

# INSTRUCTION MANUAL

**BK PRECISION®**

**MODEL 1740B**

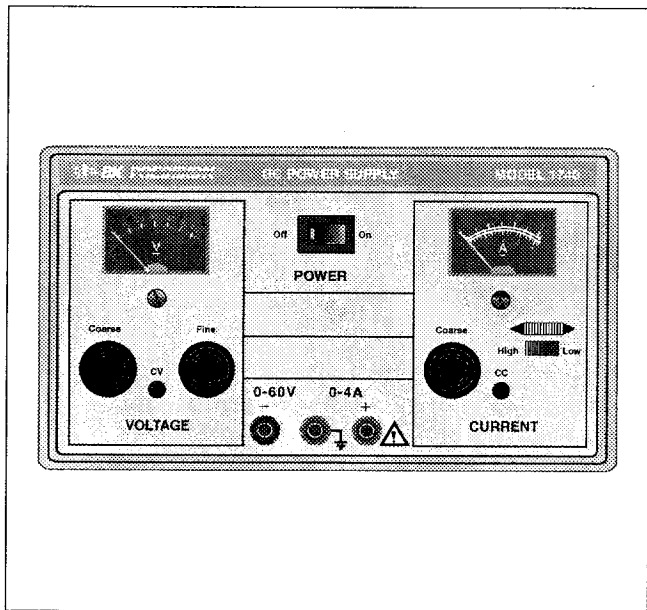

**0-60V, 0-4A  
DC POWER SUPPLY**

**T**  **USA**  
**Equipment**  
**.NET**  
An Interworld Highway, LLC Company

**BK PRECISION®**

---

## TEST INSTRUMENT SAFETY

---

### WARNING

Normal use of test equipment exposes you to a certain amount of danger from electrical shock because testing must sometimes be performed where exposed high voltage is present. An electrical shock causing 10 milliamps of current to pass through the heart will stop most human heartbeats. Voltage as low as 35 volts dc or ac rms should be considered dangerous and hazardous since it can produce a lethal current under certain conditions. Higher voltages are even more dangerous. Your normal work habits should include all accepted practices to prevent contact with exposed high voltage, and to steer current away from your heart in case of accidental contact with a high voltage. Observe the following safety precautions:



1. There is some danger of electrical shock from the power supply output, which produces a maximum of 60 volts dc. However, there may be great danger of electrical shock if the power supply output is connected to an external high voltage. There are several possible test conditions using this power supply than can create a high voltage shock hazard:
  - a. If the equipment under test is the “hot chassis” type, a serious shock hazard exists unless the equipment is unplugged (just turning off the equipment does not remove the hazard), or an isolation transformer is used.
  - b. If the equipment under test is “powered up” (and that equipment uses high voltage in any of its circuits), the power supply outputs may be floated to the potential at the point of connection. Remember that high voltage may appear at unexpected points in defective equipment. Do not float the power supply output to more than 100 volts peak with respect to chassis or earth ground.
  - c. If the equipment under test is “off” (and that equipment uses high voltage in any of its circuits under normal operation), discharge high-voltage capacitors before making connections or tests. Some circuits retain high voltage long after the equipment is turned off.
2. Use only a polarized 3-wire ac outlet. This assures that the power supply chassis, case, and ground terminal are connected to a good earth ground and reduces danger from electrical shock.
3. Don't expose high voltage needlessly. Remove housings and covers only when necessary. Turn off equipment while making test connections in high-voltage circuits. Discharge high-voltage capacitors after removing power.

(continued on inside back cover)

---

## TABLE OF CONTENTS

---

	page		page
TEST INSTRUMENT SAFETY . . . . .	inside front cover	APPLICATIONS . . . . .	19
INTRODUCTION . . . . .	3	General . . . . .	19
FEATURES . . . . .	4	Electronics Servicing . . . . .	19
SPECIFICATIONS . . . . .	5	Electronics Manufacturing . . . . .	19
CONTROLS AND INDICATORS . . . . .	7	Electronics Design Lab . . . . .	20
OPERATING INSTRUCTIONS . . . . .	9	Electronics Education . . . . .	20
Safety Precautions . . . . .	9	Battery Charging . . . . .	20
Equipment Precautions . . . . .	9	MAINTENANCE . . . . .	21
Hook-Up . . . . .	9	Fuse Replacement . . . . .	21
Typical Constant Voltage Operation . . . . .	12	Line Voltage Conversion, International Units . . . . .	21
Setting Current Limit . . . . .	13	Adjustments . . . . .	21
Typical Constant Current Operation . . . . .	14	1740 Calibration . . . . .	23
Constant Voltage/Constant Current Characteristic . . . . .	15	Instrument Repair Service . . . . .	23
Connecting Two Power Supplies in Series . . . . .	15	WARRANTY SERVICE INSTRUCTIONS . . . . .	27
Connecting Two Power Supplies in Parallel . . . . .	18	LIMITED TWO-YEAR WARRANTY . . . . .	28

---

## INTRODUCTION

---

The **B+K Precision** Model 1740 DC Power Supply is a high quality general purpose dc power source. The power supply provides 0-60 volts dc output, adjustable with both coarse and fine controls for precise settability. The current output of the Model 1740 is 0-4 amps. Two current ranges, High and Low, provide excellent current settability and meter resolution. Two large panel-mounted meters continuously monitor the output voltage and current.

The power supply exhibits excellent regulation and low ripple characteristics. The circuit design incorporates a pre-regulator, which greatly reduces internal power dissipation at low output voltages. The styling is both attractive and functional.

The instrument may be used in constant voltage or constant current applications. The crossover from constant voltage to constant current modes is smooth and automatic. LED's indicate the "CV" (constant voltage) or "CC" (constant current) mode of operation. In constant voltage applications, a current limit may be preset. When load variations cause the current to reach the preset limit, the unit then regulates output current rather than output voltage. Current limits are adjustable from 5%

to 100% of maximum. In constant current applications, the maximum voltage may be preset. When load variations cause current to drop below the regulated value, the unit reverts to regulated voltage operation at the preset value.

Reverse polarity protection prevents accidental damage to the power supply from improper connection to an external voltage, and current limiting protects the equipment being powered, as well as the power supply.

The output is isolated from chassis and earth ground, which permits full flexibility of connections. When needed, the (+) or (-) polarity may be strapped to ground, or either polarity may be floated to an external voltage. Two supplies may be connected in series as a 0-to-120 volt power source, or two supplies may be connected in parallel, with suitable balancing resistors, for up to twice the output current.

The power supply is well suited for a wide variety of electrical and electronics applications, including service shops, engineering labs, production testing, school laboratories, and home use by hobbyists.

---

## FEATURES

---

### **0-60 VOLTS**

Continuously variable over 0-to-60 volt range with coarse and fine controls.

### **0-4 AMPS**

0-to-4 amps available. Rated for continuous duty at full output current.

### **LABORATORY QUALITY**

Excellent regulation, low ripple.

### **CONSTANT VOLTAGE OR CONSTANT CURRENT**

Provides regulated dc voltage output or regulated dc current output. Crossover is smooth and automatic.

### **TWO CURRENT RANGES**

High-Low switch selects full output (0-4 A), or one quarter output (0-1 A). Low range improves current settability and meter resolution at lower current values. Switch simultaneously selects range of adjustment and corresponding meter scale.

### **BUILT-IN METERING**

Two large, easy-to-read meters continuously monitor output voltage and current.

### **LED INDICATORS**

Act as pilot light and identify mode of operation.

### **PRE-REGULATOR**

Limits internal dissipation for higher reliability.

### **ISOLATED OUTPUT**

Either polarity may be floated or grounded.

### **OVERLOAD PROTECTION**

Fully adjustable current limiting (from 5% to 100% of maximum output current) protects circuit under test and the power supply.

### **REVERSE POLARITY PROTECTION**

Prevents damage to power supply from external voltage of reverse polarity.

### **STYLING**

Modern functional styling. Logical, convenient layout of controls..

---

## SPECIFICATIONS

---

### OUTPUT VOLTAGE

0 to 60 VDC, coarse and fine adjustment

### OUTPUT CURRENT

High Range — 0 to 4 A

Low Range — 0 to 1 A

### CONSTANT VOLTAGE OPERATION

Voltage Regulation

Line (108- 132)  $\leq 0.2\% +2 \text{ mV}$

Load (no load to full load)  $\leq 0.04\% +2 \text{ mV}$

Recovery Time  $\leq 100 \mu\text{s}$  typical

Ripple Voltage

RMS 1 mV (Typical)

Temperature Coefficient

$0^\circ$  to  $+40^\circ \text{ C}$   $\leq 300 \text{ PPM}/^\circ \text{ C}$

### CONSTANT CURRENT OPERATION

Adjustable Current Limits

5% to 100%

Current Regulation

Line (108-132 V)  $\leq 0.4\% +5 \text{ mA}$

Load  $\leq 0.4\% +5 \text{ mA}$

Current Ripple  $\leq 3 \text{ mA}$  typical

### METERING

Voltmeter

Range 0 to 64 V

Accuracy  $\pm 2.5\%$

Ammeter

Hi Range 0 to 4.4 A

Lo Range 0 to 1.1 A

Accuracy  $\pm 2.5\%$

### POWER REQUIREMENTS

Domestic: 120 VAC  $\pm 10\%$ , 60 Hz

International: 120, 220, 230, 240 VAC, 50/60 Hz

### POWER CONSUMPTION

Approximately 450 Watts or less at full load

### PROTECTION

Reverse polarity protection; current limiting

### TEMPERATURE RANGE

Operation  $0^\circ$  to  $+40^\circ \text{ C}$   $\leq 75\% \text{ R.H.}$

Storage  $-15^\circ$  to  $+70^\circ \text{ C}$   $\leq 85\% \text{ R.H.}$

## **SPECIFICATIONS**

---

### **DIMENSIONS (H x W x D)**

5.7" x 10.5" x 15" (145 x 267 x 381 mm)

### **WEIGHT**

23 lb. (10.4 kg)

### **ACCESSORIES SUPPLIED**

Spare Fuse

Instruction Manual

---

## CONTROLS AND INDICATORS

---

### INDICATORS

Either the "CC" or "CV" indicator will be lighted whenever the unit is operating, thus serving as a pilot light. The unit automatically changes from CV to CC operation when the preset current limit is reached.

1. **C.C. (Constant Current) Indicator.** Red LED lights in constant current mode. Unit regulates output current at value set by CURRENT control.
2. **C.V. (Constant Voltage) Indicator.** Green LED lights in constant voltage mode. Unit regulates output voltage at value set by VOLTAGE controls.

### VOLTAGE CONTROLS

3. **Coarse Control.** Coarse adjustment of output voltage. Read value on  $\underline{V}$  meter.
4. **Fine Control.** Fine adjustment of output voltage. Read value on  $\underline{V}$  meter.

### CURRENT CONTROLS

5. **CURRENT Control.** Adjusts current limit in constant voltage mode. Adjusts constant current mode. Range of adjustment is determined by High-Low switch.
6. **High-Low Switch.** High position selects high current range; value is

read on top meter scale of A meter. Low position selects low current range; value is read on bottom meter scale of  $\underline{A}$  meter.

High	0 to 4A
Low	0 to 1A

### POWER CONTROLS

7. **ON-OFF Switch**

### OUTPUT TERMINALS

8. **“+” Terminal (Red).** Positive polarity output terminal.
9.  **$\perp$  Terminal (Green).** Earth and chassis ground.
10. **“-” Terminal (Black).** Negative polarity output terminal.

### METERS

11.  **$\underline{A}$  Meter.** Reads output current in amperes. Use top scale when High-Low switch is set to High, bottom scale when switch is set to Low.
12.  **$\underline{V}$  Meter.** Reads output voltage on 0 to 64 V scale.

### REAR PANEL CONTROLS

13. **Fuse**
14. **Power Cord**
15. **110/220 Line Voltage Conversion Switch**
16. **Switch Cover**



## CONTROLS AND INDICATORS

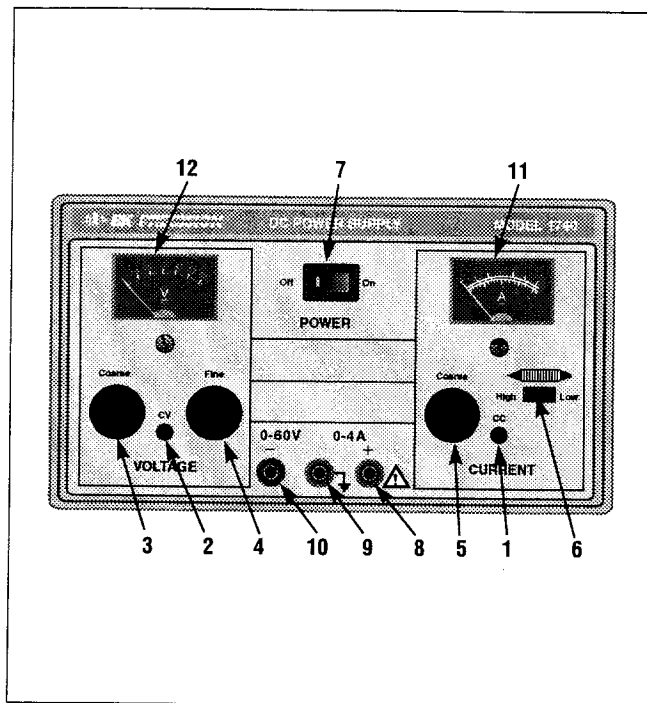

Figure 1. Front Panel Controls and Indicators.

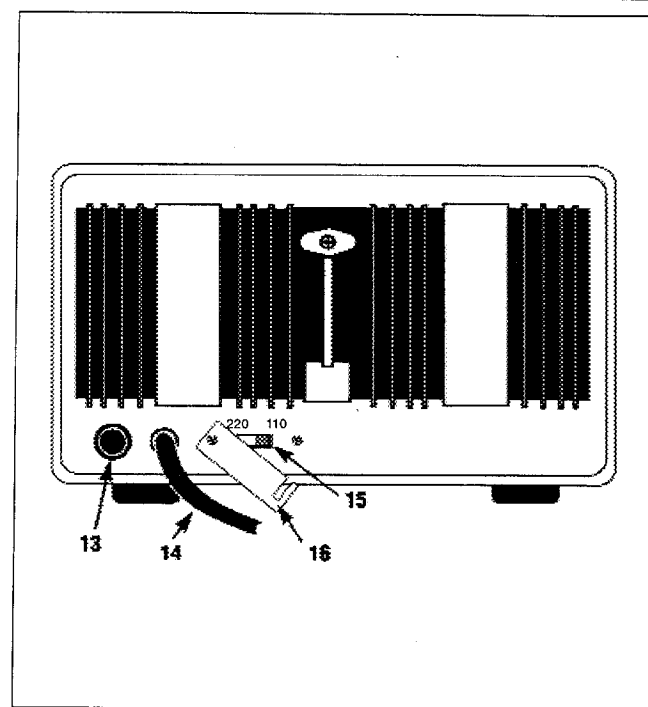

Figure 2. Rear Panel

---

# OPERATING INSTRUCTIONS

---

## SAFETY PRECAUTIONS

Use only a polarized 3-wire ac outlet. This assures that the power supply chassis, case, and ground terminal are connected to a good earth ground and reduces danger from electrical shock.



There is some danger of electrical shock from the power supply output, which produces a maximum of 60 volts dc. **However, there may be great danger of electrical shock if the power supply output is connected to an external high voltage.** Some equipment being powered may contain high voltage and present a serious hazard. Observe caution. If the power supply output is floated (referenced to a voltage rather than earth ground) turn off the power supply **and the equipment under test** when making connections. Never float the power supply to a potential greater than 100 volts peak with respect to earth ground.

## EQUIPMENT PRECAUTIONS

Avoid using the power supply in ambient temperatures above +40° C. Always allow sufficient air space around the heat sink at the rear of the power supply for effective radiation to prevent internal heat build-up.

Although the power supply is protected against reverse polarity damage, the circuit being powered may not include such protection. Always carefully observe polarity; incorrect polarity may damage the equipment under test.

Do not exceed the voltage rating of the circuit being powered. Most transistors and integrated circuits will not withstand a voltage of 60 volts.

There is no need to worry about voltage spikes or overshoot damaging the equipment under test. The voltage between the output terminals of the power supply never exceeds the preset value as the POWER switch is turned on or off.

## HOOK-UP

1. Turn off the power supply and the equipment to be powered during hook-up.
2. Connect the positive polarity of the device being powered to the red (+) terminal of the power supply.
3. Connect the negative polarity of the device being powered to the black (-) terminal of the power supply.
4. Fig. 3 illustrates the grounding possibilities.
  - a. If the negative polarity of the equipment or circuit being powered is also the chassis or common, it may be grounded to earth by strapping the black (-) terminal to the green ( $\frac{\perp}{\text{E}}$ ) terminal as shown in Fig. 3A.
  - b. Similarly, the positive polarity can be grounded by strapping the red (+) terminal to the green ( $\frac{\perp}{\text{E}}$ ) terminal as shown in Fig. 3B.
  - c. If an earth ground reference is not required, the configuration of Fig. 3C may be used. The scheme in Fig. 3C should also be used where it is not known whether the chassis is common with either the positive or negative polarity.

# OPERATING INSTRUCTIONS

## 1740 POWER SUPPLY

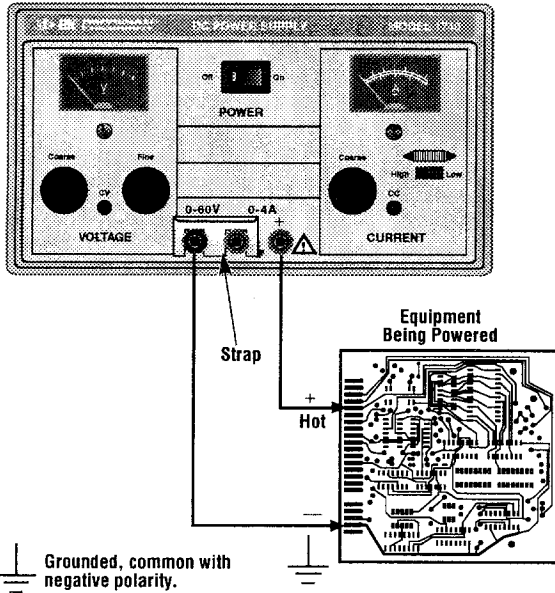

## 1740 POWER SUPPLY

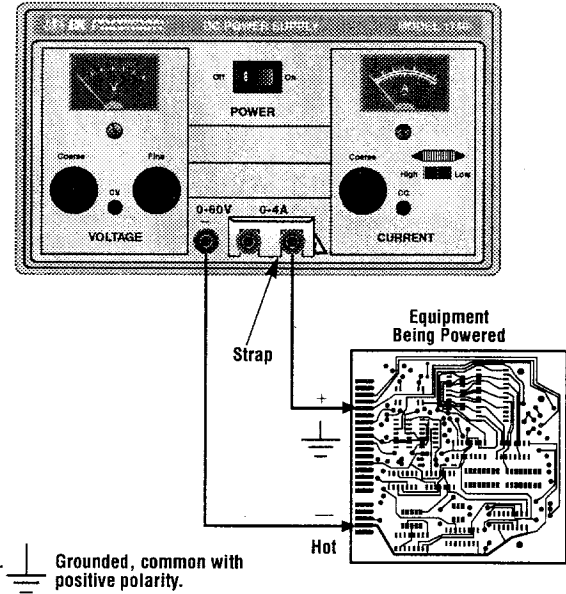

Figure 3 (A and B). Grounding Possibilities.

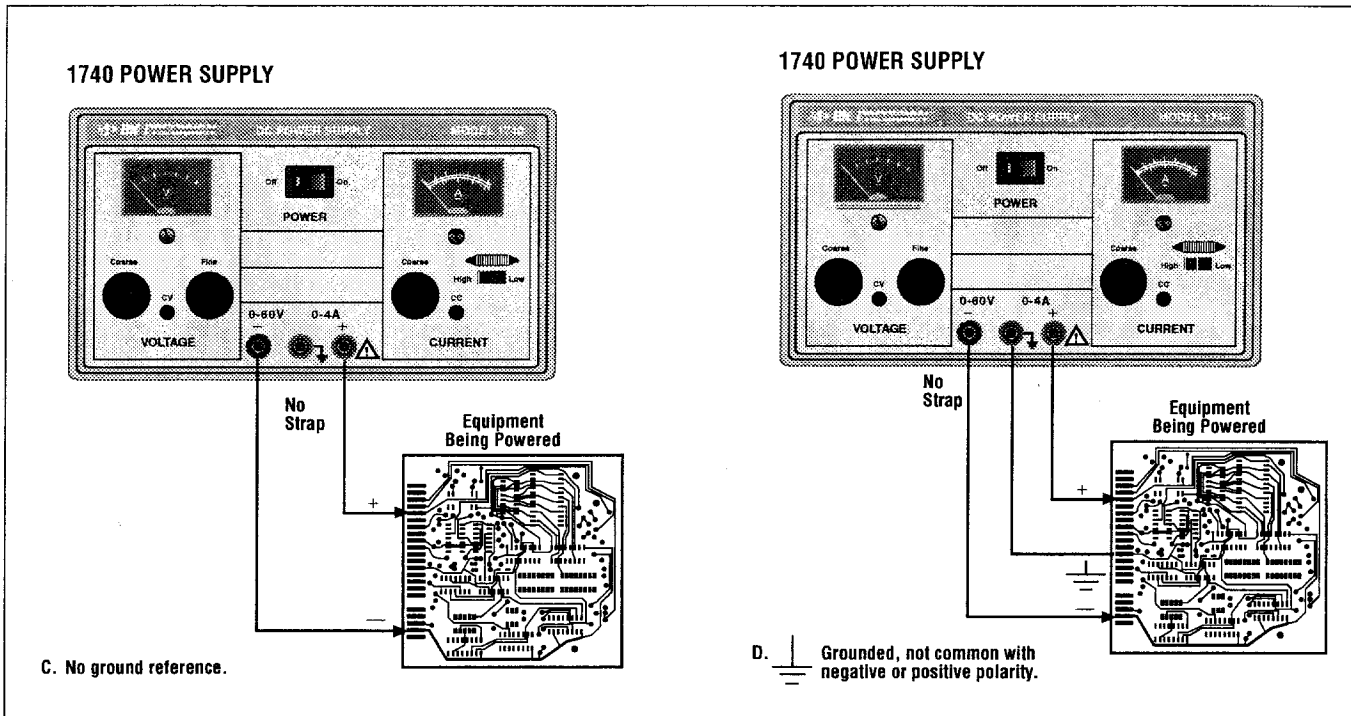

Figure 3 (C and D). Grounding Possibilities.

## OPERATING INSTRUCTIONS

- d. If the chassis or common of the equipment being powered is separate from both the positive and negative polarity power inputs, use the connection shown in Fig. 3D.
5. Observe proper polarity. If the circuit being powered is not equipped with reverse polarity protection, damage to the circuit can result from reverse polarity. Use color coded hook-up leads, for convenience in identifying polarity, red for (+) and black for (-).
6. Make sure that the hook-up leads offer sufficient current capability and low resistance between the power supply and the circuits being powered.

### TYPICAL CONSTANT VOLTAGE OPERATION

1. Before connecting the device to be powered to the power supply, determine the maximum safe load current for the device to be powered and set the current limit value (see "Setting Current Limit" procedure in this section).
2. Set Fine VOLTAGE control to center and Coarse VOLTAGE control to minimum (fully counterclockwise).
3. Turn off power supply and connect it to the device to be powered (see "Hook-Up" procedure in this section).
4. Turn on POWER switch. The CV indicator should light.
5. Increase the VOLTAGE setting until the  $\underline{V}$  meter reads the desired value. The Fine control permits easier setting to a specific value.
6. Note the load current on the  $\Delta$  meter.

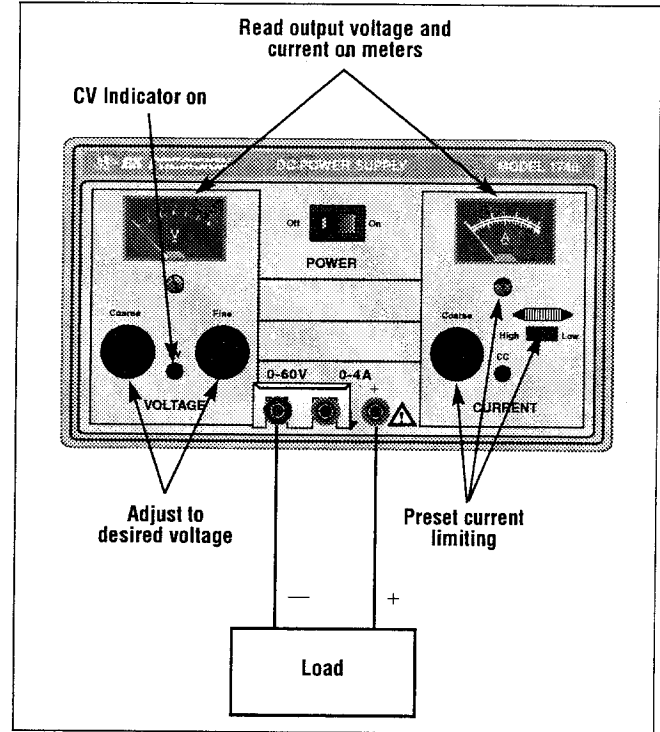

Figure 4. Typical Constant Voltage Operation.

- If the load current exceeds the preset current limit, the CV indicator will go off and the CC indicator will light. In this case, the power supply automatically switches to the constant current mode, and further rotation of the VOLTAGE control will not increase the output voltage as read on the  $\nabla$  meter.

### SETTING CURRENT LIMIT

- Determine the maximum safe current value for the device to be powered. If the value is greater than 1 A then set the High-Low switch to High. If the value is less than 1 A then set the High-Low switch to Low.
- Temporarily short the (+) and (-) terminals of the power supply together with a test lead.
- Rotate the Coarse VOLTAGE control away from zero sufficiently for the CC indicator to light.
- Adjust the Coarse CURRENT control for the desired current limit. Read the current value on the  $\Delta$  meter.
- The current limit (overload protection) has now been preset. Do not change the Coarse CURRENT control setting after this step.
- Remove the short between the (+) and (-) terminals and hook up for constant voltage operation.

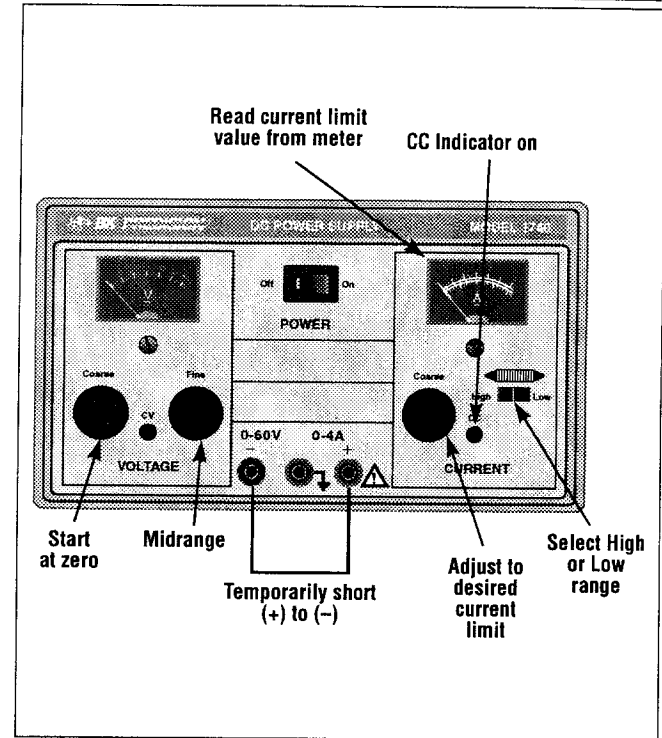

Figure 5. Setting Current Limit.

## OPERATING INSTRUCTIONS

### TYPICAL CONSTANT CURRENT OPERATION

1. Before connecting the device to be powered to the power supply, determine the maximum safe voltage to be applied and set the **VOLTAGE** controls to obtain that voltage reading on the **V** meter.
2. Determine the desired constant current value. If the value is greater than 1 A, set the High-Low switch to High. If the value is less than 1 A, set the High-Low switch to Low.
3. Set the **CURRENT** control to minimum (fully counterclockwise).
4. Turn off the power supply and connect it to the device to be powered.
5. Turn on the power supply. The **CC** indicator should light.
6. Increase the **CURRENT** control setting until the desired constant current value is read on the **A** meter, or set the current limit in advance (before connecting the load) as prescribed in the earlier "Setting Current Limit" procedure.
7. If the load current drops below the constant current value, the **CC** indicator will go off and the **CV** indicator will light. In this case, the power supply automatically switches to the constant voltage mode, and further rotation of the **CURRENT** control will not increase the output current as read on the **A** meter.

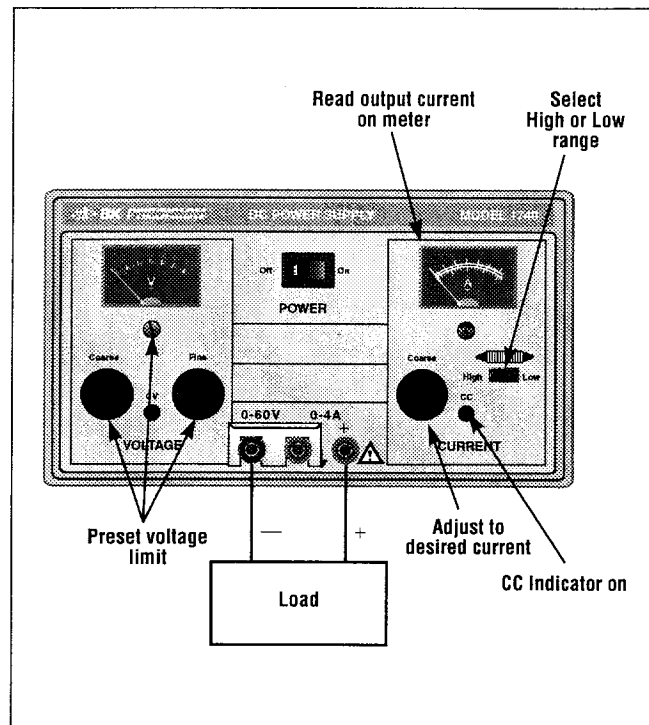

Figure 6. Typical Constant Current Operation.

### CONSTANT VOLTAGE/CONSTANT CURRENT CHARACTERISTIC

The working characteristic of the Model 1740 Power Supply is called a constant voltage/constant current automatic crossover type. This permits continuous transition from constant current to constant voltage modes in response to the load change. The intersection of constant voltage and constant current modes is called the crossover point. Fig. 7 shows the relationship between this crossover point and the load.

For example, if the load is such that the power supply is operating in the constant voltage mode, a regulated output voltage is provided. The output voltage remains constant as the load increases, up until the point where the preset current limit is reached. At that point, the output current becomes constant and the output voltage drops in proportion to further increases in load. The crossover point is indicated by the front panel LED indicators. The crossover point is reached when the CV indicator goes off and the CC indicator comes on.

Similarly, crossover from the constant current to the constant voltage mode automatically occurs from a decrease in load. A good example of this would be seen when charging a 12-volt battery. Initially, the open circuit voltage of the power supply may be preset for 13.8 volts. A low battery will place a heavy load on the supply and it will operate in the constant current mode, which may be adjusted for a 1 amp charging rate. As the battery becomes charged, and its voltage approaches 13.8 volts, its load decreases to the point where it no longer demands the full 1 amp charging rate. This is the crossover point where the power supply goes into the constant voltage mode.

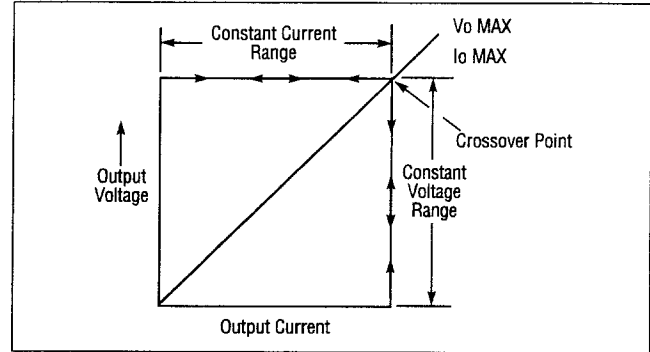

Figure 7. Constant Voltage/Constant Current Characteristics

### CONNECTING TWO POWER SUPPLIES IN SERIES

Two Model 1740 power supplies may be connected in series to provide a variable 0-120 volt output. In this configuration, two 1740's provide up to 4 amps. See Fig. 8 for the connection scheme.

When connected in series, the VOLTAGE controls of each power supply exercise control over a 0-60 volt range. Add the two V meter readings together to determine the total output voltage, or connect an external voltmeter across the load.

Load current may be monitored from either supply; the readings will be identical since they are connected in series. Also, since the supplies are connected in series, it is only necessary to set the current limit on one of the supplies; the other may be set for maximum.



# OPERATING INSTRUCTIONS

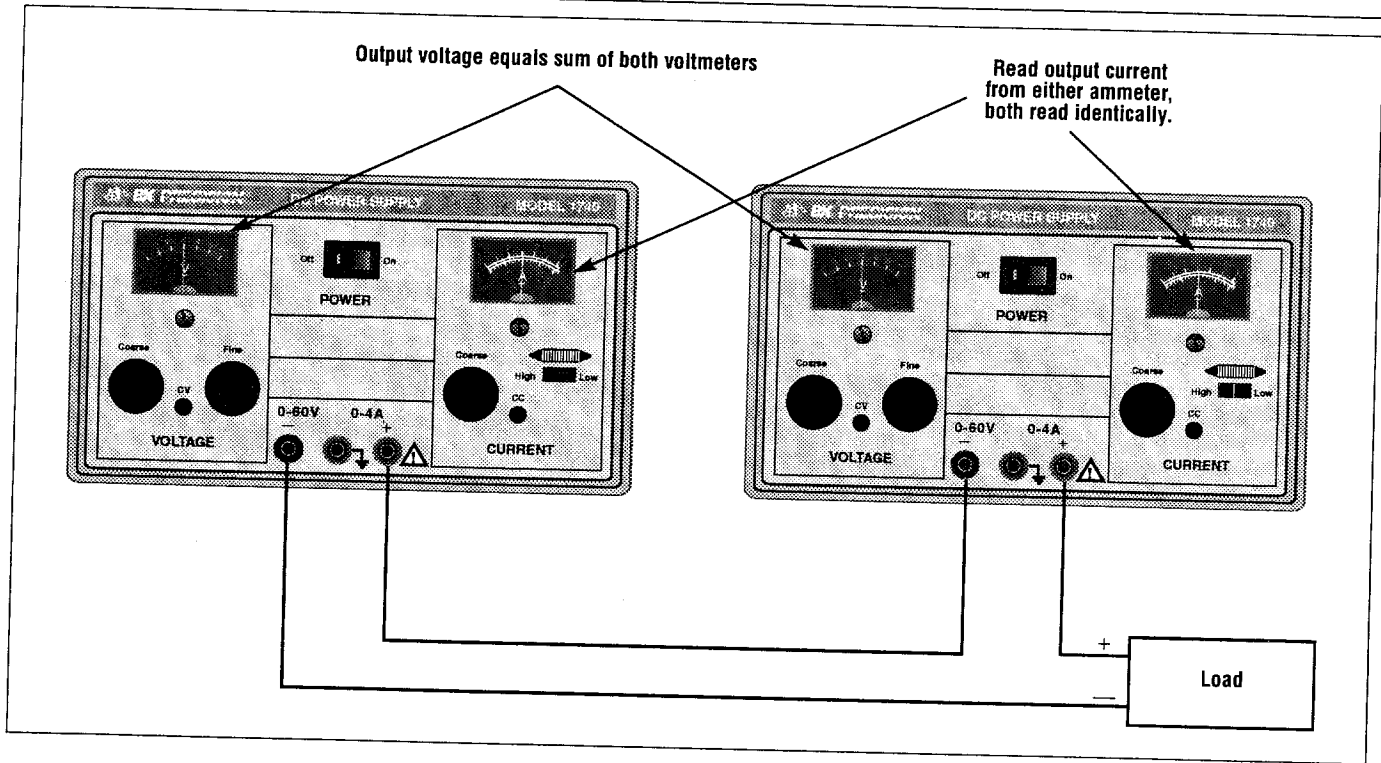

Figure 8. Connecting Two Power Supplies in Series.

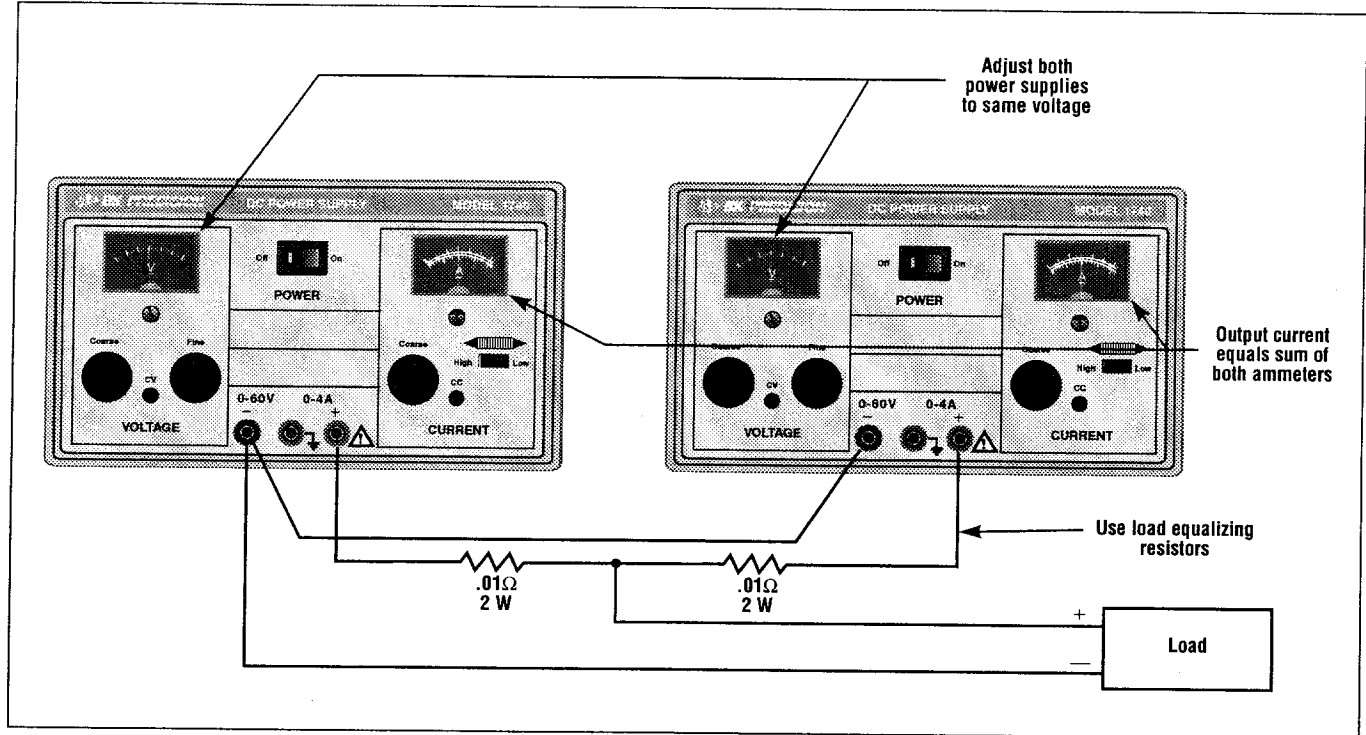

Figure 9. Connecting Two Power Supplies in Parallel.

## OPERATING INSTRUCTIONS

---

### CONNECTING TWO POWER SUPPLIES IN PARALLEL

Two power supplies may be connected in parallel to double the maximum load current. In this configuration, two 1740's will provide a variable 0-60 volt output at up to 8 amps (heavier gauge hook-up leads are advisable). Current equalizing resistors must be used as shown in Fig. 9. However, the protective current limiting feature will prevent damage if the current is temporarily unbalanced during set-up.

When connected in parallel and operating in the constant voltage mode, determine the total load current limit and preset the current limiting for each power supply to half the total load current value. Then when the load is connected, set the VOLTAGE controls on the two power supplies for equal voltage readings on the V meters. This should also provide approximately equal current from each supply, as read on the A

meters. Add the two A meter readings together for total load current, or connect an external ammeter in series with the load.

If the current equalizing resistors are not well matched, it is preferable that the voltages be slightly unbalanced to achieve current balance. Be sure that the supplies are adequately balanced so that both remain in the CV mode.

When connected in parallel and operating in the constant current mode, the VOLTAGE controls of both supplies should be preset to the same value. Then when the load is connected, the CURRENT controls of the two supplies should be adjusted for approximately equal current from each unit. Be sure that both supplies remain in the CC mode.

---

## APPLICATIONS

---

### GENERAL

The Model 1740 power supply performs a very wide variety of applications in electrical and electronics servicing, engineering laboratories, manufacturing and testing facilities, schools, and home hobbies. The power supply output is fully adjustable from 0 to 60 volts, and 0 to 4 amps. This supply is suitable for most applications requiring a dc power source.

### ELECTRONICS SERVICING

Most electronics troubleshooting and repair is performed on a test bench. This power supply can provide the dc power source to operate a module or circuit board on the test bench when it is removed from its parent equipment. It can be used to power portable, battery-operated equipment and check the effect of low battery voltage. It can power vehicular equipment such as tape players, auto sound systems, CB radios, etc. on the test bench.

Most automobiles and other vehicles use 12-volt electrical systems. Although the electrical system is normally referred to as a 12-volt system, actual battery voltage when fully charged is approximately 14 volts. The power supply may be set to 14 volts for servicing equipment from vehicles with 12-volt electrical systems. Some trucks use a 24-volt electrical system; bench testing of equipment from these systems should be performed at 28 volts.

Some servicing applications require the injection of a variable dc voltage for certain tests, such as checking the effect of AGC bias in a

television receiver. This requires an isolated dc power supply, such as the Model 1740. The equipment being tested may contain its own power supply and operate from ac power. A dc voltage may already be present in the circuit. One polarity of the power supply output is floated to an appropriate point in the circuit, such as the emitter of a transistor. The other polarity of the power supply output is then applied to another point in the circuit, such as the base of that transistor. Varying the power supply voltage then varies the dc bias on the stage, and the effects may be noted. A series limiting resistor is often used to protect the circuits from overdissipation.

### ELECTRONICS MANUFACTURING

In electronics manufacturing facilities, the power supply is often used as a dc power source while testing and adjusting modules, subassemblies, and complete units in the production and assembly area or in the quality control area. The instrument could be used in incoming inspection as a dc power source for testing purchased components and subassemblies.

This power supply is particularly well suited for manufacturing applications because of its ease of operation and its continuous duty rating. When load current or total power dissipation are among the main characteristics to be measured, the total load current and voltage are instantly displayed on the two meters. The current limit can be set so that all units which do not meet the load current specification will cause the CC indicator to light, and the unit can be rejected.

## APPLICATIONS

---

### ELECTRONICS DESIGN LAB

The technician or engineer working in an engineering laboratory requires a dc power supply to power breadboard and prototype circuits. This power supply is ideal because it monitors both current and voltage simultaneously, limits current to protect the circuit, is adjustable over a wide range, and has excellent regulation and very low ripple.

Use of the instrument in an engineering laboratory is very similar to that described for servicing electronics equipment and modules, except that lower currents may be prevalent when powering individual circuits. The current limiting feature is very valuable in this application because it can protect unproven circuits from damage.

### ELECTRONICS EDUCATION

The student in an electronics curriculum may use the power supply for powering equipment and circuits as previously described for all other applications. In addition, the power supply can be used in the classroom laboratory to conduct experiments in fundamental electronics. In learning Ohm's law, for example, the relationships of resistance, current, and voltage are vividly demonstrated by the use of a power supply. Being able to observe both the current and voltage meter simultaneously is a great aid in such experiments.

### BATTERY CHARGING

The power supply can be used as a battery charger to restore the charge in rechargeable batteries such as lead-acid, nickel-cadmium, and some alkaline types. Refer to the battery manufacturer's charging specifications for proper voltage and current settings. Charging information is sometimes printed on the batteries. Battery charging, at least initially, requires the constant current mode of operation. Before connecting the power supply to the battery, preset the VOLTAGE controls to the fully charged terminal voltage specified by the battery manufacturer. Turn off the power supply while connecting the battery. Observe proper polarity and connect as for constant current operation. Adjust the CURRENT control for the maximum charging current specified by the battery manufacturer (If the maximum charging current is greater than the power supply's maximum load current, set the CURRENT control to maximum). The CC indicator will light and the battery will charge at the preset current limit, which can be read on the A meter. As the battery approaches full charge, its terminal voltage will approach that of the power supply output and the charging current will taper off. The power supply may automatically switch to CV (constant voltage) operation. When this occurs, the power supply will continue to provide a trickle charge.

---

## MAINTENANCE

---

### WARNING

*The following instructions are for use by qualified personnel only. To avoid electrical shock, do not perform any servicing other than contained in the operating instructions unless you are qualified to do so.*

### FUSE REPLACEMENT

If the fuse blows, the CV or CC indicators will not light and the power supply will not operate. The fuse should not normally open unless a problem has developed in the unit. Try to determine and correct the cause of the blown fuse, then replace only with a fuse of the correct rating as listed below. The fuse is located on the rear panel (see Fig. 2).

OPERATION	FUSE VALUE	TYPE
120 V	3.5 A	SLOW BLOW
220/230/240 V	1.6 A	SLOW BLOW

**Table 1. Fuse Values.**

### LINE VOLTAGE CONVERSION, INTERNATIONAL UNITS

The 1740 power supply can be switched from 110 VAC to 220/230/240 VAC by a switch located on the rear panel. To convert to a different line voltage, perform the following procedure.

1. Make sure the power cord is unplugged.
2. Determine the desired voltage setting and switch the slide switch to the proper voltage. (pg. 8, Item 15)
3. To change the AC plug for a specific country, use the following wiring diagram for proper hook-up.

Green	=	Ground
White	=	220 VAC (neutral)
Black	=	220/230/240 VAC (hot)

4. Ensure plug is wired correctly before using power supply.
5. Contact factory if uncertain about wiring method.

### ADJUSTMENTS

This unit was accurately adjusted at the factory before shipment. Readjustment is recommended only if repairs have been made in a circuit affecting adjustment accuracy, or if you have a reason to believe the unit is out of adjustment. However, adjustments should be attempted only if a multimeter with an accuracy of  $\pm 0.5\%$  DCV or better is available (**B+K Precision Model 2703A** or equivalent).

**1740 CALIBRATION**

If readjustment is required, use the following procedure. Locations of the adjustments are shown in Fig. 11. The meters may be mechanically zeroed thru their front panel access holes prior to any calibration.

1. Set the front panel controls of the Model 1740 as follows:  
Coarse and Fine **VOLTAGE** controls fully clockwise.  
Coarse **CURRENT** control fully clockwise.  
High-Low switch to **Low**.  
Power switch to **On**.
2. Connect the multimeter to measure the voltage at pin 14 of IC2 with respect to the front panel red (+) output jack. **Adjust R21** for -5.00 volts on the multimeter.
3. Connect the multimeter to measure the voltage at pin 8 of IC2 with respect to the front panel red (+) output jack. **Adjust R64** for  $0 \pm 10\text{mV}$  on the multimeter.
4. Connect the multimeter to measure the DC voltage between the black (-) and red (+) output jacks. The voltage should be 60 to 63 volts, the green **CV** indicator should be lit, and the red **CC** indicator should be off.
5. Set the front panel Fine **VOLTAGE** control for a reading of 60.0 volts on the multimeter. **Adjust R54** for a front panel meter reading of 60 volts on the **VOLTAGE** meter.

6. Set the front panel Coarse **VOLTAGE** control for a reading of 10 volts on the **VOLTAGE** meter.
7. Set the High-Low switch to **High**.
8. Connect the multimeter to read the DC current between the black (-) and red (+) output jacks, using the 10 amp range. The red **CC** indicator should light and the green **CV** indicator should go off.
9. Set the front panel Coarse **CURRENT** control for a reading of 4.00 amps on the multimeter. **Adjust R56** for a front panel meter reading of 4.0 amps on the **CURRENT** meter.
10. Set the High-Low switch to **Low**, the multimeter should read  $1.00 \pm 2$  counts.

**INSTRUMENT REPAIR SERVICE**

Because of the specialized skills and test equipment required for instrument repair and calibration, many customers prefer to rely upon **B+K Precision** for this service. We maintain a network of **B+K Precision** authorized service agencies for this purpose. To use this service, even if the instrument is no longer under warranty, follow the instructions given in the **WARRANTY SERVICE INSTRUCTIONS** section of this manual. There is a nominal charge for instruments out of warranty.

**MAINTENANCE**

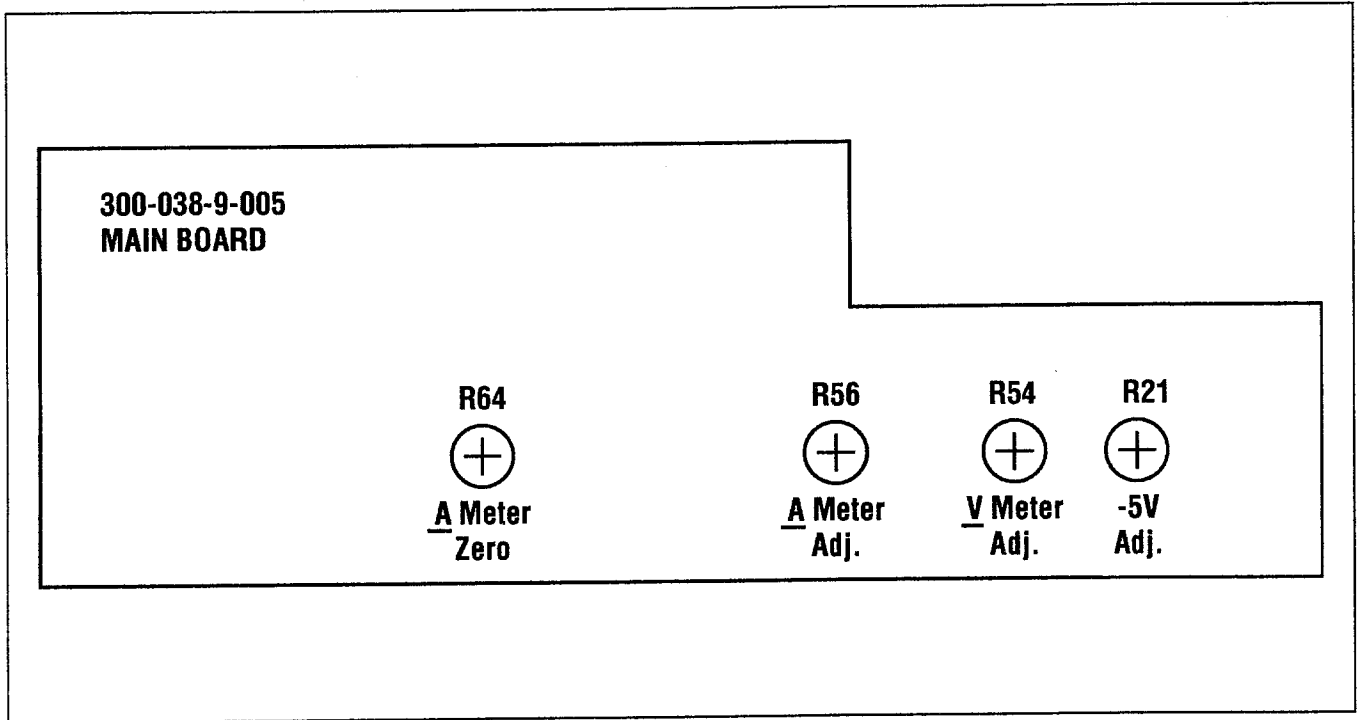

**Figure 11. Location of Adjustments.**



---

## SERVICE INFORMATION

---

**Warranty Service:** Please return the product in the original packaging with proof of purchase to the below address. Clearly state in writing the performance problem and return any leads, connectors and accessories that you are using with the device.

**Non-Warranty Service:** Please return the product in the original packaging to the below address. Clearly state in writing the performance problem and return any leads, connectors and accessories that you are using with the device. Customers not on open account must include payment in the form of a money order or credit card. For the most current repair charges contact the factory before shipping the product.

Return all merchandise to B&K Precision Corp. with pre-paid shipping. The flat-rate repair charge includes return shipping to locations in North America. For overnight shipments and non-North America shipping fees contact B+K Precision Corp.

B&K Precision  
22820 Savi Ranch Parkway  
Yorba Linda, CA 92887

Phone: 714-921-9095  
Facsimile: 714-921-6422  
e-mail: [service@bkprecision.com](mailto:service@bkprecision.com)

**Include with the instrument your complete return shipping address, contact name, phone number and description of problem.**

---

## LIMITED TWO YEAR WARRANTY

---

B&K Precision Corp. warrants to the original purchaser that its product and the component parts thereof, will be free from defects in workmanship and materials for a period of two years from the date of purchase.

B&K Precision Corp. will, without charge, repair or replace, at its option, defective product or component parts. Returned product must be accompanied by proof of the purchase date in the form a sales receipt.

To obtain warranty coverage in the U.S.A., this product must be registered by completing and mailing the enclosed warranty card to B&K Precision Corp., 22820 Savi Ranch Parkway, Yorba Linda, CA 92887 within (15) days from proof of purchase.

**Exclusions: This warranty does not apply in the event of misuse or abuse of the product or as a result of unauthorized alterations or repairs. It is void if the serial number is alternated, defaced or removed.**

B&K Precision Corp. shall not be liable for any consequential damages, including without limitation damages resulting from loss of use. Some states do not allow limitation of incidental or consequential damages, so the above limitation or exclusion may not apply to you.

This warranty gives you specific rights and you may have other rights, which vary from state-to-state.

Model Number: \_\_\_\_\_ Date Purchased: \_\_\_\_\_

(continued from inside front cover)

- 4.If possible, familiarize yourself with the equipment being tested and the location of its high voltage points. However, remember that high voltage may appear at unexpected points in defective equipment.
- 5.Use an insulated floor material or a large, insulated floor mat to stand on, and an insulated work surface on which to place equipment; and make certain such surfaces are not damp or wet.
- 6.When testing ac powered equipment, the ac line voltage is usually present on some power input circuits such as the on-off switch, fuses, power transformer, etc. “any time” the equipment is connected to an ac outlet.
- 7.**B+K Precision** products are not authorized for use in any application involving direct contact between our product and the human body, or for use as a critical component in a life support device or system. Here, “direct contact” refers to any connection from or to our equipment via any cabling or switching means. A “critical component” is any component of a life support device or system whose failure to perform can be reasonably expected to cause failure of that device or system, or to affect its safety or effectiveness.
- 8.Never work alone. Someone should be nearby to render aid if necessary. Training in CPR (cardio-pulmonary resuscitation) first aid is highly recommended.

