



Fyrite® Tech

Model 50 & 60

Combustion Gas Analyzer

Instruction 24-9428
Operation & Maintenance
Rev. 4 – August 2005

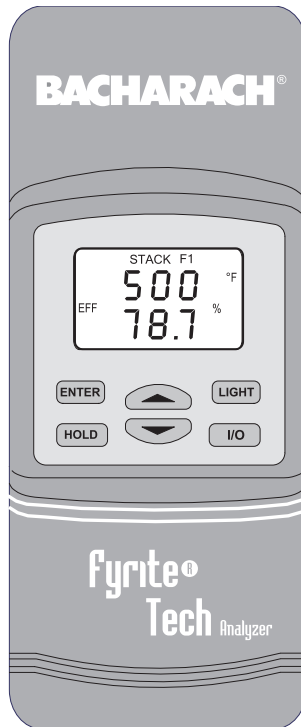

WARRANTY

Bacharach, Inc. warrants to Buyer that at the time of delivery this Product will be free from defects in material and manufacture and will conform substantially to Bacharach Inc.'s applicable specifications. Bacharach's liability and Buyer's remedy under this warranty are limited to the repair or replacement, at Bacharach's option, of this Product or parts thereof returned to Seller at the factory of manufacture and shown to Bacharach Inc.'s reasonable satisfaction to have been defective; provided that written notice of the defect shall have been given by Buyer to Bacharach Inc. within two (2) years after the date of delivery of this Product by Bacharach, Inc.

Bacharach, Inc. warrants to Buyer that it will convey good title to this Product. Bacharach's liability and Buyer's remedy under this warranty of title are limited to the removal of any title defects or, at the election of Bacharach, to the replacement of this Product or parts thereof that are defective in title.

THE FOREGOING WARRANTIES ARE EXCLUSIVE AND ARE GIVEN AND ACCEPTED IN LIEU OF (I) ANY AND ALL OTHER WARRANTIES, EXPRESS OR IMPLIED, INCLUDING WITHOUT LIMITATION THE IMPLIED WARRANTIES OF MERCHANTABILITY AND FITNESS FOR A PARTICULAR PURPOSE; AND (II) ANY OBLIGATION, LIABILITY, RIGHT, CLAIM OR REMEDY IN CONTRACT OR TORT, WHETHER OR NOT ARISING FROM BACHARACH'S NEGLIGENCE, ACTUAL OR IMPLIED. The remedies of the Buyer shall be limited to those provided herein to the exclusion of any and all other remedies including, without limitation incidental or consequential damages. No agreement varying or extending the foregoing warranties, remedies or this limitation will be binding upon Bacharach, Inc. unless in writing, signed by a duly authorized officer of Bacharach.

Register Your Warranty by Visiting www.bacharach-inc.com

Declaration of Conformity

| | |
|------------------------|---|
| Manufacturer's name: | Bacharach, Inc. |
| Manufacturer' address: | 621 Hunt Valley Circle New Kensington, PA 15068 |
| European Operations: | Bacharach Europe Sovereign House, Queensway Leamington Spa Warwickshire CV31 3JR United Kingdom |
| Product name: | Fyrite Tech conforms to the following specifications: European Directive 89/336/EEC EN50082-1: 1997 (Electrostatic Discharge) EN50082-1: 1997 (Immunity) EN55022; Group 1, Class B (Emmission) |

Notice:

Product improvements and enhancements are continuous, therefore the specifications and information contained in this document may change without notice.

Bacharach, Inc. shall not be liable for errors contained herein or for incidental or consequential damages in connection with the furnishing, performance, or use of this material.

No part of this document may be photocopied, reproduced, or translated to another language without the prior written consent of Bacharach, Inc.

Copyright © 2002–2005, Bacharach, Inc., all rights reserved.
BACHARACH and Fyrite are registered trademarks of Bacharach, Inc. All other trademarks, trade names, service marks and logos referenced herein belong to their respective companies.

Contents

| | |
|--|------------|
| Ordering Information..... | iii |
| 1.0 INTRODUCTION..... | 1 |
| 1.1 The Fyrite Tech..... | 1 |
| 1.2 Operational Overview..... | 2 |
| 2.0 TECHNICAL CHARACTERISTICS..... | 3 |
| 3.0 SETTING UP THE ANALYZER..... | 5 |
| 3.1 Scope..... | 5 |
| 3.2 Checking & Replacing the Batteries..... | 5 |
| 3.3 Connecting the Probe..... | 6 |
| 3.4 Front Panel Pushbuttons..... | 8 |
| 3.5 Setup Mode..... | 9 |
| 3.5.1 Entering Setup..... | 9 |
| 3.5.2 Selecting Temperature Units..... | 9 |
| 3.5.3 CO Channel Setup (Model 60 only)..... | 10 |
| 3.5.4 Time Setup (Model 60 only)..... | 10 |
| 3.5.5 Date Setup (Model 60 only)..... | 11 |
| 3.5.6 Year Setup (Model 60 only)..... | 11 |
| 3.5.7 Selecting Printer Protocol (Model 60 only)..... | 12 |
| 3.5.8 Exiting Setup..... | 12 |
| 4.0 OPERATION..... | 13 |
| 4.1 Performing a Test..... | 13 |
| 4.1.1 Analyzer Turn On and Warm Up..... | 13 |
| 4.1.2 Selecting a Fuel..... | 13 |
| 4.1.3 Manual Zero of the CO Channel (Model 60 only)..... | 13 |
| 4.1.4 Sampling Point..... | 14 |
| 4.1.5 Performing a Combustion Efficiency Test..... | 16 |
| 4.1.6 Printing Test Results (Model 60 only)..... | 16 |
| 4.1.7 Ending a Combustion Test..... | 18 |
| 4.1.8 Turning OFF the Analyzer..... | 18 |
| 4.2 CO Purge During Turn OFF (Model 60 only)..... | 18 |
| 4.3 Operating Tips..... | 19 |
| 4.4 Using the Backlight..... | 20 |
| 4.5 Using the Probe..... | 20 |
| 4.6 Resetting the Microprocessor..... | 20 |
| 4.7 Run Mode Screens..... | 21 |

| | | |
|------------|--|-----------|
| 4.8 | Screen Descriptions..... | 22 |
| 4.8.1 | Warm-Up Screens..... | 22 |
| 4.8.2 | Fuel Screen | 22 |
| 4.8.3 | O ₂ Screen (Model 50 only)..... | 23 |
| 4.8.4 | CO & O ₂ Screen (Model 60 only)..... | 23 |
| 4.8.5 | CO Air Free Screen (Model 60 only)..... | 24 |
| 4.8.6 | Ambient Air Temperature Screen | 24 |
| 4.8.7 | Stack Temperature & Efficiency Screen | 25 |
| 4.8.8 | CO ₂ & Excess Air Screen | 25 |
| 5.0 | CALIBRATION & MAINTENANCE | 27 |
| 5.1 | Entering the Calibration Mode and Testing the Display Segments ... | 27 |
| 5.2 | Ambient Temperature Calibration..... | 28 |
| 5.3 | Stack Thermocouple Channel Calibration..... | 28 |
| 5.4 | O ₂ Sensor Zero | 29 |
| 5.5 | CO Sensor Zero & Calibration (Model 60 only) | 30 |
| 5.6 | Water Trap / Filter Maintenance | 32 |
| 5.7 | O ₂ Sensor Replacement..... | 33 |
| 5.8 | CO Sensor Replacement (Model 60 Only)..... | 34 |
| 5.9 | Pump Assembly Replacement | 35 |
| 6.0 | PARTS & SERVICE..... | 38 |
| 6.1 | Replacement Parts | 38 |
| 6.2 | Accessories..... | 38 |
| 6.3 | Service Centers..... | 39 |

Ordering Information

| Model No. Part No. | Fyrite Tech 50 24-8216 | Fyrite Tech 60 24-8217 |
|-------------------------------|-----------------------------------|-----------------------------------|
| Measurements: | | |
| Oxygen | X | X |
| Stack Temperature | X | X |
| Ambient Temperature | X | X |
| Carbon Monoxide | | X |
| Calculations: | | |
| Combustion Efficiency | X | X |
| Excess Air | X | X |
| Carbon Dioxide | X | X |
| CO air free | | X |
| Print Capability* | | X |

* The printer used with a Fyrite Tech 60 is an optional accessory item that must be ordered separately. Refer to Section 6.2 Accessories.

Notes:

1.0 INTRODUCTION

1.1 The Fyrite Tech

Available in two models, the Fyrite Tech 50 and 60 are hand-held analyzers that are designed to calculate the efficiency of residential furnaces and combustion appliances by measuring the stack temperature and the percent oxygen level in the flue-gas stream.

While both analyzers are capable of combustion testing, the Fyrite Tech 60 has the added capability of measuring carbon monoxide and calculating CO air-free, and also has the capability of sending combustion test data to an optional printer via an infrared port using either HP or IrDA protocol.

Fyrite Tech 50

Measures:

- Oxygen (O₂)
- Stack temperature
- Ambient temperature

Calculates:

- Combustion Efficiency
- Carbon Dioxide (CO₂)
- Excess Air

Fyrite Tech 60

Measures:

- Oxygen (O₂)
- Stack temperature
- Ambient temperature
- Carbon Monoxide (CO)

Calculates:

- Combustion Efficiency
- Carbon Dioxide (CO₂)
- Excess Air
- CO air-free



WARNINGS!

This analyzer is not intended to be used on a continuous basis.

This analyzer does not have an audible alarm, and is not intended to be used as a safety device.

Except for battery replacement, this analyzer should only be opened and serviced by authorized personnel.

When testing an appliance, a full visual inspection of the appliance should be carried out to ensure its safe operation.

1.2 Operational Overview

Pressing the **I/O** button turns the analyzer ON. Note that there is a 60 second warm-up period that must elapse before the analyzer can be used.

After warm-up is complete, choose the fuel code that corresponds to the fuel being burned by the appliance being tested. Then press the **ENTER** button to place the analyzer into its Run Mode and begin the combustion testing process.

Begin testing by inserting the analyzer's probe tube into the flue-gas stream of the appliance under test. Each analyzer model will continuously monitor the flue gas and display measured and calculated values that are relative to the combustion process. These values are displayed on the analyzer's LCD, and are chosen for display by pressing the Increment (**▲**) and Decrement (**▼**) buttons.

The Fyrite Tech 60 has the capability of sending the current combustion test to an optional printer by pressing the **HOLD** button twice.

Pressing the **HOLD** button during a test will freeze all measured and calculated values at their current values. Pressing the **ENTER** button resumes testing.

A backlight enables an operator to read the display in dimly-lit areas. Pressing the **LIGHT** button turns the backlight ON and OFF. The backlight will automatically turn OFF after 10 minutes of keyboard inactivity.

A power-saver function will shut the analyzer OFF after 20 minutes of keyboard inactivity. Note, however, that the power-saver function is disabled if the detected O₂ value is less than 17.9% or the CO value is more than 50 ppm.

Press the **I/O** button to turn the analyzer OFF. Note that there is a 5 second delay before the analyzer actually turns OFF, during which time the unit can be kept ON by pressing the **ENTER** button.

If the analyzer is turned OFF while a high level of CO is still present within the unit, the pump remains running and the unit will not turn OFF until the detected CO level drops below 50 ppm.

2.0 TECHNICAL CHARACTERISTICS

The Analyzer Directly Measures and Displays:

- Flue Gas O₂ content 0.0 to 20.9% O₂
- Stack Temperature..... 0 to 999 °F (-18 to 537 °C)
- Ambient Temperature..... 32 to 212 °F (0 to 100 °C)
- Flue Gas CO content (Model 60) 0 to 2,000 ppm CO

The Analyzer Computes and Displays:

(when the measured oxygen level is below 17.9 %)

- Combustion Efficiency..... 0.1 to 99.9%
- Flue Gas CO₂ content..... 0.0 to a fuel dependent
maximum value in %
- Flue Gas CO Air-Free content (Model 60) ... 0 to 9,999 ppm
- Excess Air..... 0 to 400%

Fuel Selection:

(F1 thru F4 denotes the fuel selected as displayed on the LCD)

- Natural Gas (F1)
- Oil #2 (F2)
- LPG (F3)
- Kerosene (F4)

Normal Operating Conditions:

Temperature:

- Analyzer 32 to 104 °F (0 to 40 °C)
- Probe..... 1,000 °F max (538 °C) at
5" insertion

Humidity..... 15 to 90% RH,
Non-Condensing

Power Requirements Four 'AA' Alkaline batteries

Operating Time Up to 18 hours continuous
(pump running and back-
light off)

Warm Up Time 60 seconds

| | |
|------------------------------------|---|
| Display | 4 Digit, 2 Line, 7-segment Liquid Crystal Display |
| Front Panel Controls | Six push button switches (Refer to Section 3.4) |
| Accuracy: | |
| • Oxygen..... | ±0.3% O ₂ w/typical flue gas concentration of CO ₂ |
| • Carbon Monoxide (Model 60) | ±5% of reading or ±10 ppm, whichever is greater* |
| • Stack Temperature | ±4 °F between 32 & 255 °F (±2 °C between 0 & 124 °C) ±6 °F between 256 & 480 °F (±3 °C between 125 & 249 °C) ±8 °F between 481 & 752 °F (±4 °C between 250 & 400 °C) |
| • Ambient Temperature..... | ±4 °F between 32 & 104 °F (±2 °C between 0 & 40 °C) |
| Size | 7.5"H x 3.1"W x 2.1"D (190.5 x 78.7 x 53.3 mm) |
| Weight | 16 oz (0.454 kg) with batteries |
| Agency Approval | CE Mark |

* Tighter CO accuracy in the lower ranges, up to ±2 ppm, may be attained if a lower range calibration gas (e.g. 100 ppm CO) is used.

3.0 SETTING UP THE ANALYZER

3.1 Scope

Before using the analyzer . . .

- Check batteries (Section 3.2)
- Connect probe to analyzer (Section 3.3)
- Check setup (Section 3.5)

3.2 Checking & Replacing the Batteries

Install fresh batteries as described below. Check the analyzer for sufficient charge prior to each use. Replace the batteries if the low-battery symbol  appears in the lower right corner of the screen. To replace the batteries:

1. Remove battery cover from back of analyzer.
2. Remove old batteries and dispose of them properly.
3. Observing the polarity markings inside the battery compartment, install four 'AA' Alkaline batteries as shown in Figure 3-1.
4. Replace battery cover.

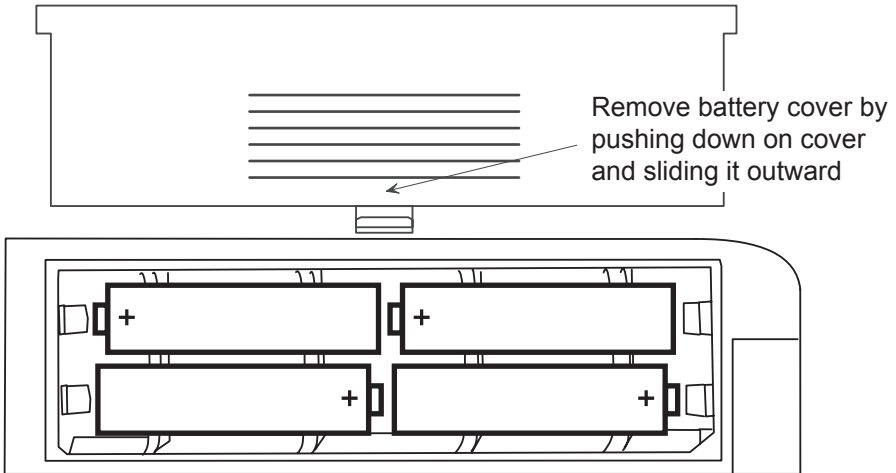

Figure 3-1. Battery Installation

3.3 Connecting the Probe

Connect the probe assembly's flue-gas hose and thermocouple connector to the analyzer as follows (see Figure 3-2):

1. Push the flue gas hose onto the analyzer's GAS inlet fitting.
2. Push the flue gas thermocouple into the T-STACK jack

Important: *DO NOT force thermocouple connector. The connection tabs are different sizes, allowing the connector to fit in only one way.*

Inspect the flue-gas hose for cracks. Replace the hose if it is defective.

Before using the analyzer, check that the Water Trap / Filter is dry and not dirty. If necessary, dry out the trap and replace the filter element per Section 5.6.

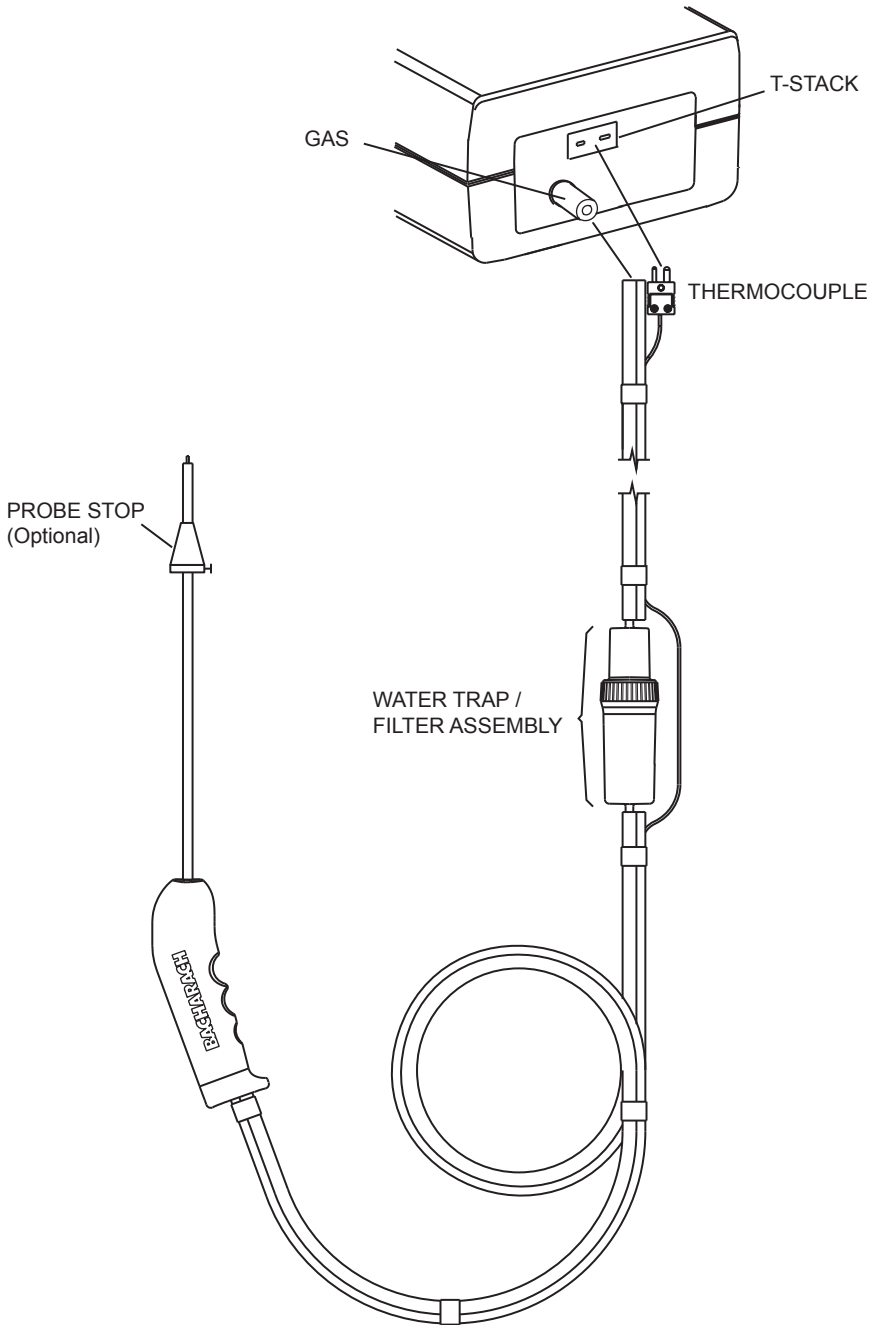

Figure 3-2. Connecting the Probe

3.4 Front Panel Pushbuttons

Note that a push button may perform several functions, depending on what screen is being displayed at the time.

- I/O**
 - Turns analyzer ON/OFF. There is a 60 second warm-up and a 5 second turn-off-delay period.
 - Places the analyzer into either its Setup or Calibration Mode when used in conjunction with the **ENTER** or **HOLD** button.
 - Aborts the CO purge function during turn-off.

- ▲**
 - Scrolls up through the display screens during a test.
 - Causes the displayed value to increase or change while in the Calibration or Setup Mode.

- ▼**
 - Scrolls down through the display screens during a test.
 - Causes the displayed value to decrease or change while in the Calibration or Setup Mode.

- ENTER**
 - Enters the Run Mode (starts a combustion test) from the Fuel Select Screen.
 - Displays the Fuel Select Screen when held down for 2 seconds while in the Run Mode.
 - Sets up the analyzer to be placed into its Calibration Mode when held down with the analyzer OFF. (Used in conjunction with the **I/O** button.)
 - Stores the displayed value and automatically steps to the next screen when pressed during calibration or setup.
 - Places the unit into its Run Mode when held down for 2 seconds while in the Calibration Mode.
 - Aborts turn-off and keeps the analyzer turned ON when pressed during the 5 second turn-off-delay period.

- HOLD**
 - Places the analyzer on hold and freezes the values in all Run Mode Screens during a test, allowing the operator to scroll through the displays and view all test values at that point in time. Pressing **ENTER** resumes testing.
 - Sets up the analyzer to be placed into its Setup Mode when held down with the analyzer OFF. (Used in conjunction with the **I/O** button.)
 - Sends combustion test data to a printer when pressed *twice* with the pump running (Fyrite Tech 60 only).

- LIGHT** Toggles the backlight ON and OFF.

3.5 Setup Mode

The analyzer is preset at the factory for the parameters shown below, but can be changed as described in their associated sections.

| Function | Parameter | To Change |
|------------------|------------------|--------------------------|
| Fuel | Natural Gas (F1) | Section 4.1.2 |
| Temperature Unit | °F | Section 3.5.2 |
| CO Channel | Auto Zero (A2) | Section 3.5.3 |
| Clock | Not initialized | Section 3.5.4 thru 3.5.6 |
| Printer Protocol | IrDA | Section 3.5.7 |

3.5.1 Entering Setup

1. With the analyzer turned OFF, press and hold down the **HOLD** button.
2. Press the **I/O** button.
3. Release both buttons.
4. The analyzer is now in its Setup Mode. Refer to Sections 3.5.2 thru 3.5.7 for information on how to set up the analyzer.

3.5.2 Selecting Temperature Units

The Temperature Units Setup Screen is labeled “Unit.”

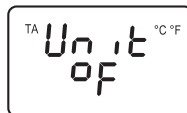

1. If not already done, enter Setup per Section 3.5.1. Repeatedly press **ENTER** until the Temperature Units Setup Screen is displayed.
2. Press the **▲** or **▼** button until the desired temperature unit (°F or °C) is displayed.
3. Press **ENTER** to move to next Setup Screen, or press **I/O** to exit setup.

3.5.3 CO Channel Setup (Model 60 only)

The CO Channel Setup Screen is labeled “CO.”



1. If not already done, enter Setup per Section 3.5.1. Repeatedly press **ENTER** until the CO Channel Setup Screen is displayed.
2. Press the ▲ or ▼ button until the desired parameter is displayed.
 - no Sensor disabled. Use this function to turn off the CO channel if the sensor is missing or known to be bad to avoid inaccurate CO readings from appearing.
 - 2Ero Manual Zero. When the CO channel is set to manual zero, the analyzer does not zero the CO sensor to ambient conditions during start up.
 - A2 Auto Zero. With the CO channel set to auto zero, the CO sensor is zeroed to the ambient CO level during start up. **Important: When using this mode the analyzer must be turned ON in fresh air; otherwise, incorrect CO readings will occur.**
3. Press **ENTER** to move to next Setup Screen, or press **I/O** to exit setup.

3.5.4 Time Setup (Model 60 only)

There are two Time Setup Screens, one for hours and the other for minutes. Two bars appear above the segments being changed. The clock value is displayed in a 24 hour format for setup purposes, but will appear as AM/PM on the printout.

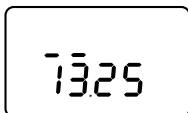

1. If not already done, enter Setup per Section 3.5.1. Repeatedly press **ENTER** until the first Time Setup Screen is displayed—the one with two bars over the hour digits.

2. Press the ▲ or ▼ button until the correct hour value is displayed.
3. Press **ENTER** to move the selection bars over the minute digits.
4. Press the ▲ or ▼ button until the correct minute value is displayed.
5. Press **ENTER** to move to next Setup Screen, or press **I/O** to exit setup.

3.5.5 Date Setup (Model 60 only)

There are two Date Setup Screens, each labeled “DATE”. The first screen sets the month while the second sets the day.

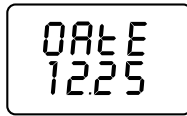

1. If not already done, enter Setup per Section 3.5.1. Repeatedly press **ENTER** until the first Date Setup Screen is displayed.
2. Press the ▲ or ▼ button until the correct month is displayed.
3. Press **ENTER** to change the ‘Day’ value.
4. Press the ▲ or ▼ key until the correct day is displayed.
5. Press **ENTER** to move to next Setup Screen, or press **I/O** to exit setup.

3.5.6 Year Setup (Model 60 only)

The Year Setup Screen is labeled “YEAR”.



1. If not already done, enter Setup per Section 3.5.1. Repeatedly press **ENTER** until the Year Setup Screen is displayed.
2. Press the ▲ or ▼ button until the correct year is displayed.
3. Press **ENTER** to move to next Setup Screen, or press **I/O** to exit setup.

3.5.7 Selecting Printer Protocol (Model 60 only)

The analyzer can be set up for either an HP or IrDA type printer.

1. If not already done, enter Setup per Section 3.5.1. Repeatedly press **ENTER** until one of the following screens is displayed.

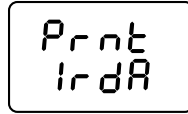
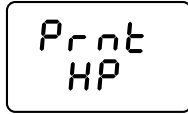

2. Press the ▲ or ▼ button to select the desired printer protocol.
3. Press **ENTER** to move to next Setup Screen, or press **I/O** to exit setup.

3.5.8 Exiting Setup

Press the **I/O** button at any time to exit the Setup Mode and turn OFF the analyzer.

Note that the last displayed parameter is automatically saved in memory.

4.0 OPERATION

4.1 Performing a Test

4.1.1 Analyzer Turn On and Warm Up

Important: *The probe must be at room temperature before performing the following steps. The temperature measured by the probe during warm up is the combustion-air temperature used by the analyzer for efficiency calculations purposes.*

1. Make sure that the analyzer is properly set up per Section 3.0.
2. During warm-up, the analyzer's probe must be located in the area containing the burner's combustion-air supply. If the burner is using room air, simply place the probe within the room. In the case of a high-efficiency furnace where combustion air is drawn in from an outside source, place the probe within that area with the burner operating. After the probe is properly positioned, turn ON the analyzer by pressing its **I/O** button.
3. Wait for the analyzer to complete its 60 second warm-up period; after which, the Fuel Screen is displayed. If errors were detected during warm-up, the Sensor Error Screen will be displayed. If this occurs, refer to Section 4.8.9 to correct the cause of the error.

4.1.2 Selecting a Fuel

1. With the Fuel Screen displayed, use the **▲** or **▼** button to step through the fuels codes until the proper fuel is displayed. The analyzer defaults to the most recently selected fuel.



| | |
|------------------|---------------|
| F1 = Natural Gas | F3 = LPG |
| F2 = Oil #2 | F4 = Kerosene |

2. Press the **ENTER** button to select the displayed fuel code; after which, the analyzer enters the Run Mode.

4.1.3 Manual Zero of the CO Channel (Model 60 only)

If the CO channel is set up for manual calibration (refer to Section 3.5.3), and if the CO reading shows a value other than zero in fresh air, then before proceeding with a test manually zero the CO channel per Section 5.5.

4.1.4 Sampling Point

Forced Air Furnace – When testing atmospheric burner or gravity vented, forced air heating equipment with a clamshell or sectional heat exchanger design, test each of the exhaust ports at the top of the heat exchanger. The probe should be inserted back into each of the exhaust ports to obtain a flue gas sample, before any dilution air is mixed in.

Hot Water Tank – Domestic hot water tanks with the ‘bell’ shaped draft diverter on top can be accurately tested by inserting the probe tip directly into the top of the fire tube below the diverter.

80% Efficiency Fan Assist or Power Vented – Combustion testing of fan assist or power vented, furnaces/boilers should be done through a hole drilled in the vent immediately above the inducer fan.

90% Efficiency Condensing – Condensing furnaces/boilers can be tested through a hole drilled in the plastic vent pipe (when allowed by the manufacturer or local authority of jurisdiction) or taken from the exhaust termination.

Atmospheric or Gravity Vented Boiler – Boilers, which have a ‘bell’ shaped draft diverter directly on top, should be tested directly below the diverter through a hole drilled in the vent connector.

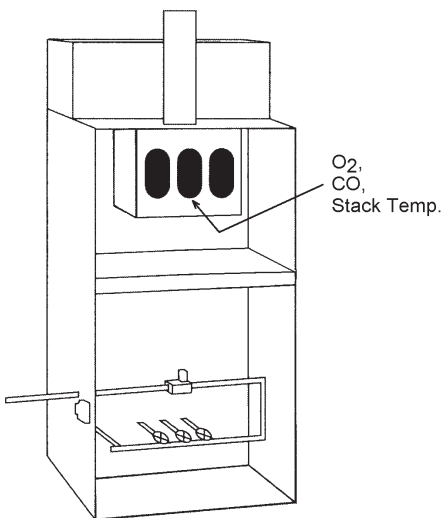

**Atmospheric Burner or
Gravity Vented Forced Air**

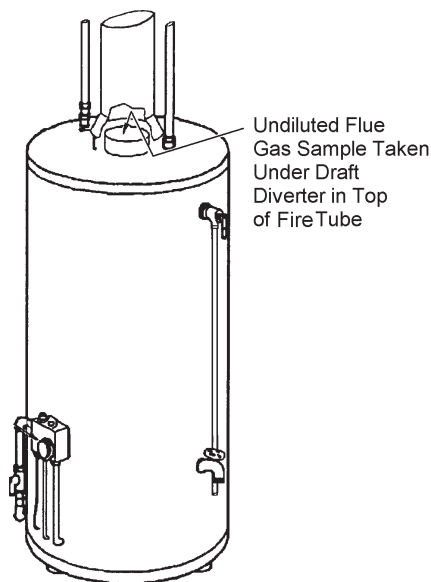

Hot Water Tank

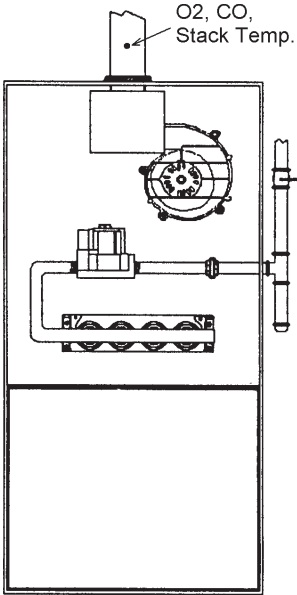

**80% Eff. Fan Assist
or Power Vented
Furnace/Boiler**

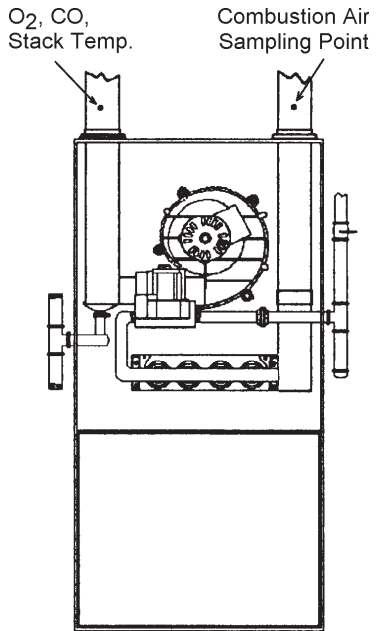

**90% Eff. Condensing
Furnace/Boiler**

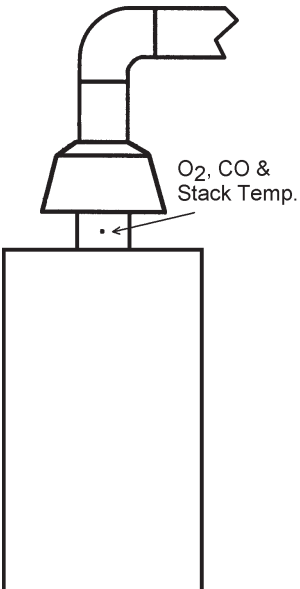

**Atmospheric or
Gravity Vented Boiler**

4.1.5 Performing a Combustion Efficiency Test

1. After turning ON the analyzer and selecting the appropriate fuel, press the ▲ or ▼ button until the Stack Temperature & Efficiency Screen (refer to Section 4.8.7) is displayed.

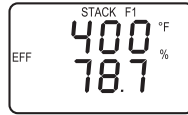

2. Position the probe in the flue-gas stream to obtain the hottest “STACK” reading. *Locating the highest stack temperature is very important for accurate efficiency calculations.*
3. You can now begin burner-service procedures. Use the ▲ and ▼ buttons during a test to scroll through the analyzer’s other display screens (refer to Section 4.7). The analyzer readings will update continuously showing changes in burner performance.
4. Pressing the **HOLD** button freezes all readings and stops the pump. The ▲ and ▼ buttons can now be used to scroll through the displays and view all test values at the moment the **HOLD** button was pressed. Pressing **ENTER** restarts the pump and resumes testing.

4.1.6 Printing Test Results (Model 60 only)

During a combustion efficiency test, the current test results can be sent to a printer as follows:

1. Turn ON printer.

TIP: Refer to the printer’s instruction manual for detailed operating information. If not already done, set up the printer for 9600 baud, DTR handshaking, and the same protocol as the analyzer (HP or IrDA). Refer to Section 3.5.7 Selecting Printer Protocol.

2. Align the printer with the top of the analyzer as shown in Figure 4-1.
3. Begin printing by doing one of the following:
 - If the pump is running, press the **HOLD** button *twice*.
 - If the display has been previously frozen by pressing the **HOLD** button, press the **HOLD** button only *once*.

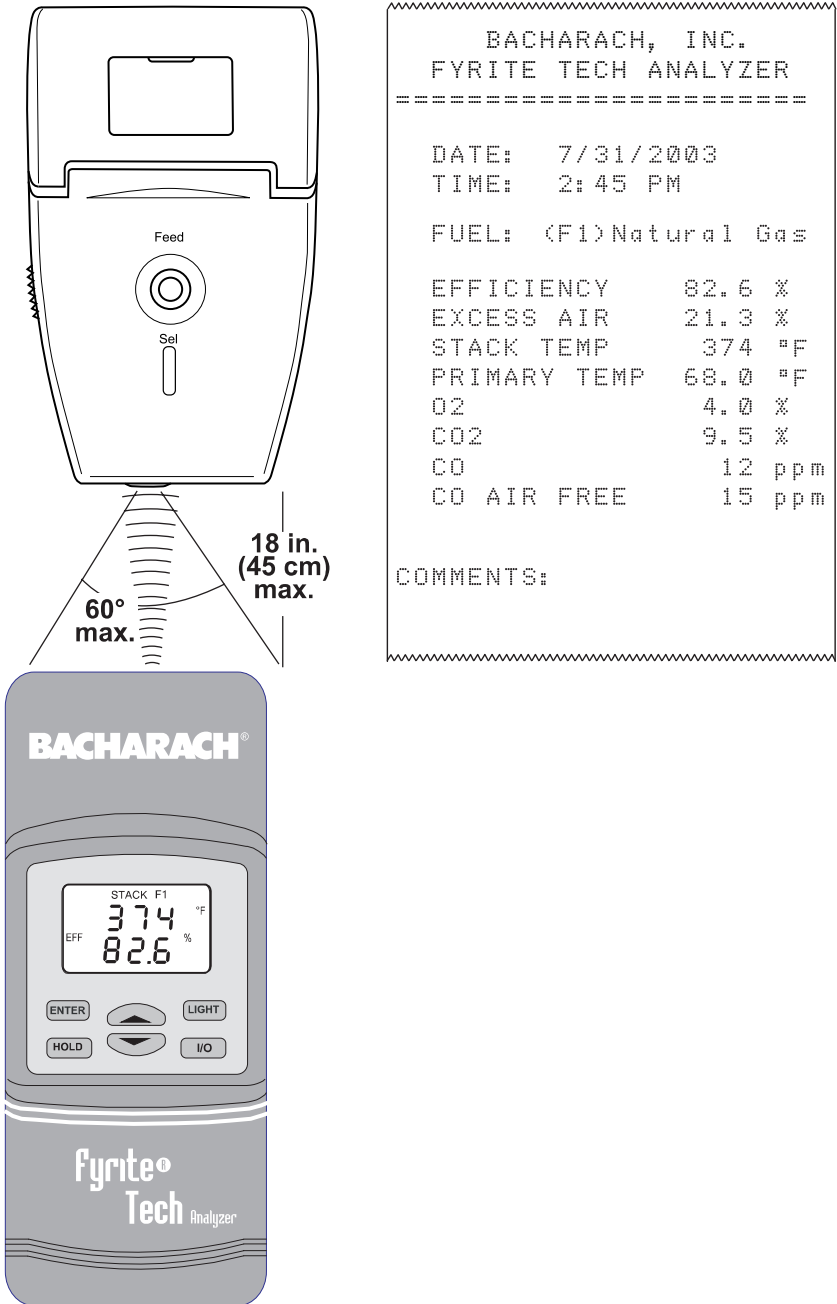

Figure 4-1. Printer Alignment & Sample Printout

4.1.7 Ending a Combustion Test



WARNING! Burn Hazard. Do not touch the probe after removing it from the stack. Allow the probe to cool before handling (about 5 minutes).

1. Remove probe from the flue-gas stream.
2. Allow the pump to run until all combustion gases are flushed from the analyzer as indicated by the O₂ reading returning to 20.9%.

4.1.8 Turning OFF the Analyzer

After the analyzer has been purged with fresh air, turn it OFF by pressing the **I/O** button. The unit will count down from 5 before turning OFF. Pressing the **ENTER** button, however, will stop the count down and keep the analyzer turned ON.



4.2 CO Purge During Turn OFF (Model 60 only)

If the detected CO level is above 50 ppm when the analyzer is turned OFF, the unit will remain ON with its pump running and display “PurG CO.” The countdown from 5 will not begin until the CO level drops below 50 ppm.

Although not recommended for everyday use, the purging process can be bypassed by pressing the **I/O** button a second time.

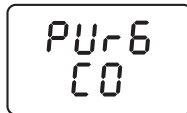

4.3 Operating Tips

- When an analyzer is brought in from a cold vehicle, let it warm up slowly to minimize condensation. Temperatures below freezing will not damage the analyzer; however, bringing a cold analyzer into a warm, humid environment may cause condensate to form inside the case.
- If the CO channel (Fyrite Tech 60) is set up for Auto Zero (refer to Section 3.5.3), ensure that the analyzer is sampling fresh air when turned ON. Pulling a flue-gas sample through the analyzer during its warm-up period will not damage the analyzer, but it will result in incorrect CO readings. Also note that a CO sensor error will occur if the detected CO level is above 50 ppm during warm-up.
- For analyzers that are used to measure flue-gas, note that flue-gas condensate is acidic and very corrosive. It is important not to allow the analyzer's internal components to become soaked in condensate for long periods of time.
- Before each use, inspect the filter element of the water-trap / filter assembly. Replace the filter if it looks dirty.
- When sampling flue-gas, keep the analyzer above the water-trap, and keep the trap in a vertical position. This will maximize the effectiveness of the trap and keep liquid condensate from being drawn directly into the analyzer.
- When liquid condensate is seen inside the water trap, empty the trap before it becomes full. Refer to Section 5.6.
- It is recommended that the analyzer be purged after taking a flue-gas measurement before turning it OFF. Once the probe is removed from the stack, disconnect the hose assembly from the bottom of the analyzer and let the pump run for 10 minutes or so to completely remove any remaining flue gases and dry any condensate from inside the sensor chamber.
- When storing the analyzer, it's a good idea to empty the water trap and leave it open to further dry it out.
- Calibrate the analyzer every 6 months to ensure its accuracy.

4.4 Using the Backlight

The LCD can be read in dimly-lit areas by pressing the **LIGHT** button.

The backlight automatically turns OFF after 10 minutes of keyboard inactivity, but can be turned OFF at any time by again pressing the **LIGHT** button.

4.5 Using the Probe

A rigid stainless steel probe with handle, connected to a flexible hose with integral water-trap / filter can be used to draw a gas sample into the analyzer from the room, grilles, diffusers, and furnace flues.

The hose and probe assembly can be detached from the analyzer when the operator desires to sample without the probe.

4.6 Resetting the Microprocessor

If the analyzer 'locks-up' and cannot be turned OFF, reset the microprocessor by removing one of the batteries for five seconds.

4.7 Run Mode Screens

The following diagrams show the order in which the screens are displayed by pressing the ▲ ▼ buttons while in the Run Mode.

Fyrite Tech 50

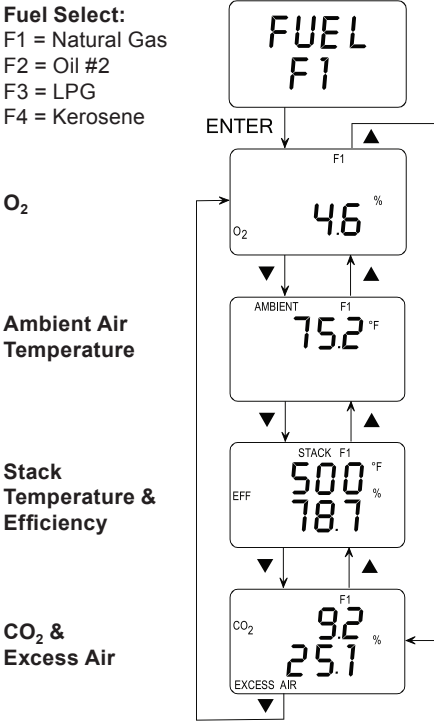

Fyrite Tech 60

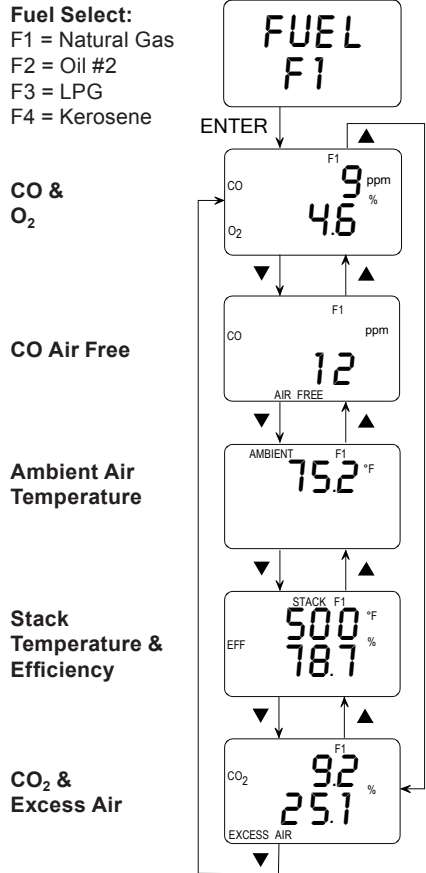

4.8 Screen Descriptions

4.8.1 Warm-Up Screens

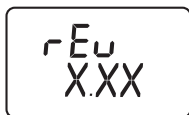
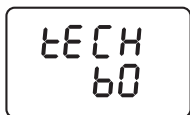

As soon as the analyzer is turned ON, a series of Warm-Up Screens are displayed. These screens show the analyzer's model number (Tech 50 or Tech 60), the unit's software revision, and finally the remaining warm-up time counted down from 60 seconds. At the end of warm-up, the analyzer displays the Fuel Screen (refer to Section 4.8.2).

Note: *If any errors were detected during warm-up, the Sensor Error Screen is displayed (refer to Section 4.8.9).*

4.8.2 Fuel Screen



The Fuel Screen is displayed after warm-up, or can be accessed from any Run Mode Screen by holding down the **ENTER** button for 2 seconds. The Fuel Screen is where an operator chooses which fuel is to be used by the analyzer to calculate combustion efficiency. Use the **▲** or **▼** button to scroll through the fuel codes until the desired fuel is displayed, and then press **ENTER** to select the displayed fuel and place the analyzer into its Run Mode. Note that the fuel code will be displayed in the top right corner of all screens while in the Run Mode.

Fuel Codes: F1 = Natural Gas
 F2 = Oil #2
 F3 = LPG
 F4 = Kerosene

Front Panel Button Functions:

- ▲ / ▼** – Scroll through fuel codes
- ENTER** – Select fuel and enter Run Mode (refer to Section 4.7)
- HOLD** – No effect
- LIGHT** – Toggles backlight ON/OFF
- I/O** – Turns analyzer OFF (no delay)

4.8.3 O₂ Screen (Model 50 only)



The O₂ display is the measured percentage of oxygen present in the flue-gas stream.

Front Panel Button Functions:

- ▲ / ▼ – Scroll through Run Mode Screens (refer to Section 4.7)
- ENTER** – Hold for 2 seconds to display Fuel Screen
- HOLD** – Freezes display (press **ENTER** to unfreeze)
- LIGHT** – Toggles backlight ON/OFF
- I/O** – Turns analyzer OFF (with a 5 second delay)

4.8.4 CO & O₂ Screen (Model 60 only)



The CO display is the measured ppm amount of carbon monoxide present in the flue-gas stream. Note, however, that the amount of CO displayed may be diluted by secondary air (refer to Section 4.8.5 CO Air Free Screen).

The O₂ display is the measured percentage of oxygen present in the flue-gas stream.

Front Panel Button Functions:

- ▲ / ▼ – Scroll through Run Mode Screens (refer to Section 4.7)
- ENTER** – Hold for 2 seconds to display Fuel Screen
- HOLD** – Freezes display (press **ENTER** to unfreeze)
- LIGHT** – Toggles backlight ON/OFF
- I/O** – Turns analyzer OFF (with a 5 second delay)

4.8.5 CO Air Free Screen (Model 60 only)



The CO AIR FREE reading is a calculation of the exact ppm concentration of carbon monoxide if oxygen were 0.0% in accordance with ANSI standard Z21.1.

$$\text{CO}_{\text{Air Free}} = \frac{\text{CO} \times 20.9}{20.9 - \text{O}_2_{\text{measured}}}$$

Front Panel Button Functions:

- ▲ / ▼ – Scroll through Run Mode Screens (refer to Section 4.7)
- ENTER** – Hold for 2 seconds to display Fuel Screen
- HOLD** – Freezes display (press **ENTER** to unfreeze)
- LIGHT** – Toggles backlight ON/OFF
- I/O** – Turns analyzer OFF (with a 5 second delay)

4.8.6 Ambient Air Temperature Screen

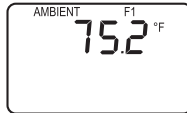

The AMBIENT reading is the room temperature in either °F or °C as measured by a temperature sensor located inside the analyzer.

Note: *The combustion-air temperature, which was measured by the probe's thermocouple during warm-up, is stored by the analyzer for efficiency calculation purposes, but cannot be displayed.*

Front Panel Button Functions:

- ▲ / ▼ – Scroll through Run Mode Screens (refer to Section 4.7)
- ENTER** – Hold for 2 seconds to display Fuel Screen
- HOLD** – Freezes display (press **ENTER** to unfreeze)
- LIGHT** – Toggles backlight ON/OFF
- I/O** – Turns analyzer OFF (with a 5 second delay)

4.8.7 Stack Temperature & Efficiency Screen

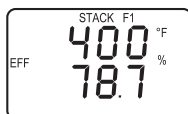

The STACK display is the temperature measured at the tip of the probe.

The EFF (Efficiency) reading is a calculation of what percentage of energy present in the fuel was converted into usable heat.

Front Panel Button Functions:

- ▲ / ▼ – Scroll through Run Mode Screens (refer to Section 4.7)
- ENTER** – Hold for 2 seconds to display Fuel Screen
- HOLD** – Freezes display (press **ENTER** to unfreeze)
- LIGHT** – Toggles backlight ON/OFF
- I/O** – Turns analyzer OFF (with a 5 second delay)

4.8.8 CO₂ & Excess Air Screen



The CO₂ reading is a calculation of the percentage of carbon dioxide that is being produced by the combustion process.

Excess Air is a calculation of the percentage of extra air that was available in the combustion chamber above the theoretical amount needed for perfect combustion.

Front Panel Button Functions:

- ▲ / ▼ – Scroll through Run Mode Screens (refer to Section 4.7)
- ENTER** – Hold for 2 seconds to display Fuel Screen
- HOLD** – Freezes display (press **ENTER** to unfreeze)
- LIGHT** – Toggles backlight ON/OFF
- I/O** – Turns analyzer OFF (with a 5 second delay)

4.8.9 Sensor Error Screen

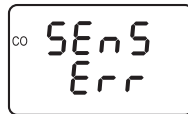
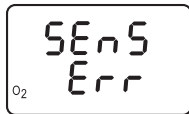

An O₂ sensor error is displayed if the analyzer determines during the warm-up cycle that the O₂ sensor's output is too low for it to be usable. However, in the extreme condition when the O₂ sensor has *no output*, a sensor error will not occur. Instead, the O₂ reading will be 0.0 as displayed in the O₂ Screen (Model 50) or the CO & O₂ Screen (Model 60).

When the CO channel (Model 60 only) is set up for Auto Zero (refer to Section 3.5.3), a CO sensor error will occur if the detected carbon monoxide level is above 50 ppm during the warm-up cycle. Note that if the CO channel is set up for manual calibration, the analyzer does not auto-zero the CO sensor during warm-up, and thus does not generate a CO sensor error when the analyzer is turned ON in an atmosphere containing a high background level of CO.

Do the following before replacing a suspected spent or defective sensor:

1. Turn OFF the analyzer and turn it back ON in an area of fresh air (containing 20.9% O₂ and no CO).
2. Perform the Oxygen Sensor Zero procedure (Section 5.4) and, if applicable, the CO Sensor Zero & Calibration procedure (Section 5.5).
3. If Steps 1 & 2 do not eliminate the error condition, replace sensor(s) (refer to Sections 5.7 or 5.8).

5.0 CALIBRATION & MAINTENANCE

Important: *Fresh batteries should be installed, and the unit allowed to stabilize at room temperature for at least two hours before proceeding with calibration. To maintain accuracy as listed in the Technical Characteristics Section of this manual, the standards used must be at least four times as accurate as the stated accuracy of the Fyrite Tech.*

5.1 Entering the Calibration Mode and Testing the Display Segments

1. With the analyzer turned OFF, place the unit in fresh, ambient air.
2. Press and hold down the **ENTER** button, and then press and release the **I/O** button. Observe that all LCD segments are turned ON.
3. Release the **ENTER** button. Observe the unit's model number and software version are displayed. The word "CAL" is then displayed while the unit counts down from 60 seconds.

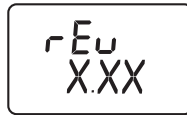
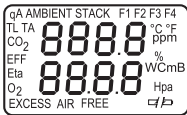

At the end of 60 seconds, the first calibration screen is automatically displayed.

Note: *During calibration: 1) The ▲ and ▼ buttons are used to increase or decrease a displayed calibration value. 2) Press **ENTER** to store the new value and move to the next screen. 3) Press and hold down the **ENTER** button for 2 seconds to exit the Calibration Mode.*

5.2 Ambient Temperature Calibration

Material Required: Calibrated Thermometer

Procedure:

1. Enter the Calibration Mode as described in Section 5.1. Observe that “AMBIENT” is displayed at the top of the display; if not, repeatedly press **ENTER** until it appears.

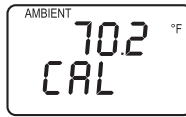

2. Use the ▲ and ▼ buttons to set the displayed value to match the reading of a calibrated thermometer at room temperature.
3. Press **ENTER** to store the displayed value and move to the next calibration screen, or hold down **ENTER** for 2 seconds to store the displayed value and enter the Run Mode, or press the **I/O** button to exit the Calibration Mode and turn OFF the analyzer without saving the changes.

5.3 Stack Thermocouple Channel Calibration

Material Required: Thermocouple Simulator

Procedure:

1. Attach the thermocouple simulator to the Stack Thermocouple connector on the analyzer (T-STACK, see Figure 3-2).
2. Enter the Calibration Mode as described in Section 5.1. Then repeatedly press the **ENTER** button until “STACK” appears at the top of the display.

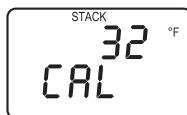

3. Set the simulator to 32 °F (0 °C). Then use the ▲ and ▼ buttons to set the displayed value to match the simulator's value.

4. Set the simulator to 572 °F (300 °C). Then use the ▲ and ▼ buttons to adjust the displayed value to match simulator's value.
5. Repeat Steps 3 and 4 as necessary until the unit is reading correctly at both temperatures.
6. Press **ENTER** to store these calibration values and move to the next calibration screen, or hold down **ENTER** for 2 seconds to store these calibration values and enter the Run Mode, or press the **I/O** button to exit the Calibration Mode and turn OFF the analyzer without saving the changes.
7. Remove thermocouple simulator from analyzer.

5.4 O₂ Sensor Zero

Material Required:

- Cylinder of 100% Nitrogen, P/N 9550-0049
- Calibration Kit, P/N 24-7059

Procedure:

1. With the analyzer sampling fresh air, enter the Calibration Mode as described in Section 5.1. Then repeatedly press the **ENTER** button until "O₂" appears in the lower left side of the display.
2. Allow pump to run and sample fresh air for at least 1 minute.
3. Use the ▲ and ▼ buttons to set the display to 20.9%.



4. Set up the Calibration Kit with 100% N₂ as described in the instructions supplied with the kit.
5. Connect the tubing of the Calibration Kit to the inlet of the analyzer. Then adjust the regulator for approximately 2 SCFH of excess flow (see Figure 5-1).
6. After the analyzer has stabilized (2 to 3 minutes,) use the ▲ and ▼ buttons to set the displayed value to 0.0%.
7. Turn off gas flow and disconnect tubing from analyzer.

8. Allow the pump to run until the O₂ reading returns to 20.9. If necessary, use the ▲ and ▼ buttons to readjust the reading to 20.9. Repeat Steps 3 thru 7 to verify the zero adjustment.
9. Press **ENTER** to store the new calibration values and move to the next calibration screen, or hold down **ENTER** for 2 seconds to store the new calibration values and enter the Run Mode, or press the **I/O** button to exit the Calibration Mode and turn OFF the analyzer without saving the changes.

5.5 CO Sensor Zero & Calibration (Model 60 only)

- Material Required:**
- Cylinder of 100 ppm (P/N 51-1994) or 500 ppm (P/N 24-0492) CO calibration gas
 - Calibration Kit, P/N 24-7059

If the analyzer will be primarily used for flue gas testing, we suggest calibrating your Fyrite Tech 60 with 500 ppm CO calibration gas. If the analyzer will be primarily used for ambient CO testing, then you may wish consider using 100 ppm CO calibration gas.

Procedure:

1. With the analyzer sampling fresh air, enter the Calibration Mode as described in Section 5.1. Then repeatedly press the **ENTER** button until “CO” appears in the upper left side of the display.

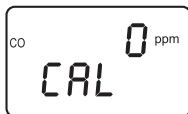

2. Allow the pump to run and sample fresh air for at least 1 minute.
3. Use the ▲ and ▼ buttons to set the displayed value to 0 ppm.
4. Do one of the following:
 - a. End this procedure and save the new zero value by holding down the **ENTER** button for 2 seconds; after which, the analyzer enters the Run Mode.
 - b. Continue with Step 5 to span the CO sensor to a known concentration of carbon monoxide.

5. Set up the Calibration Kit with 100 or 500 ppm CO as described in the instructions supplied with the kit.
6. Connect the tubing of the Calibration Kit to the inlet of the analyzer. Then adjust the regulator for approximately 2 SCFH of excess flow (see Figure 5.1).
7. After the analyzer has stabilized (2 to 3 minutes), use the ▲ and ▼ buttons to set the displayed value to match the CO concentration stamped on the gas cylinder.
8. Press **ENTER** to store the new calibration values and move to the next calibration screen, or hold down **ENTER** for 2 seconds to store the new calibration values and enter the Run Mode, or press the **I/O** button to exit the Calibration Mode and turn OFF the analyzer without saving the changes.
9. Turn off gas flow and disconnect tubing from analyzer.

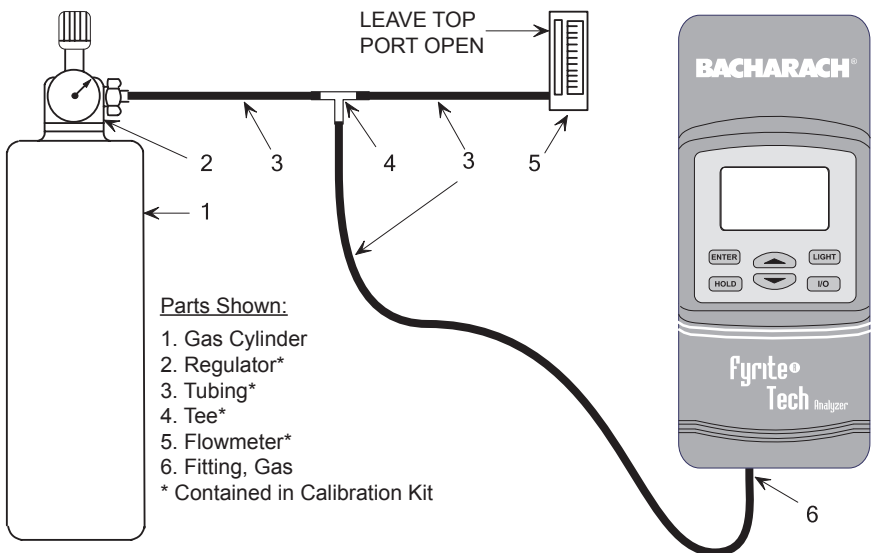

Figure 5-1. Calibration Kit Hookup

5.6 Water Trap / Filter Maintenance

The Water Trap / Filter Assembly removes water condensate from the gas sample, and also prevents soot from contaminating the internal components of the analyzer.

Drain the water condensate after every test.

Procedure:

1. Pull apart the Water Trap / Filter assembly (see Figure 5-2).
2. Pour out all water condensate. Then reassemble the trap.

Replace the Filter Element when dirty.

Material Required:

- Filter Element, P/N 07-1644
- Small Flat Blade Screwdriver

Procedure:

1. Pull apart the Water Trap / Filter assembly (see Figure 5-2).
2. Pry apart the Filter Chamber. Then remove and discard old filter.
3. Install new filter and reassemble trap, making sure that surfaces "A" and "B" are in contact.

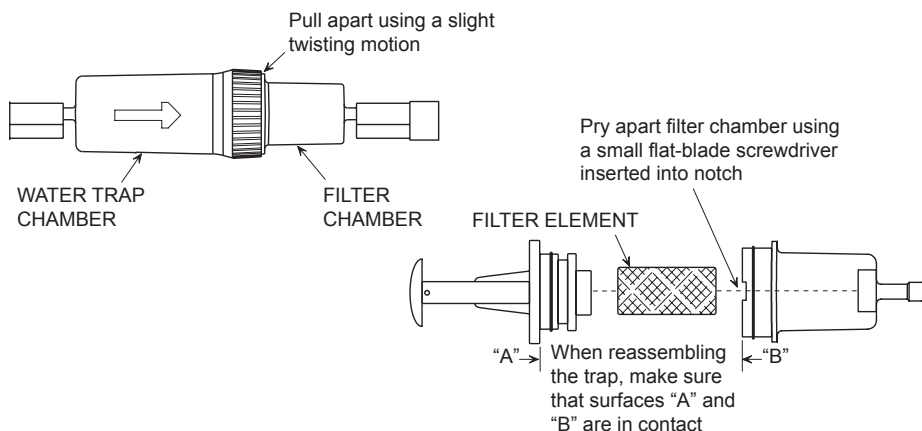

Figure 5-2. Water Trap / Filter Assembly

5.7 O₂ Sensor Replacement

Be sure to perform all of the checks listed in Section 4.8.9 to ensure that the O₂ sensor needs to be replaced.

Material Required:

- O₂ Sensor, P/N 24-8106
- #1 Phillips Screwdriver

Procedure:

1. Disassemble the analyzer as follows:
 - a. Remove the battery cover and the batteries, uncovering one of the cover hold-down screws.
 - b. Remove and set aside all four cover hold-down screws.
 - c. With the analyzer on its back, remove the front cover, laying it face down to the left of the body.
 - d. Remove the battery connector from top of circuit board. Then carefully remove the circuit board laying it face down in the top cover.
2. Remove the O₂ sensor's electrical connector from the circuit board. Then push down; twist counterclockwise; and then pull the O₂ sensor out of its socket (see Figure 5-3).

Tip: *To obtain a better grip on the O₂ sensor, it may be necessary to remove the screw that secures the sensor socket to the case.*

3. Using the old sensor as a guide, remove the paper backing from the new sensor gasket contained in the replacement kit, and adhere it to the new sensor.
4. Dispose of the old O₂ sensor in a proper manner (see the instruction sheet that comes with the new sensor).
5. Mount the new O₂ sensor in its socket. If the sensor socket was removed in Step 2, re-attach it to the case.
6. Plug the O₂ sensor's electrical connector into the printed circuit board (observe polarity, see Figure 5-4), and then reassemble the analyzer.

Note: *A new O₂ sensor may take several hours to stabilize after being connected to the printed circuit board.*

5.8 CO Sensor Replacement (Model 60 Only)

Be sure to perform all of the checks listed in Section 4.8.9 to ensure that the CO sensor needs to be replaced.

- Material Required:**
- CO Sensor, P/N 24-7265
 - CO Sensor Gasket, P/N 24-1112
 - #1 Phillips Screwdriver

Procedure:

1. Disassemble the analyzer as follows:
 - a. Remove the battery cover and the batteries, uncovering one of the cover hold-down screws.
 - b. Remove and set aside all four cover hold-down screws.
 - c. With the analyzer on its back, remove the front cover, laying it face down to the left of the body.
 - d. Remove the battery connector from top of circuit board. Then carefully remove the circuit board laying it face down in the top cover.
2. Gently pull CO sensor out of its socket (see Figure 5-4).
3. Properly dispose of the old CO sensor (see the instruction sheet that comes with the new sensor).
4. It is recommended that the CO sensor gasket be replaced at the same time as the sensor. Remove the old gasket and discard. Remove the paper backing from the new gasket and adhere it to the case in the same position as the old one.

Important: *Ensure that the new gasket does not restrict the inlet and exhaust holes in the case.*
5. Plug the new CO sensor into its socket.
6. Reassemble the analyzer.

5.9 Pump Assembly Replacement

- Material Required:**
- Pump, P/N 24-3020
 - #1 Phillips Screwdriver

Procedure:

1. Disassemble the analyzer as follows:
 - a. Remove the battery cover and the batteries, uncovering one of the cover hold-down screws.
 - b. Remove and set aside all four cover hold-down screws.
 - c. With the analyzer on its back, remove the front cover, laying it face down to the left of the body.
 - d. Remove the battery connector from top of circuit board. Then carefully remove the circuit board laying it face down in the top cover.
2. Remove the pump motor's electrical connector from the circuit board.
3. Unscrew the pump's hold down clamp and remove it from the pump (see Figure 5-3). Make note of how the pump wiring is routed.
4. Make note of how the tubing connects to the pump, and then carefully remove tubing from pump.
5. Remove the old pump and discard.
6. Mount the new pump using the hardware removed in Step 3.
7. Install tubing as was noted in Step 4, being careful not to pinch or crimp the tubing.
8. Connect the pump's electrical connector to the circuit board, routing the wiring as was noted in Step 3 (observe polarity, see Figure 5-4).
9. Reassemble the analyzer.

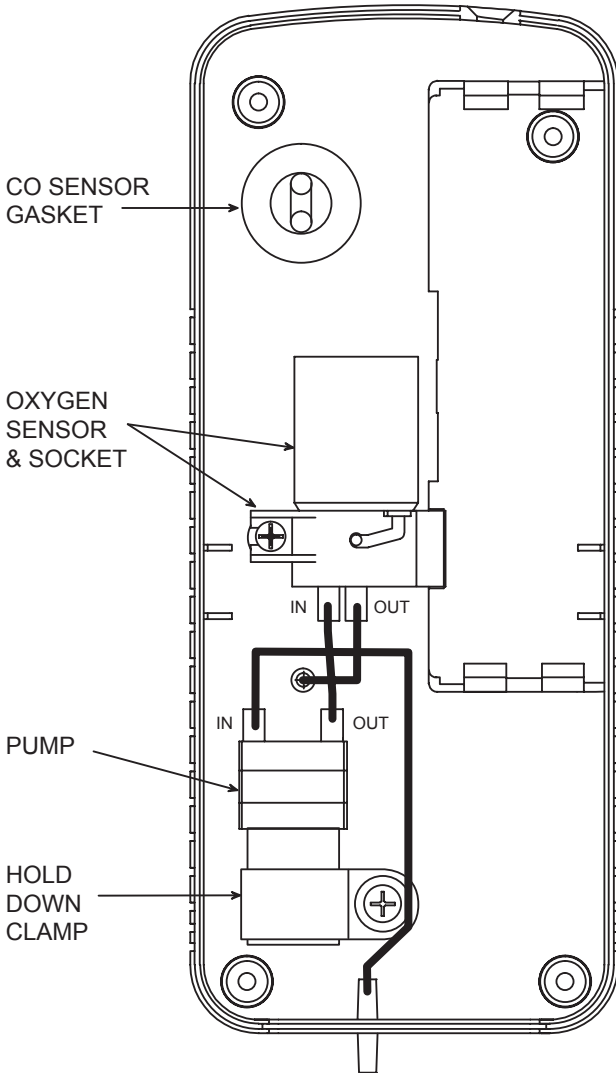

Figure 5-3. Back Case Component Locations

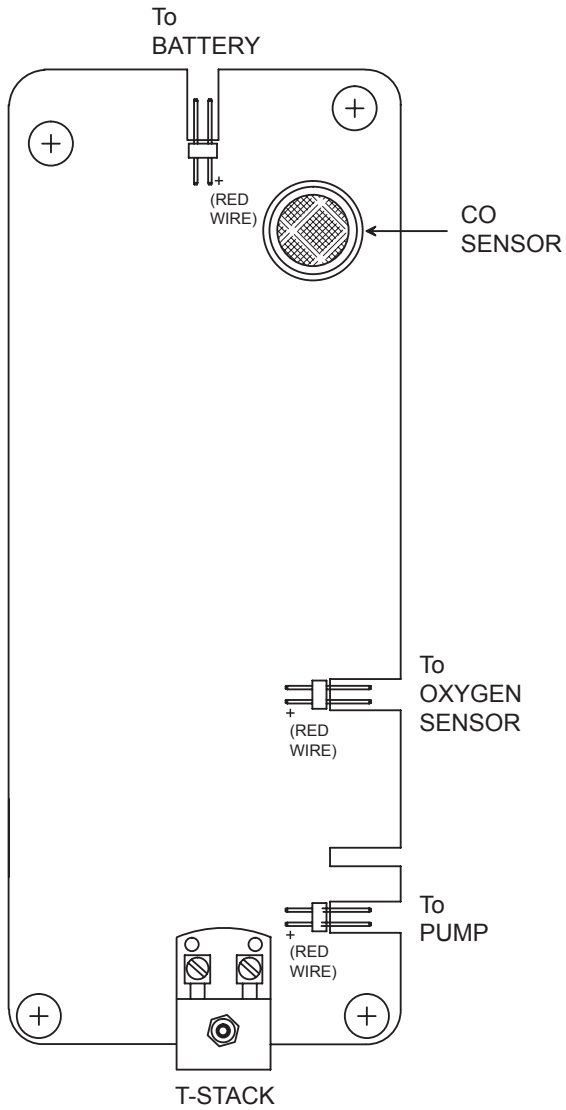

Figure 5-4. CO Sensor Location

6.0 PARTS & SERVICE

6.1 Replacement Parts

| Description | Part No. |
|--|-----------------|
| Carbon Monoxide Sensor (Model 60 only)..... | 24-7265 |
| Carbon Monoxide Sensor Gasket (Model 60 only) | 24-1112 |
| Oxygen Sensor w/ Gasket | 24-8106 |
| Oxygen Sensor Gasket | 24-1111 |
| Pump Assembly | 24-3020 |
| Probe, Hose, and Water Trap / Filter Assembly | 19-7111 |
| Tubing, Probe Assembly, 3/16" ID | 03-6183 |
| Water Trap / Filter Assembly | 19-3265 |
| Filter Element, for Water Trap / Filter Assembly, (pack of 3)..... | 07-1644 |

6.2 Accessories

STANDARD ACCESSORIES:

| | |
|-----------------------------|----------|
| Battery, "AA" Alkaline..... | 204-0004 |
| Instruction Manual..... | 24-9428 |
| Soft Carrying Case | 24-1267 |
| Quick Start Guide | 24-9429 |

OPTIONAL ACCESSORIES:

| | |
|--|-----------|
| Calibration Kit | 24-7059 |
| Gas Cylinder, 100 ppm CO | 51-1994 |
| Gas Cylinder, 500 ppm CO | 24-0492 |
| Gas Cylinder, 100% Nitrogen | 9550-0049 |
| Hard Carrying Case | 24-0865 |
| Printer: | |
| IrDA w/ rechargeable batteries (includes 120VAC charger) | 24-1229 |
| IrDA w/ disposable batteries | 24-1400 |
| Printer Paper: | |
| 1 Roll | 06-8733 |
| 5 Roll Pack | 24-1310 |
| Protective Rubber Boot w/ Magnets..... | 24-1127 |
| Probe Stop w/ Thumbscrew | 19-3037 |
| True Spot Smoke Test Set | 21-7006 |
| Filter Paper, for True Spot, 40 strips | 21-0019 |

6.3 Service Centers

Replacement parts and service can be obtained by contacting one of the following Bacharach Service Centers:

United States

California

7281 Garden Grove Blvd.,
Suite H
Garden Grove, CA 92841
Phone: 714-895-0050
Fax: 714-895-7950
Email: calservice@bacharach-inc.com

New Jersey

7300 Industrial Park
Rte. 130, Bldg. 22
Pennsauken, NJ 08110
Phone: 856-665-6176
Fax: 856-665-6661
Email: njservice@bacharach-inc.com

Pennsylvania

621 Hunt Valley Circle
New Kensington, PA 15068
Phone: 724-334-5051
Fax: 724-334-5723
Email: help@bacharach-inc.com

Canada

Bacharach of Canada, Inc.
250 Shields Court Unit #3
Markham, Ontario L3R 9W7 Canada
Phone: 905-470-8985
Fax: 905-470-8963
Email: bachcan@idirect.com

México

Bacharach de México
Playa Regatas No. 473 Tercer Piso
Col. Militar Marte
Delegación Iztacalco, 08830
México D.F. México
Phones: +52-555-634-7740
+52-555-634-7741
FAX: +52-555-634-7738
Email: bacharach@prodigy.net.mx

Europe

European Headquarters

Bacharach Instruments
Sovereign House, Queensway
Leamington Spa
Warwickshire CV31 3JR
United Kingdom
Phone: +44-1926-338111
Fax: +44-1926-338110
Email: sales@bacharach-europe.com

Sales / Service Center - Denmark

Bacharach Instruments Int'l
P.O. Box 44
39 Lindegade
DK 6070 Christiansfeld Denmark
Phone: +45-74-563171
Fax: +45-74-563178
Email: mail@bacharach.dk



205 Westwood Ave
Long Branch, NJ 07740
1-877-742-TEST (8378)
Fax: (732) 222-7088
salesteam@Tequipment.NET

Notes:

Notes:

