



205 Westwood Ave, Long Branch, NJ 07740

Phone: 866-94 BOARDS (26273) / (732)-222-1511

Fax: (732)-222-7088 | E-mail: sales@touchboards.com

BenQ

W1100/W1200

Digital Projector

User Manual

Welcome

Table of contents

Important safety

instructions3

Introduction.....7

Projector features 7

Shipping contents 8

Projector exterior view 9

Controls and functions 10

Positioning your projector 15

Choosing a location..... 15

Obtaining a preferred projected image size 16

Connection 19

Connecting Video source devices..... 21

Operation22

Starting up the projector 22

Adjusting the projected image 23

Using the menus 25

Securing the projector 26

Switching input signal 28

Magnifying and searching for details . 29

Selecting the aspect ratio 29

Optimizing the image..... 31

Hiding the image 35

Setting the Sleep Timer 35

Freezing the image..... 35

Operating in a high altitude environment 36

Adjusting the sound 36

Displaying more than one image source simultaneously..... 37

Personalizing the projector menu display39

Shutting down the projector39

Menu operation40

Maintenance.....49

Care of the projector49

Lamp information.....50

Troubleshooting56

Specifications57

Dimensions.....58

Ceiling mount installation.....58

Timing chart.....59

Warranty and Copyright information62

Regulation statements63

Important safety instructions

Your projector is designed and tested to meet the latest standards for safety of information technology equipment. However, to ensure safe use of this product, it is important that you follow the instructions mentioned in this manual and marked on the product.

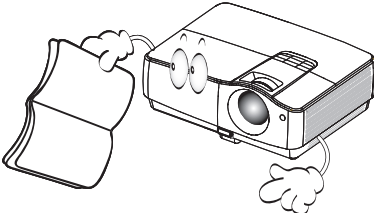
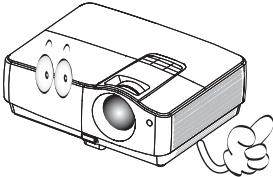
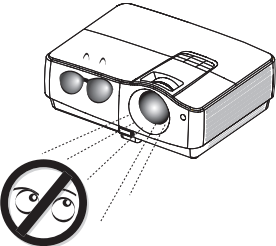
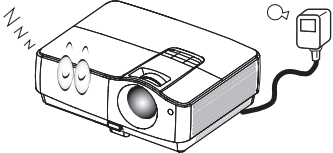
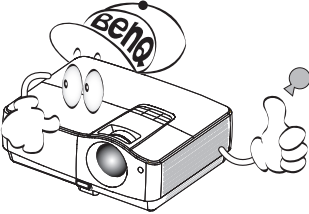
Safety Instructions	
<p>1. Please read this manual before you operate your projector. Save it for future reference.</p> 	<p>4. Always open the lens shutter or remove the lens cap when the projector lamp is on.</p> 
<p>2. Do not look straight at the projector lens during operation. The intense light beam may damage your eyes.</p> 	<p>5. In some countries, the line voltage is NOT stable. This projector is designed to operate safely within a mains voltage between 100 to 240 volts AC, but could fail if power cuts or surges of ± 10 volts occur. In areas where the mains voltage may fluctuate or cut out, it is recommended that you connect your projector through a power stabilizer, surge protector or uninterruptible power supply (UPS).</p> 
<p>3. Refer servicing to qualified service personnel.</p> 	<p>6. Do not block the projection lens with any objects when the projector is under operation as this could cause the objects to become heated and deformed or even cause a fire. To temporarily turn off the lamp, press BLANK on the projector or remote control.</p>

Safety Instructions (Continued)

7. The lamp becomes extremely hot during operation. Allow the projector to cool for approximately 45 minutes prior to removing the lamp assembly for replacement.

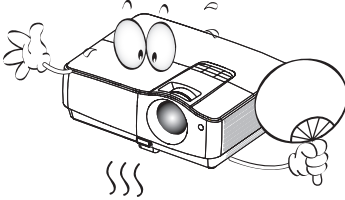

8. Do not operate lamps beyond the rated lamp life. Excessive operation of lamps beyond the rated life could cause them to break on rare occasions.

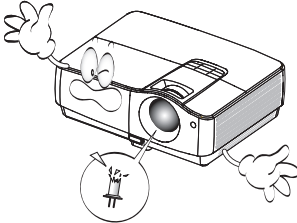

9. Never replace the lamp assembly or any electronic components unless the projector is unplugged.

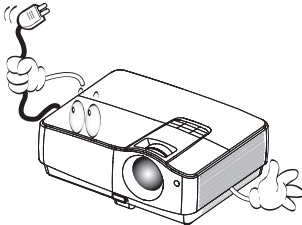

10. Do not place this product on an unstable cart, stand, or table. The product may fall, sustaining serious damage.

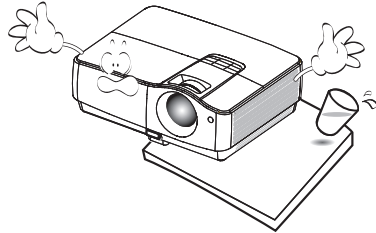

11. Do not attempt to disassemble this projector. There are dangerous high voltages inside which may cause death if you should come into contact with live parts. The only user serviceable part is the lamp which has its own removable cover. Under no circumstances should you ever undo or remove any other covers. Refer servicing only to suitably qualified professional service personnel.

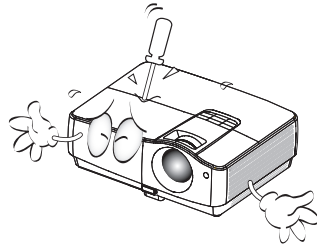

12. When the projector is under operation, you may sense some heated air and odor from its ventilation grill. It is a normal phenomenon and not a product defect.

Safety Instructions (Continued)

13. Do not place this projector in any of the following environments.
- Space that is poorly ventilated or confined. Allow at least 50 cm clearance from walls and free flow of air around the projector.
 - Locations where temperatures may become excessively high, such as the inside of a car with all windows rolled up.
 - Locations where excessive humidity, dust, or cigarette smoke may contaminate optical components, shortening the projector's life span and darkening the image.

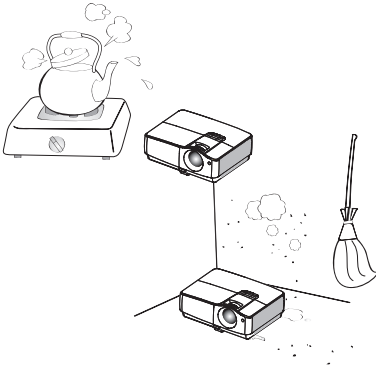

- Locations near fire alarms
- Locations with an ambient temperature above 35°C / 95°F
- Locations where the altitudes are higher than 3000 m (10000 feet).

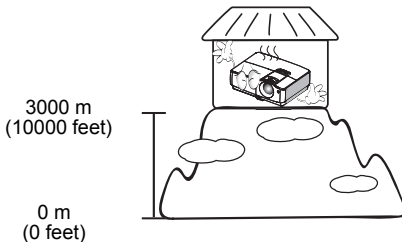

14. Do not block the ventilation holes.
- Do not place this projector on a blanket, bedding or any other soft surface.
 - Do not cover this projector with a cloth or any other item.
 - Do not place inflammables near the projector.

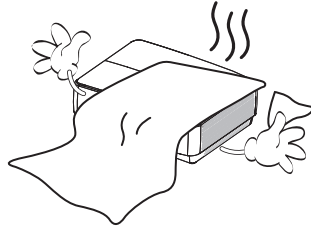

If the ventilation holes are seriously obstructed, overheating inside the projector may result in a fire.

15. Always place the projector on a level, horizontal surface during operation.
- Do not use if tilted at an angle of more than 10 degrees left to right, nor at angle of more than 15 degrees front to back. Using the projector when it is not fully horizontal may cause a malfunction of, or damage to, the lamp.

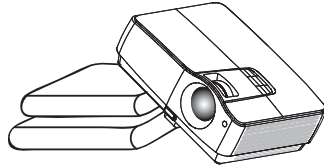

Safety Instructions (Continued)

16. Do not stand the projector on end vertically. Doing so may cause the projector to fall over, causing injury or resulting in damage to the projector.

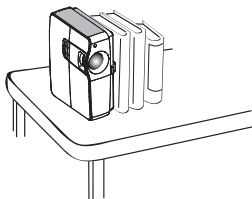

17. Do not step on the projector or place any objects upon it. Besides probable physical damage to the projector, doing so may result in accidents and possible injury.

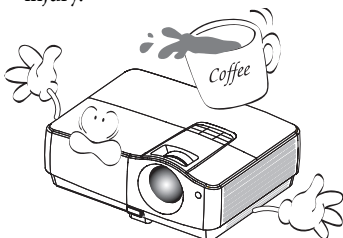

18. Do not place liquids near or on the projector. Liquids spilled into the projector may cause it to fail. If the projector does become wet, disconnect it from the power supply's wall socket and call BenQ to have the projector serviced.

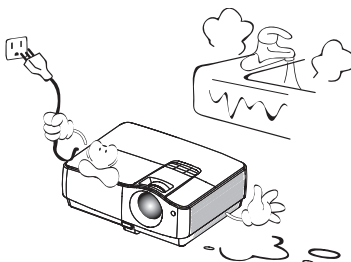

19. This product is capable of displaying inverted images for ceiling mount installation.



Use only BenQ's Ceiling Mount Kit for mounting the projector and ensure it is securely installed.

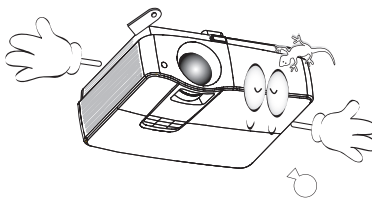

Introduction

Projector features

The projector integrates high-performance optical engine projection and a user-friendly design to deliver high reliability and ease of use.

The projector offers the following features.

- 10W x 2 Big speakers
- SRS WOW HD™ significantly improves the playback quality of audio, delivering a dynamic 3D entertainment experience with deep, rich bass and high frequency clarity for crisp detail.



- Dual HDMI inputs
- HDCP compatibility
- Quick auto search speeding up the signal detecting process
- Selectable password protected function
- 3D color management allowing color adjustments to your liking
- One-key auto-adjustment to display the best picture quality
- Digital keystone correction to correct distorted images
- Adjustable color balance control for data/video display
- High brightness projection lamp
- Multi-language On-Screen Display (OSD) menus
- Component HDTV compatibility (YPbPr)



- **The apparent brightness of the projected image will vary depending on the ambient lighting conditions, selected input signal contrast/brightness settings, and is directly proportional to projection distance.**
- **The lamp brightness will decline over time and may vary within the lamp manufacturers specifications. This is normal and expected behavior.**

Shipping contents

Carefully unpack and verify that you have all of the items shown below. If any of these items are missing, please contact your place of purchase.

Standard accessories

 The supplied accessories will be suitable for your region, and may differ from those illustrated.

*The warranty card is only supplied in some specific regions. Please consult your dealer for detailed information.

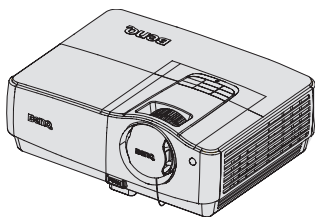

Projector

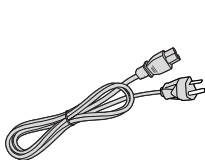

Power cord

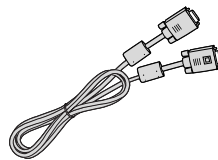

VGA cable



Quick start guide



User manual CD



Warranty card*

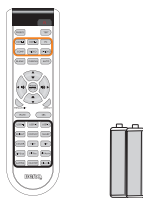

Remote control with batteries

Optional accessories

1. Spare lamp kit
2. Ceiling mount kit
3. Soft carry case
4. RS232 cable

Projector exterior view

Front/upper side

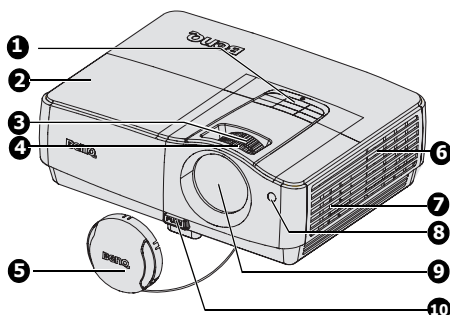

Rear/lower side

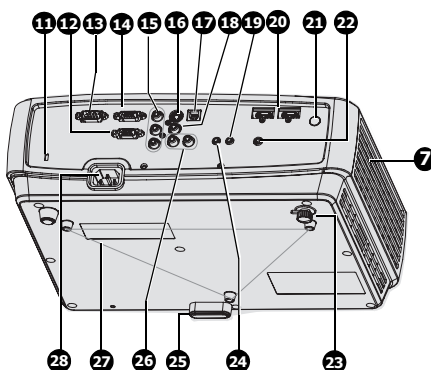

1. External control panel
(See "Projector" on page 10 for details.)
2. Lamp cover
3. Zoom ring
4. Focus ring
5. Lens cover
6. Vent
7. Speaker
8. Front IR remote sensor
9. Projection lens
10. Quick-release button
11. Kensington anti-theft lock slot
12. RGB (PC)/Component video (YPbPr/ YCbCr) signal input jack
13. RS-232 control port
14. RGB signal output jack
15. Component input jacks
16. S-Video input jack
17. USB input jack
18. Video input jack
19. Audio output jack
20. HDMI input jack
21. Rear IR remote sensor
22. 12V DC output terminal Used to trigger external devices such as anelectric screen or light control, etc. Consult your dealer for how to connect these devices.
23. Rear adjuster foot
24. Audio input jack
25. Quick release foot
26. Audio (L/R) input jack
27. Ceiling mount holes
28. AC power cord inlet

Controls and functions

Projector

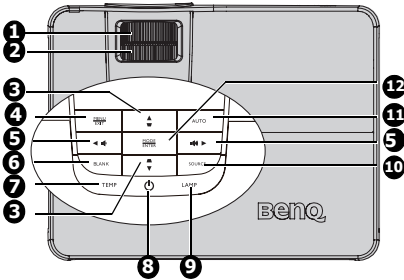

- 1. Focus ring**
Adjusts the focus of the projected image. See "[Fine-tuning the image size and clarity](#)" on page 24 for details.
- 2. Zoom ring**
Adjusts the size of the image. See "[Fine-tuning the image size and clarity](#)" on page 24 for details.
- 3. Keystone/Arrow keys (▽ / ▲ Up, ▴ / ▼ Down)**
Manually corrects distorted images resulting from an angled projection. See "[Correcting keystone](#)" on page 24 for details.
- 4. MENU/EXIT**
Turns on the On-Screen Display (OSD) menu. Goes back to previous OSD menu, exits and saves menu settings.
- 5. Volume/Arrow keys (🔊 / ◀ Left, 🔊 / ▶ Right)**
Adjusts the sound level.
When the On-Screen Display (OSD) menu is activated, the #3 and #5 keys are used as directional arrows to select the desired menu items and to make adjustments. See "[Using the menus](#)" on page 25 for details.
- 6. BLANK**
Used to hide the screen picture. See "[Hiding the image](#)" on page 35 for details.
- 7. TEMPerature indicator light**
Lights up red if the projector's temperature becomes too high. See "[Indicators](#)" on page 55 for details.
- 8. ⏻ Power/POWER indicator light**
Toggles the projector between standby mode and on. See "[Starting up the projector](#)" on page 22 and "[Shutting down the projector](#)" on page 39 for details.
Lights up or flashes when the projector is under operation. See "[Indicators](#)" on page 55 for detail.
- 9. LAMP indicator light**
Indicates the status of the lamp. Lights up or flashes when the lamp has developed a problem. See "[Indicators](#)" on page 55 for details.
- 10. Source**
Displays the source selection bar. See "[Switching input signal](#)" on page 28 for details.
- 11. AUTO**
Automatically determines the best picture timings for the displayed image. See "[Auto-adjusting the image](#)" on page 23 for details.
- 12. MODE/ENTER**
Selects an available picture setup mode. See "[Selecting a picture mode](#)" on page 31 for details.
Activates the selected On-Screen Display (OSD) menu item. See "[Using the menus](#)" on page 25 for details.

Ceiling mounting the projector

We want you to have a pleasant experience using your BenQ projector, so we need to bring this safety matter to your attention to prevent possible damage to person and property.

If you intend to mount your projector on the ceiling, we strongly recommend that you use a proper fitting BenQ projector ceiling mount kit and that you ensure it is securely and safely installed.

If you use a non-BenQ brand projector ceiling mount kit, there is a safety risk that the projector may fall from the ceiling due to an improper attachment through the use of the wrong gauge or length screws.

You can purchase a BenQ projector ceiling mount kit from the place you purchased your BenQ projector. BenQ recommends that you also purchase a separate Kensington lock compatible security cable and attach it securely to both the Kensington lock slot on the projector and the base of the ceiling mount bracket. This will perform the secondary role of restraining the projector should its attachment to the mounting bracket become loose.

Remote control

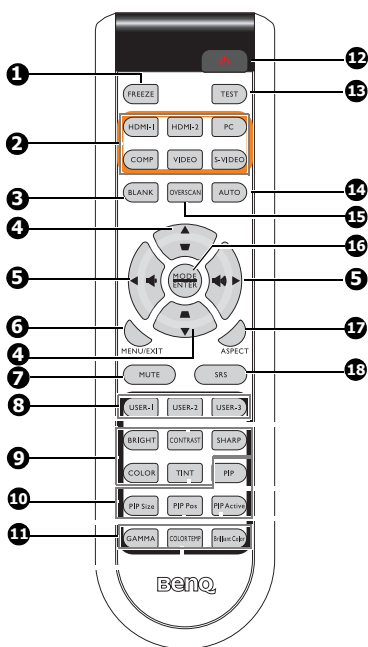

1. **FREEZE**
Freezes the projected image. See "[Freezing the image](#)" on page 35 for details.
2. **Source selection keys (HDMI-1, HDMI-2, PC, COMP, VIDEO, S-VIDEO)**
Selects an input source for display. See "[Switching input signal](#)" on page 28 for details.
3. **BLANK**
Used to hide the screen picture. See "[Hiding the image](#)" on page 35 for details.
4. **Keystone/Arrow keys (◀ / ▲ Up, ▼ / ▼ Down)**
Manually corrects distorted images resulting from an angled projection. See "[Correcting keystone](#)" on page 24 for details.

5. **Volume/Arrow keys (🔊 / ◀ Left, ▶ Right) / ▶ Right)**
Adjusts the sound level. See "[Adjusting the sound](#)" on page 36 for details.
When the On-Screen Display (OSD) menu is activated, the #4 and #5 keys are used as directional arrows to select the desired menu items and to make adjustments. See "[Using the menus](#)" on page 25 for details.
6. **MENU/EXIT**
Turns on the On-Screen Display (OSD) menu. Goes back to previous OSD menu, exits and saves menu settings.
See "[Using the menus](#)" on page 25 for details.
7. **MUTE**
Mutes the built-in speaker.
8. **USER-1/USER-2/USER-3**
Select the User memory settings. See "[Setting the User 1/User 2/User 3 mode](#)" on page 31 for details.
9. **Basic picture quality adjustment keys (BRIGHT, CONTRAST, SHARP, COLOR, TINT)**
Displays the setting bars for adjustment of the appropriate picture quality values. See "[Fine-tuning the image quality](#)" on page 32 for details.
10. **Picture window control keys (PIP, PIP Size, PIP Pos, PIP Active)**
Displays the Picture In Picture (PIP) windows, toggles between the main window and subwindow with PIP Active, and adjusts the size and position of the currently active window with PIP Size and PIP Pos. See "[Displaying more than one image source simultaneously](#)" on page 37 for details.

11. **Advanced picture quality adjustment keys (GAMMA, COLOR TEMP, Brilliant Color)**
Displays the setting bars for adjustment of the appropriate picture quality values. See ["Advanced picture quality controls" on page 32](#) for details.
12. **Power**
Toggles the projector between standby mode and on. See ["Starting up the projector" on page 22](#) and ["Shutting down the projector" on page 39](#) for details.
13. **TEST**
Displays the test pattern.
14. **AUTO**
Automatically determines the best picture timings for the displayed image. See ["Auto-adjusting the image" on page 23](#) for details.
15. **OVERSCAN**
Displays the OVERSCAN setting bar.
16. **MODE/ENTER**
Selects an available picture setup mode. See ["Selecting a picture mode" on page 31](#) for details.
Activates the selected On-Screen Display (OSD) menu item. See ["Using the menus" on page 25](#) for details.
17. **ASPECT**
Select the display aspect ratios. See ["Selecting the aspect ratio" on page 29](#) for details.
18. **SRS**
Turns on/off the SRS (Sound Retrieval System) surround sound effects.

Infra-Red (IR) remote control sensor is located on the front of the projector. The remote control must be held at an angle within 22.5 degrees perpendicular to the projector's IR remote control sensor to function correctly. The distance between the remote control and the sensor should not exceed 8 meters (~ 26 feet).

Make sure that there are no obstacles between the remote control and the IR sensor on the projector that might obstruct the infra-red beam.

- **Operating the projector from the front**
- **Operating the projector from the rear**

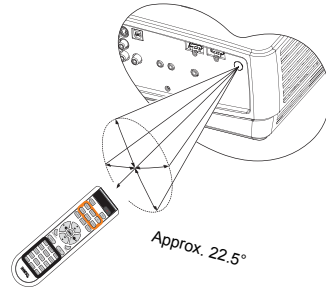
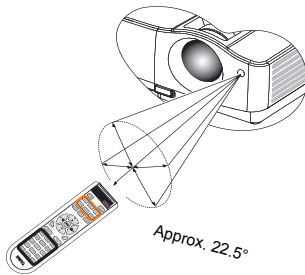

Replacing the remote control battery

1. To open the battery cover, turn the remote control over to view its back, push on the finger grip on the cover and slide it up in the direction of the arrow as illustrated. The cover will slide off.
2. Remove any existing batteries (if necessary) and install two AA batteries observing the battery polarities as indicated in the base of the battery compartment. Positive (+) goes to positive and negative (-) goes to negative.
3. Refit the cover by aligning it with the base and sliding it back down into position. Stop when it clicks into place.

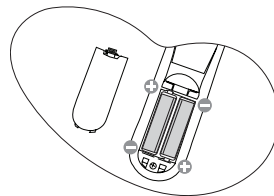
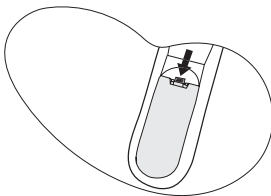

- **Avoid excessive heat and humidity.**
- **There may be battery damage if the battery is incorrectly replaced.**
- **Replace only with the same or equivalent type recommended by the battery manufacturer.**
- **Dispose of the used battery according to the battery manufacturer's instructions.**
- **Never throw a battery into a fire. There may be danger of an explosion.**
- **If the battery is dead or if you will not be using the remote control for a long time, remove the battery to prevent damage to the remote control from possible battery leakage.**

Positioning your projector

Choosing a location

Your room layout or personal preference will dictate which installation location you select. Take into consideration the size and position of your screen, the location of a suitable power outlet, as well as the location and distance between the projector and the rest of your equipment.

Your projector is designed to be installed in one of four possible installation locations:

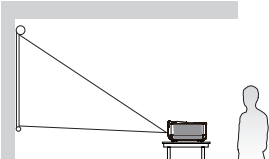
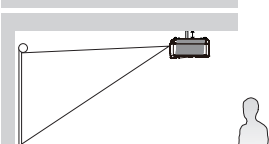
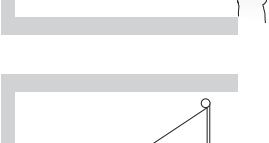
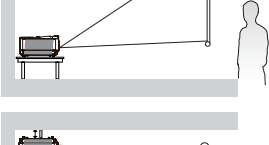
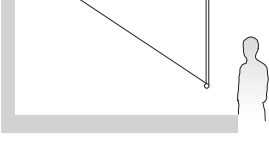
<p>1. Front Table Select this location with the projector placed near the floor in front of the screen. This is the most common way to position the projector for quick setup and portability.</p>	
<p>2. Front Ceiling Select this location with the projector suspended upside-down from the ceiling in front of the screen. Purchase the BenQ Projector Ceiling Mounting Kit from your dealer to mount your projector on the ceiling.</p>	
<p>Set Front Ceiling in the SYSTEM SETUP > Projector Position menu after you turn the projector on.</p> <p>3. Rear Table Select this location with the projector placed near the floor behind the screen.</p>	
<p>Note that a special rear projection screen is required.</p> <p>Set Rear Table in the SYSTEM SETUP > Projector Position menu after you turn the projector on.</p> <p>4. Rear Ceiling Select this location with the projector suspended upside-down from the ceiling behind the screen.</p>	
<p>Note that a special rear projection screen and the BenQ Projector Ceiling Mounting Kit are required for this installation location.</p> <p>Set Rear Ceiling in the SYSTEM SETUP > Projector Position menu after you turn the projector on.</p>	

 Your room layout or personal preference will dictate which installation location you select. Take into consideration the size and position of your screen, the location of a suitable power outlet, as well as the location and distance between the projector and the rest of your equipment.

Obtaining a preferred projected image size

The distance from the projector lens to the screen, the zoom setting (if available), and the video format each factors in the projected image size.

16:9 is the native aspect ratio of this projector.

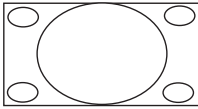

4:3 aspect image in a 16:9 aspect display area

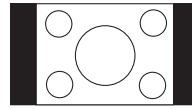

16:9 aspect image scaled to a 4:3 aspect display area

The projector should always be placed horizontally level (like flat on a table), and positioned directly perpendicular (90° right-angle square) to the horizontal center of the screen. This prevents image distortion caused by angled projections (or projecting onto angled surfaces).

If the projector is mounted on a ceiling, it must be mounted upside-down so that it projects at a slightly downward angle.

You can see from the diagram on page 18, that this type of projection causes the bottom edge of the projected image to be vertically offset from the horizontal plane of the projector. When ceiling mounted, this refers to the top edge of the projected image.

If the projector is positioned further away from the screen, the projected image size increases, and the vertical offset also increases proportionately.

When determining the position of the screen and projector, you will need to account for both the projected image size and the vertical offset dimension, which are directly proportional to the projection distance.

BenQ has provided a table of screen sizes to assist you in determining the ideal location for your projector. There are two dimensions to consider, the perpendicular horizontal distance from the center of the screen (projection distance), and the vertical offset height of the projector from the horizontal edge of the screen (offset).

How to determine the position of the projector for a given screen size

1. Select your screen size.
2. Refer to the table on page 18 and find the closest match to your screen size in the left columns labelled "Screen size". Using this value, look across this row to the right to find the corresponding average distance from screen value in the column labelled "Average". This is the projection distance.
3. On that same row, look across to the right column and make note of the "Vertical offset (mm)" value. This will determine the final vertical offset placement of the projector in relation to the edge of the screen.
4. The recommended position for the projector is aligned perpendicular to the horizontal center of the screen, at the distance from the screen determined in step 2 above, and offset by the value determined in step 3 above.

For example, if you are using a 120-inch screen, the average projection distance is 4710 mm and with a vertical offset of 513 mm.

How to determine the recommended screen size for a given distance

This method can be used for situations where you have purchased this projector and would like to know what screen size will fit in your room.

The maximum screen size is limited by the physical space available in your room.

1. Measure the distance between the projector and where you want to position the screen. This is the projection distance.
2. Refer to the table on page 18 and find the closest match to your measurement in the average distance from screen column labelled "Average". Check that your measured distance is between the min and max distances listed on either side of the average distance value.
3. Using this value, look across that row to the left to find the corresponding "Screen size" listed in that row. That is the projected image size of the projector at that projection distance.
4. On that same row, look across to the right column and make note of the "Vertical offset (mm)" value. This will determine the final placement of the screen in relation to the horizontal plane of the projector.

For example, if your measured projection distance was 4.0 m (4000 mm), the closest match in the "Average" column is 3920 mm. Looking across this row shows that a 100-inch screen is required.

If you place the projector in a different position (to that recommended), you will have to tilt it down or up to center the image on the screen. In these situations, some image distortion will occur. Use the Keystone function to correct the distortion. See "Correcting keystone" on page 24 for details.

Projection dimensions

Refer to "[Dimensions](#)" on page 58 for the center of lens dimensions of this projector before calculating the appropriate position.

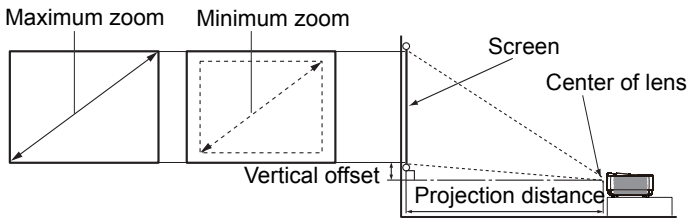

Screen size				Distance from screen (mm)			Vertical offset (mm)
Diagonal		W	H	Min length	Average	Max length	
Inch	mm	(mm)	(mm)	(max. zoom)		(min. zoom)	
30	762	664	374	890	1140	1390	128
40	1016	886	498	1210	1540	1870	171
50	1270	1107	623	1520	1935	2350	214
60	1524	1328	747	1830	2330	2830	256
80	2032	1771	996	2460	3125	3790	342
100	2540	2214	1245	3090	3920	4750	427
120	3048	2657	1494	3720	4710	5700	513
150	3810	3321	1868	4660	5900	7140	641
200	5080	4428	2491	6240	7890	9540	854
220	5588	4870	2740	6870	8685	10500	940
250	6350	5535	3113	7810	9875	11940	1068
300	7620	6641	3736	9380	11855	14330	1282

ⓘ There is 3% tolerance among these numbers due to optical component variations. BenQ recommends that if you intend to permanently install the projector, you should physically test the projection size and distance using the actual projector in situ before you permanently install it, so as to make allowance for this projector's optical characteristics. This will help you determine the exact mounting position so that it best suits your installation location.

Connection

When connecting a signal source to the projector, be sure to:

1. Turn all equipment off before making any connections.
2. Use the correct signal cables for each source.
3. Ensure the cables are firmly inserted.

 • In the connections shown below, some cables may not be included with the projector (see "Shipping contents" on page 8). They are commercially available from electronics stores.

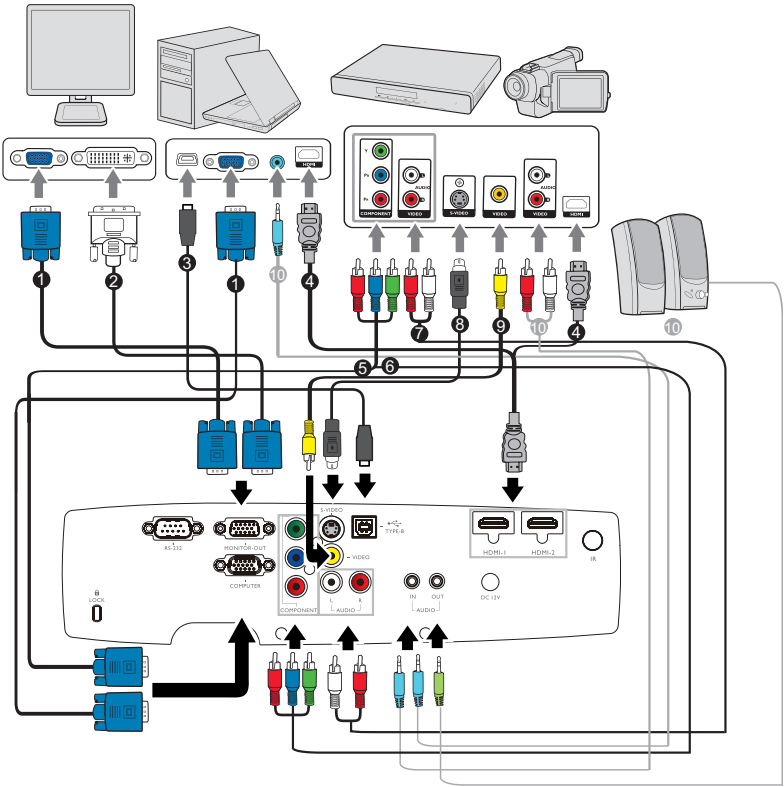

- | | |
|---|---|
| <ol style="list-style-type: none"> 1. VGA cable 2. VGA to DVI-A cable 3. USB Cable 4. HDMI cable 5. Component Video to VGA (D-Sub) adapter cable | <ol style="list-style-type: none"> 6. Component Video cable 7. Audio L/R cable 8. S-Video cable 9. Video cable 10. Audio cable |
|---|---|





 • Many notebooks do not turn on their external video ports when connected to a projector. Usually a key combo like FN + F3 or CRT/LCD key turns the external display on/off. Locate

a function key labeled CRT/LCD or a function key with a monitor symbol on the notebook. Press FN and the labeled function key simultaneously. Refer to your notebook's documentation to find your notebook's key combination.

- The output signal for MONITOR OUT jack only works when the input signal comes from COMPUTER jack. When the projector is powered on, the output signal from MONITOR OUT jack varies depending on the input signal from COMPUTER jack.
- If you wish to use "Monitor Out" connection method when the projector is in standby mode, make sure the Monitor Out function is turned on in the SYSTEM SETUP menu. See ["Standby Settings" on page 47](#) for details.

Connecting Video source devices

You need only connect the projector to a Video source device using just one of the above connecting methods, however each provides a different level of video quality. The method you choose will most likely depend upon the availability of matching terminals on both the projector and the Video source device as described below:

Terminal name	Terminal appearance	Picture quality
HDMI	HDMI 	Best
Component Video	COMPONENT 	Better
S-Video	S-VIDEO 	Good
Video	VIDEO 	Normal

- If the selected video image is not displayed after the projector is turned on and the correct video source has been selected, check that the Video source device is turned on and operating correctly. Also check that the signal cables have been connected correctly.
- In the unlikely event that you connect the projector to a DVD player via the projector's HDMI input and the projected picture displays wrong colors, please change the color space to YUV. See "[Changing Color Space](#)" on page 28 for details.
- To make sure you select a correct input source type for the HDMI signal, see "[HDMI Settings](#)" on page 45 for details.

Operation

Starting up the projector

1. Plug the power cord into the projector and into a power outlet. Turn on the power outlet switch (where fitted). Check that the **POWER indicator light** on the projector lights red after power has been applied.

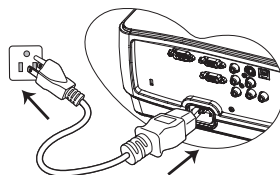

- Please use the original accessories (e.g. power cable) only with the device to avoid possible dangers such as electric shock and fire.
- If Direct power on function is activated in the **SYSTEM SETUP > Operation Settings** menu, the projector will turn on automatically after the power cord has been connected and power has been applied.

2. Remove the lens cap. If it is closed, it could become deformed due to the heat produced by the projection lamp.

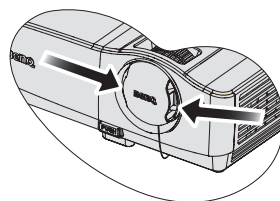

3. Press **Power** on the projector or remote control to start the projector. The **POWER indicator light** flashes and stays green when the projector is on.

The start up procedure takes about 30 seconds. In the later stage of start up, a startup logo is projected.

(If necessary) Rotate the focus ring to adjust the image clearness.

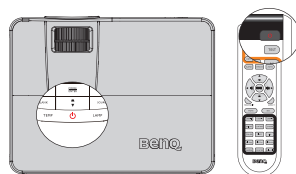

- If the projector is still hot from previous activity, it will run the cooling fan for approximately 90 seconds before energizing the lamp.

4. If the projector is activated for the first time, select your OSD language following the on-screen instructions.
5. If you are prompted for a password, press the arrow keys to enter a six digit password. See ["Utilizing the password function"](#) on page 26 for details.
6. Switch all of the connected equipment on.
7. The projector will start to search for input signals. The current input signal being scanned displays in the screen. If the projector doesn't detect a valid signal, the message **'No Signal'** will continue displaying until an input signal is found.

Language		
English	한국어	Hrvatski
Français	Svenska	Română
Deutsch	Nederlands	Norsk
Italiano	Türkçe	Dansk
Español	Čeština	Български
Русский	Português	suomi
中文 (繁)	ไทย	Indonesia
中文 (簡)	Polski	Ελληνικά
日本語	Magyar	
[Enter] Confirm [MENU] Exit		

You can also press **SOURCE** on the projector or **Source selection keys** on the remote control to select your desired input signal. See "[Switching input signal](#)" on page 28 for details.

 If the frequency/resolution of the input signal exceeds the projector's operating range, you will see the message 'Out of Range' displayed on a blank screen. Please change to an input signal which is compatible with the projector's resolution or set the input signal to a lower setting. See "[Timing chart](#)" on page 59 for details.

Adjusting the projected image

Adjusting the projection angle

The projector is equipped with 1 quick-release adjuster foot and 1 rear adjuster foot. These adjusters change the image height and projection angle. To adjust the projector:

1. Press the quick-release button and lift the front of the projector. Once the image is positioned where you want it, release the quick-release button to lock the foot in position.
2. Screw the rear adjuster foot to fine tune the horizontal angle.

To retract the foot, hold up the projector while pressing the quick-release button, then slowly lower the projector. Screw the rear adjuster foot in a reverse direction.

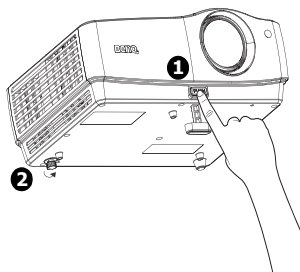

If the projector is not placed on a flat surface or the screen and the projector are not perpendicular to each other, the projected image becomes trapezoidal. To correct this situation, see "[Magnifying and searching for details](#)" on page 29 for details.

-  **Do not look into the lens while the lamp is on. The strong light from the lamp may cause damage to your eyes.**
- Be careful when you press the adjuster button as it is close to the exhaust vent where hot air comes from.**

Auto-adjusting the image

In some cases, you may need to optimize the picture quality. To do this, press **AUTO** on the projector or remote control. Within 3 seconds, the built-in Intelligent Auto Adjustment function will re-adjust the values of Frequency and Clock to provide the best picture quality.

-  **The screen will be blank while AUTO is functioning.**
- This function is only available when PC signal (analog RGB) is selected.**

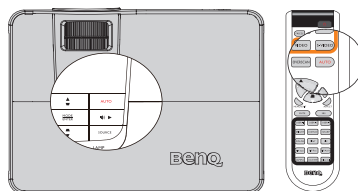

Fine-tuning the image size and clarity

1. Adjust the projected image to the size that you need using the zoom ring.

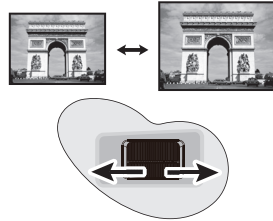

2. Then sharpen the image by rotating the focus ring.

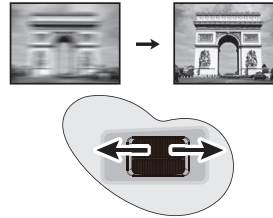

Correcting keystone

Keystoning refers to the situation where the projected image is noticeably wider at either the top or bottom. It occurs when the projector is not perpendicular to the screen.

To correct this, besides adjusting the height of the projector, you will need to manually correct it following one of these steps.

- Using the remote control

Make sure Auto Keystone function is off. Press **▼** / **▲** on the projector or remote control to display the Keystone correction page. Press **▲** to correct keystone at the top of the image. Press **▼** to correct keystone at the bottom of the image.

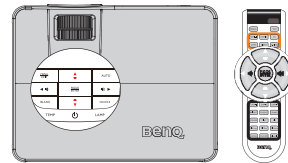

- Using the OSD menu

1. Press **MENU/EXIT** and then press **◀/▶** until the **DISPLAY** menu is highlighted.
2. Press **▼** to highlight **Keystone** and press **MODE/ENTER**.
3. Highlight **Auto Keystone** and press **◀/▶** to select **Off** to disable Auto Keystone function.
4. Press **▼** to highlight **Keystone** and adjust the value with **◀/▶**.
5. Press **▲** to correct keystone at the top of the image or press **▼** to correct keystone at the bottom of the image.

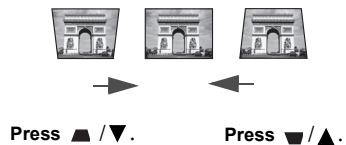

Using the menus

The projector is equipped with On-Screen Display (OSD) menus for making various adjustments and settings.

Below is the overview of the OSD menu.

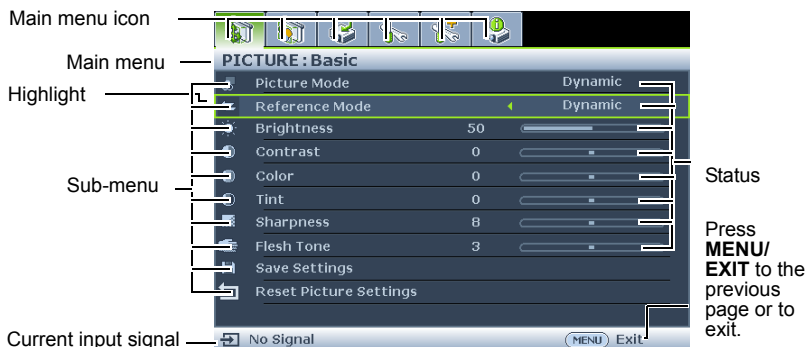

The following example describes how to set the OSD language.

1. Press **MENU/EXIT** on the projector or remote control to turn the OSD menu on.
3. Press **▼** to highlight **Language** and press **◀/▶** to select a preferred language.



2. Use **◀/▶** to highlight the **SYSTEM SETUP** menu.
4. Press **MENU/EXIT** twice* on the projector or remote control to leave and save the settings.



*The first press leads you back to the main menu and the second press closes the OSD menu.

Securing the projector

Using a security cable lock

The projector has to be installed in a safe place to prevent theft. Otherwise, purchase a lock, such as the Kensington lock, to secure the projector. You can locate a Kensington lock slot on the rear side of the projector. See item 11 on page 9 for details.

A Kensington security cable lock is usually a combination of key(s) and the lock. Refer to the lock's documentation for finding out how to use it.

Utilizing the password function

For security purposes and to help prevent unauthorized use, the projector includes an option for setting up password security. The password can be set through the On-Screen Display (OSD) menu.

 **WARNING:** You will be inconvenienced if you activate the power-on lock functionality and subsequently forget the password. Print out this manual (if necessary) and write the password you used in this manual, and keep the manual in a safe place for later recall.

Setting a password

 Once a password has been set, the projector cannot be used unless the correct password is entered every time the projector is started.

1. Open the OSD menu and go to the **SYSTEM SETUP > Security Settings** menu. Press **MODE/ENTER**.
2. Highlight **Change Security Settings** and press **MODE/ENTER**.
3. Highlight **Power on Lock** and select **On** by pressing **◀/▶**.
4. As pictured to the right, the four arrow keys (**▲**, **▶**, **▼**, **◀**) respectively represent 4 digits (1, 2, 3, 4). According to the password you desire to set, press the arrow keys to enter six digits for the password.
5. Confirm the new password by re-entering the new password.



Once the password is set, the OSD menu returns to the **Security Settings** page.

 **IMPORTANT:** The digits being input will display as asterisks on-screen. Write your selected password down here in this manual in advance or right after the password is entered so that it is available to you should you ever forget it.

Password: _____

Keep this manual in a safe place.

6. To leave the OSD menu, press **MENU/EXIT**.

If you forget the password

If the password function is activated, you will be asked to enter the six-digit password every time you turn on the projector. If you enter the wrong password, the password error message as pictured to the right displays lasting for three seconds, and the message 'INPUT PASSWORD' follows. You can retry by entering another

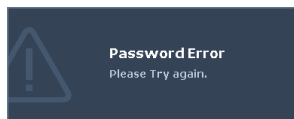

six-digit password, or if you did not record the password in this manual, and you absolutely do not remember it, you can use the password recall procedure. See "Entering the password recall procedure" on page 27 for details.

If you enter an incorrect password 5 times in succession, the projector will automatically shut down in a short time.

Entering the password recall procedure

1. Press and hold **AUTO** on the projector or remote control for 3 seconds. The projector will display a coded number on the screen.
2. Write down the number and turn off your projector.
3. Seek help from the local BenQ service center to decode the number. You may be required to provide proof of purchase documentation to verify that you are an authorized user of the projector.

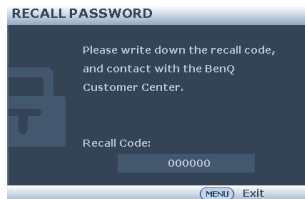

Changing the password

1. Open the OSD menu and go to the **SYSTEM SETUP > Security Settings > Change password** menu.
2. Press **MODE/ENTER**. The message 'INPUT CURRENT PASSWORD' displays.
3. Enter the old password.
 - If the password is correct, another message 'INPUT NEW PASSWORD' displays.
 - If the password is incorrect, the password error message displays lasting for three seconds, and the message 'INPUT CURRENT PASSWORD' displays for your retry. You can press **MENU/EXIT** to cancel the change or try another password.
4. Enter a new password.

 **IMPORTANT:** The digits being input will display as asterisks on-screen. Write your selected password down here in this manual in advance or right after the password is entered so that it is available to you should you ever forget it.

Password: _ _ _ _ _

Keep this manual in a safe place.

5. Confirm the new password by re-entering the new password.
6. You have successfully assigned a new password to the projector. Remember to enter the new password next time the projector is started.
7. To leave the OSD menu, press **MENU/EXIT**.

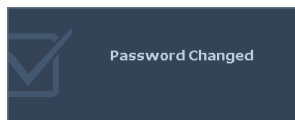

Disabling the password function

To disable password protection, go back to the **SYSTEM SETUP > Security Settings > Change Security Settings > Power on Lock** menu after opening the OSD menu system. Select **Off** by pressing **◀ / ▶**. The message 'INPUT PASSWORD' displays. Enter the current password.

- i. If the password is correct, the OSD menu returns to the **Security Settings** page with 'Off' shown in the row of **Power on Lock**. You will not have to enter the password next time you turn on the projector.
- ii. If the password is incorrect, the password error message displays lasting for three seconds, and the message 'INPUT PASSWORD' displays for your retry. You can press **MENU/EXIT** to cancel the change or try another password.

 **Though the password function is disabled, you need to keep the old password in hand should you ever need to re-activate the password function by entering the old password.**

Switching input signal

The projector can be connected to multiple devices at the same time. However, it can only display one full screen at a time. When starting up, the projector automatically searches for the available signals.

Be sure the **Quick Auto Search** function in the **SOURCE** menu is **On** (which is the default of this projector) if you want the projector to automatically search for the signals.

You can also manually cycle through the available input signals.

1. Press **SOURCE** on the projector. A source selection bar displays.
2. Press **▲/▼** until your desired signal is selected and press **MODE/ENTER**. You may press **Source selection keys** on remote control.

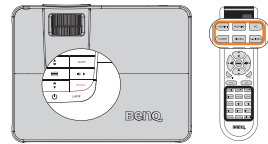

Once detected, the selected source information will display on the screen for seconds. If there is multiple equipment connected to the projector, repeat steps 1-2 to search for another signal.

-  • **The brightness level of the projected image will change accordingly when you switch between different input signals. Data (graphic) "PC" presentations using mostly static images are generally brighter than "Video" using mostly moving images (movies).**
- **The input signal type effects the options available for the Picture Mode. See ["Selecting a picture mode" on page 31](#) for details.**
- **The native display resolution of this projector is in a 16:9 aspect ratio. For best display picture results, you should select and use an input signal which outputs at this resolution. Any other resolutions will be scaled by the projector depending upon the 'aspect ratio' setting, which may cause some image distortion or loss of picture clarity. See ["Selecting the aspect ratio" on page 29](#) for details.**

Changing Color Space

In the unlikely event that you connect the projector to a DVD player via the projector's HDMI input and the projected picture displays wrong colors, please change the color space to YUV.

1. Press **MENU/EXIT** and then press **◀/▶** until the **DISPLAY** menu is highlighted.
2. Press **▼** to highlight **SOURCE** and press **MODE/ENTER**.
3. Press **▼** to highlight **Color Space Conversion** and press **◀/▶** to select a suitable color space.

 **This function is only available when the HDMI input port is in use.**

Magnifying and searching for details

If you need to find the details on the projected picture, magnify the picture. Use the direction arrow keys for navigating the picture.

- Using the OSD menu
 1. Press **MENU/EXIT** and then press ◀/▶ until the **DISPLAY** menu is highlighted.
 2. Press ▼ to highlight **Digital Zoom** and press **MODE/ENTER**. The Zoom bar displays.
 3. Press ▲ on the projector repeatedly to magnify the picture to a desired size.
 4. To navigate the picture, press **MODE/ENTER** to switch to the panning mode and press the directional arrows (▲, ▼, ◀, ▶) to navigate the picture.
 5. Use the directional arrows (▲, ▼, ◀, ▶) on the projector or remote control to navigate the picture.
 6. To reduce size of the picture, press **MODE/ENTER** to switch back to the zoom in/out functionality, and press **AUTO** to restore the picture to its original size. You can also press ▼ repeatedly until it is restored to the original size.

☞ **The picture can only be navigated after the picture is magnified. You can further magnify the picture while searching for details.**

Selecting the aspect ratio

The 'aspect ratio' is the ratio of the image width to the image height. Most analog TV and computers are in 4:3 ratio, which is the default for this projector, and digital TV and DVDs are usually in 16:9 ratio.

With the advent of digital signal processing, digital display devices like this projector can dynamically stretch and scale the image output to a different aspect than that of the image input signal.

To change the projected image ratio (no matter what aspect the source is):

1. Press **MENU/EXIT** and then press ◀/▶ until the **DISPLAY** menu is highlighted.
2. Press ▼ to highlight **Aspect Ratio**.
3. Press ◀/▶ to select an aspect ratio to suit the format of the video signal and your display requirements.

About the aspect ratio

☞ **In the pictures below, the black portions are inactive areas and the white portions are active areas. OSD menus can be displayed on those unused black areas.**

1. **Auto:** Scales an image proportionally to fit the projector's native resolution in its horizontal or vertical width. This is suitable for the incoming image which is neither in 4:3 nor 16:9 and you want to make most use of the screen without altering the image's aspect ratio.

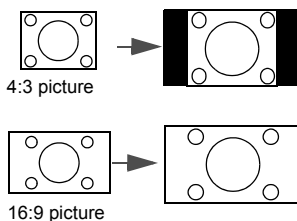

2. **Real:** The image is projected as its original resolution, and resized to fit within the display area. For input signals with lower resolutions, the projected image will display smaller than if resized to full screen. You could adjust the zoom setting or move the projector towards the screen to increase the image size if necessary. You may also need to refocus the projector after making these adjustments.

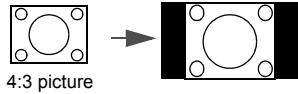

4:3 picture

3. **4:3:** Scales an image so that it is displayed in the center of the screen with a 4:3 aspect ratio. This is most suitable for 4:3 images like computer monitors, standard definition TV and 4:3 aspect DVD movies, as it displays them without aspect alteration.



4:3 picture

4. **16:9:** Scales an image so that it is displayed in the center of the screen with a 16:9 aspect ratio. This is most suitable for images which are already in a 16:9 aspect, like high definition TV, as it displays them without aspect alteration.

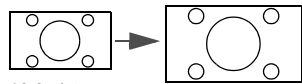

16:9 picture

5. **Letter Box:** Scales an image so that the original aspect ratio of the production is preserved. For input signals that do not conform to the projector's native resolution, the full unaltered image is displayed with a black border where no image exists..

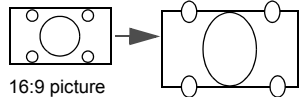

16:9 picture

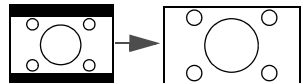

Letter Box
format picture

Optimizing the image

Selecting a picture mode

The projector is preset with several predefined picture modes so that you can choose one to suit your operating environment and input signal picture type.

To select an operation mode that suits your need, you can follow one of the following steps.

- Press **MODE/ENTER** on the remote control or projector repeatedly until your desired mode is selected.
- Go to the **PICTURE: Basic > Picture Mode** menu and press **◀/▶** to select a desired mode.

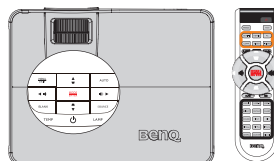

The picture modes are listed below.

1. **Dynamic mode:** Maximizes the brightness of the projected image. This mode is suitable for environments where extra-high brightness is required, such as using the projector in well lit rooms.
2. **Standard mode:** Is designed for presentations. The brightness is emphasized in this mode.
3. **Cinema mode:** Is appropriate for playing colorful movies, video clips from digital cameras or DVs through the PC input for best viewing in a blackened (little light) environment.
4. **User 1/User 2/User 3 mode:** Recalls the settings customized based on the current available picture modes. See "[Setting the User 1/User 2/User 3 mode](#)" on page 31 for details.

Setting the User 1/User 2/User 3 mode

There are two user-definable modes if the current available picture modes are not suitable for your need. You can use one of the picture modes (except the **User 1/User 2/User 3**) as a starting point and customize the settings.

1. Press **MENU/EXIT** to open the On-Screen Display (OSD) menu.
2. Go to the **PICTURE: Basic: Basic > Picture Mode** menu.
3. Press **◀/▶** to select **User 1/ User 2/User 3**.
4. Press **▼** to highlight **Reference Mode**.

 **This function is only available when User 1/User 2/User 3 mode is selected up in the Picture Mode sub-menu item.**

5. Press **◀/▶** to select a picture mode that is closest to your need.
6. Press **▼** to select a sub-menu item to be changed and adjust the value with **◀/▶**. See "[Fine-tuning the image quality](#)" below for details.
7. When all settings have been done, highlight **Save Settings** and press **MODE/ENTER** to store the settings.
8. The confirmation message '**Setting Saved**' displays.

The User 1/User 2/User 3 functions can also be accessible by pressing **USER-1/USER-2/USER-3** on the remote control.



Fine-tuning the image quality

No matter what picture mode you have selected, you are able to fine-tune those settings to fit every presentation purpose. Those adjustments will be saved to the preset mode you are at when you exit the OSD menu. Highlight **PICTURE: Basic** menu, press **▼** to select a sub-menu item to be changed and adjust the values by pressing **◀/▶** on the projector or remote control.

Adjusting Brightness

The higher the value, the brighter the image. And the lower the setting, the darker the image. Adjust this control so the black areas of the image appear just as black and that detail in the dark areas is visible.



Adjusting Contrast

The higher the value, the greater the contrast. Use this to set the peak white level after you have previously adjusted the **Brightness** setting to suit your selected input and viewing environment.



Adjusting Color

Lower setting produces less saturated colors. If the setting is too high, colors on the image will be overpowering, which makes the image unrealistic.

Adjusting Tint

The higher the value, the more reddish the picture becomes. The lower the value, the more greenish the picture becomes.

Adjusting Sharpness

The higher the value, the sharper the picture becomes. The lower the value, the softer the picture becomes.

Adjusting Flesh Tone

This function adjusts accurate color primaries resulting in natural looking flesh tones with excellent color saturation.

The Brightness, Contrast, Sharpness, Color, Tint functions can also be accessible by pressing **BRIGHT**, **CONTRAST**, **SHARP**, **COLOR**, **TINT** on the remote control.



Advanced picture quality controls

There are more advanced functions in the **PICTURE: Advanced** menu to be adjusted to your preference. To save the settings, just press **MENU/EXIT** to leave the OSD menu.

Adjusting Clarity Control

Highlight **Clarity Control** in the **PICTURE: Advanced** menu and press **MODE/ENTER** to enter **Clarity Control** page.

To adjust the settings:

1. **Noise Reduction:** Reduces electrical image noise caused by different media players. The higher the setting, the less the noise.
Highlight **Noise Reduction** and press **◀/▶** to adjust the value from 0 to 15.
2. **Detail Enhancement:** Sharpens the image. The higher the setting, the more details the image reveals.

Highlight **Detail Enhancement** and press ◀/▶ to adjust the value from 0 to 10 to enhance the image.

Selecting a Color Temperature

Highlight **Color Temperature** in the **PICTURE: Advanced** menu and adjust the values by pressing ◀/▶ on the projector or remote control.

Choose a preferred color temperature from among Warmer/Warm/Normal/Cool/Cooler.

*About color temperatures:

There are many different shades that are considered to be "white" for various purposes. One of the common methods of representing white color is known as the "color temperature". A white color with a low color temperature appears to be reddish white. A white color with a high color temperature appears to have more blue in it.

Fine-Tuning a Color Temperature

Highlight **Color Temperature Fine-Tuning** in the **PICTURE: Advanced** menu and press **MODE/ENTER**.

To adjust the settings:

1. **Color Temperature Control:** Adjusts R/G/B color.
Highlight **Color Temperature Control** and choose a preferred color temperature control range: R-Color: 5~195/ G-Color: 5~195/ B-Color: 5~195.
2. **White Balance:** Adjusts R/G/B-Gain and R/G/B-Bias.
Highlight **White Balance** and choose a preferred white balance range: R-Gain: -50~50/
G-Gain : -50~50/ B-Gain: -50~50/ R-Bias: -50~50/ G-Bias: -50~50/ B-Bias: -50~50.

Selecting a Gamma Selection

Highlight **Gamma Selection** in the **PICTURE: Advanced** menu and select the modes by pressing ◀/▶ on the projector or remote control.

Choose a preferred gamma mode from among Default/1.6/1.8/2.0/2.2/2.4/2.6/2.8.

Gamma Correction enables adjustment to the light intensity (brightness) of an image in order to match the source more closely.

Adjusting Brilliant Color

Highlight **Brilliant Color** in the **PICTURE: Advanced** menu and select the modes by pressing ◀/▶ on the projector or remote control.

This feature utilizes a new color-processing algorithm and system level enhancements to enable higher brightness while providing truer, more vibrant colors in picture. It enables a greater than 50% brightness increase in mid-tone images, which are common in video and natural scenes, so the projector reproduces images in realistic and true colors. If you prefer images with that quality, select **On**. If you don't need it, select **Off**.

On is the default and recommended selection for this projector. When **Off** is selected, the **Color Temperature** function is not available.

The Color Temperature, Gamma, Brilliant Color functions can also be accessible by pressing COLOR TEMP, GAMMA, Brilliant Color on the remote control.



Selecting a White Peaking

Highlight **White Peaking** in the **PICTURE: Advanced** menu and adjust the values by pressing ◀/▶ on the projector or remote control.

This adjustable item utilizes a new color-processing algorithm and system level enhancements to enable higher brightness while providing true, more vibrant colors in picture. The range is from 1 to 3. If you prefer a stronger enhanced image, adjust toward the maximum setting. For a smoother, more natural image, adjust toward the minimum setting.

3D Color Management

In most installation situations, color management will not be necessary, such as in classroom, meeting room, or lounge room situations where lights remain on, or where building external windows allow daylight into the room.

Only in permanent installations with controlled lighting levels such as boardrooms, lecture theaters, or home theaters, should color management be considered. Color management provides fine color control adjustment to allow for more accurate color reproduction, should you require it.

Proper color management can only be achieved under controlled and reproducible viewing conditions. You will need to use a colorimeter (color light meter), and provide a set of suitable source images to measure color reproduction. These tools are not provided with the projector, however, your projector supplier should be able to provide you with suitable guidance, or even an experienced professional installer.

The Color Management provides six sets (RGBCMY) of colors to be adjusted. When you select each color, you can independently adjust its range and saturation according to your preference.

If you have purchased a test disc which contains various color test patterns and can be used to test the color presentation on monitors, TVs, projectors, etc. You can project any image from the disc on the screen and enter the **3D Color Management** menu to make adjustments.

To adjust the settings:

1. Go to the **PICTURE: Advanced** menu and highlight **3D Color Management**.
2. Press **MODE/ENTER** and the **3D Color Management** page displays.
3. Highlight **Primary Color** and press **◀/▶** to select a color from among Red, Yellow, Green, Cyan, Blue, or Magenta.
4. Press **▼** to highlight **Hue** and press **◀/▶** to select its range. Increase in the range will include colors consisted of more proportions of its two adjacent colors.

Please refer to the illustration to the right for how the colors relate to each other.

For example, if you select Red and set its range at 0, only pure red in the projected picture will be selected. Increasing its range will include red close to yellow and red close to magenta.

5. Press **▼** to highlight **Saturation** and adjust its values to your preference by pressing **◀/▶**. Every adjustment made will reflect to the image immediately.

For example, if you select Red and set its value at 0, only the saturation of pure red will be affected.

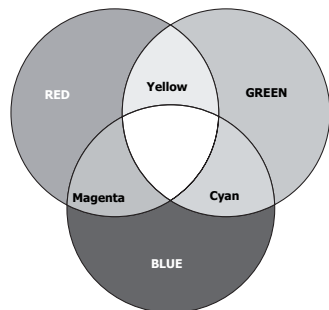

 **Saturation is the amount of that color in a video picture. Lower settings produce less saturated colors; a setting of “0” removes that color from the image entirely. If the saturation is too high, that color will be overpowering and unrealistic.**

6. Press ▼ to highlight **Gain** and adjust its values to your preference by pressing ◀/▶. The contrast level of the primary color you select will be affected. Every adjustment made will reflect to the image immediately.
7. Repeat steps 3 to 6 for other color adjustments.
8. Make sure you have made all of the desired adjustments.
9. Press **MENU/EXIT** to exit and save the settings.

Selecting a Film Mode

Highlight **Film Mode** in the **PICTURE: Advanced** menu and select by pressing ◀/▶ on the projector or remote control.

On is the default and recommended selection for this projector. When **Off** is selected, the **Film Mode** function is not available.

This function is only available when Video or S-Video with NTSC system is selected.

Selecting a 3D Comb Filter

Highlight **3D Comb Filter** in the **PICTURE: Advanced** menu and select by pressing ◀/▶ on the projector or remote control.

3D Comb Filter separates the Y and C signals while simultaneously processing three consecutive horizontal scan lines. While comparing three consecutive horizontal scan lines within a single video frame, it also analyzes each frame in advance, ensuring the best possible picture.

On is the default and recommended selection for this projector. When **Off** is selected, the **3D Comb Filter** function is not available.

 This function is only available when Video or S-Video with NTSC system is selected.

Hiding the image

In order to draw the audience's full attention to the presenter, you can use **BLANK** on the projector or remote control to hide the screen image. Press any key on the projector or remote control to restore the image. The word '**BLANK**' appears at the screen while the image is hidden. When this function is activated with an audio input connected, the audio can still be heard.

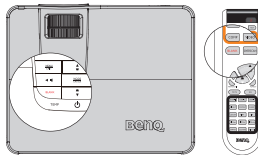

You can set the blank time in the **SYSTEM SETUP > Operation Settings > Blank Timer** menu to let the projector return the image automatically after a period of time when there is no action taken on the blank screen. The length of time can be set from 5 to 30 minutes in 5-minute increments.

 Do not block the projection lens from projecting as this could cause the blocking object to become heated.

Setting the Sleep Timer

You can set the Sleep Timer interval so the projector powers off after the specified time period of inactivity (regardless of signal).

Set the sleep timer in the **SYSTEM SETUP > Operation Settings > Sleep Timer** from among Disable/30 min/1 hr/2 hr/3 hr/4 hr/8 hr/12hr.

Freezing the image

Press **FREEZE** on the remote control to freeze the image. The word **'FREEZE'** will display in the screen. To release the function, press any key on the projector or remote control.

Even if an image is frozen on the screen, the pictures are running on the video or other device. If the connected devices have active audio output, you will still hear the audio even though the image is frozen on screen.



Operating in a high altitude environment

We recommend you use the **High Altitude Mode** when your environment is between 1500 m –3000 m above sea level, and ambient temperature is between 0°C–35°C.

 **Do not use the High Altitude Mode if your altitude is between 0 m and 1500 m and ambient temperature is between 0°C and 35°C. The projector will be over cooled, if you turn the mode on under such a condition.**

To activate the **High Altitude Mode**:

1. Press **MENU/EXIT** and then press ◀ / ▶ until the **SYSTEM SETUP** menu is highlighted.
2. Press ▼ to highlight **High Altitude Mode** and press ◀ / ▶ to select **On**. A confirmation message displays.
3. Highlight **Yes** and press **MODE/ENTER**.

Operation under "**High Altitude Mode**" may cause a higher decibel operating noise level because of increased fan speed necessary to improve overall system cooling and performance.

If you use this projector under other extreme conditions excluding the above, it may display auto shut-down symptoms, which is designed to protect your projector from over-heating. In cases like this, you should switch to High Altitude mode to solve these symptoms. However, this is not to state that this projector can operate under any and all harsh or extreme conditions.

Adjusting the sound

The sound adjustments made as below will have an effect on the projector speaker(s). Be sure you have made a correct connection to the projector audio input. See "["Connection"](#)" on [page 19](#) for how the audio input is connected.

Turning on/off the SRS

- Using the remote control
Press **SRS** to turn on the SRS surround sound effects.

To cancel SRS surround sound effects, press **SRS** again.

- Using the OSD menu
 1. Press **MENU/EXIT** and then press ◀ / ▶ until the **AUDIO SETUP** menu is highlighted.
 2. Press ▼ to highlight **SRS** and press ◀ / ▶ to select **On/Off**.



Muting the sound

To temporarily turn off the sound,

- Using the remote control
Press **MUTE** to temporarily turn off the sound.

To restore the sound, press **MUTE** again.

- Using the OSD menu
 - Press **MENU/EXIT** and then press ◀ / ▶ until the **AUDIO SETUP** menu is highlighted.
 - Press ▼ to highlight **MUTE** and press ◀ / ▶ to select **On**.
 - To restore the sound, repeat steps 1-2 and press ◀ / ▶ to select **Off**.



Adjusting the sound level

To adjust the sound level,

- Using the remote control
Press 🔊 or 🔊 to select a desired sound level.
- Using the OSD menu
 - Press **MENU/EXIT** and then press ◀ / ▶ until the **AUDIO SETUP** menu is highlighted.
 - Press ▼ to highlight **Volume** and press ◀ / ▶ to select a desired sound level.

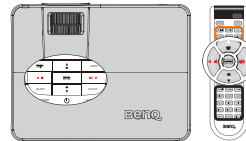

Adjusting the Treble level

To adjust the treble level,

- Press **MENU/EXIT** and then press ◀ / ▶ until the **AUDIO SETUP** menu is highlighted.
- Press ▼ to highlight **Treble** and press ◀ / ▶ to select a desired treble level.

☞ If adjusting the treble level when Mute is on, the Mute function turns off automatically.

Adjusting the Bass level

To adjust the bass level,

- Press **MENU/EXIT** and then press ◀ / ▶ until the **AUDIO SETUP** menu is highlighted.
- Press ▼ to highlight **Bass** and press ◀ / ▶ to select a desired bass level.

☞ If adjusting the bass level when Mute is on, the Mute function turns off automatically.

Turning on the Power on/off Ring Tone

- Repeat steps 1 above.
- Press ▼ to highlight **Power on/off Ring Tone** and press ◀ / ▶ to select **On**.

☞ The only way to change Power on/off ring tone is setting On or Off here. Setting the sound mute or changing the sound level will not affect the Power on/off ring tone.

Displaying more than one image source simultaneously

Your projector is capable of displaying pictures simultaneously from two input sources, which can be used to enhance your presentation in an interesting way. Ensure the signals you want to display are correctly connected to the projector.

To display the PIP window:

- Using the remote control

Press PIP to display the PIP page and make adjustments by following the steps starting from step 3 in the section "Using the OSD menu" below.



When the PIP window is on, to change the PIP window size, press PIP Size repeatedly until a desired size is selected.

When the PIP window is on, to change the PIP window position, press PIP Pos repeatedly until a desired position is selected.

When the PIP window is on, to highlight one of the sources to make adjustments, press PIP Active repeatedly until the source is selected.

- Using the OSD menu

1. Press **MENU/EXIT** and then press **◀/▶** until the **DISPLAY** menu is highlighted.
2. Press **▼** to highlight **PIP** and press **MODE/ENTER**. The PIP page displays.
3. Highlight **PIP** and press **◀/▶** to select **On**.



The projector will select two currently active signals to display and the last viewed picture will be displayed on the big screen as a main source.

The PIP function is effective at below source combinations.

	Source 2	
Source 1	HDMI 1	HDMI 2
Component	V	V
PC	V	V
Video	V	V
S-Video	V	V

4. To change the **Main Source** or **Second Source**, press **▼** to highlight **Main Source** or **Second Source**, use **◀/▶** to highlight the source you want to display for the main (bigger) or second (smaller) window.
5. To make OSD settings to one of the two sources (main or second), highlight **Active Window** and press **◀/▶** to select the source you want to make adjustments.

 **The settings made on the OSD menu will only take effect on the active window. The following OSD menu function cannot work on the active windows for the PIP: Quick Auto Search.**

6. To change the position of the smaller picture, highlight **Position** and press **◀/▶** repeatedly until a suitable position is selected.
7. To resize the small picture, highlight **Size** and press **◀/▶** to set the PIP size among **Small** or **Large**
8. To leave the OSD menu, press **MENU/EXIT** repeatedly until the menu disappears.

Personalizing the projector menu display

The On-Screen Display (OSD) menus can be set according to your preferences. The following settings do not affect the projection settings, operation, or performance.

- **Menu display time** in the **SYSTEM SETUP > Menu Settings** menu sets the length of time the OSD will remain active after your last key press. The time length ranges from 5 to 30 seconds in 5-second increments. Use ◀/▶ to select a suitable time frame.
- **Menu position** in the **SYSTEM SETUP > Menu Settings** menu sets the OSD position in five locations. Use ◀/▶ to select a preferred position.
- **Language** in the **SYSTEM SETUP** menu sets your familiar language for the OSD menus. Use ◀/▶ to select your language.

Shutting down the projector

1. Press **Power** and a confirmation message displays prompting you. If you don't respond in a few seconds, the message will disappear.

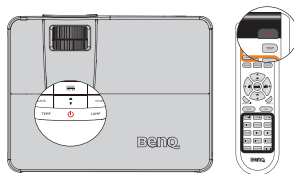

2. Press **Power** a second time. The **POWER indicator light** flashes red, the projection lamp shuts down, and the fans will continue to run for approximately 90 seconds to cool down the projector.

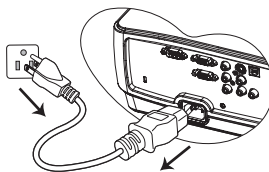

- **To protect the lamp, the projector will not respond to any commands during the cooling process.**

3. Once the cooling process finishes, the **POWER indicator light** is a steady red and fans stop.
4. Disconnect the power cord from the power outlet if the projector will not be used in an extended period of time.



- **If the projector is not properly shut down, to protect the lamp, when you attempt to re-start the projector, the fans will run for a few minutes to cool down. Press Power again to start the projector after the fans stop and the POWER indicator light turns red.**

- **Actual lamp life may vary due to different environmental conditions and usage.**

Menu operation

Menu system

Please note that the on-screen display (OSD) menus vary according to the signal type selected.

Main menu	Sub-menu	Options
1. PICTURE: Basic	Picture Mode	Dynamic/Standard/Cinema/ISF Day(for W1200 only)/ISF Night(for W1200 only)/User 1/User 2/User 3
	Reference Mode	Dynamic/Standard/Cinema
	Brightness	
	Contrast	
	Color	
	Tint	
	Sharpness	
	Flesh Tone	
	Save Settings	
	Reset Picture Settings	
	2. PICTURE: Advanced	Clarity Control
Color Temperature		Warmer/Warm/Normal/Cool/Cooler
Color Temperature Fine-Tuning		Color Temperature Control R-Color/G-Color/B-Color
White Balance		White Balance R-Gain/G-Gain/B-Gain/R-Bias/G-Bias/B-Bias
Gamma Selection		Default/1.6/1.8/2.0/2.2/2.4/2.6/2.8
Brilliant Color		On/Off
White Peaking		
3D Color Management		Primary Color Hue Saturation Gain
Film Mode		On/Off
3D Comb Filter		On/Off
ISF (for W1200 only)		



3. DISPLAY	Aspect Ratio	Auto/16:9/4:3/Letter Box/Real	
	Keystone	Auto Keystone	On/Off
		Keystone	
	Overscan Adjustment	Overscan	
	Digital Zoom		
	PC & Component YPbPr Tuning	Auto/H. Size/Phase/Horizontal Position/Vertical Position/SOG Level	
	SOURCE	Quick Auto Search	On/Off
		Color Space Conversion	Auto/RGB/YUV
	HDMI Settings	HDMI Format	Auto/PC Signal/Video Signal
		HDMI Amplifier Gain	
	Closed Caption	Closed Caption Enable	Off/On
		Caption Version	CC1/CC2/CC3/CC4
	Test Pattern		Off/On
	PIP	PIP	On/Off
		Main Source	HDMI 1/HDMI 2/Video/S-Video/Component/PC
		Second Source	
		Active Window	Main/PIP
		Position	Top-Right/Bottom-Left/Bottom-Right/Top-Left
		Size	Large/Small
	Frame Interpolation (for W1200 only)		
	4. AUDIO SETUP	SRS	On/Off
Mute		Off/On	
Volume			
Treble			
Bass			
Power on/off Ring Tone		On/Off	

5. SYSTEM SETUP	Language	English/ Français/ Deutsch/ Italiano/ Español/ Русский / 繁體中文/ 简体中文/ 日本語/ 한국어/ Svenska/ Nederlands/ Türkçe/ Čeština/ Português/ ^{தமிழ்} Polski Magyar/ Hrvatski/ Română/ Norsk/ Dansk/ Български / Suomi / Ελληνικά Bahasa Indonesia	
	Projector Position	Front Table/Rear Table/Rear Ceiling/Front Ceiling	
	Menu Settings	Menu display time	5 sec/10 sec/15 sec/20 sec/25 sec/30 sec
		Menu position	Top-Left/Top-Right/Center/ Bottom-Left/Bottom-Right
	Operation Settings	Direct power on	On/Off
		Auto Power Off	Disable/5 min/10 min/15 min/20 min/25 min/30 min
		Blank Timer	Disable/5 min/10 min/15 min/20 min/25 min/30 min
		Sleep Timer	Disable/30 min/1 hr/2 hr/3 hr/4 hr/8 hr/12 hr
		Background Color	Black/Blue/Purple
		Splash Screen	BenQ/Black/Blue
		Standby Settings	Monitor Out
	High Altitude Mode	On/Off	Yes/No
	Lamp Settings	Lamp Mode	Normal/Economic
		Reset lamp timer Equivalent Lamp Hour	
	Security Settings	Change password	
		Change Security Settings	Power on Lock
	Baud Rate		2400/4800/9600/14400/19200/ 38400/57600/115200
	LED Indicator		On/Off
	Reset All Settings		
	6. INFORMATI ON	Current System Status	<ul style="list-style-type: none"> • Source • Picture Mode • Resolution • Color System • Equivalent Lamp Hour • Firmware Version



Note that the menu items are available when the projector detects at least one valid signal. If there is no equipment connected to the projector or no signal detected, limited menu items are accessible.

Description of each menu

-  • The default values listed in this manual, especially on pages 43-48, are for reference only. They may vary between the projectors due to the continuous improvement to the products.

FUNCTION	DESCRIPTION
Picture Mode	Pre-defined picture modes are provided so you can optimize your projector image set-up to suit your program type. See " Selecting a picture mode " on page 31 for details.
Reference Mode	Selects a picture mode that best suits your need for the image quality and further fine-tune the image based on the selections listed on the same page below. See " Setting the User 1/User 2/User 3 mode " on page 31 for details.
Brightness	Adjusts the brightness of the image. See " Adjusting Brightness " on page 32 for details.
Contrast	Adjusts the degree of difference between dark and light in the image. See " Adjusting Contrast " on page 32 for details.
Color	Adjusts the color saturation level -- the amount of each color in a video image. See " Adjusting Color " on page 32 for details.  This function is only available when Video or S-Video with NTSC system is selected.
Tint	Adjusts the red and green color tones of the image. See " Adjusting Tint " on page 32 for details.  This function is only available when Video or S-Video with NTSC system is selected.
Sharpness	Adjusts the image to make it look sharper or softer. See " Adjusting Sharpness " on page 32 for details.  This function is only available when Video or S-Video with NTSC system is selected.
Flesh Tone	See " Adjusting Flesh Tone " on page 32 for details.
Save Setting	Saves the settings made for User 1 or User 2 or User 3 mode.
Reset Picture Settings	Resets the picture settings for User 1 or User 2 or User 3 mode.

1. PICTURE: Basic menu

FUNCTION	DESCRIPTION
Clarity Control	See "Adjusting Clarity Control" on page 32 for details.
Color Temperature	See "Selecting a Color Temperature" on page 33 for details.
Color Temperature Fine-Tuning	See "Fine-Tuning a Color Temperature" on page 33 for details.
Gamma Selection	Selects gamma mode that most suits your need for the image quality. See "Selecting a Gamma Selection" on page 33 for details.
Brilliant Color	Adjusts the Brilliant Color value to extend the exposure range and sharpens detail for grain free images. See "Adjusting Brilliant Color" on page 33 for details.
White Peaking	Adjusts white peaking while maintaining correct color presentation. See "Selecting a White Peaking" on page 33 for details.
3D Color Management	See "3D Color Management" on page 34 for details.
Film Mode	See "Selecting a Film Mode" on page 35 for details.  This function is only available when Video or S-Video with NTSC system is selected.
3D Comb Filter	See "Selecting a 3D Comb Filter" on page 35 for details.  This function is only available when Video or S-Video with NTSC system is selected.
ISF (for W1200 only)	The ISF calibration menu is password protected and only accessible by authorized ISF calibrators. The ISF (Imaging Science Foundation) has developed carefully crafted, industry-recognized standards for optimal video performance and has implemented a training program for technicians and installers to use these standards to obtain optimal picture quality from BenQ video display devices. Accordingly, we recommend that setup and calibration be performed by an ISF certified installation technician.  For more information, please go to www.imagingscience.com or contact the place you purchased the projector.

FUNCTION	DESCRIPTION
Aspect Ratio	There are five options to set the image's aspect ratio depending on your input signal source. See "Selecting the aspect ratio" on page 29 for details.
Keystone	Corrects any keystone of the image automatically or manually. See "Correcting keystone" on page 24 for details.
Overscan Adjustment	Removes the noise in a video image. Overscans the image to remove video encoding noise on the edge of video source.
Digital Zoom	Magnifies or reduces the projected image. See "Magnifying and searching for details" on page 29 for details.
PC & Component YPbPr Tuning	Corrects the display data frequency, phase, the position of the image and selects the preferred SOG level automatically or manually.
SOURCE	Selects the default source for projection. See "Switching input signal" on page 28 for details.
HDMI Settings	HDMI Format Selects appropriate HDMI format automatically or manually. HDMI Amplifier Gain Adjusts the appropriate HDMI amplifier gain automatically or manually.
Closed Caption	Selects the screen to display closed captioning text if available.
Test Pattern	Selecting On enables the function and the projector displays the grid test pattern. It helps you adjust the image size and focus and check that the projected image is free from distortion.
PIP	Turns the PIP window on or off and makes related adjustments. See "Displaying more than one image source simultaneously" on page 37 for details.
Frame Interpolation (for W1200 only)	This function enables the display to enhance the smoothness and clarity of pictures through motion estimation/motion compensation technology.

FUNCTION	DESCRIPTION
4. AUDIO SETUP menu	SRS See "Turning on/off the SRS" on page 36 for details.
	Mute See "Muting the sound" on page 36 for details.
	Volume See "Adjusting the sound level" on page 37 for details.
	Treble See "Adjusting the Treble level" on page 37 for details.
	Bass See "Adjusting the Bass level" on page 37 for details.
	Power on/off Ring Tone See "Turning on the Power on/off Ring Tone" on page 37 for details.

FUNCTION	DESCRIPTION
Language	Sets the language for the On-Screen Display (OSD) menus. See "Using the menus" on page 25 for details.
Projector Position	The projector can be installed on a ceiling or behind a screen, or with one or more mirrors. See "Choosing a location" on page 15 for details.
Menu Settings	Menu display time Sets the length of time the OSD will remain active after your last key press. The range is from 5 to 30 seconds in 5-second increments.
	Menu position Sets the On-Screen Display (OSD) menu position.
5. SYSTEM SETUP menu Operation Settings	Direct Power On Selecting On enables the function. See "Starting up the projector" on page 22 for details.
	Auto Power Off Allows the projector to turn off automatically if no input signal is detected after a set period of time. See "Setting Auto Power Off" on page 50 for details.
	Blank Timer Sets the image blank time when the Blank feature is activated, once elapsed the image will return to the screen. See "Hiding the image" on page 35 for details.
	Sleep Timer Sets the auto-shutdown timer. The timer can be set to a value between 30 minutes and 12 hours.
	Background Color Allows you to select which background color will display when no signal is input into the projector. Three options are available: Black, Blue, or Purple.
	Splash Screen Allows you to select which logo screen will display during projector start-up. Three options are available: BenQ logo, Black screen, or Blue screen.
Standby Settings	Monitor Out Selecting On enables the function. The projector can output a VGA signal when it is in standby mode and the COMPUTER jack is correctly connected to devices. <p> Enabling this function slightly increases the standby power consumption.</p>

		FUNCTION	DESCRIPTION
5. SYSTEM SETUP menu		High Altitude Mode	A mode for operation in high altitude areas. See " Operating in a high altitude environment " on page 36 for details.
		Lamp Settings	<p>Lamp Mode See "Setting Lamp Mode as Economic" on page 50 for details.</p> <p>Reset lamp timer See "Resetting the lamp timer" on page 54 for details.</p> <p>Equivalent Lamp Hour See "Getting to know the lamp hour" on page 50 for details.</p>
		Security Settings	<p>Change password You will be asked to enter the current password before changing to a new one.</p> <p>Change Security Settings</p> <p>Power on Lock See "Securing the projector" on page 26 for details.</p>
		Baud Rate	Selects a baud rate that is identical with your computer's so that you can connect the projector using a suitable RS-232 cable and update or download the projector's firmware. This function is intended for qualified service personnel.
		LED Indicator	Selecting On enables the function and the POWER LED on the control panel lights when the project is in use.
		Reset All Settings	<p>Returns all settings to the factory preset values.</p> <p> The following settings will still remain: PC & Component YPbPr Tuning, Language, Projector Position, High Altitude Mode, Security Setting and Baud Rate.</p>
6. INFORMATION menu		Current System Status	<p>Source Shows the current signal source.</p> <p>Picture Mode Shows the selected mode in the PICTURE: Basic menu.</p> <p>Resolution Shows the native resolution of the input signal.</p> <p>Color System Shows input system format, NTSC, PAL, SECAM, or RGB.</p> <p>Equivalent Lamp Hour Displays the number of hours the lamp has been used.</p> <p>Firmware Version Shows firmware version.</p>

Maintenance

Care of the projector

Your projector needs little maintenance. The only thing you need to do on a regular basis is to keep the lens and case clean.

Never remove any parts of the projector except the lamp. Contact your dealer if other parts need replacing.

Cleaning the lens

Clean the lens whenever you notice dirt or dust on the surface.

- Use a canister of compressed air to remove dust.
- If there is dirt or smears, use lens-cleaning paper or moisten a soft cloth with lens cleaner and gently wipe the lens surface.
- Never use any type of abrasive pad, alkaline/acid cleaner, scouring powder, or volatile solvent, such as alcohol, benzene, thinner or insecticide. Using such materials or maintaining prolonged contact with rubber or vinyl materials may result in damage to the projector surface and cabinet material.

 **Never rub the lens with abrasive materials.**

Cleaning the projector case

Before you clean the case, turn the projector off using the proper shutdown procedure as described in "[Shutting down the projector](#)" on [page 39](#) and unplug the power cord.

- To remove dirt or dust, wipe the case with a soft, lint-free cloth.
- To remove stubborn dirt or stains, moisten a soft cloth with water and a neutral pH detergent. Then wipe the case.

 **Never use wax, alcohol, benzene, thinner or other chemical detergents. These can damage the case.**

Storing the projector

If you need to store the projector for an extended time, please follow the instructions below:

- Make sure the temperature and humidity of the storage area are within the recommended range for the projector. Please refer to "[Specifications](#)" on [page 57](#) or consult your dealer about the range.
- Retract the adjuster feet.
- Remove the battery from the remote control.
- Pack the projector in its original packing or equivalent.

Transporting the projector

It is recommended that you ship the projector with its original packing or equivalent.

Lamp information

Getting to know the lamp hour

When the projector is in operation, the duration (in hours) of lamp usage is automatically calculated by the built-in timer.

 See "**Setting Lamp Mode as Economic**" below for more information on **Economic mode**.

To obtain the lamp hour information:

1. Press **MENU/EXIT** and then press **◀/▶** until the **SYSTEM SETUP** menu is highlighted.
2. Press **▼** to highlight **Lamp Settings** and press **MODE/ENTER**. The **Lamp Settings** page displays.
3. You will see the **Equivalent Lamp Hour** information displaying on the menu.
4. To leave the menu, press **MENU/EXIT**.

You can also get the lamp hour information on the **INFORMATION** menu.

Extending lamp life

The projection lamp is a consumable item. To keep the lamp life as long as possible, you can do the following settings via the OSD menu.

Setting Lamp Mode as Economic

Using **Economic** mode reduces system noise and power consumption by 20%. If the **Economic** mode is selected, the light output will be reduced and result in darker projected pictures.

Setting the projector in **Economic** mode also extends the lamp operation life. To set **Economic** mode, go into the **SYSTEM SETUP > Lamp Settings > Lamp Mode** menu and press **◀/▶**.

Setting Auto Power Off

This function allows the projector to turn off automatically if no input source is detected after a set period of time to prevent unnecessary waste of lamp life.

To set **Auto Power Off**, go into the **SYSTEM SETUP > Operation Settings > Auto Power Off** menu and press **◀/▶**. The time period can be set from 5 to 30 minutes in 5-minute increments. If the preset time lengths are not suitable for your presentation, select **Disable**. The projector will not automatically shut down in a certain time period.

Timing of replacing the lamp

When the **Lamp indicator** lights up red or a message appears suggesting it is time to replace the lamp, please install a new lamp or consult your dealer. An old lamp may cause a malfunction in the projector and in some instances the lamp may explode.

Go to <http://lamp.benq.com> for a replacement lamp.

 **The Lamp indicator light and Temperature warning light will light up if the lamp becomes too hot. See "Indicators" on page 55 for details.**

The following lamp warning displays will remind you to change the lamp.

 **The warning messages below are for reference only. Please follow the actual on-screen instructions to prepare and replace the lamp.**

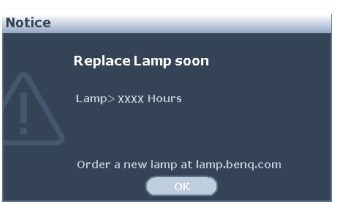
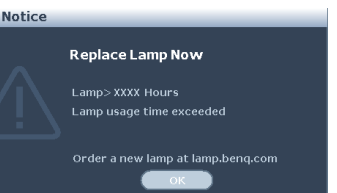
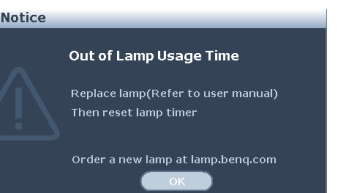
Status	Message
<p>Install a new lamp for optimal performance. If the projector is normally run with Economic selected ("Setting Lamp Mode as Economic" on page 50), you may continue to operate the projector until the next lamp warning appears.</p> <p>Press MODE/ENTER to dismiss the message.</p>	
<p>A new lamp should be fitted to avoid the inconvenience when the projector runs out of lamp time.</p> <p>Press MODE/ENTER to dismiss the message.</p>	
<p>It is strongly recommended that you replace the lamp at this stage. The lamp is a consumable item. The lamp brightness diminishes with use. This is normal lamp behavior. You can replace the lamp whenever you notice that the brightness level has significantly diminished.</p> <p>Press MODE/ENTER to dismiss the message.</p>	
<p>The lamp MUST be replaced before the projector will operate normally.</p> <p>Press MODE/ENTER to dismiss the message.</p>	

 **"XXXX" shown in the above messages are numbers that vary depending on different models.**

Replacing the lamp



- Hg - Lamp contains mercury. Manage in accordance with local disposal laws. See www.lamprecycle.org.
 - If lamp replacement is performed while the projector is suspended upside-down from the ceiling, make sure that no one is underneath the lamp socket to avoid any possible injury or damage to the human eyes caused by fractured lamp.
 - To reduce the risk of electrical shock, always turn the projector off and disconnect the power cord before changing the lamp.
 - To reduce the risk of severe burns, allow the projector to cool for at least 45 minutes before replacing the lamp.
 - To reduce the risk of injuries to fingers and damage to internal components, use caution when removing lamp glass that has shattered into sharp pieces.
 - To reduce the risk of injuries to fingers and/or compromising image quality by touching the lens, do not touch the empty lamp compartment when the lamp is removed.
 - This lamp contains mercury. Consult your local hazardous waste regulations to dispose of this lamp in a proper manner.
 - To assure optimal performance from the projector, it is recommended that you purchase a BenQ projector lamp for lamp replacement.
1. Turn the power off and disconnect the projector from the power outlet. If the lamp is hot, avoid burns by waiting for approximately 45 minutes until the lamp has cooled.
 2. Loosen the screw that secures the lamp cover.

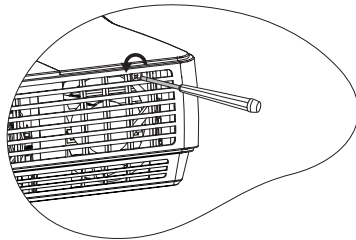

3. Remove the lamp cover by (a) sliding the cover toward the side of the projector and (b) lifting it off.



- **Do not turn the power on with the lamp cover removed.**
- **Do not insert your fingers between the lamp and the projector. The sharp edges inside the projector may cause injuries.**

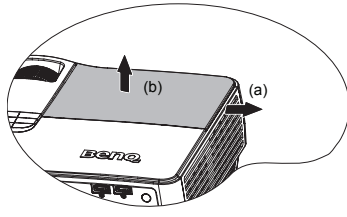

4. Loosen the screws that secure the lamp.

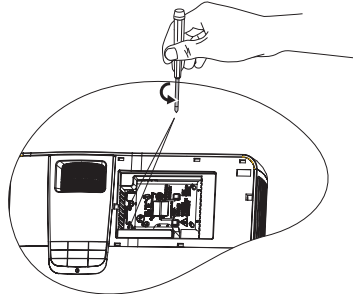

5. Lift the handle so that it stands up. Use the handle to slowly pull the lamp out of the projector.



- **Pulling it too quickly may cause the lamp to break and scatter broken glass in the projector.**
- **Do not place the lamp in locations where water might splash on it, children can reach it, or near flammable materials.**
- **Do not insert your hands into the projector after the lamp is removed. If you touch the optical components inside, it could cause color unevenness and distortion of the projected images.**

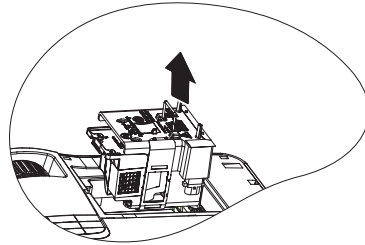

6. Insert the new lamp into the lamp compartment and make sure it fits in the projector.

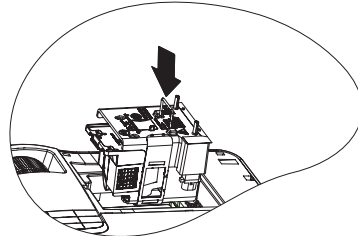

7. Tighten the screws that secure the lamp.



• **Loose screw may cause a bad connection, which could result in malfunction.**

• **Do not over tighten the screws.**

8. Ensure the handle is fully laid flat and locked in place.

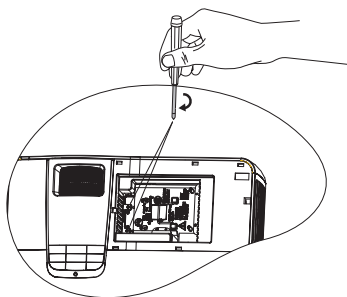

9. Replace the lamp cover by sliding it into place.

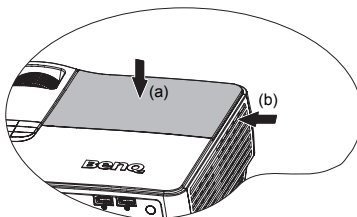

10. Tighten the screw that secures the lamp cover.



• **Loose screw may cause a bad connection, which could result in malfunction.**

• **Do not over tighten the screw.**

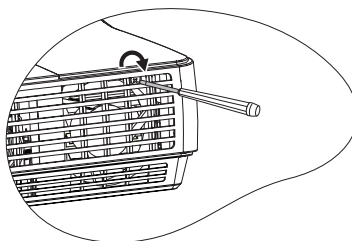

11. Restart the projector.



• **Do not turn the power on with the lamp cover removed.**

Resetting the lamp timer

12. After the startup logo, open the On-Screen Display (OSD) menu. Go to the **SYSTEM SETUP > Lamp Settings** menu. Press **MODE/ENTER**. The **Lamp Settings** page displays.

Press **▼** to highlight **Reset Lamp Timer** and press **MODE/ENTER**. A warning message displays asking if you want to reset the lamp timer. Highlight **Reset** and press **MODE/ENTER**. The lamp time will be reset to '0'.

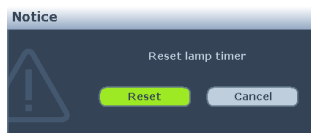

• **Do not reset if the lamp is not new or replaced as this could cause damage.**

Indicators

Light			Status & Description
POWER	TEMP	LAMP	
Power events			
Red	Off	Off	Stand-by mode
Green Flashing	Off	Off	Powering up
Green	Off	Off	Normal operation
Red Flashing	Off	Off	The projector needs to cool for 90 seconds after the power is turned off.
Lamp events			
Off	Off	Red	The projector has shutdown automatically. If you try to restart the projector, it will shutdown again. Please contact your dealer for assistance.
Off	Off	Red Flashing	1. The projector needs 90 seconds to cool down. Or 2. Please contact your dealer for assistance.
Thermal events			
Off	Red Flashing	Off	The projector has shutdown automatically. If you try to restart the projector, it will shutdown again. Please contact your dealer for assistance.
Off	Red	Off	
Red Flashing	Off	Off	
System events			
Off	Red Flashing	Red Flashing	The projector has shutdown automatically. If you try to restart the projector, it will shutdown again. Please contact your dealer for assistance.
Off	Red	Red	

Troubleshooting

⑦ The projector does not turn on.

Cause	Remedy
There is no power from the power cable.	Plug the power cord into the AC inlet on the projector, and plug the power cord into the power outlet. If the power outlet has a switch, make sure that it is switched on.
Attempting to turn the projector on again during the cooling process.	Wait until the cooling down process has completed.

⑦ No picture

Cause	Remedy
The video source is not turned on or connected correctly.	Turn the video source on and check that the signal cable is connected correctly.
The projector is not correctly connected to the input signal device.	Check the connection.
The input signal has not been correctly selected.	Select the correct input signal with the SOURCE key on the projector or remote control.
The lens cover is still closed.	Open the lens cover.

⑦ Blurred image

Cause	Remedy
The projection lens is not correctly focused.	Adjust the focus of the lens using the focus ring.
The projector and the screen are not aligned properly.	Adjust the projection angle and direction as well as the height of the unit if necessary.
The lens cover is still closed.	Open the lens cover.

⑦ Remote control does not work

Cause	Remedy
The battery is out of power.	Replace the battery with new one.
There is an obstacle between the remote control and the projector.	Remove the obstacle.
You are too far away from the projector.	Stand within 8 meters (26 feet) of the projector.

⑦ The password is incorrect

Cause	Remedy
You do not remember the password.	Please see "Entering the password recall procedure" on page 27 for details.

Specifications

 All specifications are subject to change without notice.

Optical

Resolution
1920x1080, 1080p

Display system
1-CHIP DMD

Lens F/Number
F = 2.41 to 2.91
f = 20.72 to 31 mm

Lamp
230 W lamp

Electrical

Power supply
AC100–240V, 3.70A,
50-60 Hz (Automatic)

Power consumption
320 W (Max); < 1 W (Standby)

Mechanical

Weight
3.6 Kg (8 lbs)

Output terminals

RGB output
D-Sub 15-pin (female) x 1

Speaker
10 watt x 2

Audio output
3.5mm jack x 1

12V Trigger
3.5mm jack x 1

Control

RS-232 serial control
9 pin x 1
USB Type B x 1

Input terminals

Computer input
RGB input
D-Sub 15-pin (female) x 1

Video signal input
HDMI
Screw type x 2
S-VIDEO
Mini DIN 4-pin port x 1

VIDEO
RCA jack x 1
SD/HDTV signal input
Component RCA jack x 3

Audio input
PC audio jack x 1
RCA jack x 2

Environmental Requirements

Operating temperature
0°C-35°C at sea level
Operating relative humidity
10%-90% (without condensation)
Operating altitude
0-1499 m at 0°C-35°C
1500-3000 m at 0°C-30°C (with High
Altitude Mode on)

Dimensions

339.2 mm (W) x 138.8 mm (H) x 260.6 mm (D)

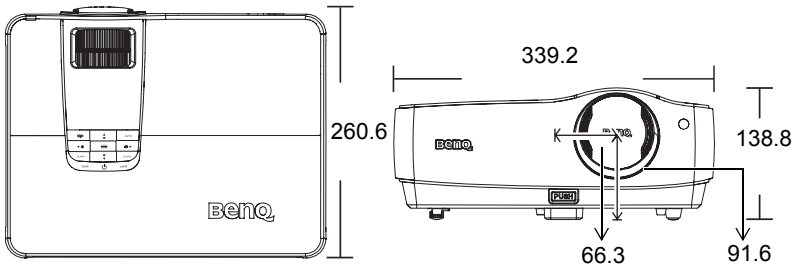

Ceiling mount installation

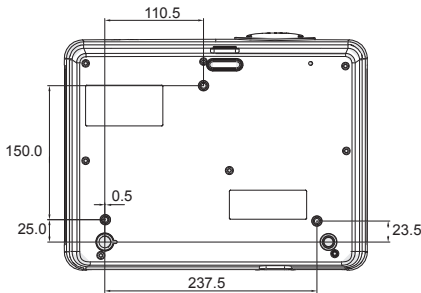

Ceiling mount screws:
M4 x 8 (Max. L = 8 mm)

Unit: mm

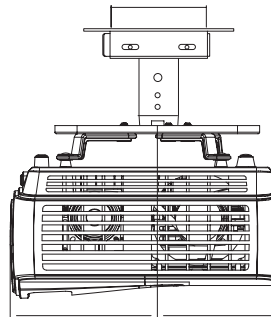
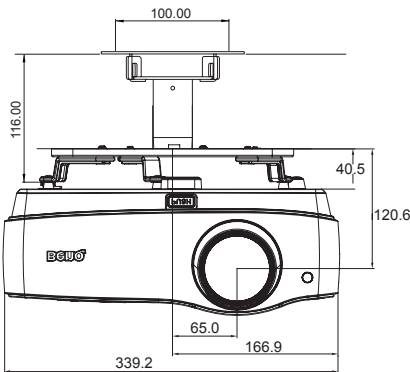

Timing chart

Supported timing for PC input

Resolution	Horizontal Frequency (kHz)	Vertical Frequency (Hz)	Pixel Frequency (MHz)	Mode
640 x 480	31.469	59.940	25.175	VGA_60
	37.861	72.809	31.500	VGA_72
	37.500	75.000	31.500	VGA_75
	43.269	85.008	36.000	VGA_85
720 x 400	31.469	70.087	28.3221	720 x 400_70
800 x 600	37.879	60.317	40.000	SVGA_60
	48.077	72.188	50.000	SVGA_72
	46.875	75.000	49.500	SVGA_75
	53.674	85.061	56.250	SVGA_85
1024 x 768	48.363	60.004	65.000	XGA_60
	56.476	70.069	75.000	XGA_70
	60.023	75.029	78.750	XGA_75
	68.667	84.997	94.500	XGA_85
1024 x 576	35.820	60.0	46.966	BenQ
1024 x 600	41.467	64.995	51.419	BenQ
1024 x 600@60Hz	37.32	60.00	48.964	Notebook timing
1280 x 800	49.702	59.810	83.500	WXGA_60
1280 x 1024	62.795	74.934	106.500	WXGA_75
	71.554	84.880	122.500	WXGA_85
	63.981	60.020	108.000	SXGA_60
1280 x 960	79.976	75.025	135.000	SXGA_75
	91.146	85.024	157.500	SXGA_85
	60.000	60.000	108	1280 x 960_60
1440 x 900	85.938	85.002	148.500	1280 x 960_85
	55.935	59.887	106.500	WXGA+_60
1400 x 1050	65.317	59.978	121.750	SXGA+_60
1600 x 1200	75.000	60.000	162.000	UXGA
640 x 480@67Hz	35.000	66.667	30.240	MAC13
832 x 624@75Hz	49.722	74.546	57.280	MAC16
1024 x 768@75Hz	60.241	75.020	80.000	MAC19
1152 x 870@75Hz	68.68	75.06	100.00	MAC21
640 x 480	61.910	119.518	52.500	VGA_120
800 x 600	77.425	119.854	83.000	SVGA_120
1024 x 768	98.958	119.804	137.750	XGA_120
1280 x 800	101.563	119.909	146.250	WXGA_120

Supported timing for HDMI input

Resolution	Horizontal Frequency (kHz)	Vertical Frequency (Hz)	Pixel Frequency (MHz)	Mode
640 x 480	31.469	59.940	25.175	VGA_60
	37.861	72.809	31.500	VGA_72
	37.500	75.000	31.500	VGA_75
	43.269	85.008	36.000	VGA_85
	61.910	119.518	52.500	VGA_120
720 x 400	31.469	70.087	28.3221	720 x 400_70
800 x 600	35.156	56.250	36.000	SVGA_56
	37.879	60.317	40.000	SVGA_60
	48.077	72.188	50.000	SVGA_72
	46.875	75.000	49.500	SVGA_75
	53.674	85.061	56.250	SVGA_85
	77.425	119.854	83.000	SVGA_120
1024 x 768	48.363	60.004	65.000	XGA_60
	56.476	70.069	75.000	XGA_70
	60.023	75.029	78.750	XGA_75
	68.667	84.997	94.500	XGA_85
	98.958	119.804	137.750	XGA_120
1152 x 864	67.500	75.000	108.000	1152 x 864_75
1280 x 768	47.396	60	68.25	1280 x 768_60
	47.776	59.870	79.5	1280 x 768_60
	60.289	74.893	102.25	1280 x 768_75
	68.633	84.837	117.50	1280 x 768_85
1280 x 800	49.702	59.810	83.500	WXGA_60
	62.795	74.934	106.500	WXGA_75
	71.554	84.880	122.500	WXGA_85
	101.563	119.909	146.250	WXGA_120
	1280 x 1024	63.981	60.020	108.000
79.976		75.025	135.000	SXGA_75
91.146		85.024	157.500	SXGA_85
1280 x 960		60.000	60.000	108
	85.938	85.002	148.500	1280 x 960_85
1360 x 768	47.712	60.015	85.500	1360 x 768_60
1440 x 900	55.469	60	88.75	WXGA+_60
	55.935	59.887	106.500	WXGA+_60
	70.635	74.984	136.75	WXGA+_75
	80.430	84.842	157.000	WXGA+_85
1400 x 1050	65.317	59.978	121.750	SXGA+_60
1600 x 1200	75.000	60.000	162.000	UXGA
1680 x 1050	64.674	59.883	119.000	1680 x 1050_60
	65.290	59.954	146.250	1680 x 1050_60
1920 x 1200	74.038	59.950	154.000	1920 x 1200_60
640 x 480@67Hz	35.000	66.667	30.240	MAC13
832 x 624@75Hz	49.722	74.546	57.280	MAC16
1024 x 768@75Hz	60.241	75.020	80.000	MAC19
1152 x 870@75Hz	68.68	75.06	100.00	MAC21
1024 x 576@60Hz	35.820	60.00	46.996	Notebook timing
1024 x 600@60Hz	37.32	60.00	48.964	Notebook timing
1024 x 600@65Hz	41.467	64.995	51.419	Notebook timing

VIDEO (HDCP)	15.73	59.94	27	480i
	15.63	50i	27	576i
	31.47	59.94	27	480p
	31.25	50p	27	576p
	44.96	59.94	74.25	720p60
	37.50	50p	74.25	720p50
	26.97	23.98	74.25	1080/24P
	28.13	25	74.25	1080/25P
	33.72	29.97	74.25	1080/30P
	33.72	59.94	74.25	1080i60
	28.13	50i	74.25	1080i50
	67.43	59.94	148.5	1080p60
	56.25	50p	148.5	1080p50

 Displaying a 1080i(1125i)@60Hz or 1080i(1125i)@50Hz signal may result in slight image vibration.

Supported timing for Component-YPbPr input

Signal Format	Horizontal Frequency (kHz)	Vertical Frequency (Hz)
480i	15.73	59.94
480p	31.47	59.94
576i	15.63	50.00
576p	31.25	50.00
720/50p	37.5	50.00
720/60p	44.96	59.94
1080/50i	28.125	50
1080/60i	33.72	59.94
1080/24P	26.97	23.98
1080/25P	28.125	25
1080/30P	33.72	29.97
1080/50P	56.25	50
1080/60P	67.43	59.94

Supported timing for Video and S-Video inputs

Video mode	Horizontal Frequency (kHz)	Vertical Frequency (Hz)	Color sub-carrier Frequency (MHz)
NTSC	15.73	60	3.58
PAL	15.63	50	4.43
SECAM	15.63	50	4.25 or 4.41
PAL-M	15.73	60	3.58
PAL-N	15.63	50	3.58
PAL-60	15.73	60	4.43
NTSC4.43	15.73	60	4.43

Warranty and Copyright information

Patents for W1100/W1200

This BenQ projector is covered by the following patents:

U.S. patents 6,837,608; 7,275,834; 7,181,318; TW patents 202690; 205470; I228635; I259932; China Patents (中国发明专利) ZL01143168.7; ZL03119907.0; ZL200510051609.2

Limited warranty

BenQ warrants this product against any defects in material and workmanship, under normal usage and storage.

Proof of purchase date will be required with any warranty claim. In the event this product is found to be defective within the warranty period, BenQ's only obligation and your exclusive remedy shall be replacement of any defective parts (labor included). To obtain warranty service, immediately notify the dealer from which you purchased the product of any defects.

Important: The above warranty shall be void if the customer fails to operate the product in accordance with BenQ's written instructions, especially the ambient humidity must be in-between 10% and 90%, temperature in-between 0°C and 35°C, altitude lower than 4920 feet, and avoiding to operate the projector in a dusty environment. This warranty gives you specific legal rights, and you may have other rights which vary from country to country.

For other information, please visit www.BenQ.com.

Copyright

Copyright 2010 by BenQ Corporation. All rights reserved. No part of this publication may be reproduced, transmitted, transcribed, stored in a retrieval system or translated into any language or computer language, in any form or by any means, electronic, mechanical, magnetic, optical, chemical, manual or otherwise, without the prior written permission of BenQ Corporation.

Disclaimer

BenQ Corporation makes no representations or warranties, either expressed or implied, with respect to the contents hereof and specifically disclaims any warranties, merchantability or fitness for any particular purpose. Further, BenQ Corporation reserves the right to revise this publication and to make changes from time to time in the contents hereof without obligation to notify any person of such revision or changes.

*DLP, Digital Micromirror Device and DMD are trademarks of Texas Instruments. Others are copyrights of their respective companies or organizations.

Regulation statements

FCC statement

CLASS B: This equipment generates, uses and can radiate radio frequency energy and, if not installed and used in accordance with the instructions, may cause harmful interference to radio communications. However, there is no guarantee that interference will not occur in a particular installation. If this equipment does cause harmful interference to radio or television reception, which can be determined by turning the equipment off and on, the user is encouraged to try to correct the interference by one or more of the following measures:

- Reorient or relocate the receiving antenna.
- Increase the distance between the equipment and receiver.
- Connect the equipment into an outlet on a circuit different from that to which the receiver is connected.
- Consult the dealer or an experienced radio/TV technician for help.

EEC statement (for European users)

This device complies with the requirements set out in the Council Directives on the Approximation of the Laws of the Member States relating Electromagnetic Compatibility (2004/108/EC) , Low Voltage Directive (2006/95/EC), the Restriction of The Use of Certain Hazardous Substances in Electrical And Electronic Equipment Directive (2002/95/EC), Turkish EEE Directive, Commission Regulation (EC) No 1275/2008 implementing Directive 2005/32/EC of the European Parliament and of the Council with regard to ecodesign requirements for standby and off mode electric power consumption of electrical and electronic household and office equipment, and the Directive 2009/125/EC of the European parliament and of the council establishing a framework for the setting of ecodesign requirements for energy-related products.

WEEE directive

Disposal of Waste Electrical and Electronic Equipment by users in private households in the European Union.

This symbol on the product or on the packaging indicates that this can not be disposed of as household waste. You must dispose of your waste equipment by handing it over to the applicable take-back scheme for the recycling of electrical and electronic equipment. For more information about recycling of this equipment, please contact your city office, the shop where you purchased the equipment or your household waste disposal service. The recycling of materials will help to conserve natural resources and ensure that it is recycled in a manner that protects human health and environment.



Accessibility Requirements for Rehabilitation Act of 1973, Section 508

BenQ's commitment to accessible products allows us to support government in making accessible technology choices BenQ's LCD monitors and projectors are compliant with Section 508 guidelines by including the assistive features as below:

- BenQ's monitors have colored "Power" indicators. While the indicator shows green, it means that the monitor is using the full power. While the indicator shows yellow or amber, it means that the monitor is in suspend or sleep mode and is using less than 2 watts of electricity.
- BenQ's monitors have a variety of settings of pre-programmed flicker-free timing to make the screen shown on the monitor readily accessible. The default timing setting is automatically turned on every time the monitor is powered up, and thus reduces the hassle of user intervention.
- BenQ's monitors and projectors have options for brightness and contrast adjustments that text and images could be displayed differently to meet the demands of the visually impaired. Other similar adjustments are also available by using the On-Screen Display (OSD) controls on the products.
- BenQ's monitors and projectors include user-selectable color controls, such as color temperature selections (Monitor: 5800K, 6500K and 9300K, Projector: 5500K, 6500K, 7500K and 9300K), with a wide range of contrast levels.
- BenQ's multimedia monitors and projectors usually have one or two speakers for audio performance which allow users (including hearing impaired) to interact with the computer systems connected. Speaker controls are typically located on the front-panel.
- Firmware of BenQ's monitors and projectors contain unique product information that helps computer systems to identify BenQ products and activate their Plug-and-Play function when connected.
- All BenQ's monitors and projectors are compatible with the PC99 standard. For example, connectors are color-coded to help users easily connecting products to computer systems correctly.
- Some models of BenQ's monitors and projectors contain additional USB and DVI ports for connection to more devices such as a special headphone to assist the hearing impaired.
- All BenQ monitors and projectors come with user manuals on compact discs which could be easily read by commercial software such as Adobe Reader via a connected computer system. These documents are also available on the BenQ's web site (www.BenQ.com <<http://www.BenQ.com>>). Other types of documents may be available upon requests.
- BenQ's customer service provides answers and assistance to all our customers through phone calls, facsimiles, e-mails, or web sites.

- The mains lead (power cable) on the Projector comes with a moulded plug incorporating a fuse.
- The rating of the fuse is indicated on the pin face of the plug and, if it requires replacing, a fuse approved by ASTA or BSI to BS 1362 of the same rating must be used.
- If the plug has a detachable fuse cover, remember to place the fuse cover back if you need to change the fuse.
- Do NOT use a plug without the fuse cover. If the fuse cover is missing, contact your nearest BenQ Customer Service Center for assistance.