

Owner's Manual

Network Set-up and Operation

Wired Setting

Projector Set-up and Operation

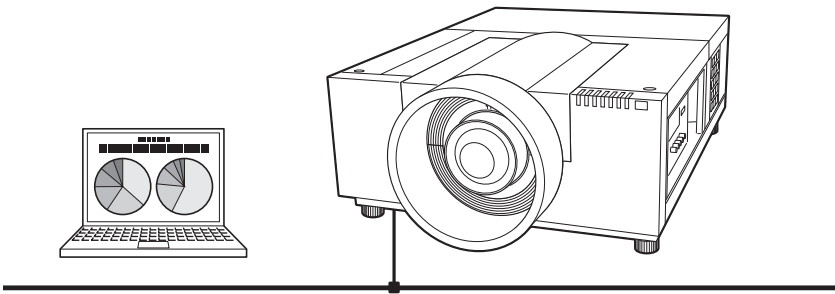

This is the manual for the Network function.
Read this manual thoroughly to operate the Network function.
First, read the owner's manual of the projector to understand the basic operation of the projector and the safety instructions.
The safety instructions in the owner's manuals should be followed strictly.

for HDT1000

Touchboards

205 Westwood Ave, Long Branch, NJ 07740
Phone: 866-94 BOARDS (26273) / (732)-222-1511
Fax: (732)-222-7088 | E-mail: sales@touchboards.com

Compliance

Federal Communications Commission Notice

This equipment has been tested and found to comply with the limits for a Class A digital device, pursuant to Part 15 of FCC Rules. These limits are designed to provide reasonable protection against harmful interference when the equipment is operated in a commercial environment. This equipment generates, uses, and can radiate radio frequency energy and, if not installed and used in accordance with the instruction manual, may cause harmful interference to radio communications. Operation of this equipment in a residential area is likely to cause harmful interference in which case the user will be required to correct the interference at his own expense.

Do not make any changes or modifications to the equipment unless otherwise specified in the instructions. If such changes or modifications should be made, you could be required to stop operation of the equipment.

WARNING

This is a Class A product. In a domestic environment this product may cause radio interference in which case the user may be required to take adequate measures.

Safety instructions



CAUTION IN USING THE PROJECTOR VIA NETWORKS

- When you find a problem with the projector, remove the power cable immediately and inspect the unit. Using the projector with failure may cause fire or other accidents.
- If you remotely use the projector via networks, carry out a safety check regularly and take particular care to its environment. Incorrect installation may cause fire or other accidents.



CAUTION IN USING NETWORK FUNCTION

- We assume no responsibility for the loss or damage of data, or damage of the computer caused by using this projector. Making back-up copies of valuable data in your computer is recommended.

Table of contents

Compliance.....	2
Safety instructions.....	3
Table of contents.....	4
Chapter 1 Preparation	5
Features.....	6
Required operating environment for computers	7
Network specifications of the projector.....	7
Flow of installation.....	9
Notice about installing Software CD-ROM.....	9
Chapter 2 Setup Procedures.....	11
Connecting to the LAN line.....	12
Network configuration.....	12
Network PIN code.....	14
Network information.....	14
Network factory default.....	15
Wired LAN factory default settings.....	15
Chapter 3 Basic Setting and Operation.....	17
Login the setting page of the projector.....	18
[1] Enter the IP address.....	18
[2] Login.....	18
[3] Display of main setting page.....	19
How to use the setting page.....	20
Initial setting.....	22
Network PIN code setting.....	23
PJLink and password setting.....	23
Network configuration.....	24
E-mail setting.....	25
Examples: Type and contents of alert mail.....	28
SNMP setting.....	29
Chapter 4 Controlling the Projector	31
Power control and status check.....	32
Control.....	34
Input.....	34
System.....	35
Image adjustment.....	36
PC adjustment.....	37
Setting up the projector.....	38
Screen setting.....	38
Lens adjustment.....	39
Setting 1.....	40
Setting 2.....	41
Setting 3.....	42
Setting 4.....	43
Information.....	44
Information 1.....	44
Information 2.....	45
Network.....	45
Chapter 5 Appendix	47
Examples of connection.....	48
Use of telnet.....	50
Web browser setting.....	52
Examples: OS/Browsers.....	53
Q&A.....	57

Chapter 1

Preparation

Describes features and operating environment of this projector.

1

Features

Web Management function (☞ p.31)

With this function, you can monitor projector functions such as power status, lamp status, input mode, signal condition, lamp-use time, etc. through the network by using the web browser installed on your computer.

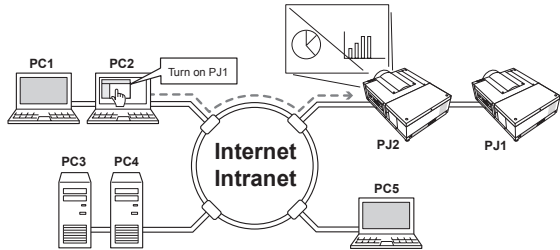

E-Mail Alert function (☞ p.25)

The projector sends messages to the registered e-mail addresses when a lamp abnormality or power failure occurs with the projector. This message describes how to solve the cause of the problems. You can take efficient action for quick recovery.

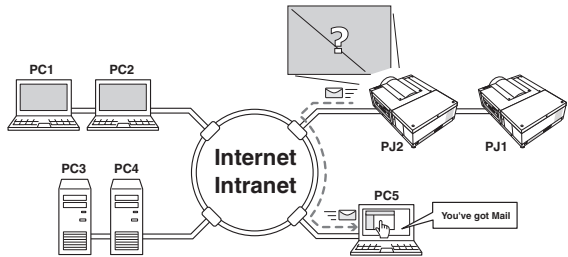

SNMP Agent function (☞ p.29)

To send the information of the projector to the SNMP manager. Enables you to manage the projector condition with the supplied SNMP manager software.

SNMP Manager function

A function to manage the condition of projectors in the network by using the SNMP protocol. The managing computer needs to provide an SNMP managing software. Refer to the owner's manual of the "PJ Network Manager" supplied separately for further details.

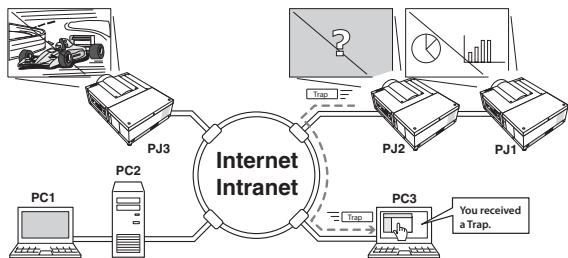

Required operating environment for computers

When operating the projector via networks, computers should meet the operating environment below.

Operating System		Windows 2000, Windows XP (32bit version), Windows Vista (32bit version), Windows 7 (32bit version) Mac OS X v 10.4 or 10.5
Computer environment	Recommended CPU	Windows: Pentium III 900MHz or more Macintosh : 800 MHz PowerPC G4 or faster, or 1.8 GHz Intel Core Processor or faster
	Memory	Windows : 64MB (Minimum)/ 128MB or more (Recommended) 128MB or more for Windows XP 1GB or more for Windows Vista or Windows 7 Macintosh : 256MB or more (512MB is recommended)
	Free disk space	100MB or more
	Drive equipment	CD-ROM drive
	Display settings	Support one of following resolutions; VGA (640 x 480), SVGA(800 x 600), XGA(1,024 x 768) Number of colors: Either of 16 bit (65,536 color 24/32 bit (16.77 million colors))
	Network card	The computer must provide a 10Base-T or 100Base-TX network card.
Web Browser*		Internet Explorer version 6.0, 7.0 or 8.0 Netscape Navigator version 7.1 or 9.0 Safari 3.1 * Used to control and set up the projector. The layout of pages in the browser may slightly differ from each type of application or operating system you use.
Recommended Internet Mailer*		- Microsoft Outlook - Microsoft Outlook Express - Netscape Mail * Required the internet e-mail application software to receive an e-mail alert sent from this projector. If you do not use the function E-mail Alert, this application is not required.

Network specifications of the projector

LAN Terminal

Data communication standards	100Base-TX (100Mbps)/10Base-T (10Mbps)
Protocol	TCP/IP

Cabling Between the Projector and a Hub or computer*1

Use an appropriate cable when connecting the projector and a hub or computer.

Connection	Ethernet cable type	Max. cable length
Projector - Hub	STP straight-through category 5 *2 cable	100m (328feet)
Projector - Computer	STP crossover category 5*2 cable	100m (328feet)

*1 There may be other limitations depending on your network environment or LAN specification. Please consult your network administrator for further details.

*2 Cable category indicates cable quality.

Notice

Expression/Abbreviation

The OS of the computer and the Web browser described in this manual are Windows XP Professional and Internet Explorer 6.0. In case of another OS or Web browser, some instruction procedures may differ from the actual operation depending on your computer environment.

Use of this manual

This manual does not provide the detailed description of basic operation and functions for computer, web browser, projector and network. For instructions about each piece of equipment or application software, please refer to the respective manual.

Trademarks

Ethernet is a registered trademark of Xerox Corporation. Microsoft, Windows, Windows NT, Windows XP, Windows Vista and Windows 7 are registered trademarks of Microsoft Corporation in the United States and other countries. Internet Explorer is a registered trademark of Microsoft Corporation. Netscape Navigator and Netscape Communicator are trademarks or registered trademarks of Netscape Communications Corporation. JavaScript is a registered trademark of Sun Microsystems, Inc.

Macintosh is a registered trademark of Apple, Inc. in the USA and other countries. PowerPC is a registered trademark of IBM Corporation. Intel Core is a registered trademark of Intel Corporation in the USA and other countries.

Other product or brand names in this manual are registered trademarks or trademarks of their respective owners.

* Unauthorized use of a part or whole of the contents in this manual is prohibited.

* The contents of this manual are subject to change without notice.

Flow of installation

To use the projector via the networks, follow the setup procedures below.

STEP 1

Connect the LAN and set the configuration.



Decide depending on the LAN environment.

→ "2. Setup Procedures" (pp.11–16).

Detailed LAN configurations need to be done with a browser later.

First, complete the Wired LAN connection between computers and projectors, then start browser configurations.

→ "3. Basic setting and operation" (pp.17–30).

STEP 2

Network Configuration has completed.



Follow each chapter to operate the projector.

■ Operate and manage the projector → "4. Controlling the projector" (pp.31-46)

→ "Power Control and status check" (p.32)

→ "Control" (pp.34-36)

→ "PC adjustment" (p.37)

→ "Setting up the projector" (pp.38-43)

→ "Projector information" (pp.44-46)

STEP 3

Install the Software on computers.

Install the software recorded in CD-ROM on each computer which will be operated. Refer to the owner's manual of PJ Network Manager.

Notice about installing Software CD-ROM

It is available for controlling and setting of the projector by using the web browser without installing any software. So it is not required to install the software into your computer.

For PJ Network Manager function, it is required to install the software. Please see the owner's manual of "PJ Network Manager Function".

Chapter 2

Setup Procedures

Describes how to configure the network.

2

Setting procedures and contents differ depending on the LAN installation location. When installing, consult your system administrator to set up the LAN appropriately.

Connecting to the LAN line

Connect the LAN cable to the LAN connection terminal of the projector.

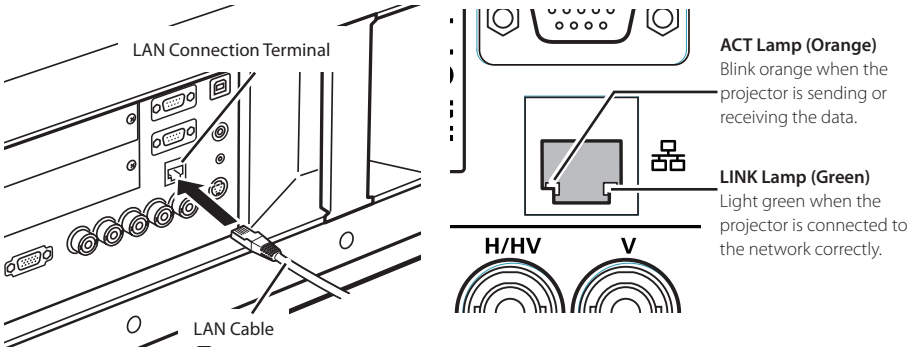

* Please use a shielded LAN cable.

Network configuration

Set the Wired LAN network through the projector menu. Detailed network settings will be made with browser. Refer to "3. Basic setting and operation" (p.17-30). First, complete the settings described in this chapter before performing steps in "3. Basic setting and operation."

Setting Procedure

1. Select "Network" in the Network menu, and press Point **▶** or **SELECT** button.
2. Select "On" with the Point **▲▼** buttons, and the press **SELECT** button. Then the Menu will disappear, the "Please wait..." message will appear, and switching operation will start. Switching will take a while and the projector's LINK/ACT Lamp will be on or blink, and after completing the operation, the "Please wait..." message will disappear.

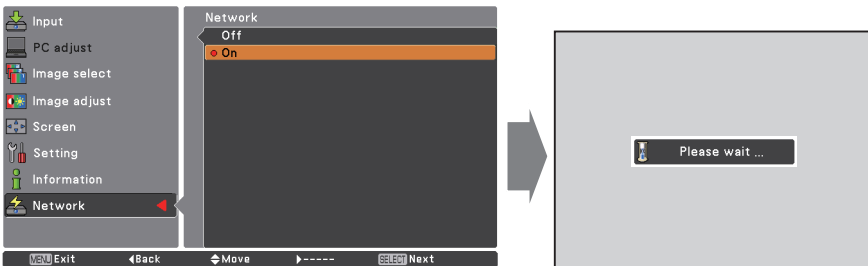

3. Select "Network setting" in the Network menu and press **SELECT** button, and then the LAN setting screen will appear and selected LAN settings will be displayed. Adjust each item to the setting environment. Consult your system administrator about the detailed settings.

Press **SELECT** button in a row where you want to adjust, and adjust the figures with the Point ▲▼ buttons and move among the items with the Point ◀▶ buttons, and then press **SELECT** button to fix. Move to the next row with the Point ▲▼ buttons to adjust.

4. After completing all the settings, select "Set" and press **SELECT** button. Now, all procedures have been done. To cancel the adjusted settings, select "Cancel" and press **SELECT** button.

You can confirm the LAN settings you have made from "Network information" (p.14). In such cases that the LAN cannot be connected, see this screen.



DHCP: On

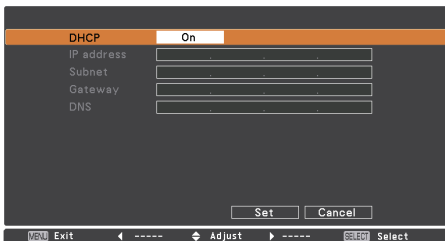

DHCP: Off

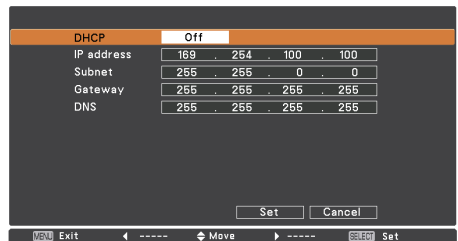

* The numerical value is a setting example.

Item	Description
------	-------------

DHCPSets DHCP function On or Off. When you setup the network setting manually, select "Off". When it is set On, IP address, Subnet, Gateway and DNS are automatically set according to your network environment *1.
------	--

IP addressSets IP address of the projector
------------	---------------------------------------

SubnetSets Subnet mask. Normally sets 255.255.255.0
--------	--

Gateway*2Sets IP address of the default gateway (Router)
-----------	--

DNS*3Sets IP address of the DNS server.
-------	---

*1 Set "On" only when the DHCP server is available on your network environment.

*2 Set [255.255.255.255] if the network does not provide the gateway (router).

*3 Set [255.255.255.255] if you do not use the function E-mail alert.

Network PIN code

The Network PIN code is to restrict the access to the projector through the network. After setting the Network PIN code, you need to enter it to operate the projector via the networks.

1. Select "Network PIN code" in the Network menu, and press **SELECT** button.
The Network PIN code screen will appear.
2. Set the Network PIN code.

Set the figures with the Point ▲▼ buttons and move to the next items with the Point ◀▶ buttons. Select "Set" and press **SELECT** button to set. To cancel the preset Network PIN code, select "Cancel". When you do not want to set the Network PIN code, set "0000". It is recommended to set the Network PIN code if you use the projector via the networks. The Network PIN code can be set also through the networks. See "3. Basic setting and operation" → "Initial setting" → "Network PIN code setting" (p.23).

* You can also enter the Network PIN code with the number buttons on the remote control.

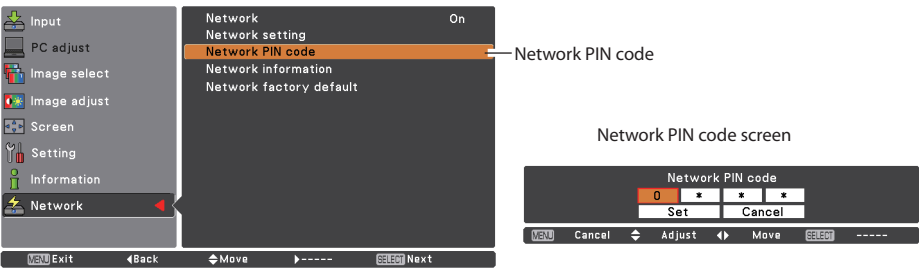

Network information

Select "Network information" in the Network menu and press Point ▶ or **SELECT** button to show LAN setting environment of the currently selected projector. (The description below is an example and different from what will be shown.)

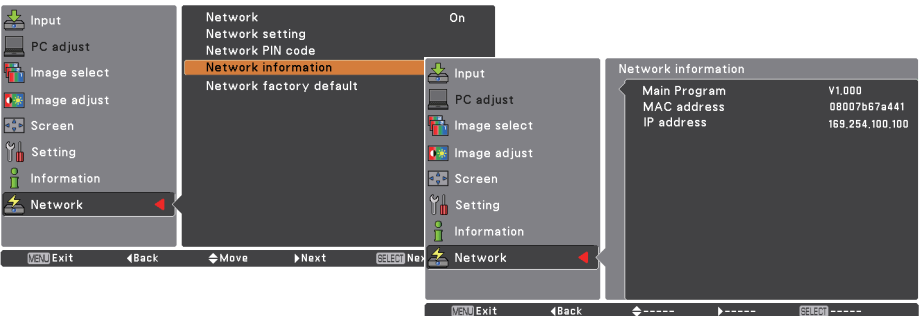

* The numerical value is a setting example.

Network factory default

1. Select "Network factory default" in the Network menu and press **SELECT** button.
2. A confirmation box appears and select "Yes" and then press **SELECT** button.
3. Another confirmation box appears and select "Yes" and then press **SELECT** button.
4. All the wired LAN settings will go back to the factory default settings. For details, refer to "Wired LAN factory default settings" as shown in the table below.

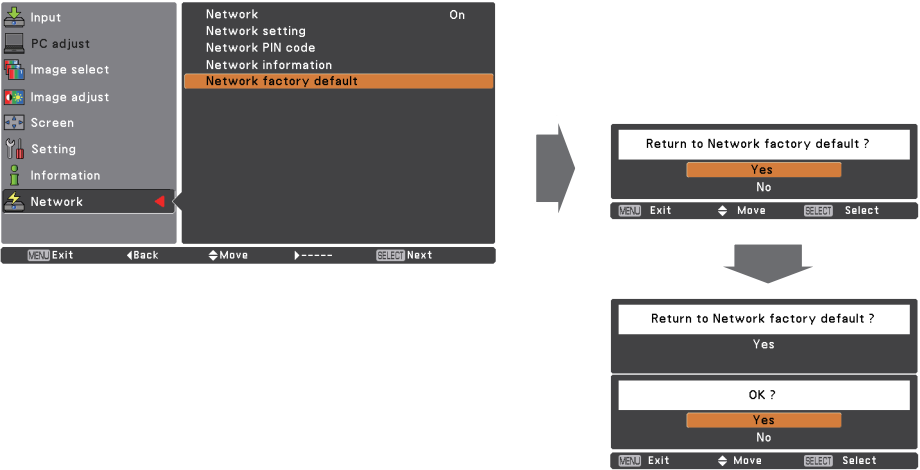

Wired LAN factory default settings

Parameter	Settings
DHCP	Off
IP ADDRESS	169.254.100.100
SUBNET MASK	255.255.0.0
GATEWAY ADDRESS	255.255.255.255
DNS ADDRESS	255.255.255.255

3

Chapter 3 ***Basic Setting and Operation***

Describes basic operations and settings for controlling the projector by using the web browser. It is required that computer and projector is connected to the network and the network address is properly configured.

Login the setting page of the projector

[1] Enter the IP address

Launch the web browser installed in your computer, enter the IP address into the "Address" on the browser and then press "Enter" key.

Enter the address that you configured in item "Network configuration" (p.12).

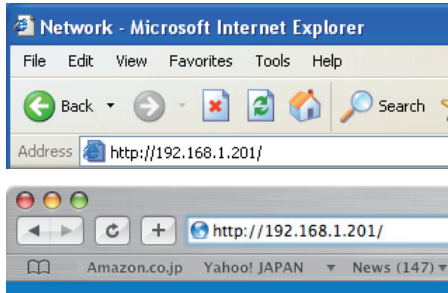

* The numerical value is a setting example.

[2] Login

If the setting page has set the password, the authentication window will appear. In this case type "user" onto the **User Name** text area and the login Network PIN code onto the **Password** text area and then click **OK (Log in)** button.

* The entering User Name must be "user" and it can not be changed.

[Note]

When accessing the projector for the first time or the Network PIN code "0000" is set, the auto-login will be performed and the next main setting page is displayed.

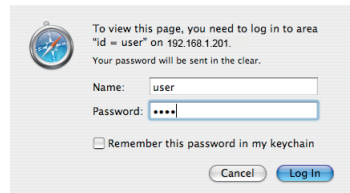

[3] Display of main setting page

The following main setting page will be displayed according to your display mode selection. Perform various kinds of settings through this page. Click on the menus to display the control and setting pages.

Main setting page in the display

The screenshot shows the projector's main setting page. On the left is a vertical 'Main menu' with icons and labels: Initial setting, Power & Status, PC Adj., Control, Setting, E-mail setting, Network, Information, and SNMP setting. The 'Control' menu is selected. The main area displays the 'Control' sub-menu, which includes options like Contrast, Brightness, Color, Tint, Color temp., White balance (Red, Green, Blue), Offset (Red, Green, Blue), Auto picture control, Advanced color, Sharpness, Gamma, Noise reduction, Progressive, Reset, Store, and Load image mode. Each option has a numerical value or status and a 'Set' button. A 'Sub menu tab' at the top right of the main area is labeled 'Input / System / Image adj.' and is used to switch between sub-menus.

Main menu
For selection of control and setting items of the projector.

Setting page
Displays the control and setting items according to the selected menu.

Sub menu tab
Switches the sub menu tab.

How to use the setting page

To control and set up the projector, use the setting menus on the web browser. Describes the basic operation and procedures commonly used on this manual.

Example of the setting page

The setting menu appears when clicking the sub menu tab.

* Each item has a valid setting range respectively.

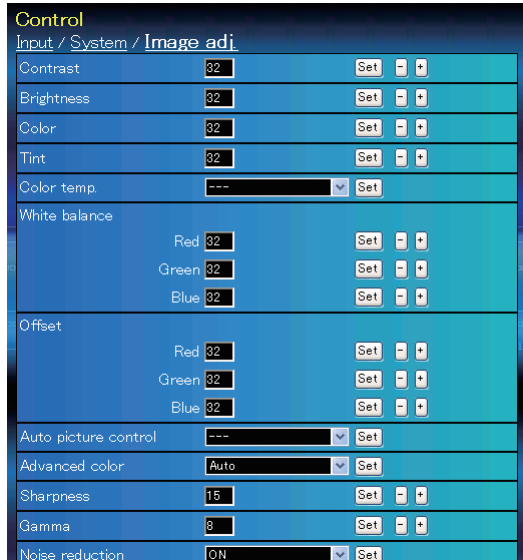

Types of setting

Text box setting

Enter a number or text and then click **Set** button.

or

Change a value with - or + button.

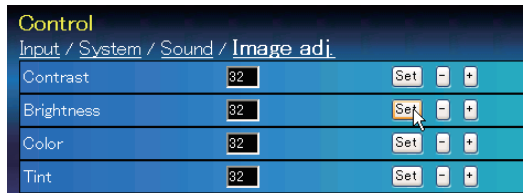

Pull-down menu setting

Select an item with pull-down menu button and then click **Set** button.

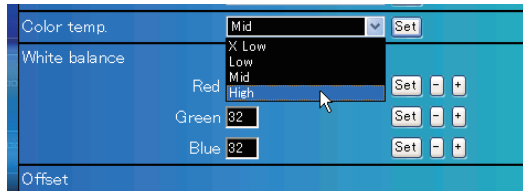

☞ The value in the text box indicates current value.

☞ Each item has a valid setting range. The setting value exceeding this becomes invalid. Some control items can not be used depending on the selecting input mode or functions of the projector you use. In this case, the values of those items are indicated with "---".

Radio button setting

Select an item by selecting a radio button.



Check box setting

Select items by ticking on check boxes.

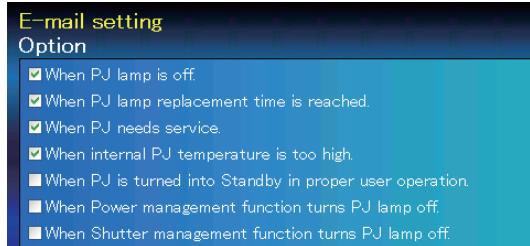



Initial setting

After installing the projector, perform the following basic initial setting. Click **Initial Setting** on the main menu to display the initial setting page.



* The serial number in the figure is used for an example.

Item	Description
------	-------------

- | | |
|------------------------|--|
| Language..... | Switches display language on the setting page. (Japanese, English) |
| Model name | Indicates the model name of the projector |
| SERIAL NO. | Indicates the serial number of the projector |
| Network PIN code | Sets the Network PIN code to login the setting page (☞p.23) |
| Temperature..... | Switches display temperature unit. (Centigrade, Fahrenheit) |
| PJLink..... | Switches PJLink password authentication. (ON, OFF) (☞p.23) |
| Password..... | Password for PJLink function (☞p.23) |

Network PIN code setting

This is to set the Network PIN code to restrict the access from an unauthorized person through the network.

Enter a 4-digit number as the Network PIN code onto the text box and click **Set** button.

The projector begins restarting and it takes about 10 seconds. Close (Quit) the web browser and access to the login page again in 10 seconds. This is to perform the login authentication firmly.

The default Network PIN code [0000] means no Network PIN code is set.

The screenshot shows the 'Initial setting' page with the following fields: Language (English), Model name (HDT1 000), SERIAL NO. (GOYA1234), Network PIN code (1234), Temperature (Center ade), and PJLink (OFF). The 'Set' button next to the Network PIN code field is highlighted with a mouse cursor.

☞ When you connect the projector to the network, it is recommended to set a new Network PIN code. Only a four-digit number is valid for the Network PIN code.

PJLink and password setting

This is to set the PJLink password authentication on or off. If set "ON" with the PJLink pull-down menu, the password must be required. Enter a **password*** onto the text box and click **Set** button.

The screenshot shows the 'Initial setting' page with the following fields: Language (English), Model name (HDT1 000), SERIAL NO. (GOYA1234), Network PIN code (1234), Temperature (Center ade), PJLink (OFF), and Password (4321). The 'Set' button next to the Password field is highlighted with a mouse cursor.

☞ 1 to 32 alphanumeric characters can be used for the password.

What's PJLink?

The projectors equipped with PJLink function can be used together on the same network, regardless of model or brand, for centralized control and monitoring. This standard was established by the Japan Business Machine and Information System Industries Association (JBMA). Please visit the Website at <http://pjlink.jbma.or.jp/english/>.

PJLink Notice

The projector is compliant with PJLink Standard Class 1 of JBMA, and it supports all commands defined by PJLink Class 1 and is verified conformance with PJLink Standard Class 1.

Projector Input		PJLink Input	Parameter
Input 1	RGB (PC analog)	RGB 1	11
	RGB (Scart)	RGB 2	12
	RGB (PC digital)	DIGITAL 1	31
	RGB (AV HDCP)	DIGITAL 2	32
	HDMI	DIGITAL 3	33
	INPUT 1	AUX 1	46
Input 2	Video	VIDEO 1	21
	Y, Pb/Cb, Pr/Cr	VIDEO 2	22
	RGB	RGB 3	13
	S-video	VIDEO 5	25
	INPUT 2	AUX 2	47
Input 3	INPUT 3	AUX 3	48
Input 4	INPUT 4	AUX 4	49



Network configuration

Click **Network** on the main menu. The following setting page is displayed. The IP Address, Subnet Mask, Default Gateway, DNS (Domain Name Server) and projector name are set up on this menu.

The IP address and Subnet Mask have been configured already in chapter "Installation". If you want to change them or configure default gateway or DNS, perform them in this page. If you change them, the projector begins restarting and it takes about 10 seconds. Close (Quit) the web browser and access to the login page again in 10 seconds.

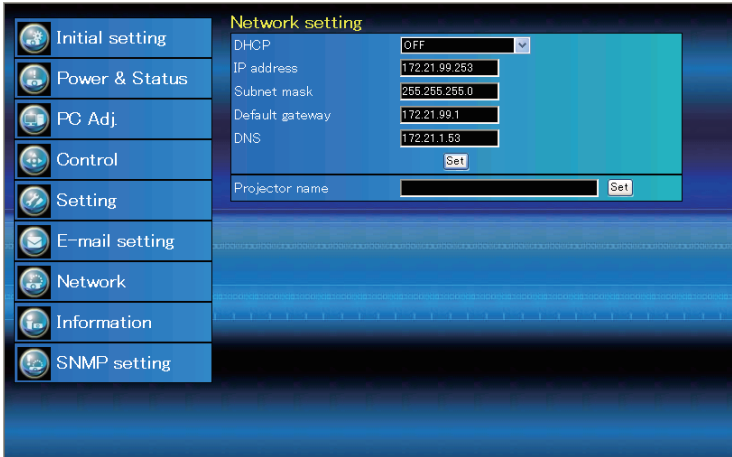

* The numerical value is a setting example.

Item	Description
------	-------------

DHCP.....	Sets DHCP configuration (ON/OFF).
IP address	Sets IP address of the projector
Subnet mask.....	Sets Subnet mask. Normally sets 255.255.255.0
Default gateway* ¹	Sets IP address of the default gateway (Router)
DNS* ²	Sets IP address of the DNS server. Must be set when using the e-mail function
Projector name* ³	Sets name of the projector. (64 characters maximum)

✎ You must use the number specified by your administrator. The address must be entered as a group with four numbers split by a dot like [192.168.001.101].

*1 Set [0.0.0.0] if the network does not provide the gateway (router).

*2 Set [0.0.0.0] if you do not use the function E-Mail alert.

*3 If you use the DNS server, register the host name registered to the DNS server as a projector name. You can access with this projector name from any computers in your network. If you do not use the DNS server, access with the assigned IP address to the projector.

* All the network setting will reset to the default when setting [0.0.0.0] of the IP Address.

* If you make incorrect settings, you cannot find out the new network settings. Be careful to set up them correctly, otherwise you cannot connect to the projector. It is recommended to make a note of them.



E-mail setting

This projector has an E-mail function which can send an alert message to users or an administrator if it detects an abnormality on the projector or run out of the life span of the lamp. Click **E-mail Setting** on the main menu and follow the below steps.

Item	Description
SMTP server	Enter server name or IP address of the SMTP server. (up to 60 characters)
SMTP server port	Enter Port number of the SMTP server. (from 1 to 65535)
Administrator address.....	Enter e-mail address of administrator.
Add address.....	Enter e-mail address of the user to send mail when the projector has an abnormality.
SMTP Authentication setting	
Auth	Sets authentication setting option. (OFF, SMTP Auth, POP before SMTP)
SMTP Auth	Sets user authentication setting option when selecting "SMTP Auth" in above column. (CRAM-MD5, LOGIN, PLAIN)
User ID	Enter SMTP user ID. (up to 63 characters)
Password	Enter SMTP password. (up to 63 characters)
POP server.....	Enter server name or IP address of the POP server. (up to 60 characters)
POP server port	Enter Port number of the POP server. (from 1 to 65535)

1 Setting SMTP server and administrator address

Enter the server name or IP address of the SMTP server*, the port number of the SMTP server and administrator address and click **Set** button. The administrator address is set to "Reply-To" address of the message sent from the projector.

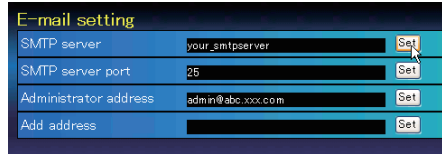

*1 The SMTP server is a server for sending e-mail. Please contact your network administrator to have this SMTP server address.

2 Registering and deleting E-mail addresses

Enter the e-mail address onto "Add e-mail address" and click **Set** button.



Check / Delete

To check the registered addresses, click **Check/Delete** sub menu tab. The addresses are listed as the figure on the right.

Up to 10 E-mail addresses can be registered.

To delete the registered addresses, check the address you want to delete and click **Delete** button.

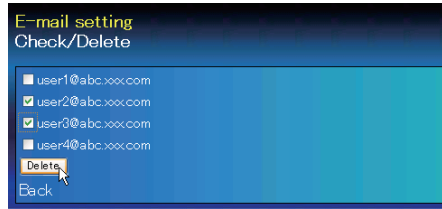

3 Setting SMTP authentication

Set the SMTP authentication concerned and click **Set** button. Please contact your network administrator in details.

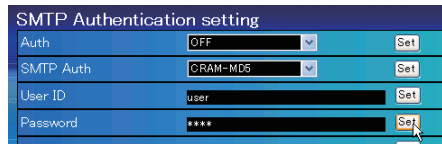

- If the projector sends an alert message due to the abnormality on the projector but the SMTP server is down in some other reason, the message will not be sent. In this case, the message "Unable to connect to server." will be displayed on the setting page. To clear this message, set up SMTP server address again.
- To use the E-Mail function, it must be set the DNS address on the Network setting page correctly.
- You cannot use this E-mail function if the DNS server and SMTP server cannot be used in your network environment.
- The projector does not send message to the address set in "Administrator address" text box. If you want to send e-mails to the administrator address, enter the administrator address into "Add address" text box.

4 Setting POP server

When "POP before SMTP" is selected at "Auth" of "SMTP Authentication setting", enter "POP server*2" and "POP server port" and click **Set** button.

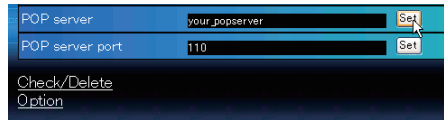

*2 The POP server is a server for receiving e-mail.
Please contact your network administrator to have this POP server address.

Error message for sending alert mail

When the projector has an abnormality, an alert message will be sent to the registered E-mail address.

If the SMTP server is missing or the authentication is not completed because of input error in E-mail address setting or SMTP authentication setting when sending alert e-mail, the error message will be displayed. Please check the respective settings.

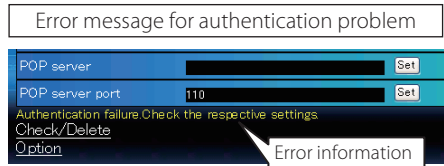
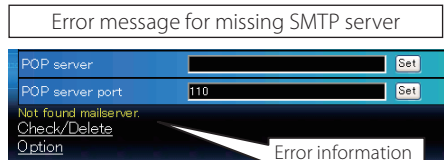

5 Option selection for sending alert mail

Click **Option** sub menu tab. Check the condition items under which alert mail will be sent and click **Set** button.

Please refer to item "Examples :Type and contents of alert mail" described on the next page.

Option

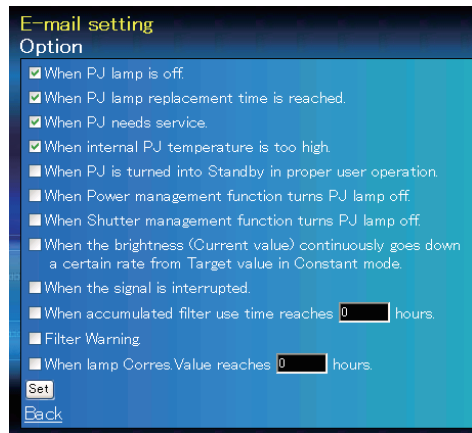

① "When PJ lamp is off" signifies the lamp goes out without user operation. "When PJ is turned into Standby in proper user operation" signifies that the projector is turned on by using the web browser and then it is turned into standby with ON/STANDBY button on the side control or the remote control.

② Up to 99,999 hours can be set for use time.

Examples: Type and contents of alert mail

When the projector has an abnormality, the following alert messages are sent to the registered E-mail address according to your selected condition. Administrator or user can take an efficient action quickly by receiving this message. This is very useful to maintain and service the projector.

The following are examples of received messages.

● When internal PJ temperature is too high:

TITLE: Message from projector
Projector Model Name: *model name*
TCP/IP: 192.168.1.201 Projector Name: Proj05

It sends you following message.

** The projector lamp is turned off, because internal temperature goes over the safety limit. Wait for the completion of the cooling process and make sure the projector has been turned into Standby. Then turn the projector on again. If the Indicator continues flashing, check the air filter for dust accumulation.*



● When PJ needs service:

**Maintenance requirement from Projector is detected. Check up LED status of projector and consult with the dealer.*

AD,	3.3V	OK
KS,	3.3V	OK
---	---	---
MAIN,	3.3V	NG
---	---	---



 The projector lamp was turned off, because the projector power circuit failed. Unplug the AC power cord and plug it, and then turn on the projector once again to verify operation. If the problem still persists, unplug the AC power cord and ask servicing to a qualified service personnel with the error information.

● When PJ lamp replacement time is reached:

**The projector lamp 1 has reached replacement time.
Lamp 1 ON 2000 h
Lamp 2 ON 1800 h*

 Replace it with a new lamp immediately and reset the lamp counter. If the projector is used without resetting the lamp counter, the alert mail is sent to users in every power-on of the projector. This alert mail will not be sent when unchecking the mail sending condition "When PJ lamp replacement time is reached".

● When the brightness (Current value) continuously goes down a certain rate from Target value in Constant mode:

**The brightness (Current value) continuously goes down a certain rate from the value in Constant mode. Check the lamp status and replace the lamp, or decrease Target value in Constant mode.*

 This alert mail will be sent when "Lamp mode" is set to "Constant mode".



SNMP setting

This projector provides a SNMP (Simple Network Management Protocol) agent function. The SNMP consists of a manager and agents. The group which communicates information each other with SNMP is called "Community". There are two access modes in a community, Refer (read only) and Set (read-write). This projector allows to use Refer (read only) only. The SNMP message informs the projector status called "Trap" to an administrator. Click **SNMP Setting** on the main menu and set up each item.

PJ information

Item	Description
Contact	Enter user name of the projector etc. (optional)
Place	Enter place of the projector (optional)
Community name(refer)	Enter community name (read only). Default name is "public".

Trap

Item	Description
Community name	Enter community name to send "Trap". Default name is "public".
Trap address	Enter IP address of the SNMP manager computer to receive "Trap".

Trap check/delete

Check and delete the trap address

Checking the registered trap address and deleting the address.

To delete the address, tick check box in front of the IP address and click **Delete** button.

✎ Up to 10 trap addresses can be registered.

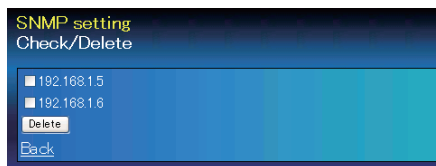

Trap option

Trap option setting

Tick check boxes in front of the condition item to send the trap.

✎ Click **Set** button if you tick or un-tick the check box on a page.

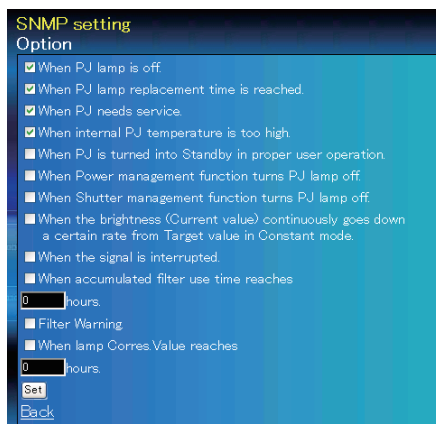

✎ "When PJ lamp is off" signifies the lamp goes out without user operation. "When PJ is turned into Standby in proper user operation" signifies that the projector is turned on by using the web browser and then it is turned into standby with ON/STANDBY button on the side control or the remote control.

✎ Up to 99,999 hours can be set for the time setting.

4

Chapter 4 *Controlling the Projector*

Describes controlling and setting of the projector by using the web browser.



Power control and status check

Click **Power & Status** on the main menu. The control page will be displayed.

By clicking **ON** or **Standby** button on the page, the power of the projector can be controlled.



Warning temperature icon

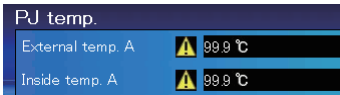

Popup confirmation window

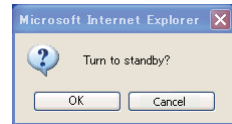

Item	Description
------	-------------

PJ status

- Power**Displays the status of the lamp. (ON, OFF, On starting up, On cooling down, Service in need)
- Status**Displays the status of the projector's power. (Refer to next page.)
- Power control**Controls the projector power by clicking the "ON" or "Standby" button.

PJ temp.

- External temp. A**..Displays the surrounding temperature of the intake vent.
- Inside temp. A**Displays the temperature inside of the projector.

* The warning icon will appear if the temperature exceeds a specified value. Check if there is no object to obstruct the airflow around the intake or exhaust vent. It might be airfilter clogged. Replace the airfilter with new one.

* The temperature unit can be set either Centigrade or Fahrenheit in the item "Initial Setting". (p.22)

- The projector cannot be turned on while the projector is on cooling down.
- The web browser checks and updates the projector's condition every 30 seconds automatically.

About projector condition

Status	Description
Normal.....	Projector is operating normally.
Power management in operation.....	Power management is operating
Shutter management in operation	Shutter management is operating
Lamp failure.....	Lamp failure is occurring
Abnormal temperature	The temperature of the projector became too high
Standby after Abnormal Temp.....	Projector detects abnormal temp. and sets into standby mode.
Power failure	Power failure has occurred inside the projector. Projector is turned off. Unplug the AC cord and ask servicing to a qualified service personnel.

When a security (PIN code lock) has been set on the projector, you also cannot control it through the network. To control the projector through the network temporarily, execute "PJ lock suspend" command to unlock the security. "PJ lock suspend" is on setting sub menu [3] on Setting main menu. (p.42)



Control

Click **Control** on the main menu. The setting method differs depending on the contents of the page. Click on the page number to change pages and select desired setting items.

Please see the owner's manual of the projector to have the further information of each control item.



Input

This function is to select the input mode and source mode of the projector. Click **Set** button after selecting the input and source mode.

Item	Description
Input.....	Selects input mode of the projector.
Source.....	Selects signal source of the input.
Input1 :	RGB(PC analog) RGB(PC Scart) RGB(PC digital) RGB(AV HDCP) HDMI
Input2 :	Video Y, Pb/Cb, Pr/Cr RGB S-video

The control page displays valid control items depending on the selected input mode, signal or functions of the projector you use, therefore, there may be different controls between the described items and actual control items on the page display. For further information , refer to the projector's owner's manual.

When the projector is in standby, all the controlling items are inactive.

System

This function is to select the system of signal input to the projector. The available system mode are listed on the pull-down menu button according to the input signal. Select a system and then click **Set** button.



Available selection at the RGB(PC analog) input

Item	Description
------	-------------

XGA1	It automatically switches to the proper computer system of the input signal. * The computer system modes (VGA, SVGA, XGA, SXGA, UXGA, WXGA...) which meet the input signal are listed.
------------	---

Available selection at the RGB(PC digital)/RGB(AV HDCP)/HDMI input

Item	Description
------	-------------

D-XGA.....	It automatically switches to the proper computer system of the input signal. * The computer system modes (D-VGA, D-SVGA, D-XGA, D-SXGA1...) which meet the input signal are listed.
D-480p	It automatically switches to the proper scanning system of the input signal. * The selectable scanning systems are D-480p, D-575p, D-720p, D-1035i, D-1080i and D-1080p.

Available selection at the Video/S-video/Scart input

Item	Description
------	-------------

AUTO.....	It automatically switches to the proper color system of the input signal. * The selectable color systems are PAL, SECAM, NTSC, NTSC4.43, PAL-M and PAL-N. * AUTO is fixed at the Scart input.
-----------	---

Available selection at the Component input

Item	Description
------	-------------

AUTO.....	It automatically switches to the proper scanning system of the input signal. * The selectable scanning systems are 480i, 575i, 480p, 575p, 720p, 1035i, 1080i and 1080p.
-----------	---

☞ If the mode (Mode1 to Mode10) which is stored in the item "PC Adjustment" (p.37) is available, they are also listed together with the above mode.

Image adjustment

This function is to adjust the projected picture image and save the image mode. To store the adjusted value, click **Store** button, and to load the adjusted value, click **Load** button.

Item	Description
Contrast.....	Adjusts picture contrast. (0~ 63)
Brightness.....	Adjusts picture brightness. (0~ 63)
Color.....	Adjusts picture color saturation. (0~ 63)
Tint.....	Adjusts picture hue. (0~ 63)
Color temp.....	Sets a color temperature mode. (X Low, Low, Mid, High, Adj.)

White Balance

Red, Green, Blue.....Adjusts each white balance respectively. (0~ 63)

* When changing the value of the white balance, the color temp. indicates "Adj."

Offset

Red, Green, Blue.....Adjusts each offset respectively. (0~ 63)

Auto picture control.....Sets auto picture control level. (OFF, L1, L2)

Advanced color.....Applies improved color adjustment with yellow light controller. (Auto, OFF)

Sharpness.....Adjusts picture sharpness. (0~ 31)

Gamma.....Adjusts brightness of darker part of the picture. (0~ 15)

Noise reduction.....Switches noise reduction mode (ON, OFF)

Progressive.....Switches progressive mode (OFF, ON, Film)

Reset.....Resets the Image adjustment to previous levels.

Store.....Stores the Image adjustment values. Select an item [Image1 - Image10] from the pull-down menu and click **Store** button.

Load Image mode.....Loads the Image mode. Select an image mode from the pull-down menu and click **Load** button. There may not be available mode depending on the input mode as shown in the table left.

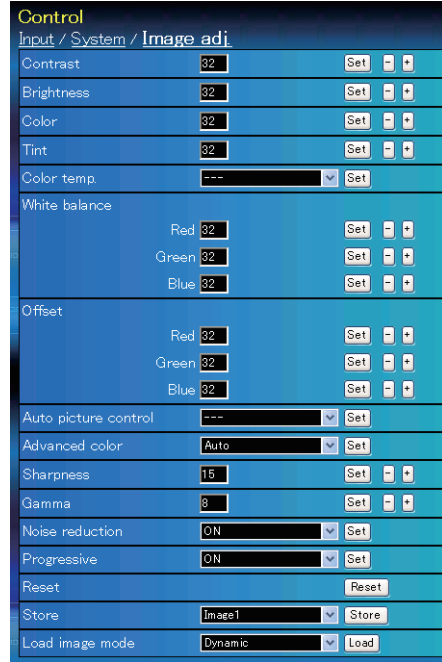

Input source Image mode	Video Computer	
	Video	Computer
Standard	✓	✓
Cinema	✓	*
Real	*	✓
Dynamic	✓	✓
Image1 - 10	✓	✓

* When Edge blending is set to "ON", Auto picture control and Advanced color are disable.

* When Color matching is set to "ON", Auto picture control, Advanced color, Color temp., White balance and Offset are disable.

☞ The mark "✓" means that the available image mode in the selected input source. The error message appears when selecting the disabled image mode indicated with "*".



PC adjustment

Click **PC Adj.** on the main menu. This function is to adjust the signal from the computer connected to the projector to obtain the proper picture image on the screen.



Item	Description
Current mode.....	Displays a current mode like VGA, SVGA, XGA, SXGA, UXGA, WXGA, etc. or Mode1 - Mode10 which are the customized mode created by using the "Mode Store" function described below.
Auto PC adj.....	Performs automatic adjustment.
Fine sync	Performs Fine Sync adjustment. (0 ~ 31)
Total dots	Adjust the number of total dots in the horizontal period.
Clamp.....	Adjusts the phase of the clamp.
Display area	
Horizontal.....	Adjusts the image area horizontally.
Vertical	Adjusts the image area vertically.
Position	
Horizontal.....	Adjusts the horizontal position of the screen.
Vertical	Adjusts the vertical position of the screen.
Reset.....	Resets the PC adjustments to the previous levels.
Mode Store.....	Stores the PC adjustment values. Select a mode no. [Mode1 - Mode10] from the pull-down menu.
Mode Free	Clear the PC adjustment values. Select a mode no. [Mode1 - Mode10] from the pull-down menu.



Setting up the projector

Click **Setting** on the main menu. This function is to set up the projector. Select the sub menu [Screen setting] or [Setting] and then set up each setting.



Screen setting

This function is to adjust the screen mode or the lens functions of the projector.

Item	Description
Screen	Switches the screen mode. (Normal, Full, Wide(16:9), Zoom, True, Natural wide, Custom)
Ceiling	Sets the image top/bottom and left/right reversed. (ON, OFF)
Rear	Sets the image left/right reversed. (ON, OFF)

* See the next page for the description of other functions.



Continue from the previous page.

Item	Description
Screen aspect	Sets the aspect ratio to fit the screen. (Full, 16:9, 16:10, 4:3) *Full is for flexible aspect ratio. *Some Screen settings are limited depending on the Screen aspect as shown in the below table.
Keystone.....	Corrects the keystone distortion of the projected image on the screen by pressing the Up/Down/Left/Right buttons. Click Reset to reset the keystone correction.
Digital zoom.....	Adjusts the image zoom in and out at computer input mode. Click OFF to return the image to its normal size.
Reset.....	Resets the settings of Screen, Ceiling, Rear, Screen aspect, Keystone and Digital zoom.



Lens adjustment

Item	Description
Zoom	Adjusts the image zoom in and out.
Focus.....	Adjusts the focus of the image.
Lens shift.....	Positions to the desired point by pressing the Up/Down/Left/Right buttons. Click Reset to return to the center position.
* Step(s).....	Sets the effective steps (1-20 steps) by one pressing the +/- or Up/Down/Left/Right buttons to adjust them quickly.

Screen Aspect	Full or 16:10		16:9		4:3	
	Video	PC	Video	PC	Video	PC
Normal	✓	✓	✓	✓	✓	✓
Full	✓	✓	✓	✓	✓	✓
Wide(16:9)	✓	✓	*1	*1	*3	✓
Zoom	✓	✓	✓	✓	✓	✓
True	*1	✓	*1	✓	*1	✓
Natural wide	*2	*1	*2	*1	*1	*1
Custom	✓	✓	✓	✓	✓	✓

☞ The mark "✓" means that the available screen mode in the selected input source system.

*1 The error message appears when selecting the disabled screen mode indicated with "*1".

*2 **Natural wide** cannot be selected when 720p, 1035i, 1080i, 1080p or 2K is selected in AV system menu.

*3 **Wide(16:9)** can be selected when the video signal is 2K.

Setting 1

Item	Description
Language.....	Sets the language display of projector's on-screen display menu.
Display.....	Switches on or off the on-screen menu display on the screen. (ON, Countdown off, OFF) Countdown off..... Displays input image instead the countdown during the startup.
Background.....	Sets the screen background when no signal input. (Blue, User, Black)
Lamp mode.....	Switches the lamp mode. {2-Lamps mode, 1-Lamp mode (Auto, Lamp1, Lamp2), Constant mode} * Auto Automatically selects a lamp with shorter cumulative use time. Constant mode..... Sets the desired Target brightness (up to 1024) to keep the brightness with modulating the lamp(s) or switching the lamp mode. The current brightness is shown in the Current box.
Lamp control.....	Selects lamp control mode. (Auto, Normal, Eco1, Eco2) * When constant mode is selected in "Lamp mode", this function is disable.
Lamp life control...	Selects lamp life control mode (Mode1, Mode2) when the total use time exceeds the recommended total hours of use.
Lamp interval.....	Sets the interval period of switching two lamps. (OFF, 24H, 200H, 500H, 1000H, 2000H) * OFF The lamp switching function is disable. * When constant mode is selected in "Lamp mode", this function is disable.
HDMI setup.....	Sets the digital RGB image level according to the HDMI source. (Normal, Enhanced)

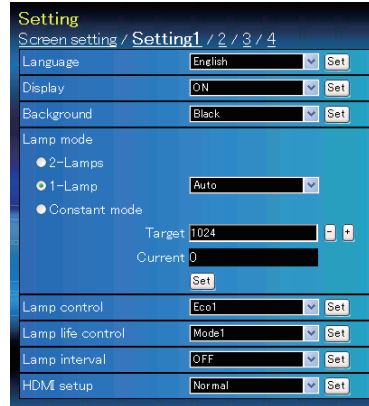

Setting 2

Item	Description
Picture in Picture...	Selects the Picture in Picture mode which has been preset in the setting menu of the projector. (OFF, User1 - User5) * The additional display items are as follows: Free No mode is stored. Stored... The mode is already stored. Adj..... The mode is not yet stored.
Mode.....	Selects the Picture in Picture mode. (P in P, P by P)
Main picture	Selects the input and signal source. Adjusts the size and position of the main picture.
Sub picture	Selects the input and signal source. Adjusts the size and position of the sub picture.
Frame lock.....	Selects the frame lock to main or sub picture. (Main picture, Sub picture)
Reset.....	Resets the settings of Picture in Picture mode.
Store	Stores the adjustment values. Select a mode no. [User1 - User5] from the pull-down menu.
Mode Free	Clear the adjustment values. Select a mode no. [User1 - User5] from the pull-down menu.

* **Step(s)**.....Sets the effective steps (1-20 steps) by one pressing the +/- or Up/Down/Left/Right buttons to adjust them quickly.

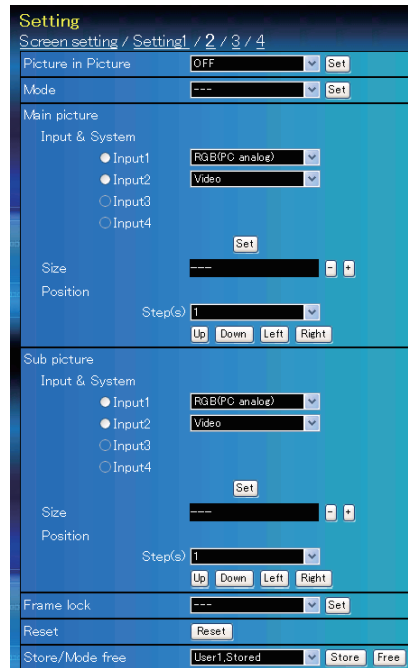

Setting 3

Item	Description
Edge blending.....	Sets the seamless overlapping for multi-screen. (ON, OFF)
Color matching ..	Corrects the details of color for multi-screen. (ON, OFF)
Logo	Sets on or off the logo display on the screen during the startup. (User, Default, OFF)
Filter control	Scroll the filter. Click "Roll-up", a confirmation display appears, and then click "OK", the filter will be scrolled.
Fan speed control...	Sets the running speed for the cooling fans. (Normal, Max)
Remote control....	Selects the remote control code. (Code1 - Code8)
Power management...	Sets into the selected power management mode (OFF, Ready, Shut down) if the input signal is interrupted and no control key is pressed for the specified period of time.

*The specified time can be set 1 to 30 min.

Direct on.....	Sets the power-on mode when the AC cord is connected to the outlet.
Key lock.....	Sets the prohibition of controls either Projector or Remote control. (OFF, Projector, Remote control)
PJ lock suspend...	When the projector has a security of PIN code lock, disable this function temporarily by pressing Execute button.

Setting procedure

1. Turn off the projector, disconnect AC cord from the outlet and then connect AC cord again.
2. Access this page with the web browser.
3. Click Execute button on the PJ lock suspend.

Shutter.....Sets the shutter operation. (ON: close, OFF: open)

Shutter management...Sets the shutter management operation.

Effect.....Sets the effect to fade in or out at opening or closing the shutter. (OFF, L1, L2)

Release key.....Sets available keys to release the shutter. (Any, SHUTTER)

Time.....Sets the specified period of time when the projector shuts down after the projector is left with the shutter closed.

* The specified time can be set 5 to 480 min.

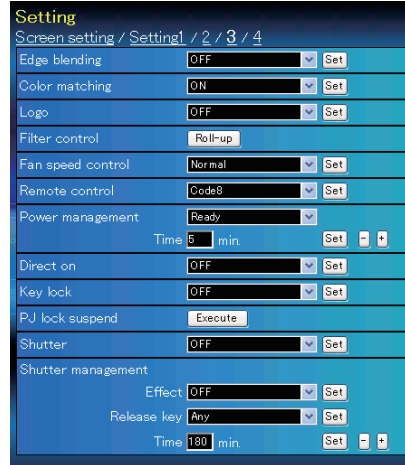

Setting 4

Item	Description
Video delay control	...Sets the digital processing of the image faster. (OFF, Low, Mid, High)
Closed caption	...Sets the closed caption function.
Closed caption	...Sets the closed caption mode. (OFF, CC1, CC2, CC3, CC4)
ColorSets the color of the contents. (Color, White)
Filter counter(h)	...Displays the filter counter. Reset the time after filter cartridge replacement. Click "Reset", a confirmation display appears, and then click "OK", the time will be reset. * Do not reset the Filter counter when the filter cartridge is not replaced.
Filter warningSets the time to indicate the filter warning message on the screen. (OFF, 400H, 700H, 1000H)
Scrolls remaining	...Displays the scrolls remaining of the filter. Reset the scroll counter after filter cartridge replacement. Click "Reset", a confirmation display appears, and then click "OK", the time will be reset. * Do not reset the Scrolls remaining when the filter cartridge is not replaced.
FreezeSets the image to freeze mode. (ON, OFF)
Test patternSets the preset image of the projector. (OFF, Color, Gradation 1 - Gradation4, All white, All black, Cross)
Factory default	...Sets all of the projector control items to the factory default setting except the following items. User Logo, Logo PIN code lock, PIN code lock, Lamp Corres. Value, Filter counter, PJ time, Network PIN code, Network setting * This function is not effective for the settings of Network address settings, e-mail settings, etc.

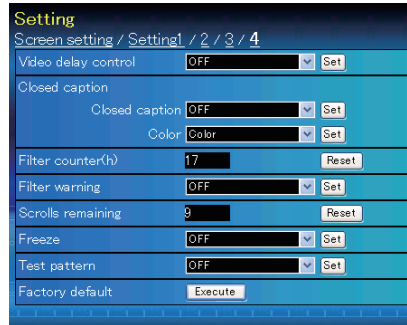



Information

This page is to display the basic information of the projector status. Click **Information** on the main menu.

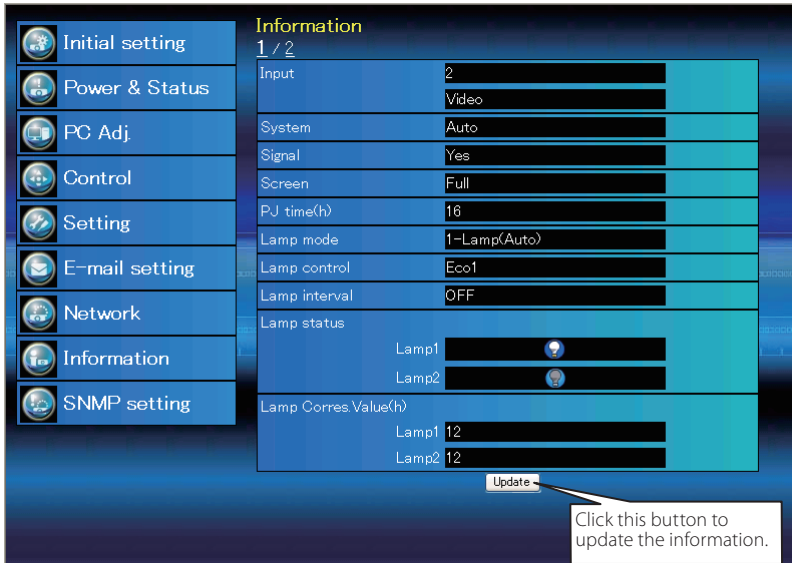

Information 1

Items	Description
Input.....	Displays selected input and source.
System.....	Displays selected signal system.
Signal.....	Input signal status (Yes, No)
Screen.....	Displays screen mode.
PJ time(h).....	Displays the accumulated use time of the projector.
Lamp mode.....	Displays the current "Lamp mode".
Lamp control.....	Displays the current "Lamp control".
Lamp interval.....	Displays the current "Lamp interval".
Lamp status.....	Displays the status of the 2 lamps with an icon. Refer to the table on page 46.
Lamp Corres. Value(h).....	Displays the use time (Corresponding value) of the 2 lamps.

* When PIP mode is active, displays **Input**, **System**, and **Screen** to "PIP mode".

Information 2



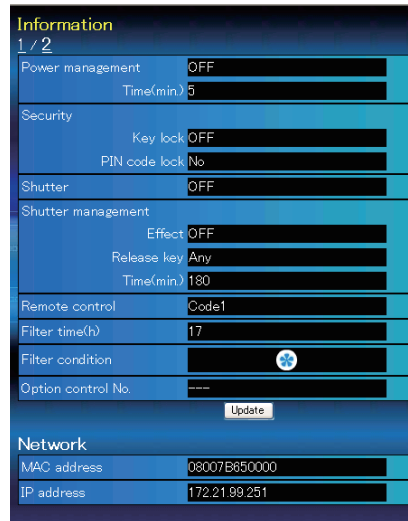



Item	Description
Power management.....	Displays the power management status.
Security.....	Displays the security (Key lock and PIN code lock) status.
Shutter.....	Displays the shutter status. (OFF: open, ON: close)
Shutter management.....	Displays the shutter management (Effect, Release key, Time) status.
Remote control.....	Displays the remote control code.
Filter time(h).....	Displays the accumulated use time of the filter.
Filter condition.....	Displays filter status with an icon. Refer to the table as shown in the next page.
Option control No.....	Displays the option control number for purchasing suitable optional terminal boards.





Network

Items	Description
MAC address.....	Displays MAC address of the projector.
IP address.....	Displays the IP address of the projector.

Indication of the lamp status

Icon display/background	Status
 White/Blue	Lamp on (Normal)
 White/Red	Lamp on (Lamp is being used over a specified use time, replace lamp immediately)
 Gray/Blue	Lamp off (Normal)
 Gray/Red	Lamp off (Lamp is being used over a specified use time, replace lamp immediately)
 Red/Blue with X	Lamp failure (Lamp failure, check lamp condition)
 Red/Red with X	Lamp failure (Lamp failure and lamp is being used over a specified use time, replace lamp immediately)

Indication of the filter status

Icon display/background	Status
 Blue	Good condition.
 Yellow/Gray	Filter is almost clogged.
 Red/Gray	Filter is clogged. Replace a filter with new one. * When the projector cannot decode the return from the filter cartridge, this icon also appears.

5

Chapter 5 *Appendix*

Connection examples

Use of telnet

Web browser setting

Q & A

Examples of connection

Peer-To-Peer connection

Connecting the projector (PJ01) to the control computer (PC05) directly.

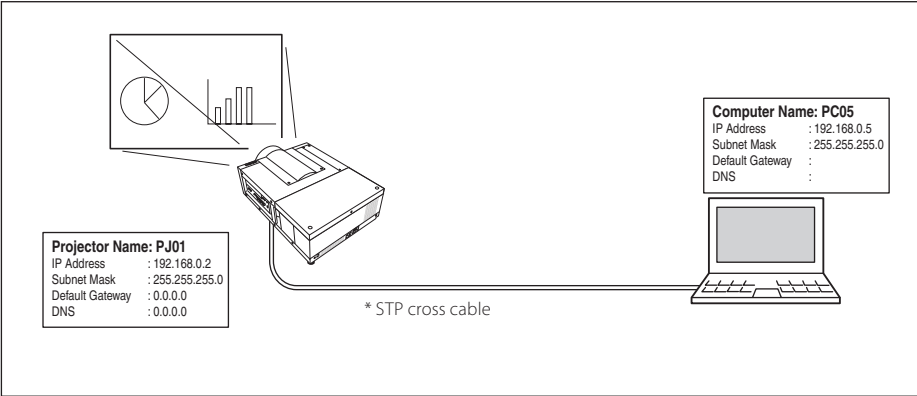

Connecting the projector (PJ01) to the control computer (PC05) via the hub.

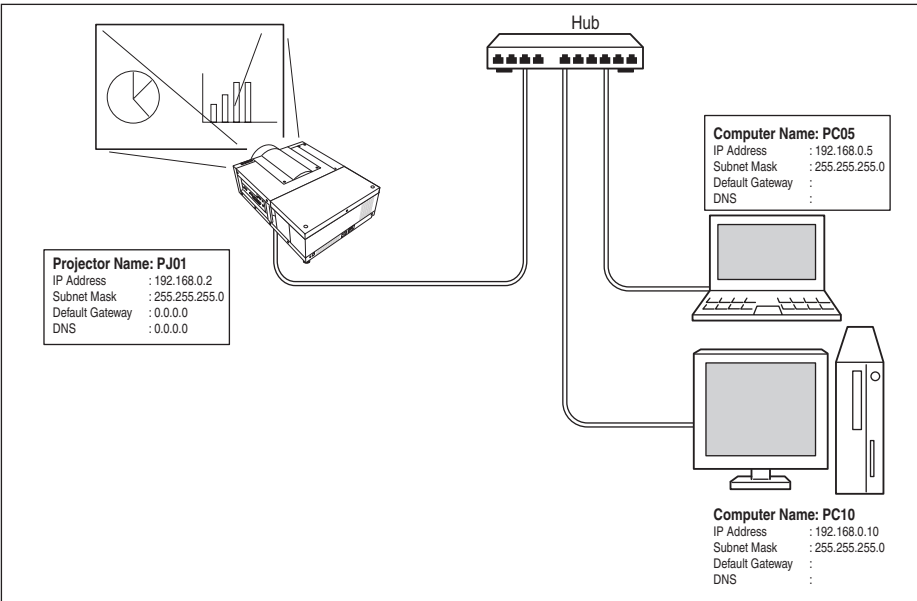

When the projector is connected to the computer directly without hub, the STP cross cable should be used.

The gateway (Router) installed in the network

Connecting the projector (PJ01) to the control computer (PC05) via the gateway.

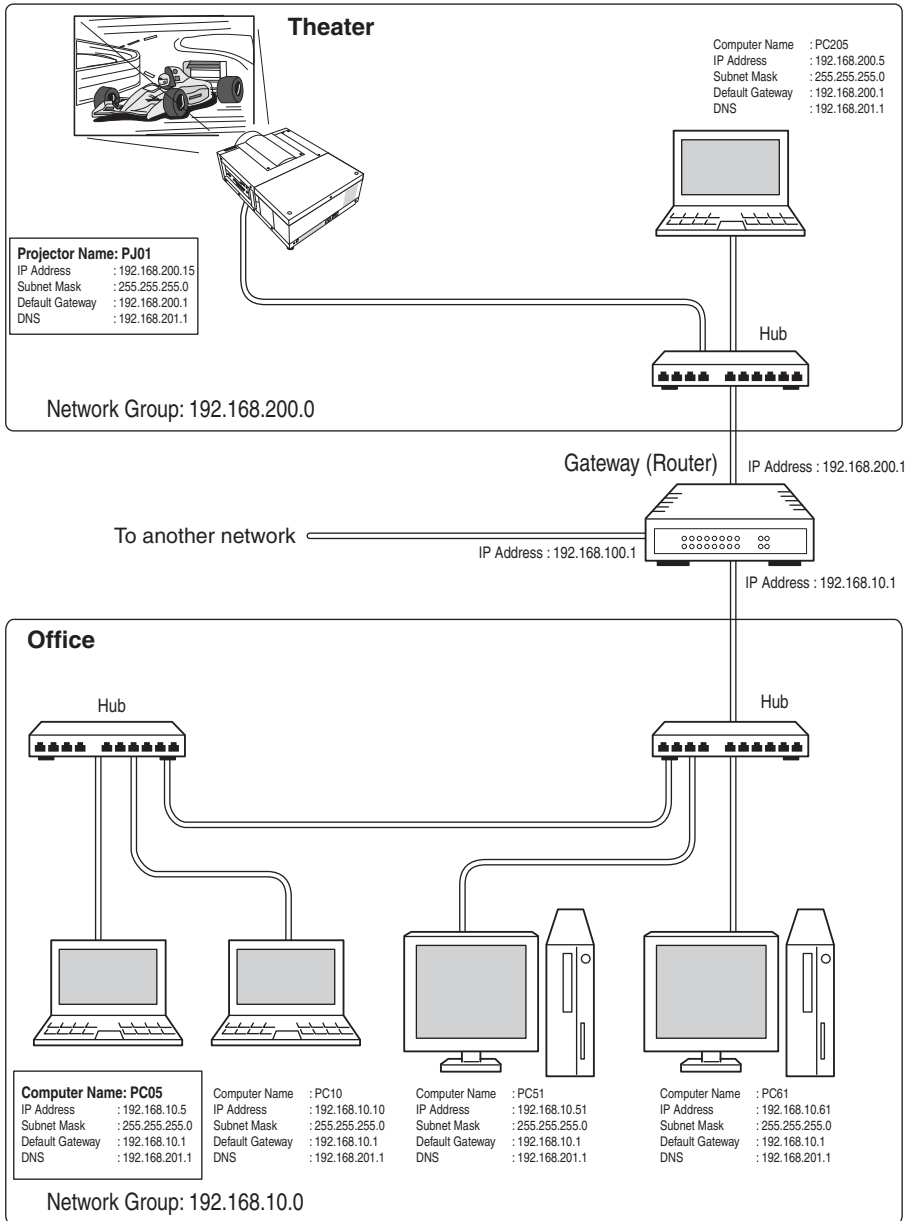

Use of telnet

You can control the projector by using the telnet application¹ installed on your computer. Normally, the telnet application is available on your computer.

* The telnet 10000 port is used to control the projector.

Control

(For example, in case of using the telnet application of **Windows XP Professional**.)

1. Select **Run...** submenu from **Start** menu on the computer. Type "telnet" onto the **Open** text area on the displayed window and press **OK** button.

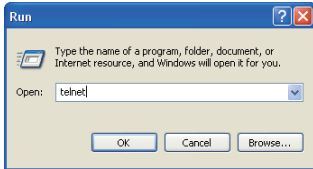

(For example, in case of using the telnet application of **Mac OS X v 10.4**)

1. Select **Terminal** from **Applications -->Utilities**.

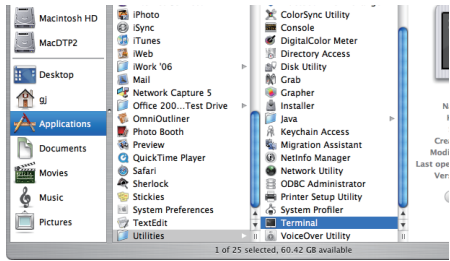

Type as below on the displayed window.
> telnet [return]

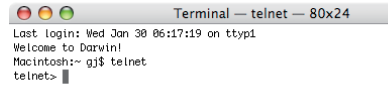

2. The telnet application will start and the following window will be displayed. Type as below to connect the projector.

> open 192.168.1.201 10000 [return]

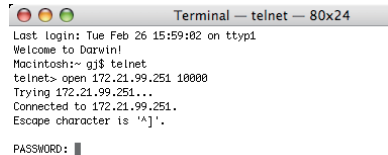
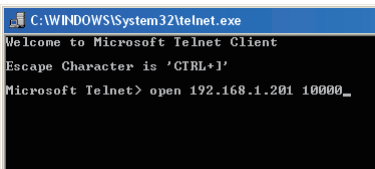

* Use the IP address assigned to the projector.

3. When communication is established correctly, the word "PASSWORD:" appears on the window. Type the login password (Network PIN code²) for the projector and then press "Enter" key on the keyboard. If you do not set up the Network PIN code, just press "Enter" key.

When the word "Hello" is replied, login has been succeeded.

* The password "1234" is used for the example.

```
Telnet 192.168.1.201
PASSWORD: 1*2*3*4*
Hello
|
```

```
Terminal — telnet — 80x24
Last login: Tue Feb 26 16:03:39 on ttty1
Welcome to Darwin!
Macintosh:~ gjs$ telnet
telnet> open 172.21.99.251 10000
Trying 172.21.99.251...
Connected to 172.21.99.251.
Escape character is '^['.
PASSWORD: 1234
Hello
|
```

4. Type the commands, refer to below table, to control the projector and then press "Enter" key for termination. For example, type "C00" which is a command to turn on the projector, and press "Enter" key. Confirm the projector is turning on.
- * Enter with ASCII 64-byte capital characters and one-byte characters.

To disconnect the communication, press "Ctrl" key and "]" key at the same time, type "close" and then press "Enter" key on the Keyboard.

> close [return]

The table below shows the typical command lists for controlling this projector and please consult your local dealer for further information of another commands.

Command list table

Command	Function
C00	Power on
C01	Power off
C05	Input 1
C06	Input 2
C07	Input 3
C08	Input 4
C1C	Menu display on
C1D	Menu display off

*1 Further instructions about the telnet application, please see the on-line guide on your computer.

*2 The password is a Network PIN code decided item "Network PIN code setting" (see pp.14, 23). If the authentication of the entered password is failed 4 times continuously, the communication will be disconnected automatically. Please try again for the connection.

☞ If the password or any command is not entered for more than 30 seconds, the communication will be disconnected automatically. Please try again for the connection.

Web browser setting

This projector is designed to be set up and controlled from an Internet web browser. Depending on the preference settings of the web browser, some control functions may not be available. Please make sure that the following functions are set up properly in the web browser.

Active Script/JavaScript enable

There are some control items used with the JavaScript function in the setting pages. If the web browser is set not to use this JavaScript function, it may not control the projector properly. In this case, the warning message "Make sure JavaScript is ON." will be displayed on the top of the page. To enable the JavaScript, please see further instructions on the next page.

Proxy setting

In some cases, your web browser is set up to use the proxy server for the internet or intranet connection. In this case, when you install this projector into the local network, you should set up the proxy setting of web browser preference correctly. Especially when connecting the projector and computer with a STP cross cable directly, or when the network does not provide the proxy server, make sure that "not use proxy server" is set up in your web browser preference. Please see item "Examples: OS/Browsers" in the next page for further setting up procedure.

 There are various ways to change your browser preferences depending on the version or applications. Please see the setting instructions on next page for example and also refer to on-line help of your web browser.

Examples: OS/Browsers

Windows XP Professional

Internet Explorer v.6.0

ActiveScript setting

Select **Internet Options** from **Tools** menu on the web browser and then select **Security** tab and click **Customize Level...** button. On the security setting window, scroll down and find the **Scripting** item, make sure that "Enable" is selected in item **Active Scripting**.

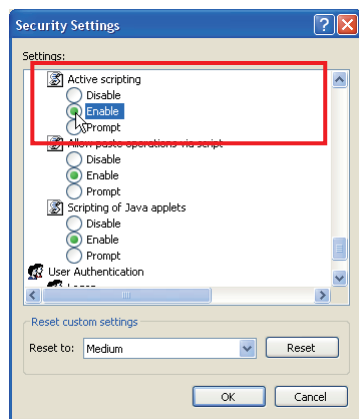
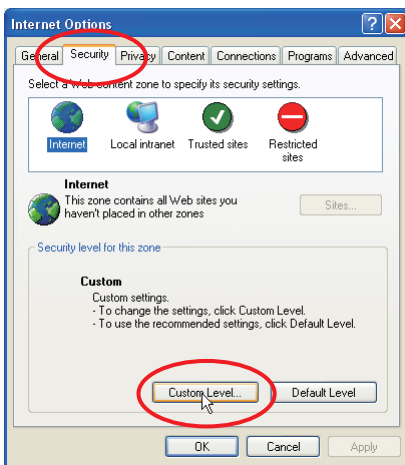

Proxy setting

Select **Internet Options** from **Tools** menu on the web browser and then select **Connection** tab and click **LAN Settings** button. Properly set up your web browser's the proxy server settings according to the local area network environment to which the projector is connected.

- Using proxy server

To use an external internet connection from the local area network, check the item **Use a proxy server** and enter the proxy server address and port correctly in the proxy settings window. For further instruction please consult your network administrator.

- Not using proxy server

Uncheck the item **Use a proxy server**.

If you connect the projector to the computer directly with STP cross cable, this must be unchecked.

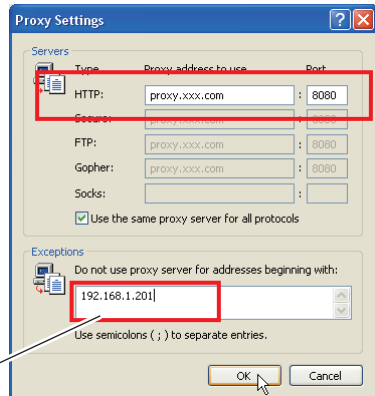
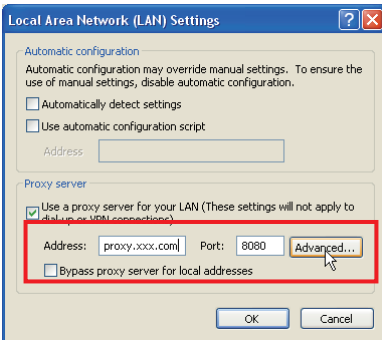

To designate proxy settings that will not use the proxy server when accessing the projector installed in the local area network, enter the IP address or domain name here.

Netscape Navigator v.7.1

JavaScript Setting

Select **Preference** from **Edit** menu on the web browser and then select the item **Advanced/Scripts & Plugins** in the **Category** column. Make sure that the **Enable JavaScript for Navigator** is checked.

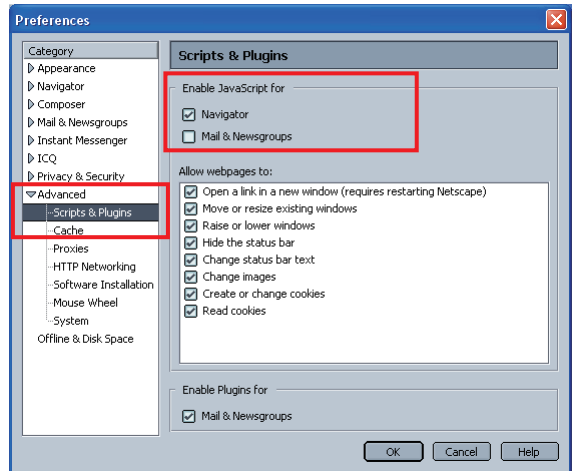

Proxy setting

Select **Preference** from **Edit** menu on the web browser and then select the item **Advanced/Proxies** in the **Category** column. Properly set up your web browser's the proxy server settings according to the local area network environment to which the projector is connected.

- Using proxy server

When you use an external internet connection from the local area network, select the item **Manual proxy configuration**. Enter the proxy server address and port number correctly on **HTTP Proxy** item. For further instruction please consult your network administrator.

- Not using proxy server

Select the item **Direct connection to the Internet** in the proxy setting window. If you connect the projector to the computer directly with STP cross cable, this must be selected.

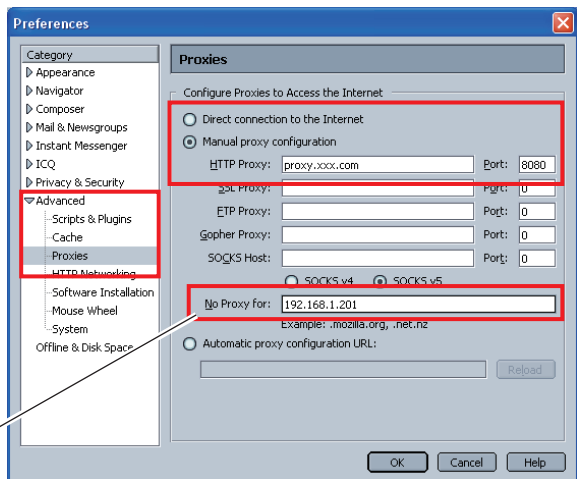

To designate proxy settings that will not use the proxy server when accessing the projector installed in the local area network, enter the IP address or domain name here.

MAC OS X v 10.4

Safari v.3.2.1

JavaScript enable setting

Select **Preferences...** from **Safari** on the web browser and then select **Security** tab and check **Enable JavaScript**.

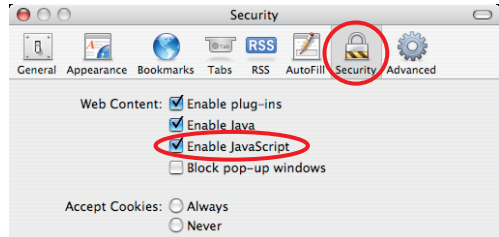

Proxy setting

- 1 Open **Preferences...** from **Safari** menu on the web browser **Safari**. The preference menu appears.
- 2 Select **Advanced** icon and then click **Proxies: Change Settings ...**
- 3 Select **Proxies** tab and properly set up your web browser **Safari**'s the proxy server settings according to the local area network environment to which the projector is connected.

- Using proxy server

To use an external internet connection from the local area network, check the items **Web Proxy (HTTP)** and **Secure Web Proxy (HTTPS)** of **Select a proxy server to configure** window and enter the proxy server address and port correctly in **Web Proxy Server** window. For further instruction please consult your network administrator.

- Not using proxy server

Uncheck the items **Web Proxy (HTTP)** and **Secure Web Proxy (HTTPS)** of **Select a proxy server to configure**. If you connect the projector to the computer directly with STP cross cable, they must be unchecked.

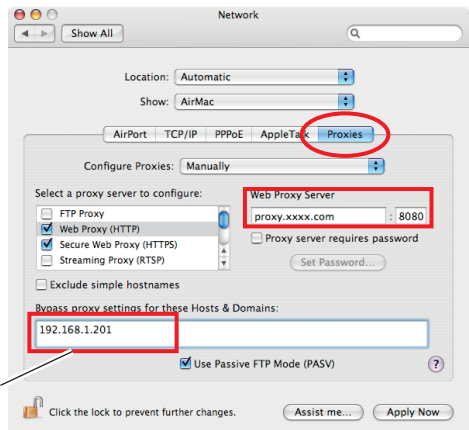
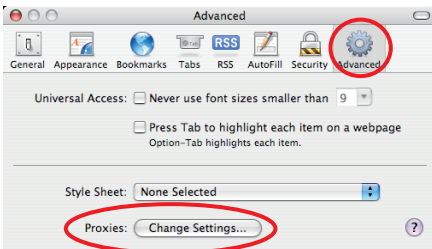

To designate proxy settings that will not use the proxy server when accessing the projector installed in the local area network, enter the IP address or domain name here.

Q&A

Installation/Access

Q *Why doesn't the setting page appear in my web browser?*

- A** Following causes are possible. Please check them.
1. The projector does not connect to the network.
Check LED indicators status (☞ p.12).
 - Check the connection of LAN cable if the LINK Lamp does not light green.
 - Check the network configuration of the projector if the ACT Lamp does not blink orange.
 2. Wrong network configuration of the computer.
Check the network configuration of the computer.
 3. The proxy setting of the web browser is not set correctly (☞ p.54).
 4. The computer does not provide TCP/IP protocol.

Q *How can I restrict access from the computer.*

- A**
1. Please use the password authentication function on the login page (☞ p.23).
 2. Please use the IP filtering function provided with the gateway (router) to restrict the accessing from the computer. For further information please consult your network administrator.

Q *Can I access the projector installed on the company's local area network from a remote location?*

- A** There are some ways to access to the projector in the LAN, but you must consult your network administrator for security reason.
- ☞ Use of modem
(Connect to the company's network from your home or some other places by using modem.)
 - ☞ Use of private line
(Connect to the company's network from the branch office or maintenance office by using private line.)
 - ☞ Use of internet
(Connect to the company's network from your home, branch office or some other places by using the internet.)

Q *We use the DHCP/BOOTP server to assign the IP address. Is it possible to use the projector in this network environment?*

A Possible. This projector supports the DHCP/BOOTP server. To use this projector in this network environment, set it up so that the DHCP/BOOTP server does not assign the IP address configured to this projector for another device on the network. Please consult your network administrator (☞ pp.13, 24).

Q *How can I install several projectors?*

A Install and configure network one by one to avoid the IP address collision each other. To configure the IP address please see item "Network configuration" (☞ pp.12-13, 24).

Password/Login

Q *What should I do when I forget the IP address of the projector?*

A You can check the IP address in the "Network information" menu.

Q *What should I do when I forget the password (Network PIN code)?*

A Please set the new network PIN code in the "Network PIN code" menu.

Q *Can I register the setting page as a web browser "Favorites" or "Bookmarks"?*

A Please add "Login" page to your "Favorites" or "Bookmarks". Do not add the specified setting page because it will not be able to perform the password authentication correctly.

Operation

Q *Why can't I change the controls in the setting page with web browser?*

A Please make sure the projector is turned on. If it is in the standby mode, the setting is not effective to the projector. To control the projector with a web browser, the projector must be in the powered-on condition.

Q *Why does it sometimes take a lot of time to complete the page display?*

A The display speed of the page depends on the network environment in which both the projector and computer are placed. It may take much time to complete the page display if network traffic is heavy. Please consult your network administrator.

Q *How many numbers of the E-mail address can I register in the E-mail setting page.*

A You can register up to 10 addresses.

Q *Why am I not receiving E-mail alert messages?*

A Make sure that the registered E-mail address and SMTP server address are correct. If the SMTP server is located in your LAN (Local Area Network), the address should be set to the SMTP server in your LAN. The SMTP server located outside of your LAN may not be available for security reason. For further information please contact your network administrator (☎ p.25).

Others

Q *What are the rules for IP address assignment?*

A If the network is constructed with TCP/IP protocol, a unique IP address is required for each piece of network equipment. The following are basic rules of the assignment.

Rule1

Do not configure the same IP address to the network equipment in the same network group. Each piece of equipment must be assigned a unique IP address.

If the IP address is set [192.168.x.x], the Subnet Mask should be set [255.255.255.0] for example.

Rule2

The start address [xxx.xxx.xxx.0] and the last address [xxx.xxx.xxx.255] of the IP address must not be assigned to any other equipment. These address numbers are reserved.

Rule3

The IP address must correlate to a network number. If network numbers are different between the equipment, they cannot establish communications each other. In this case, the router is placed in the networks to make the routing.

Q *Can I control the projector by using the telnet application?*

A Possible. Please refer to the item "Use of telnet" (☞ p.50 - 51).

Q *What is the MAC address assigned to the projector?*

A The MAC address is displayed in "Network information" menu of the projector (☞ p.14) and in "Information" menu through the web browser (☞ p.45).

Q *Can I update the firmware of the projector.*

A It is possible to update the firmware through the network. It is required to have a special tool for the updating. For further information please consult your local dealer. The version number of the firmware is indicated on the lower part of the "Initial setting" page.

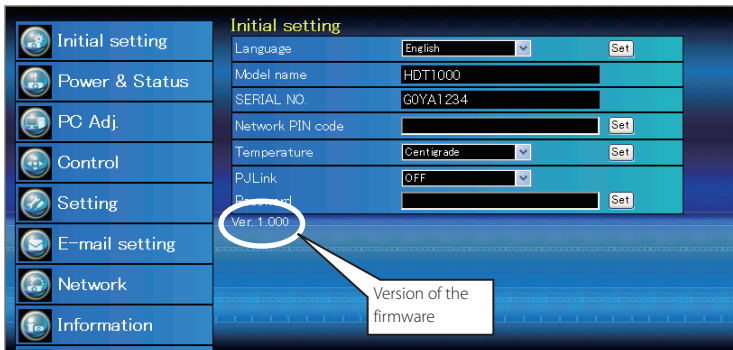

EIKI

Touchboards

205 Westwood Ave, Long Branch, NJ 07740

Phone: 866-94 BOARDS (26273) / (732)-222-1511

Fax: (732)-222-7088 | E-mail: sales@touchboards.com

WorldWide Website <http://www.eiki.com>