

# EIKI

MULTIMEDIA PROJECTOR

## MODEL LC-X85

# Touchboards

205 Westwood Ave, Long Branch, NJ 07740  
Phone: 866-94 BOARDS (26273) / (732)-222-1511  
Fax: (732)-222-7088 | E-mail: sales@touchboards.com

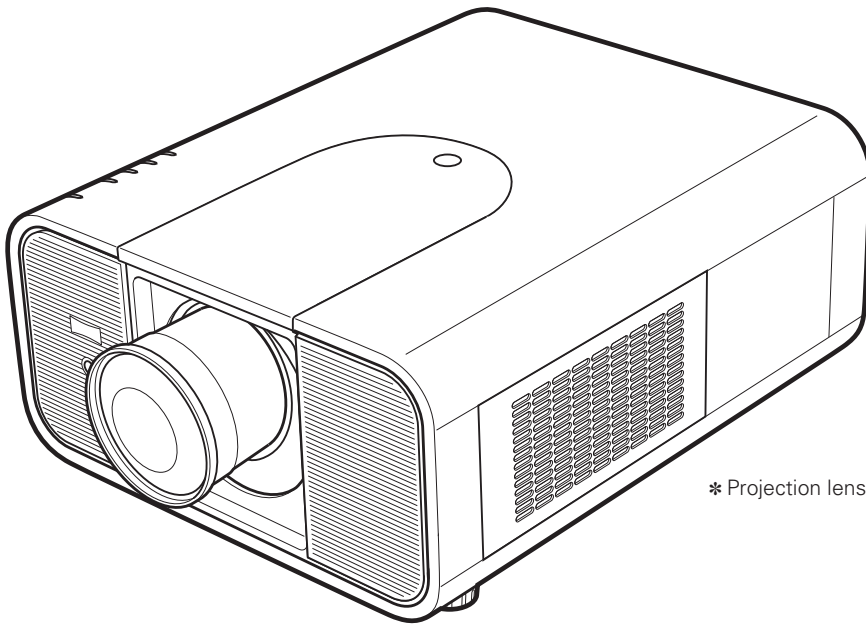

\* Projection lens is optional.

## OWNER'S MANUAL

**PJLink™**

# Features and Design

This Multimedia Projector is designed with most advanced technology for portability, durability, and ease of use. This projector utilizes built-in multimedia features, a palette of 1.07 billion colors, and matrix liquid crystal display (LCD) technology.

## ◆ **Functionally Rich**

This projector has many useful functions such as lens shifting, ceiling and rear projection, perpendicular omnidirectional projection, variety of lens options, etc.

## ◆ **Multi-use Remote Control**

Use the remote control as wired and wireless, or as a PC wireless mouse. Eight remote control codes and selectable pointer shapes are also available.

## ◆ **Simple Computer System Setting**

The projector has the Multi-scan system to conform to almost all computer output signals quickly (p.38). Supported resolution up to WUXGA.

## ◆ **Useful Functions for Presentation**

Digital zoom function allows you to focus on the crucial information during a presentation (pp.15, 44).

## ◆ **Security Function**

The Security function helps you to ensure security of the projector. With the Key lock function, you can lock the operation on the side control or remote control (p.57). PIN code lock functions prevents unauthorized use of the projector (pp.57–58).

## ◆ **Power Management**

The Power management function reduces power consumption and maintains lamp life (p.56).

## ◆ **Automatic Filter Replacement Function**

The projector monitors the condition of the filter and replaces a filter automatically when it detects the clogging.

## ◆ **Motor-driven Lens Shift**

Projection lens can be moved up, down, right and left with the motor-driven lens shift function. This function makes it easy to provide projected image where you want. Zoom and focus can also be adjusted with a motor-driven operation. (p.30)

## ◆ **Multilanguage Menu Display**

Operation menu is available in 12 languages; English, German, French, Italian, Spanish, Portuguese, Dutch, Swedish, Russian, Chinese, Korean, and Japanese (p.52).

## ◆ **Network-capable**

Through an optional Pj-to NetDirector, you can operate and control the projector.

## ◆ **Logo Function**

The Logo function allows you to customize the screen logo (pp.53–54). You can capture an image for the screen logo and use it for the starting-up display or between presentations.

## ◆ **Pointer Function**

Remote control pointer function. This function helps you to make a smart presentation on a projected screen.

## ◆ **Multiple Interface Terminals**

The projector has several interface terminals that can support various types of equipment and signals (pp.11-12).

## ◆ **Shutter Function**

The projector is equipped with the shutter that provides complete blackness when the projected image is not needed with keeping the projector on. The shutter management function allows you to set the timer. It prevents from keeping the projector on when the shutter is closed for a long time. (p.59)

## ◆ **New Optical Technology**

This projector is equipped with a new optical engine. The new optical engine controls the amount of yellow light in the image, producing higher brightness with improved color accuracy and clarity. (p.50)

### ✓ **Note:**

- The On-Screen Menu and figures in this manual may differ slightly from the product.
- The contents of this manual are subject to change without notice.

# Table of Contents

|   |           |   |           |
|---|-----------|---|-----------|
| <b>Features and Design</b> . . . . .              | <b>2</b>  | <b>Computer Input</b> . . . . .   | <b>38</b> |
| <b>Table of Contents</b> . . . . .                | <b>3</b>  | Computer System Selection   | 38        |
| <b>To The Owner</b> . . . . .                     | <b>4</b>  | Auto PC Adjustment  | 39        |
| <b>Safety Instructions</b> . . . . .              | <b>5</b>  | Manual PC Adjustment  | 40        |
| Air Circulation                                   | 6         | Image Level Selection   | 42        |
| Installing the Projector in Proper Directions     | 7         | Screen Size Adjustment  | 43        |
| Moving the Projector                              | 8         | <b>Video Input</b> . . . . .  | <b>45</b> |
| Cautions in Handling the Projector                | 8         | Video System Selection  | 45        |
| <b>Compliance</b> . . . . .                       | <b>9</b>  | Image Level Selection   | 46        |
| <b>Part Names and Functions</b> . . . . .         | <b>10</b> | Screen Size Adjustment  | 47        |
| Front   | 10        | <b>Picture Image</b> . . . . .  | <b>49</b> |
| Back  | 10        | Image Adjustment  | 49        |
| Bottom  | 10        | <b>Setting</b> . . . . .  | <b>52</b> |
| Rear Terminal                                     | 11        | Setting   | 52        |
| Rear Terminal                                     | 12        | <b>Maintenance and Care</b> . . . . .   | <b>61</b> |
| Side Control and Indicators                       | 13        | Filter Instructions   | 61        |
| Remote Control                                    | 14        | Replacing the Filter Cartridge  | 62        |
| Remote Control Battery Installation               | 16        | Resetting the Filter Counter  | 63        |
| Remote Control Receivers and Operating Range      | 16        | Resetting the Scroll Counter  | 63        |
| Wired Remote Control Transmitter                  | 16        | Lamp Replacement  | 64        |
| Remote Control Code                               | 17        | Resetting the Lamp Counter  | 65        |
| <b>Installation</b> . . . . .                     | <b>18</b> | Cleaning the Projection Lens  | 67        |
| Adjustable Feet                                   | 18        | Cleaning the Projector Cabinet  | 67        |
| Lens Installation                                 | 19        | Warning Indicators  | 68        |
| Connecting to a Computer (Digital and Analog RGB) | 22        | <b>Appendix</b> . . . . .   | <b>69</b> |
| Connecting to Video Equipment (Video, S-Video)    | 23        | Troubleshooting   | 69        |
| Connecting for Audio Signal                       | 24        | Menu Tree   | 72        |
| Connecting the AC Power Cord                      | 25        | Indicators and Projector Condition  | 75        |
| <b>Basic Operation</b> . . . . .                  | <b>26</b> | Compatible Computer Specifications  | 78        |
| Turning On the Projector                          | 26        | Technical Specifications  | 80        |
| Turning Off the Projector                         | 27        | Optional Parts  | 81        |
| How to Operate the On-Screen Menu                 | 28        | Lens Replacement  | 81        |
| Menu Bar  | 29        | PJ Link Notice  | 81        |
| Operating with Projector Control                  | 30        | Configurations of Terminals   | 82        |
| Sound Adjustment                                  | 31        | PIN Code Number Memo  | 83        |
| Operating with Remote Control                     | 32        | Dimensions  | 84        |
| Pointer Function                                  | 34        | Serial Control Interface  | 85        |
| Wireless Mouse Operation                          | 34        | <b>Trademarks</b>   |           |
| <b>Input Selection</b> . . . . .                  | <b>35</b> | Each name of corporations or products in this book is either a registered trademark or a trademark of its respective corporation. |           |
| Input   | 35        |   |           |
| Computer Input Source Selection                   | 36        |   |           |
| Video Input Source Selection                      | 37        |   |           |





# To The Owner

Before installing and operating the projector, read this manual thoroughly.

The projector provides many convenient features and functions. Operating the projector properly enables you to manage those features and maintains it in good condition for many years to come.

Improper operation may result in not only shortening the product life, but also malfunctions, fire hazard, or other accidents.

If your projector seems to operate improperly, read this manual again, check operations and cable connections and try the solutions in the "Troubleshooting" section in the back of this manual. If the problem still persists, contact the dealer where you purchased the projector or the service center.

|   |
|---|
|  <div style="border: 1px solid black; padding: 5px; text-align: center;"><b>CAUTION</b><br/><b>RISK OF ELECTRIC SHOCK</b><br/><b>DO NOT OPEN</b></div>  |
| <b>CAUTION: TO REDUCE THE RISK OF ELECTRIC SHOCK, DO NOT REMOVE COVER (OR BACK). NO USER-SERVICEABLE PARTS INSIDE EXCEPT LAMP REPLACEMENT. REFER SERVICING TO QUALIFIED SERVICE PERSONNEL.</b>  |
|  THIS SYMBOL INDICATES THAT DANGEROUS VOLTAGE CONSTITUTING A RISK OF ELECTRIC SHOCK IS PRESENT WITHIN THIS UNIT.   |
|  THIS SYMBOL INDICATES THAT THERE ARE IMPORTANT OPERATING AND MAINTENANCE INSTRUCTIONS IN THE OWNER'S MANUAL WITH THIS UNIT.   |

The symbol mark and recycling systems described below apply to EU countries and do not apply to countries in other areas of the world.

Your product is designed and manufactured with high quality materials and components which can be recycled and/or reused.

The symbol mark means that electrical and electronic equipment, batteries and accumulators, at their end-of-life, should be disposed of separately from your household waste.

Note:

If a chemical symbol is printed beneath the symbol mark, this chemical symbol means that the battery or accumulator contains a heavy metal at a certain concentration. This will be indicated as follows: Hg: mercury, Cd: cadmium, Pb: lead  
In the European Union there are separate collection systems for used electrical and electronic equipment, batteries and accumulators.

Please, dispose of them correctly at your local community waste collection/recycling centre.

Please, help us to conserve the environment we live in!



**READ AND KEEP THIS OWNER'S MANUAL FOR LATER USE.**



## Safety Precaution

**WARNING: ● THIS APPARATUS MUST BE EARTHED.**

**● TO REDUCE THE RISK OF FIRE OR ELECTRIC SHOCK, DO NOT EXPOSE THIS APPLIANCE TO RAIN OR MOISTURE.**

- This projector produces intense light from the projection lens. Do not stare directly into the lens, otherwise eye damage could result. Be especially careful that children do not stare directly into the beam.
- Install the projector in a proper position. Otherwise it may result in a fire hazard.
- Allowing the proper amount of space on the top, sides, and rear of the projector cabinet is critical for proper air circulation and cooling of the unit. The diagrams shown here indicates the minimum space required. If the projector is to be built into a compartment or similarly enclosed, these minimum distances must be maintained.
- Do not cover the ventilation slots on the projector. Heat build-up can reduce the service life of your projector, and can also be dangerous.

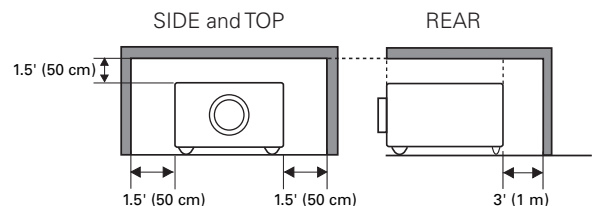

- If the projector is unused for an extended time, unplug the projector from the power outlet.
- Do not project the same image for a long time. The afterimage may remain on the LCD panels by the characteristic of panel.



### CAUTION ON HANGING FROM THE CEILING

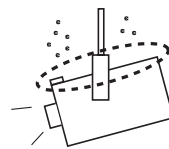

When hanging the projector from the ceiling, clean the air intake vents and top of the projector periodically with a vacuum cleaner. If you leave the projector unclean for a long time, the cooling fans can be clogged with dust, and it may cause a breakdown or a disaster.

**DO NOT SET THE PROJECTOR IN GREASY, WET, OR SMOKY CONDITIONS SUCH AS IN A KITCHEN TO PREVENT A BREAKDOWN OR A DISASTER. IF THE PROJECTOR COMES IN CONTACT WITH OIL OR CHEMICALS, IT MAY BECOME DETERIORATED.**

### CAUTION

Not for use in a computer room as defined in the Standard for the Protection of Electronic Computer/Data Processing Equipment, ANSI/NFPA 75.

Ne peut être utilisé dans une salle d'ordinateurs telle que définie dans la norme ANSI/NFPA 75 Standard for Protection of Electronic Computer/Data Processing Equipment.

# Safety Instructions

All the safety and operating instructions should be read before the product is operated.

Read all of the instructions given here and retain them for later use. Unplug this projector from AC power supply before cleaning. Do not use liquid or aerosol cleaners. Use a damp cloth for cleaning.

Follow all warnings and instructions marked on the projector.

For added protection to the projector during a lightning storm, or when it is left unattended and unused for long periods of time, unplug it from the wall outlet. This will prevent damage due to lightning and power line surges.

---

Do not expose this unit to rain or use near water... for example, in a wet basement, near a swimming pool, etc...

Do not use attachments not recommended by the manufacturer as they may cause hazards.

Do not place this projector on an unstable cart, stand, or table. The projector may fall, causing serious injury to a child or adult, and serious damage to the projector. Use only with a cart or stand recommended by the manufacturer, or sold with the projector. Wall or shelf mounting should follow the manufacturer's instructions, and should use a mounting kit approved by the manufacturers.

An appliance and cart combination should be moved with care. Quick stops, excessive force, and uneven surfaces may cause the appliance and cart combination to overturn.



---

Slots and openings in the back and side of the cabinet are provided for ventilation, to ensure reliable operation of the equipment and to protect it from overheating.

The openings should never be covered with cloth or other materials, and the bottom opening should not be blocked by placing the projector on a bed, sofa, rug, or other similar surface. This projector should never be placed near or over a radiator or heat register.

This projector should not be placed in a built-in installation such as a book case unless proper ventilation is provided.

Never push objects of any kind into this projector through cabinet slots as they may touch dangerous voltage points or short out parts that could result in a fire or electric shock. Never spill liquid of any kind on the projector.

Do not install the projector near the ventilation duct of air-conditioning equipment.

This projector should be operated only from the type of power source indicated on the marking label. If you are not sure of the type of power supplied, consult your authorized dealer or local power company.

Do not overload wall outlets and extension cords as this can result in fire or electric shock. Do not allow anything to rest on the power cord. Do not locate this projector where the cord may be damaged by persons walking on it.

Do not attempt to service this projector yourself as opening or removing covers may expose you to dangerous voltage or other hazards. Refer all servicing to qualified service personnel.

Unplug this projector from wall outlet and refer servicing to qualified service personnel under the following conditions:

- a. When the power cord or plug is damaged or frayed.
- b. If liquid has been spilled into the projector.
- c. If the projector has been exposed to rain or water.
- d. If the projector does not operate normally by following the operating instructions. Adjust only those controls that are covered by the operating instructions as improper adjustment of other controls may result in damage and will often require extensive work by a qualified technician to restore the projector to normal operation.
- e. If the projector has been dropped or the cabinet has been damaged.
- f. When the projector exhibits a distinct change in performance-this indicates a need for service.

When replacement parts are required, be sure the service technician has used replacement parts specified by the manufacturer that have the same characteristics as the original part. Unauthorized substitutions may result in fire, electric shock, or injury to persons.

Upon completion of any service or repairs to this projector, ask the service technician to perform routine safety checks to determine that the projector is in safe operating condition.

---

## NOTE FOR CUSTOMERS IN THE US

 LAMP(S) INSIDE THIS PRODUCT CONTAIN MERCURY AND MUST BE RECYCLED OR DISPOSED OF ACCORDING TO LOCAL, STATE OR FEDERAL LAWS.

# Safety Instructions

## Air Circulation

Openings in the cabinet are provided for ventilation. To ensure reliable operation of the product and to protect it from overheating, these openings must not be blocked or covered.

### CAUTION

Hot air is exhausted from the exhaust vent. When using or installing the projector, the following precautions should be taken.

- Do not put any flammable object or spray can near the projector, hot air is exhausted from the air vents.
- Keep the exhaust vent at least 3' (1 m) away from any objects.
- Do not touch peripheral parts of the exhaust vent, especially screws and metallic parts. These areas will become hot while the projector is being used.
- Do not put anything on the cabinet. Objects put on the cabinet will not only get damaged but also may cause fire hazard by heat.

Cooling fans are provided to cool down the projector. The fans' running speed is changed according to the temperature inside the projector.

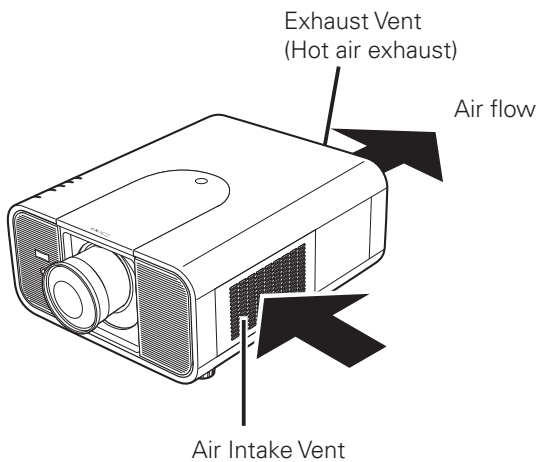

## IMPORTANT!

### Filter Maintenance!!

The projector uses a lamp which generates significant heat. The cooling fans and air vents are provided to dissipate the heat by drawing air into the housing and the filter is located in the intake vents to prevent dust from getting inside of the projector.

In order to care for the projector appropriately, regular cleaning is required. Remove any dirt or dust that has accumulated on the projector.

If the projector reaches a time set in the timer setting, a Filter replacement icon (Fig. 1) appears on the screen and WARNING FILTER indicator on the top panel lights up (see below), indicating that the filter replacement is necessary.

If the projector detects that the filter is clogged and no scroll is left in the filter cartridge, a Filter cartridge replacement icon (Fig. 2) appears on the screen and WARNING FILTER indicator on the top panel lights up (see below). Stop using the projector immediately and replace the filter cartridge.

Blocking the air vents and leaving the projector uncleaned for a long time may not only damage the projector and may require costly repairs but may also cause accidents or fire.

For maintenance of the filter, refer to "Filter counter" on page 60 and "Maintenance and Care" on pages 61-63.

**Damages to the projector caused by using an uncleaned filter or improper maintenance will void the warranty on the projector.**

### Top Panel

LAMP / SHUTTER 

LAMP REPLACE 

WARNING FILTER 

WARNING TEMP. 

**WARNING FILTER indicator**



**Fig.1** Filter replacement icon



**Fig.2** Filter cartridge replacement icon

## Installing the Projector in Proper Directions

Use the projector properly in specified positions. Improper positioning may reduce the lamp life and result in severe accident or fire hazard.

This projector can project the picture in upward, downward, or inclined position in perpendicular direction to the horizontal plane. When installing the projector in downwardly inclined position, install the projector bottom side up.

**✓ Note:**

- To inverse or reverse the image, set the ceiling function to "On." (pp. 44, 48)

## Positioning Precautions

Avoid positioning the projector as described below when installing.

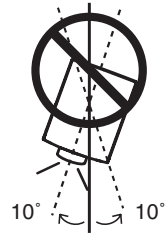
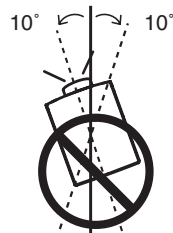
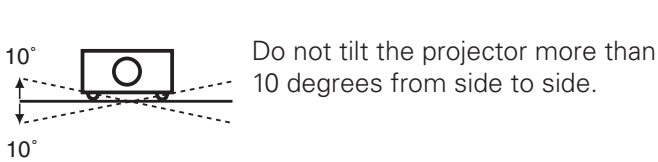

### CAUTION ON CEILING MOUNTING

For ceiling mounting, you need the ceiling mount kit designed for this projector. When not mounted properly, the projector may fall, causing hazards or injury. For details, consult your dealer. The warranty on this projector does not cover any damage caused by use of any non-recommended ceiling mount kit or installation of the ceiling mount kit in an improper location.



# Safety Instructions

## Moving the Projector

Use the handle grip when moving the projector.

Retract the adjustable feet to prevent damage to the lens and cabinet when carrying.

When this projector is not in use for an extended period, put it into a suitable case to protect the projector.



### CAUTION IN CARRYING OR TRANSPORTING THE PROJECTOR

- Do not drop or bump the projector, otherwise damages or malfunctions may result.
- When carrying the projector, use a suitable carrying case.
- Do not transport the projector by courier or any other transport service in an unsuitable transport case. This may cause damage to the projector. For information about transporting the projector by courier or any other transport service, consult your dealer.
- Do not put the projector in a case before it is cooled enough.

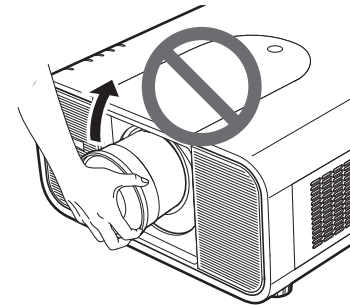
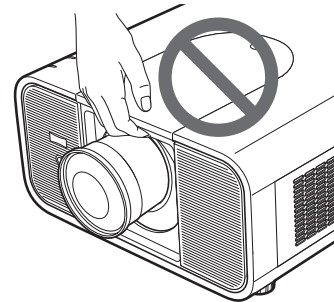
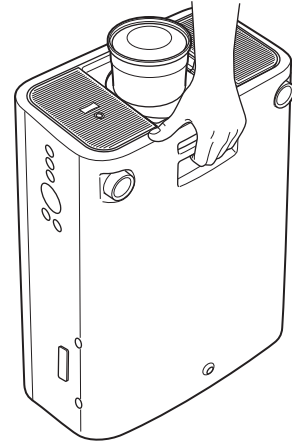

## Cautions in Handling the Projector

Do not hold the lens or the top cover when lifting or moving the projector. Doing so may cause damage to the lens and the projector.

Care must be taken when handling the projector; do not drop, bump, subject it to strong forces, or put other things on the cabinet.

Do not hold the lens and the peripheral part.



### CAUTION

Projection lens is a motorized lens. Please note the followings when using the projector.



- Do not touch the lens while it is moving as this could cause injury to the fingers.
- Never allow children to touch the lens.

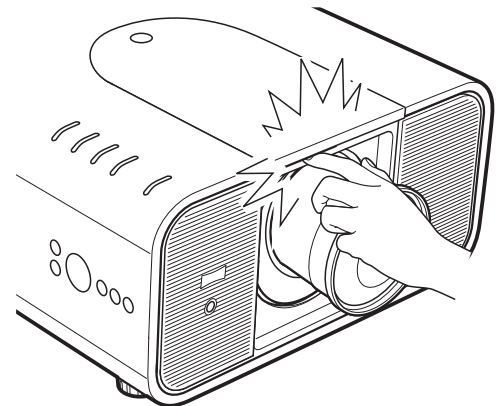



# Compliance

## Federal Communications Commission Notice

Note: This equipment has been tested and found to comply with the limits for a Class B digital device, pursuant to Part 15 of the FCC Rules. These limits are designed to provide reasonable protection against harmful interference in a residential installation. This equipment generates, uses and can radiate radio frequency energy and, if not installed and used in accordance with the instructions, may cause harmful interference to radio communications. However, there is no guarantee that interference will not occur in a particular installation. If this equipment does cause harmful interference to radio or television reception, which can be determined by turning the equipment off and on, the user is encouraged to try to correct the interference by one or more of the following measures:

- Reorient or relocate the receiving antenna.
- Increase the separation between the equipment and receiver.
- Connect the equipment into an outlet on a circuit different from that to which the receiver is connected.
- Consult the dealer or an experienced radio/TV technician for help.

Use of shielded cable is required to comply with class B limits in Subpart B of Part 15 of FCC Rules.

Do not make any changes or modifications to the equipment unless otherwise specified in the instructions. If such changes or modifications should be made, you could be required to stop operation of the equipment.

Model Number : LC-X85  
Trade Name : EIKI  
Responsible party : EIKI International, Inc.  
Address : 30251 Esperanza Rancho Santa Margarita CA 92688-2132 U.S.A.  
Telephone No. : 800-242-3454 (949-457-0200)

## AC Power Cord Requirement

The AC Power Cord supplied with this projector meets the requirement for use in the country you purchased it.

### AC Power Cord for the United States and Canada:

AC Power Cord used in the United States and Canada is listed by the Underwriters Laboratories (UL) and certified by the Canadian Standard Association (CSA).

AC Power Cord has a grounding-type AC line plug. This is a safety feature to be sure that the plug will fit into the power outlet. Do not try to defeat this safety feature. Should you be unable to insert the plug into the outlet, contact your electrician.



### AC Power Cord for the United Kingdom:

This cord is already fitted with a moulded plug incorporating a fuse, the value of which is indicated on the pin face of the plug. Should the fuse need to be replaced, an ASTA approved BS 1362 fuse must be used of the same rating, marked thus  $\diamond$ . If the fuse cover is detachable, never use the plug with the cover omitted. If a replacement fuse cover is required, ensure it is of the same colour as that visible on the pin face of the plug (i.e. red or orange). Fuse covers are available from the Parts Department indicated in your User Instructions.

If the plug supplied is not suitable for your socket outlet, it should be cut off and destroyed.

The end of the flexible cord should be suitably prepared and the correct plug fitted. (See Over)

**WARNING: A PLUG WITH BARED FLEXIBLE CORD IS HAZARDOUS IF ENGAGED IN A LIVE SOCKET OUTLET.**

The Wires in this mains lead are coloured in accordance with the following code:

Green-and-yellow ..... Earth  
Blue ..... Neutral  
Brown ..... Live

As the colours of the wires in the mains lead of this apparatus may not correspond with the coloured markings identifying the terminals in your plug proceed as follows:

The wire which is coloured green-and-yellow must be connected to the terminal in the plug which is marked by the letter E or by the safety earth symbol  $\perp$  or coloured green or green-and-yellow.

The wire which is coloured blue must be connected to the terminal which is marked with the letter N or coloured black.

The wire which is coloured brown must be connected to the terminal which is marked with the letter L or coloured red.

**WARNING: THIS APPARATUS MUST BE EARTHED.**

**THE SOCKET-OUTLET SHOULD BE INSTALLED NEAR THE EQUIPMENT AND EASILY ACCESSIBLE.**

# Part Names and Functions

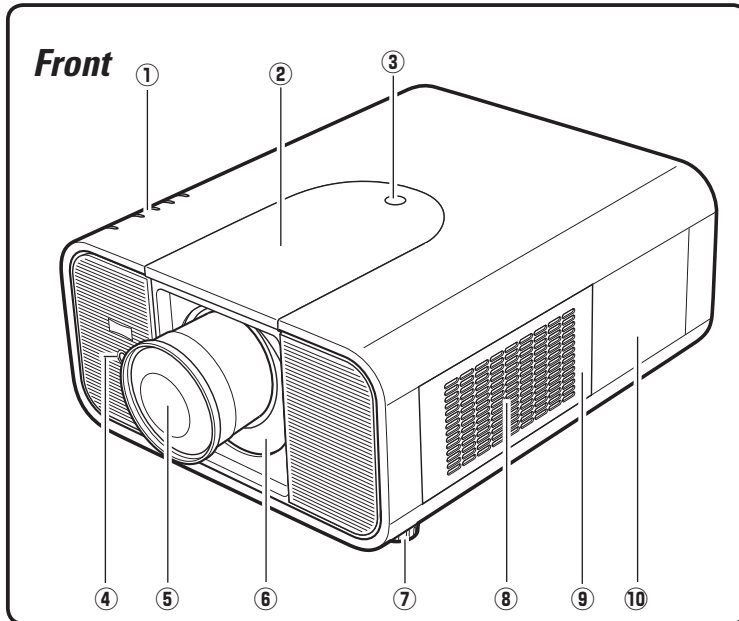

- ① Indicators
- ② Top Cover
- ③ Top Cover Release Button
- ④ Infrared Remote Receiver (Front)
- ⑤ Projection Lens (optional)
- ⑥ Light-Block Sheet
- ⑦ Adjustable Feet
- ⑧ Air Intake Vent
- ⑨ Filter Cover
- ⑩ Lamp Cover
- ⑪ Exhaust Vent

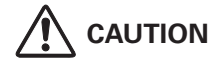

Hot air is exhausted from the exhaust vent. Do not put heat-sensitive objects near this side.

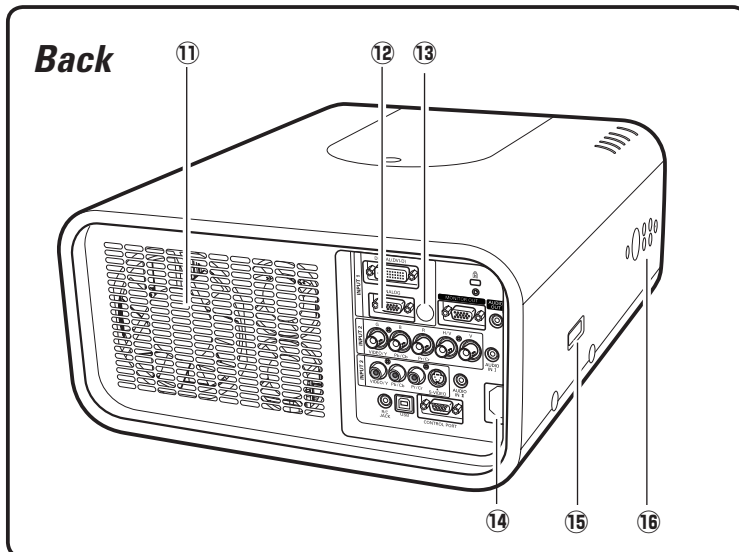

- ⑫ Terminals and Connectors
- ⑬ Infrared Remote Receiver (Back)
- ⑭ Power Cord Connector
- ⑮ Optional Parts Attachment
- ⑯ Side Controls
- ⑰ Hand Grip

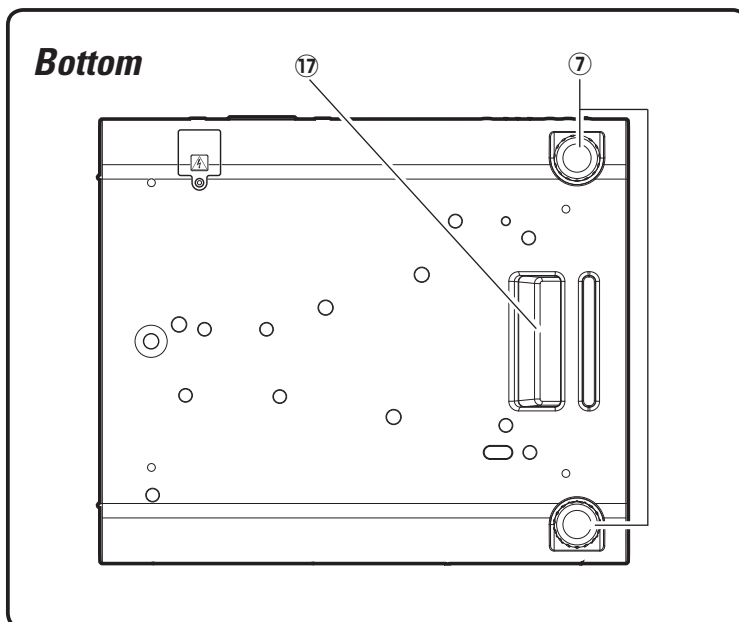

**Rear Terminal**

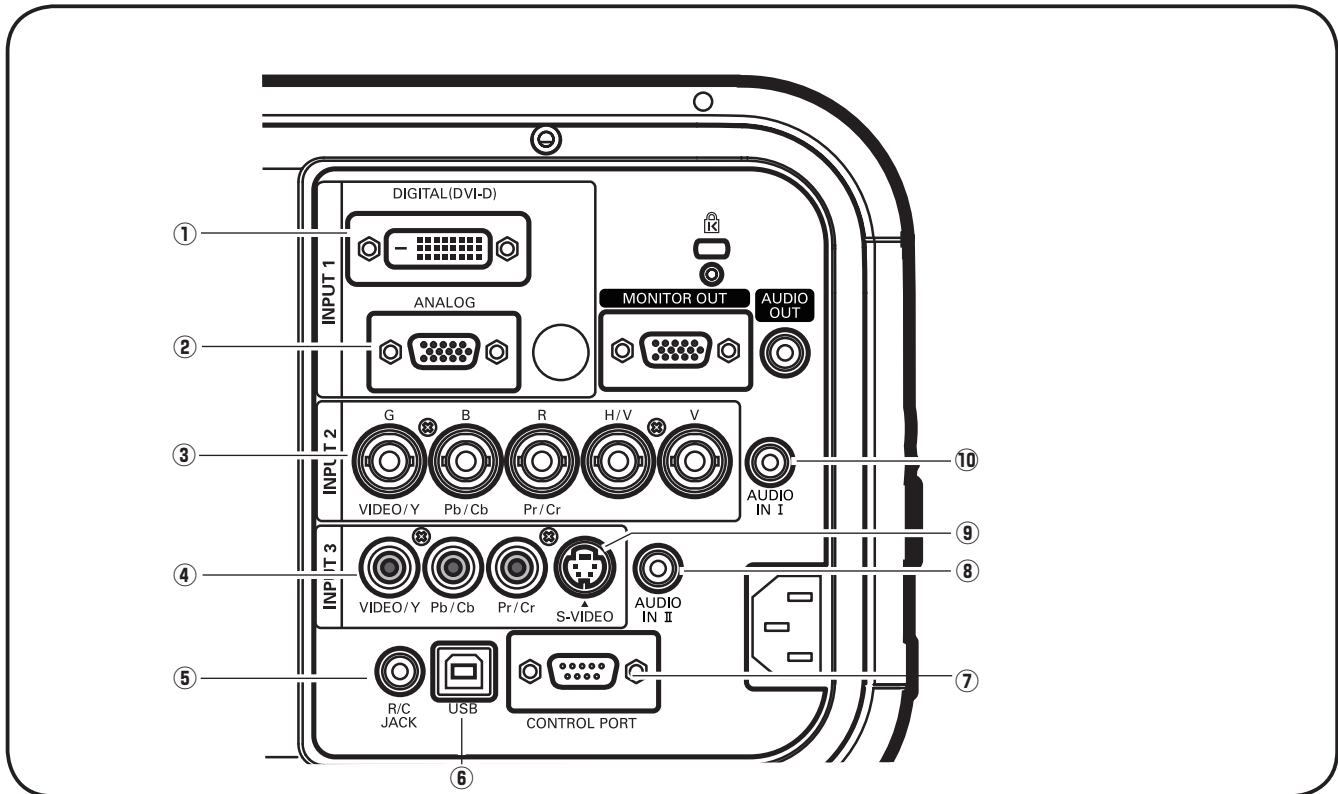

**① COMPUTER INPUT TERMINAL (DIGITAL)**

Connect the computer output digital signal to this terminal. The HDTV (HDCP compatible) signal can also be connected (pp.22-23).

**② COMPUTER INPUT TERMINAL (ANALOG)**

Connect the computer (or RGB scart) output signal to this terminal (pp.22-23).

**③ 5 BNC INPUT JACKS**

Connect the component or composite video output signal from video equipment to VIDEO/Y, Pb/Cb, and Pr/Cr jacks or connect the computer output signal (5 BNC Type [Green, Blue, Red, Horiz. Sync, and Vert. Sync.]) to G, B, R, H/V, and V jacks (pp.22-23).

**④ VIDEO INPUT JACK**

Connect the component or the composite video output signal from video equipment to this jack (p.23).

**⑤ R/C JACK**

When using the wired remote control, connect the wired remote control to this jack with a remote control cable.

**⑥ USB CONNECTOR (Series B)**

Use this connector when controlling a computer with the remote control of the projector. Connect the USB terminal of your computer to this connector with the supplied USB cable (p.22).

**⑦ CONTROL PORT CONNECTOR**

When controlling the projector from a computer, connect the computer to this connector with a control cable (p.22).

**⑧ AUDIO IN II JACK**

Connect the audio output (stereo) signal from a computer or video equipment (p.24).

**⑨ S-VIDEO INPUT JACK**

Connect the S-VIDEO output signal from video equipment to this jack (p.23).

**⑩ AUDIO IN I JACK**

Connect the audio output (stereo) signal from a computer or video equipment (p.24).

## Rear Terminal

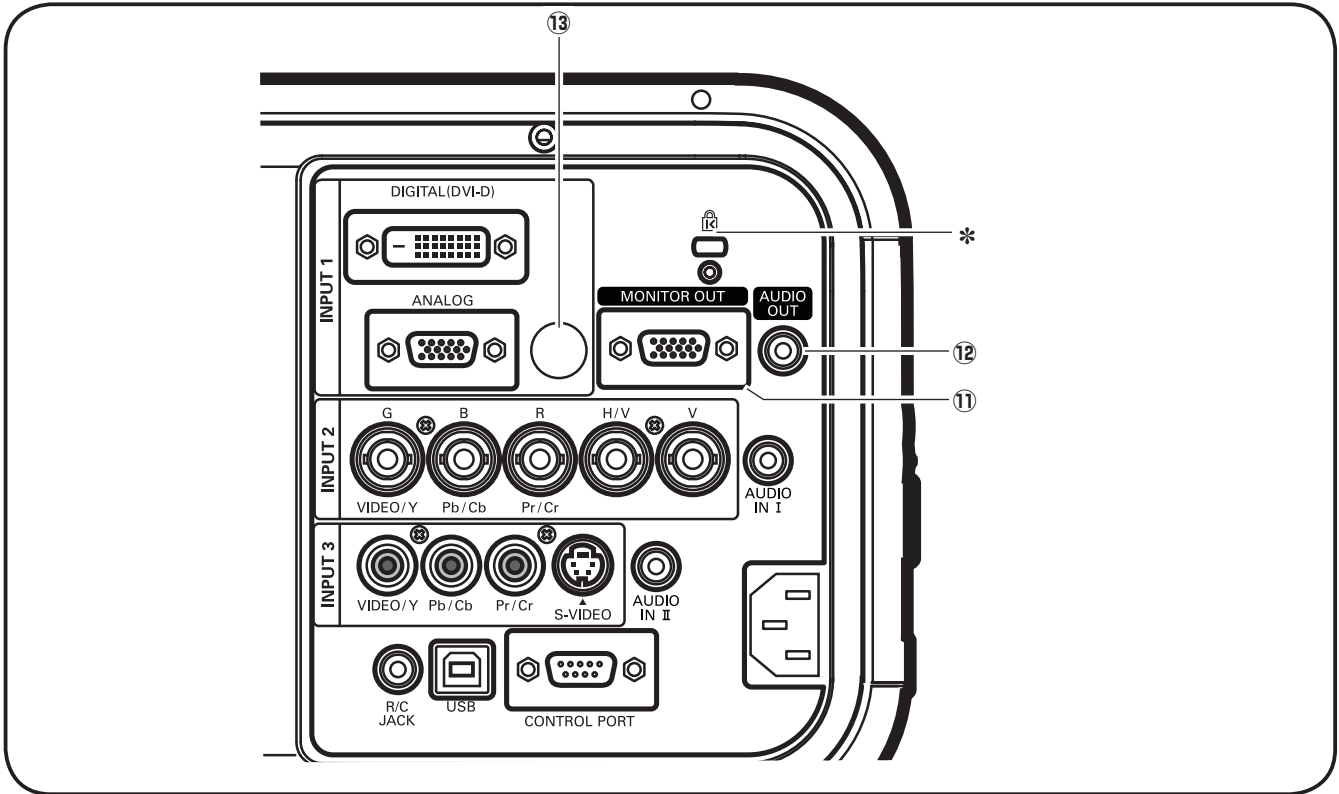

### ⑪ MONITOR OUT TERMINAL

This terminal outputs the analog RGB, component or composite video signal that is projected and connected to INPUT 1-3 terminal (pp.22-23).

### ⑫ AUDIO MONITOR OUTPUT JACK

This jack outputs the audio signal from computer or video equipment to external audio equipment (p.24).

### ⑬ INFRARED REMOTE RECEIVER (Back)

The infrared remote receiver is also located in the front (pp.10, 16).

### \* Kensington Security Slot

This slot is for a Kensington lock used to deter theft of the projector.

\*Kensington is a registered trademark of ACCO Brands Corporation.

### ✓ Note:

- Use the optional COMPONENT-VGA cable (p.81) and commercially available RCA cable when connecting component or composite video signal to another equipment.
- A Composite video signal is output from the green cord of COMPONENT-VGA cable .

**Side Control and Indicators**

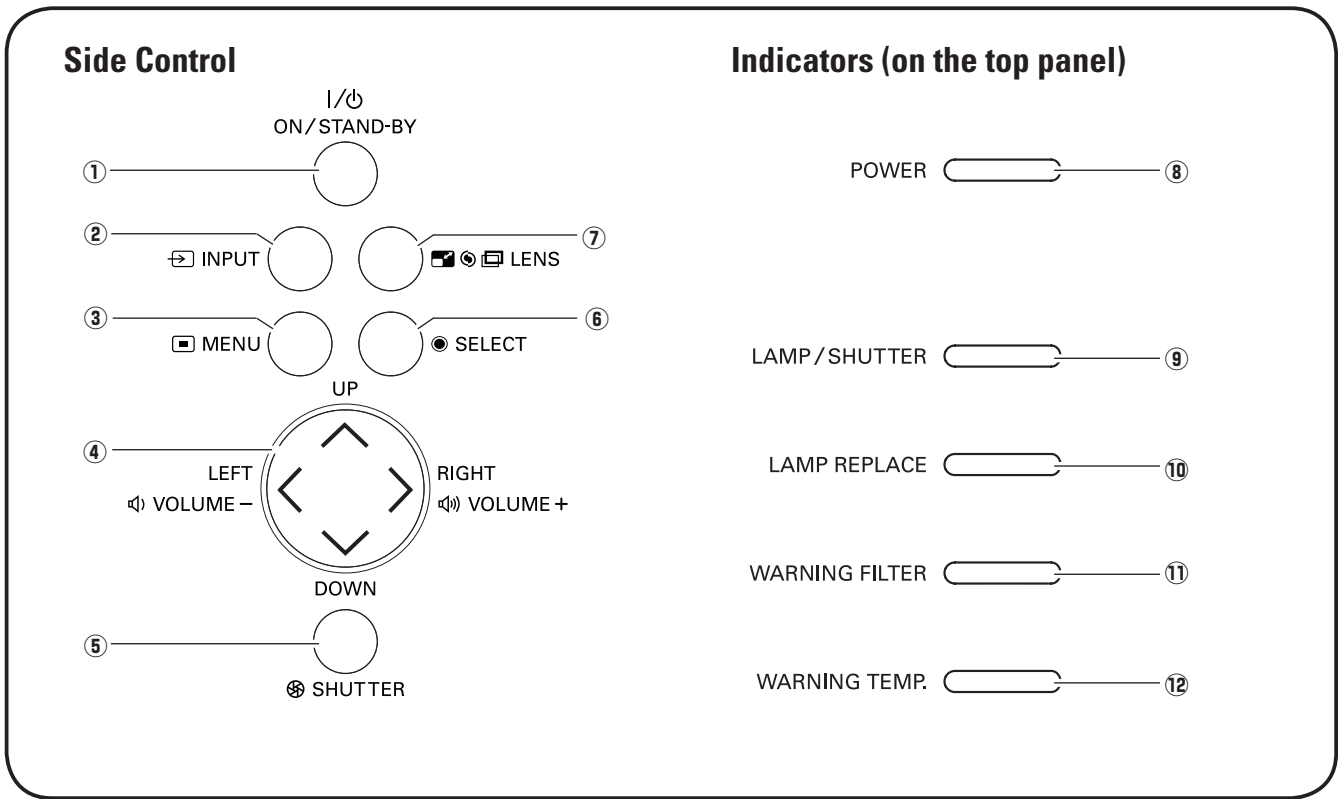

- ① **ON/STAND-BY button**  
Turn the projector on or off (pp.26–27).
- ② **INPUT button**  
Select an input source (pp.35–37).
- ③ **MENU button**  
Open or close the On-Screen Menu (p.28).
- ④ **Point ▲▼◀▶ (VOLUME + / -) buttons**
  - Select an item or adjust the value in the On-Screen Menu (p.28).
  - Pan the image in Digital zoom + mode (p.44).
  - Adjust the volume level (with Point ◀▶ buttons) (p.31).
- ⑤ **SHUTTER button**  
Close and open up the built-in shutter. (p.30)
- ⑥ **SELECT button**
  - Execute the selected item (p.28).
  - Expand or compress the image in the Digital zoom mode (p.44).
- ⑦ **LENS button**  
Enter the focus, zoom, and lens shift adjustment mode (p.30).

- ⑧ **POWER indicator**
  - Light when in stand-by mode and during operations.
  - Blink in the Power management mode (p.56).
- ⑨ **LAMP/SHUTTER indicator**  
Light red during operations.  
Light blue when the shutter is closed (p.75).
- ⑩ **LAMP REPLACE indicator**  
Light orange when the projection lamp reaches its end of life (pp.64, 76).
- ⑪ **WARNING FILTER indicator**
  - Blink slow when the filter is being scrolled (pp. 61, 75).
  - Blink fast when the filter scroll is not working properly or the filter cartridge is not installed (pp.61, 77).
  - Light orange when the clogging of the filter is detected or the filter counter reaches a time set in the timer setting, urging immediate filter/ filter cartridge replacement (pp.60, 61, 77).
- ⑫ **WARNING TEMP. indicator**  
Blink red when the internal temperature of the projector exceeds the operating range (pp.68, 75-77).

## Remote Control

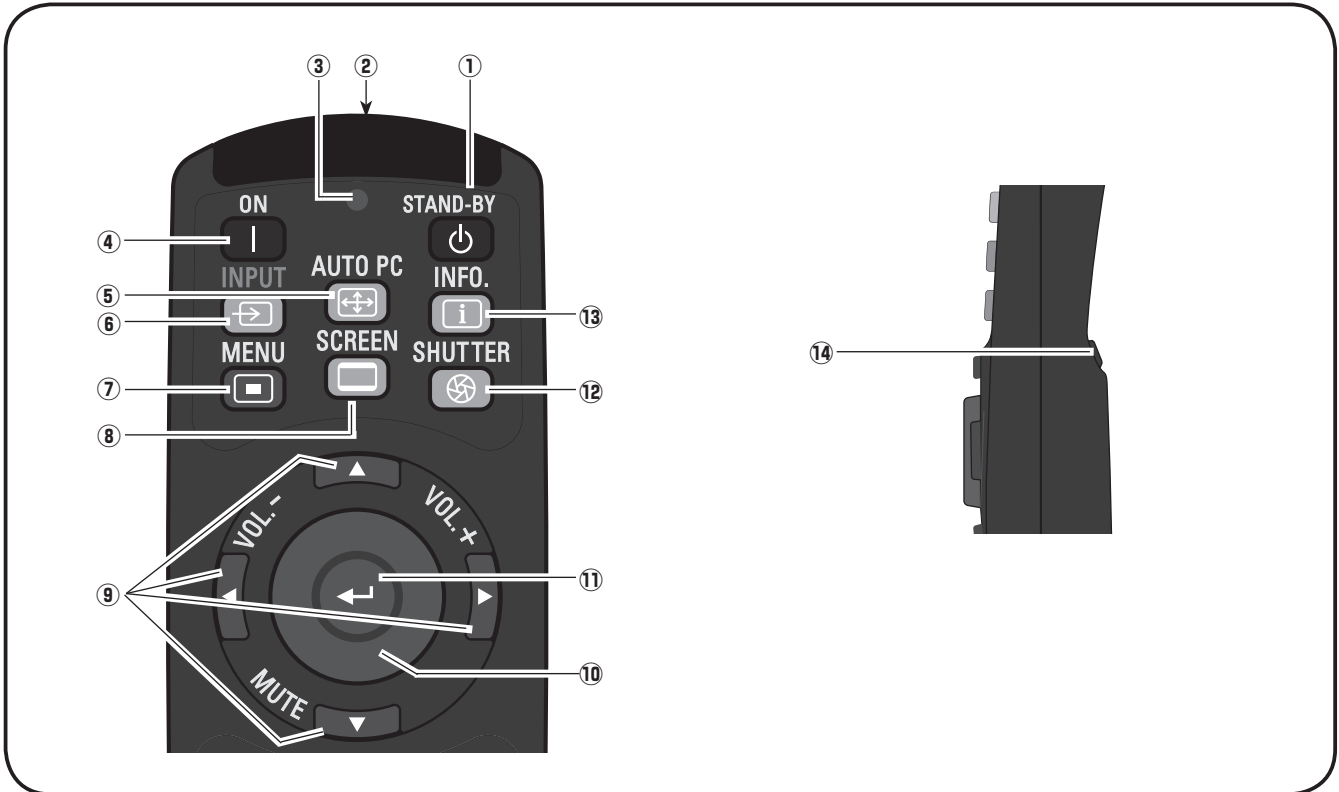

**① STAND-BY button**

Turn the projector off (p.27).

**② WIRED REMOTE jack**

Connect the remote control cable to this jack when using as a wired remote control.

**③ SIGNAL EMISSION indicator**

Light red while a signal is being sent from the remote control to the projector.

**④ ON button**

Turn the projector on (p.26).

**⑤ AUTO PC button**

Automatically adjust the computer image to its optimum setting (pp.32, 39).

**⑥ INPUT button**

Select a signal (pp.35–37).

**⑦ MENU button**

Open or close the On-Screen Menu (p.28).

**⑧ SCREEN button**

Select the screen size (p.32).

**⑨ POINT ▲▼◀▶ (VOLUME + / - , MUTE) buttons**

- Select an item or adjust the value in the On-Screen Menu (p.28).
- Pan the image in Digital zoom + mode (p.44).
- Adjust the volume level (with Point ◀▶ buttons) or mute the sound (with Point ▼ button.) (p.31).

**⑩ MOUSE POINTER button**

Move a pointer of the projector or a pointer for wireless mouse operation (p.34).

**⑪ SELECT button**

- Execute the selected item (p.28).
- Expand or compress the image in the Digital zoom mode (p.44).

**⑫ SHUTTER button**

Close and open up the built-in shutter (p.30).

**⑬ INFO. button**

Display the input source information (p.32).

**⑭ L-CLICK button**

Act as the left mouse button for wireless mouse operation (p.34).



To ensure safe operation, observe the following precautions:

- Do not bend, drop, or expose the remote control to moisture or heat.
- For cleaning, use a soft dry cloth. Do not apply benzene, thinner, splay, or any other chemical materials.



**Remote Control**

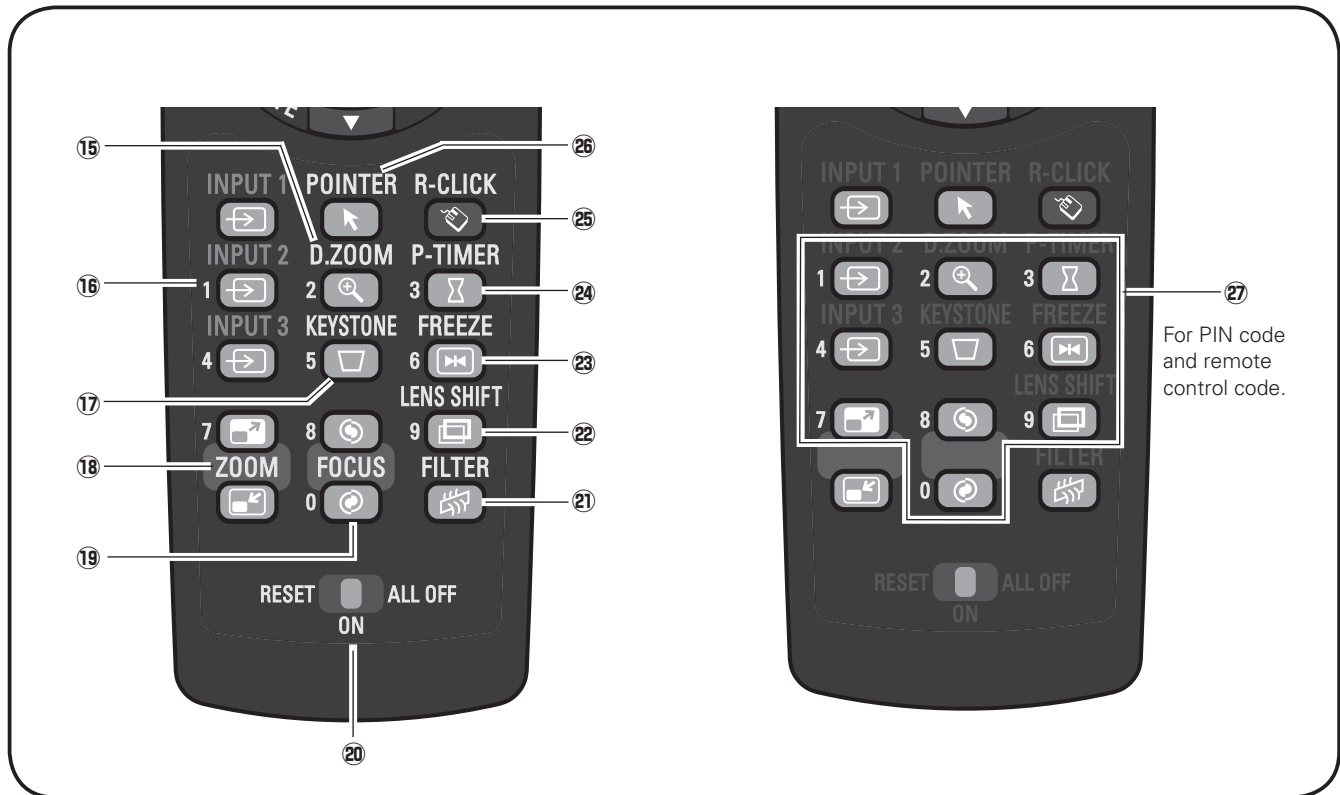

- 15 D.ZOOM button**  
 Select the Digital zoom +/- mode and resize the image (p.44).
- 16 INPUT 1 – 3 buttons**  
 Select an input source (INPUT 1 – INPUT 3) (pp.35–37).
- 17 KEYSTONE button**  
 Correct keystone distortion (p.33).
- 18 ZOOM ▲▼ buttons**  
 Zoom in and out the images (p.32).
- 19 FOCUS buttons**  
 Adjust the focus (p.32).
- 20 RESET/ON/ALL-OFF switch**  
 When using the remote control, set this switch to “ON.” Set it to “ALL OFF” for power saving when it is not in use. Slide this switch to “RESET” to initialize the remote control code.
- 21 FILTER button**  
 Scroll the filter (p.33).
- 22 LENS SHIFT button**  
 Select the Lens Shift function (p.32).

- 23 FREEZE button**  
 Freeze the picture on the screen (p.33).
- 24 P-TIMER button**  
 Operate the P-timer function (p.33).
- 25 R-CLICK button**  
 Act as the right mouse button for wireless mouse operation (p.34).
- 26 POINTER button**  
 Act as the On-Off switch for the Pointer (p.33, 34).
- 27 NUMBER buttons**  
 Act as number buttons. Use these buttons when setting the remote control codes (pp.17, 55) or when entering the PIN code numbers (pp. 26, 54, 58).

## Remote Control Battery Installation

- 1** Open the battery compartment lid.

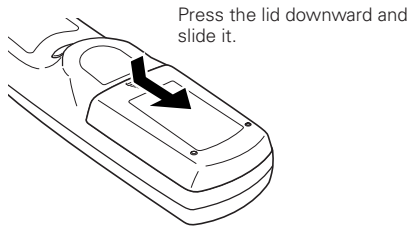

- 2** Install new batteries into the compartment.

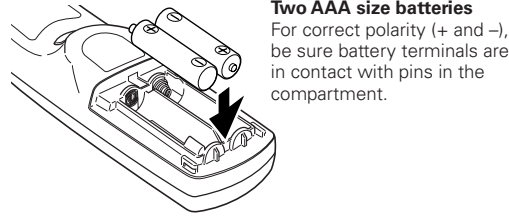

- 3** Replace the compartment lid.

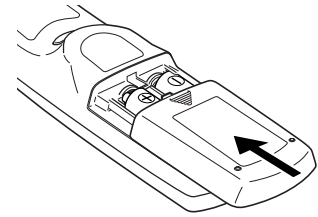

To ensure safe operation, please observe the following precautions :

- Use two (2) AAA or LR03 type alkaline batteries.
- Always replace batteries in sets.
- Do not use a new battery with a used battery.
- Avoid contact with water or liquid.
- Do not expose the remote control to moisture or heat.
- Do not drop the remote control.
- If the battery has leaked on the remote control, carefully wipe the case clean and install new batteries.
- Risk of an explosion if battery is replaced by an incorrect type.
- Dispose of used batteries according to the instructions.

## Remote Control Receivers and Operating Range

Point the remote control toward the projector (to Infrared Remote Receivers) when pressing the buttons. Maximum operating range for the remote control is about 16.4' (5 m) and 60 degrees in front and rear of the projector.

Infrared Remote Receivers are provided both in front and back of the projector. You can conveniently use both of the receivers (pp. 10, 56).

**✓ Note:**

- When hanging the projector from the ceiling, select the Infrared Remote Receiver which is located farther away from the fluorescent light (p.56).

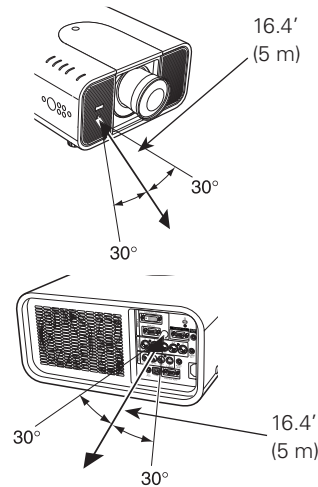

## Wired Remote Control Transmitter

The remote control can be used as a wired remote control. Wired remote control helps you use the remote control outside of the operating range (16.4' / 5 m). Connect the remote control and the projector with the remote control cable. Connected with the remote control cable, the remote control does not emit wireless signal.

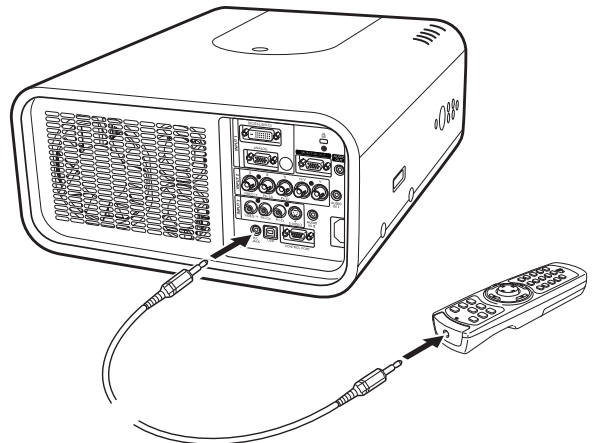

## Remote Control Code

The eight different remote control codes (Code 1–Code 8) are assigned to this projector. Switching the remote control codes prevents interference from other remote controls when several projectors or video equipment next to each other are operated at the same time. Change the remote control code for the projector first before changing that for the remote control. See “Remote control” in the Setting Menu on page 55.

- 1** Press and hold the MENU and a number button (1–8) for more than five seconds to switch between the codes.
- 2** To initialize the remote control code, slide the RESET/ON/ALL-OFF switch to “RESET,” and then to “ON.” The initial code is set to Code 1.

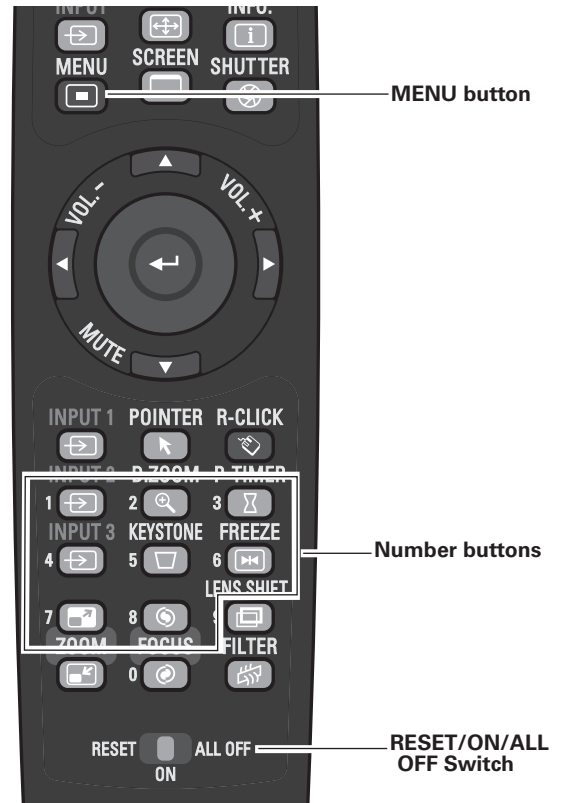

Press and hold the MENU and a number button (1–8) that corresponds to the remote control code for more than five seconds to switch between the codes.

# Installation

## ***Adjustable Feet***

Projection angle can be adjusted up to 6.5 degrees with the adjustable feet.

Rotate the adjustable feet and tilt the projector to the proper height; to raise the projector, rotate the both feet clockwise.

To lower the projector or to retract the adjustable feet, rotate the both feet counterclockwise.

To correct keystone distortion, press the KEYSTONE button on the remote control or select Keystone from the menu (see pages 15, 33, 44, 48).

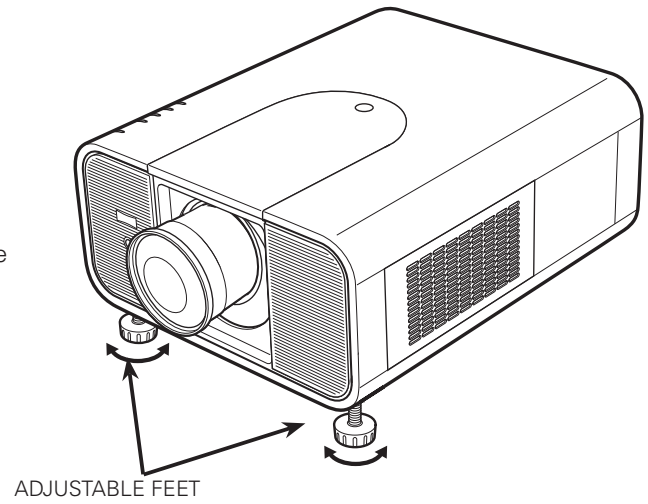

## Lens Installation

When replacing the lens or using an optional lens, install the lens by following the instructions below. Ask the sales dealer for detailed information of the optional lens specifications.

### Removing the lens

- 1** Shift the lens to the center position by using the Lens shift function (p. 30).
- 2** Turn off the projector and unplug the AC power cord.
- 3** While pressing the top cover release button on the top cover, slide the top cover toward front to remove it.
- 4** Slide the light-block sheet upward and remove it.
- 5** Hold the lens with one hand and pull the Lens Lock Lever upward with the other hand. Remove the lens from the projector.
  - \*Do not touch the glass part of the lens with your hand.



#### **CAUTION**

Be careful when handling the lens. Do not drop.

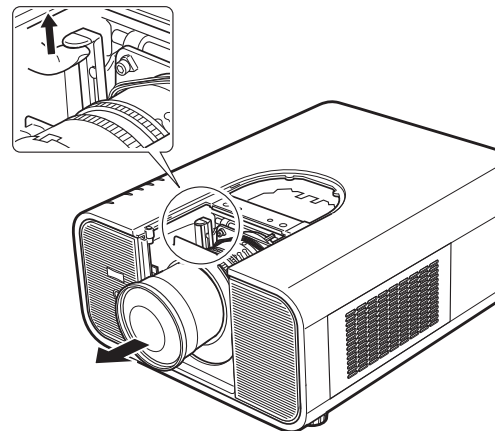
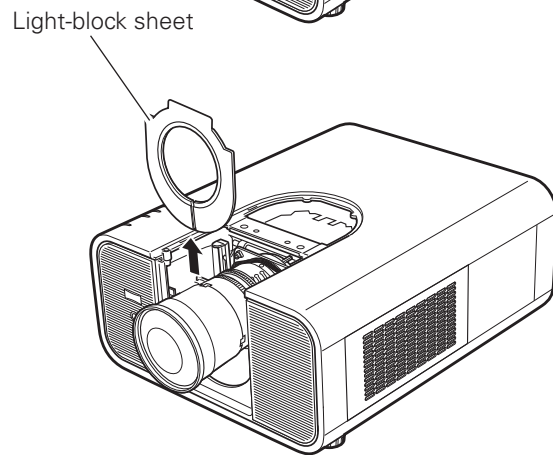
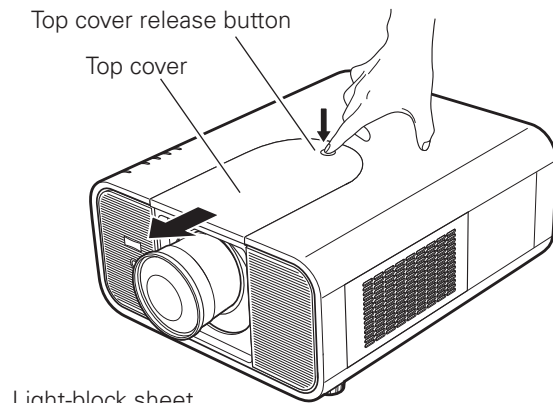

## Attaching the lens to the projector

- 1** Turn off the projector and unplug the AC power cord.
- 2** Fit the lens to the projector. Make sure that the lens is fully inserted to the projector.
- 3** Push the Lens Lock Lever downward. Make sure that the lens is properly locked.
- 4** Slide the light-block sheet in the groove to mount.
- 5** While pressing the top cover release button on the top cover, slide the top cover back to the projector.

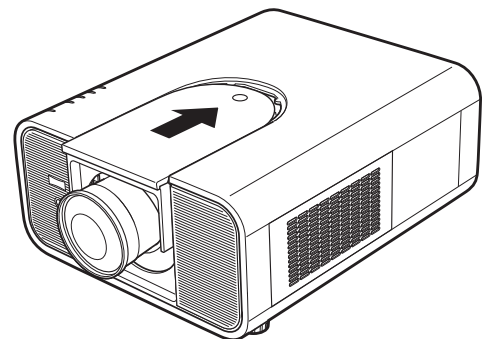
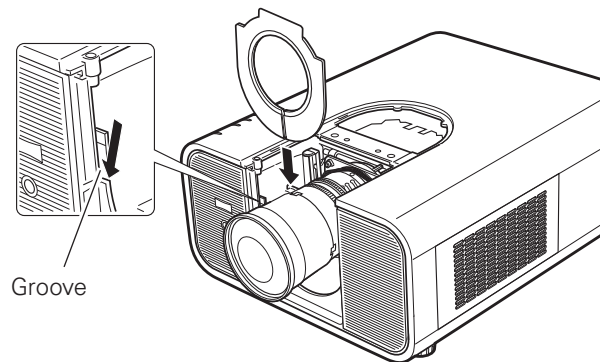
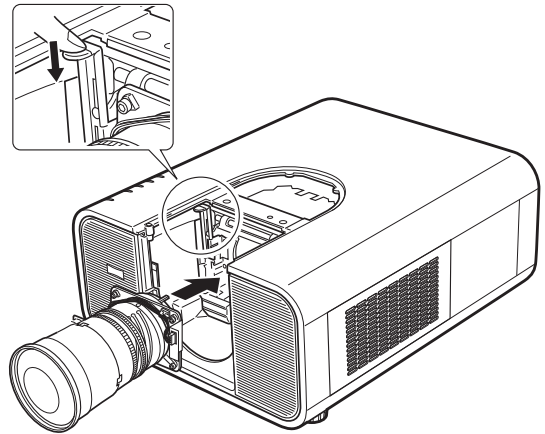

### NOTES ON LENS INSTALLATION

- Do not touch or remove any parts except the lens and related parts. It may result in malfunctions, electrical shock, fire hazard or other accidents.
- Before installing or replacing the lens, check that the Model No. of the Projection Lens matches to the projector.
- For details of the lens and installation, contact the sales dealer where you purchased the projector.



## Focus correction

When the lens is attached to the projector and images are being projected onto the screen, the peripheral focus may be out of focus in some localized areas. If this happens, insert the one, of three sizes of spacers, in between the Lens Attachment and the lens to adjust the focus.

Inserting the Spacer corrects the distance on the Lens Attachment and improves the diagonal focus.

The corrected distance is determined by the thickness of the used spacers. As a guide, the distance is adjusted by approximately 30 mm for each 0.1-mm thickness of the spacers.

There are three types of spacers provided, and there are four of each spacer type. Use these spacers to correct the distance as required.

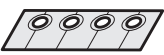
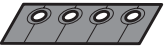
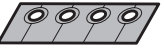
|   |   |  |
|---|---|--|
|    | Spacer "1"<br>Color; Clear<br>Thickness; 0.1 mm | Correction distance<br>30 mm/for 40-inch<br>projection |
|    | Spacer "2"<br>Color; Black<br>Thickness; 0.2 mm | Correction distance<br>55 mm/for 40-inch<br>projection |
|  | Spacer "3"<br>Color; Cream<br>Thickness; 0.3 mm | Correction distance<br>80 mm/for 40-inch<br>projection |

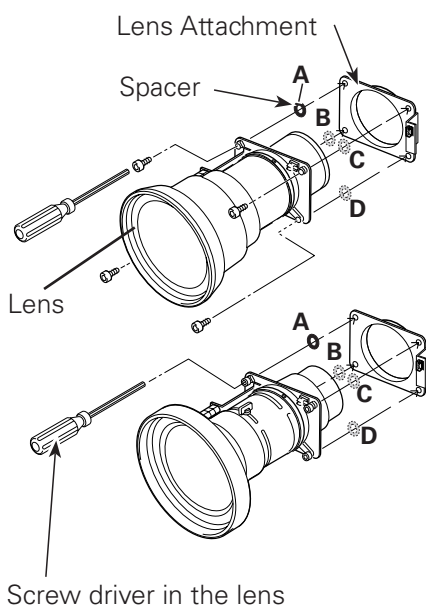
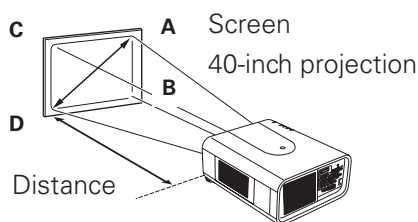

## Focus adjustment

### AH-32011

Set up the projector and project image on the screen.

1. Loosen the Focus Lock Screw on the lens.
2. Rotate the lens to obtain proper focus on center area of the screen.
3. Lock the Focus Lock Screw securely.

When proper focus is not observed at outer area of the screen, proceed the following adjustments.

4. Loosen the Focus Lock Ring on the lens. (Turn the Lock Ring counter-clockwise.)
5. Rotate the lens to obtain proper focus on outer area of the screen.
6. Lock the Focus Lock Ring securely. (Turn the Lock Ring clockwise.)

If proper focus is not observed over the entire screen, repeat above adjustments 1~ 6.

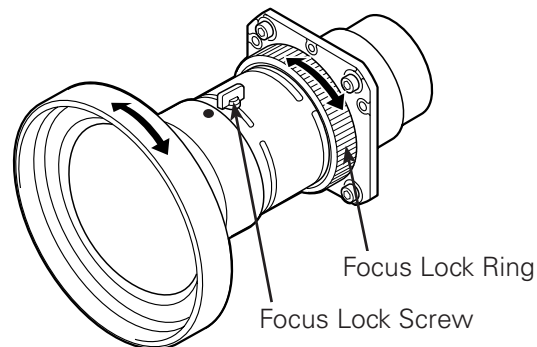

### BE SURE TO CHECK FOR SAFETY

After installing or replacing the lens, be sure to check the following for safety.



1. Check the lens is securely fixed with the screws.
2. Check no wiring is damaged or tangled on the gear of the lens motor or the other mechanical parts.
3. Check no part is missing, and no mounting part is loose.

Some parts are not used for installation or replacement. Keep these parts for later use.

### ✓ Note:

- Figures in this manual may differ from the actual product.

## Connecting to a Computer (Digital and Analog RGB)

### Cables used for connection (\* = Cables not supplied with this projector.)

- VGA Cable (One cable is supplied.)
- DVI-Digital Cable \*
- BNC Cable \*
- Serial Cross Cable\*
- USB Cable

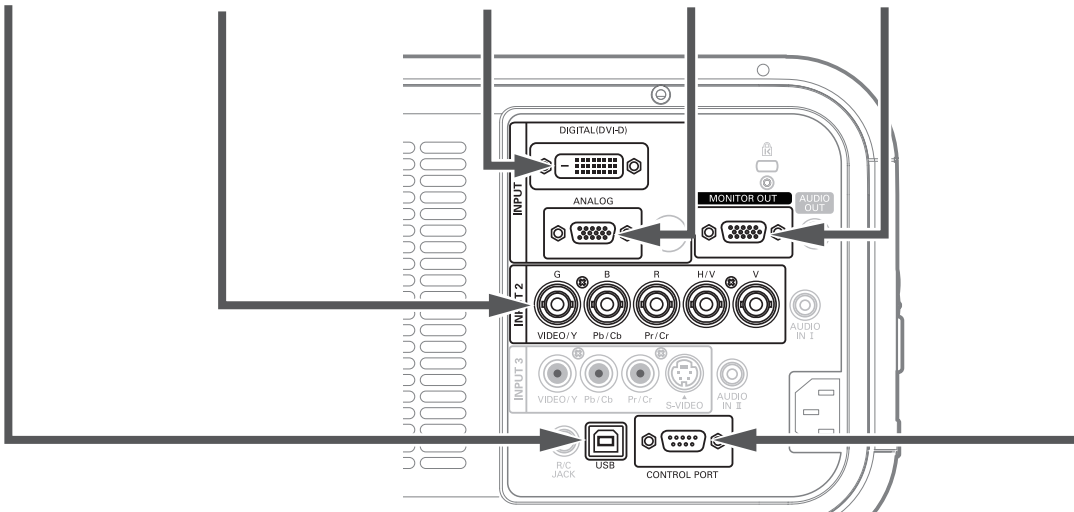
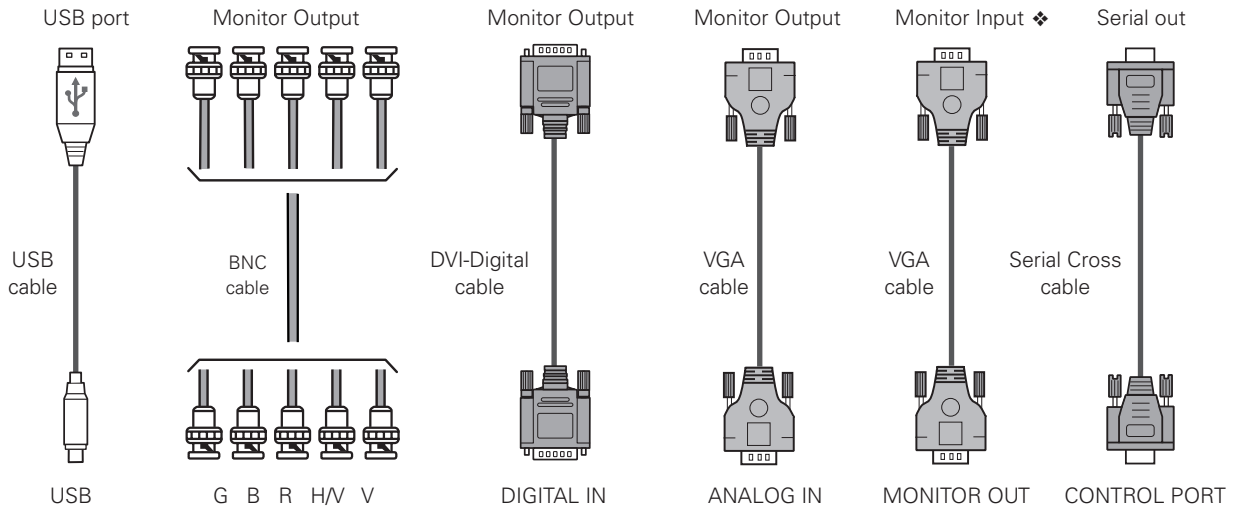
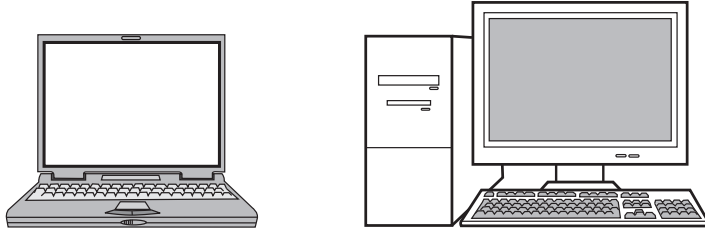

Unplug the power cords of both the projector and external equipment from the AC outlet before connecting cables.

❖ See the next page for the signals that can output to the MONITOR OUT terminal.

## Connecting to Video Equipment (Video, S-Video)

**Cables used for connection** (\* = Cables not supplied with this projector.)

- Video Cable (RCA x 1 or RCA x 3) \*
- BNC Cable \*
- S-VIDEO Cable \*
- Scart-VGA Cable \*
- DVI-Digital Cable \*

### Monitor Out Signal Table

| Input Terminal |         | Monitor Out      | Cable |
|----------------|---------|------------------|-------|
| Input 1        | D-sub15 | RGB (PC analog)  | YES   |
|                |         | RGB (SCART)      | NO    |
|                | DVI-D   | RGB (PC digital) | NO    |
|                |         | RGB (AV HDCP)    | NO    |
| Input 2        | 5BNC    | RGB              | YES   |
|                |         | Video            | YES   |
|                |         | Y, Cb/Cr         | YES   |
| Input 3        | RCA     | Y, Cb/Cr         | YES   |
|                | S-Video | S-video          | NO    |
|                | Video   | Video            | YES   |
| Network        |         | NO               |       |

\* A cable with one end D-sub 15 and the other end (Black box) compatible with each equipment is necessary.



Unplug the power cords of both the projector and external equipment from the AC outlet before connecting cables.

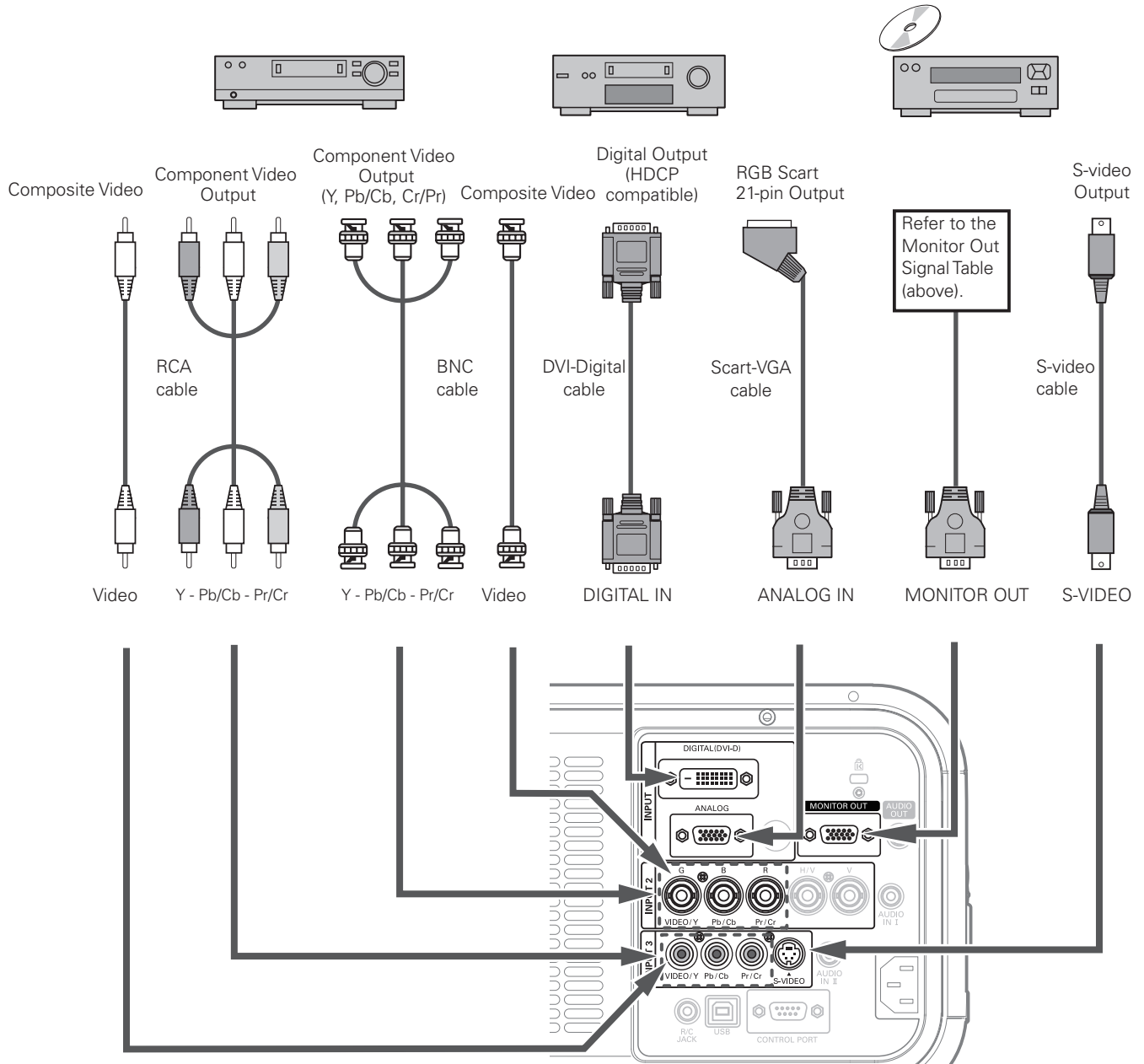

## Connecting for Audio Signal

**Cables used for connection** (\* = Cables not supplied with this projector.)

- Audio Cable \*

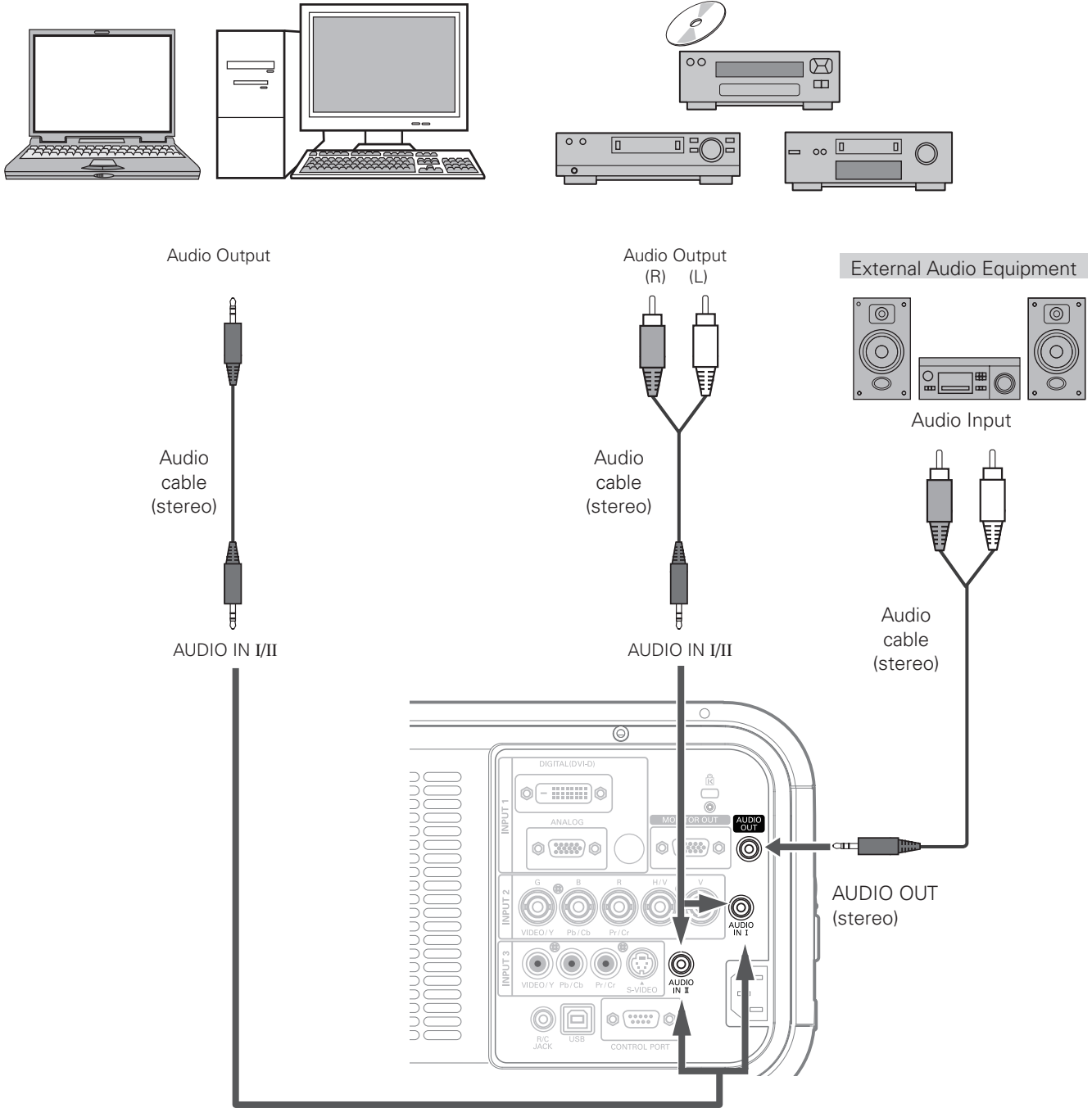

Unplug the power cords of both the projector and external equipment from the AC outlet before connecting cables.

✓ **Note:**

- See the Sound menu to set the Input pattern for AUDIO IN I/II. (p. 31)

### Connecting the AC Power Cord

This projector uses nominal input voltages of 100–120 V or 200–240 V AC and it automatically selects the correct input voltage. It is designed to work with single-phase power systems having a grounded neutral conductor. To reduce the risk of electrical shock, do not plug into any other type of power system. If you are not sure of the type of power being supplied, consult your authorized dealer or service station. Connect the projector with all peripheral equipment before turning on the projector.

**CAUTION**

The AC outlet must be near this equipment and must be easily accessible.

**Note:**

- *Unplug the AC power cord when the projector is not in use. When the projector is connected to an outlet with AC power cord, it is in stand-by mode and consumes a little electric power.*

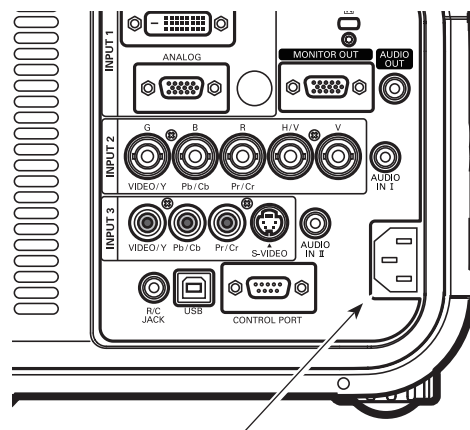

Connect the AC power cord (supplied) to the projector.

#### NOTE ON THE POWER CORD

AC power cord must meet the requirements of the country where you use the projector. Confirm the AC plug type with the chart below and proper AC power cord must be used. If the supplied AC power cord does not match your AC outlet, contact your sales dealer.

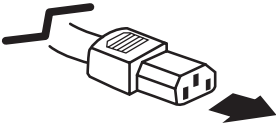
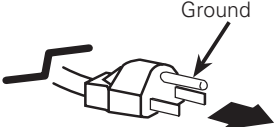
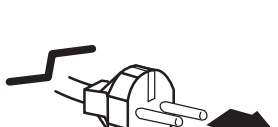
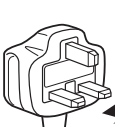
| Projector side  | AC Outlet side  |   |  |
|---|---|---|--|
|  <p>To POWER CORD CONNECTOR on your projector.</p> | <p><b>For the U.S.A. and Canada</b></p>  <p>To the AC Outlet. (120 V AC)</p> | <p><b>For Continental Europe</b></p>  <p>To the AC Outlet. (200–240 V AC)</p> | <p><b>For the U.K.</b></p>  <p>To the AC Outlet. (200–240 V AC)</p> |

# Basic Operation

## Turning On the Projector

- 1 Complete peripheral connections (with a computer, VCR, etc.) before turning on the projector.
- 2 Connect the projector's AC power cord into an AC outlet. The LAMP/SHUTTER indicator lights red and the POWER indicator lights green.
- 3 Press the ON/STAND-BY button on the side control or the ON button on the remote control. The LAMP/SHUTTER indicator dims and the cooling fans start to operate. The preparation display appears on the screen and the countdown starts.
- 4 After the countdown, the input source that was selected the last time and the Lamp control status icon (see page 55) appear on the screen.

If the projector is locked with a PIN code, PIN code Input Dialog Box will appear. Enter the PIN code as instructed below.

### Enter a PIN code

Use the Point ▲▼ buttons on the side control or Number buttons on the remote control to enter a number.

### When using side control

Use the Point ▲▼ buttons on the side control to select a number. Press the Point ► button to fix the number and move the red frame pointer to the next box. The number changes to "\*" Repeat this step to complete entering a four-digit number. After entering the four-digit number, move the pointer to "Set." Press the SELECT button so that you can start to operate the projector.

### When using remote control

Press the Number buttons on the remote control to enter a number (p.15). When you complete entering a four-digit number, the pointer moves to "Set." Press the SELECT button so that you can start to operate the projector.

If you fixed an incorrect number, use the Point ◀ button to move the pointer to the number you want to correct, and then enter the correct number.

If you entered an incorrect PIN code, "PIN code" and the number (\*\*\*\*) will turn red for a moment. Enter the correct PIN code all over again.

### What is PIN code?

PIN (Personal Identification Number) code is a security code that allows the person who knows it to operate the projector. Setting a PIN code prevents unauthorized use of the projector.

A PIN code consists of a four-digit number. Refer to the PIN code lock function in the Setting Menu on page 57-58 for locking operation of the projector with your PIN code.



The preparation display will disappear after 30 seconds.

### Selected Input Source and Lamp control

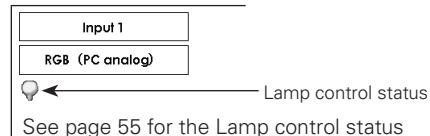

### ✓ Note:

- The Lamp replacement icon and the Filter replacement or the Filter cartridge replacement icon may appear on the screen depending on the usage state of the projector.
- When the filter cartridge replacement icon keeps appearing on the screen at turning on the projector for some time and no action is taken to replace the filter cartridge, the projector will be automatically shut down in 3 minutes after turning on to protect the projector. (pp. 61-63, 77)

### PIN code Input Dialog Box

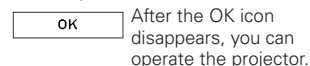
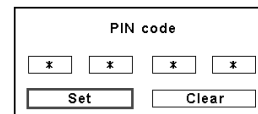

### ✓ Note:

- When the Logo select function is set to "Off," the logo will not be shown on the screen (p.53).
- When the "Countdown off" or "Off" is selected in the Display function, the countdown will not be shown on the screen (p.52).
- During the countdown period, all operations are invalid.
- If the PIN code number is not entered within 3 minutes after the PIN code dialog box appeared, the projector will be turned off automatically.
- The "1234" is set as the initial PIN code at the factory.



### CAUTION ON HANDLING PIN CODE

If you forget your PIN code, the projector can no longer be started. Take special care in setting a new PIN code; write down the number in a column on page 83 of this manual and keep it on hand. Should the PIN code be missing or forgotten, consult your dealer or service center.



## Turning Off the Projector

- 1** Press the ON/STAND-BY button on the side control or the STAND-BY button on the remote control, and "Power off?" appears on the screen.
- 2** Press the ON/STAND-BY button on the side control or the STAND-BY button on the remote control again to turn off the projector. The LAMP/SHUTTER indicator lights bright and the POWER indicator turns off. After the projector is turned off, the cooling fans operate for 90 seconds. You cannot turn on the projector during this cooling down period.
- 3** When the projector has cooled down enough, the POWER indicator lights green and then you can turn on the projector. To unplug the AC power cord, wait until the projector is completely cooled down.

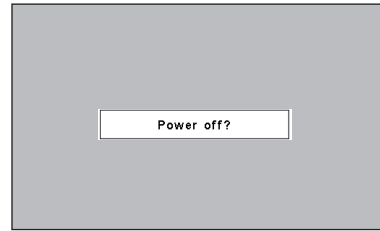

"Power off?" disappears after 4 seconds.



TO MAINTAIN THE LIFE OF THE LAMP, ONCE YOU TURN THE PROJECTOR ON, WAIT AT LEAST FIVE MINUTES BEFORE TURNING IT OFF. DO NOT UNPLUG THE AC POWER CORD WHILE COOLING FANS ARE RUNNING OR BEFORE THE POWER INDICATOR LIGHTS GREEN AGAIN. OTHERWISE IT WILL RESULT IN SHORTENING OF THE LAMP LIFE.



DO NOT OPERATE THE PROJECTOR CONTINUOUSLY WITHOUT REST. CONTINUOUS USE MAY RESULT IN SHORTENING THE LAMP LIFE. TURN OFF THE PROJECTOR AND LET STAND FOR ABOUT AN HOUR IN EVERY 24 HOURS.

### ✓ Note:

- When the On start function is set to "On," the projector will be turned on automatically by connecting the AC power cord to an AC outlet (p.56).
- The running speed of cooling fans is changed according to the temperature inside the projector.
- Do not put the projector in a case before the projector is cooled enough.
- If the WARNING TEMP. indicator blinks red, see "Warning Indicators" on page 68.
- The projector cannot be turned on during the cooling period with the POWER indicator turned off. You can turn it on again after the POWER indicator becomes green again.

## How to Operate the On-Screen Menu

The projector can be adjusted or set via the On-Screen Menu. For each adjustment and setting procedure, refer to the respective sections in this manual.

- 1** Press the MENU button on the side control or the remote control to display the On-Screen Menu.
- 2** Use the Point ◀▶ buttons to select a Menu icon. Use the Point ▲▼ buttons to select an item in the selected menu.
- 3** Press the SELECT button to show the item data. Use the Point ◀▶ buttons to adjust the values.

To close the On-Screen Menu, press the MENU button again.

**✓ Note:**

- The selected item is not active until the SELECT button is pressed.

### Side Control

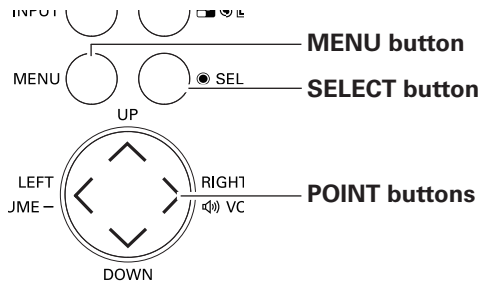

### Remote Control

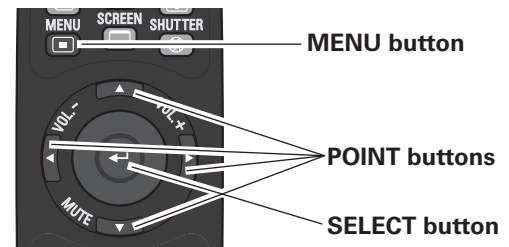

### On-Screen Menu

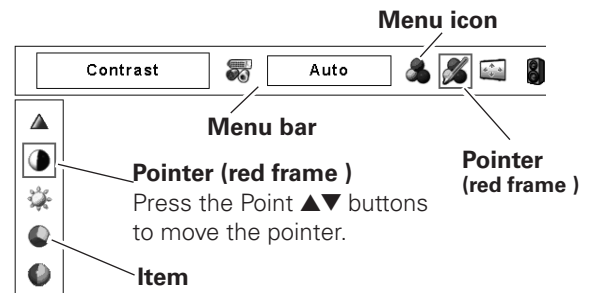

Press the SELECT button here to display previous items.

Press the SELECT button here to display next items.

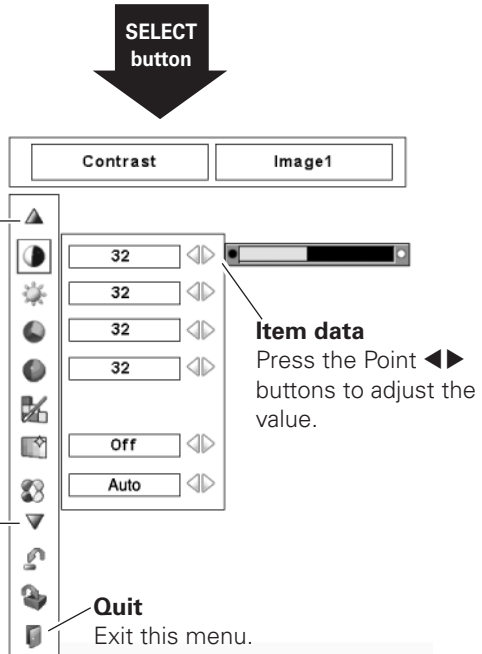

**Item data**  
Press the Point ◀▶ buttons to adjust the value.

**Quit**  
Exit this menu.

## Menu Bar

For detailed functions of each menu, see “Menu Tree” on pages 72-74.

### For Computer Source

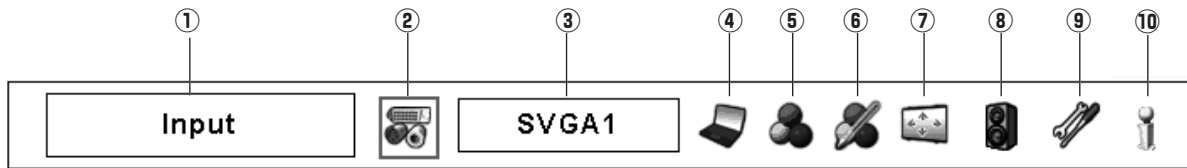

#### ① Guide Window

Show the selected Menu of the On-Screen Menu.

#### ② Input Menu

Used to select an input source (Input 1, Input 2, or Input 3) (pp. 35, 36).

#### ③ PC System Menu

Used to select computer system (p. 38).

#### ④ PC Adjust Menu

Used to adjust the parameters to match with the input signal format (pp. 39-41).

#### ⑤ Image Select Menu

Used to select an image level among Standard, Real, and Image 1–10 (p. 42).

#### ✓ Note:

- Items will be same as the items in video source when 480i, 575i, 480p, 575p, 720p, 1035i or 1080i is selected.

#### ⑥ Image Adjust Menu

Used to adjust the computer image. [Contrast/ Brightness/ Color management/Auto picture control/Advanced color/Color temp./White balance (R/G/B)/Offset (R/G/B)/ Sharpness/ Gamma/Reset/Store/Quit] (pp.49–51).

#### ⑦ Screen Menu

Used to adjust the size of the image. [Normal/True/Wide/ Full screen/Custom/Keystone/Ceiling/Rear/Reset/Digital zoom +/-] (pp.43-44).

#### ⑧ Sound Menu

Used to adjust the volume, mute the sound, or switch the Input pattern (p. 31).

#### ⑨ Setting Menu

Used to set the projector’s operating configurations (pp. 52-60).

#### ⑩ Information Menu

Display the input source information (p. 32).

### For Video Source

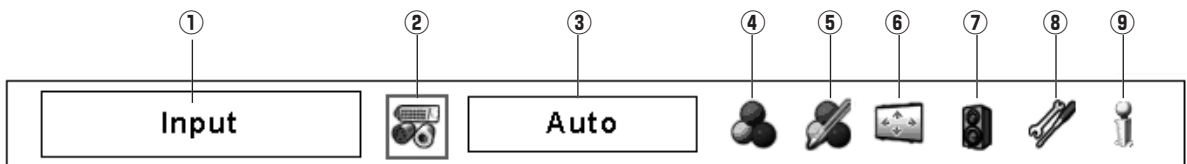

#### ① Guide Window

Show the selected Menu of the On-Screen Menu.

#### ② Input Menu

Used to select an input source (Input 1, Input 2, or Input 3) (pp. 35, 36).

#### ③ AV System Menu

Used to select the system of selected video source (p. 45).

#### ④ Image Select Menu

Used to select an image level among Standard, Cinema, and Image 1–10 (p. 46).

#### ⑤ Image Adjust Menu

Used to adjust the picture image. [Contrast/Brightness/ Color/Tint/Color management/ Auto picture control/

Advanced color/Color temp./White balance (R/G/B)/ Offset (R/G/B)/Sharpness/Gamma/Noise reduction/Progressive/ Reset/Store/Quit] (pp. 49–51).

#### ⑥ Screen Menu

Used to adjust the size of the image. [Normal/Wide/ Custom/Keystone/Ceiling/Rear/Reset] (pp. 47-48).

#### ⑦ Sound Menu

Used to adjust the volume, mute the sound, or switch the Input pattern (p. 31).

#### ⑧ Setting Menu

Used to set the projector’s operating configurations (pp. 52-60).

#### ⑨ Information Menu

Display the input source information (p. 32).

## Operating with Projector Control

### Lens Operation

The following lens operation can be made with the Lens button on the side control.

Press the LENS button to enter each lens operation mode. The selected adjustment display appears on the screen.

Zoom → Focus → Lens Shift → .....

### Zoom Adjustment

Display "Zoom" on the screen. Use the Point ▲▼ buttons to zoom in and out the image.

### Focus Adjustment

Display "Focus" on the screen. Use the Point ▲▼ buttons to adjust focus of the image.

### Lens Shift Adjustment

Display "Lens shift" on the screen. Use the Point ▲▼◀▶ buttons to position the screen to the desired point without having picture distortion.

The screen can be moved up or down to 50 percent, or sideways up to 10 percent from the central axis of the lens shift.

✓ **Note:**

- The arrow disappears at the maximum lens shift in each direction.
- The arrow turns red when the lens shift comes to the center position of the screen.

### Shutter Function

Shutter function allows you to completely block out light to the screen. Press the SHUTTER button to close the shutter inside the projector. To open up the shutter, press the SHUTTER button again. Refer to p.59 for detail of setting for the Shutter function.

✓ **Note:**

- The SHUTTER button on the side control and the remote control cannot be effective when Shutter Protection is "On" in the Setting menu. (p.59)
- The LAMP/SHUTTER indicator on the projector's top lights blue when the shutter is closed. (p.13)
- The projector will shut down automatically when the set time on shutter management has passed. (p.59)
- The Power management function does not work when the shutter is closed.(p.56)

### Side Control

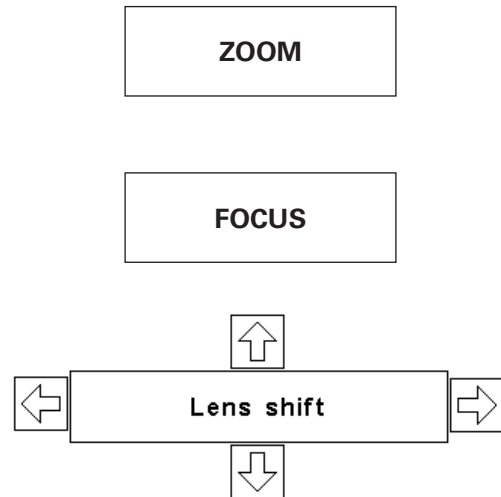
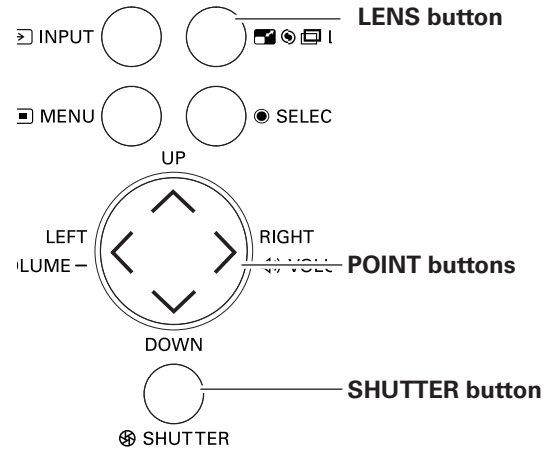

## Sound Adjustment

### Direct Operation

#### Volume

Press the VOLUME+/- buttons on the side control or on the remote control to adjust the volume of Audio Output. The volume dialog box appears on the screen for a few seconds.

#### Mute

Press the MUTE button on the remote control to temporarily turn off the AUDIO OUT. To turn the AUDIO OUT back on, press the MUTE button again or press the VOLUME +/- buttons.

### Menu Operation

- 1 Press the MENU button to display the On-Screen Menu. Use the Point ◀▶ buttons to move the red frame pointer to the Sound Menu icon.
- 2 Use the Point ▲▼ buttons to move the red frame pointer to the desired item, and then press the SELECT button.

#### Volume (Audio output)

Press the Point ▶ button to turn up the volume; press the Point ◀ button to turn down the volume.

#### Mute (Audio output)

Press the Point ◀▶ buttons to switch the mute function On/Off. When the sound is turned off, "On" is displayed. Press the Point ◀▶ buttons again to turn the sound back on.

#### Input pattern

This projector has two INPUT terminals [AUDIO IN I/ AUDIO IN II]. Input pattern allows you to set up INPUT 1, INPUT 2, and INPUT 3 to each INPUT for sound function. (pp. 11, 35-37)

Press the SELECT button to display the input pattern dialog box. Use the Point ▲▼ buttons to move the pointer (red arrow) to the desired pattern and press the SELECT button to set the input pattern for sound function. Check mark appears next to the selected Input pattern.

### Side Control

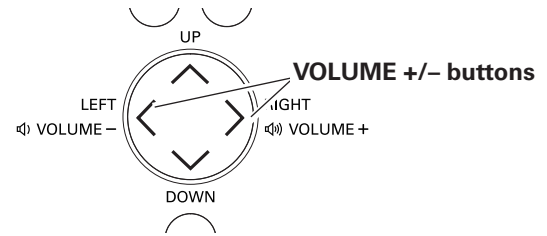

### Remote Control

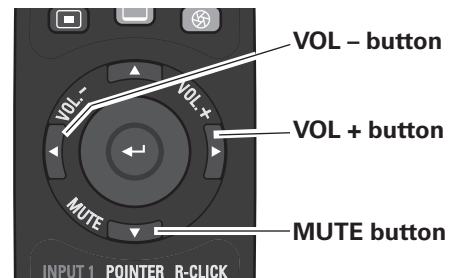

### Volume Dialog Box

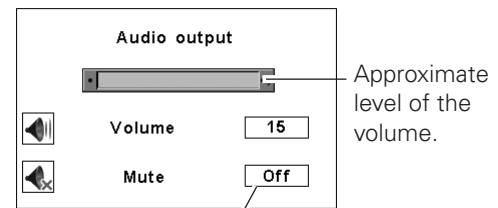

Press the MUTE button to set the Mute function On or Off. The dialog box disappears after 4 seconds.

### Sound Menu

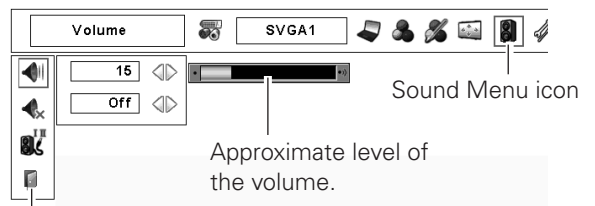

Exit the Sound Menu.

### Input Pattern Dialog Box

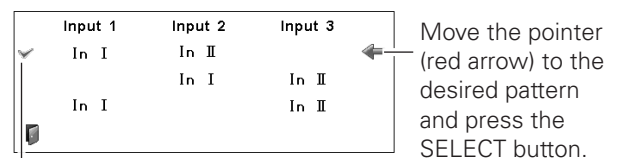

Selected Input Pattern

## Operating with Remote Control

Using the remote control for some frequently used operations is advisable. Just pressing one of the buttons enables you to make the desired operation quickly without calling up the On-Screen Menu.

### AUTO PC button

Press the AUTO PC button on the remote control to operate the Auto PC Adj. function. The computer screen adjustment can be done easily by pressing this button. See page 39 for details.

### SCREEN button

Press the SCREEN button on the remote control to select the desired screen size. The selected screen size symbol appears on the screen for 4 seconds. See pages 43 to 44 and 47 to 48 for details.

Press and hold the SCREEN button for more than 5 seconds to return all the screen size adjustment setting to the factory default setting.

### SHUTTER button

See page 30 for details.

### D.ZOOM button

Press the D.ZOOM button on the remote control to enter to the Digital zoom +/- mode. See page 44 for details.

### LENS SHIFT button

See page 30 for details.

### ZOOM buttons

Press the ZOOM buttons on the remote control to zoom in and out the image.

### FOCUS buttons

Press the FOCUS buttons on the remote control to adjust focus of the image.

### INFO. button

Information display can be used to confirm the current operating condition of the projector and the signal being projected through the projector.

Press the INFO. button on the remote control to display the information window on the screen. To hide the information window, press the INFO. button again or Point ◀▶ buttons.

The information window can also be selected from the menu.

**✓ Note:**

- The H- and V-sync freq. values described in the figure may be different from the actual values.
- SERIAL NO. is used to service the projector.

## Remote Control

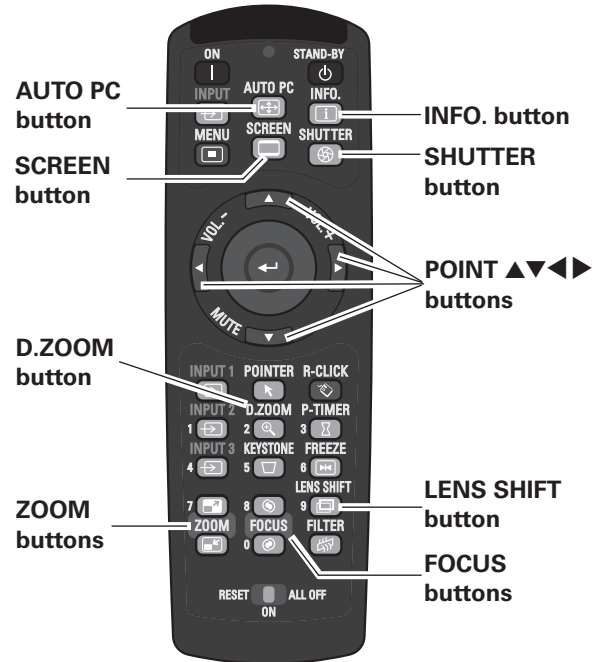

**✓ Note:**

- See the next page for the description of other buttons.

## Information Menu



Information Menu

|                    |                   |
|--------------------|-------------------|
| Input              | Input 1           |
|                    | RGB (PC analog)   |
| H-sync freq.       | 15.7 KHz          |
| V-sync freq.       | 30.0 Hz           |
| Screen             | Normal            |
| Language           | English           |
| Lamp status        |                   |
| Power management   | Ready 5 Min.      |
| Shutter management | Remote control On |
|                    | Projector Off     |
|                    | 180 Min           |
| Security           | Key lock          |
|                    | PIN code lock Off |
| Remote control     | Simple mode On    |
|                    | RC code Code 1    |
| SERIAL NO.         | G7802077          |

## MOUSE POINTER button

Move the pointer on the screen with this button.

## POINTER button

Press POINTER button on the remote control to display the Pointer on the screen.

## P-TIMER button

Press the P-TIMER button on the remote control. The Timer display "00 : 00" appears on the screen and starts to count time (00 : 00–59 : 59).

To stop the P-TIMER, press the P-TIMER button.

To cancel the P-TIMER, press the P-TIMER button again.



P-Timer display

## FREEZE button

Press the FREEZE button on the remote control to freeze the picture on the screen. To cancel the FREEZE function, press the FREEZE button again or press any other button.

## FILTER button

Press and hold the FILTER button for more than five seconds to operate electrically operated filter to replace the filter.

### ✓ Note:

- The filter cannot be rewound.
- When the filter is replaced, the total accumulated time of the filter use is automatically set to 0.

## KEYSTONE button

Press the KEYSTONE button on the remote control. The "Keystone" appears on the screen.

Use the Point ▲▼◀▶ buttons to correct keystone distortion. The keystone adjustment can be stored (pp.44, 48).

Reduce the upper width with Point ▲ button.

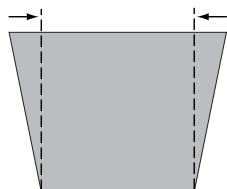

Reduce the lower width with Point ▼ button.

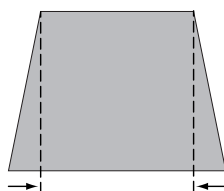

Reduce the left part with Point ◀ button.

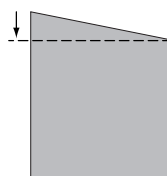

Reduce the right part with Point ▶ button.

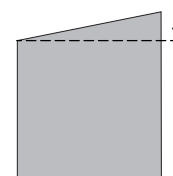

## Remote Control

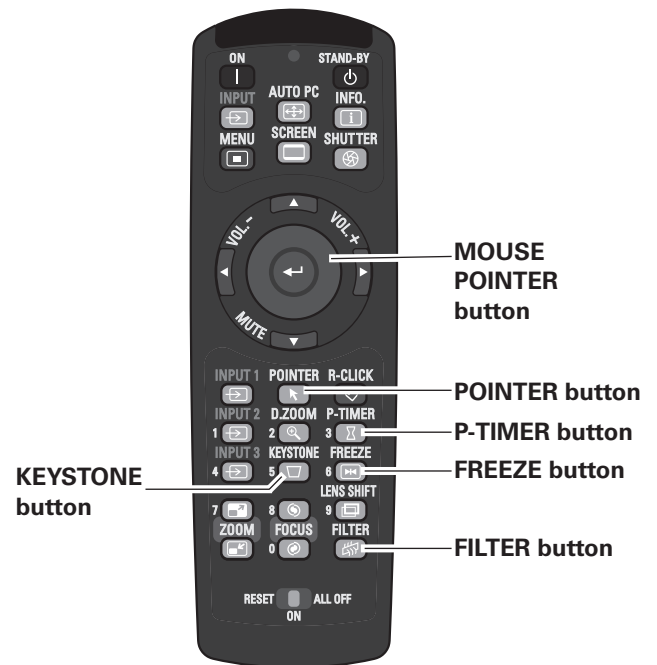

### ✓ Note:

- See the previous page for the description of other buttons.

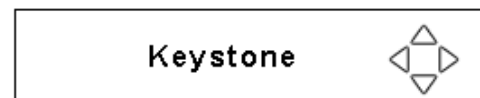

- The white arrows indicate that there is no correction.
- A red arrow indicates the direction of correction.
- An arrow disappears at the maximum correction.
- If you press the KEYSTONE button on the remote control again while the Keystone dialog box is being displayed, the keystone adjustment will be canceled.
- The adjustable range can be limited depending on the input signal.
- "Keystone" disappears after 10 seconds.



## Pointer Function

You can move the Pointer of the projector with the remote control to emphasize a part of the projected image.

- 1 Press the POINTER button to activate the Pointer function.
- 2 Use the MOUSE POINTER button to move the Pointer.
- 3 To cancel the Pointer function, press the POINTER button again or press any other button.

### Pointer

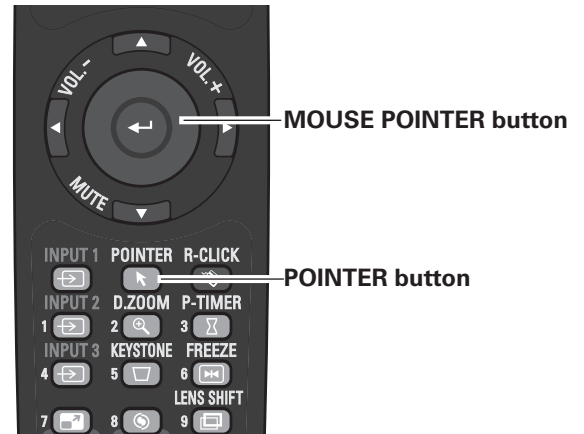
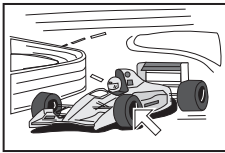

### ✓ Note:

- You can choose the pattern of Pointer (Arrow/Finger/Dot) in the Setting Menu (p. 56)

## Wireless Mouse Operation

The remote control can be used as a wireless mouse for your computer.

- 1 Before operating the wireless mouse, connect your computer and the projector with the supplied USB cable (p. 22).  
When the Pointer function is used, the wireless mouse is not available.
- 2 When a USB cable is connected to the computer and the projector, turn on the projector first, then the computer. If you turn on the computer first, the wireless mouse function may not operate properly.

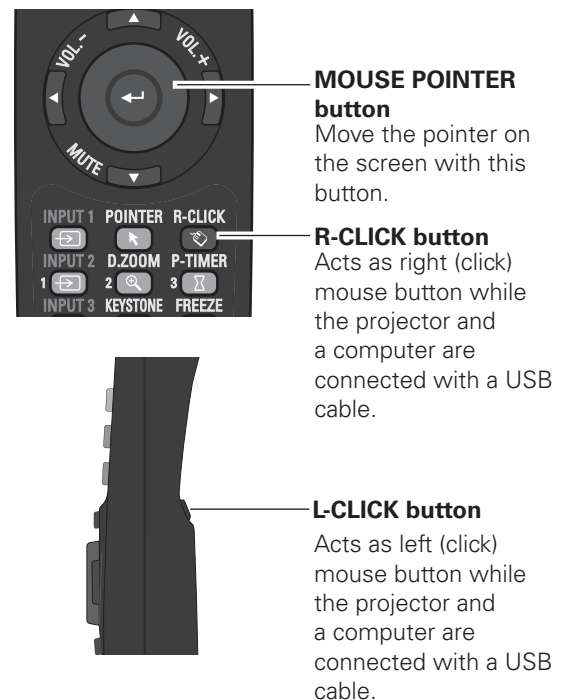

# Input Selection

## Input

### Side Control

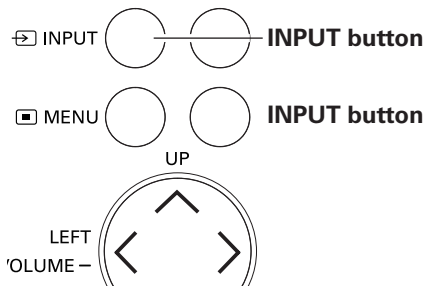

### Remote Control

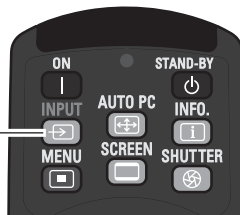

### Side Control/Remote control button operation

#### INPUT button

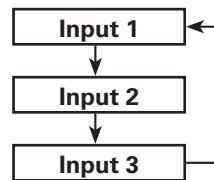

### Side Control/Remote control Operation

Press the INPUT button on the side control or the remote control. It switches to INPUT 1, INPUT 2, and INPUT 3 as you press the INPUT button.

Before using the INPUT button on the side control or the remote control, you must select a correct input source by On-Screen Menu and the latest input source will be displayed.

### Remote Control

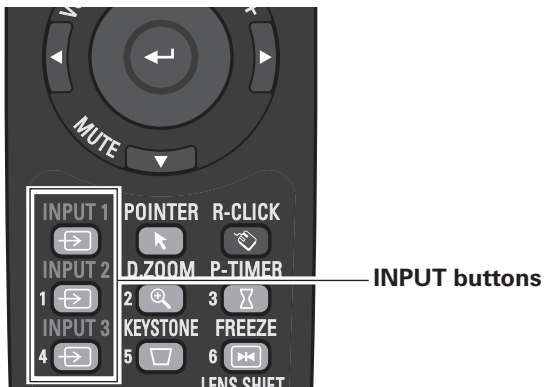

INPUT buttons

### Remote Control Operation

Press the INPUT 1, INPUT 2, or INPUT 3 buttons on the remote control. The input source appears on the screen as you press each button. Select the connected input source.

### Remote Control button operation

#### INPUT 1 button

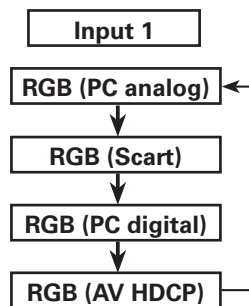

#### INPUT 2 button

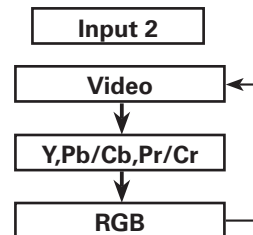

#### INPUT 3 button

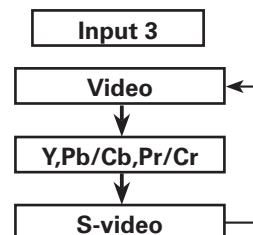

## Computer Input Source Selection

### Menu Operation

#### WHEN SELECTING INPUT 1 (COMPUTER INPUT TERMINALS )

- 1 Press the MENU button to display the On-Screen Menu. Use the Point ◀▶ buttons to move the red frame pointer to the INPUT Menu icon.
- 2 Use the Point ▲▼ buttons to move the red arrow pointer to the desired input and then press the SELECT button. The Source Select Menu appears.
- 3 Use the Point ▲▼ buttons to select the desired source and then press the SELECT button.

#### RGB (PC analog)

When your computer is connected to the INPUT 1 (ANALOG) terminal, select RGB (PC analog).

#### RGB (PC digital)

When your computer is connected to INPUT 1 (DIGITAL) terminal, select RGB (PC digital).

#### ✓ Note:

- INPUT SOURCE changes if the INPUT 1 button on the remote control is pressed.
- HDCP (High-bandwidth Digital Content Protection) is a system for protecting digital entertainment content which is delivered by DVI (Digital Visual Interface) from being copied. The specification of HDCP is decided and controlled by Digital Content Protection, LLC. Should the specification be changed, this projector may not display the digital content protected by HDCP.

#### INPUT MENU

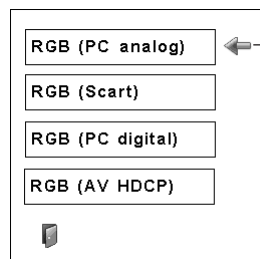
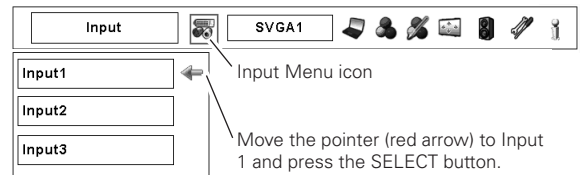

#### WHEN SELECTING INPUT 2 (5 BNC INPUT JACKS )

When connecting the computer output [5 BNC Type (Green, Blue, Red, Horiz. Sync, and Vert. Sync.)] from the computer to G, B, R, H/HV, and V jacks:

#### RGB

When your computer is connected to the INPUT 2 (5 BNC INPUT JACKS) terminal, select RGB.

#### INPUT MENU

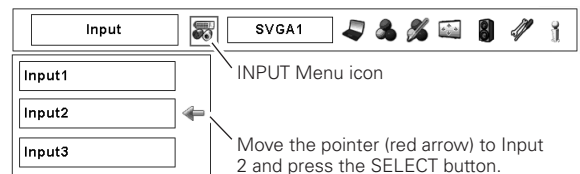

## Video Input Source Selection

### Menu Operation

#### WHEN SELECTING INPUT 1 (COMPUTER INPUT TERMINALS )

When connecting to video equipment, select the type of Video source in the Source Select Menu.

##### RGB (Scart)

When scart video equipment is connected to the INPUT 1 (ANALOG) terminal, select RGB (Scart).

##### RGB (AV HDCP)

If the HDCP-compatible signal source is connected to the INPUT 1 (DIGITAL) terminal, select RGB (AV HDCP).

#### INPUT MENU

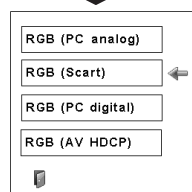
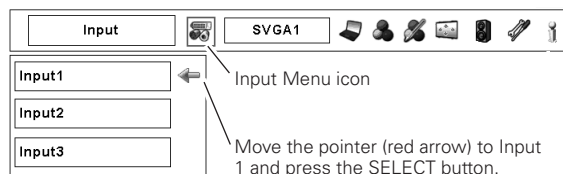

#### Source Select Menu

Move the pointer (red arrow) to RGB (Scart) or RGB (AV HDCP) and press the SELECT button.

#### WHEN SELECTING INPUT 2 (5 BNC INPUT JACKS )

When connecting to video equipment, select the type of Video source in the Source Select Menu.

##### Video

When the video input signal is connected to the VIDEO jack, select Video.

##### Y, Pb/Cb, Pr/Cr

When the video input signal is connected to the Y, Pb/Cb-Pr/Cr jacks, select Y, Pb/Cb, Pr/Cr.

#### INPUT MENU

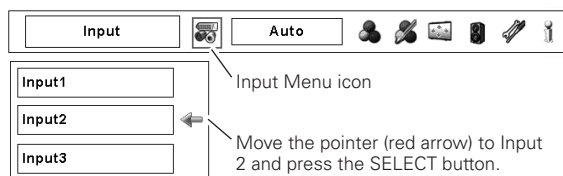

#### Source Select Menu

Move the pointer (red arrow) to Video or Y, Pb/Cb, Pr/Cr and press the SELECT button.

#### WHEN SELECTING INPUT 3 (AV TERMINALS )

When connecting to video equipment, select the type of Video source in the Source Select Menu.

##### Video

When the video input signal is connected to the VIDEO jack, select Video.

##### Y, Pb/Cb, Pr/Cr

When the video input signal is connected to the Y, Pb/Cb-Pr/Cr jacks, select Y, Pb/Cb, Pr/Cr.

##### S-Video

When the video input signal is connected to the S-VIDEO jack, select S-Video.

#### INPUT MENU

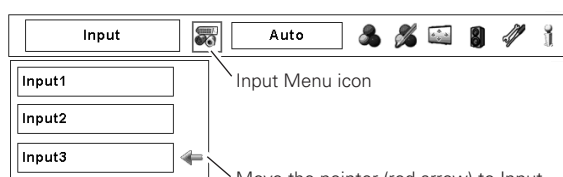

#### Source Select Menu

Move the pointer (red arrow) to the desired source and press the SELECT button.

# Computer Input

## Computer System Selection

### Automatic Multi-Scan System

This projector automatically tunes to various types of computers based on VGA, SVGA, XGA, SXGA, SXGA+, WXGA, UXGA or WUXGA (refer to “Compatible Computer Specifications” on pages 78–79). If a computer is selected as a signal source, this projector automatically detects the signal format and tunes to project a proper image without any additional settings. (Some computers need to be set manually.)

One of the following messages may appear when:

#### Auto

The projector cannot recognize the connected signal conforming to the provided PC Systems. The “Auto” is displayed on the System Menu box and the Auto PC Adjustment function works to display proper images. If the image is not projected properly, a manual adjustment is required. (pp. 40–41.)

-----

There is no signal input from the computer. Check the connection between your computer and the projector. (See “Troubleshooting” on page 69.)

#### Mode 1

The preset system is manually adjusted in the PC Adjust Menu. The adjusted data can be stored in the Mode 1–10. (pp. 40–41)

#### SVGA 1

PC systems provided in this projector is chosen. The projector chooses a proper system provided in the projector and displays it.

\* Mode 1 and SVGA 1 are examples.

### Selecting Computer System Manually

PC system can also be selected manually.

- 1 Press the MENU button to display the On-Screen Menu. Use the Point ◀▶ buttons to move the red frame pointer to the PC System Menu icon.
- 2 Use the Point ▲▼ buttons to move the red arrow pointer to the desired system, and then press SELECT button.

#### PC SYSTEM MENU

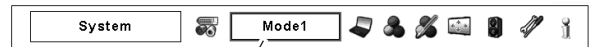

PC System Menu icon  
Selected system is displayed.

#### PC SYSTEM MENU

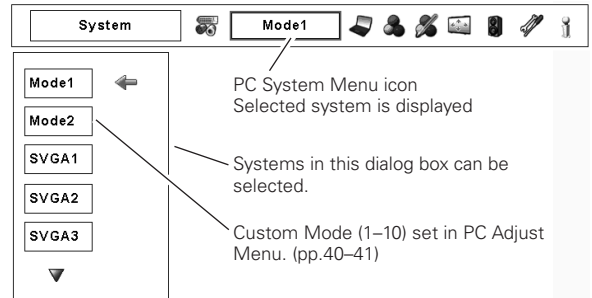

PC System Menu icon  
Selected system is displayed

Systems in this dialog box can be selected.

Custom Mode (1–10) set in PC Adjust Menu. (pp.40–41)

## Auto PC Adjustment

Auto PC Adjustment function is provided to automatically adjust Fine sync, Total dots, Horizontal and Vertical positions to conform to your computer.

### Direct Operation

The Auto PC adjustment function can be operated directly by pressing the AUTO PC button on the remote control.

### Remote Control

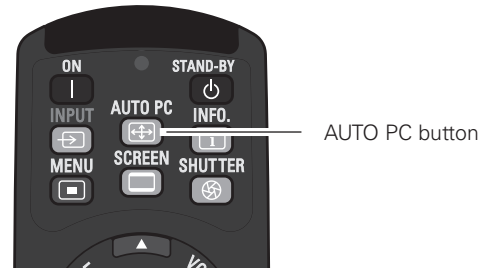

### Menu Operation



#### Auto PC adj.

- 1 Press the MENU button to display the On-Screen Menu. Use the Point ◀▶ buttons to move the red frame pointer to the PC Adjust Menu icon.
- 2 Use the Point ▲▼ buttons to move the red frame pointer to the AUTO PC adj. icon and then press the SELECT button twice.

#### To store the adjusted parameters.

The adjusted parameters from the Auto PC Adjustment can be stored in the projector. Once the parameters are stored, the setting can be done just by selecting Mode in PC SYSTEM Menu (p.38). See MANUAL PC ADJUSTMENT on pages 40–41.

#### ✓ Note:

- Fine sync, Total dots, Horizontal and Vertical position of certain computers cannot be fully adjusted with the Auto PC Adjustment function. When the image is not provided properly with this operation, manual adjustments are required. (pp. 40–41.)
- Auto PC Adjustment cannot be operated in Digital Signal Input on the DVI terminal and "480p," "575p," "480i," "575i," "720p," "1035i," or "1080i" is selected on the PC SYSTEM Menu.
- Depending on the condition of signals and the type and length of cables, the signals may not be properly viewed.

### PC ADJUST MENU

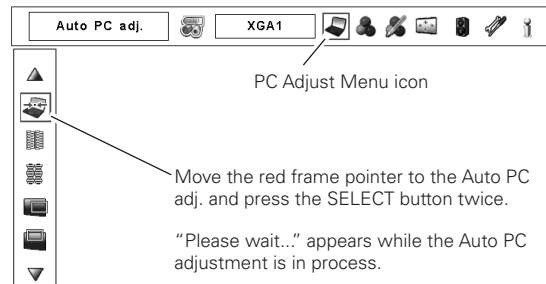

## Manual PC Adjustment

Some computers employ special signal formats which may not be tuned by Multi-Scan system of this projector. Manual PC Adjustment enables you to precisely adjust several parameters to match those special signal formats. The projector has 10 independent memory areas to store those parameters manually adjusted. It allows you to recall the setting for a specific computer.

**✓ Note:** The PC Adjust Menu cannot be operated when the digital signal input on the DVI terminal is selected on PC System Menu.

- 1 Press the MENU button to display the On-Screen Menu. Use the Point ◀▶ buttons to move the red frame pointer to the PC Adjust Menu icon.
- 2 Use the Point ▲▼ buttons to move the red frame pointer to the desired item and then press the SELECT button to display the adjustment dialog box. Use the Point ◀▶ buttons to adjust the setting value.

### Fine sync

Use the Point ◀▶ buttons to adjust the value, eliminating a flicker from the image displayed (from 0 to 31).

### Total dots

Use the Point ◀▶ buttons to adjust the number of total dots in one horizontal period to match your PC image.

### Position H

Use the Point ◀▶ buttons to adjust the horizontal picture position.

### Position V

Use the Point ◀▶ buttons to adjust the vertical picture position.

### Current mode

Press the SELECT button to show H-sync freq. and V-sync freq. of the connected computer.

### Clamp

Use the Point ◀▶ buttons to adjust the clamp level. When the image has dark bars, try this adjustment.

### Display area H

Use the Point ◀▶ buttons to adjust the horizontal area displayed by this projector.

### Display area V

Use the Point ◀▶ buttons to adjust the vertical area displayed by this projector.

## PC ADJUST MENU

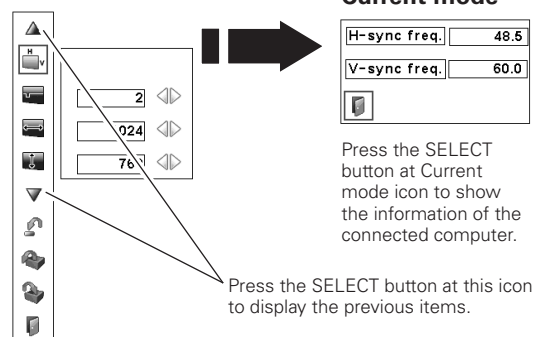
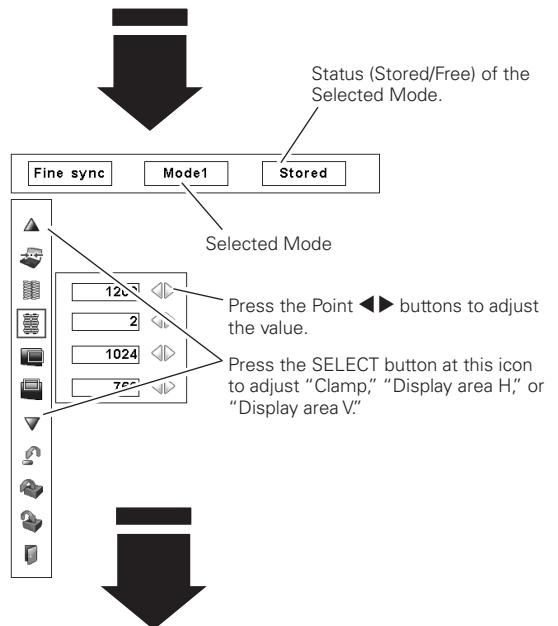
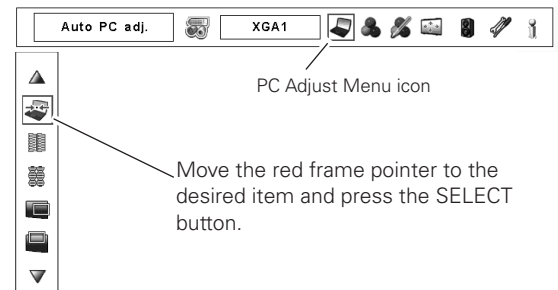





## Reset

To reset the adjusted data, select Reset and press the SELECT button. A confirmation box appears and then select [Yes]. All adjustments will return to their previous figures.



## Mode free

To clear the adjusted data, select Mode free and then press the SELECT button. Move the red arrow pointer to the Mode that you want to clear and then press the SELECT button.



## Store

To store the adjusted data, select Store and then press the SELECT button. Move the red arrow pointer to one of the Mode 1 to 10 in which you want to store, and then press the SELECT button.



## Quit

Exit the PC Adjust Menu.

### To clear the adjusted data.

Where to free?

|       |        |   |   |   |   |   |   |   |
|-------|--------|---|---|---|---|---|---|---|
| ▲     |        |   |   |   |   |   |   |   |
| Mode1 | Stored | 0 | 0 | 0 | 0 | 0 | 0 | ← |
| Mode2 | Free   | 0 | 0 | 0 | 0 | 0 | 0 |   |
| Mode3 | Free   | 0 | 0 | 0 | 0 | 0 | 0 |   |
| Mode4 | Free   | 0 | 0 | 0 | 0 | 0 | 0 |   |
| Mode5 | Free   | 0 | 0 | 0 | 0 | 0 | 0 |   |
| ▼     |        |   |   |   |   |   |   |   |

|       |
|-------|
| OK?   |
| Yes ← |
| No    |

Close this dialog box.

Confirmation box appears and then select [Yes].

### To store the adjusted data.

Where to store?

|       |        |   |   |   |   |   |   |   |
|-------|--------|---|---|---|---|---|---|---|
| ▲     |        |   |   |   |   |   |   |   |
| Mode1 | Stored | 0 | 0 | 0 | 0 | 0 | 0 | ← |
| Mode2 | Free   | 0 | 0 | 0 | 0 | 0 | 0 |   |
| Mode3 | Free   | 0 | 0 | 0 | 0 | 0 | 0 |   |
| Mode4 | Free   | 0 | 0 | 0 | 0 | 0 | 0 |   |
| Mode5 | Free   | 0 | 0 | 0 | 0 | 0 | 0 |   |
| ▼     |        |   |   |   |   |   |   |   |

This Mode has stored parameters.

Vacant

Values of "Total dots," "Position H," "Position V," "Display area H," and "Display area V."

Close this dialog box.

|       |
|-------|
| OK?   |
| Yes ← |
| No    |

Confirmation box appears and then select [Yes].

## Image Level Selection

### Menu Operation

- 1** Press the MENU button to display the On-Screen Menu. Use the Point ◀▶ buttons to move the red frame pointer to the Image Select Menu icon.
- 2** Use the Point ▲▼ buttons to move the red frame pointer to the desired image level and then press the SELECT button.



#### Standard

Normal picture level preset on the projector.



#### Real

Picture level with improved halftone for graphics.



#### IMAGE 1-10

User preset picture adjustment in the Image Adjust Menu. (p. 51)

### IMAGE SELECT MENU

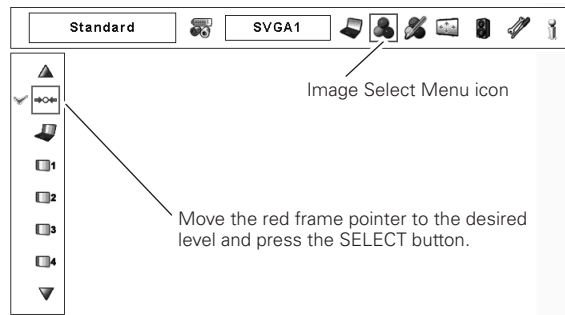

## Screen Size Adjustment

Select the desired screen size that conforms to the input signal source.

- 1 Press the MENU button to display the On-Screen Menu. Use the Point ◀▶ buttons to move the red frame pointer to the Screen Menu icon.
- 2 Use the Point ▲▼ buttons to move the red frame pointer to the desired function and then press the SELECT button.



### Normal

Provide the image at the normal computer aspect ratio of 4:3.



### True

Provide the image in its original size. When the original image size is larger than the screen size (1024 x 768), the projector enters to the panning mode automatically. Use the Point ▲▼◀▶ buttons to pan the image. When adjusted, the arrows will turn red. When reached to the correction limits, the arrows will disappear.



### Wide

Provide the image to fit the wide video aspect ratio (16:9) by expanding the image width uniformly. This function can be used to provide the squeezed video signal at 16:9.



### Full screen

Provides the full screen image.



### Custom

Adjust the screen scale and position manually with this function. Press the SELECT button at Custom and the "Custom" is displayed on the screen for a few seconds. To display the Aspect dialog box, press the SELECT button at Custom again and then the Aspect dialog box appears.

- Scale H/V..... Adjust the Horizontal/Vertical screen scale.
- H&V..... When set to "On," the aspect ratio is fixed. The "Scale V" appears dimmed and becomes unavailable. Adjust "Scale H," then the screen scale is automatically modified based on the aspect ratio.
- Position H/V..... Adjust the Horizontal/Vertical screen position.
- Common ..... Save the adjusted scale to all the inputs. Press the SELECT button at Common to display a confirmation box. To save the scale, press the SELECT button at "Yes." When Custom is selected, the saved scale is used.
- Reset..... Reset the all adjusted values. Press the SELECT button at Reset to display a confirmation box. To reset, press the SELECT button at "Yes."

### SCREEN MENU

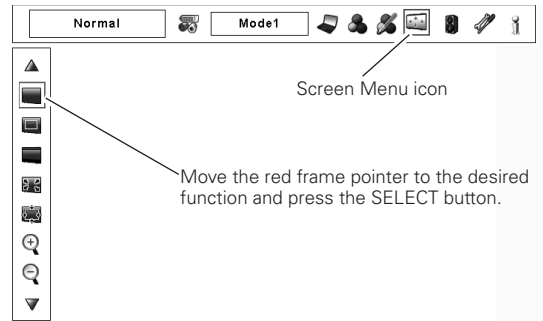

#### ✓ Note:

- The projector cannot display any resolution higher than 1920 x 1200. If your computer's screen resolution is higher than 1920 x 1200, lower the resolution before connecting the projector.
- The image data other than XGA (1024 x 768) is modified to fit the screen size in initial mode.
- True, Full screen, and Digital zoom +/- cannot be selected when no signal is detected in the PC System Menu. (p.38)

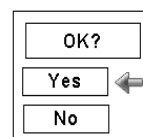
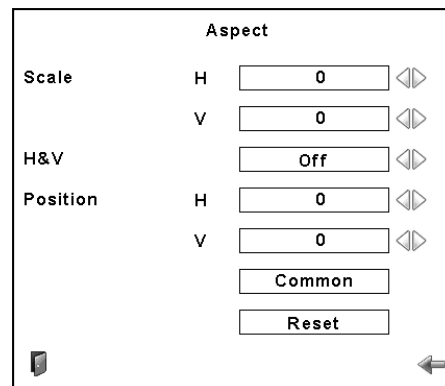

Press the SELECT button at Common or Reset, to display a confirmation box.

#### ✓ Note:

- When no signal is detected, "Normal" is set automatically and the Aspect dialog box disappears.
- The adjustable range for Scale H/V and Position H/V is limited depending on the input signal.



## Keystone

This function is used to store or reset the keystone correction when the AC power cord is unplugged. Use the Point ◀▶ buttons to switch between each option.

Store. . . Keep the keystone correction even when the AC power cord is unplugged.

Reset . . Release the keystone correction when the AC power cord is unplugged.

To correct keystone distortion, press the Select button. The Keystone dialog box appears. Use the Point ▲▼◀▶ buttons to correct keystone distortion. (p.33)



## Ceiling

When this function is set to "On," the picture is top/bottom and left/right reversed. This function is used to project the image from a ceiling-mounted projector.



## Rear

When this function is set to "On," the picture is left/right reversed. This function is used to project the image from the rear of the screen.



## Reset

This function returns all adjusted values to the factory default settings. Press the SELECT button at Reset to display a confirmation box. To reset, press the SELECT button at "Yes."



## Quit

Exit the Screen Size Adjustment Menu.

## For zooming in and out the images



## Digital zoom +

Select Digital zoom +. The On-Screen Menu disappears and "D. zoom +" appears. Press the SELECT button to expand the image size. Use the Point ▲▼◀▶ buttons to pan the image. The Panning function can work only when the image is larger than the screen size.

You can also enter the Digital zoom + mode by pressing the D.ZOOM button on the remote control.



## Digital zoom -

Select Digital zoom -. The On-Screen Menu disappears and "D. Zoom -" appears. Press the SELECT button to compress the image size.

You can also enter the Digital zoom - mode by pressing the D.ZOOM button on the remote control.

To exit the Digital Zoom +/- mode, press any button except the D.ZOOM , SELECT, and Point buttons.

## SCREEN MENU

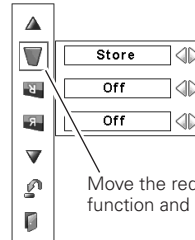

Move the red frame pointer to the desired function and press the SELECT button.

## Ceiling

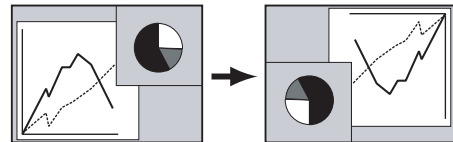

## Rear

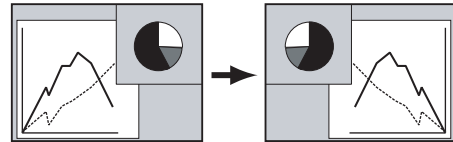

## ✓ Note:

- The panning function may not operate properly if the stored Mode in the PC Adjust Menu is used. (p. 41)
- The minimum compression ratio can be limited depending on the input signal or when the Keystone function is working.
- Digital zoom +/- cannot be selected when Full screen or True is selected.
- Digital zoom - cannot be operated when Custom is selected.

# Video Input

## Video System Selection

- 1 Press the MENU button to display the On-Screen Menu. Use the Point ◀▶ buttons to move the red frame pointer to the AV System Menu icon.
- 2 Use the Point ▲▼ buttons to move the red arrow pointer to the desired system and then press the SELECT button.

## Video Jack or S-Video Jack

### Auto

The projector automatically detects an incoming video system, and adjusts itself to optimize its performance.

When Video System is PAL-M or PAL-N, select the system manually.

### PAL/SECAM/NTSC/NTSC4.43/PAL-M/PAL-N

If the projector cannot reproduce proper video image, select a specific broadcast signal format from among PAL, SECAM, NTSC, NTSC 4.43, PAL-M, and PAL-N.

### AV SYSTEM MENU (VIDEO OR S-VIDEO)

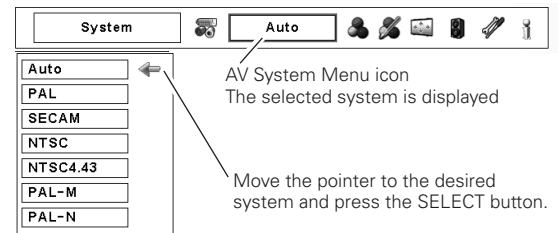

## Y, Pb/Cb, Pr/Cr Jacks

### Auto

The projector automatically detects an incoming video signal, and adjusts itself to optimize its performance.

When the Video System is 1035i or 1080i, select the system manually.

### COMPONENT VIDEO SIGNAL FORMAT

If the projector cannot reproduce proper video image, select a specific component video signal format from among 480i, 575i, 480p, 575p, 720p, 1035i, and 1080i.

### AV SYSTEM MENU (COMPONENT VIDEO)

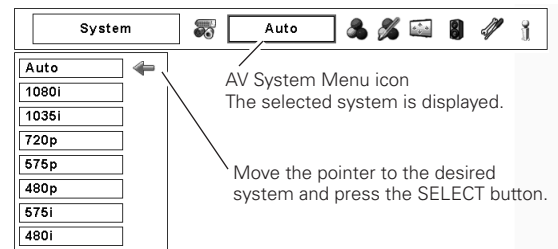

## Image Level Selection

### Menu Operation

- 1** Press the MENU button to display the On-Screen Menu. Use the Point ◀▶ buttons to move the red frame pointer to the Image Select Menu icon.
- 2** Use the Point ▲▼ buttons to move the red frame pointer to the desired image level and then press the SELECT button.



#### Standard

Normal picture level preset on the projector.



#### Cinema

Picture level adjusted with fine tone.



#### IMAGE 1-10

User preset picture adjustment in the Image Adjust Menu. (p. 51)

### IMAGE SELECT MENU

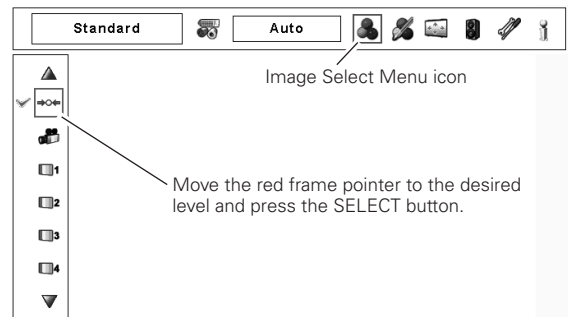

## Screen Size Adjustment

- 1 Press the MENU button to display the On-Screen Menu. Use the Point ◀▶ buttons to move the red frame pointer to the Screen Menu icon.
- 2 Use the Point ▲▼ buttons to move the red frame pointer to the desired function and then press the SELECT button.



### Normal

Provide the image at the normal video aspect ratio of 4:3.



### Wide

Provide the image at the wide screen ratio of 16:9.



### Custom

Adjust the screen scale and position manually with this function. Press the SELECT button at Custom and the "Custom" is displayed on the screen for a few seconds. To display the Aspect dialog box, press the SELECT button at Custom again and then the Aspect dialog box appears.

- Scale H/V ..... Adjust the Horizontal/Vertical screen scale.
- H&V ..... When set to "On," the aspect ratio is fixed. The "Scale V" appears dimmed and becomes unavailable. Adjust "Scale H," then the screen scale is automatically modified based on the aspect ratio.
- Position H/V ..... Adjust the Horizontal/Vertical screen position.
- Common ..... Save the adjusted scale to all the inputs. Press the SELECT button at Common to display a confirmation box. To save the scale, press the SELECT button at "Yes." When Custom is selected, the saved scale is used.
- Reset ..... Reset the all adjusted values. Press the SELECT button at Reset to display a confirmation box. To reset, press the SELECT button at "Yes."

### SCREEN MENU



#### ✓ Note:

- Wide cannot be operated when "720p," "1035i," or "1080i" is selected on AV System Menu (p.45).

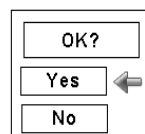
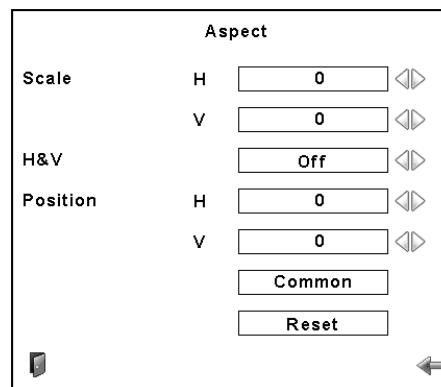

Press the SELECT button at Common or Reset, to display a confirmation box.

#### ✓ Note:

- When no signal is detected, "Normal" is set automatically and the Aspect dialog box disappears.
- The adjustable range for Scale H/V and Position H/V is limited depending on the input signal.



# Video Input



## Keystone

This function is used to store or reset the keystone correction when the AC power cord is unplugged. Use the Point ◀▶ buttons to switch between each option.

Store. . . Keep the keystone correction even when the AC power cord is unplugged.

Reset . . Release the keystone correction when the AC power cord is unplugged.

To correct keystone distortion, press the Select button. The Keystone dialog box appears. Use the Point ▲▼◀▶ buttons to correct keystone distortion. (p.33)



## Ceiling

When this function is set to "On," the picture is top/bottom and left/right reversed. This function is used to project the image from a ceiling-mounted projector.



## Rear

When this function is set to "On," the picture is left/right reversed. This function is used to project the image from the rear of the screen.



## Reset

This function returns all adjusted values to the factory default settings. Press the SELECT button at Reset to display a confirmation box. To reset, press the SELECT button at "Yes."



## Quit

Exit the Screen Size Adjustment Menu.

## SCREEN MENU

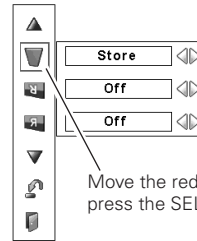

Move the red frame pointer to a function and press the SELECT button.

## Ceiling

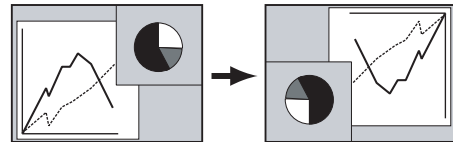

## Rear

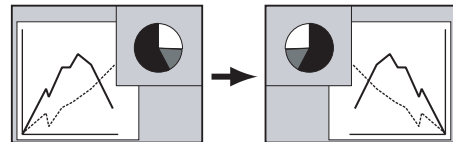

# Picture Image

## Image Adjustment

- 1 Press the MENU button to display the On-Screen Menu. Use the Point ◀▶ buttons to move the red frame pointer to the Image Adjust Menu icon.
- 2 Use the Point ▲▼ buttons to move the red frame pointer to the desired item and then press the SELECT button to display the adjustment dialog box. Use the Point ◀▶ buttons to adjust the setting value.



### Contrast

Press the Point ◀ button to decrease contrast; press the Point ▶ button to increase the contrast (from 0 to 63).



### Brightness

Press the Point ◀ button to decrease the brightness; press the Point ▶ button to increase the brightness (from 0 to 63).



### Color \*

Press the Point ◀ button to decrease the intensity of the color; press the Point ▶ button to increase the intensity of the color (from 0 to 63).



### Tint \*

Press the Point ◀▶ buttons to adjust the tint value to obtain proper color balance (from 0 to 63).



### Color Management

The Color Management function can be used to adjust the LEVEL, PHASE, and GAMMA of the selected display colors (except for black, white, and gray) on the screen and replace these colors with other colors if required.

You can store up to eight (8) color management data.

- 1 Use the Point ▲▼ buttons to move the red frame pointer to Color Management, and then press the SELECT button. The projected image freezes, and the COLOR MANAGEMENT POINTER appears.
- 2 Use the Point ▲▼◀▶ buttons to move the pointer to the spot where you want to adjust the color and then press the SELECT button. The COLOR SELECTION window appears, and the color in the center of the pointer is selected and you can adjust the color.
- 3 Use the Point ▲▼◀▶ buttons to adjust the LEVEL and PHASE of the color, and then press the SELECT button to confirm the setting. Then use the Point ▲▼ buttons to adjust the GAMMA for the color and press the SELECT button to accept the setting. After adjusting, press the SELECT button to go to the COLOR MANAGEMENT LIST.

## COLOR SELECTION MODE

### LIST

Go to the COLOR MANAGEMENT LIST.

## IMAGE ADJUST MENU

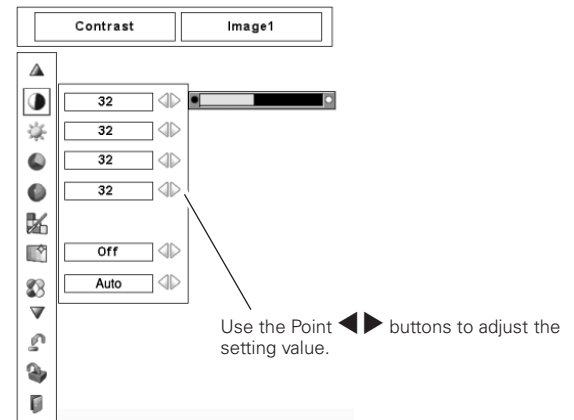
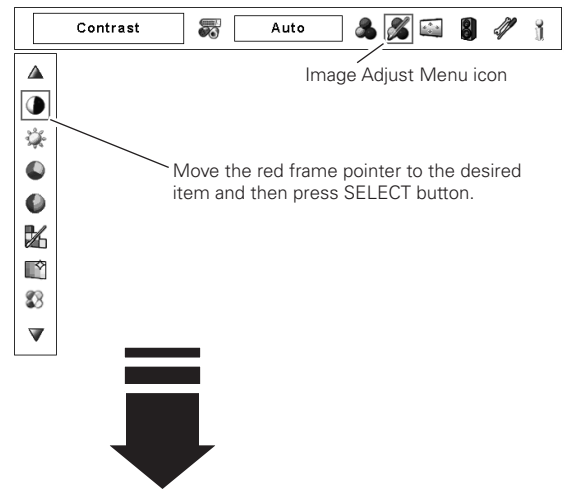

## POINTER MODE

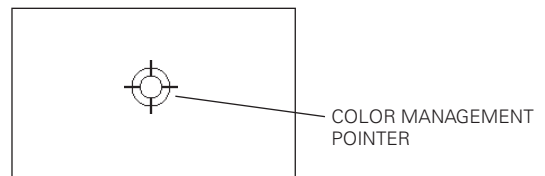

### ✓ Note:

- \* Displayed only in Video Input.
- Tint cannot be selected when the video system is PAL, SECAM, PAL-M, or PAL-N (p.45).

## COLOR SELECTION MODE (continued)

### COLOR M.

Return to the COLOR MANAGEMENT POINTER. (If you press the MENU button on the side control or the remote control, it returns to the COLOR MANAGEMENT POINTER and you will need to reselect and readjust the color.)

### MENU

Return to the IMAGE ADJUST Menu. Any settings that have been changed will not be stored. To store the changed settings, be sure to select "LIST" and go to the COLOR MANAGEMENT LIST.

- 4** In the COLOR MANAGEMENT LIST, the adjusted color data are checkmarked. You can decide whether or not to apply the adjusted color data in the list to the projected image (see below).

## LIST MODE



Clear the check mark if you do not want to apply the adjusted color data; select the check mark and then press the SELECT button. The check mark disappears.

### COLOR PALETTE

Return to the COLOR SELECTION mode so that you can readjust the setting for the color in that line. (This option is not available if the check mark is cleared.)

### DEL

Select the DEL box if you want to delete the adjusted data. Press the SELECT button and a confirmation box appears and then select [Yes]

### ALL DEL

Delete all the data in the list. Press the SELECT button and a confirmation box appears and then select [Yes].

### MENU

The same function as stated above.

### COLOR M.

The same function as stated above.



### Auto picture control

Use the Point ◀▶ buttons to select the desired Auto picture control position (Off, L1 or L2).

Off . . . . Auto picture control OFF position.

L1 . . . . Auto picture control LEVEL 1 position.

L2 . . . . Auto picture control LEVEL 2 position.



### Advanced color

Use the Point ◀▶ buttons to select the advanced color mode.

Off . . . . Advanced color mode is "Off"

Auto . . . . Advanced color according to the type of image.



### Color temp.

Use the Point ◀▶ buttons to select the desired Color temp. level (High, Mid, Low, or XLow).

## COLOR SELECTION MODE

Level and phase adjustment palette.

Gamma adjustment palette.

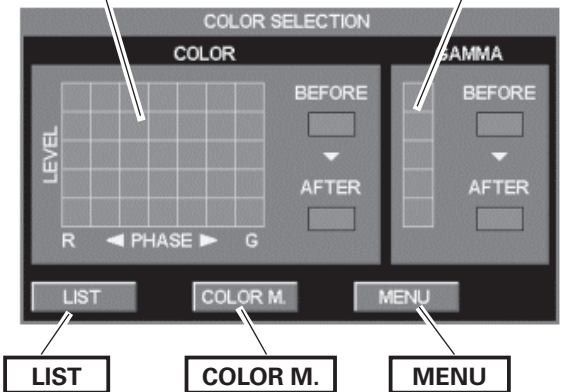

## LIST MODE

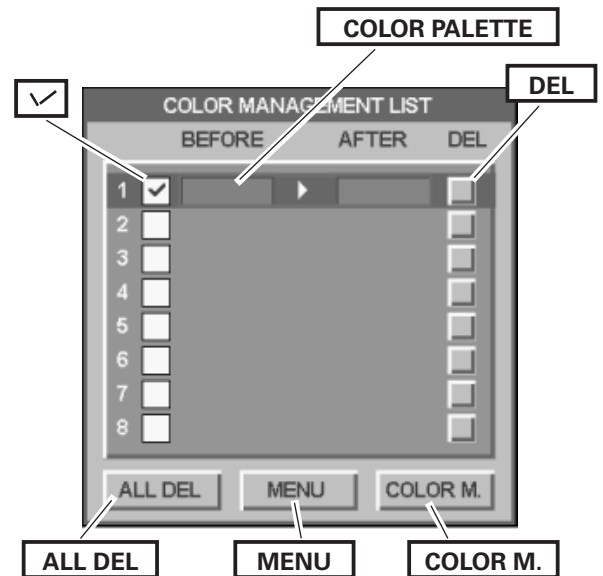



## White balance (Red/Green/Blue)

Press the Point ◀ button to lighten red/green/blue tone; press the Point ▶ button to deepen red/green/blue tone (from 0 to 63).



## Offset (Red/Green/Blue)

Press the Point ◀ button to lighten red/green/blue tone of the black level of an image; press the Point ▶ button to deepen red/green/blue tone of the black level of an image (from 0 to 63).



## Sharpness

Press the Point ◀ button to decrease the sharpness of the image; press the Point ▶ button to increase the sharpness of the image (from 0 to 31).



## Gamma

Use the Point ◀▶ buttons to adjust the gamma value to obtain a better balance of contrast (from 0 to 15).



## Noise reduction \*

Noise interference on the screen can be reduced. Press the Point ◀▶ buttons to change the noise reduction mode.

- Off . . . . Noise reduction mode is "Off"
- On . . . . Noise reduction mode is "On"



## Progressive \*

An interlaced video signal can be displayed in progressive mode.

Press the Point ◀▶ buttons to change the progressive scan mode.

- Off . . . . Progressive scan mode is "Off."
- On . . . . Progressive scan mode is "On."
- Film . . . For watching a film. With this function, the projector reproduces pictures faithful to the original film quality.



## Reset

To reset the adjusted data, select Reset and press the SELECT button. A confirmation box appears and then select [Yes]. All adjustments will return to their previous figures.



## Store

To store the adjusted data, move the red frame pointer to the Store icon and press the SELECT button. The Image Level Menu appears. Move the red arrow pointer to any of the Image 1 to 10 in which you want to set and press the SELECT button. A confirmation box appears and then select [Yes].



## Quit

Exit the Image Adjust Menu.

### ✓ Note:

- \* Displayed only in Video Input.
- When the White balance Red, Green, or Blue is adjusted, the Color temp. level will change to "Adj."
- Progressive cannot be selected when "480p," "575p," or "720p" is selected (p.45).

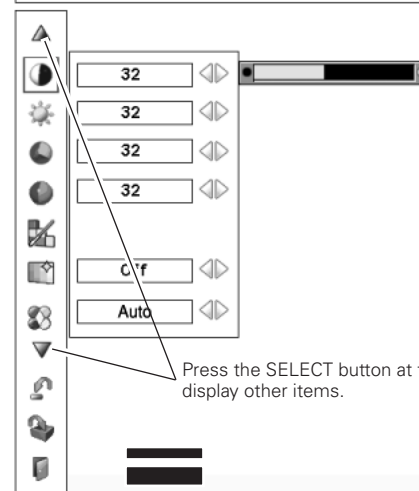

Press the SELECT button at this icon to display other items.

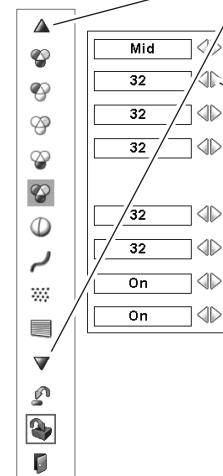

Press the SELECT button at this icon to display the previous items.

Press the Point ◀▶ buttons to adjust the setting value.

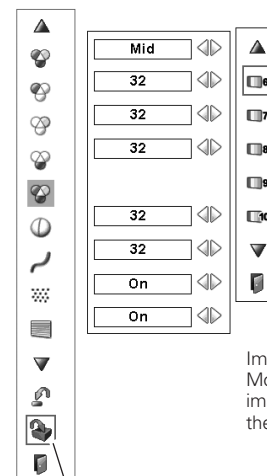

Image Level Menu  
Move the red frame pointer to an image item to be set and then press the SELECT button.

Store icon  
Press the SELECT button at this icon to store the adjustment.

# Setting

## Setting

This projector has a Setting menu that allows you to set up other various functions.

- 1 Press the MENU button to display the On-Screen Menu. Use the Point ◀▶ buttons to move the red frame pointer to the Setting Menu icon.
- 2 Use the Point ▲▼ buttons to move the red frame pointer to the desired item and then press the SELECT button. The Setting dialog box appears.

### Language

The language used in the On-Screen Menu is available in English, German, French, Italian, Spanish, Portuguese, Dutch, Swedish, Russian, Chinese, Korean, or Japanese.

### Menu

This function allows you to adjust the position of the On-Screen Display and the value adjustment bar in the Picture Image Adjustment Menu.

### Position

This function is used to adjust the On-Screen Menu display position. Press the SELECT button and the adjustment screen appears (arrows appear). Use the Point ▲▼◀▶ buttons to adjust the position. After making the adjustment, press the SELECT button to return to the Menu screen.

### Simple menu

When this function is set to "On," the value adjustment bar in the Picture Image Adjustment Menu appears on the screen.

### Display

This function decides whether to display On-Screen Displays.

- On . . . . . Shows all the On-Screen Displays. Use this function when you want to project images after the lamp becomes bright enough. The factory default setting is in this option.
- Countdown Off. . . Show the input image instead of the countdown when turning on the projector. Use this function when you want to project the image as early as possible even when the lamp is not bright enough.
- Off . . . . . Hide the On-Screen Displays except:
  - On-Screen Menu
  - "Power off?" (p.27)
  - Color management operation screen (pp.49-50)
  - "No signal" for Power management (p.56)
  - P-TIMER (p.33)
  - "Please wait..." for Auto PC adjustment (p.39)
  - Arrows for the True function in the Screen Menu (p.43)
  - Exclamation mark when non-simple mode buttons are pressed while the simple mode is set to "On." (p.55)

### SETTING MENU (Language)

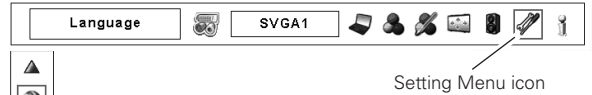

Set the red frame pointer to the item and press the SELECT button.



Press the SELECT button at Language, then the Language Menu appears.

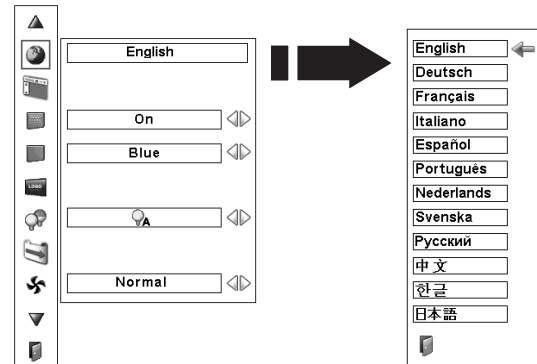

### Menu

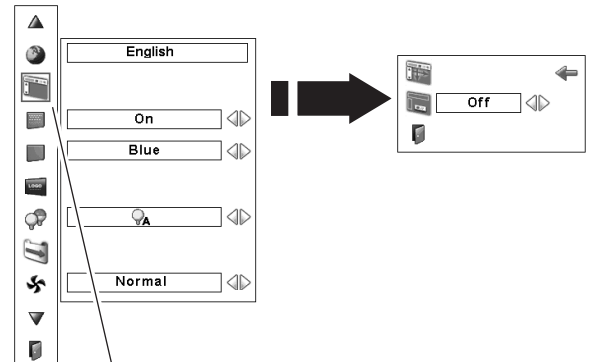

Set the red frame pointer to the item and press the SELECT button.

## Background

The selected background screen will be displayed when no input signal is detected.

- Blue . . . Blue colored background.
- User . . . The image you captured.
- Black . . . Black colored background.

## Logo

This function allows you to customize the screen logo with Logo select, Capture, and Logo PIN code lock functions.

### ✓ Note:

- When "On" is selected in the Logo PIN code lock function, Logo select and Capture functions cannot be selected.

## Logo select

This function decides on the starting-up display from among the following options.

- User . . . Show the image you captured.
- Default . . Show the factory-set logo.
- Off . . . . Show the countdown display only.

## Capture

This function enables you to capture an image being projected to use it for a starting-up display or interval of presentations.

Select Capture and press the SELECT button.

A confirmation box appears and select [Yes] to capture the projected image.

After capturing the projected image, go to the Logo select function and set it to "User." Then the captured image will be displayed the next time you turn on the projector.

To cancel the Capture function, select [No].

### ✓ Note:

- Before capturing an image, select "Standard" in the Image Select Menu to capture a proper image. (pp. 42, 46)
- A signal from a computer can be captured up to XGA (1024 X 768).
- Certain signals may not be captured properly.
- When capturing the image that has been adjusted by the Keystone function, the adjusted data is automatically reset and the projector captures an image without keystone correction.
- When starting to capture a new image, the previously stored image is cleared even if you cancel the capturing.
- Once you exit the Logo Menu after setting the Logo lock to "On," you are required to enter the PIN code every attempting to change the Logo setting.
- "User" cannot be selected when the image is not captured.

### ✓ Note:

- "User" cannot be selected when the image is not captured.

## Logo

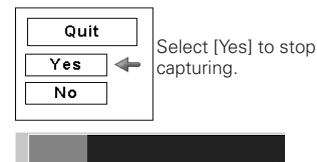
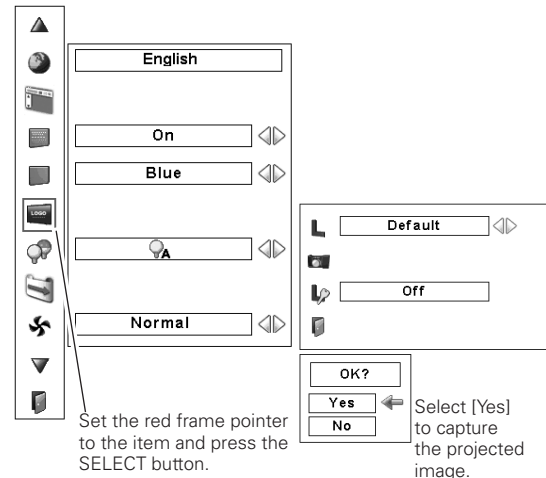

## Capture

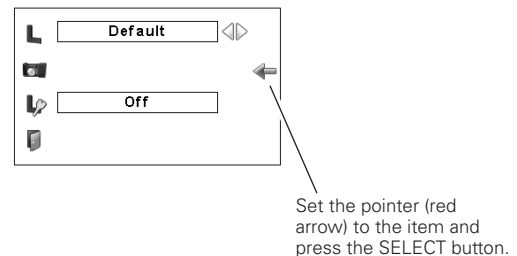



## Logo PIN code lock

This function prevents an unauthorized person from changing the screen logo.

- Off . . . . The screen logo can be changed freely from the Logo Menu.
- On . . . . The screen logo cannot be changed without a Logo PIN code.

If you want to change the Logo PIN code lock setting, press the SELECT button and the Logo PIN code dialog box appears. Enter a Logo PIN code by following the steps below. The initial Logo PIN code is set to "4321" at the factory.

### Enter a Logo PIN code

Use the Point ▲▼ buttons on the side control or Number buttons on the remote control to enter a number.

#### When using side control

Use the Point ▲▼ buttons on the side control to select a number. Press the Point ► button to fix the number and move the red frame pointer to the next box. The number changes to "\*." Repeat this step to complete entering a four-digit number. After entering the four-digit number, move the pointer to "Set." Press the SELECT button so that you can change the Logo PIN code lock setting.

#### When using remote control

Press the Number buttons on the remote control to enter a number (p.15). When you complete entering a four-digit number, the pointer moves to "Set." Press the SELECT button so that you can change the Logo PIN code lock setting.

If you fixed an incorrect number, use the Point ◀ button to move the pointer to the number you want to correct, and then enter the correct number.

If you entered an incorrect PIN code, "Logo PIN code" and the number (\*\*\*\*) will turn red for a moment. Enter the correct PIN code all over again.

### Change the Logo PIN code lock setting

Use the Point ◀▶ buttons to switch On/Off, and then press the Point ▼ button to move the pointer to "Quit." Press the SELECT button to close the dialog box.

### Change the Logo PIN code

Logo PIN code can be changed to your desired four-digit number. Press the Point ▼ button to select "Logo PIN code change" and then press the SELECT button. The New Logo PIN code input dialog box appears. Set a new Logo PIN code.

Be sure to note the new Logo PIN code and keep it on hand. If you lost the number, you could no longer change the Logo PIN code setting. For details on PIN code setting, refer to "PIN code lock" on pages 57-58.

### Logo PIN Code Lock

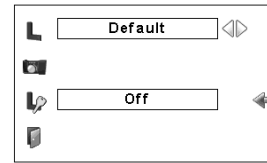

### Enter a Logo PIN code

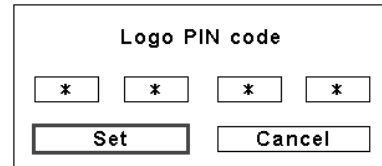

After a correct Logo PIN code is entered, the following dialog box appears.

### Change the Logo PIN code lock setting



Use the Point ◀▶ buttons to switch On/Off,

### Change the Logo PIN code

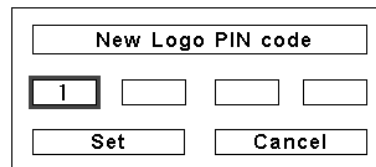

#### CAUTION:

**WHEN YOU HAVE CHANGED THE LOGO PIN CODE, WRITE DOWN THE NEW PIN CODE IN COLUMN OF THE LOGO PIN CODE NO. MEMO ON PAGE 83, AND KEEP IT SECURELY. SHOULD THE LOGO PIN CODE BE LOST OR FORGOTTEN, THE LOGO PIN CODE SETTING CAN NO LONGER BE CHANGED.**





## Lamp control

This function allows you to change the brightness of the screen.

- Auto . . . . . Brightness according to the input signal.
- Normal . . . . . Normal brightness.
- Eco 1. . . . . Lower brightness and Fan control set to Normal. Lower brightness reduces the lamp power consumption and extends the lamp life.
- Eco 2. . . . . Lower brightness and Fan control set to Max. Lower brightness reduces the lamp power consumption and extends the lamp life. It is recommended to use Eco 2 when using the projector continuously over a long period of time. The fan noise becomes louder in Eco 2 than in Eco 1. Select the suitable mode for the used environment.



## Filter control

You can replace the filter with this function. Press the SELECT button at Filter control to display a confirmation box. To replace, press the SELECT button at "YES" and the electrically operated filter starts to scroll.

You can also replace the filter by using the remote control (p. 33).



## Fan control

Choose the running speed of cooling fans from the following options.

- Normal..... Operate in this mode under normal conditions.
- Max ..... Use this mode when you want to increase the cooling effect when operating the projector in high ambient temperature environment. Fan noise is louder than "Normal".



## Remote control

This function allows you to change the Simple mode and RC code setting on the remote control.

### Simple mode

This function decides whether to activate the simple mode.

- Off . . . . . Simple mode function is off.
- On . . . . . Only the simple mode buttons are active.

### RC code

The eight different remote control codes (Code 1–Code 8) are assigned to the projector; the factory-set, initial code (Code 1) and the other seven codes (Code 2 to Code 8). After selecting the RC code, move the red arrow pointer to the Quit icon and press the SELECT button to set the RC code.

The same code should set on both the projector and the remote control. For example, operating the projector in "Code 7"; the remote control code also must be switched to "Code 7".

### To change the code for the projector:

Select a remote control code in this Setting Menu.

### To change the code for the remote control:

Press and hold the MENU button and a number button (1–8) on the remote control for more than five seconds to switch between the codes (p. 17).

### ✓ Note:

- Filter replacement icon and "Please wait..." message appear on the screen when the filter is being scrolled.
- The filter cannot be rewound.
- When the filter is replaced, the total accumulated time of the filter use is automatically set to 0.

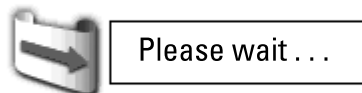

### Remote control

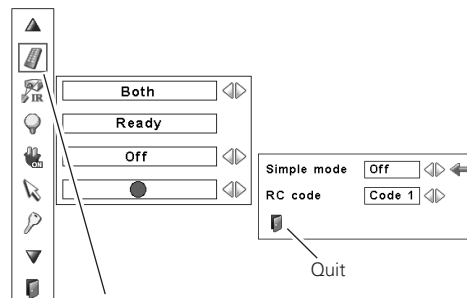

When pressing the SELECT button at Remote control, the Remote control menu appears.

### Simple mode buttons

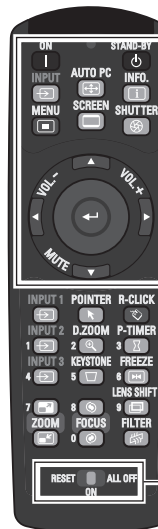

Only these buttons are active when the simple mode is set to "On." [ON, STAND-BY, INPUT, AUTO PC, INFO., MENU, SCREEN, SHUTTER, ▲▼◀▶, SELECT, VOL.+, VOL.-, MUTE, RESET/ON/ALL-OFF switch]  
Number buttons (p.15) also become active only when setting the remote control codes numbers or entering the PIN code numbers (pp. 54, 58).

### ✓ Note:

- If you do not select the Quit icon and exit the Remote control menu, the RC code will not be set.



## RC sensor

Select a location of the infrared remote receiver of the remote control. See "Remote Control Receivers and Operating Range" on page 16 for details.

- Both..... Activate both the front and back receiver.
- Front..... Activate only the front receiver.
- Back..... Activate only the back receiver.



## Power management

For reducing power consumption as well as maintaining the lamp life, the Power management function turns off the projection lamp when the projector is not used for a certain period.

If the input signal is interrupted and no button is pressed for more than 30 seconds, the timer display with "No signal" appears. It starts the countdown until the lamp is turned off. The countdown time can be set between 1 and 30 minutes.

Use the Point ◀▶ buttons to set the countdown timer.

Select one of the following options:

- Ready . . . . . When the lamp has been fully cooled down, the POWER indicator starts blinking. In this condition, the projection lamp is turned on if the input signal is reconnected or any button on the side control or remote control is pressed .
- Shutdown . . . . . When the lamp has been fully cooled down, the power is turned off.
- Off . . . . . Power Management function is off.

**✓ Note:**

- Factory default is "Ready: 5 min."
- When the shutter is closed while the Power management function is working, the Power management function is released.



## On start

When this function is set to "On," the projector will be automatically turned on just by connecting the AC power cord to the wall outlet.

**✓ Note:**

- Be sure to turn off the projector properly (see "Turning Off the Projector" on page 27). If the projector is turned off in the incorrect sequence, the On start function does not work properly.



## Pointer

You can emphasize a part of the projected image with this function. Use the Point ◀▶ buttons to select a pattern of the Pointer (Arrow, Finger, or Dot) (P. 34)

**✓ Note:**

- The Point ▲▼◀▶ buttons and SELECT button are invalid when the Pointer function is operating.

## Power management



Time left before the lamp is off

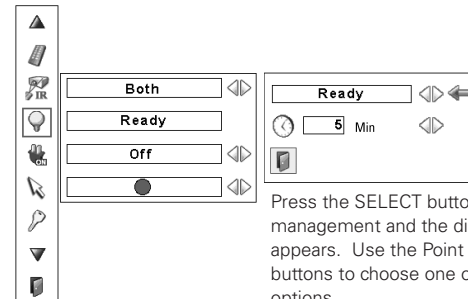

Press the SELECT button at Power management and the dialog box appears. Use the Point ◀▶ buttons to choose one of the three options. Press the Point ▼ button to select the timer, and then use the Point ◀▶ buttons to set the timer

 **Security**

 **Key lock**

This function locks the side control and remote control buttons to prevent operation by unauthorized persons.

 . . . . . Unlocked.

 . . . . . Lock the side control buttons.  
To unlock, use the remote control.

 . . . . . Lock the remote control buttons.  
To unlock, use the side control.

If the side control accidentally becomes locked and you do not have the remote control nearby and unable to operate the projector, contact the service station.

 **PIN code lock**

This function prevents the projector from being operated by unauthorized persons and provides the following setting options for security.

- Off . . . . . Unlocked.
- On1 . . . . . Enter the PIN code every time turning on the projector.
- On2 . . . . . Enter the PIN code to operate the projector once the power cord is disconnected; as long as the AC power cord is connected, the projector can be operated without a PIN code.

Whenever you change the PIN code lock setting or the PIN code (the four-digit number), you are required to enter the PIN code. "1234" is set as the initial PIN code at the factory.

If you want to change the PIN code lock setting, press the SELECT button and the PIN code dialog box appears. Enter a PIN code by following the steps on the next page.

**Security**

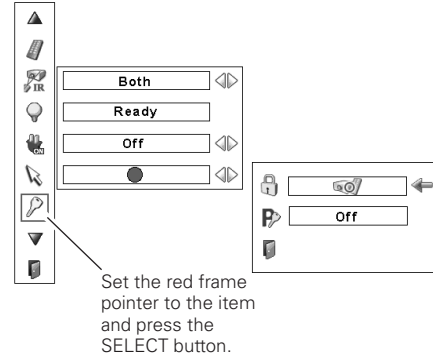

**Key lock**

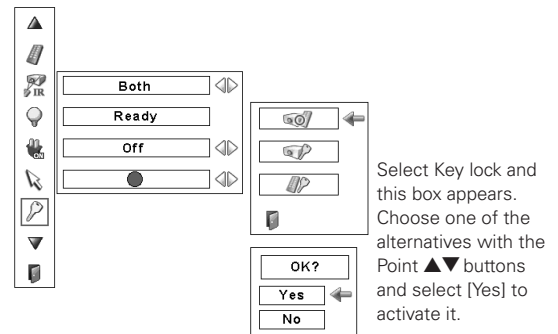

**PIN code lock**

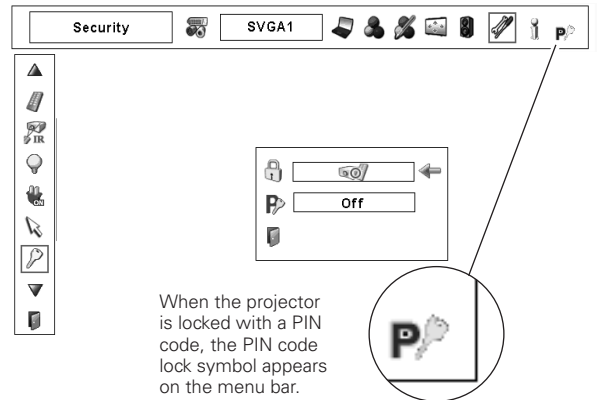

## Enter a PIN code

Use the Point ▲▼ buttons on the side control or Number buttons on the remote control to enter a number.

### When using side control

Use the Point ▲▼ buttons on the side control to select a number. Press the Point ► button to fix the number and move the red frame pointer to the next box. The number changes to “\*.” Repeat this step to complete entering a four-digit number. After entering the four-digit number, move the pointer to “Set.” Press the SELECT button so that you can change the PIN code lock setting.

### When using remote control

Press the Number buttons on the remote control to enter a number (p.15). When you complete entering a four-digit number, the pointer moves to “Set.” Press the SELECT button so that you can change the PIN code lock setting.

If you fixed an incorrect number, use the Point ◀ button to move the pointer to the number you want to correct, and then enter the correct number.

If you entered an incorrect PIN code, “PIN code” and the number (\*\*\*\*) will turn red for a moment. Enter the correct PIN code all over again.

## Change the PIN Code Lock setting

Use the Point ◀► button to select Off, On1, or On2 and then move the pointer to “Quit” with the Point ▼ button. Press the SELECT button to close the dialog box.

## Change the PIN Code

The PIN code can be changed to your desired four-digit number. Press the Point ▼ buttons to select “PIN code change” and press the SELECT button. The New PIN code input dialog box appears. Set a new PIN code.

### CAUTION:

**WHEN YOU HAVE CHANGED THE PIN CODE, WRITE DOWN A NEW PIN CODE IN COLUMN OF THE PIN CODE NO. MEMO ON PAGE 83, AND KEEP IT SECURELY. IF YOU FORGET YOUR PIN CODE, THE PROJECTOR CAN NO LONGER BE STARTED.**

## Enter a PIN code

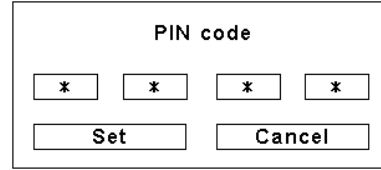

After a correct Logo PIN code is entered, the following dialog box appears.

## Change the PIN code lock setting



Use the Point ◀► buttons to switch between the options.

## Change the PIN code

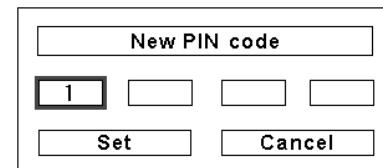



## Shutter

Shutter function is available to block out light to the screen, so that the screen can be used for the other presenters.

### Protection

Prohibit the shutter operation from the remote control and the projector's side control.

- Remote control    Selecting "On" prohibits the shutter operation from the remote control.
- Projector . . .    Selecting "On" prohibits the shutter operation from the side control.

It is possible to prohibit the shutter operation from both of the remote control and the side control.

### Management

The Shutter Management function turns off the projection lamp when the projector is left with the shutter closed and the set time has passed away. The count-down time can be set between 5 and 180 minutes. When the count-down time has elapsed, the shutter will be opened up automatically and the lamp will be turned off to cool itself down. The LAMP/SHUTTER indicator is blinking blue and red during this cooling-off period. When the lamp has been fully cooled down, the POWER indicator turns green lighting and the LAMP/SHUTTER indicator keeps blinking. Should the ON / STAND-BY button be pressed in this condition, the projection lamp will be turned on and the LAMP/SHUTTER indicator lights dim red.

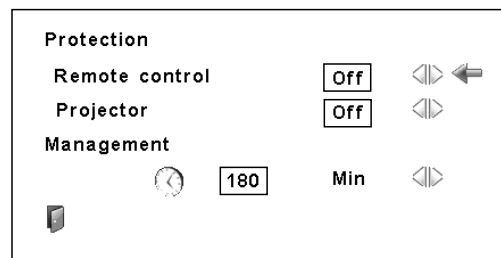

### ✓ Note:

- The Factory default value is set to 180 minutes for the count down time.
- The Shutter Management function cannot be halted.



## Lamp counter

This function is used to reset the lamp counter.

When the lamp life reaches a recommended lamp replacement time, the time shown in the dialog box turns red and the Lamp replacement icon appears on the screen, indicating that the end of lamp life is approaching.

When replacing the projection lamp, reset the lamp counter. See "Resetting the Lamp Counter" on page 65.

### ✓ Note:

- The Lamp replacement icon will not appear when the Display function is set to "Off" (p.52) or during "Freeze" (p.33).



This icon appears on the screen when the end of lamp life is approaching.

### ✓ Note:

- This icon also appears at turning on and selecting input source.



## Filter counter

This function is used to set a frequency for the filter replacement.

Use the Point ▲▼ buttons to move the red frame pointer to Filter counter and then press the SELECT button. A dialog box appears showing the Used time option and the Scrolls remaining option.

Used Time . . . . . Show the total accumulated time of the filter use, timer setting option and the Reset options. When the projector reaches a time set in the timer setting, the Filter replacement icon (Fig. 1) appears on the screen and the total accumulated time turns red, indicating that the filter replacement is necessary. If the filter is out of scroll and the projector reaches a time set in the timer setting, Fig. 2 appears on the screen, indicating that the filter cartridge replacement is necessary.

Scrolls remaining . . Show the scroll counter and the Reset options. When the filter scroll is counted down to 1 (Scroll counter on the screen is showing "0 scroll(s)", the last scroll icon (Fig. 3) appears on the screen. When the filter scroll is counted down to 0, the Filter cartridge replacement icon (Fig. 4) appears on the screen and the WARNING FILTER indicator lights orange, indicating that the filter cartridge replacement is necessary.

To set a timer, press the SELECT button on Used time option. Move the red arrow pointer to the timer setting option and use the Point ◀▶ buttons to select from (Off/ 400H/700H/1000H) depending on the use environment.

When replacing the Filter cartridge, reset the Filter counter and the Scroll counter (p.63).

**✓ Note:**

- Do not reset the counter(s) when the filter or the filter cartridge are not replaced.
- Timer setting notifies that the filter needs replacement. To replace the filter, use the filter control function (p.55).



## Test pattern

Various test pattern are available for use when setting up the projector.



## Factory default

This function returns all setting values except for the user logo, PIN code lock, Logo PIN code lock, lamp counter, and filter counter to the factory default settings.



## Quit

Exit the Setting Menu.

## Filter counter



Set the red frame pointer to the item and press the SELECT button.

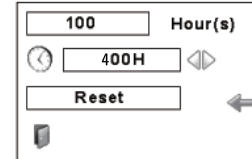
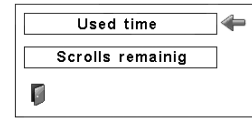

Use the Point ◀▶ buttons to set the timer. Select from (Off/ 400H/700H/1000H) depending on the use environment

**Fig.1** Filter replacement icon



Filter replacement icon appears on the screen at a set time.

**Fig.2**



**Fig.3** Last scroll icon



Last scroll icon appears on the screen when the filter is down to the last scroll.

**Fig.4** Filter cartridge replacement icon



Filter cartridge replacement icon appears on the screen when the filter scroll is counted down to 0 scroll.

**✓ Note:**

- Fig.1, Fig. 2, Fig. 3 and Fig. 4 appear at turning on and selecting input source.
- Fig.1, Fig. 2, Fig. 3 and Fig. 4 will not appear when the Display function is set to "Off" (p.52) or during "Freeze" (p.33).

## Factory default

Set the red frame pointer to the item and press the SELECT button.



Select Factory default and this box appears. Select [Yes], and the next box appears.

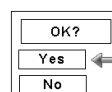
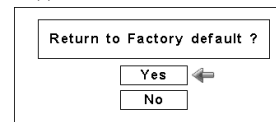

Select [Yes] to activate it.

# Maintenance and Care

## Filter Instructions

Filter prevents dust from accumulating on the optical elements inside the projector. Should the filter becomes clogged with dust particles, it will reduce cooling fans' effectiveness and may result in internal heat buildup and adversely affect the life of the projector. This projector has an electrically operated filter which helps you to replace the filter easily. The projector monitors the condition of the filter at all time and replaces a filter with a new one automatically when it detects the clogging.

If the projector reaches a time set in the timer setting (p. 60), a Filter replacement icon (Fig.1) appears on the screen and the WARNING FILTER indicator on the top panel lights up (p.77). When you see this icon, replace the filter as soon as possible (pp.33, 55). If the filter is out of scroll and the projector reaches a time set in the timer setting, Fig. 2 appears on the screen, indicating that the filter cartridge replacement is necessary.

When the filter scroll is counted down to 1, the Last scroll icon (Fig.3) appears on the screen, indicating that there is one scroll left in the filter cartridge (p.60).

If the projector detects that the filter is clogged and no scroll is left in the filter cartridge, a Filter cartridge replacement icon (Fig. 4) appears on the screen and the WARNING FILTER indicator on the top panel lights up (p.77). When you see this icon, replace the filter cartridge (p.62) and reset the Filter counter (p.63) and the Scroll counter (p.63).

When the filter is being scrolled using the remote control (p.33) or the Filter control function in the setting menu (p.55), a Filter replacement icon and "Please wait..." message (Fig.5) appear on the screen and the WARNING FILTER indicator blinks slow (approx. 2 seconds ON, 2 seconds OFF) (p.75).

The WARNING FILTER indicator blinks fast when the projector detects an abnormal condition, the filter cartridge is not installed properly, or the filter scroll is not working properly (p.77).

### ✓ Note:

- Fig.1, Fig.2, Fig.3, Fig. 4 and Fig.5 will not appear when the Display function is set to "Off" (p.52) or during "Freeze" (p.33).
- The filter cannot be rewound.
- The filter can be scrolled 9 times since the filter cartridge has 10 scrolls.
- The filter cartridge is disposable. Do not clean and reuse the filter cartridge.
- Do not expose the filter cartridge to water or liquid, or it may cause a breakdown.
- Replace the filter cartridge after all the scroll is used up. If you replace the filter cartridge when there are some scrolls left in the filter cartridge, the filter counter and the scroll counter do not recognize the correct number of remaining scrolls and the reset function cannot work properly. It may cause a breakdown.
- Do not use the filter cartridge with other projector. The filter counter and the scroll counter do not recognize the correct number of remaining scrolls of the used filter cartridge and the reset function cannot work properly. It may cause a breakdown.
- Make sure that the projection lamp is turn off when you are replacing the filter cartridge. If you replace the filter cartridge when the projection lamp is turn on, the projector will be shut down automatically for safety purpose
- When you forget to reset the filter counter, the projector cannot recognize the correct number of remaining scrolls and may cause a breakdown.
- Do not forget to reset the filter counter and the scroll counter in the setting menu after replacing the filter cartridge. If you forget to reset the filter counter and the scroll counter, the projector cannot recognize the correct number of remaining scrolls and may cause a breakdown.



Fig.1 Filter replacement icon



Fig.2



Fig.3 Last scroll icon



Fig.4 Filter cartridge replacement icon



Please wait . . .

Fig.5 Filter replacement icon and "Please wait..." message.



## Replacing the Filter Cartridge

- 1 Turn off the projector, and unplug the AC power cord from the AC outlet.
- 2 First, clean up the dust on the projector and around the air vents.
- 3 Press ▲ on the filter cover to release the latch and open the filter cover.
- 4 Pull out the filter cartridge. When taking out the filter cartridge, put your finger on the filter cartridge's tab and then pull.
- 5 Put the new one back into the position and close the filter cover. Make sure that the filter cartridge is properly and fully inserted.
- 6 Connect the AC power cord to the projector and turn on the projector.
- 7 **Reset the filter counter and the scroll counter** (p.63).



### CAUTION

Make sure the filter cartridge is inserted in the projector. If the filter cartridge is not inserted, the projector cannot be turned on. Do not put anything into the air vents. Doing so may result in malfunction of the projector.

### RECOMMENDATION

**We recommend avoiding dusty/smoky environments when operating the projector. Usage in these environments may cause a poor image quality.**

When using the projector under dusty or smoky conditions, dust may accumulate on a lens, liquid crystal panels, or optical elements inside the projector. Such condition may degrade the quality of the projected image.

When the symptoms above are noticed, contact your authorized dealer or service station for proper cleaning.

### ORDER REPLACEMENT FILTER CARTRIDGE

Replacement filter cartridge can be ordered through your dealer. When ordering, give the following information to the dealer.

- **Model No. of your projector**  
**LC-X85**
- **Replacement Filter Cartridge Type No.**  
**Service Parts No. 610 334 3747**

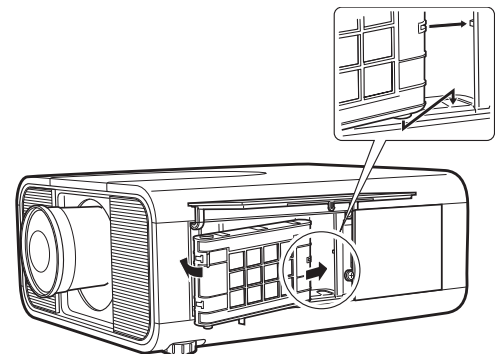
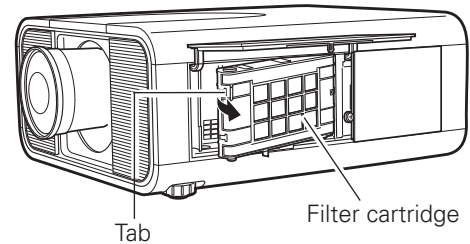
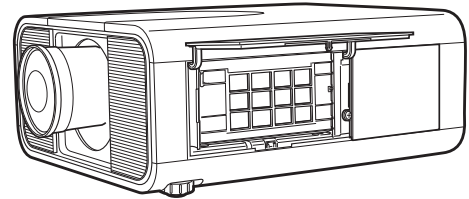
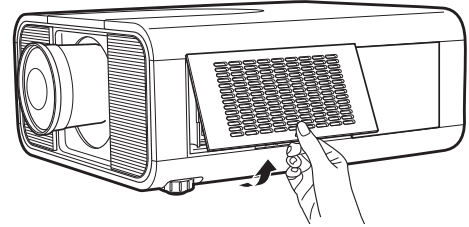
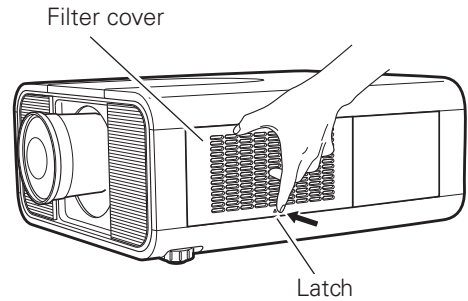



### Resetting the Filter Counter

Be sure to reset the Filter counter after replacing the filter cartridge.

- 1** Press the MENU button to display the On-Screen Menu. Use the Point ◀▶ buttons to move the red frame pointer to the Setting Menu icon.
- 2** Use the Point ▲▼ buttons to move the red frame pointer to Filter counter and then press the SELECT button. A dialog box appears showing the Used time option and the Scrolls remaining option. Use the Point ▲▼ buttons to select Used time.
- 3** Used time shows the total accumulated time of the filter use, a timer setting option, and the Reset option. Select Reset and the "Filter counter Reset?" appears. Select [Yes] to continue.
- 4** Another confirmation dialog box appears, select [Yes] to reset the Filter counter.

### Filter counter

Used time  
Scrolls remaining

Select "Used time" and the dialogue box below appears.

100 Hour(s)  
400H  
Reset

Select Reset and the "Filter counter Reset?" appears.

Filter counter Reset ?  
Yes  
No

Select [Yes], then another confirmation box appears.

OK?  
Yes  
No

Select [Yes] again to reset the Filter counter.

### Resetting the Scroll Counter

Be sure to reset the Scroll counter after replacing the filter cartridge.

- 1** Press the MENU button to display the On-Screen Menu. Use the Point ◀▶ buttons to move the red frame pointer to the Setting Menu icon.
- 2** Use the Point ▲▼ buttons to move the red frame pointer to Filter counter and then press the SELECT button. A dialog box appears showing the Used time option and the Scrolls remaining option. Use the Point ▲▼ buttons to select Scroll(s) remaining.
- 3** Scroll(s) remaining shows the number of the remaining scrolls and the Reset option. Select Reset and the "Scroll counter Reset?" appears. Select [Yes] to continue.
- 4** Another confirmation dialog box appears, select [Yes] to reset the Scroll counter.

### Scroll counter

Used time  
Scrolls remaining

Select "Scrolls remaining" and the dialogue box below appears.

9 Scroll(s)  
Reset

Select Reset and the "Scroll counter Reset?" appears.

Scroll counter Reset ?  
Yes  
No

Select [Yes], then another confirmation box appears.

OK?  
Yes  
No

Select [Yes] again to reset the Scroll counter.

## Lamp Replacement

When the projection lamp of the projector reaches its end of life, the Lamp replacement icon appears on the screen and LAMP REPLACE indicator lights orange. Replace the lamp with a new one promptly. The timing when the LAMP REPLACE indicator should light is depending on the lamp mode.

### Top Panel

LAMP / SHUTTER

LAMP REPLACE

WARNING FILTER

WARNING TEMP.



Lamp replacement icon

### LAMP REPLACE indicator

#### ✓ Note:

- The Lamp replacement icon will not appear when the Display function is set to "Off" (p.52) or during "Freeze" (p.33)

Follow these steps to replace the lamp.

- 1** Turn off the projector and unplug the AC power cord. Let the projector cool for at least 45 minutes.
- 2** Open the filter cover. (p.62)
- 3** Loosen the screw and open the lamp cover. Pull out the lamp by using the built in handle.
- 4** Replace the lamp with a new one. Make sure that the lamp is properly and fully inserted.
- 5** Close the lamp cover and secure the screw.
- 6** Close the filter cover.
- 7** Connect the AC power cord to the projector and turn on the projector.
- 8** **Reset the Lamp counter** (p.65)

#### ✓ Note:

- Be sure to insert the lamp in the correct direction.
- Do not reset the Lamp counter when the projection lamp is not replaced.

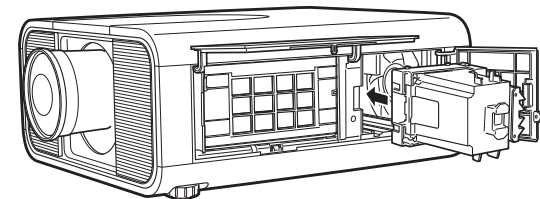
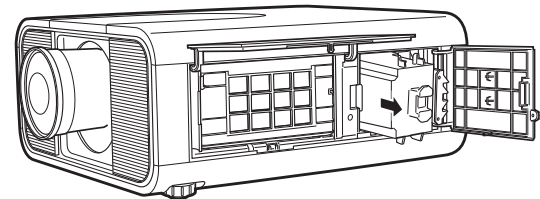
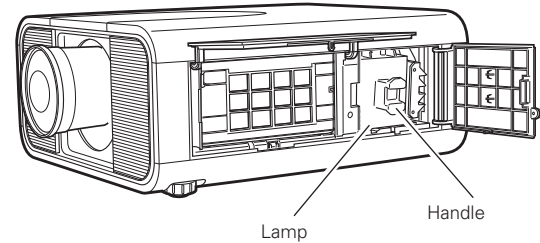
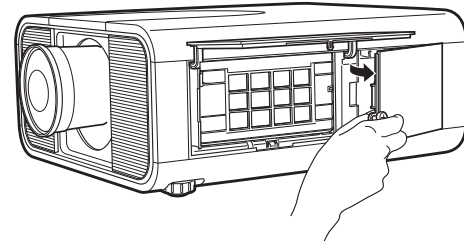
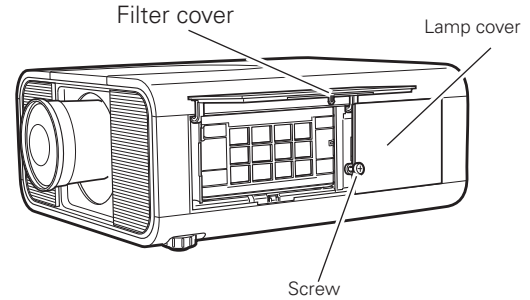

## CAUTION

Allow a projector to cool for at least 45 minutes before you open the lamp cover. The inside of the projector can become very hot.



## CAUTION

For continued safety, replace with a lamp of the same type. Do not drop the lamp or touch the glass bulb! The glass can shatter and may cause injury.

## Resetting the Lamp Counter

Be sure to reset the Lamp counter after the lamp is replaced. When the Lamp counter is reset, the LAMP REPLACE indicator stops lighting and the Lamp replacement icon disappears.

- 1** Press the MENU button to display the On-Screen Menu. Use the Point ◀▶ buttons to move the red frame pointer to the Setting Menu icon
- 2** Use the Point ▲▼ buttons to move the red frame pointer to Lamp counter and then press the SELECT button. A dialog box appears showing the total accumulated time of the lamp usage and the reset option. Select Reset and the "Lamp replacement counter Reset?" appears. Select [Yes] to continue.
- 3** Another confirmation dialog box appears and select [Yes] to reset the Lamp counter.

**✓ Note:**

- Do not reset the Lamp counter without replacing the lamp. Be sure to reset the Lamp counter only after replacing the lamp.

### Lamp counter

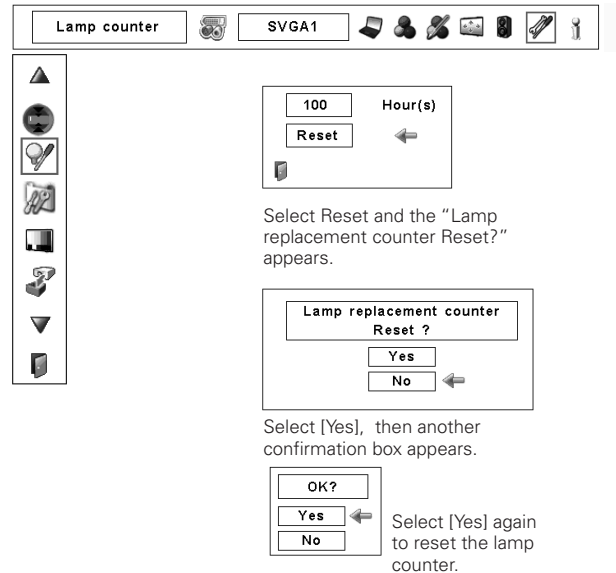

### ORDER REPLACEMENT LAMP

Replacement lamp can be ordered through your dealer. When ordering, give the following information to the dealer.

- **Model No. of your projector** : **LC-X85**
- **Replacement Lamp Type No.** : **POA-LMP124**

(Service Parts No. 610 341 1941)



### LAMP HANDLING PRECAUTIONS

This projector uses a high-pressure lamp which must be handled carefully and properly. Improper handling may result in accidents, injury, or create a fire hazard.

- Lamp lifetime may differ from lamp to lamp and according to the environment of use. There is no guarantee of the same lifetime for each lamp. Some lamps may fail or terminate their lifetime in a shorter period of time than other similar lamps.
- If the projector indicates that the lamp should be replaced, i.e., if the LAMP REPLACE indicator lights up, replace the lamp with a new one IMMEDIATELY after the projector has cooled down. (Follow carefully the instructions in the Lamp Replacement section of this manual.) Continuous use of the lamp with the LAMP REPLACE indicator lighted may increase the risk of lamp explosion.
- Lamp may explode as a result of vibration, shock or degradation as a result of hours of use as its lifetime draws to an end. Risk of explosion may differ according to the environment or conditions in which the projector and lamp are being used.

#### **IF A LAMP EXPLODES, THE FOLLOWING SAFETY PRECAUTIONS SHOULD BE TAKEN.**

If a lamp explodes, disconnect the projector's AC plug from the AC outlet immediately. Contact an authorized service station for a checkup of the unit and replacement of the lamp. Additionally, check carefully to ensure that there are no broken shards or pieces of glass around the projector or coming out from the cooling air circulation holes. Any broken shards found should be cleaned up carefully. No one should check the inside of the projector except those who are authorized trained technicians and who are familiar with projector service. Inappropriate attempts to service the unit by anyone, especially those who are not appropriately trained to do so, may result in an accident or injury caused by pieces of broken glass.

### ***Cleaning the Projection Lens***

Unplug the AC power cord before cleaning.

Gently wipe the projection lens with a cleaning cloth that contains a small amount of non-abrasive camera lens cleaner, or use a lens cleaning paper or commercially available air blower to clean the lens.

Avoid using an excessive amount of cleaner. Abrasive cleaners, solvents, or other harsh chemicals might scratch the surface of the lens.

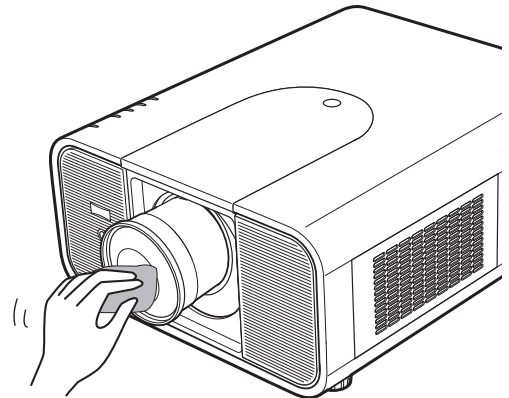

### ***Cleaning the Projector Cabinet***

Unplug the AC power cord before cleaning.

Gently wipe the projector body with a soft dry cleaning cloth. When the cabinet is heavily soiled, use a small amount of mild detergent and finish with a soft dry cleaning cloth. Avoid using an excessive amount of cleaner. Abrasive cleaners, solvents, or other harsh chemicals might scratch the surface of the cabinet.

When the projector is not in use, put the projector in an appropriate carrying case to protect it from dust and scratches.

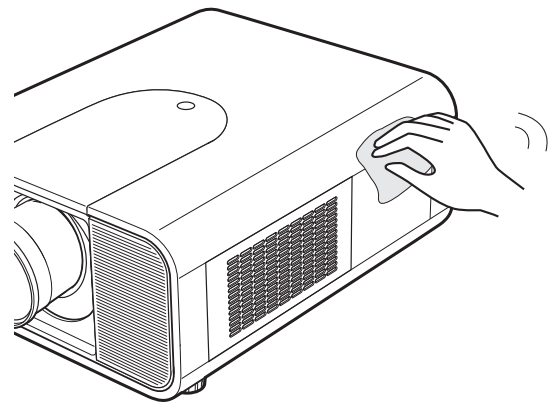

## Warning Indicators

The WARNING indicators show the state of the function which protects the projector. Check the state of the WARNING indicators and the POWER indicator to take proper maintenance.

### **The projector is shut down and the WARNING TEMP. indicator is blinking red.**

When the temperature inside the projector reaches a certain level, the projector will be automatically shut down to protect the inside of the projector. The LAMP/SHUTTER indicator turns red and the WARNING TEMP indicator blinks while the projector is being cooled down. When the projector has cooled down enough (to its normal operating temperature), it can be turned on again by pressing the ON/STAND-BY button.

**✓ Note:**

- The WARNING TEMP. indicator continues to blink even after the temperature inside the projector returns to normal. When the projector is turned on again, the WARNING TEMP. indicator stops blinking.

**Then check the matters below:**

- Did you provide appropriate space for the projector to be ventilated? Check the installing condition to see if the air vents of the projector are not blocked.
- Has the projector been installed near an Air-Conditioning/ Heating Duct or Vent? Move the installation of the projector away from the duct or vent.
- Is the filter clean? Replace the filter with a new one.

### **The projector is shut down; and the LAMP/SHUTTER indicator is lighting red and other four indicators are blinking.**

When the projector detects an abnormal condition, it will be automatically shut down to protect the inside of the projector and the LAMP/SHUTTER indicator lights red and other four indicators blink. In this case, unplug the AC power cord and plug it, and then turn on the projector once again to verify operation. If the projector cannot be turned on and these indicators are still lighting and blinking, unplug the AC power cord and contact the service station.



**CAUTION**

DO NOT LEAVE THE PROJECTOR WITH THE AC POWER CORD CONNECTED UNDER AN ABNORMAL CONDITION. IT MAY RESULT IN FIRE OR ELECTRIC SHOCK.

### Top Panel

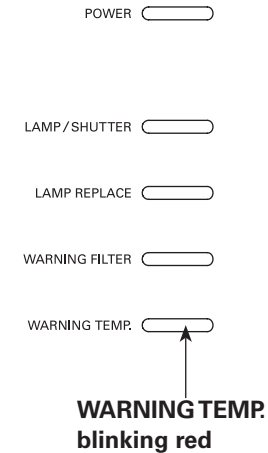

### Top Panel

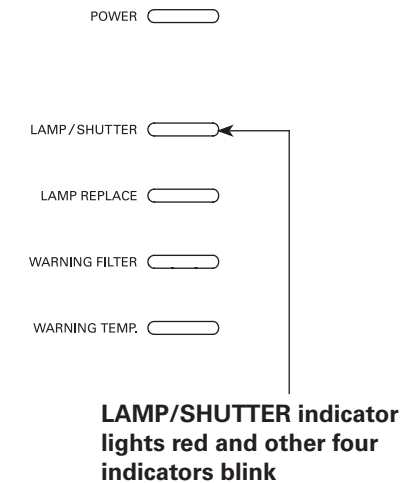



# Appendix

## Troubleshooting

Before calling your dealer or service center for assistance, check the items below once again.

1. Make sure you have properly connected the projector to peripheral equipment as described on pages 22–24.
2. Check the cable connection. Make sure that all computers, video equipment, and power cords are properly connected.
3. Make sure that all power is switched on.
4. If the projector still does not produce an image, restart your computer.
5. If an image still does not appear, disconnect the projector from your computer and check your computer monitor's display. A problem may be noticed with your graphics controller rather than with the projector. (When you reconnect the projector, be sure to turn the computer and monitor off before you turn on the projector. Turn on equipment in the order of the projector and computer.)
6. If a problem still persists, check the following solutions.

| <b>Problem:</b>   | <b>Solutions</b>  |
|---|---|
| <b>No power.</b>  | <ul style="list-style-type: none"> <li>– Plug the power cord of the projector into the AC outlet.</li> <li>– Wait until the POWER indicator stops blinking to turn on the projector again. (See page 26)</li> <li>– Check the WARNING TEMP. indicator. If the WARNING TEMP. indicator is blinking, the projector cannot be turned on. (See page 68.)</li> <li>– Unlock the Key lock function for the projector. (See page 57)</li> <li>– See if the filter cartridge is inserted. (See page 62)</li> <li>– Check the projection lamp. (See page 64.)</li> </ul>   |
| <b>PIN code dialog box appears at start-up.</b>   | <ul style="list-style-type: none"> <li>– PIN code lock is being set. Enter a PIN code; the "1234" or numbers you have set (See pages 26, 57-58)</li> </ul>  |
| <b>The initial display is not shown.</b>  | <ul style="list-style-type: none"> <li>– Make sure "Off " or "Countdown Off" are not chosen at Display function. (See "SETTING" section on page 52)</li> </ul>  |
| <b>The initial display is not same with the default one.</b>  | <ul style="list-style-type: none"> <li>– Make sure "User" or "Off" are not chosen at Logo select function. (See "SETTING" section on page 53)</li> </ul>  |
| <b>When the projector is on and you press the input button, an icon other than the Lamp mode icon appears.</b>      | <ul style="list-style-type: none"> <li>– That is the Filter warning icon. (See page 61.)</li> </ul>   |
| <b>An icon other than Input mode or Lamp mode icon appears.</b>   | <ul style="list-style-type: none"> <li>– That is the Lamp replacement icon or the Filter warning icon. (See pages 60-61.)</li> </ul>  |
| <b>No image.</b>  | <ul style="list-style-type: none"> <li>– Check the connection between your computer or video equipment and the projector.</li> <li>– See if the input signal is correctly output from your computer. Some laptop computers may need to be changed the setting for monitor output when connected to the projector. See your computer's instruction manual for the setting.</li> <li>– It takes about 30 seconds to display an image after turning on the projector.</li> <li>– See if the selected system is corresponding with your computer or video equipment.</li> <li>– Select correct input source once again through menu operation (See pages 35-37).</li> <li>– Make sure the temperature is not out of Operating Temperature (41°F–104°F [5°C–40°C]).</li> </ul> |
| <br><b>appears on the screen</b> | <ul style="list-style-type: none"> <li>– End of lamp life is approaching. Replace the lamp with a new one promptly. (See pages 59, 64-65)</li> </ul>  |

|   |  |
|---|--|
|   <p><b>appears on the screen</b></p> | <ul style="list-style-type: none"> <li>– Filter is out of scroll. Replace the filter cartridge with a new one promptly. (See pages 62 -63)</li> </ul>  |
| <p><b>The image is out of focus.</b></p>  | <ul style="list-style-type: none"> <li>– Adjust the focus of the projector.</li> <li>– Check Projection Lens to see if it needs cleaning.</li> <li>✓<b>Note:</b> Moving the projector from a cool temperature location to a warm temperature location may result in moisture condensation on Projection Lens. In such cases, leave the projector OFF and wait until condensation evaporates.</li> <li>– Projecting from excessive slant angle to the screen may cause keystone distortion and partial imperfect focus.</li> <li>– Make sure the projection screen is at least 4.6' (1.4 m) away from the projector.</li> </ul> |
| <p><b>The image is not bright enough.</b></p>   | <ul style="list-style-type: none"> <li>– Check if “Contrast” or “Brightness” are adjusted properly. (See page 49)</li> <li>– Check if “Image level” is selected properly. (See pages 42, 46)</li> <li>– Check the Lamp control function. ( See “SETTING” section on page 55)</li> <li>– Check the LAMP REPLACE indicator. If it lights, the end of lamp life is approaching. Replace the lamp with a new one promptly. (See page 64)</li> </ul>  |
| <p><b>The color is strange.</b></p>   | <ul style="list-style-type: none"> <li>– Check the Input signal, color system, video system, or computer system mode.</li> <li>– Adjust the Image Level properly. (See pages 42, 46)</li> </ul>  |
| <p><b>The image is Left/Right reversed.</b></p>   | <ul style="list-style-type: none"> <li>– Check the Ceiling / Rear function. (See pages 44, 48.)</li> </ul>   |
| <p><b>The image is Top/Bottom reversed.</b></p>   | <ul style="list-style-type: none"> <li>– Check the Ceiling function. (See pages 44, 48.)</li> </ul>  |
| <p><b>The image is distorted or runs off.</b></p>   | <ul style="list-style-type: none"> <li>– Check “PC Adjust” menu or “ Screen” menu and adjust them.</li> </ul>  |
| <p><b>Auto PC adjustment function does not work.</b></p>  | <ul style="list-style-type: none"> <li>– Check the Input signal. Auto PC Adjustment function cannot work when 480p, 575p, 720p, 480i, 575i, 1035i, or 1080i is selected or when the digital signal is input into DVI terminal. (See page 39)</li> </ul>  |
| <p><b>Some displays are not seen during the operation.</b></p>  | <ul style="list-style-type: none"> <li>– Check the Display function (see page 52).</li> </ul>  |
| <p><b>The setting does not remain after turning off power.</b></p>  | <ul style="list-style-type: none"> <li>– Make sure you selected “Store” after adjusting settings. Some settings cannot be stored if not registered with “Store.”</li> </ul>  |
| <p><b>Power management function does not work.</b></p>  | <ul style="list-style-type: none"> <li>– Power management function cannot work while “Freeze” function is running or the shutter is closed.</li> </ul>   |
| <p><b>Image disappears automatically.</b></p>   | <ul style="list-style-type: none"> <li>– Check the power management function in the Setting. The power management is set to “On” at the factory.</li> </ul>  |
| <p><b>Capture function does not work.</b></p>   | <ul style="list-style-type: none"> <li>– Check the connection to see if there is signal.</li> </ul>  |
| <p><b>Some menus cannot be selected.</b></p>  | <ul style="list-style-type: none"> <li>– Each of the Video Input and Computer Input has a limit on selectable menus.</li> </ul>  |
| <p><b>No sound</b></p>  | <ul style="list-style-type: none"> <li>– Check the audio cable connection from audio input source.</li> <li>– Adjust the audio source.</li> <li>– Press the Volume + button. ( See page 31)</li> <li>– Press the Mute button. (See page 31)</li> <li>– Is the image projected? You will hear the sound only when the image is projected.</li> <li>– Make sure you selected correct Input pattern. (See page 31)</li> </ul>   |



|   |   |
|---|---|
| <p><b><i>The power is turned off automatically.</i></b></p>   | <ul style="list-style-type: none"> <li>- Power management function runs by initial setting. Check "SETTING" section on page 56.</li> <li>- When the filter cartridge replacement icon keeps appearing on the screen at turning on the projector for some time and no action is taken to replace the filter cartridge, the projector will be automatically shut down in 3 minutes after turning on to protect the projector. (See pages 61-63, 77)</li> <li>- Do not cover the ventilation slots on the projector. (See pages 4, 6)</li> <li>- Projector may be used in high ambient temperature environment. Make sure the temperature is not out of Operating Temperature (41°F–104°F [5°C–40°C]). (See page 69)</li> </ul>  |
| <p><b><i>You cannot operate with the side control.</i></b></p>  | <ul style="list-style-type: none"> <li>- The side control is not available. If the side control is locked at "Key lock" under "Security" of SETTING section. Please check "SETTING" section on page 57.</li> </ul>  |
| <p><b><i>The Remote Control does not work.</i></b></p>  | <ul style="list-style-type: none"> <li>- Check the batteries.</li> <li>- Check if the RC sensor is set properly. (See page 56)</li> <li>- Make sure no obstruction is between the projector and remote control.</li> <li>- Make sure you are not too far from the projector when using the remote control. Maximum operating range is 16.4' (5m).</li> <li>- Make sure that the remote control code conforms to the projector's code. (See "SETTING" section on page 55.)</li> <li>- Unlock the Key lock function for the remote control. (See page 57)</li> <li>- Wireless remote control does not work when the remote control cable is connected to the projector. (See page 16)</li> <li>- Check if the ALL-OFF switch on the remote control is set to "ON."</li> <li>- Make sure that the simple mode in the remote control function is set to "Off" (See page 55).</li> </ul> |
| <p><b><i>Wireless mouse function does not work.</i></b></p>   | <ul style="list-style-type: none"> <li>- Check the cable connection between the projector and your computer. (See page 34)</li> <li>- Check the mouse setting on your computer.</li> <li>- Turn on the projector before you turn on the computer.</li> </ul>  |
| <p><b><i>Indicators blink or light.</i></b></p>   | <ul style="list-style-type: none"> <li>- Check the status of the projector with referring to " INDICATORS AND PROJECTOR CONDITION" on pages 75-77.</li> </ul>   |
| <div style="text-align: center;">  <p><b><i>appears on the screen</i></b></p> </div> | <ul style="list-style-type: none"> <li>- Your operation is invalid. Operate correctly.</li> </ul>   |
| <p><b><i>Unable to unlock the Logo PIN code lock, Security key lock or Security PIN code lock.</i></b></p>  | <ul style="list-style-type: none"> <li>- Contact the dealer where you purchased the projector or the service center.</li> </ul>   |
| <p><b><i>Forget the Logo PIN code or Security PIN code.</i></b></p>   | <ul style="list-style-type: none"> <li>- Contact the dealer where you purchased the projector or the service center.</li> </ul>   |

**WARNING:**

**High voltages are used to operate this projector. Do not attempt to open the cabinet.**

If problems still persist after following all operating instructions, contact the dealer where you purchased the projector or the service center. Specify the model number and explain about the problem. We will advise you how to obtain service.

## Menu Tree

### Computer Input/Video Input

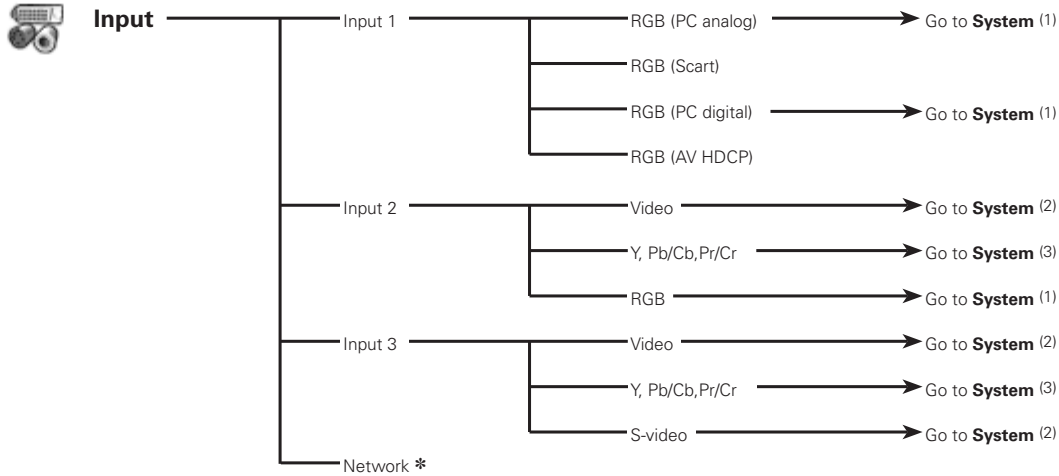

\* Network will be displayed only when an optional Pj-to NetDirector is attached.

### Information

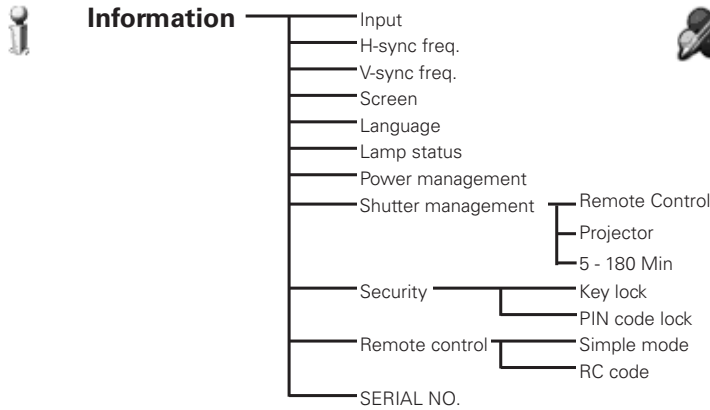

### Image Adjust

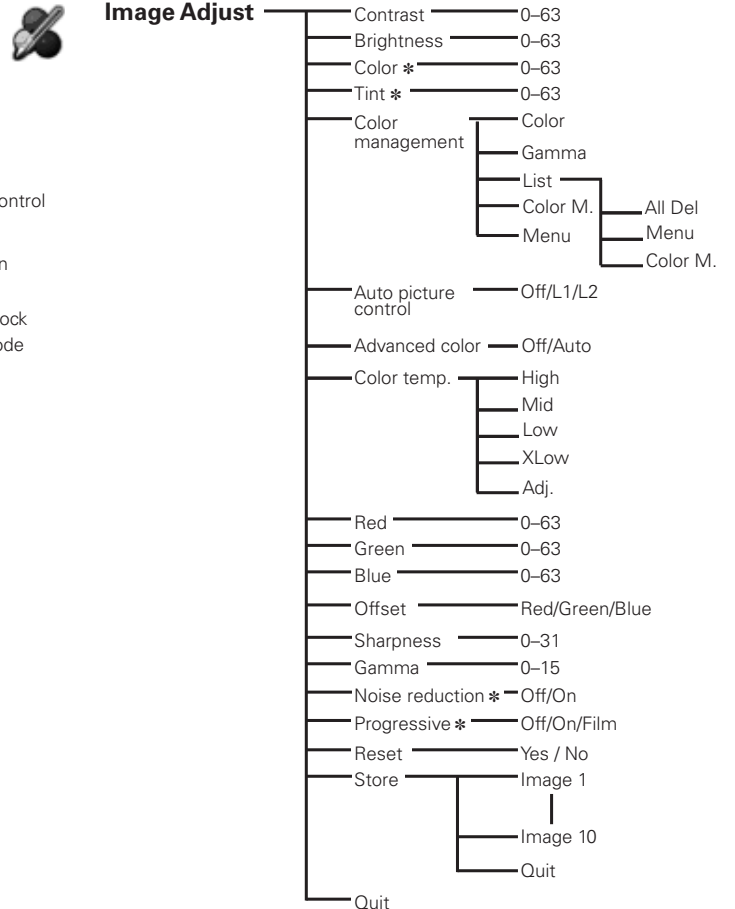

### Sound



✓ **Note:**

• The Menu display varies depending on the input signal.

\* Displayed only in Video Input

## Computer Input

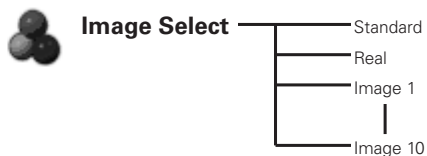
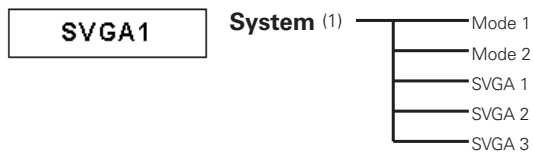

\* System displayed in the System Menu varies depending on the input signal.

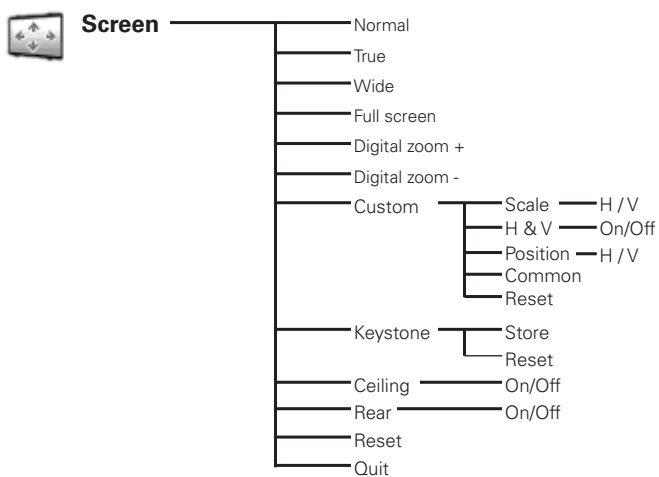
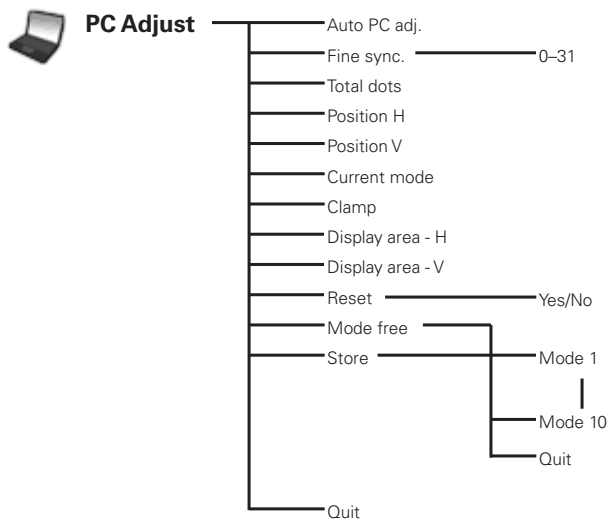

## Video Input

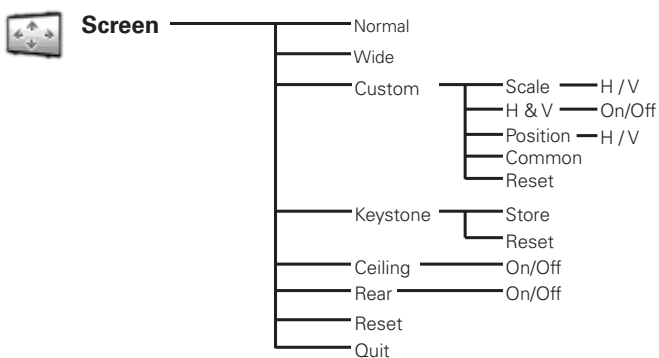
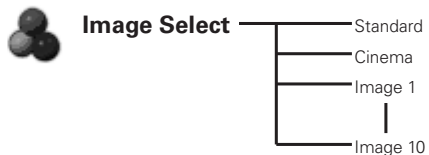
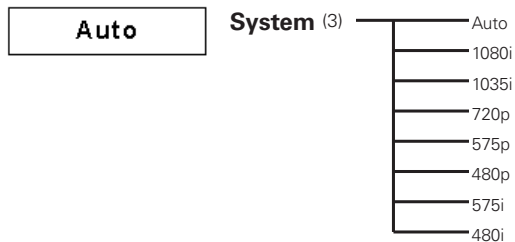
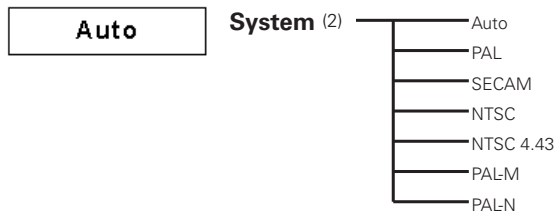

**✓ Note:**

• The Menu display varies depending on the input signal.

## Computer Input/Video Input



### Setting

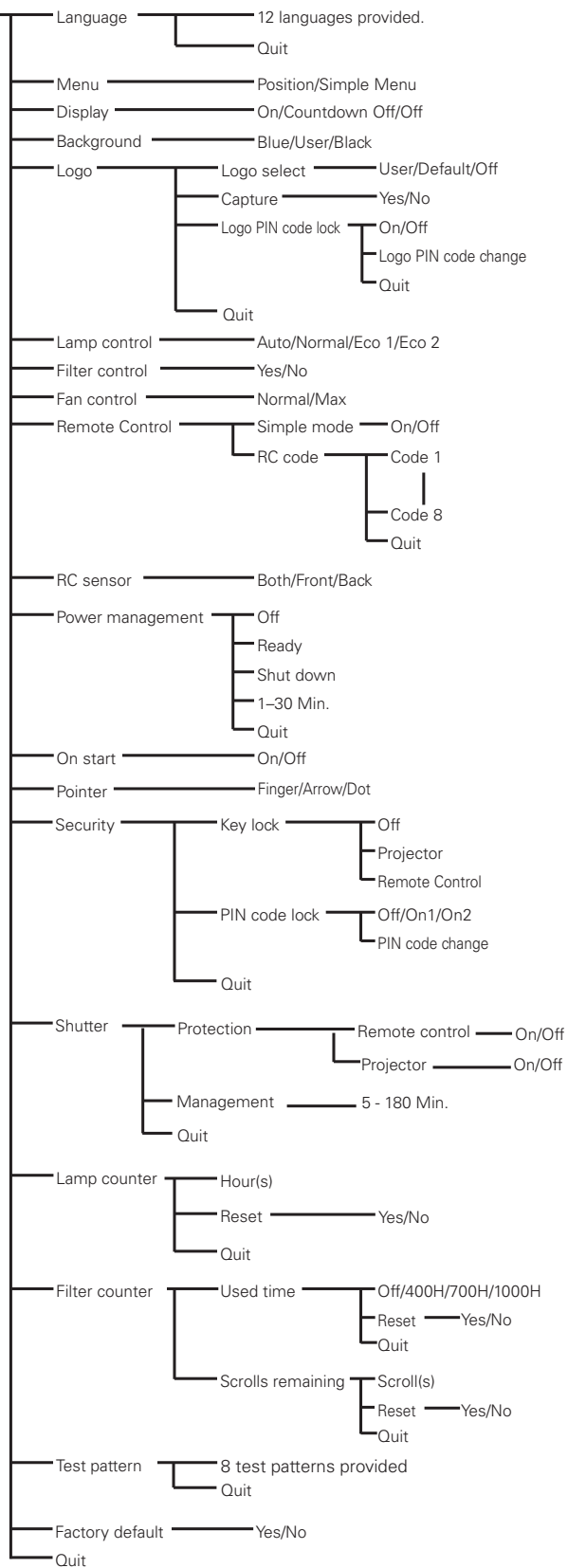

### Indicators and Projector Condition

Check the indicators for the projector condition.

The projector is operating normally.

| Indicators     |                              |                        |                             |                           | Projector Condition  |
|----------------|------------------------------|------------------------|-----------------------------|---------------------------|--|
| POWER<br>green | LAMP/<br>SHUTTER<br>red/blue | WARNING<br>TEMP<br>red | WARNING<br>FILTER<br>orange | LAMP<br>REPLACE<br>orange |  |
| ●              | ●                            | ●                      | ●                           | ●                         | The projector is off. (The AC power cord is unplugged.)  |
| ○              | ⊕                            | ●                      | *                           | *                         | The projector is in stand-by mode. Press the ON/STAND-BY button to turn on the projector.  |
| ○              | ⊕                            | ●                      | *                           | *                         | The projector is operating normally. (The shutter is open)   |
| ○              | ⊗                            | ●                      | *                           | *                         | The projector is operating normally. (The shutter is closed)   |
| ●              | ⊕                            | ●                      | *                           | *                         | The projector is preparing for stand-by or the projection lamp is being cooled down. The projector cannot be turned on until cooling is completed and the POWER indicator lights green.  |
| ●              | ⊕                            | ●                      | *                           | *                         | The projection lamp is being cooled down in the Power management mode.   |
| ○ <sup>⚡</sup> | ⊕                            | ●                      | *                           | *                         | The projector is in the Power management mode.   |
| ●              | ⊗ <sup>⚡</sup>               | ●                      | *                           | *                         | The projection lamp is being cooled down in the Shutter management mode.   |
| ○              | ⊗ <sup>⚡</sup>               | ●                      | *                           | *                         | The projector is in the Shutter management mode. Press the ON/STAND-BY button to turn on the projector.  |
| ○              | *                            | ●                      | ○ <sup>⚡</sup>              | *                         | The filter is scrolled using the FILTER button on the remote control or the Filter control function in the setting menu. When the filter is being scrolled, the Filter replacement icon and "Please wait..." message (Fig. 1) appear on the screen for about 30 seconds. |



Please wait . . .

Fig.1 Filter replacement icon and "Please wait..."

- ●●● on
- ⊕ ●●● on (red)
- ⊗ ●●● on (blue)
- ●●● dim
- ⊕ ●●● dim (red)
- <sup>⚡</sup> ●●● blinking at the normal rate (approx. 1 second ON, 1 second OFF)
- ⊗<sup>⚡</sup> ●●● blinking at the normal rate (blue and dim red) (approx. 1 second ON, 1 second OFF)
- ●●● off
- \* ●●● Differ according to conditions.
- ⊗ ●●● blinking fast (approx. 0.5 seconds ON, 0.5 seconds OFF)
- ⊗<sup>⚡</sup> ●●● blinking fast (blue and dim red) (approx. 0.5 seconds ON, 0.5 seconds OFF)
- <sup>⚡</sup> ●●● blinking slow (approx. 2 seconds ON, 2 seconds OFF)

## The projector is detecting abnormal condition.

| Indicators     |                              |                         |                             |                           | Projector Condition  |
|----------------|------------------------------|-------------------------|-----------------------------|---------------------------|--|
| POWER<br>green | LAMP/<br>SHUTTER<br>red/blue | WARNING<br>TEMP.<br>red | WARNING<br>FILTER<br>orange | LAMP<br>REPLACE<br>orange |  |
|                |                              |                         |                             |                           | The temperature inside the projector is elevated close to the abnormally high level.   |
|                |                              |                         |                             |                           | The temperature inside the projector is abnormally high. The projector cannot be turned on. When the projector is cooled down enough and the temperature returns to normal, the POWER indicator lights green and the projector can be turned on. (The WARNING TEMP. indicator keeps blinking.) Check and replace the filter. |
|                |                              |                         |                             |                           | The projector has been cooled down enough and the temperature returns to normal. When turning on the projector, the WARNING TEMP. indicator stops blinking. Check and replace the filter.  |
|                |                              |                         |                             |                           | The lamp cannot light up. (The projector is preparing for stand-by or the projection lamp is being cooled down. The projector cannot be turned on until cooling is completed.)   |
|                |                              |                         |                             |                           | The lamp cannot light up. (The lamp has been cooled down enough and the projector is in stand-by mode and ready to be turned on with the ON/STAND-BY button.)  |
|                |                              |                         |                             |                           | The lamp has been used overtime. Replace the lamp immediately and then reset the lamp counter. The indicator will be turned off after resetting the counter.   |











### WARNING FILTER

When the filter detects clogging, reaches a time set in the timer setting or runs out of the filter scroll, the WARNING FILTER indicator lights orange. When this indicator lights orange, replace the filter or the filter cartridge with a new one promptly. Reset the Filter counter and Scroll counter after replacing the filter cartridge (p.63).

### LAMP REPLACE

When the projection lamp reaches its end of life, the LAMP REPLACE indicator lights orange. When this indicator lights orange, replace the projection lamp with a new one promptly. Reset the lamp counter after replacing the lamp (p.65).

The projector is detecting abnormal condition.

| Indicators  |   |   |   |   | Projector Condition  |
|---|---|---|---|---|--|
| POWER<br>green  | LAMP/<br>SHUTTER<br>red/blue  | WARNING<br>TEMP.<br>red   | WARNING<br>FILTER<br>orange   | LAMP<br>REPLACE<br>orange   |  |
| ○   | *   | ●   | ○   | *   | <p>If the Filter counter reached a time set in the timer setting, a Filter replacement icon (Fig.2) appears on the screen and the WARNING FILTER indicator on the top panel lights up. Replace the filter as soon as possible. If the filter is out of scroll and the projector reaches a time set in the timer setting, Fig. 3 appears on the screen and the WARNING FILTER indicator lights up. Replace the filter cartridge as soon as possible.</p> <p>If the filter is clogged and no scroll is left in the filter cartridge, a Filter cartridge replacement icon (Fig.4) appears on the screen and the WARNING FILTER indicator lights up. Replace the filter cartridge as soon as possible.</p> <p><b>✓ Note:</b></p> <ul style="list-style-type: none"> <li>• Fig.2, Fig.3 and Fig.4 icon will not appear when the Display function is set to "Off" (p.52) or during "Freeze" (p.33).</li> </ul> |
|  <p><b>Fig.2</b> Filter replacement icon</p>           |   |   |   |   |  |
|  <p><b>Fig.3</b></p>                                   |   |   |   |   |  |
|  <p><b>Fig.4</b> Filter cartridge replacement icon</p> |   |   |   |   |  |
|    |  |  |  |  | <p>The filter cartridge is not installed in the projector. Check the filter compartment to see if the filter cartridge is installed in the projector. When the filter cartridge is installed and the indicators continue to light and blink, read the column below.</p> <p>The projector detects an abnormal condition and cannot be turned on. Unplug the AC power cord and plug it again to turn on the projector. If the projector is turned off again, unplug the AC power cord and contact the dealer or the service center. Do not leave the projector on. It may cause an electric shock or a fire hazard.</p>  |
| *   |  | *   | *   | *   | The shutter is out of control.   |
| ●   |  | ●   | *   | *   | The shutter is out of control. (The projector is in the cooling mode.)   |
| ○   |  | ●   | *   | *   | The shutter is out of control. (The projector is in the stand-by mode.) In that case, contact the service station immediately.   |

## Compatible Computer Specifications

Basically this projector can accept the signal from all computers with the V- and H-Frequency mentioned below and less than 180 MHz of Dot Clock.

| ON-SCREEN DISPLAY | RESOLUTION              | H-Freq. (kHz) | V-Freq. (Hz) | ON-SCREEN DISPLAY | RESOLUTION               | H-Freq. (kHz) | V-Freq. (Hz) |
|-------------------|-------------------------|---------------|--------------|-------------------|--------------------------|---------------|--------------|
| VGA 1             | 640x480                 | 31.470        | 59.880       | SXGA 6            | 1280x1024                | 71.690        | 67.190       |
| VGA 2             | 720x400                 | 31.470        | 70.090       | SXGA 7            | 1280x1024                | 81.130        | 76.107       |
| VGA 3             | 640x400                 | 31.470        | 70.090       | SXGA 8            | 1280x1024                | 63.980        | 60.020       |
| VGA 4             | 640x480                 | 37.860        | 74.380       | SXGA 9            | 1280x1024                | 79.976        | 75.025       |
| VGA 5             | 640x480                 | 37.860        | 72.810       | SXGA 10           | 1280x960                 | 60.000        | 60.000       |
| VGA 6             | 640x480                 | 37.500        | 75.000       | SXGA 11           | 1152x900                 | 61.200        | 65.200       |
| VGA 7             | 640x480                 | 43.269        | 85.000       | SXGA 12           | 1152x900                 | 71.400        | 75.600       |
| MAC LC13          | 640x480                 | 34.970        | 66.600       | SXGA 13           | 1280x1024<br>(Interface) | 50.000        | 86.000       |
| MAC 13            | 640x480                 | 35.000        | 66.670       | SXGA 14           | 1280x1024<br>(Interface) | 50.000        | 94.000       |
| 480p              | 640x480                 | 31.470        | 59.880       | SXGA 15           | 1280x1024                | 63.370        | 60.010       |
| 575p              | 768x575                 | 31.250        | 50.000       | SXGA 16           | 1280x1024                | 76.970        | 72.000       |
| 575i              | 768x576<br>(Interface)  | 15.625        | 50.000       | SXGA 17           | 1152x900                 | 61.850        | 66.000       |
| 480i              | 640x480<br>(Interface)  | 15.734        | 60.000       | SXGA 18           | 1280x1024<br>(Interface) | 46.430        | 86.700       |
| SVGA 1            | 800x600                 | 35.156        | 56.250       | SXGA 19           | 1280x1024                | 63.790        | 60.180       |
| SVGA 2            | 800x600                 | 37.880        | 60.320       | SXGA 20           | 1280x1024                | 91.146        | 85.024       |
| SVGA 3            | 800x600                 | 46.875        | 75.000       | SXGA+ 1           | 1400x1050                | 63.970        | 60.190       |
| SVGA 4            | 800x600                 | 53.674        | 85.060       | SXGA+ 2           | 1400x1050                | 65.350        | 60.120       |
| SVGA 5            | 800x600                 | 48.080        | 72.190       | SXGA+ 3           | 1400x1050                | 65.120        | 59.900       |
| SVGA 6            | 800x600                 | 37.900        | 61.030       | SXGA+ 4           | 1400x1050                | 64.030        | 60.010       |
| SVGA 7            | 800x600                 | 34.500        | 55.380       | SXGA+ 5           | 1400x1050                | 62.500        | 58.600       |
| SVGA 8            | 800x600                 | 38.000        | 60.510       | MAC 21            | 1152x870                 | 68.680        | 75.060       |
| SVGA 9            | 800x600                 | 38.600        | 60.310       | MAC               | 1280x960                 | 75.000        | 75.080       |
| SVGA 10           | 800x600                 | 32.700        | 51.090       | MAC               | 1280x1024                | 80.000        | 75.080       |
| SVGA 11           | 800x600                 | 38.000        | 60.510       | WXGA 1            | 1366x768                 | 48.360        | 60.000       |
| MAC 16            | 832x624                 | 49.720        | 74.550       | WXGA 2            | 1360x768                 | 47.700        | 60.000       |
| XGA 1             | 1024x768                | 48.360        | 60.000       | WXGA 3            | 1376x768                 | 48.360        | 60.000       |
| XGA 2             | 1024x768                | 68.677        | 84.997       | WXGA 4            | 1360x768                 | 56.160        | 72.000       |
| XGA 3             | 1024x768                | 60.023        | 75.030       | WXGA 6            | 1280x768                 | 47.776        | 59.870       |
| XGA 4             | 1024x768                | 56.476        | 70.070       | WXGA 7            | 1280x768                 | 60.289        | 74.893       |
| XGA 5             | 1024x768                | 60.310        | 74.920       | WXGA 8            | 1280x768                 | 68.633        | 84.837       |
| XGA 6             | 1024x768                | 48.500        | 60.020       | WXGA 9            | 1280x800                 | 49.600        | 60.050       |
| XGA 7             | 1024x768                | 44.000        | 54.580       | WXGA 10           | 1280x800                 | 41.200        | 50.000       |
| XGA 8             | 1024x768                | 63.480        | 79.350       | WXGA 11           | 1280x800                 | 49.702        | 59.810       |
| XGA 9             | 1024x768<br>(Interface) | 36.000        | 87.170       | WUXGA 1           | 1920x1200                | 74.556        | 59.885       |
| XGA 10            | 1024x768                | 62.040        | 77.070       | WSXGA+ 1          | 1680x1050                | 65.290        | 59.954       |
| XGA 11            | 1024x768                | 61.000        | 75.700       | WXGA+ 1           | 1440x900                 | 55.935        | 59.887       |
| XGA 12            | 1024x768<br>(Interface) | 35.522        | 86.960       | UXGA 1            | 1600x1200                | 75.000        | 60.000       |
| XGA 13            | 1024x768                | 46.900        | 58.200       | UXGA 2            | 1600x1200                | 81.250        | 65.000       |
| XGA 14            | 1024x768                | 47.000        | 58.300       | UXGA 3            | 1600x1200                | 87.500        | 70.000       |
| XGA 15            | 1024x768                | 58.030        | 72.000       | UXGA 4            | 1600x1200                | 93.750        | 75.000       |
| MAC 19            | 1024x768                | 60.240        | 75.080       | 720p              | 1280x720                 | 45.000        | 60.000       |
| SXGA 1            | 1152x864                | 64.200        | 70.400       | 720p              | 1280x720                 | 37.500        | 50.000       |
| SXGA 2            | 1280x1024               | 62.500        | 58.600       | 1035i             | 1920x1035<br>(Interface) | 33.750        | 60.000       |
| SXGA 3            | 1280x1024               | 63.900        | 60.000       | 1080i             | 1920x1080<br>(Interface) | 33.750        | 60.000       |
| SXGA 4            | 1280x1024               | 63.340        | 59.980       |                   | 1920x1080<br>(Interface) | 28.125        | 50.000       |
| SXGA 5            | 1280x1024               | 63.740        | 60.010       |                   |                          |               |              |

✓ **Note:**

- True cannot be selected when \* is selected. (p.43)



When an input signal is digital from the DVI terminal, refer to the chart below.

| ON-SCREEN DISPLAY | RESOLUTION | H-Freq. (kHz) | V-Freq. (Hz) | ON-SCREEN DISPLAY | RESOLUTION               | H-Freq. (kHz) | V-Freq. (Hz) |
|-------------------|------------|---------------|--------------|-------------------|--------------------------|---------------|--------------|
| D-VGA             | 640x480    | 31.470        | 59.940       | D-WXGA 11         | 1280x800                 | 49.702        | 59.810       |
| D-480p            | 720x480    | 31.470        | 59.880       | D-SXGA 2          | 1280x1024                | 60.276        | 58.069       |
| D-575p            | 720x575    | 31.250        | 50.000       | D-SXGA 3          | 1280x1024                | 31.650        | 29.800       |
| D-SVGA            | 800x600    | 37.879        | 60.320       | D-WXGA+ 1         | 1440x900                 | 55.935        | 59.887       |
| D-XGA             | 1024x768   | 43.363        | 60.000       | D-720p            | 1280x720                 | 45.000        | 60.000       |
| D-WXGA 1          | 1366x768   | 48.360        | 60.000       | D-720p            | 1280x720                 | 37.500        | 50.000       |
| D-WXGA 2          | 1360x768   | 47.700        | 60.000       | D-1035i           | 1920x1035<br>(Interlace) | 33.750        | 60.000       |
| D-WXGA 3          | 1376x768   | 48.360        | 60.000       | D-1080i           | 1920x1080<br>(Interlace) | 33.750        | 60.000       |
| D-WXGA 4          | 1360x768   | 56.160        | 72.000       |                   | 1920x1080<br>(Interlace) | 28.125        | 50.000       |
| D-WXGA 5          | 1366x768   | 46.500        | 50.000       |                   | D-1080psf/30             | 1920x1080     | 33.750       |
| D-WXGA 6          | 1280x768   | 47.776        | 59.870       | D-1080psf/25      | 1920x1080                | 28.125        | 50.000       |
| D-WXGA 7          | 1280x768   | 60.289        | 74.893       | D-1080psf/24      | 1920x1080                | 27.000        | 48.000       |
| D-WXGA 9          | 1280x800   | 49.600        | 60.050       |                   |                          |               |              |
| D-WXGA 10         | 1280x800   | 41.200        | 50.000       |                   |                          |               |              |

**✓ Note:**

- Depending on the condition of signals and the type and length of cables, these signals may not be properly viewed.
- Specifications are subject to change without notice.

 The CE Mark is a Directive conformity mark of the European Community (EC).



This symbol on the nameplate means the product is Listed by Underwriters Laboratories Inc. It is designed and manufactured to meet rigid U.L. safety standards against risk of fire, casualty, and electrical hazards.

## Technical Specifications

### Mechanical Information

---

|                        |  |
|------------------------|--|
| Projector Type         | Multi-media Projector                                    |
| Dimensions (W x H x D) | 14.56" x 7.36" x 17.32" (370.0 mm x 187.0 mm x 439.9 mm) |
| Net Weight             | 25.1 lbs (11.4 kg)                                       |
| Feet Adjustment        | 0° to 6.5°   |

### Panel Resolution

---

|                  |                                       |
|------------------|---------------------------------------|
| LCD Panel System | 1.3" TFT Active Matrix type, 3 panels |
| Panel Resolution | 1,024 x 768 dots                      |
| Number of Pixels | 2,359,296 (1,024 x 768 x 3 panels)    |

### Signal Compatibility

---

|                           |  |
|---------------------------|--|
| Color System              | PAL, SECAM, NTSC, NTSC4.43, PAL-M, and PAL-N   |
| High Definition TV Signal | 480i, 480p, 575i, 575p, 720p, 1035i, and 1080i |
| Scanning Frequency        | H-sync. 15 kHz–100 kHz, V-sync. 48 Hz–100 Hz   |

### Optical Information

---

|                 |                 |
|-----------------|-----------------|
| Projection Lamp | 330 W NSHA lamp |
|-----------------|-----------------|

### Interface

---

|               |   |
|---------------|---|
| Input 1       | Digital (DVI-D) x 1, Analog (Mini D-sub 15 pin) x 1           |
| Input 2       | BNC Type x 5 (G or Video/Y, B or Cb-Pb, R or Cr-Pr, HV and V) |
| Input 3       | RCA Type x 3 (Video/Component), Mini DIN 4 pin x 1 (S-video)  |
| Monitor Out   | Analog RGB (Mini D-sub 15 pin) Terminal x 1                   |
| Audio Out     | Audio (Mini Type stereo) x 1                                  |
| Audio In I/II | Audio (Mini Type stereo) x 2                                  |
| R/C Jack      | Mini jack (Wired Remote) x 1                                  |
| Control Port  | D-sub 9 pin x 1   |
| USB Connector | USB Series B x 1  |
| Option        | Pj-to NetDirector x 1   |

### Power

---

|                               |   |
|-------------------------------|---|
| Voltage and Power Consumption | AC 100–120 V (4.6A Max. Ampere), 50/60 Hz (The U.S.A and Canada)<br>AC 200–240 V (2.3A Max. Ampere), 50/60 Hz (Continental Europe and The U.K.) |
|-------------------------------|---|

### Operating Environment

---

|                       |                         |
|-----------------------|-------------------------|
| Operating Temperature | 41°F–104°F (5°C–40°C)   |
| Storage Temperature   | 14°F–140°F (-10°C–60°C) |

### Remote Control

---

|                 |   |
|-----------------|---|
| Battery         | AAA or LR03 Type x 2                                    |
| Operating Range | 16.4' (5 m/±30°)  |
| Dimensions      | 1.8" (W) x 1.0" (H) x 5.7" (D) (45 mm x 25 mm x 145 mm) |
| Net Weight      | 3.5 oz (99 g) (including batteries)                     |

### Accessories

---

|                              |                                     |
|------------------------------|-------------------------------------|
| Owner's Manual (CD-ROM)      | Lens Attachment (For option lens)   |
| Quick Reference Guide        | Light-block sheet (For option lens) |
| AC Power Cord                | Spacer (For option lens)            |
| Remote Control and Batteries |                                     |
| VGA Cable                    |                                     |
| USB Cable                    |                                     |
| PIN Code Label               |                                     |
| Remote Control Cable         |                                     |

- The specifications are subject to change without notice.
- LCD panels are manufactured to the highest possible standards. Even though 99.99% of the pixels are effective, a tiny fraction of the pixels (0.01% or less) may be ineffective by the characteristics of the LCD panels.

## Optional Parts

The parts listed below are optionally available. When ordering those parts, specify the item name and Model No. to the sales dealer.

|                             | <i>Model No.</i>     |
|-----------------------------|----------------------|
| <b>Standard Zoom Lens</b>   | : AH-23061/ AH-23081 |
| <b>Long Zoom Lens</b>       | : AH-23132           |
| <b>Ultra Long Zoom Lens</b> | : AH-24241           |
| <b>Short Zoom Lens</b>      | : AH-23122           |
| <b>Short Fixed Lens</b>     | : AH-32011           |
| <b>COMPONENT-VGA Cable</b>  | : AH-98771           |
| <b>Pj-to NetDirector</b>    | : PjNET-30           |

## Lens Replacement

The lens of this projector can be replaced with other optional lens. This feature enables you to use the projector for wide variety of uses.

For installation and replacement of the lens, always contact the sales dealer. The projector lens must be installed or replaced by well-trained sales or service engineers. Do not attempt to install and replace the lens by yourself as it may cause injury.



Do not hold the lens when carrying or lifting the projector. It may cause serious damage to the projector.

### To the sales and service engineers:

For the lens replacement and lens installation, refer to the installation manual of the optional lens. Before replacing and installing the lens, make sure that you are using the lens with the correct Type No.

## PJ Link Notice

This projector is compliant with PJLink Standard Class 1 of JBMIA (Japan Business Machine and Information System Industries Association). The projector supports all commands defined by PJLink Class 1 and is verified conformance with PJLink Standard Class 1.

| Projector Input |                  | PJLink Input | Parameter |
|-----------------|------------------|--------------|-----------|
| Input 1         | RGB (PC analog)  | RGB 1        | 11        |
|                 | RGB (Scart)      | RGB 2        | 12        |
|                 | RGB (PC digital) | DIGITAL 1    | 31        |
|                 | RGB (AV HDCP)    | DIGITAL 2    | 32        |
| Input 2         | Video            | VIDEO 1      | 21        |
|                 | Y, Pb/Cb,Pr/Cr   | VIDEO 2      | 22        |
|                 | RGB              | RGB 3        | 13        |
| Input 3         | Video            | VIDEO 3      | 23        |
|                 | Y, Pb/Cb,Pr/Cr   | VIDEO 4      | 24        |
|                 | S-video          | VIDEO 5      | 25        |
| Input 4         | Network          | NETWORK 1    | 51        |

PJLink is a registered trademark of JBMIA and pending trademark in some countries.



## Configurations of Terminals

### ANALOG/ MONITOR OUT (Mini D-sub 15 pin)

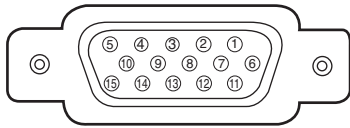

#### Input

|   |                      |    |  |
|---|----------------------|----|--|
| 1 | Red Input            | 9  | +5V Power                                |
| 2 | Green Input          | 10 | Ground (Vert.sync.)                      |
| 3 | Blue Input           | 11 | Ground                                   |
| 4 | No Connect           | 12 | DDC Data                                 |
| 5 | Ground (Horiz.sync.) | 13 | Horiz. sync. Input (Composite H/V sync.) |
| 6 | Ground (Red)         | 14 | Vert. sync. Input                        |
| 7 | Ground (Green)       | 15 | DDC Clock                                |
| 8 | Ground (Blue)        |    |  |

#### Output

|   |                      |    |                     |
|---|----------------------|----|---------------------|
| 1 | Red Output           | 9  | No Connect          |
| 2 | Green Output         | 10 | Ground (Vert.sync.) |
| 3 | Blue Output          | 11 | No Connect          |
| 4 | No Connect           | 12 | No Connect          |
| 5 | Ground (Horiz.sync.) | 13 | Horiz. sync. Output |
| 6 | Ground (Red)         | 14 | Vert. sync. Output  |
| 7 | Ground (Green)       | 15 | No Connect          |
| 8 | Ground (Blue)        |    |                     |

### DIGITAL DVI-D (DVI 24 PIN)

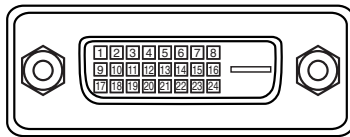

|   |                       |    |                       |    |                       |
|---|-----------------------|----|-----------------------|----|-----------------------|
| 1 | T.M.D.S. Data2-       | 9  | T.M.D.S. Data1-       | 17 | T.M.D.S. Data0-       |
| 2 | T.M.D.S. Data2+       | 10 | T.M.D.S. Data1+       | 18 | T.M.D.S. Data0+       |
| 3 | T.M.D.S. Data2 Shield | 11 | T.M.D.S. Data1 Shield | 19 | T.M.D.S. Data0 Shield |
| 4 | No Connect            | 12 | No Connect            | 20 | No Connect            |
| 5 | No Connect            | 13 | No Connect            | 21 | No Connect            |
| 6 | DDC Clock             | 14 | +5V Power             | 22 | T.M.D.S. Clock Shield |
| 7 | DDC Data              | 15 | Ground (for +5V)      | 23 | T.M.D.S. Clock+       |
| 8 | No Connect            | 16 | Hot Plug Detect       | 24 | T.M.D.S. Clock-       |

### USB CONNECTOR (Series B)

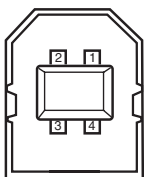

|   |        |
|---|--------|
| 1 | Vcc    |
| 2 | - Data |
| 3 | + Data |
| 4 | Ground |

### CONTROL PORT CONNECTOR (D-sub 9 pin)

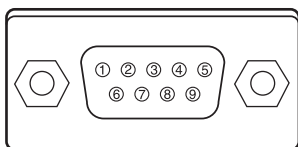

|   | Serial |
|---|--------|
| 1 | ---    |
| 2 | R X D  |
| 3 | T X D  |
| 4 | ---    |
| 5 | SG     |
| 6 | ---    |
| 7 | RTS    |
| 8 | CTS    |
| 9 | ---    |

### ***PIN Code Number Memo***

Write down the PIN code number in the column below and keep it with this manual securely. If you forgot or lost the number and unable to operate the projector, contact the service station.

|                                      |  |  |  |  |  |
|--------------------------------------|--|--|--|--|--|
| <b><i>PIN Code Lock No.</i></b>      | <table border="1"> <tr> <td style="width: 30px; height: 30px;"></td> <td style="width: 30px; height: 30px;"></td> <td style="width: 30px; height: 30px;"></td> <td style="width: 30px; height: 30px;"></td> </tr> </table> |  |  |  |  |
|                                      |  |  |  |  |  |
|                                      | <b><i>Factory default set No: 1 2 3 4*</i></b>   |  |  |  |  |
| <b><i>Logo PIN Code Lock No.</i></b> | <table border="1"> <tr> <td style="width: 30px; height: 30px;"></td> <td style="width: 30px; height: 30px;"></td> <td style="width: 30px; height: 30px;"></td> <td style="width: 30px; height: 30px;"></td> </tr> </table> |  |  |  |  |
|                                      |  |  |  |  |  |
|                                      | <b><i>Factory default set No: 4 3 2 1*</i></b>   |  |  |  |  |
|                                      | <p><i>*Should the four-digit number be changed, the factory set number will be invalid.</i></p>  |  |  |  |  |

While the projector is locked with the PIN code...

Put the label below (supplied) on in a prominent place of the projector's body while it is locked with a PIN code.

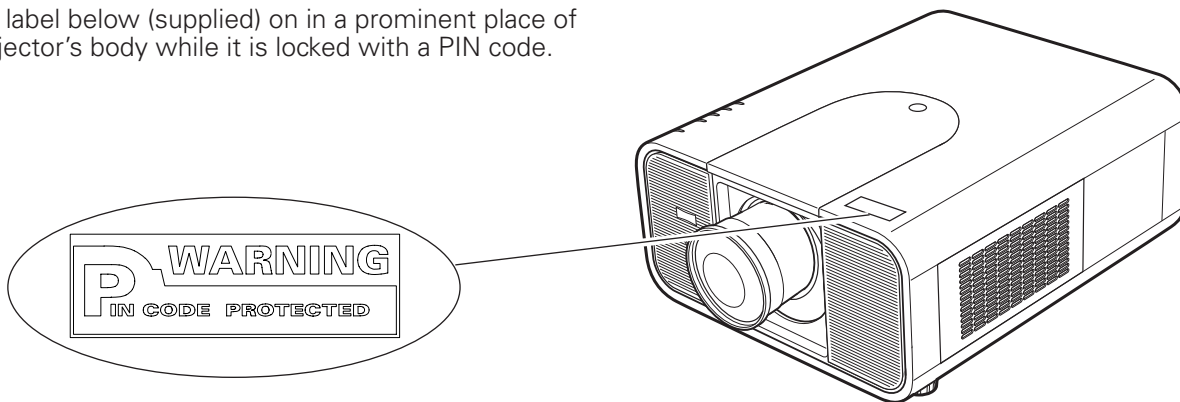

## Dimensions

Unit: inch (mm)

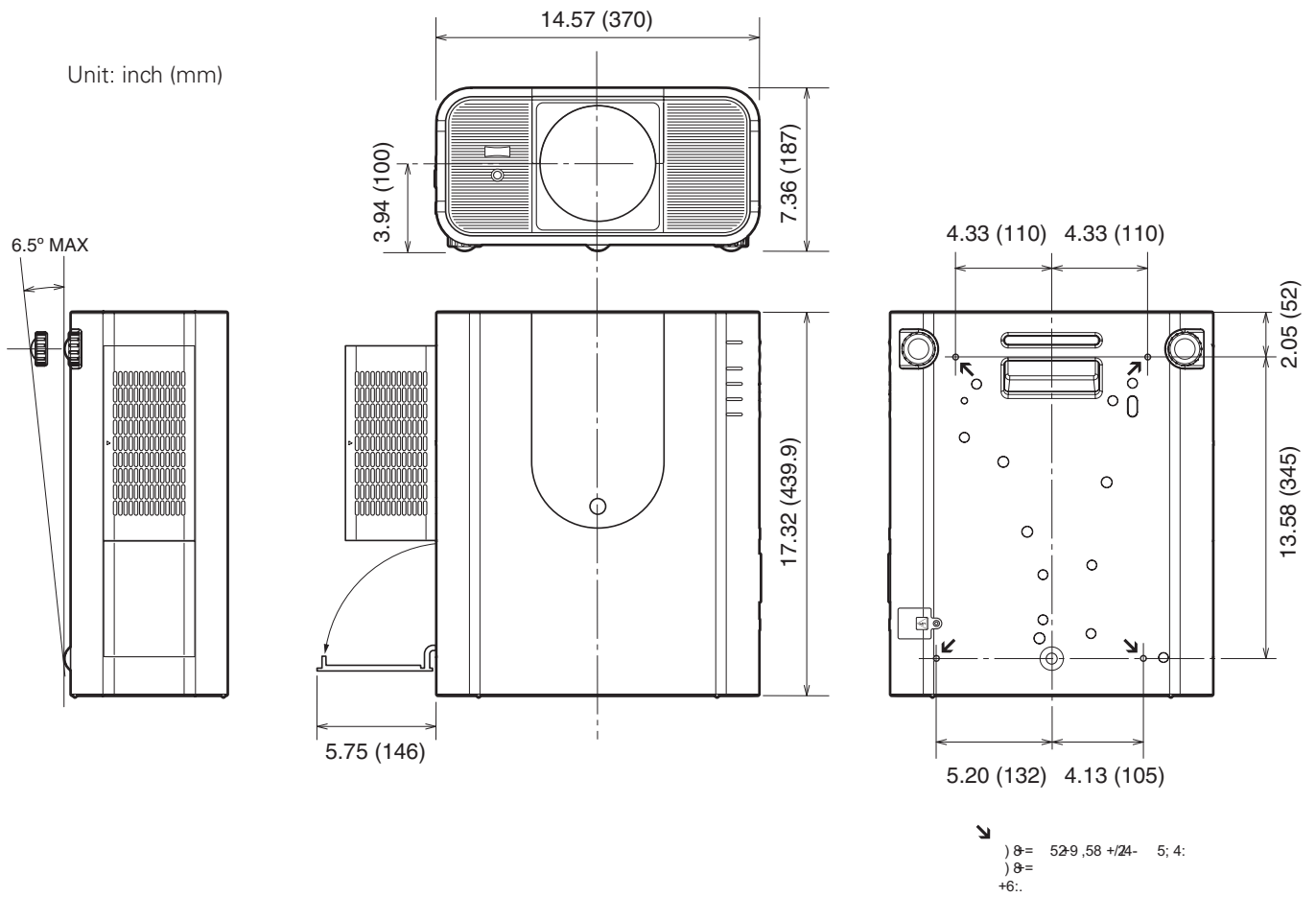

## Serial Control Interface

This projector provides a function to control and monitor the projector's operations by using the RS-232C serial port.

### Operation

- 1 Connect a RS-232C serial cross cable to CONTROL PORT on the projector and serial port on the PC.  
(See p.22)
- 2 Launch a communication software provided with PC and setup the communication condition as follows:

|              |                    |
|--------------|--------------------|
| Baud rate    | : 9600 / 19200 bps |
| Parity check | : none             |
| Stop bit     | : 1                |
| Flow control | : none             |
| Data bit     | : 8                |

✓ **Note:**

- *The default of the baud rate is set to 19200 bps. If an error occurs in the communication, change the serial port and the communication speed (baud rate).*

- 3 Type the command for controlling the projector and then enter the "Enter" key.

**Example**

When you want to change the input to INPUT 2, Type 'C' '0' '6' 'Enter'.

✓ **Note:**

- *Enter with ASCII 64-byte capital characters and one-byte characters.*

## Functional Execution Command

### Format

The command is sent from PC to the projector with the format below;

'C' [Command] 'CR'

Command: two characters (refer to the command table below.

-The projector decodes the command and returns the 'ACK' with the format below;

'ACK' 'CR'

-When the projector can not decode the command, it returns with format below.

'?' 'CR'

| Command | Function                                 |
|---------|--|
| C00     | Turn the projector ON                    |
| C01     | Turn the projector OFF (immediately OFF) |
| C02     | Turn the projector OFF                   |
| C05     | Select Input 1                           |
| C06     | Select Input 2                           |
| C07     | Select Input 3                           |
| C08     | Select Network                           |
| C09     | Volume +                                 |
| C0A     | Volume -                                 |
| C0B     | Sound mute ON                            |
| C0C     | Sound mute OFF                           |
| C0D     | Video mute ON                            |
| C0E     | Video mute OFF                           |
| C0F     | Aspect 4:3                               |
| C10     | Aspect 16:9                              |
| C1C     | Menu ON                                  |
| C1D     | Menu OFF                                 |
| C20     | Brightness UP                            |
| C21     | Brightness DOWN                          |
| C23     | Select Input 2 Video                     |
| C24     | Select Input 2 Y, Pb/Cb,Pr/Cr            |
| C25     | Select Input 2 RGB                       |
| C28     | ON Start ON                              |
| C29     | ON Start OFF                             |
| C33     | Select Input 3 Video                     |
| C34     | Select Input 3 S-video                   |
| C35     | Select Input 3 Y, Pb/Cb,Pr/Cr            |

| Command | Function                        |
|---------|---------------------------------|
| C3A     | Pointer RIGHT                   |
| C3B     | Pointer LEFT                    |
| C3C     | Pointer UP                      |
| C3D     | Pointer DOWN                    |
| C3F     | Enter                           |
| C46     | Zoom DOWN                       |
| C47     | Zoom UP                         |
| C4A     | Focus DOWN                      |
| C4B     | Focus UP                        |
| C50     | Select Input 1 Analog RGB       |
| C51     | Select Input 1 SCART            |
| C52     | Select Input 1 DVI (PC Digital) |
| C53     | Select Input 1 DVI (AV HDCP)    |
| C5D     | Lens shift UP                   |
| C5E     | Lens shift DOWN                 |
| C5F     | Lens shift LEFT                 |
| C60     | Lens shift RIGHT                |
| C89     | Auto PC Adj.                    |
| C8E     | Keystone UP                     |
| C8F     | Keystone DOWN                   |
| C90     | Keystone RIGHT                  |
| C91     | Keystone LEFT                   |



## Status Read Command

### Format

The command is sent from PC to the projector with the format below;

'CR' [Command] 'CR'

Command: one character (refer to the command table below).

The projector decodes the command and returns the 'Character string' with the format below;

| Command | Function   | Projector Return | Projector status   |
|---------|--|------------------|--|
| CR0     | Status Read  | 00               | Power On   |
|         |  | 80               | Stand-by mode  |
|         |  | 40               | Countdown  |
|         |  | 20               | Cooling down   |
|         |  | 10               | Power Malfunction  |
|         |  | 28               | Cooling down at the temperature anomaly  |
|         |  | 24               | Cooling down at Power Management mode  |
|         |  | 04               | Power Management mode after Cooling down   |
|         |  | 21               | Cooling down after the projector is turned off when the lamps are out.   |
|         |  | 81               | Stand-by mode after Cooling down when the lamps are out.   |
|         |  | 88               | Stand-by mode after Cooling down at the temperature anomaly.   |
|         |  | 2C               | Cooling down when the projector is turned off by the shutter management function.  |
| 8C      | Stand-by mode after cooling down by the shutter management function. |                  |  |
| CR6     | Temperature Read   | S1 S2 S3         | S1 = Temperature at Sensor 1 (°C)<br>S2 = Temperature at Sensor 2 (°C)<br>S3 = Temperature at Sensor 3 (°C)<br>(ex.) S1 = 12.3°C, S2 = 23.4°C, S3 = 34.5°C<br>--> The projector displays "12.3 23.4 34.5"<br>(For each sensor, two digit and the tenth place numbers are displayed with a space between each temperature.) |
|         |  | ?                | Communication failure  |

The tables on page 86 and 87 show the typical command lists for controlling the projector. Please consult your local dealer for further information of other commands.

# EIKI

# Touchboards

205 Westwood Ave, Long Branch, NJ 07740  
Phone: 866-94 BOARDS (26273) / (732)-222-1511  
Fax: (732)-222-7088 | E-mail: [sales@touchboards.com](mailto:sales@touchboards.com)

WorldWide Website <http://www.eiki.com>