

# Quick Start Guide

MODEL LC-XIP2610

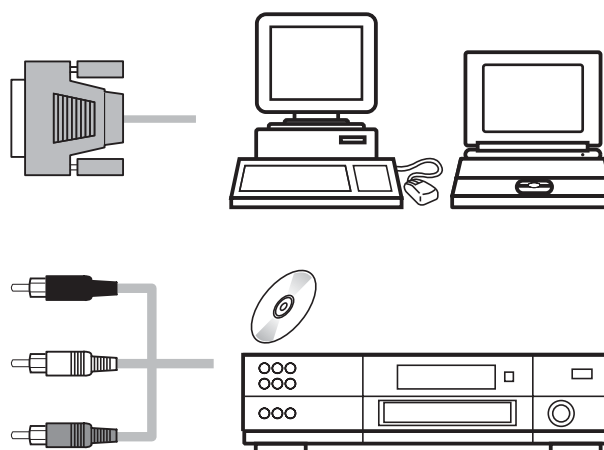
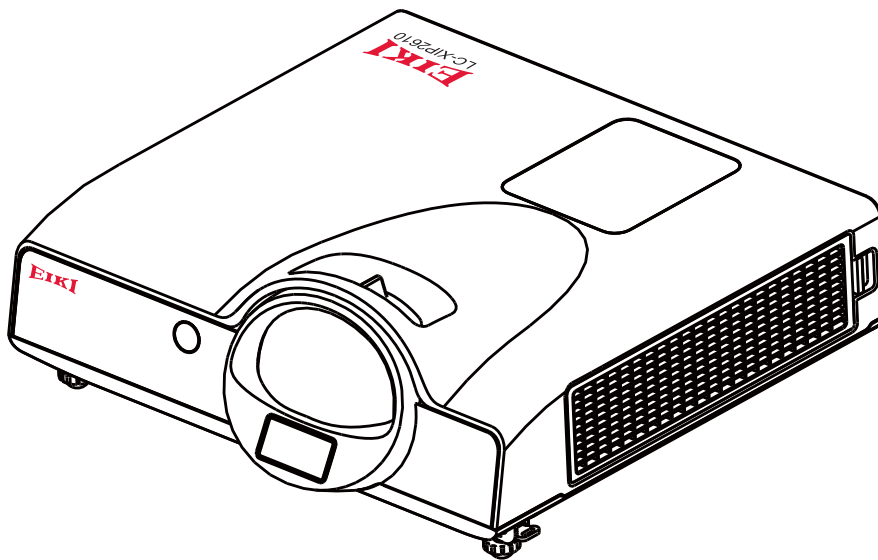

ENGLISH

DEUTSCH

FRANÇAIS

ESPAÑOL

ITALIANO

PORTUGUÊS

日本語

Use this book as a start guide when setting up the projector.

For detailed information about installation, setup and operation of the projector, refer to the owner's manual on the CD-ROM.

Read the safety instructions in owner's manual before using projector.



### Quick Start Guide

Before using, read the “ Quick Start Guide ” and the owner’s manual to ensure correct usage through understanding.

After reading, store them in a safe place for future reference.

Do not look into the lens while the projector’s power is turned on.

### Schnellstartanleitung

Lesen Sie bitte zuerst die "Schnellstartanleitung" und die "Gebrauchsanleitung", um eine richtige Verwendung dieses Produkts sicherzustellen.

Verwahren Sie die Anleitungen nach dem Lesen an einem sicheren Platz.

Blicken Sie nicht in das Objektiv, wenn der Projektor eingeschaltet ist.

### Guide De Mise En Route

Avant d'utiliser, veuillez lire le “Guide de mise en route” et le “Manuel d'utilisation” pour assurer que vous l'utilisez correctement.

Après les avoir lus, gardez-les dans un endroit sûr à titre de référence.

Ne pas regarder dans l'objectif du projecteur lorsque l'il est allumé.

### Guía de Inicio Rápido

Antes de usarlo, léase la “Guía de Inicio Rápido” y el “Manual de Usuario” para asegurarse de que puede usarlo correctamente tras haberlo comprendido.

Tras leerlo, guárdelo en un lugar seguro para futuras consultas.

No mire dentro de la lente mientras el proyector está encendido.

### Guida Rapida

Prima dell'uso, leggere la “Guida rapida” ed il “Manuale d'uso” per assicurare l'uso appropriato grazie alla conoscenza e comprensione.

Dopo la lettura, archiviare la documentazione in un posto sicuro per riferimenti futuri.

Non guardare nell'obiettivo del proiettore quando il proiettore è acceso.

### uia de consulta rápida

Antes de usar, leia o "Guia de consulta rápida" e o "Manual do proprietário" para utilizar o projector de forma correcta.

Após a leitura, guarde-os num local seguro para consultas futuras.

Não olhe para a lente enquanto o projector estiver ligado.

### クイックスタートガイド

ご使用の前に、クイックスタートガイドと取り扱い説明書をお読みください。

本書をお読みになった後は、いつでも取り出せるところに必ず保管してください。

プロジェクターが起動したとき、レンズを覗かないでください。

# EIKI

Interactive Projector

## Quick Start Guide

MODEL LC-XIP2610

ENGLISH

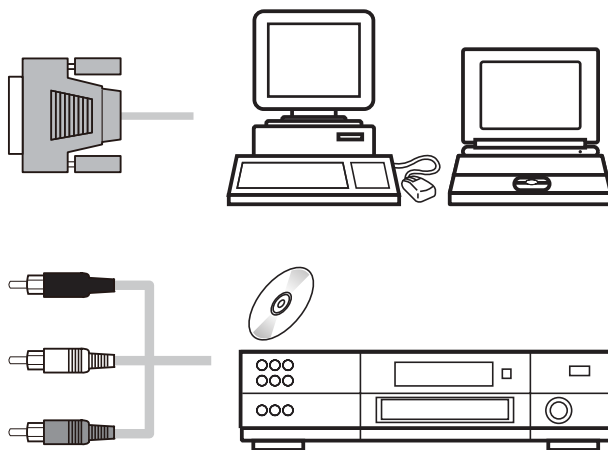
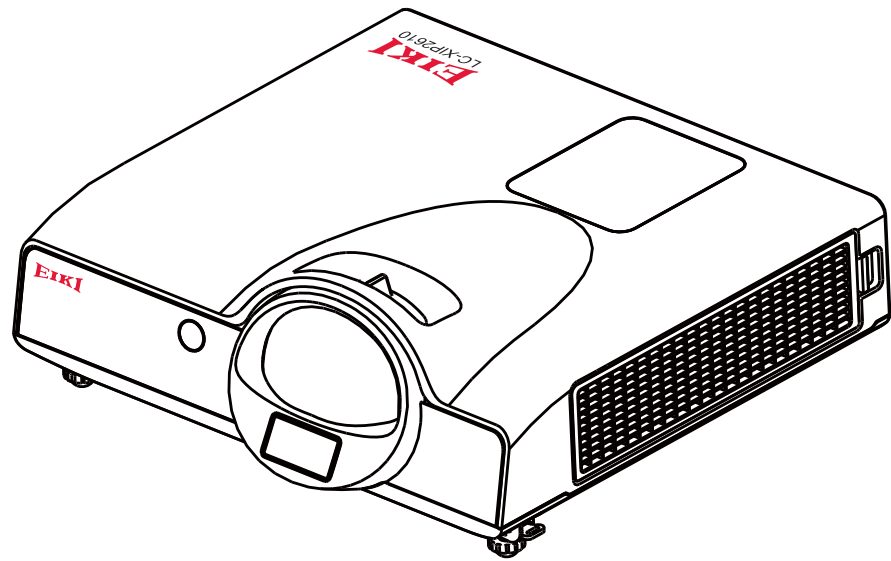

---

Use this book as a start guide when setting up the projector.  
For detailed information about installation, setup and operation of the projector,  
refer to the owner's manual on the CD-ROM.  
Read the safety instructions in owner's manual before using projector.

# Contents of Package

Please make sure that following items are included in the box, along with the projector. If any items missing, contact your dealer.

- 1 Projector
- 2 Remote Control (Include Batteries)
- 3 Power Cord
- 4 Computer Cable
- 5 USB Cable
- 6 Owner's Manual CD-ROM
- 7 Quick Start Guide
- 8 Accessory Bag
- 9 Light Pen (Include Batteries)
- 10 Pointer (Include Batteries)
- 11 Strap

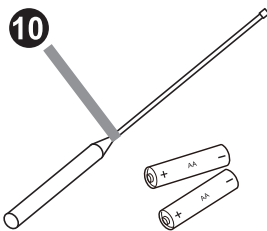
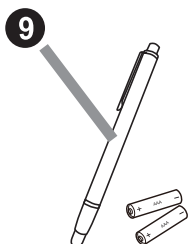
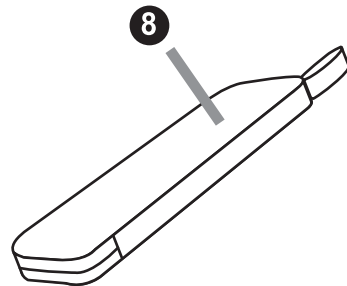
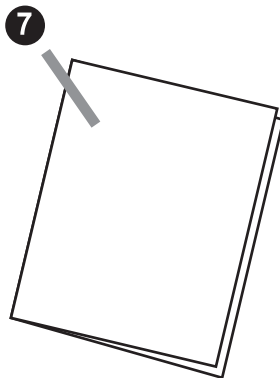
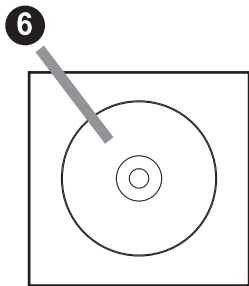
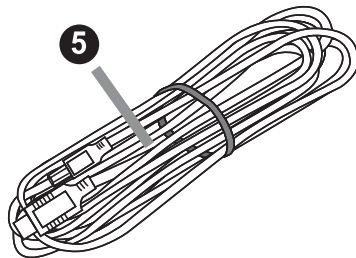
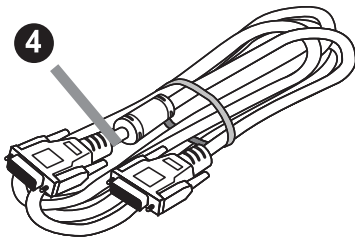
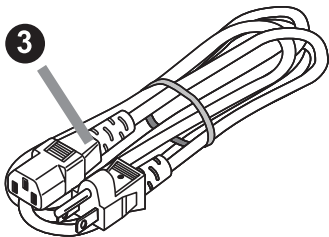
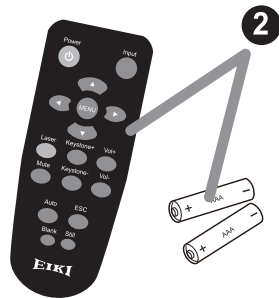
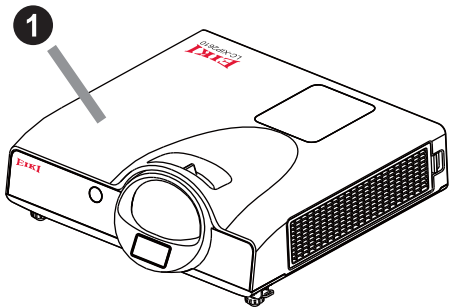

The distance between the projector and screen determines the actual image size. Refer to the table below to determine the screensize at a given distance.

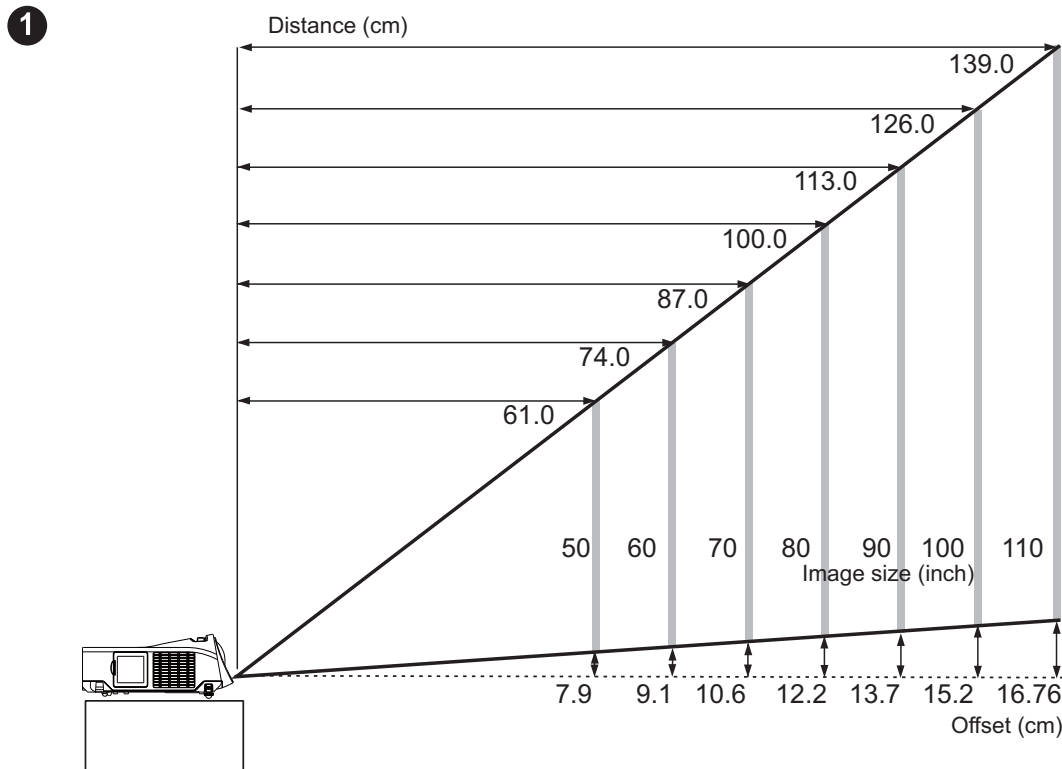

2 Note: The dimensions in the table below are approximate.

Image size (inch)	Distance (cm)	Offset (cm)
50	61.0	7.62
60	74.0	9.1
70	87.0	10.6
80	100.0	12.2
90	113.0	13.7
100	126.0	15.2
110	139.0	16.76

- ❶ Make sure that power cord is firmly and correctly connected to the projector.
- ❷ The POWER indicator will light up in slow green.
- ❸ Press POWER button on the control panel or the remote control to turn on the projector.
- ❹ Rotate the focus ring to adjust the focus.

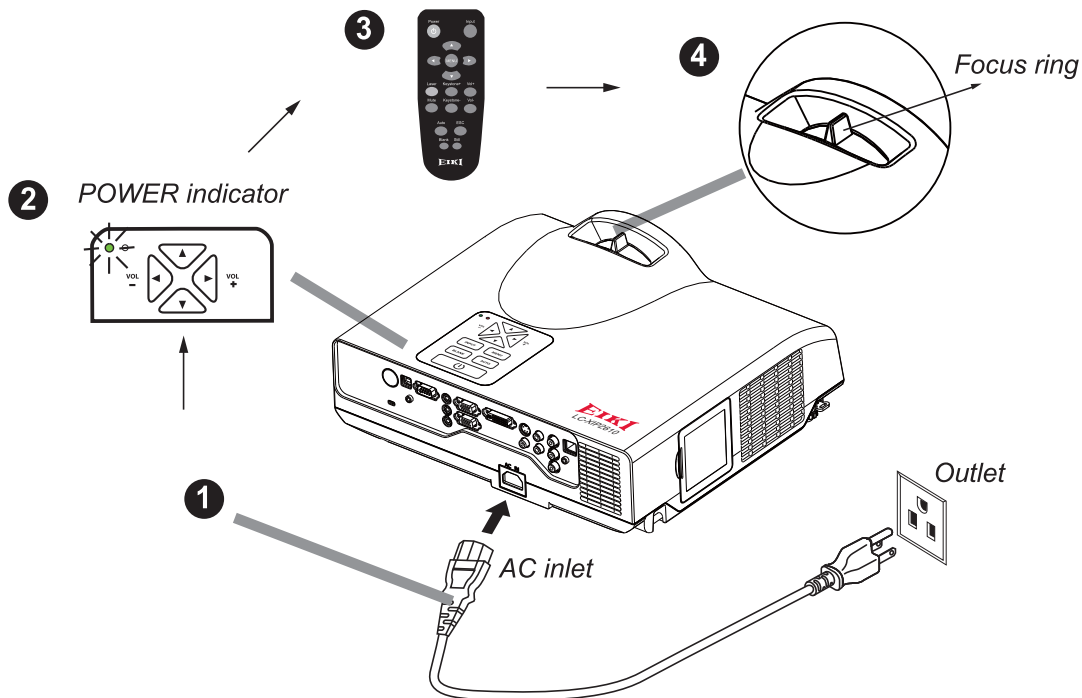

## Adjusting The Projector's Elevation

Use the adjustable feet at the front of the projector to set the image height.

- ❶ Holding the projector, push the foot adjust buttons to loosen the front adjustable feet.
- ❷ Position the front side of the projector to the desired height.
- ❸ Release the foot adjust buttons in order to lock the front adjustable feet.
- ❹ Please make sure that the front adjustable feet are locked.

### ⚠ CAUTION

1. The adjustment range of front adjustable feet is 0 to 7 degrees.
2. When the feet are adjusted, it may cause the shape of the projected image to become distorted. Use the keystone correction function to correct this distortion.

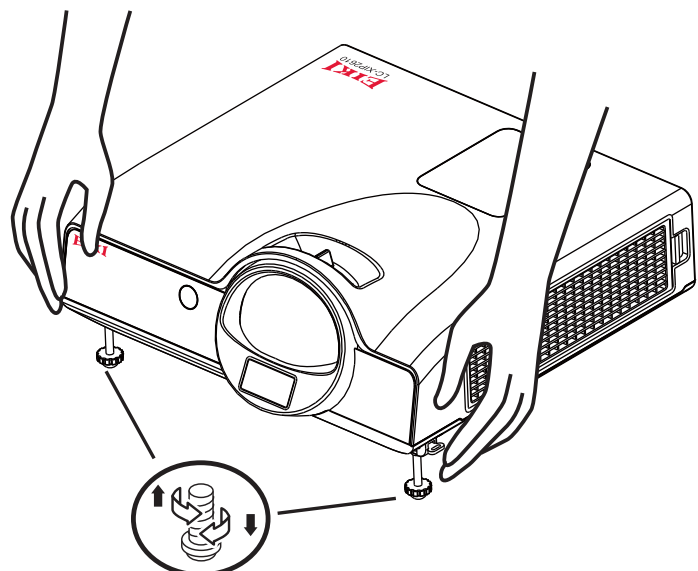

## Remote Control Battery Installation

- 1 Remove the battery cover.
- 2 Insert the battery. Make sure the plus pole is correctly oriented.
- 3 Close the battery cover.

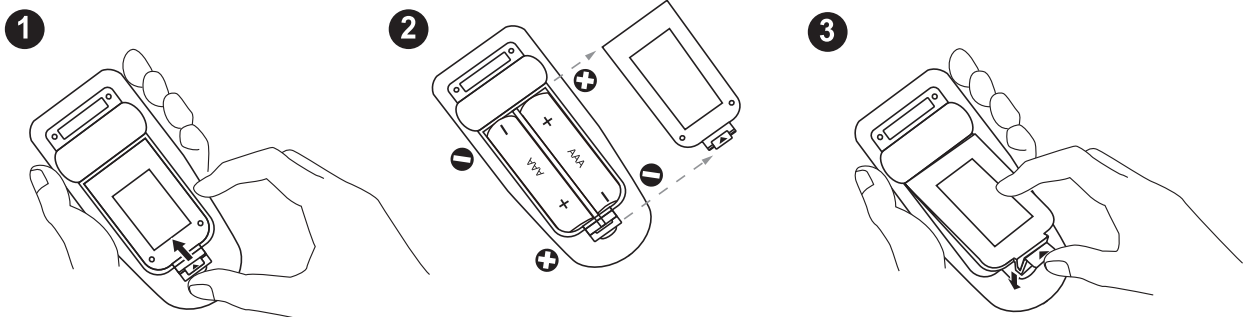

## How To Connect

### 4 Connecting to a computer

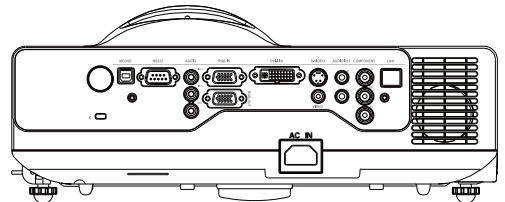

Computer		Projector
1  USB port	interactive control USB cable	USB port
2  RS-232C port	RS-232C cable	RS-232C port
3  Audio out	3.5 mm Audio cable	AUDIO IN 1
Monitor OUT	RGB cable	RGB IN
4  DVI port out	DVI cable	DVI port IN
Audio out	3.5 mm Audio cable	AUDIO IN 2
5  Network port	LAN cable	LAN

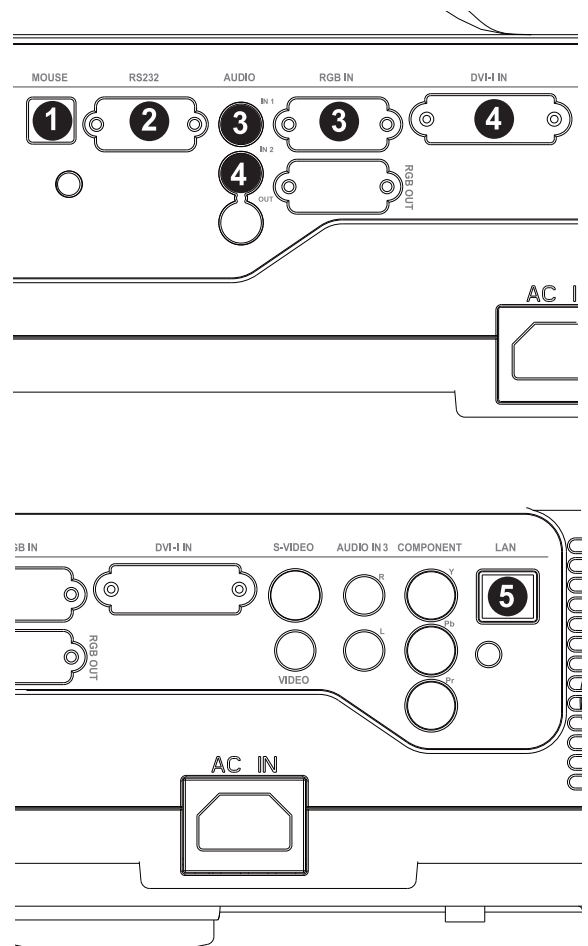



## Connecting to a monitor

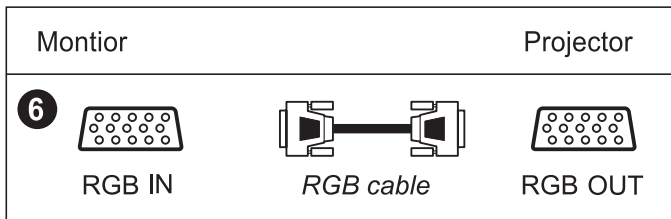
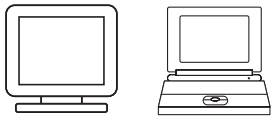

## Connecting to a speaker

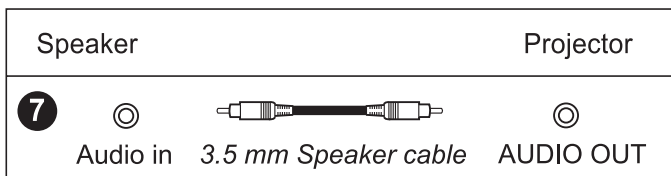

## Connecting to a VCD/DVD Player

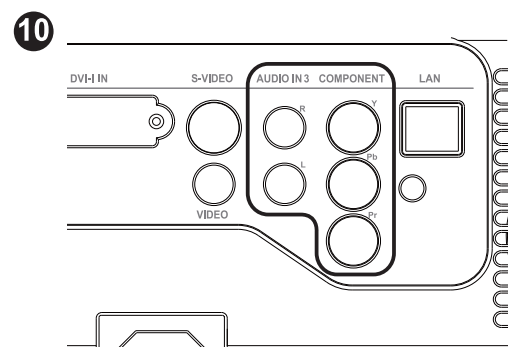
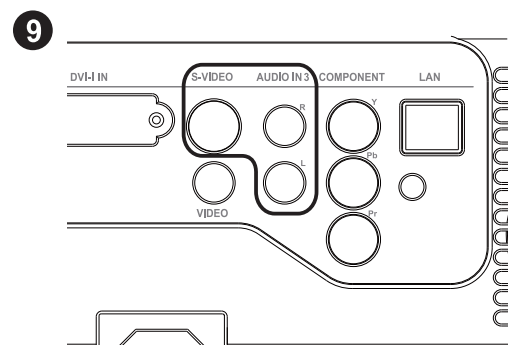
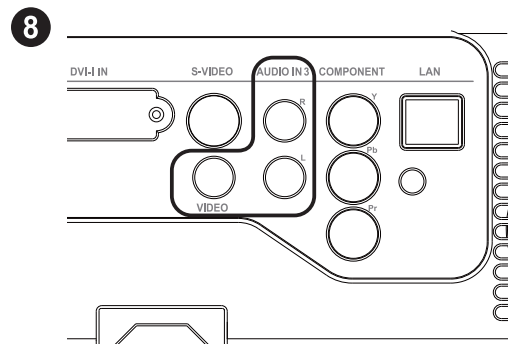
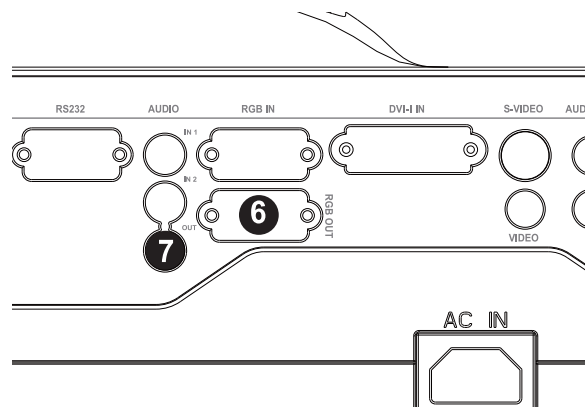
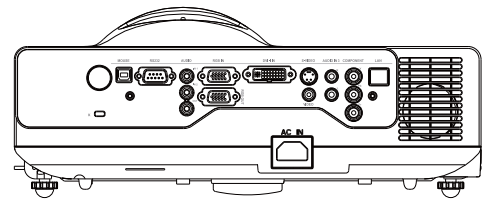
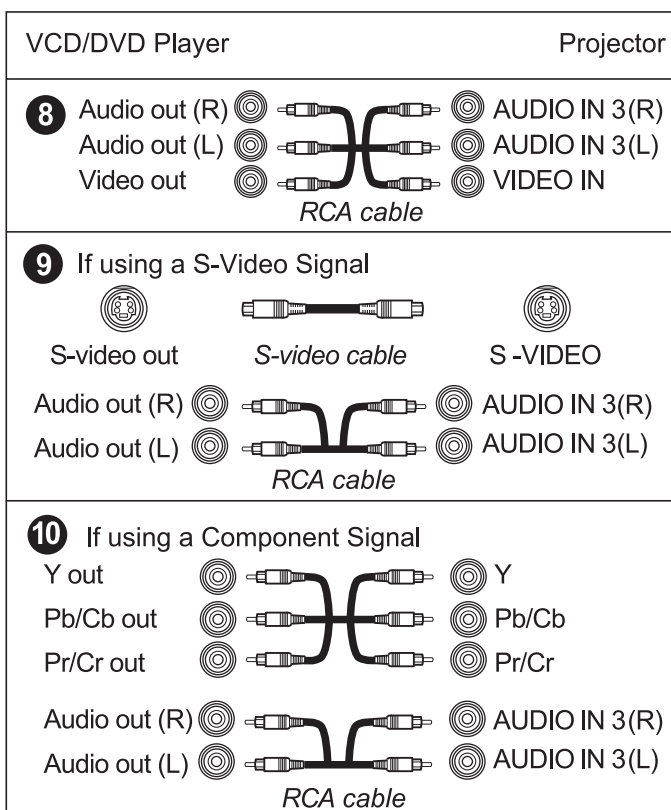
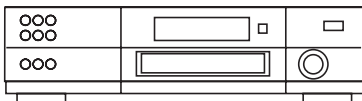

## Turning Off the Power

- 1 Press the POWER button on the control panel or the remote control.  
The " Power Off " confirmation message will appear.
- 2 Press the POWER button again while the message is shown on the screen.
- 3 When the projector enters " Standby " mode, the green POWER blinks slowly.
- 4 If you don't use the projector for a long time, remove power cord.

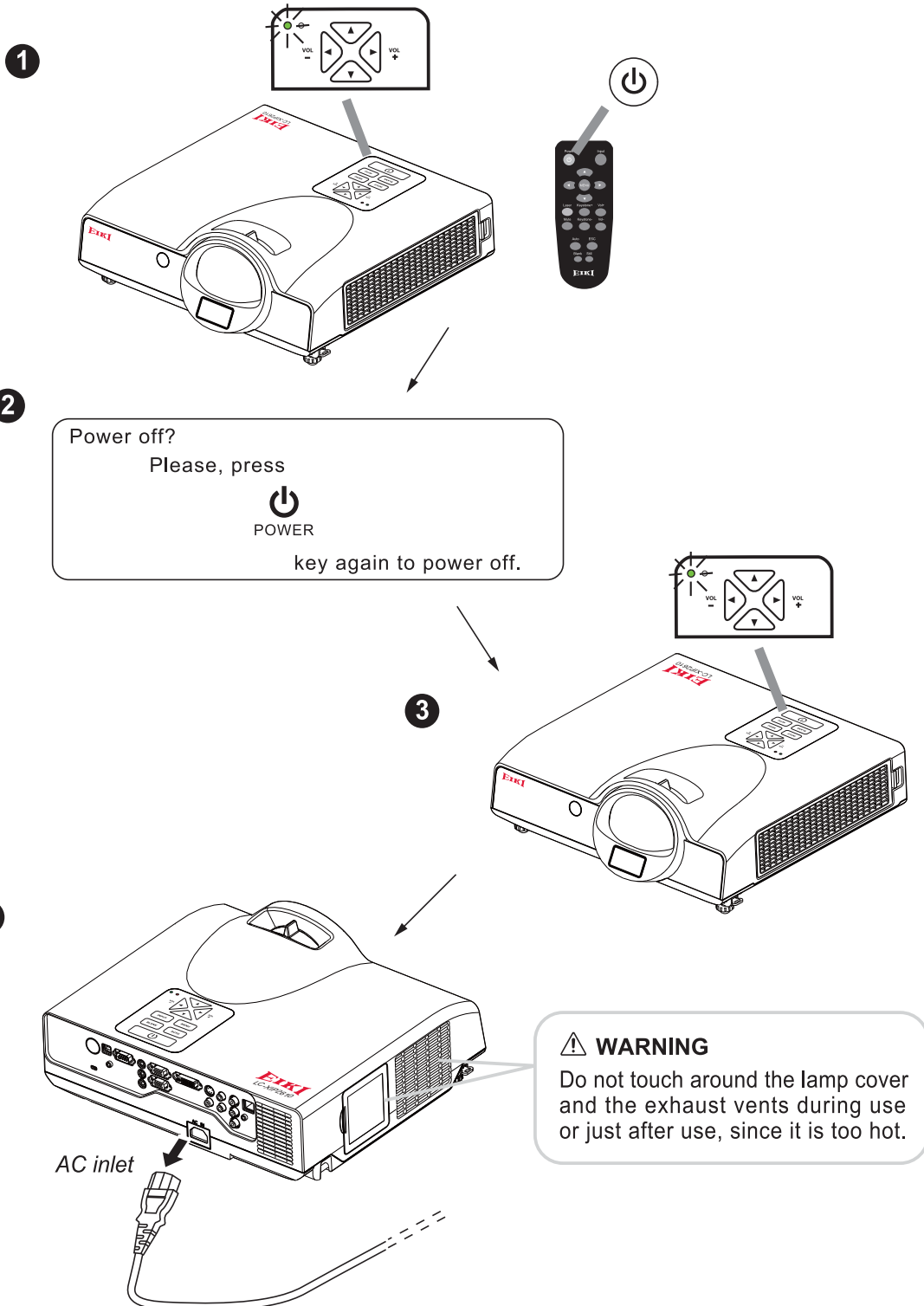



# EIKI

Interaktiver Projektor

## Schnellstartanleitung

Modell LC-XIP2610

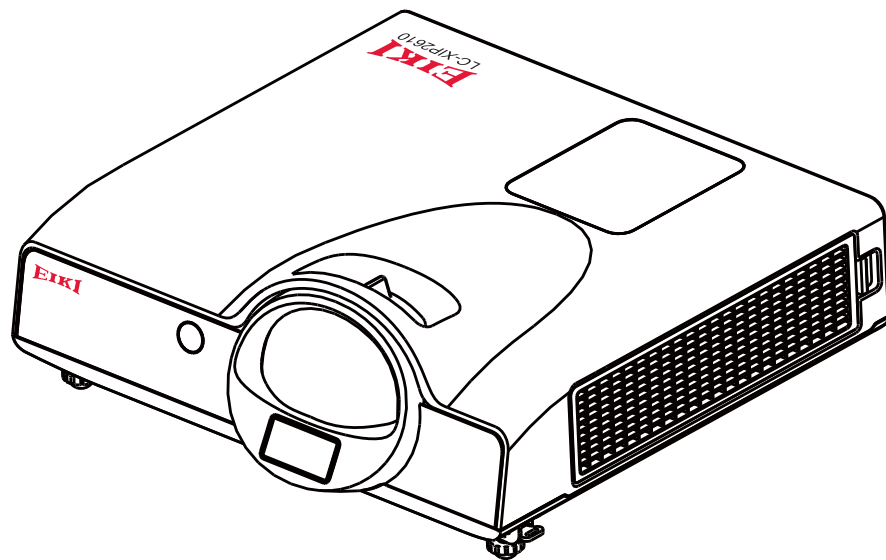

DEUTSCH

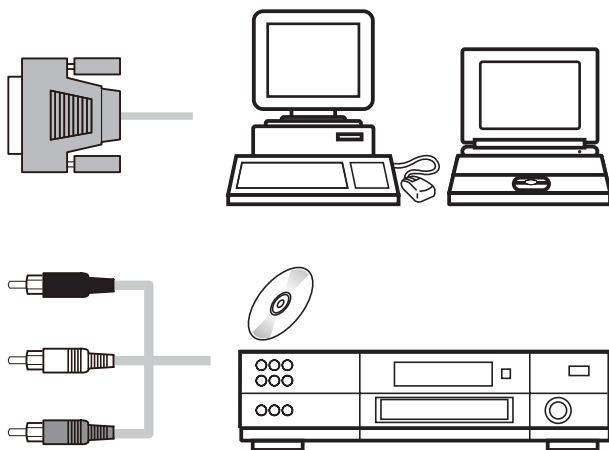

Benutzen Sie dieses Buch wie ein Anfangsführer, wenn Sie den Projektor gründen. Für ausführliche Information über Installation, beziehen sich Einstellung und Betrieb des Projektors, auf das Handbuch des Inhabers auf der CD-ROM. Vor der Anwendung des Projektors lesen Sie die Sicherheitsvorschriften in diesem schnelles Anfangsführer.

Stellen Sie bitte sicher, dass die folgenden Artikel mitgeliefert sind. Wenden Sie sich umgehend an Ihren Händler, falls irgendein Artikel fehlt.

- |                                     |                         |                                |
|-------------------------------------|-------------------------|--------------------------------|
| 1 Projektor                         | 5 USB-Kabel             | 9 Stift (gehören Batterien)    |
| 2 Fernbedienung (gehören Batterien) | 6 Gebrauchsanleitung-CD | 10 Pointer (gehören Batterien) |
| 3 Netzkabel                         | 7 Schnellstartanleitung | 11 Gurt                        |
| 4 Computerkabel                     | 8 Zubehörtasche         |                                |

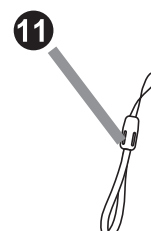
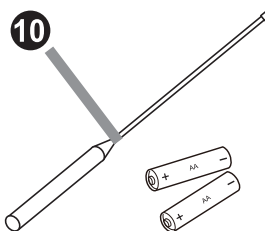
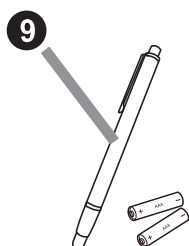
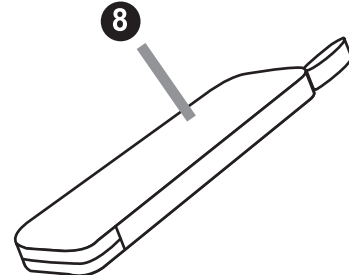
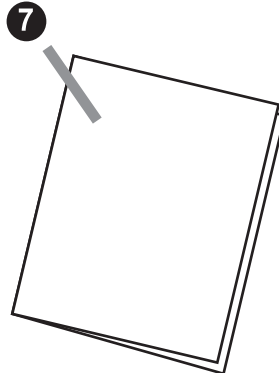
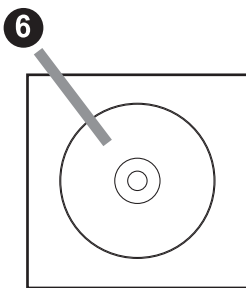
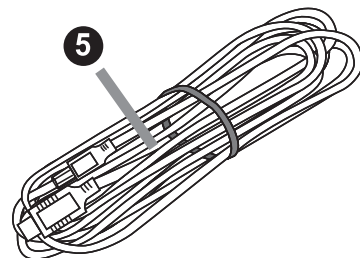
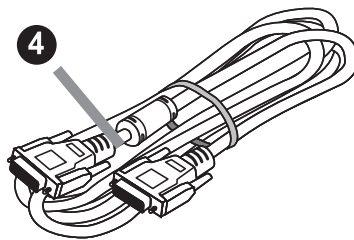
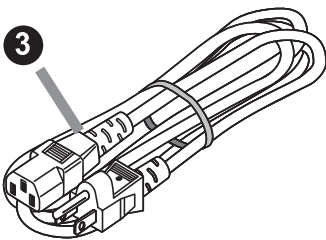
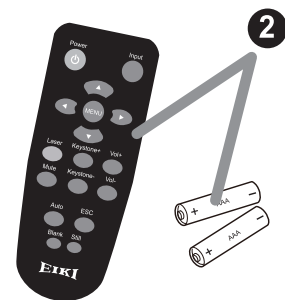
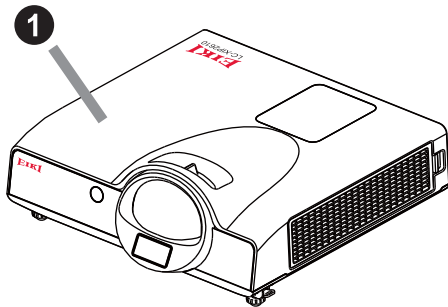

Der Abstand zwischen dem Projektor und der Leinwand beeinflusst die Größe des projizierten Bildes. Sehen Sie bitte in der folgenden Tabelle für die Leinwandgröße bei einem bestimmten Abstand nach.

- 1 Wenn der Projektor neben einer Wand aufgestellt wird, achten Sie bitte auf einen Mindestabstand von 20 cm (7,9 Zoll) zwischen dem Projektor und der Wand.

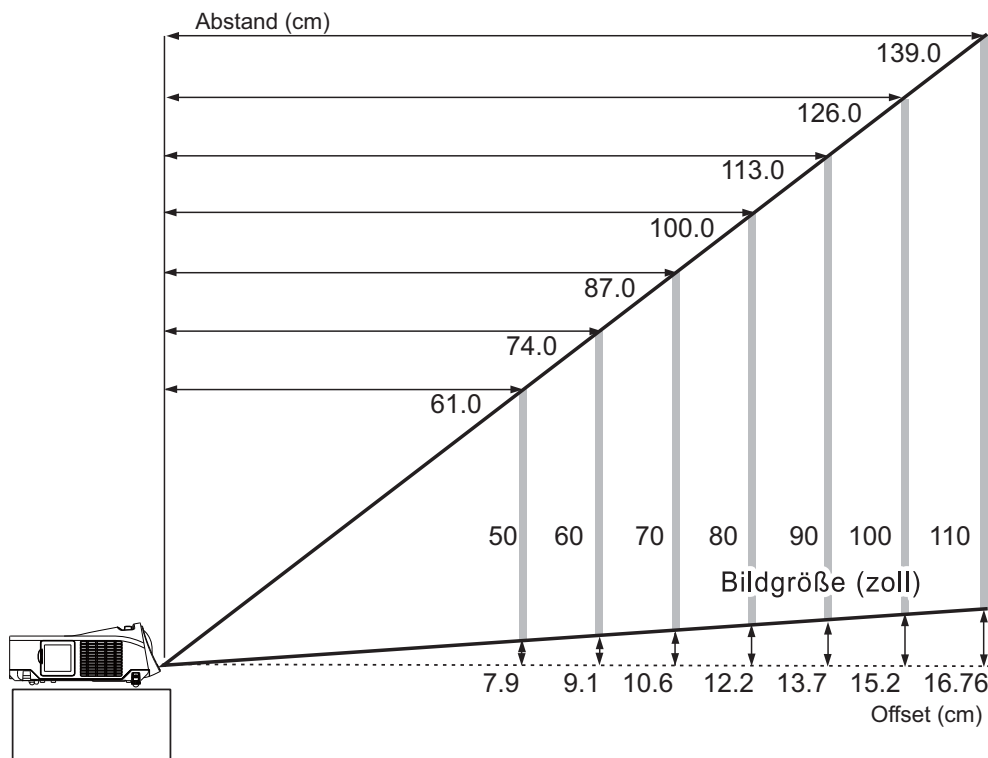

- 2 Hinweis: Die Abmessungen in der folgenden Tabelle gelten als Richtwerte.

Bildgröße (zoll)	Abstand (cm)	Offset (cm)
50	61.0	7.62
60	74.0	9.1
70	87.0	10.6
80	100.0	12.2
90	113.0	13.7
100	126.0	15.2
110	139.0	16.76

- 1 Stellen Sie sicher, dass das Netzkabel richtig mit dem Projektor verbunden ist.
- 2 Die Betriebsanzeige leuchtet grün auf.
- 3 Drücken Sie den Stromschalter an dem Bedienfeld oder auf der Fernbedienung, um den Projektor einzuschalten.
- 4 Drehen Sie den Fokusring, um den Fokus anzupassen.

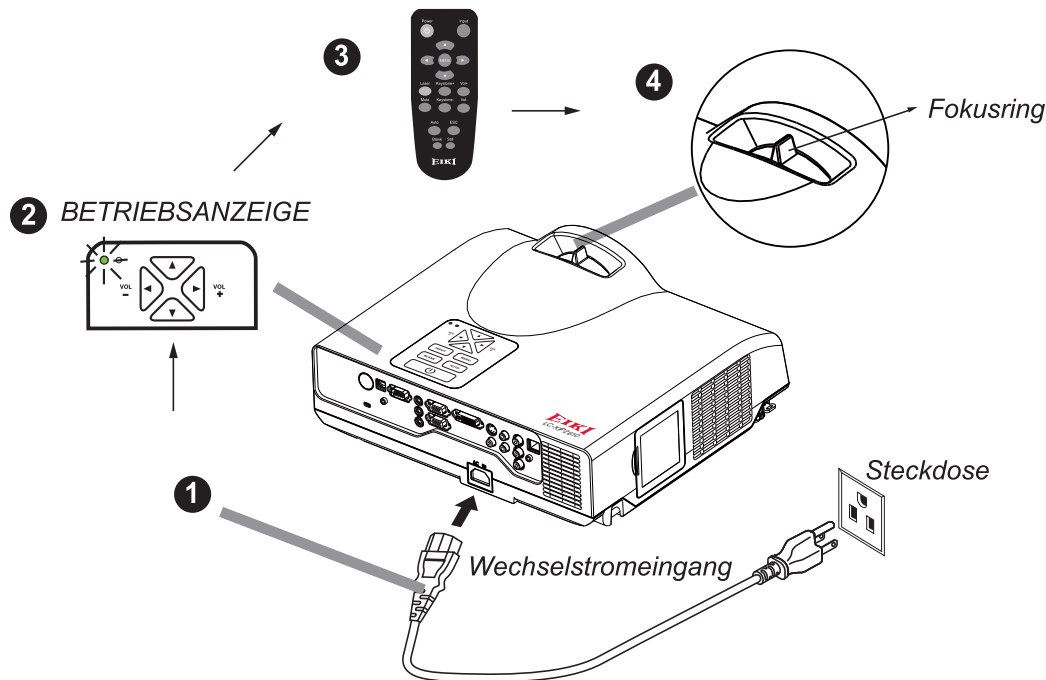

## Einstellen der Höhe des Projektionsbildes

Verwenden Sie den verstellbaren Fuß vorne an dem Projektor, um die Höhe des projizierten Bildes einzustellen.

- 1 Halten Sie den Projektor fest und drücken den Fußverstellknopf, um den vorderen verstellbaren Fuß zu entriegeln.
- 2 Stellen Sie die Frontseite des Projektors in die gewünschte Höhe.
- 3 Lassen Sie den Fußverstellknopf wieder los, damit der vordere verstellbare Fuß in dieser Position einrastet.
- 4 Nachdem Sie sichergestellt haben, dass der vordere verstellbare Fuß verriegelt ist, stellen Sie bitte vorsichtig den Projektor darauf.

### ⚠ VORSICHT

1. Durch den vorderen verstellbaren Fuß kann ein Winkel von 0 bis zu 7 Grad erzielt werden.
2. Durch die Verstellung des Fußes kann die Form des projizierten Bildes verzerrt werden. Verwenden Sie die Trapezkorrekturfunktion, um diese Verzerrung zu korrigieren.

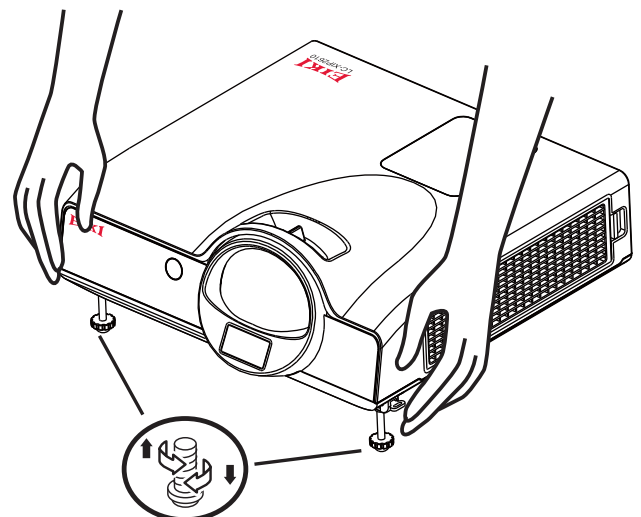

## Einlegen der Batterien in die Fernbedienung

- 1 Entfernen Sie die Abdeckung des Batteriefachs.
- 2 Legen Sie die Batterien ein. Achten Sie dabei auf die richtige Polung.
- 3 Bringen Sie die Abdeckung des Batteriefachs wieder an.

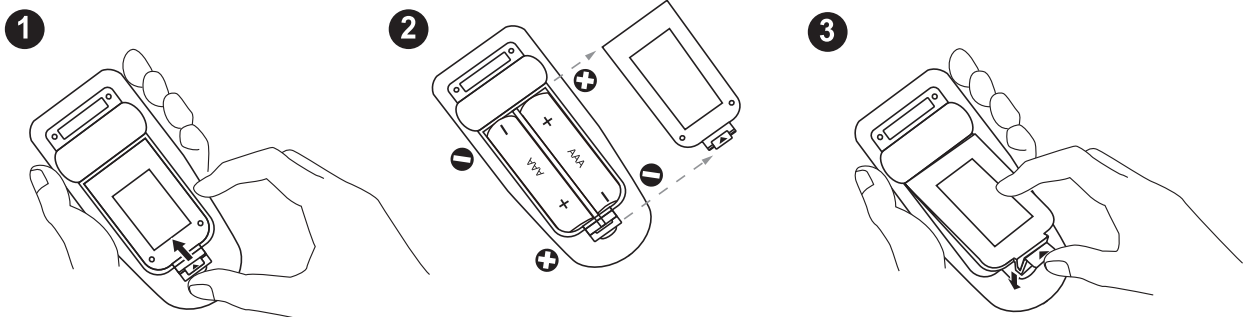

## Vornehmen der Verbindungen

Anschluss (analog oder digital) an einen Computer

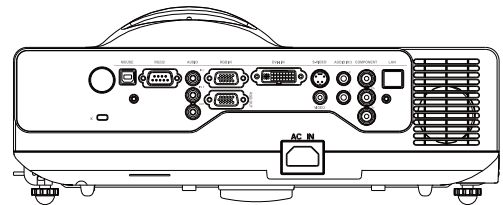

Computer		Projektor
<b>1</b>  USB Anschluss	interaktive Steuerung  USB Kabel	 USB Anschluss
<b>2</b>  RS-232C Anschluss	 RS-232C Kabel	 RS-232C Anschluss
<b>3</b>  Audio out	 3.5 mm Audio Kabel	 AUDIO IN 1
 Monitor out	 RGB Kabel	 RGB IN
<b>4</b>  DVI Anschluss	 DVI Kabel	 DVI Anschluss
 Audio out	 3.5 mm Audio Kabel	 AUDIO IN 2
<b>5</b>  Network Anschluss	 LAN Kabel	 LAN

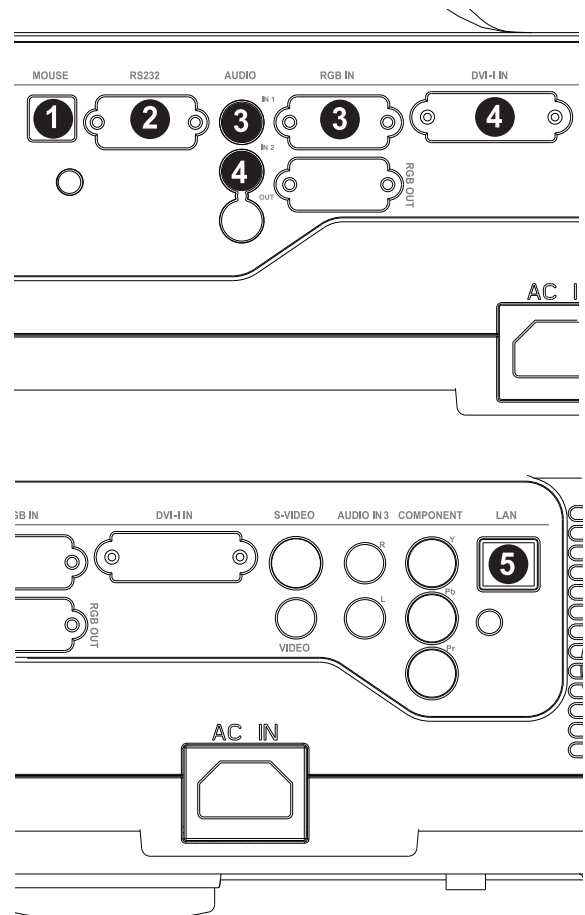



## Monitor anschließen

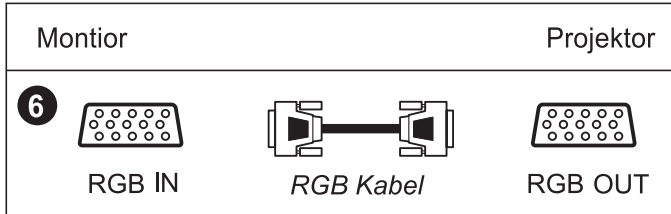
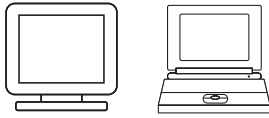

## Anschluss von AUDIO-Verstärkeranlage (Stereo)

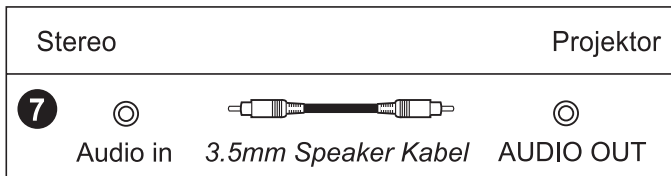

## Anschluss eines DVD/VCD Spielers

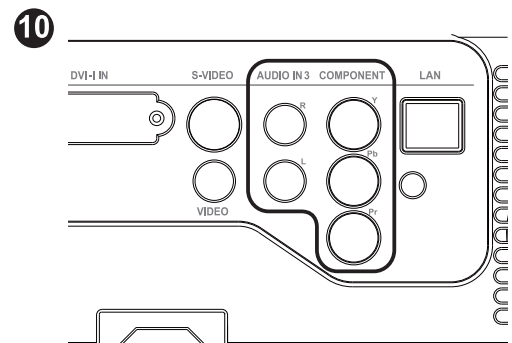
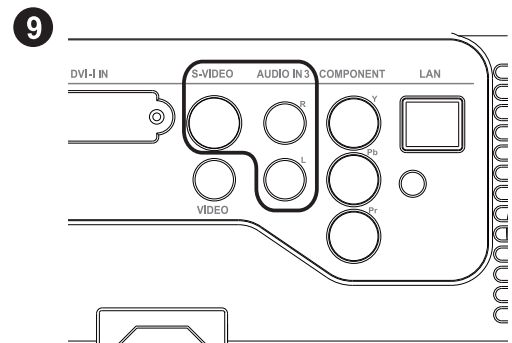
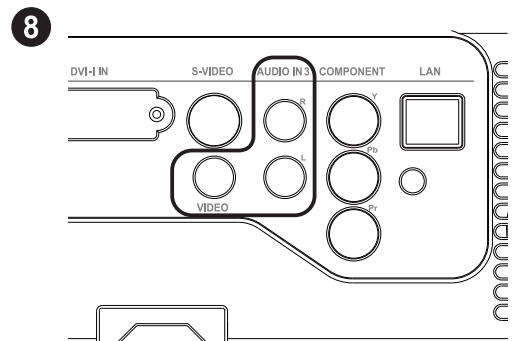
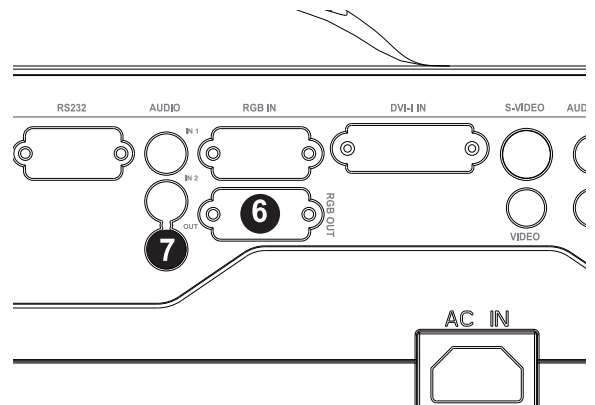
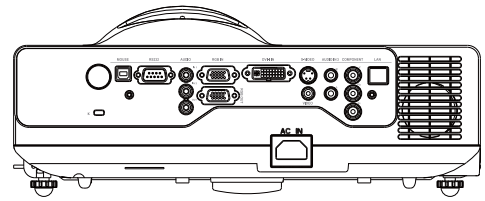
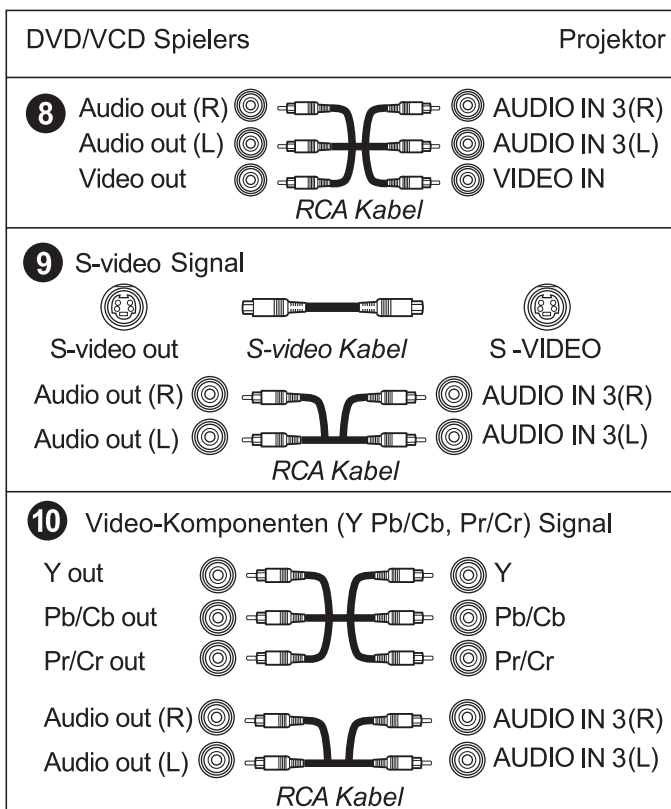
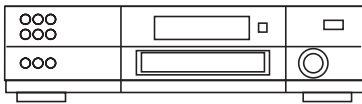

- 1 Drücken Sie den Stromschalter an dem Bedienfeld oder auf der Fernbedienung. Die Bestätigungsaufforderung "Ausschalten" erscheint.
- 2 Drücken Sie noch einmal den Stromschalter, wenn diese Frage erscheint.
- 3 Die Betriebsanzeige leuchtet grün, wenn der Projektor in den "Standby"-Modus wechselt.
- 4 Entfernen Sie bitte das Netzkabel, wenn der Projektor nicht mehr verwendet wird.

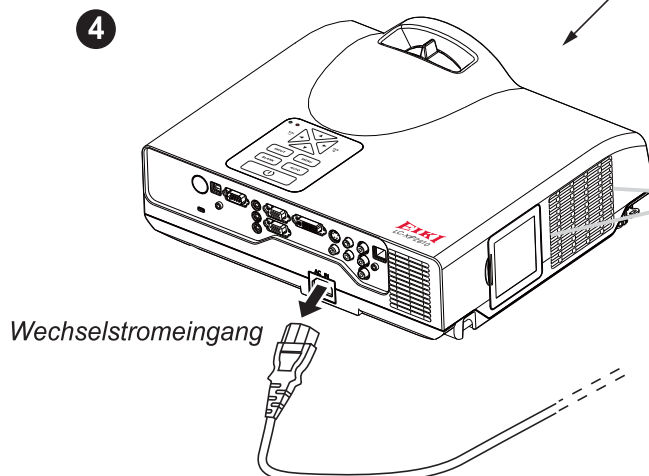
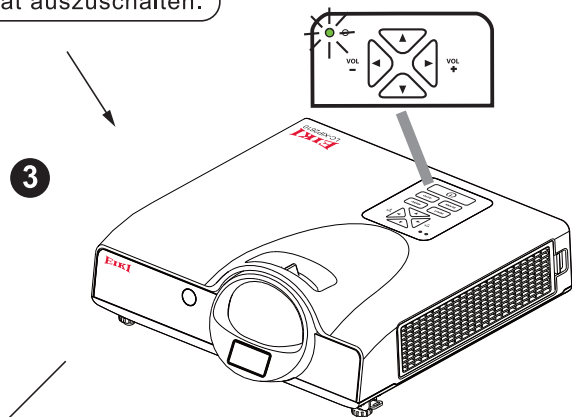
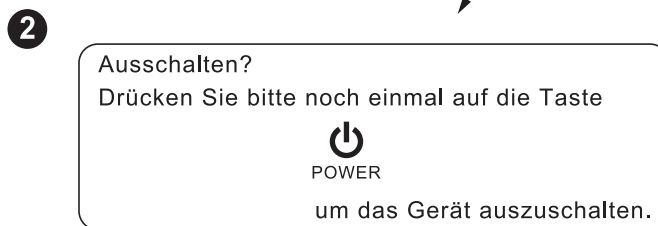
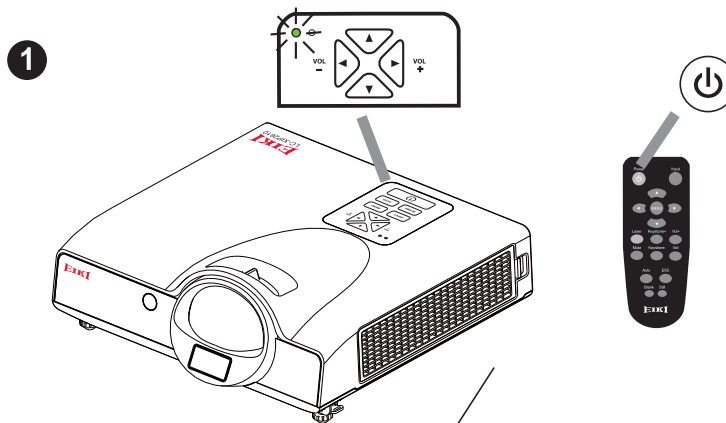

**⚠ WARNING**

Berühren Sie während des Betriebs oder kurz nach dem Betrieb weder die Lampenabdeckung noch die Entlüftungsöffnungen, weil sie sehr heiß sein können.



# EIKI

Projecteur Interactif

## Guide De Mise En Route

le modèle **LC-XIP2610**

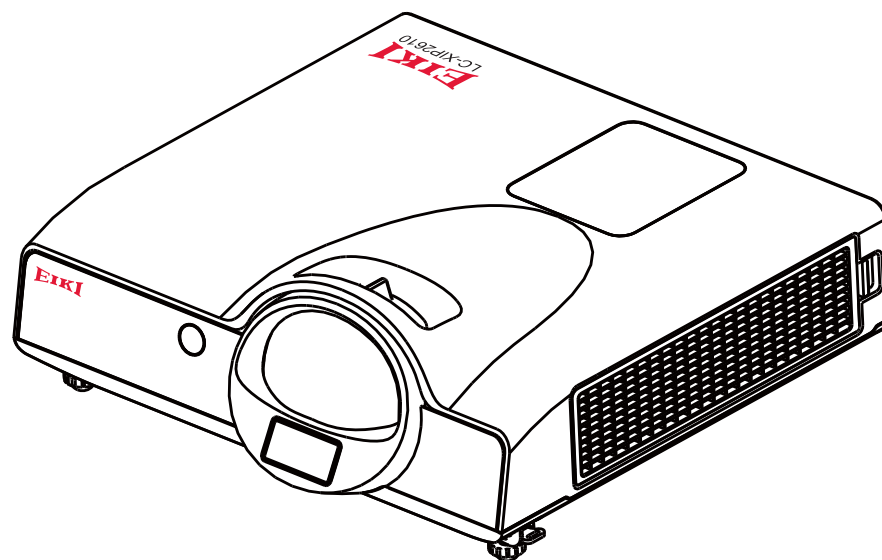

FRANÇAIS

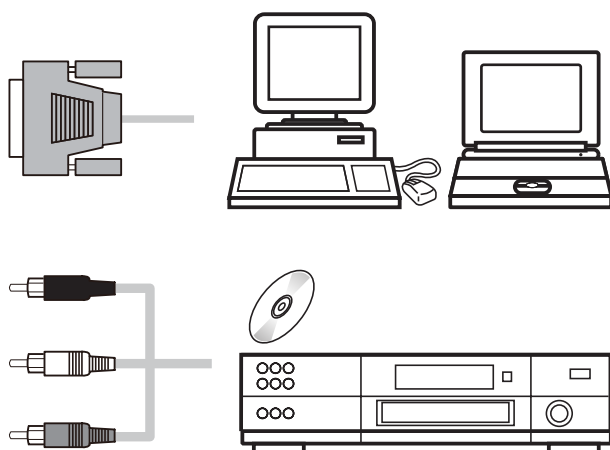

Employez ce livre comme un guide de début en installant le projecteur. Pour les informations détaillées au sujet de l'installation, l'installation et le fonctionnement du projecteur, se rapportent au manuel du propriétaire sur la CD-ROM. Lisez les instructions de sûreté de ce guide de début rapide avant d'utiliser le projecteur.

## Contenu de l'emballage

*Veillez vous assurer que les articles suivants qui accompagnent le projecteur, se trouvent bien dans l'emballage. Si un article venait à manquer, contactez votre fournisseur.*

- |  |                              |                                     |
|--|------------------------------|-------------------------------------|
| 1 Projecteur                           | 5 Câble USB                  | 9 Stylo (comprennent les piles)     |
| 2 Télécommande (comprennent les piles) | 6 CD du manuel d'utilisation | 10 Pointeur (comprennent les piles) |
| 3 Cordon d'alimentation                | 7 Guide de mise en route     | 11 Sangle                           |
| 4 Câble d'ordinateur                   | 8 Pochette d'accessoire      |                                     |

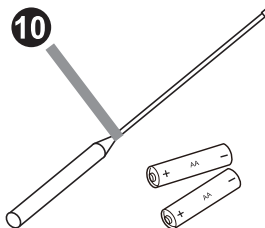
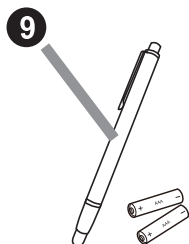
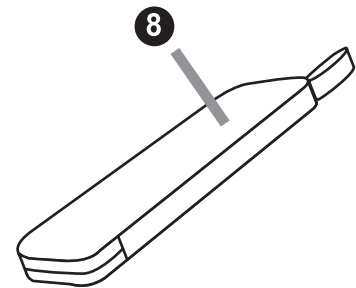
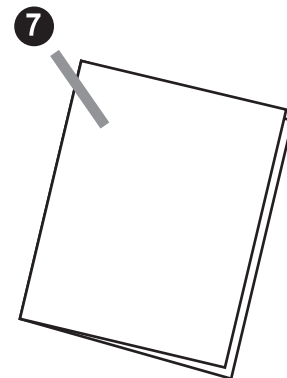
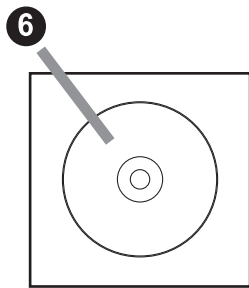
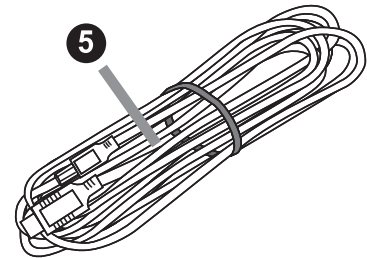
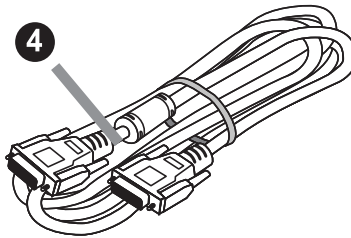
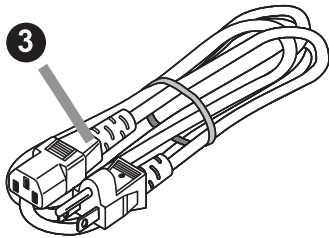
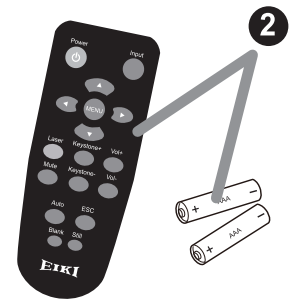
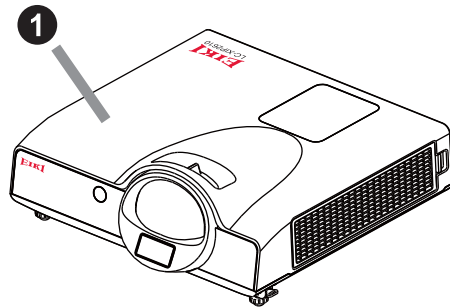

La distance entre le projecteur et l'écran détermine la taille réelle de l'image. Reportez-vous au tableau ci-dessous pour déterminer la taille de l'écran en fonction de la distance.

- 1 Lorsque le projecteur est placé à proximité d'un mur, laissez un espace d'environ 20 cm (7,9 po.) entre le projecteur et le mur.

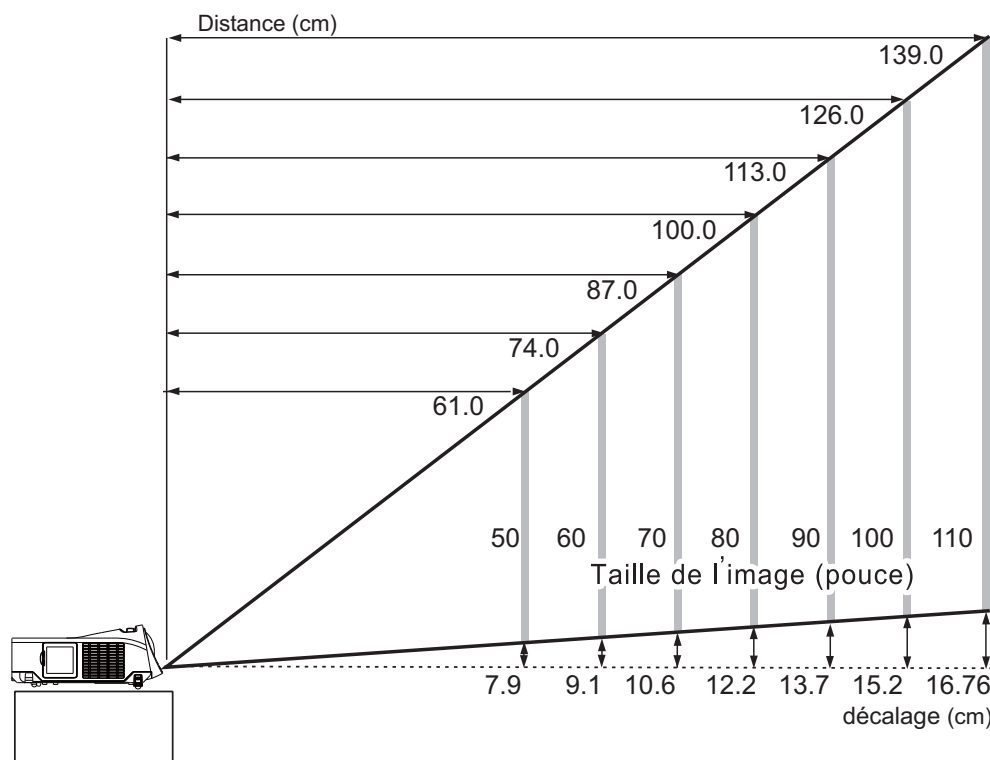

- 2 Remarque: Les dimensions du tableaux suivants sont des approximations

Taille de l'image (pouce)	Distance (cm)	décalage (cm)
50	61.0	7.62
60	74.0	9.1
70	87.0	10.6
80	100.0	12.2
90	113.0	13.7
100	126.0	15.2
110	139.0	16.76

- ❶ Assurez-vous de la bonne connexion du cordon d'alimentation au projecteur. r.
- ❷ Le voyant d'alimentation s'allume en vert.
- ❸ Appuyez sur le bouton MARCHÉ/ARRÊT du panneau de commande ou de la télécommande pour mettre le projecteur sous tension.
- ❹ Tournez la bague de mise au point pour effectuer la mise au point.

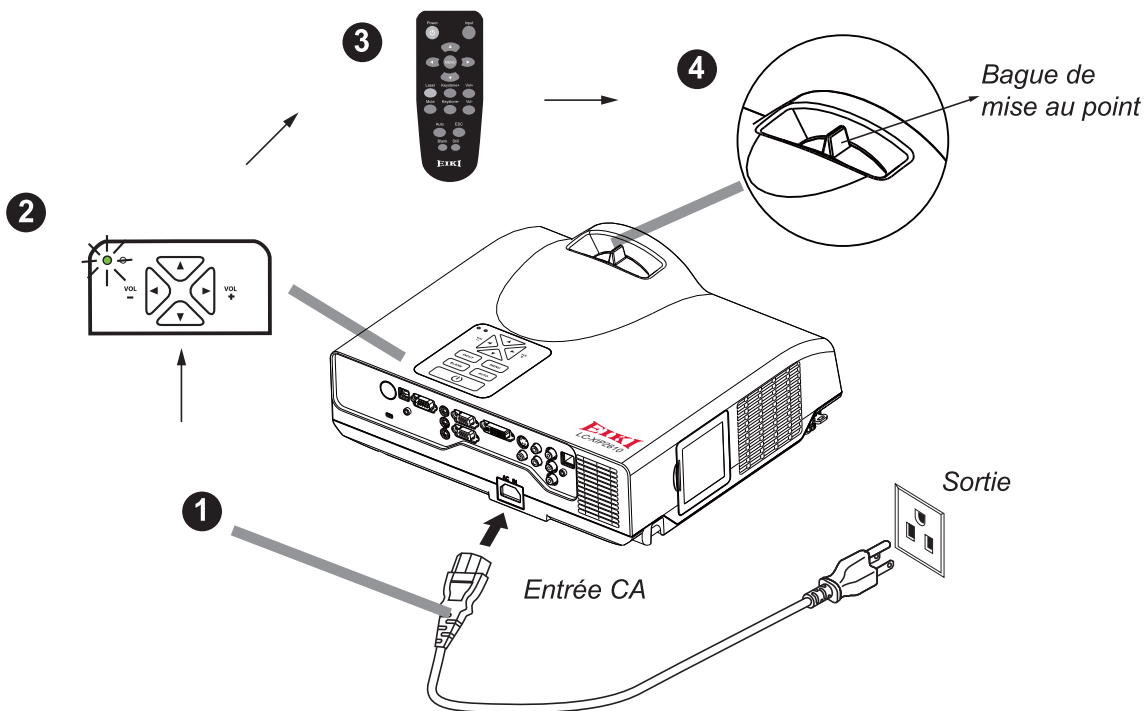

## Réglage de la hauteur du projecteur

Utilisez le pied réglable à l'avant du projecteur pour ajuster la hauteur de l'image.

- ❶ En maintenant le projecteur, poussez les boutons de réglage du pied pour défaire le pied réglable.
- ❷ Positionnez la partie avant du projecteur à la hauteur désirée.
- ❸ Relâchez les boutons de réglage de façon à verrouiller les pieds réglables avant en place.
- ❹ Une fois avoir vérifié le verrouillage des pieds réglables avant, reposez doucement le projecteur.

### ⚠ ATTENTION

1. Le réglage du pied avant peut être effectué de 0 à 7 degrés.
2. Une fois le pied réglé, il se peut que l'image projetée soit déformée. Utilisez la fonction de correction de la distorsion pour corriger la déformation.

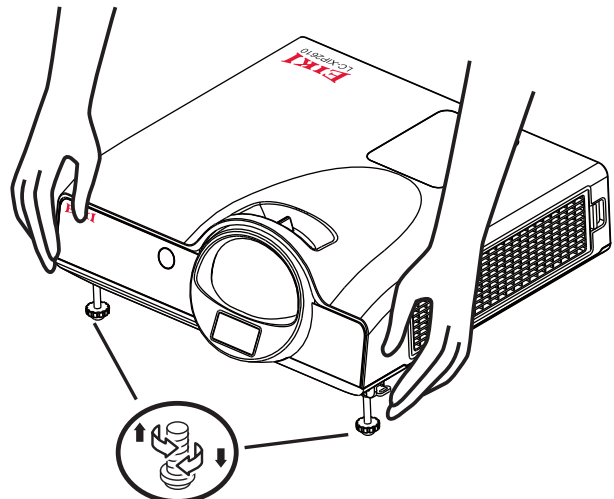

## Installation des piles dans la télécommande

- 1 Retirez le couvercle.
- 2 Mettez en place les piles. Assurez-vous de respecter leur polarité lors de leur mise en place.
- 3 Retirez le couvercle.

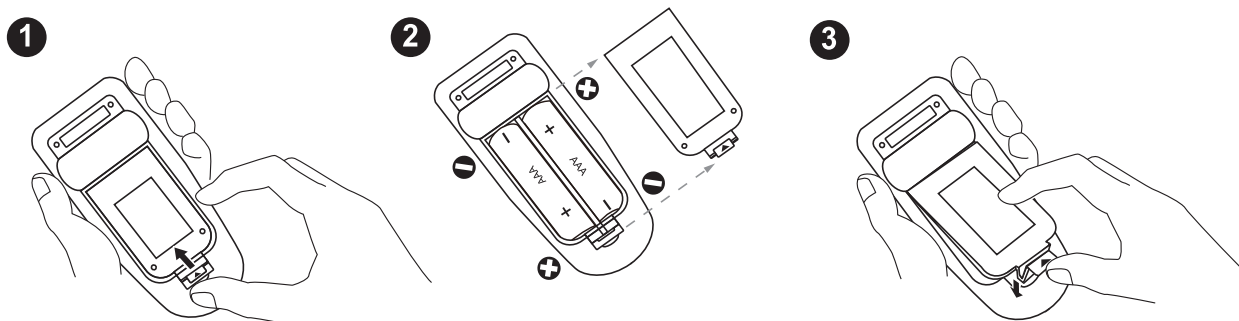

## Comment effectuer les branchements

### Se relier à un ordinateur

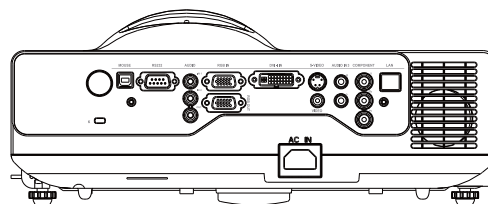

ordinateur		Projecteur
1  USB port	contrôle interactif USB câble	USB port
2  RS-232C port	RS-232C câble	RS-232C port
3  Audio out	3.5mm Audio câble	AUDIO IN 1
Monitor OUT	RGB câble	RGB IN
4  DVI port out	DVI câble	DVI port IN
Audio out	3.5mm Audio câble	AUDIO IN 2
5  Network port	LAN câble	LAN

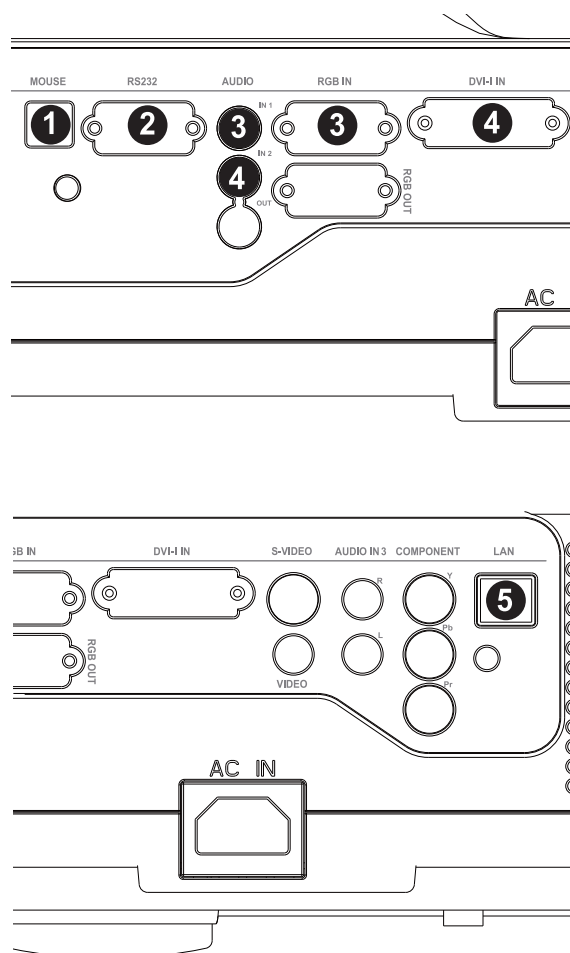



# Comment effectuer les branchements

## Se relier à un moniteur

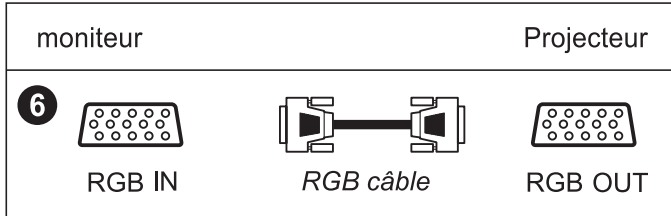
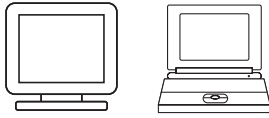

## Se relier à un haut-parleur

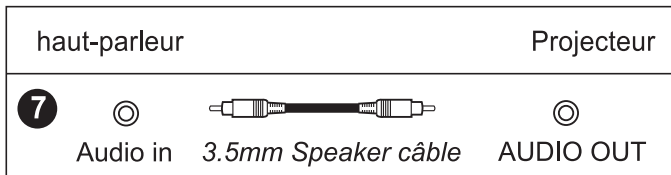

## Se relier à un joueur de VCD/DVD

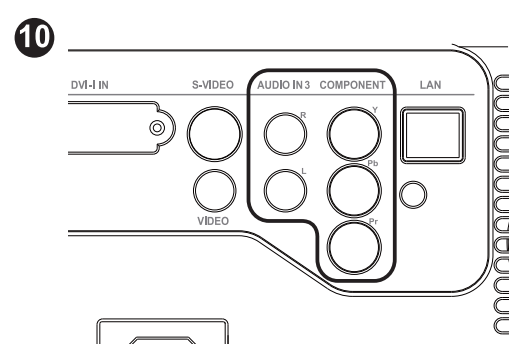
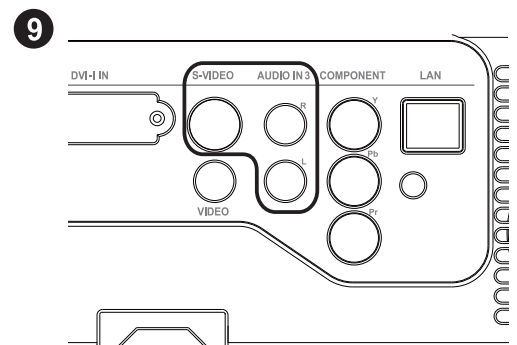
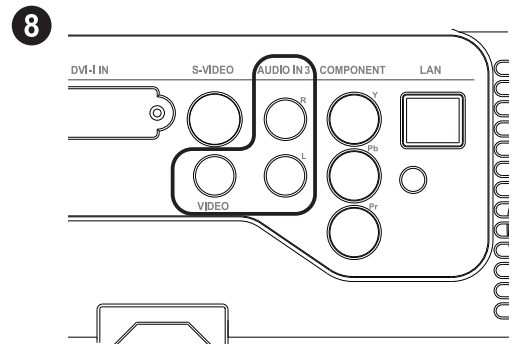
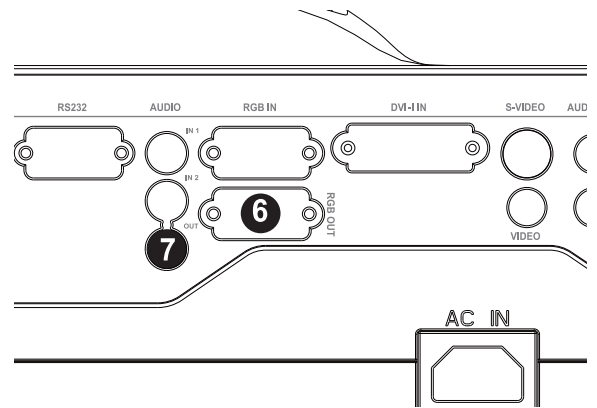
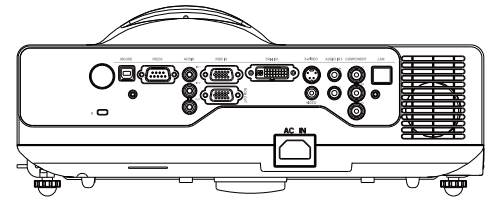
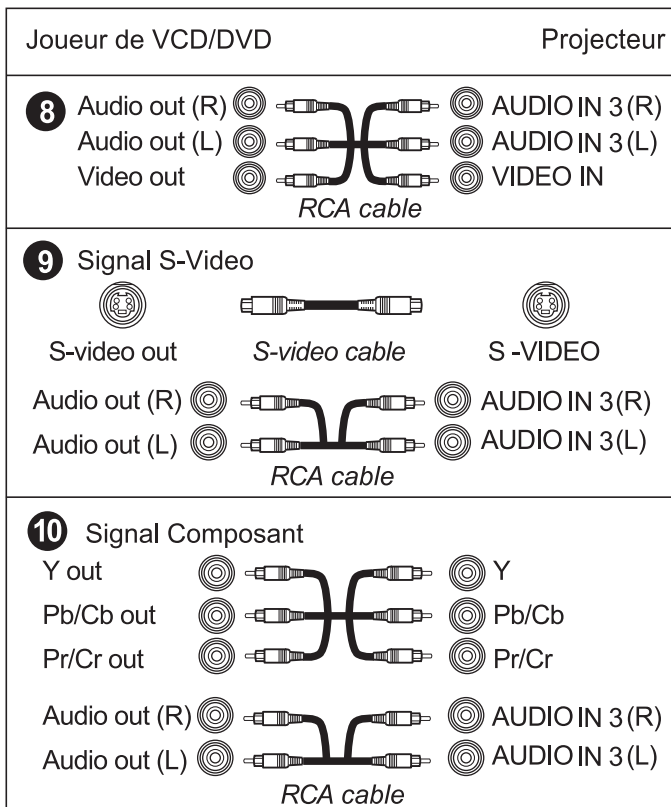
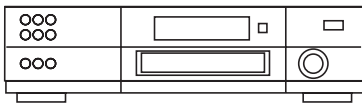

## Mettre l'appareil hors tension

- 1 Appuyez sur le bouton MARCHÉ/ARRÊT du panneau de commande ou de la télécommande. Le message de confirmation "mise hors tension" apparaît.
- 2 Appuyez à nouveau sur le bouton MARCHÉ/ARRÊT lorsque le message est à l'écran.
- 3 Lorsque le projecteur entre en mode "Veille", le voyant ALIMENTATION s'allume en vert.
- 4 Si vous n'allez plus utiliser le projecteur, débranchez le cordon d'alimentation.

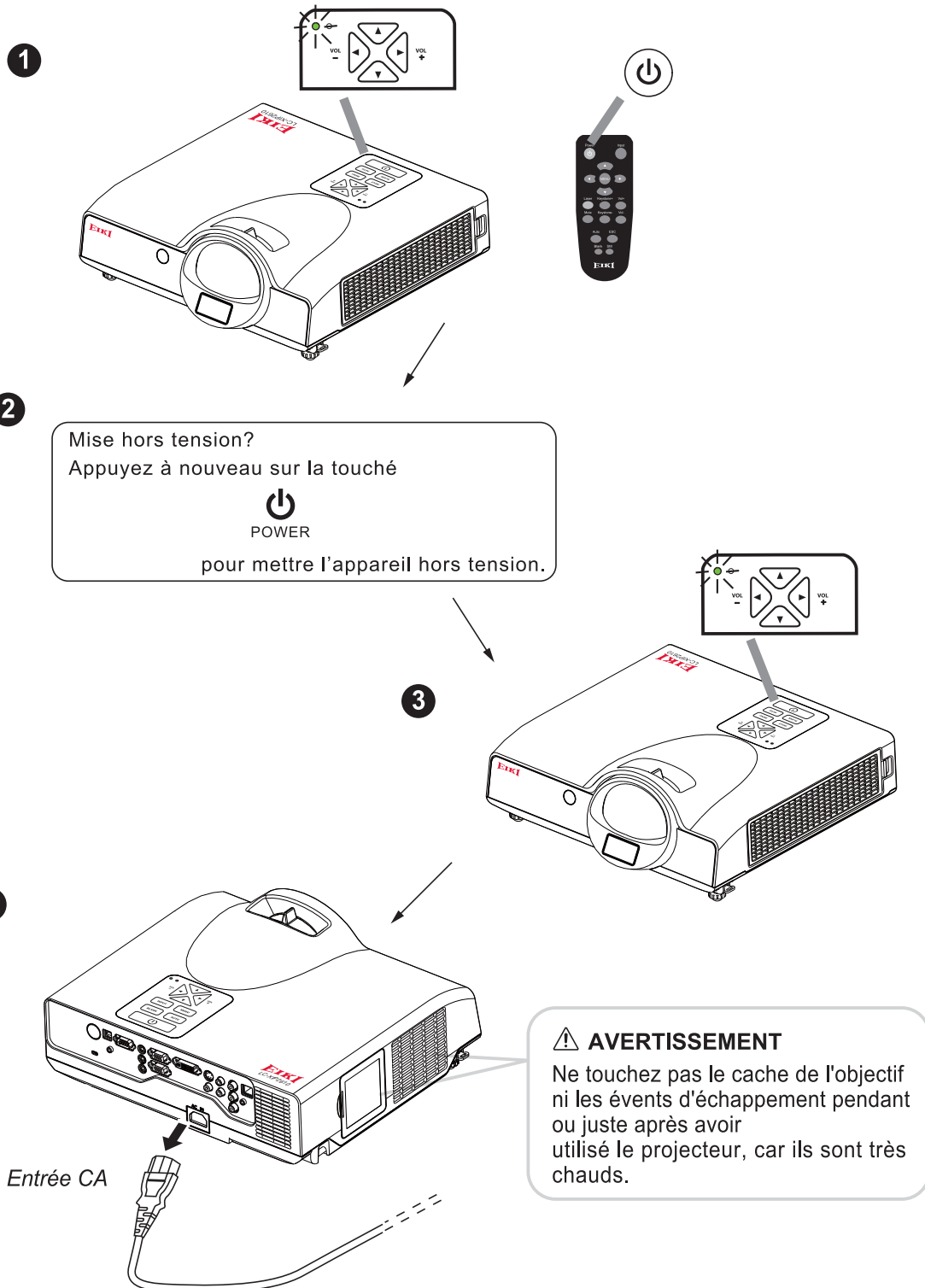



# EIKI

Proyector Interactivo

## Guía de Inicio Rápido

Modelo **LC-XIP2610**

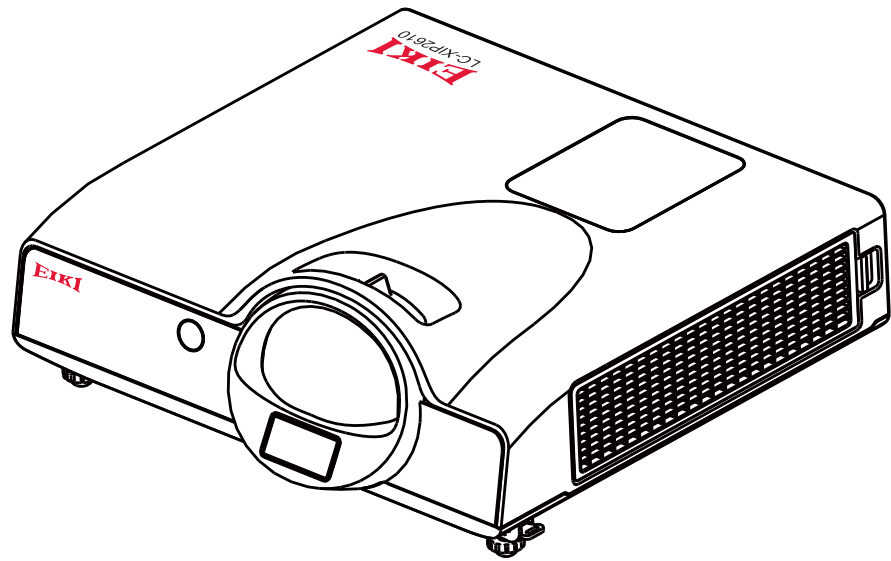

ESPAÑOL

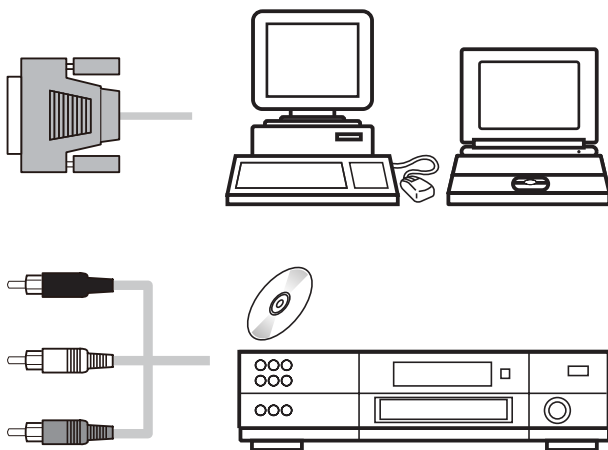

Utilice este libro como una guía del comienzo al fijar el proyector. Para la información detallada sobre la instalación, la disposición y la operación del proyector, refieren al manual del dueño en el CD-ROM. Lea las instrucciones de seguridad en esta guía del comienzo rápido antes de usar el proyector.

## Contenidos de su caja

Por favor, asegúrese de que los siguientes elementos estén incluidos en la caja, además de los principales. Si faltase alguno de los elementos, póngase en contacto con su vendedor.

- |   |  |   |                               |    |  |
|---|--|---|-------------------------------|----|--|
| 1 | Proyector                              | 5 | Cable USB                     | 8  | Bolsa de Accesorios (incluyen las pilas) |
| 2 | Mando a Distancia (incluyen las pilas) | 6 | OCD de Manual del Propietario | 9  | Lápiz Óptico (incluyen las pilas)        |
| 3 | Cable de alimentación                  | 7 | Guía de Inicio Rápido         | 10 | Puntero                                  |
| 4 | Cable del Ordenador                    |   |                               | 11 | Correa                                   |

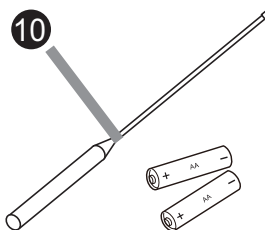
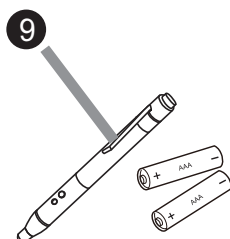
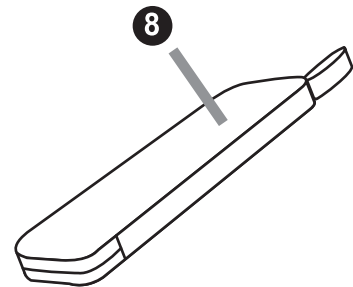
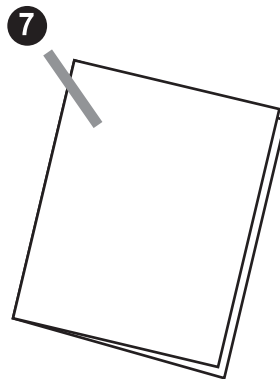
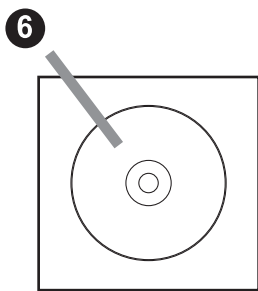
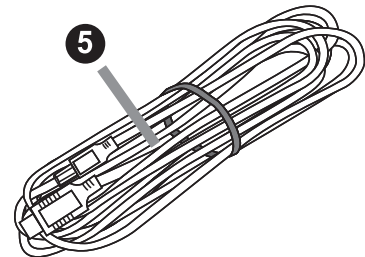
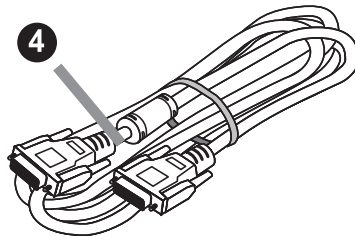
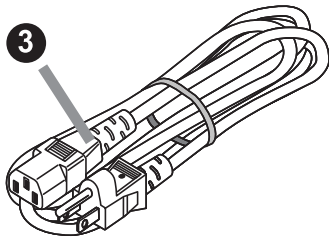
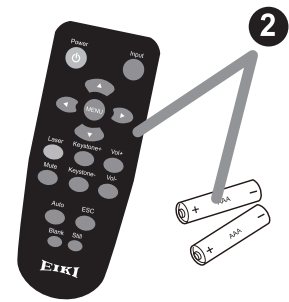
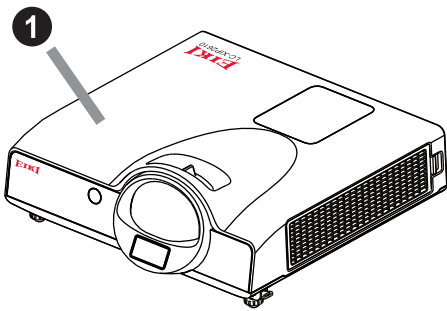

La distancia entre el proyector y la pantalla determina el tamaño real de la imagen. Consulte con la siguiente tabla para determinar el tamaño de la pantalla a una distancia determinada.

- 1 Cuando esté contra una pared, deje unos 20cm(7,9 pulgadas) entre el proyector y la pared.

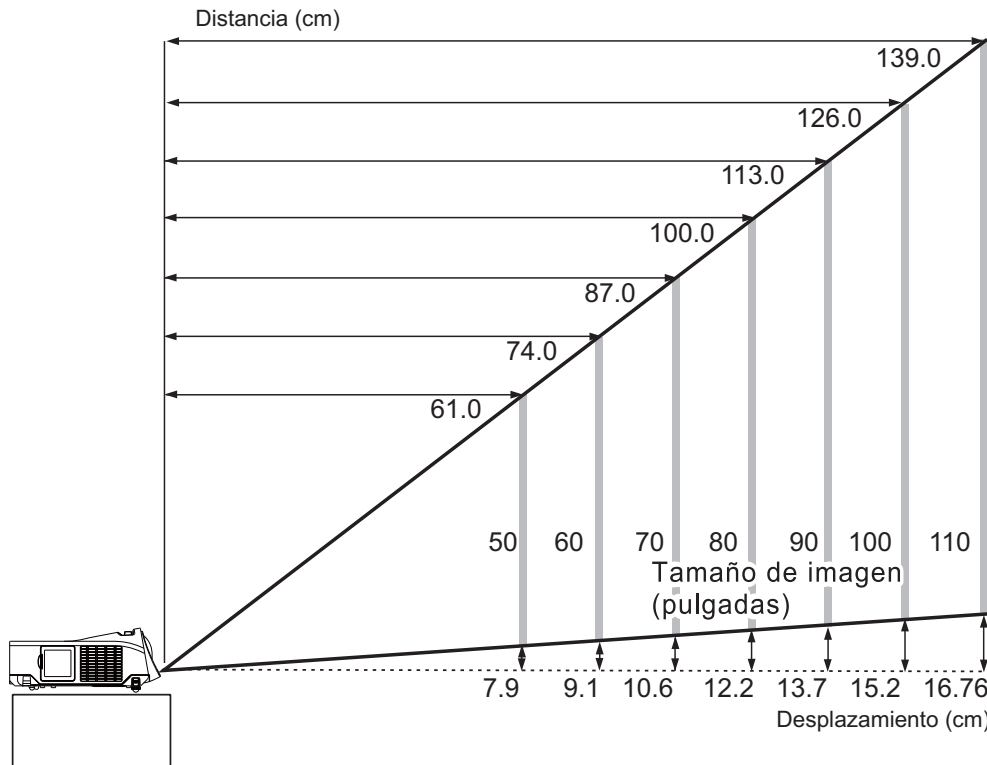

- 2 Nota: Las dimensiones de la siguiente tabla son aproximadas.

Tamaño de imagen (pulgadas)	Distancia (cm)	Desplazamiento (cm)
50	61.0	7.62
60	74.0	9.1
70	87.0	10.6
80	100.0	12.2
90	113.0	13.7
100	126.0	15.2
110	139.0	16.76

- 1 Asegúrese de que el cable de alimentación esté firmemente conectado al proyector.
- 2 El indicador de ENCENDIDO se iluminará en verde.
- 3 Pulse el botón ENCENDIDO del panel de control o del mando a distancia para encender el proyector.
- 4 Gire el anillo de enfoque para ajustar el enfoque.

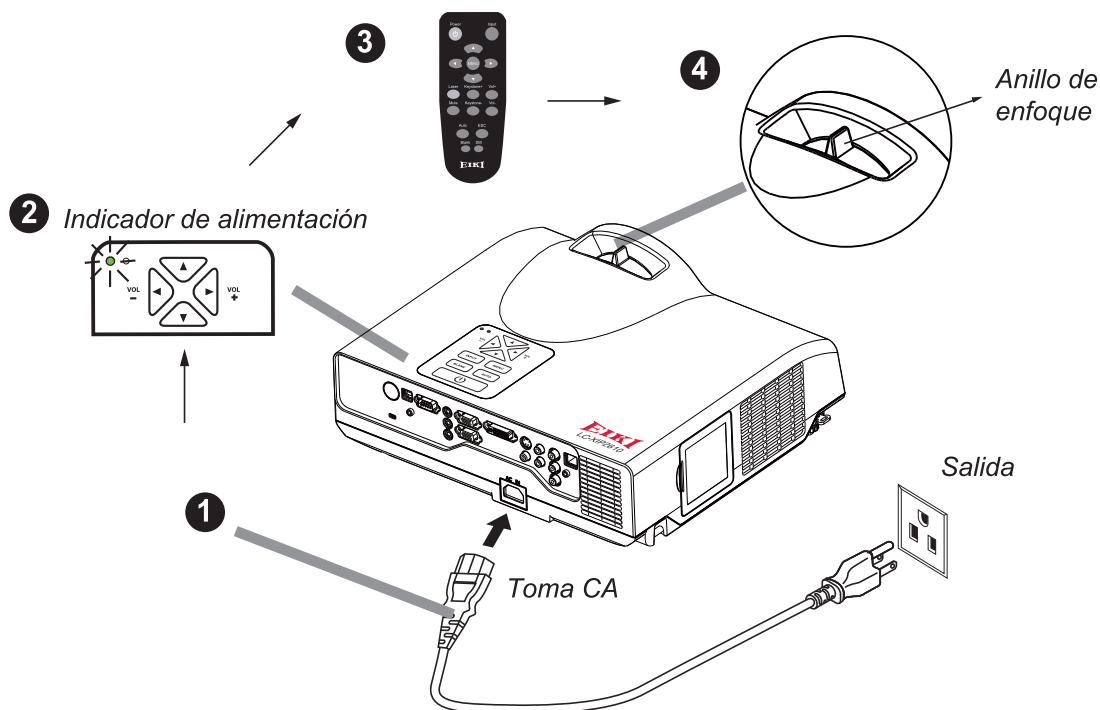

## Ajustar La Elevación del Proyector

Use el pié ajustable de la parte frontal del proyector para ajustar la altura de la imagen.

- 1 Sujetando el proyector, apriete los botones de ajuste del pié para aflojar el pié ajustable frontal.
- 2 Ponga la parte frontal del proyector a la altura deseada.
- 3 Suelte los botones de ajuste del pié para bloquear el pié ajustable frontal.
- 4 Tras asegurarse de que los pies ajustables frontales están bloqueados, ponga encima el proyector con cuidado.

### ⚠ PRECAUCIÓN

1. El rango de ajuste del pié ajustable frontal es de entre 0 y 7 grados.
2. Al ajustar el pié, puede hacer que la forma de la imagen proyectada quede distorsionada. Use la función de corrección trapezoidal para corregir esta distorsión

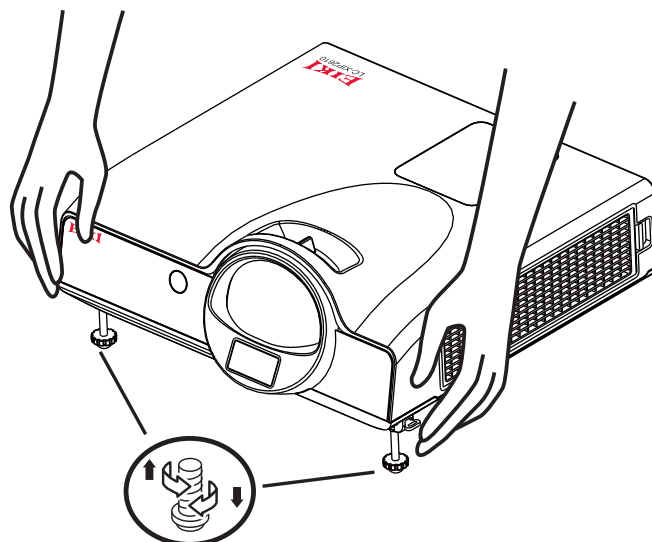

## Instalación de las Baterías del Mando A Distancia

- 1 Extraiga la tapa de la batería.
- 2 Cargue las baterías. Asegúrese de que los polos estén orientados correctamente.
- 3 Cierre la tapa de la batería.

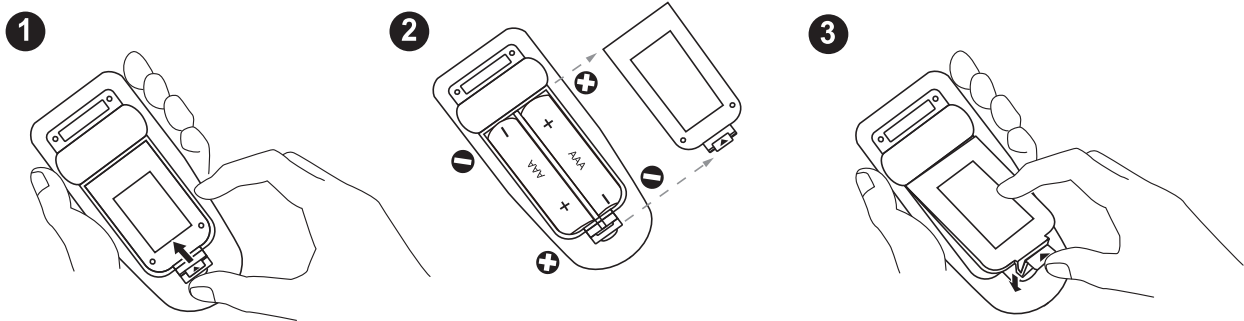

## Cómo Conectar

### Conexión con una computadora

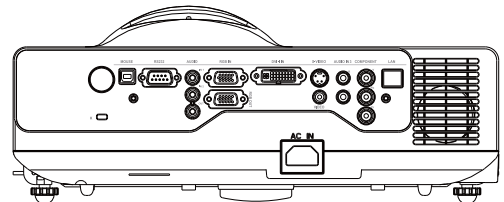

computadora		proyector
1  USB puerto	control interactivo USB cable	USB puerto
2  RS-232C puerto	RS-232C cable	RS-232C puerto
3  Audio out	3.5mm Audio cable	AUDIO IN 1
Monitor OUT	RGB cable	RGB IN
4  DVI puerto	DVI cable	DVI puerto
Audio out	3.5mm Audio cable	AUDIO IN 2
5  Network puerto	LAN cable	LAN

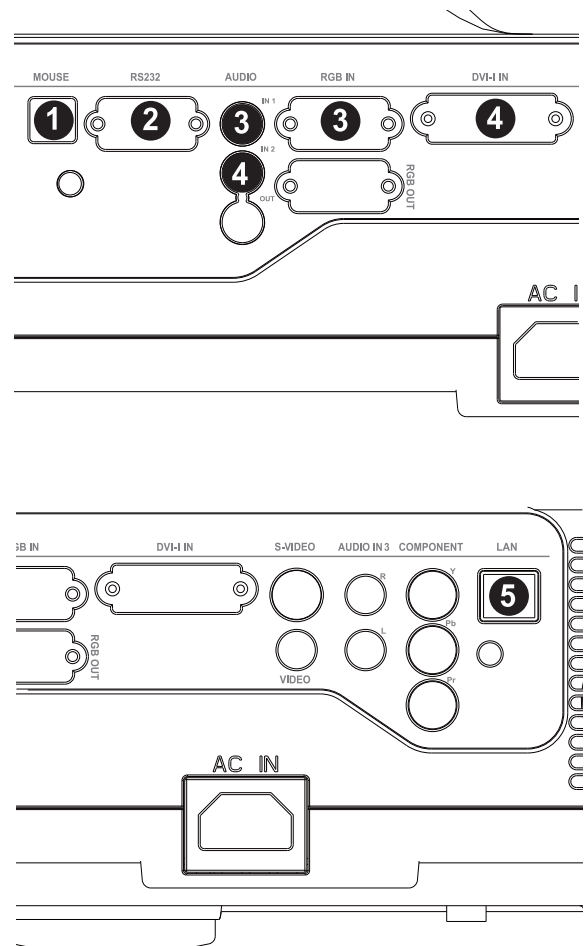



## Conexión con un monitor

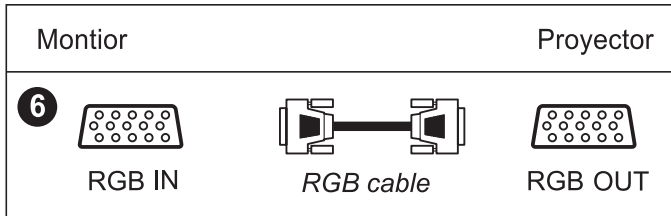
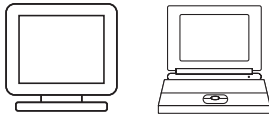

## Conexión con un altavoz

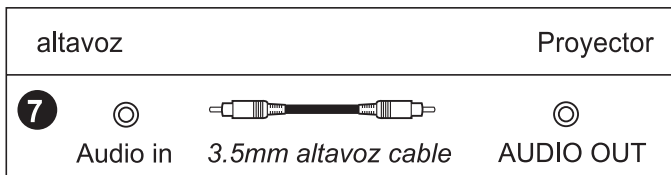

## Conexión con un jugador de VCD/DVD

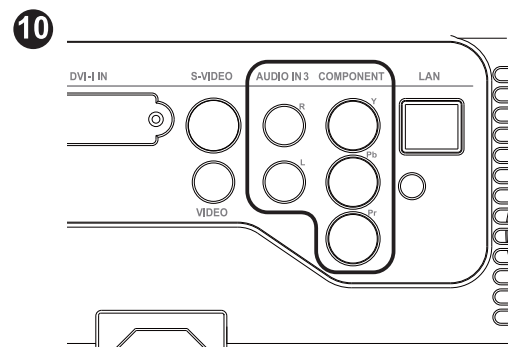
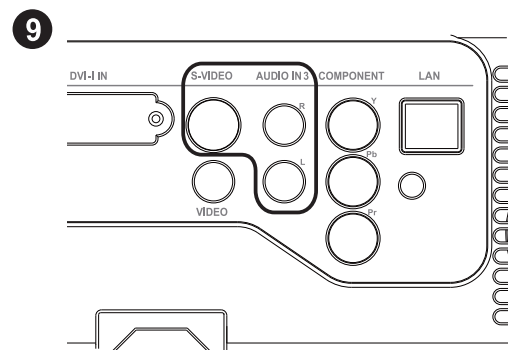
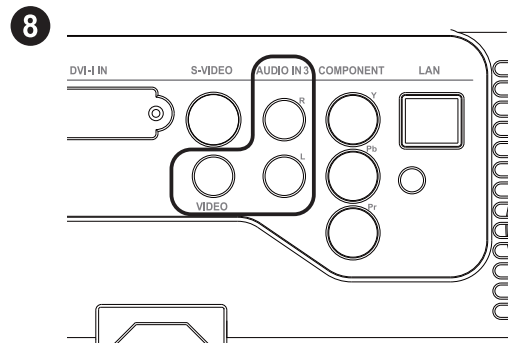
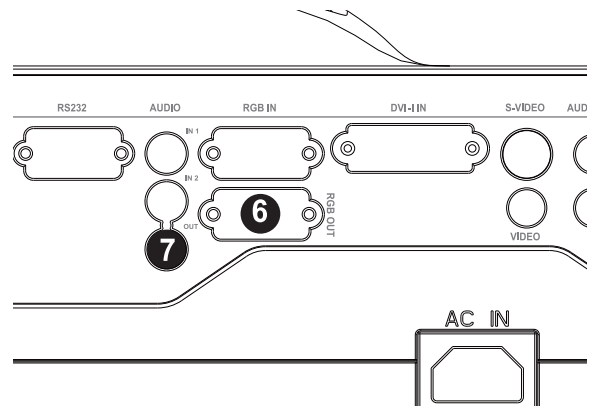
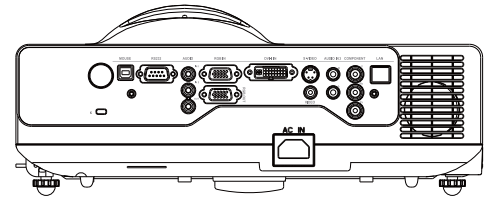
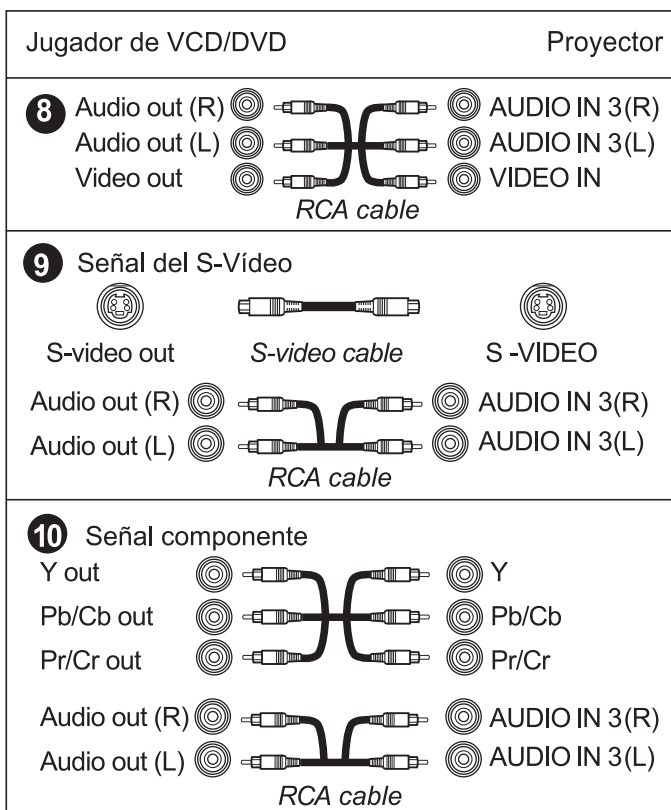
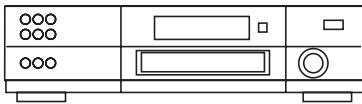

## Apagar El Proyector

- 1 Pulse el botón ENCENDIDO del panel de control o del mando a distancia. Aparecerá un mensaje de confirmación de “apagado”.
- 2 Pulse de nuevo el botón ENCENDIDO mientras aparece el mensaje.
- 3 Cuando el proyector entre en modo “Standby”, el indicador de ENCENDIDO se iluminará en verde.
- 4 Si no usa el proyector, extraiga el cable de alimentación.

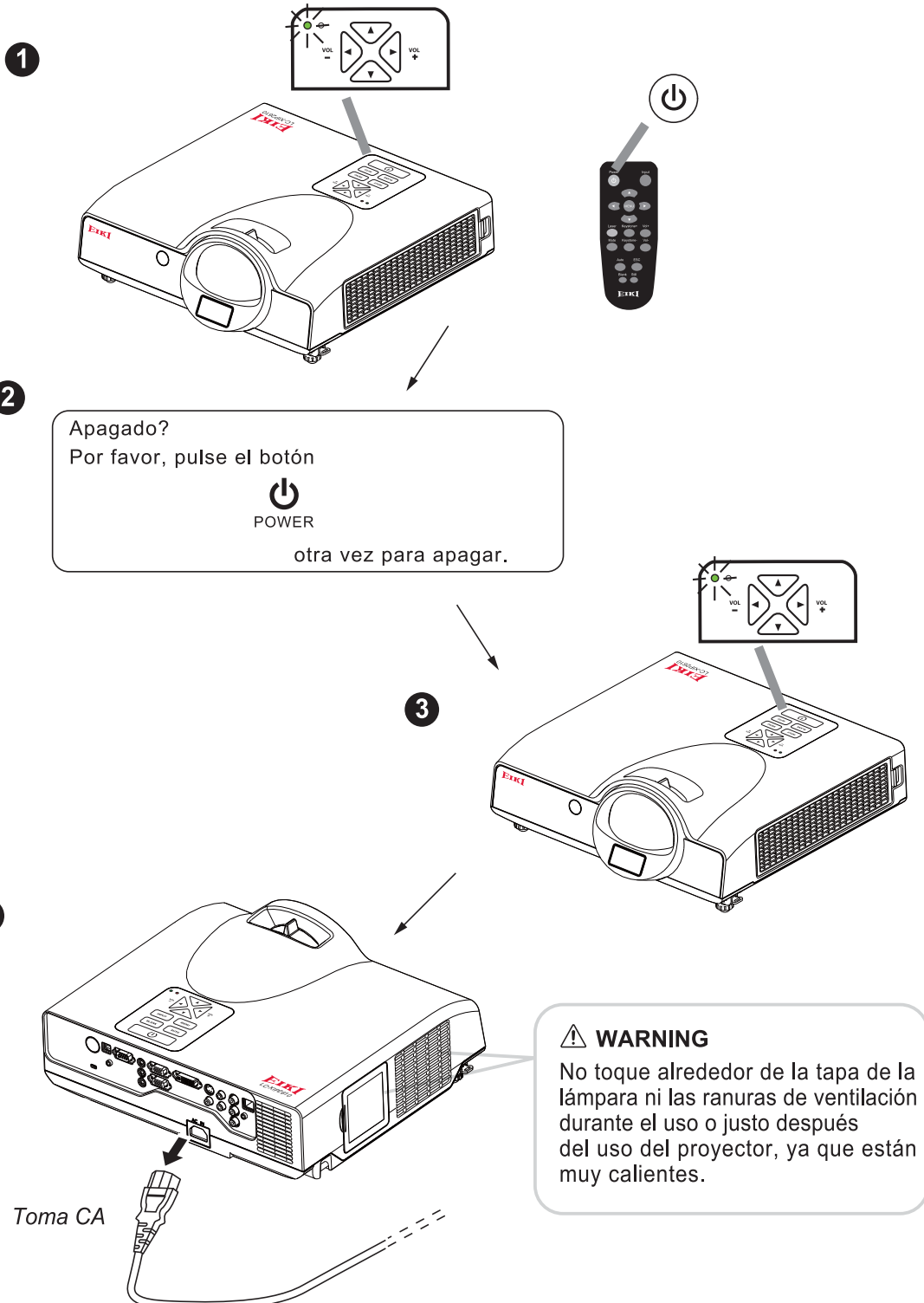



# EIKI

Proiettore Interattivo

## Guida Rapida

---

Model **LC-XIP2610**

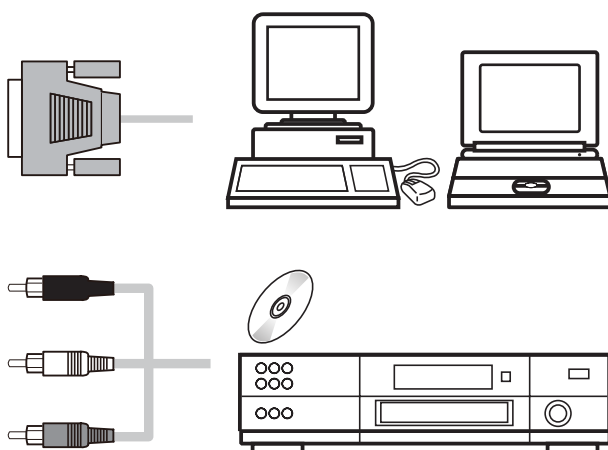
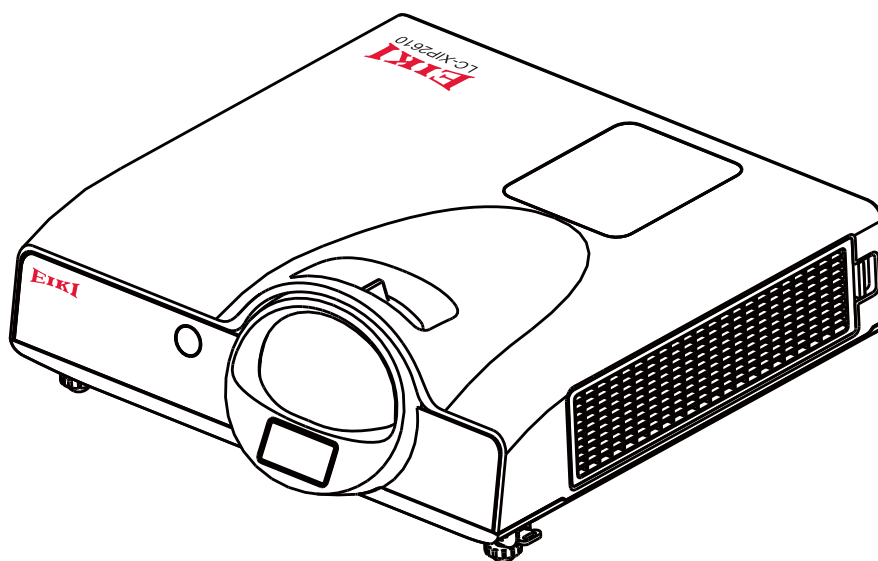

ITALIANO

---

Usi questo libro come una guida di inizio quando installano il proiettore. Per informazioni dettagliate circa installazione, la messa a punto ed il funzionamento del proiettore, si riferiscono al manuale del proprietario sul CD-ROM. Legga le istruzioni di sicurezza in questa guida di inizio rapido prima di per mezzo del proiettore.

## Contenuto della scatola

Assicurarsi che la scatola contenga i seguenti elementi, oltre a quelli principali.  
In caso di componenti mancanti, contattare il proprio rivenditore.

- |   |                                  |   |                  |    |                                   |
|---|----------------------------------|---|------------------|----|-----------------------------------|
| 1 | Proiettore                       | 5 | Cavo USB         | 9  | Penna ottica (includono batterie) |
| 2 | Telecomando (includono batterie) | 6 | CD Manuale d'uso | 10 | Puntatore (includono batterie)    |
| 3 | Cavo per collegamento elettrico  | 7 | Guida rapida     | 11 | Cinturino                         |
| 4 | Cavo computer                    | 8 | Custodia         |    |                                   |

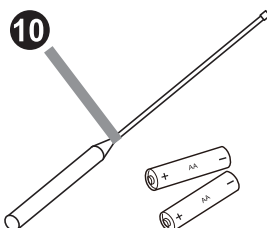
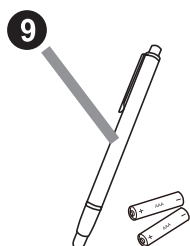
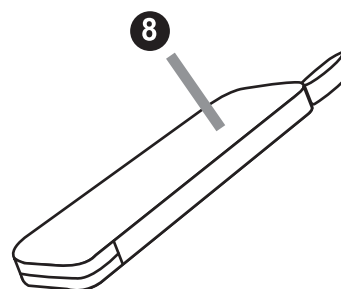
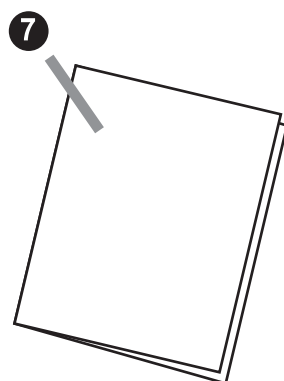
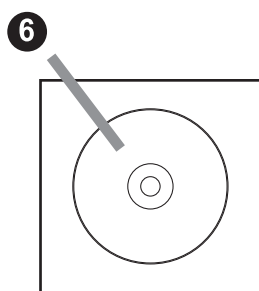
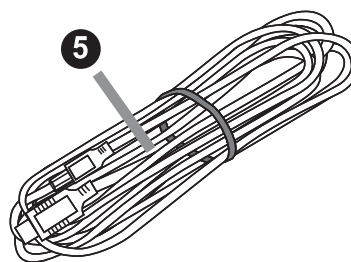
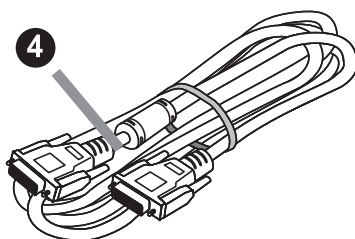
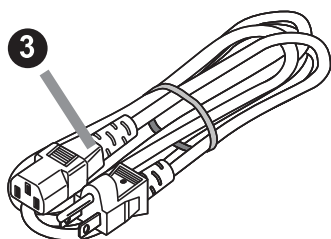
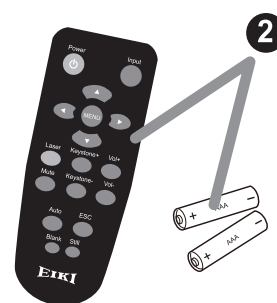
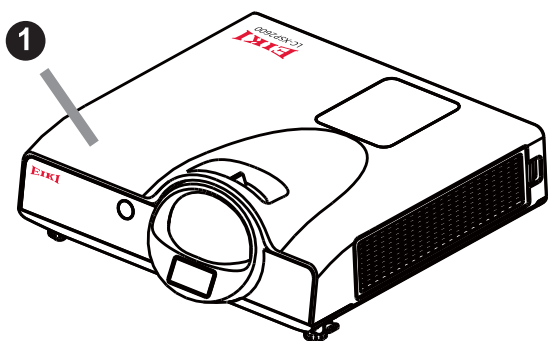

La distanza tra il proiettore e lo schermo determina la dimensione effettiva dell'immagine. Fare riferimento alla tabella riportata di seguito per determinare la dimensione dello schermo ad una data distanza.

- 1 Quando è posizionato contro una parete, lasciare uno spazio di 20cm circa (7,9in.) tra il proiettore e la parete stessa.

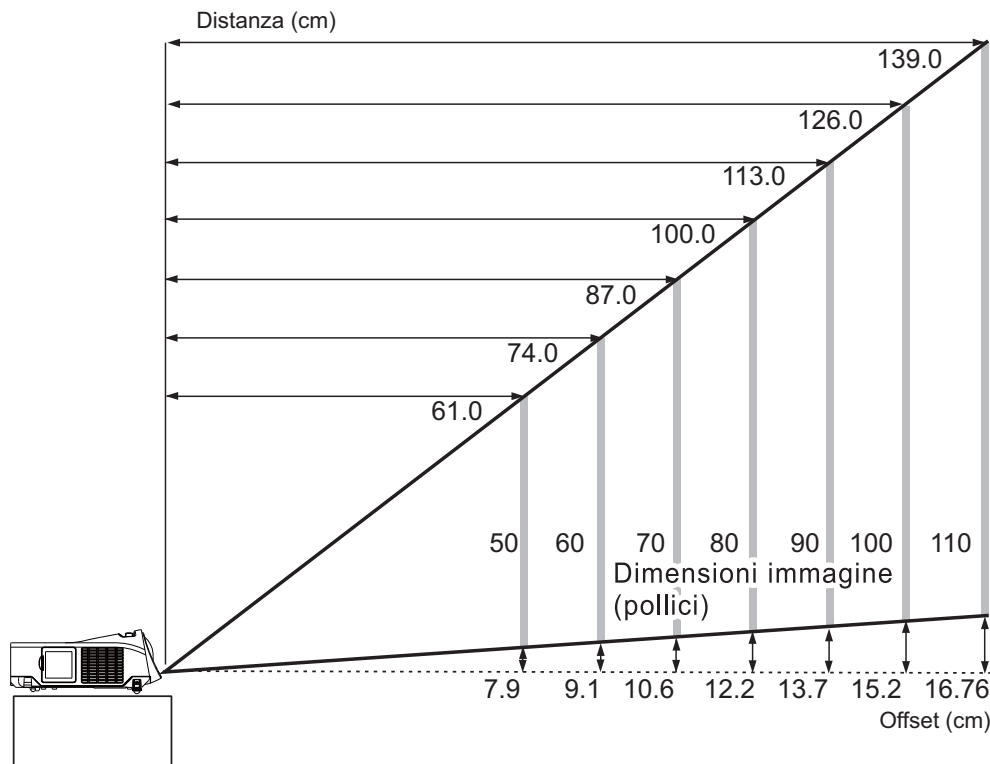

- 2 Nota: Le dimensioni nella tabella seguente sono approssimative.

Dimensione dello schermo (diagonale)	Distanza (cm)	Offset (cm)
50	61.0	7.62
60	74.0	9.1
70	87.0	10.6
80	100.0	12.2
90	113.0	13.7
100	126.0	15.2
110	139.0	16.76

- 1 Assicurarsi che il cavo elettrico sia collegato fermamente e correttamente al proiettore.
- 2 L'indicatore di ATTIVAZIONE emetterà una luce verde.
- 3 Premere il pulsante di ATTIVAZIONE sul pannello di controllo o sul telecomando per accendere il proiettore.
- 4 Ruotare l'anello di messa a fuoco per regolare la messa a fuoco.

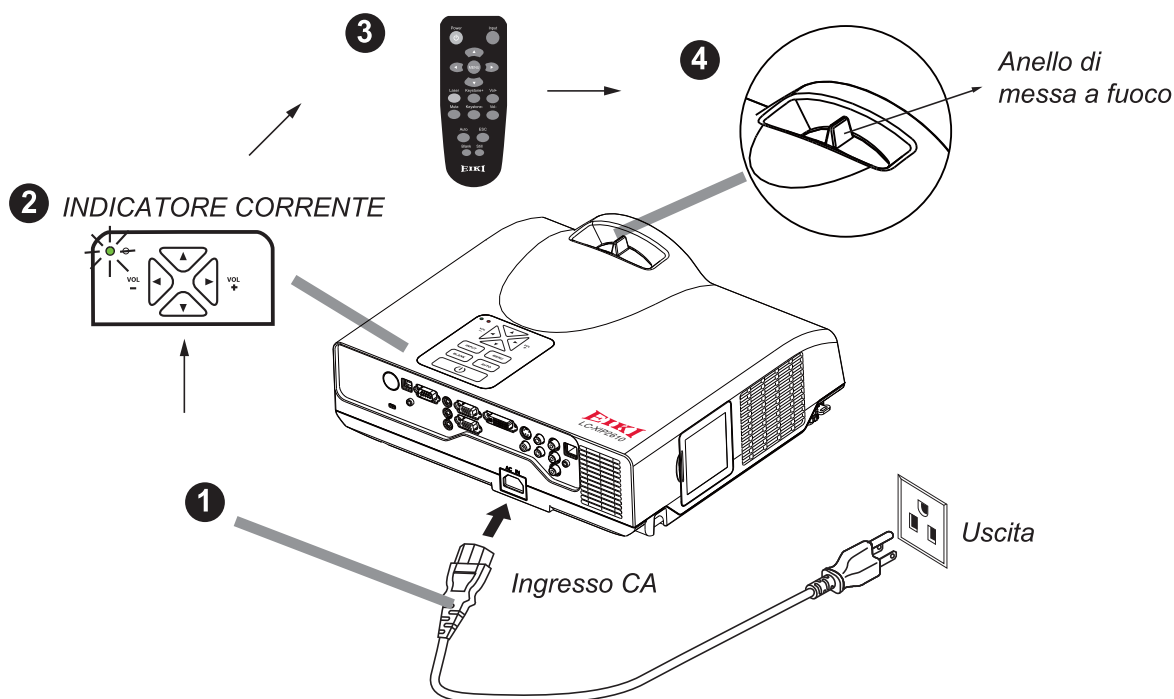

## Regolazione dell'altezza del proiettore

Utilizzare il piedino regolabile sulla parte anteriore del proiettore per impostare l'altezza dell'immagine.

- 1 Tenendo fermo il proiettore, premere i pulsanti di regolazione per sbloccare il piedino regolabile anteriore.
- 2 Posizionare il lato anteriore del proiettore all'altezza desiderata.
- 3 Sbloccare i pulsanti di regolazione dei piedini per bloccare i piedini regolabili anteriori.
- 4 Dopo essersi assicurati che i piedini regolabili anteriori siano stati bloccati, collocarvi il proiettore con cautela.

### ⚠ ATTENZIONE

1. Il raggio di regolazione del piedino regolabile anteriore varia da 0 a 7 gradi.
2. La regolazione del piedino potrebbe causare la distorsione di un'immagine. Usare la funzione di correzione keystone per correggere la distorsione.

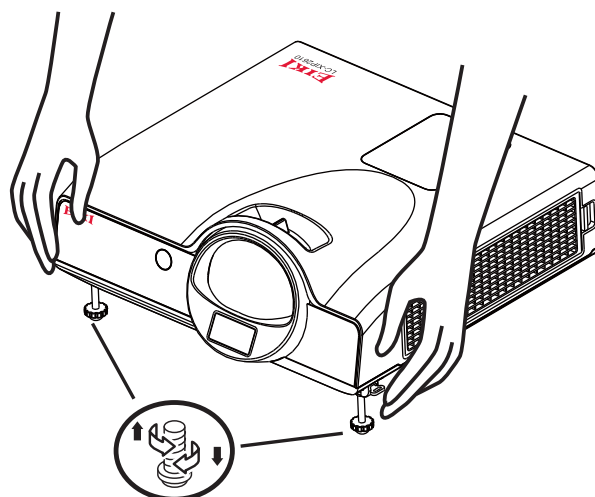

## Installazione batterie telecomando

- 1 Estrarre la batteria dal suo involucro.
- 2 Inserire le batterie. Verificare che i poli siano orientati correttamente.
- 3 Chiudere il vano batterie.

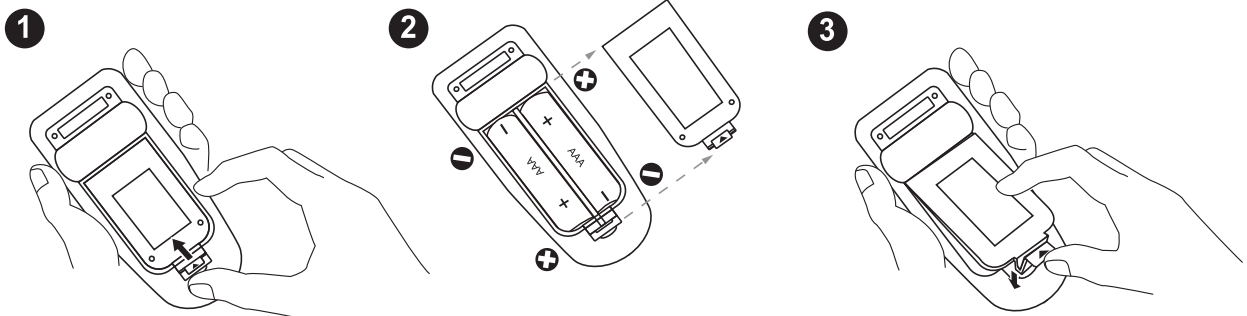

## Come eseguire il collegamento

### Collegandosi ad un computer

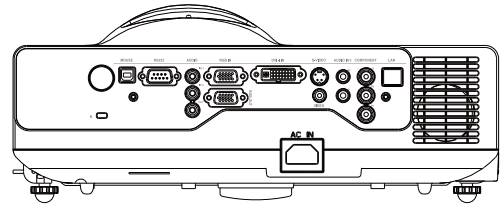

Calcolatore		Proiettore
1 USB Calcolatore	controllo interattivo  USB cavo	 USB Calcolatore
2 RS-232C Calcolatore	 RS-232C cavo	 RS-232C Calcolatore
3 Audio out	 3.5 mm Audio cavo	 AUDIO IN 1
 Calcolatore OUT	 RGB cavo	 RGB IN
4 DVI Calcolatore	 DVI cavo	 DVI Calcolatore
 Audio out	 3.5mm Audio cavo	 AUDIO IN 2
5 Network Calcolatore	 LAN cavo	 LAN

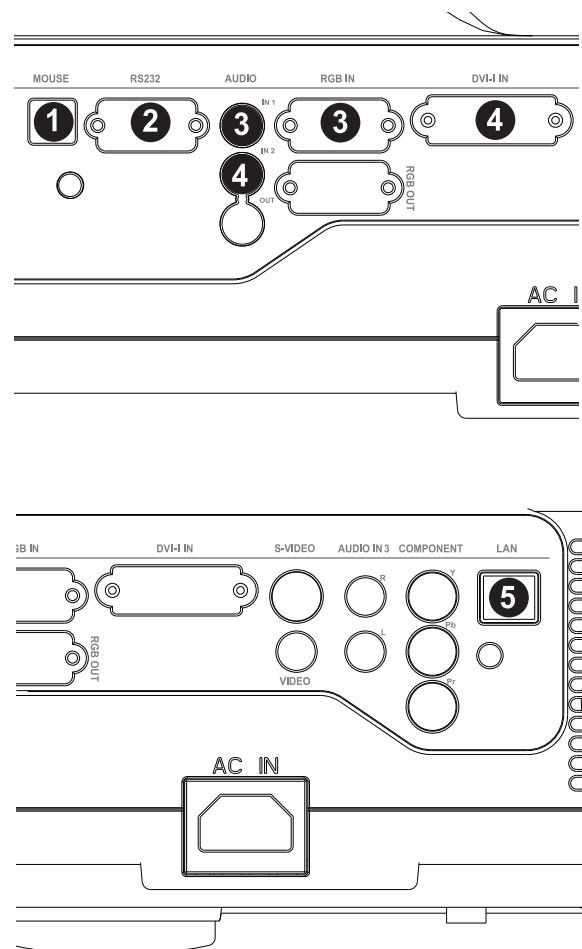



## Collegandosi ad un Montior

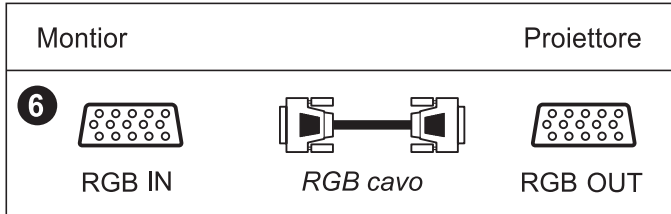
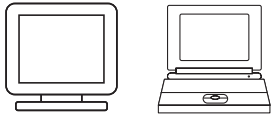

## Collegandosi ad un altoparlante

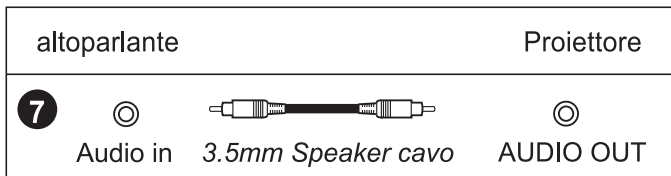

## Collegandosi ad un giocatore di VCD/DVD

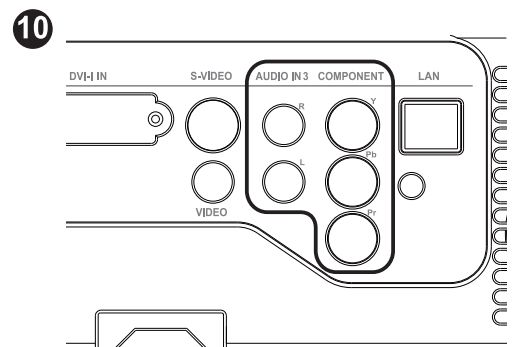
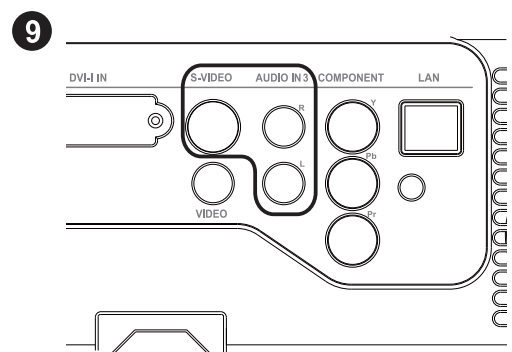
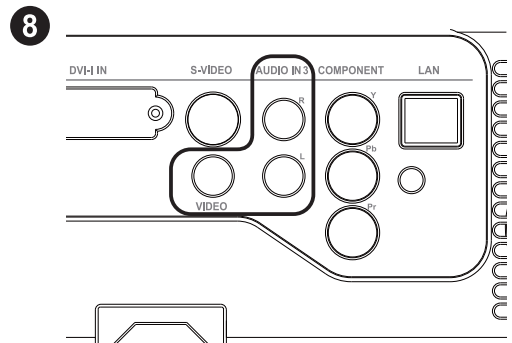
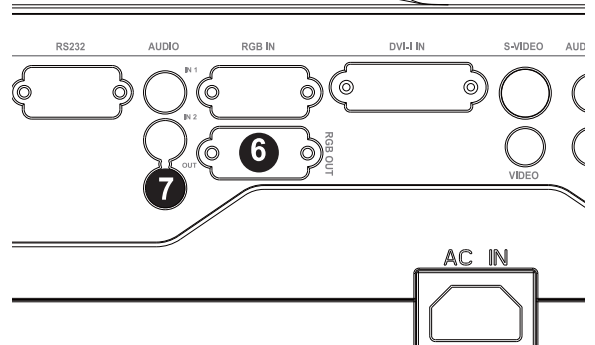
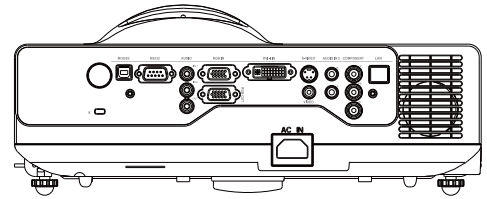
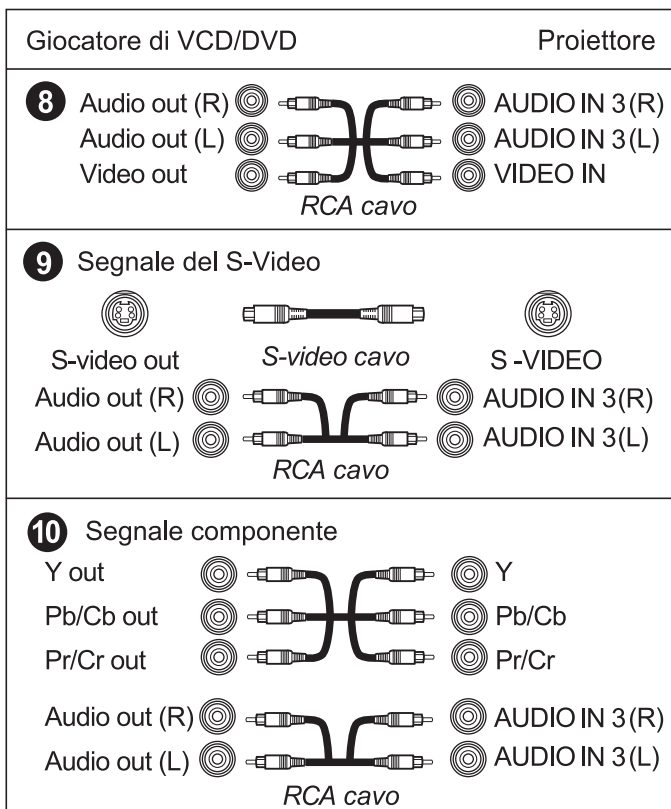
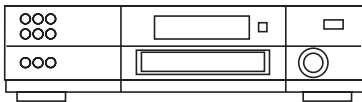

- 1 Premere il pulsante POWER sul pannello di controllo o sul telecomando per accendere il proiettore. Appare il messaggio di conferma “disattivazione” avvenuta.
- 2 Premere di nuovo il pulsante di ATTIVAZIONE durante la visualizzazione del messaggio.
- 3 Quando il proiettore passa alla modalità di “standby”, si accenderà l’indicatore di ATTIVAZIONE emettendo una luce verde.
- 4 In caso di non utilizzo del proiettore, rimuovere il cavo di collegamento elettrico.

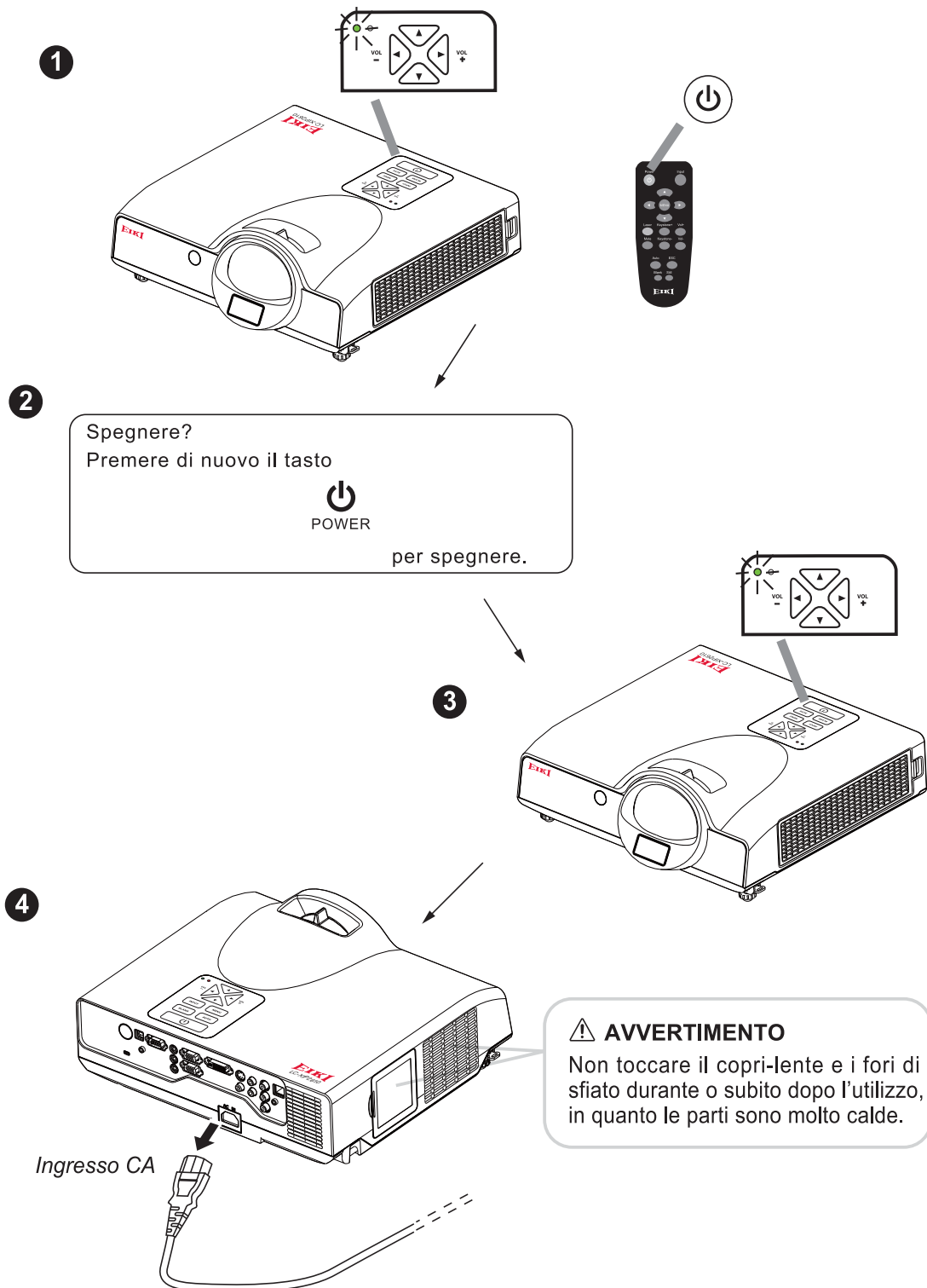



# EIKI

Projektor de Interativo

## uia de consulta rápida

Modelo LC-XIP2610

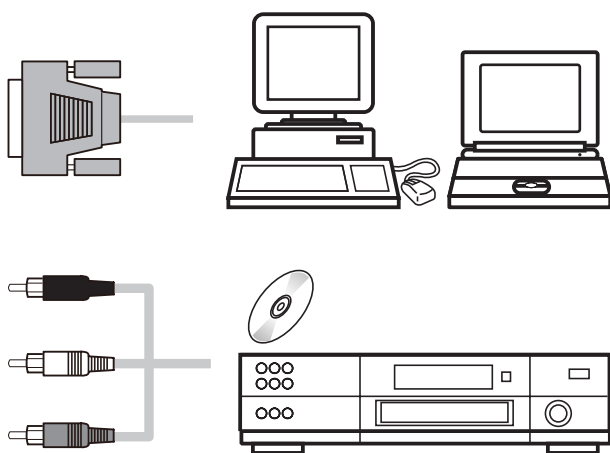
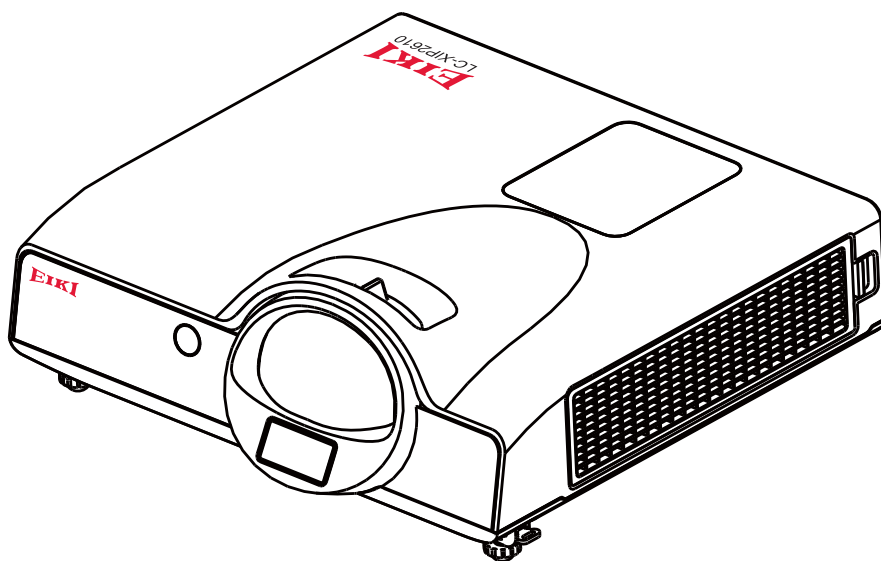

PORTUGUÊS

Use este livro como um guia do começo ao setting-up o projetor. Para a informações detalhadas sobre a instalação, a instalação e o funcionamento do projetor, referem o manual do proprietário no CD-ROM. Leia as instruções de segurança neste guia do começo rápido antes de usar o projetor.

## Conteúdo Da Embalagem

*Certifique-se de que os itens seguintes constam da embalagem juntamente com o projetor. Se qualquer um dos itens estiver em falta, contacte o fornecedor.*

- |  |                                      |   |
|--|--------------------------------------|---|
| <b>1</b> Projetor                            | <b>5</b> Cabo USB                    | <b>9</b> Caneta com LUZ (incluir as pilhas) |
| <b>2</b> Controlo remoto (incluir as pilhas) | <b>6</b> CD com manual do utilizador | <b>10</b> Ponteiro (incluir as pilhas)      |
| <b>3</b> Cabo de alimentação                 | <b>7</b> Guia de consulta rápida     | <b>11</b> Cinta                             |
| <b>4</b> Cabo para ligação ao computador     | <b>8</b> Acessórios                  |   |

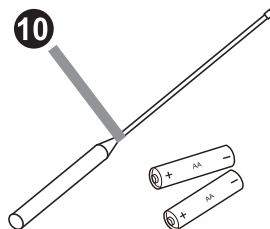
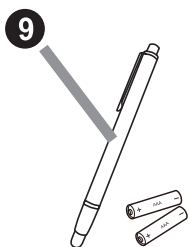
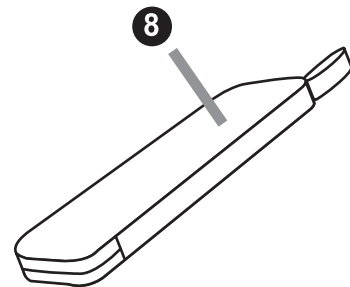
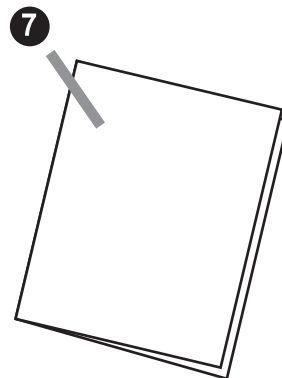
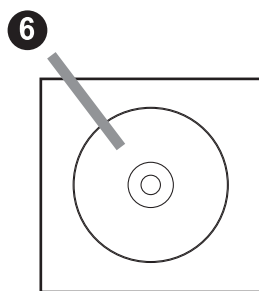
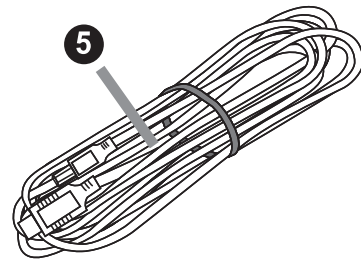
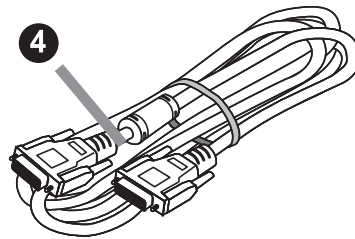
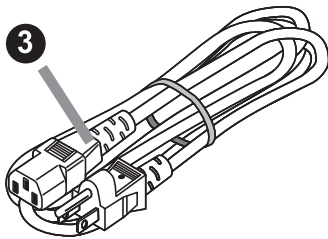
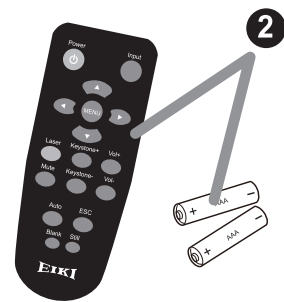
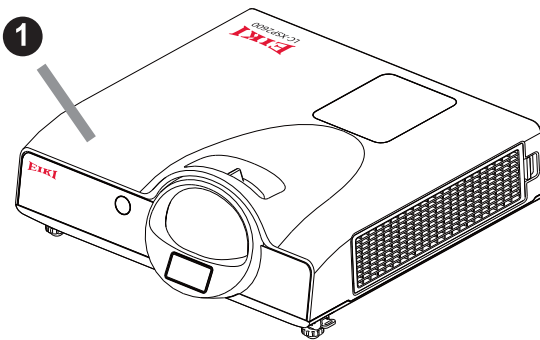

A distância entre o projetor e o ecrã determina o tamanho da imagem. Consulte a tabela em baixo para ajustar o tamanho do ecrã e a distância de projecção.

- 1 Ao colocar o projetor contra uma parede deixe um intervalo de cerca de 20 cm (7,9") entre ambos.

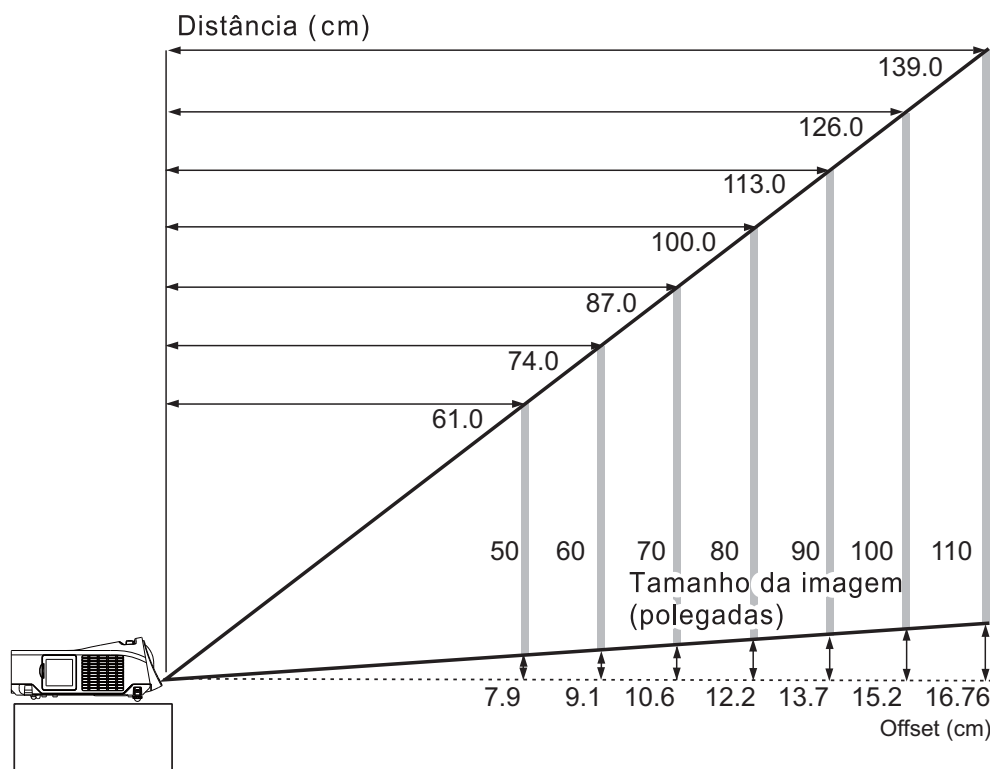

- 2 Nota: As dimensões dadas na tabela são valores aproximados.

Tamanho do ecrã (diagonal)	Distância (cm)	Offset (cm)
50	61.0	7.62
60	74.0	9.1
70	87.0	10.6
80	100.0	12.2
90	113.0	13.7
100	126.0	15.2
110	139.0	16.76

## Ligar o projetor

- 1 Certifique-se de que o cabo de alimentação está correctamente ligado ao projetor.
- 2 LED de alimentação fica verde.
- 3 Prima o botão de ALIMENTAÇÃO no painel de controlo ou no controlo remoto. para ligar o projetor.
- 4 Rode o anel de focagem para ajustar a focagem.

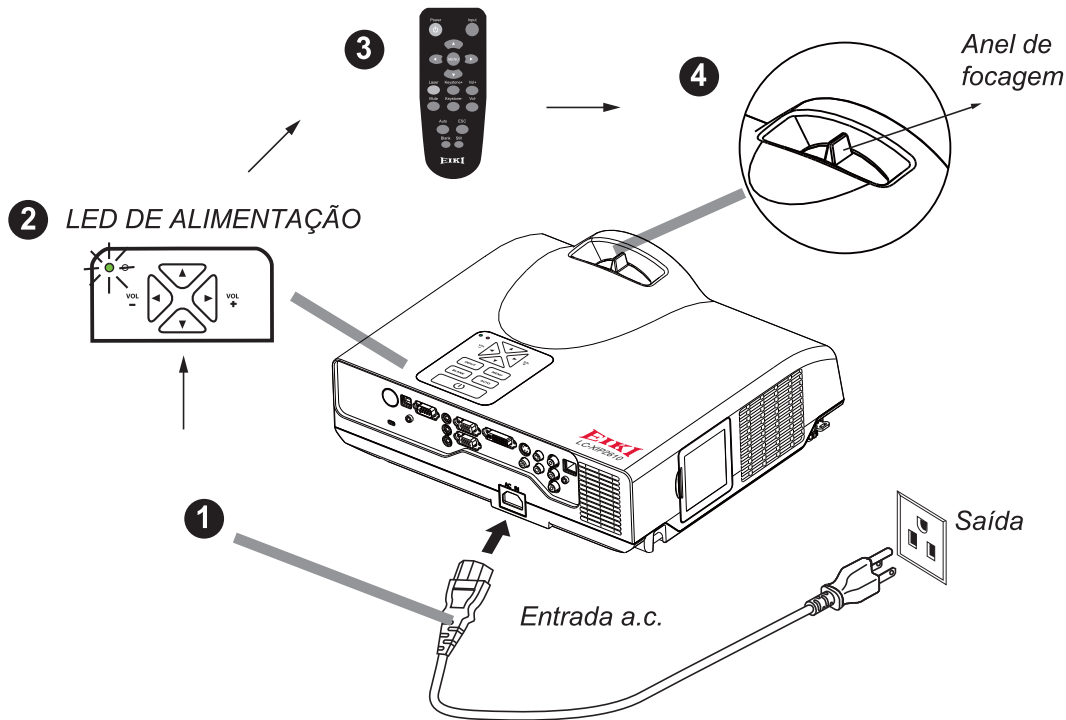

## Ajuste da altura do projetor

Use os pés ajustáveis existentes na parte da frente do projetor para ajustar a altura deste.

- 1 Segure no projetor e empurre os botões dos pés ajustáveis para os libertar.
- 2 Eleve a parte da frente do projetor até obter a altura pretendida.
- 3 Liberte os botões dos pés ajustáveis para fixar estes últimos na posição escolhida.
- 4 Depois de ter a certeza de que os pés do projetor estão fixos, posicione o projetor.

### ⚠ ATENÇÃO

1. O ajuste dos pés elevatórios frontais varia entre os 0 e 7 graus.
2. Quando os pés são ajustados, estes podem fazer com que a forma da imagem projectada fique distorcida. Use a função de correcção keystone para corrigir esta distorção.

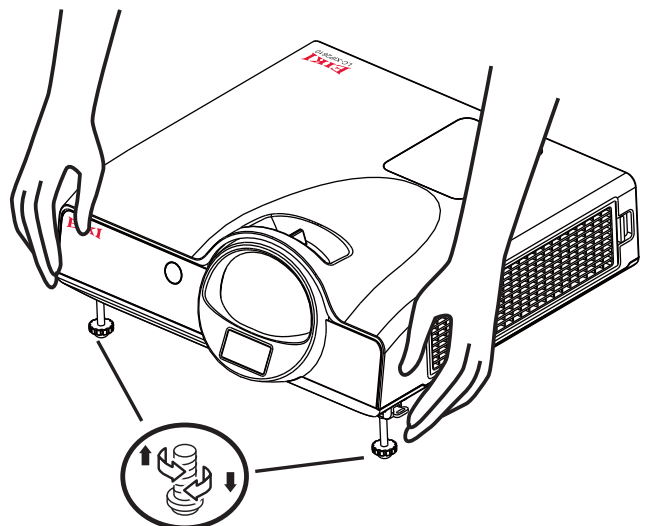

## Colocação das pilhas no controlo remoto

- 1 Remova a tampa.
- 2 Introduza as pilhas. Certifique-se de que as pilhas estão correctamente instaladas.
- 3 Feche a tampa do compartimento das pilhas.

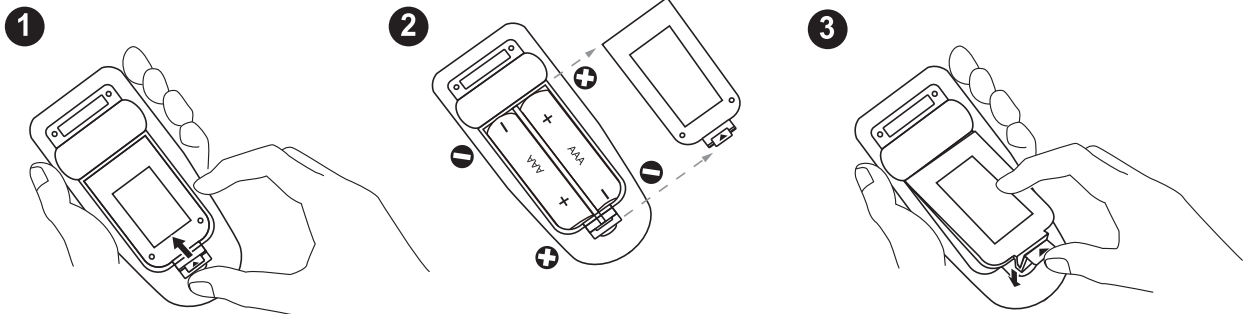

## Como ligar o projetor

### Conexão a um computador

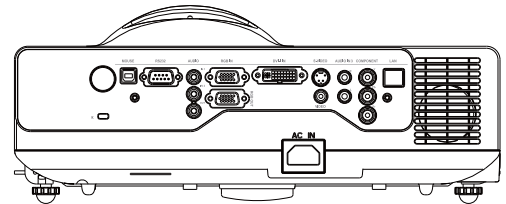

computador		Projetor
1  USB porto	controle interativo USB cabo	USB porto
2  RS-232C porto	RS-232C cabo	RS-232C porto
3  Audio out	Audio cabo	AUDIO IN 1
Monitor OUT	RGB cabo	RGB IN
4  DVI port out	DVI cabo	DVI port IN
Audio out	Audio cabo	AUDIO IN 2
5  Network porto	LAN cabo	LAN

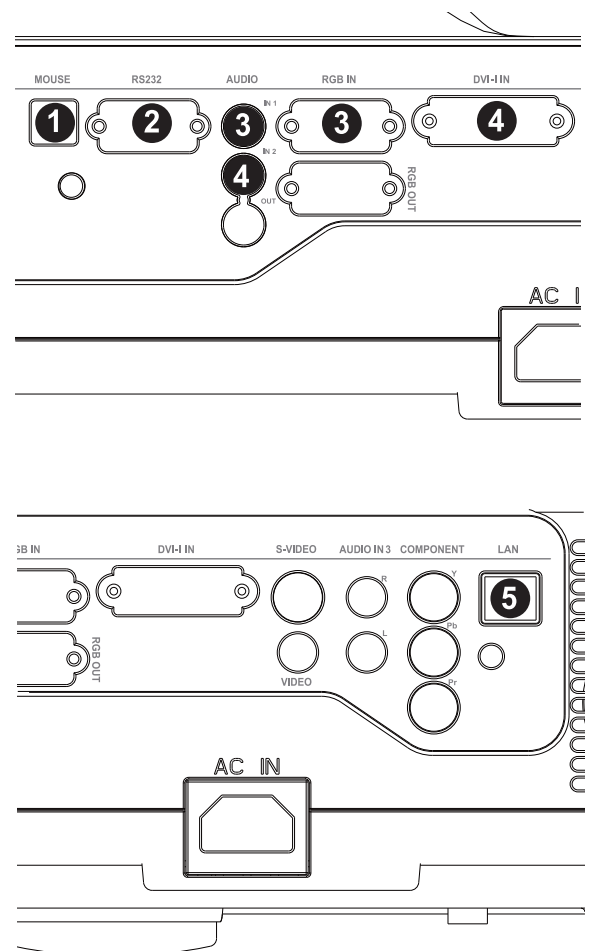



## Conexão a um monitor

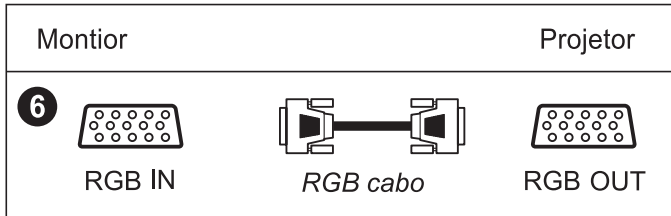
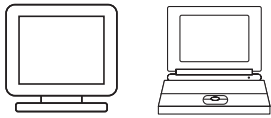

## Conexão a um altofalante

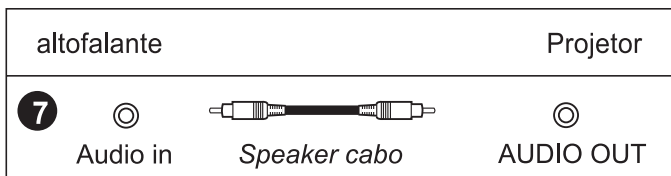

## Conexão a um jogador de VCD/DVD

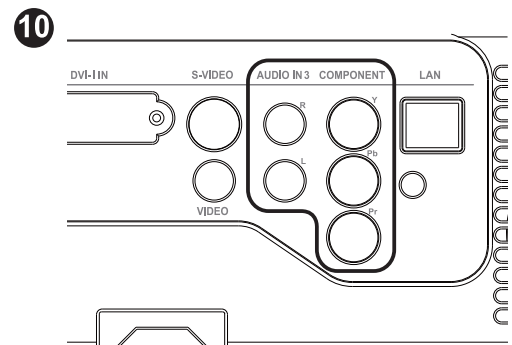
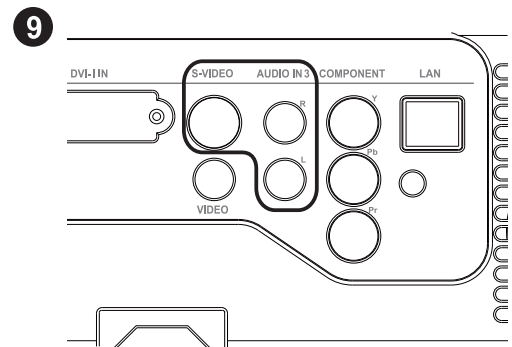
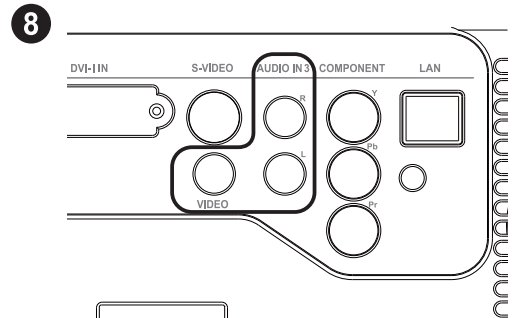
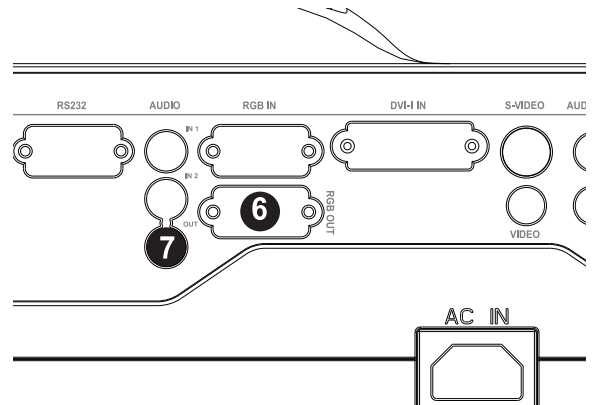
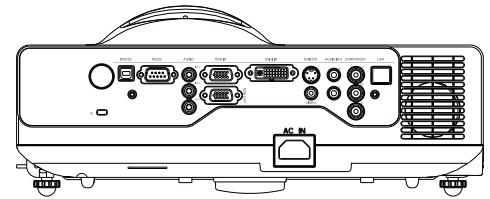
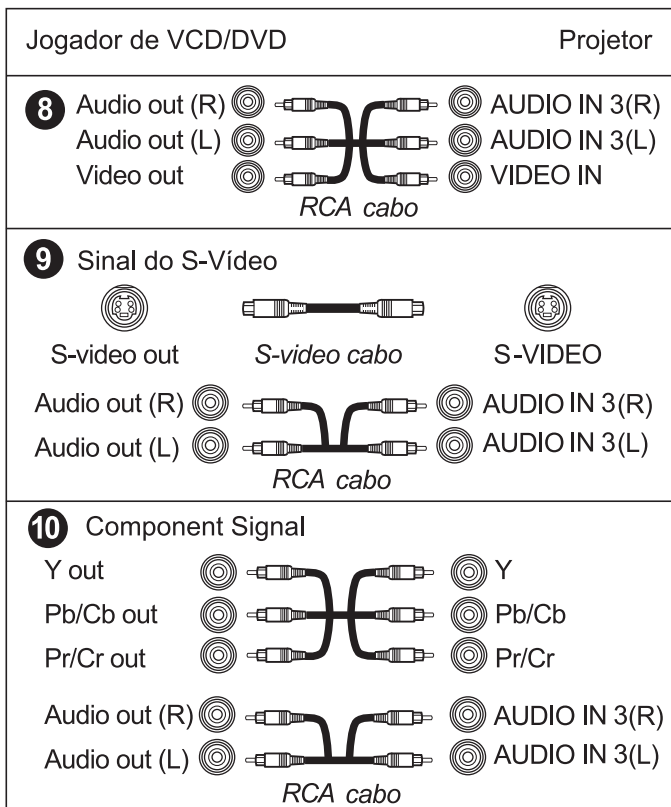
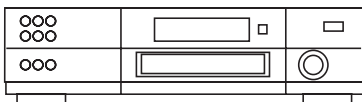

## Desligar o projetor

- 1 Prima o botão de alimentação no painel de controlo ou no controlo remoto. É mostrada a mensagem de confirmação “Desligar”.
- 2 Prima novamente o botão de ALIMENTAÇÃO quando esta mensagem for mostrada.
- 3 Quando o projetor entrar no modo de suspensão, o LED de alimentação fica verde.
- 4 Se não pretender usar o projetor, desligue o cabo de alimentação.

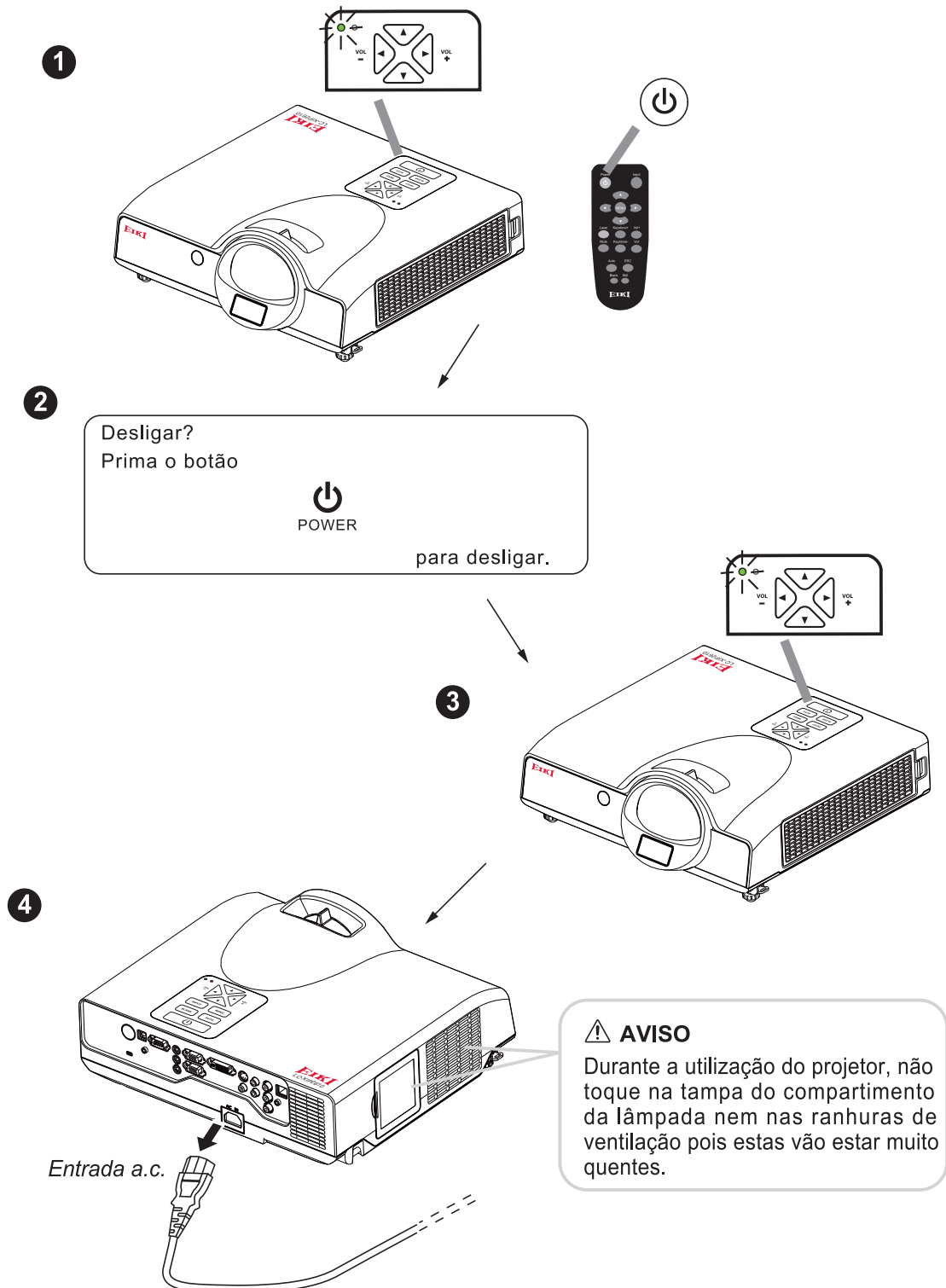



# EIKI

インタラクティブ・プロジェクター

## クイックスタートガイド

品番 LC-XIP2610

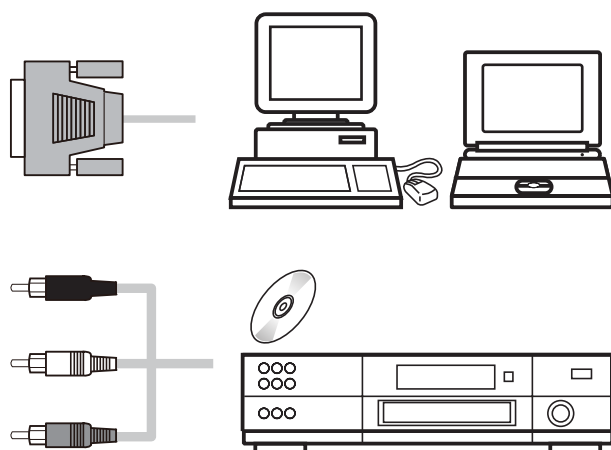
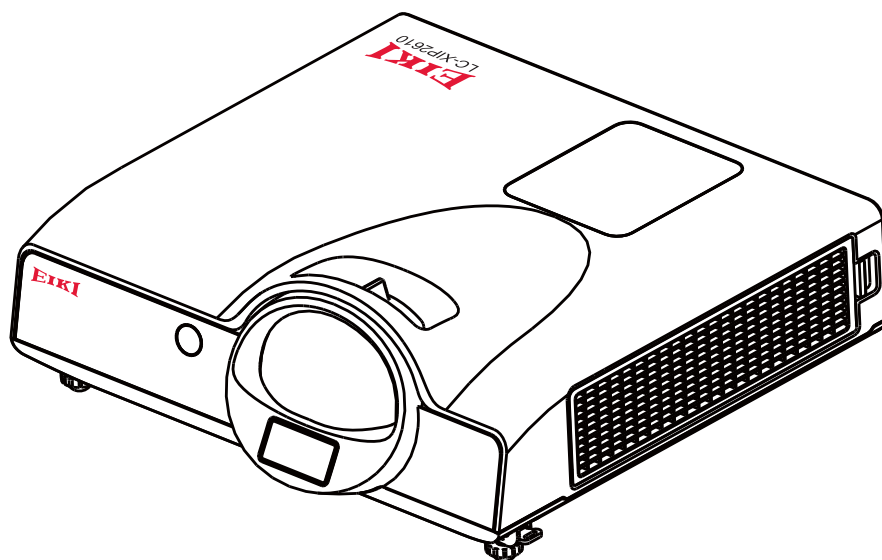

本書はプロジェクターを設置するときの参考用ガイドです。  
詳しい内容について、取り扱い説明書 (CD-ROM) をご覧ください。  
ご使用前に、取り扱い説明書の安全上のご注意を必ずお読みください。

## 付属品の確認

プロジェクター本体を含め、箱の中に以下のものが含まれているかご確認ください。万一不足しているものがあれば、すぐにお買い上げの販売店にご連絡ください。

- |                     |                    |                      |
|---------------------|--------------------|----------------------|
| ① プロジェクター           | ⑤ USB ケーブル         | ⑨ ペン (単4形乾電池2本含む)    |
| ② リモコン (単4形乾電池2本含む) | ⑥ 取扱い説明書CD-ROM     | ⑩ ポインター (単3形乾電池2本含む) |
| ③ 電源コード             | ⑦ クイックスタートガイド (本書) | ⑪ ストラップ              |
| ④ コンピュータケーブル        | ⑧ アクセサリーバッグ        |                      |

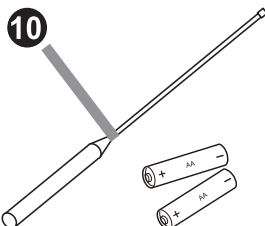
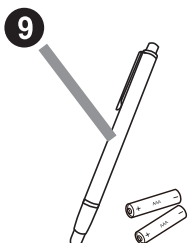
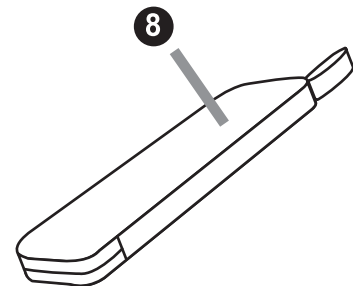
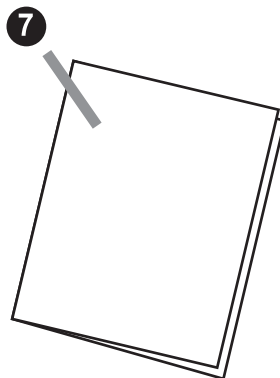
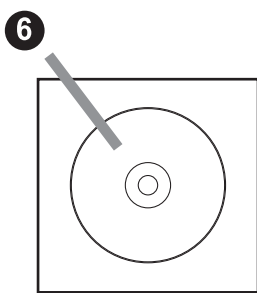
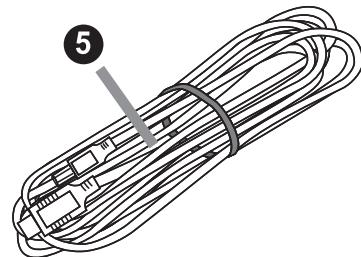
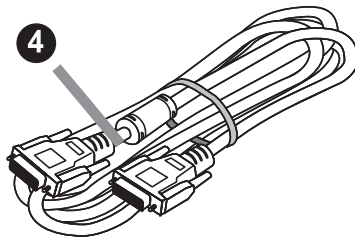
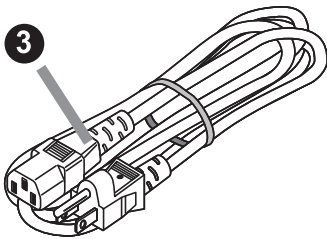
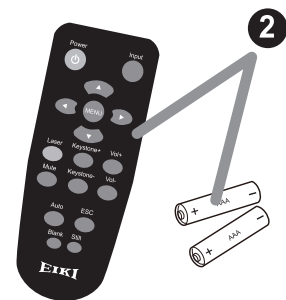
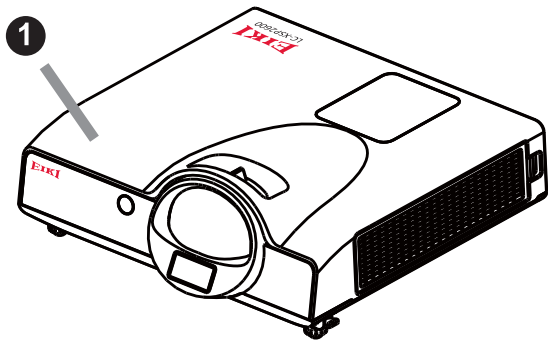

プロジェクターとスクリーンの距離は画面のサイズにより決定されます。下記の図表を参考にし、距離よりスクリーンのサイズをお決めください。

①

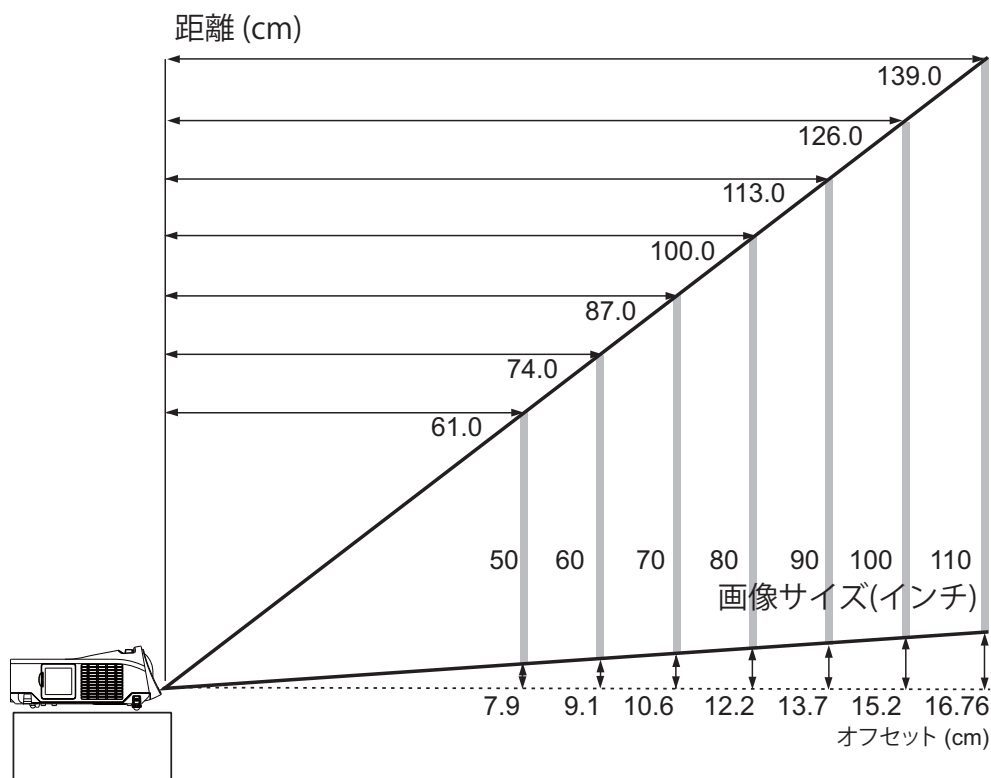

② 注：下表の寸法はおよその値です。

画面对角(インチ)	投射距離 (cm)	オフセット (cm)
50	61.0	7.62
60	74.0	9.1
70	87.0	10.6
80	100.0	12.2
90	113.0	13.7
100	126.0	15.2
110	139.0	16.76

- ① 本機のACソケットに電源コードのコネクターを差し込み、壁などのコンセントに電源コードのプラグを差し込んでください。
- ② 電源インジケータは、緑色に点滅します。
- ③ 操作パネルか、リモコンの電源ボタンを押して電源を入れて下さい。
- ④ フォーカスリングを回してフォーカスを調整してください。

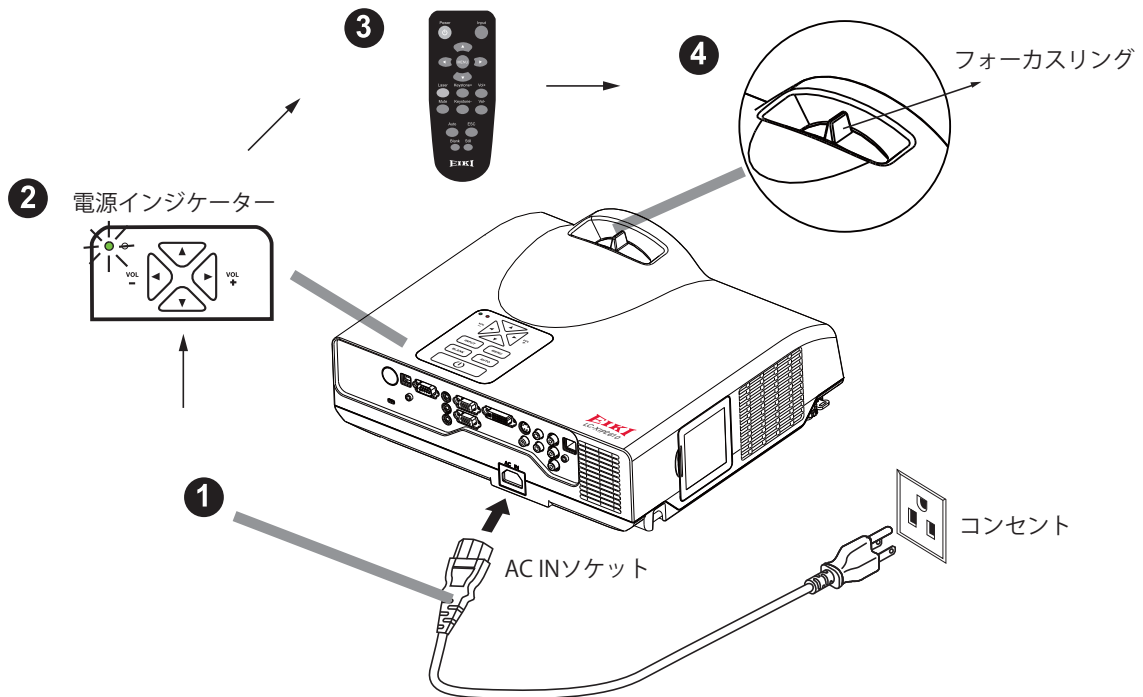

## 設置角度を調整する

フットアジャスターで設置角度を変えて、投影画面の高さを調整することができます。

- ① 本機を背面から両手で支え、フットアジャスター解除ボタンを押してください。
- ② 解除ボタンを離すと、フットアジャスターがその位置に固定されます。
- ③ アジャスターが固定されたことを確認してゆっくりと本機を置いてください。
- ④ フットアジャスターを回して投影画面の高さと傾きを微調整します。

### ⚠ 注意

1. フットアジャスターの調整範囲は0~7度です。
2. 調整脚をあげると、投影された画像が台形に歪む原因となります。 Keystone補正機能を使用してこの歪みを調整してください。

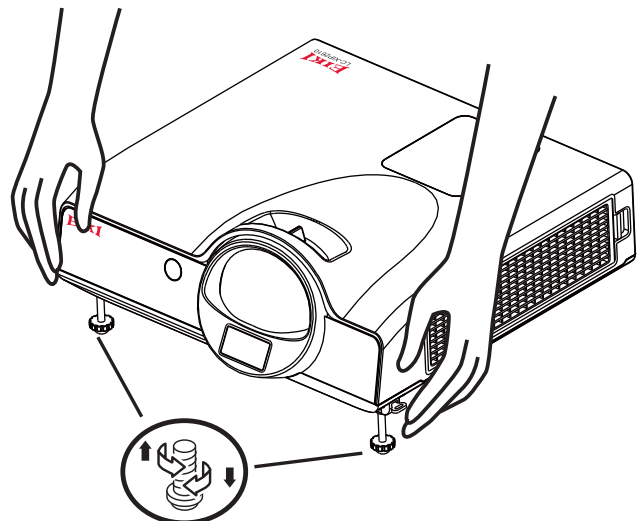

# リモコン電池の取り付け

- 1 電池カバーを取り外します。
- 2 乾電池を入れます。電池の+/-を確かめて入れてください。
- 3 電池カバーを閉めます。

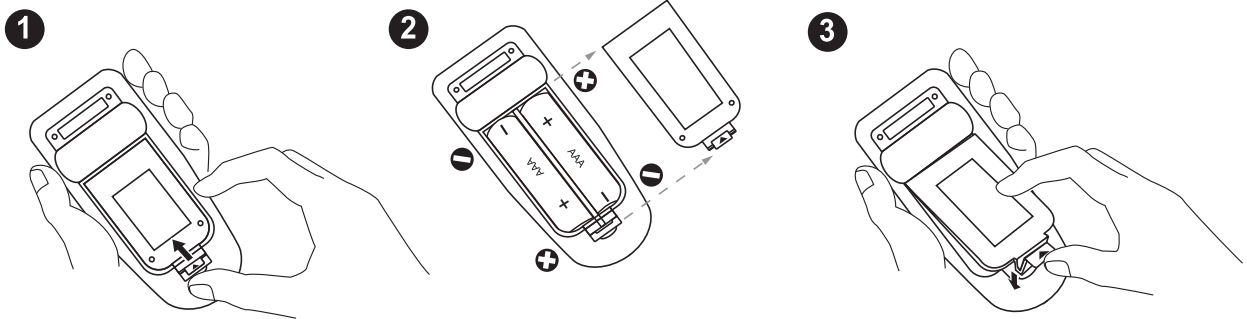

## 接続

### コンピューターとの接続

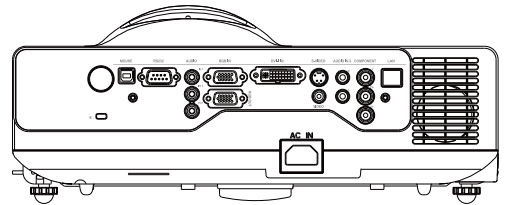

コンピューター		プロジェクター
1  USB port	インタラクティブコントロール USBケーブル	USB port
2  RS-232C port	RS-232Cケーブル	RS-232C port
3  Audio out	3.5MMオーディオケーブル	AUDIO IN 1
Monitor OUT	RGBケーブル	RGB IN
4  DVI port out	DVIケーブル	DVI port IN
Audio out	3.5MMオーディオケーブル	AUDIO IN 2
5  Network port	LANケーブル	LAN

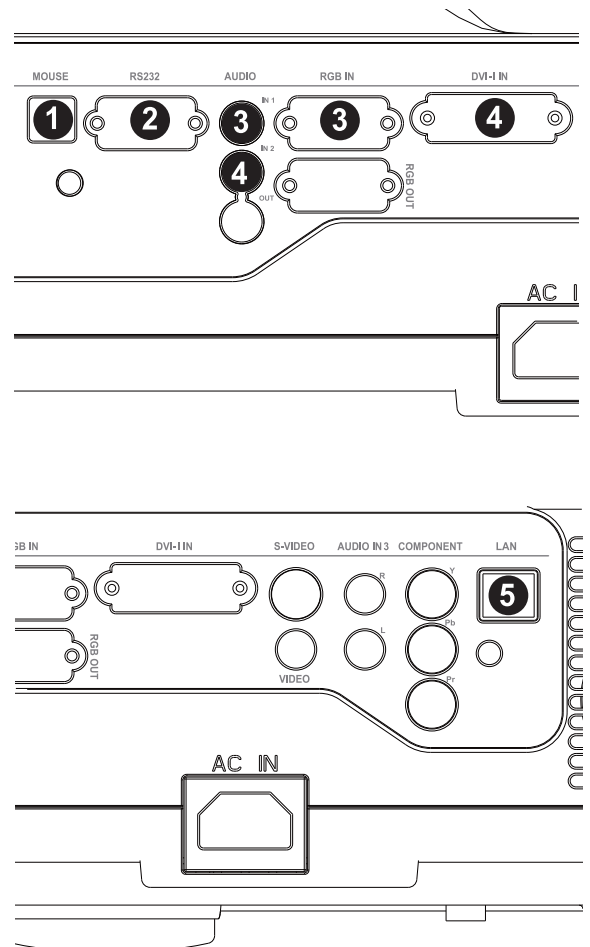



## モニターとの接続

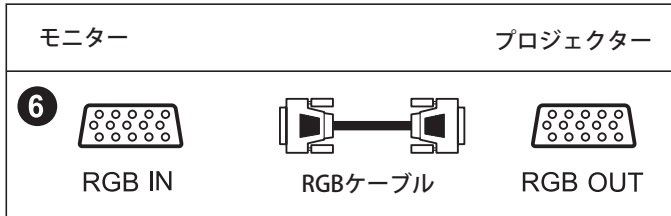
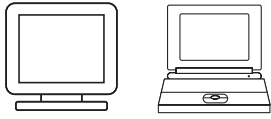

## スピーカーとの接続

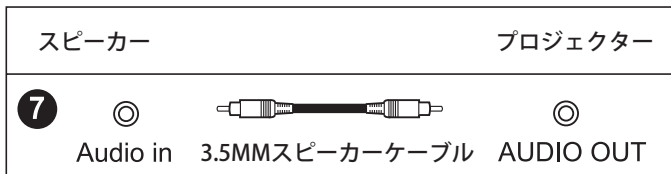

## VCD/DVDプレーヤーとの接続

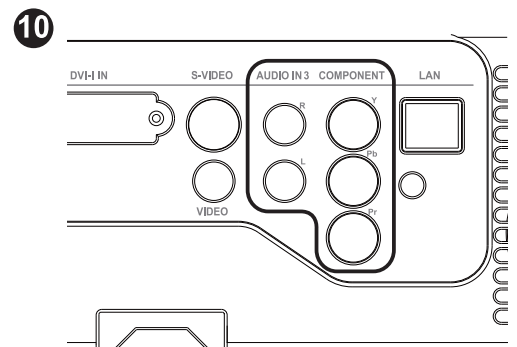
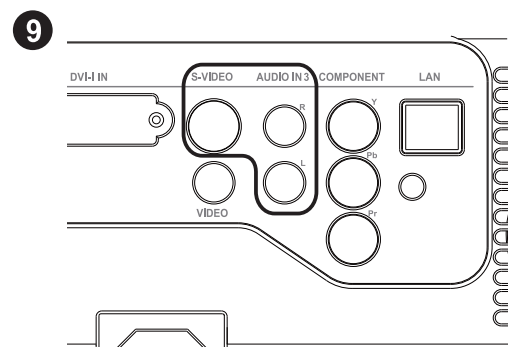
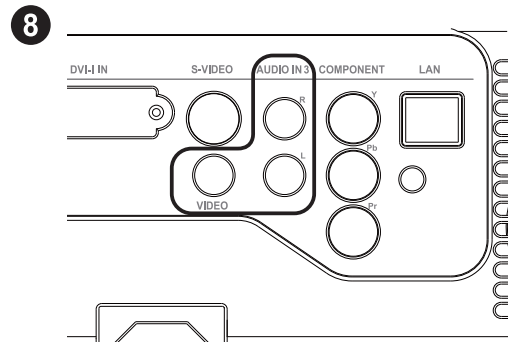
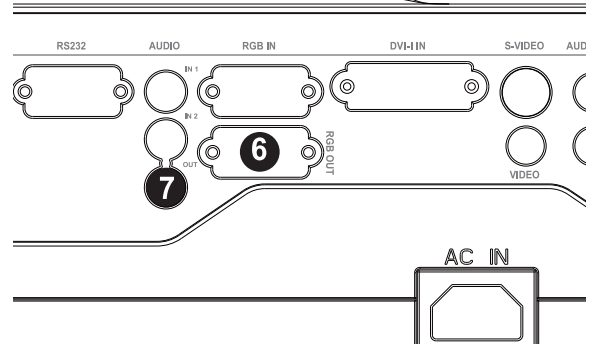
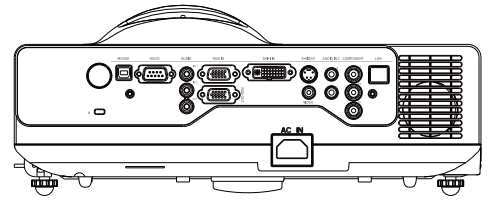
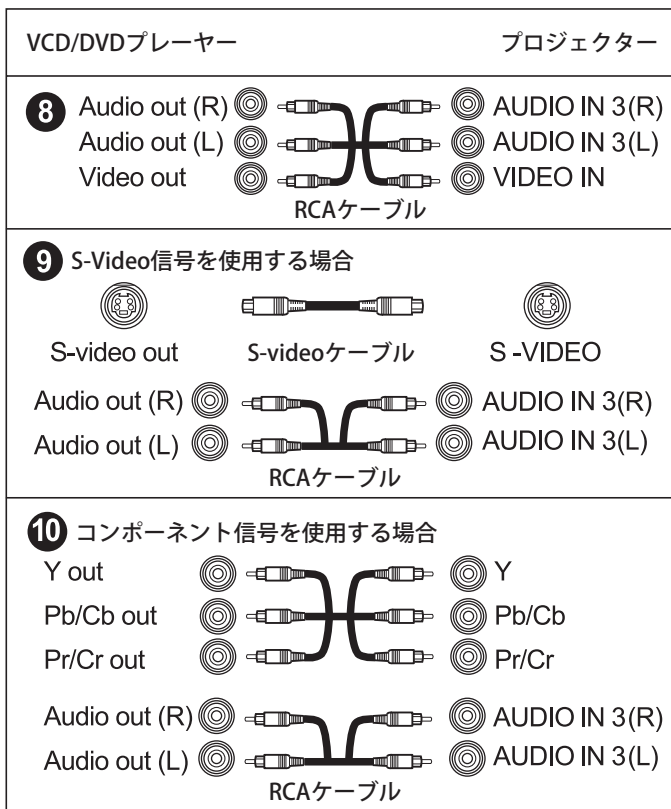
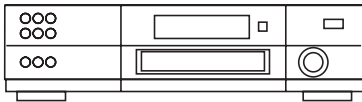

## 電源をオフにする

- 1 操作パネルやリモコンの電源ボタンを押すと、「電源オフ」のメッセージが出ます。
- 2 メッセージが表示されている間に、電源ボタンをもう一度押すと電源が切れます。
- 3 約2分間過ぎ、「スタンバイ」モードに入ると、電源インジケータは、緑色に点灯し、電源を入れることができます。
- 4 長期間プロジェクターを使用しないときは、電源プラグをコンセントから抜いてください。

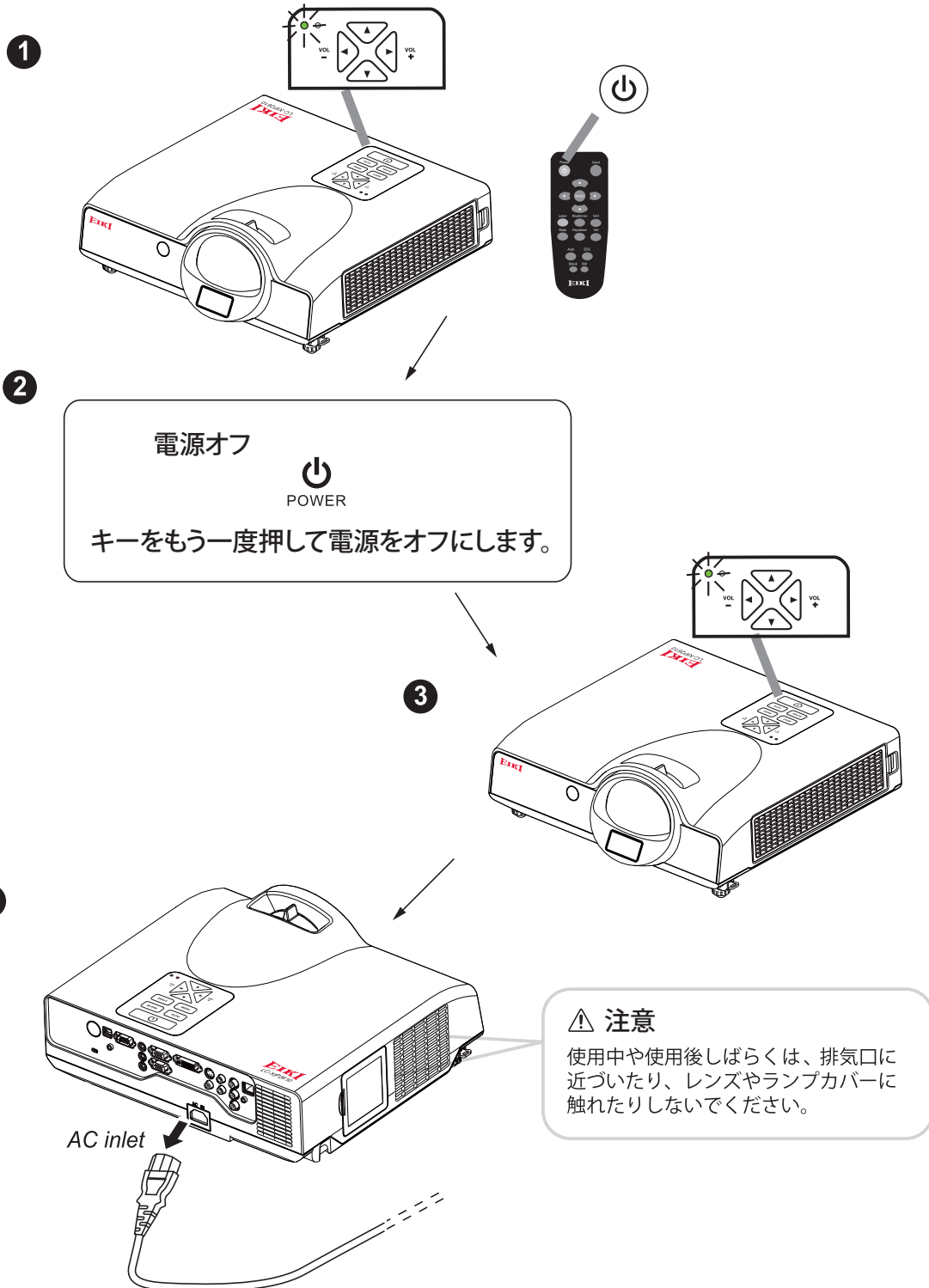



# EIKI

# Touchboards

205 Westwood Ave, Long Branch, NJ 07740  
Phone: 866-94 BOARDS (26273) / (732)-222-1511  
Fax: (732)-222-7088 | E-mail: [sales@touchboards.com](mailto:sales@touchboards.com)

WorldWide Website <http://www.eiki.com>