

EIKI

Touchboards

205 Westwood Ave, Long Branch, NJ 07740
Phone: 866-94 BOARDS (26273) / (732)-222-1511
Fax: (732)-222-7088 | E-mail: sales@touchboards.com

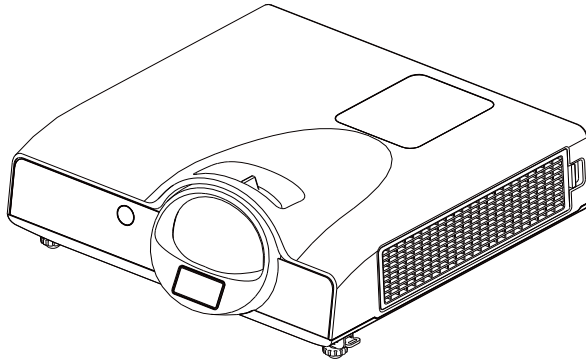

LC-XIP2610

OWNER'S MANUAL

Projector

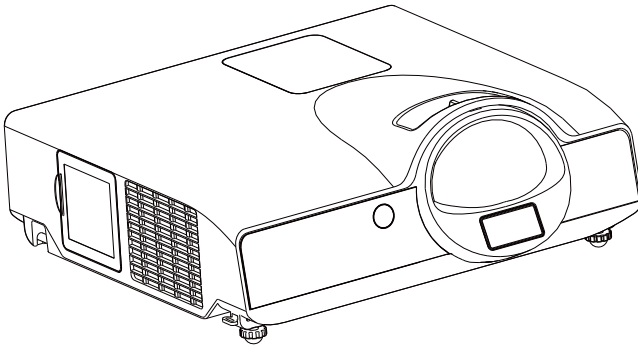

About the Owner's Manual

Please read the owner's manual thoroughly to ensure correct usage of the projector and its features.

After reading, store the owner's manual in a safe place for future reference.

Features

1. Short Throw
2. Dress up Design
3. Designed for tough environment
4. Side change lamp
5. Side change filter
6. Advanced Anti-theft features
7. Five auto features (Auto Search, Auto Sync, Auto Ceiling, Auto Keystone and Auto Filter Alert)
8. Seven display modes (Natural, Cinema, Daylight, Green board, White Board, Black Board and User)
9. Built-in 8W speaker
10. Logo capture
11. Image freeze function
12. Interactive function

The content of this manual is subject to change without prior notice.

All rights reserved.

Issue of edition 0111.01_00

Contents

About Owner's Manual

Contents	1
Contents of Your Box	3
Safety Instructions	4
Safety Labels	8
Part Names	9
Projector	9
Touch Keypad.....	10
Rear	11
Setting Up	12
Arrangement.....	12
Power ON / OFF	13
Setting Up The Projector.....	14
Ceiling Mounted Installation Guide.....	15
Adjusting The Projector's Elevation	16
How To Connect.....	17
Remote Control	19
Menu Operation	21
How To Operate On-Screen Display.....	21
MENU (PC Mode)	22
Picture Menu (PC Mode)	22
Audio Menu (PC Mode).....	23
Setting Menu (PC Mode)	24
MENU (Video Mode)	25
Picture Menu (Video Mode).....	25
Audio Menu (Video Mode).....	26
Setting Menu (Video Mode).....	27
MENU	28
Advanced Menu	28
Presentation Menu	31
Security Menu	33
PIN Key In Operation	37
Network Control Software Application	38
Procedure to utilize this function	38
Before Using Network Control Software.....	39

Contents

Network Control Software Application-Browser Control	40
Auto IP address setting.....	40
Item Setting description.....	41
Status	42
Control.....	43
Network.....	44
Alert.....	45
Schedule	46
Network Control Software Application-Software Control.....	47
Activate Network Control Software.....	47
Projector Auto Search.....	48
Modify The Projector Setting.....	49
Sorting the projector.....	50
Delete	51
Projector Setting.....	52
System Setting.....	53
Monitor / Default Setting / Auto Scan Timer.	54
Saving the Project File.	55
Link	56
Power Control / Input Source / Function Key.....	57
Function Key / Projector Status	58
Network Control Window Introduction	59
Maintenance Of Projector	60
Filter / How to clean or replace the filiters.....	60
Lamp / Replacing New Lamp	61
Additional	63
Troubleshooting.....	64
Indicator	64
Error For Machine Defects.....	65
List of Supported Monitor Displays.....	67
Appendix	

Contents of Your Box

Please make sure that following items are included in the box. If any items are missing, contact your dealer please..

1. Projector

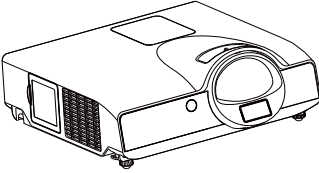

2. Remote control

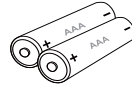

3. Owner's Manual CD

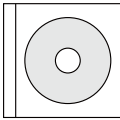

4. Quick Start Guide

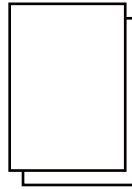

5. Power cord

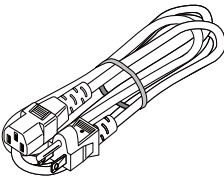

6. Computer cable

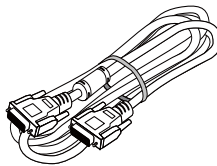

7. USB Cable

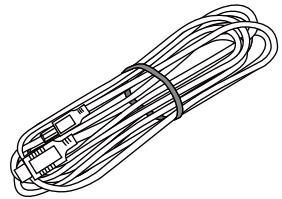

8. Interactive Kit

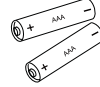
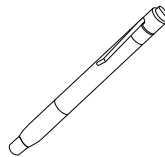
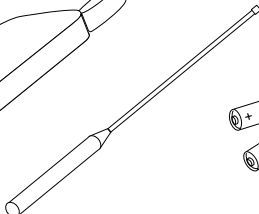
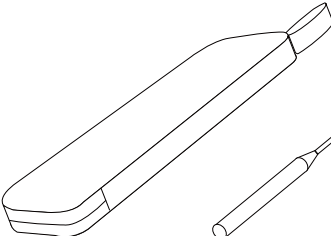

Accessory Bag

Pointer

AA Batteries

Pointer

AAA Batteries

Strap

Safety Instructions

The projector is designed and tested to meet the latest standards for safety of information technology equipment. However, to ensure safe use of this product, it is important that you follow the instructions mentioned in this manual and marked on the product.



WARNING

This symbol indicates information that, if ignored, could possibly result in personal injury or even death.



CAUTION

This symbol indicates information that, if ignored, could result in personal injury or physical damage.

Typical Symbols



This symbol indicates an additional warning (including cautions). An illustration is provided to clarify the contents (for example: the illustration to the left indicates danger of electrical shock).



This symbol indicates a prohibited action. The contents will be clearly indicated in an illustration or description near the symbol (for example: the symbol to the left indicates that disassembly is prohibited).



This symbol indicates a compulsory action. The contents will be clearly indicated in an illustration or description near the symbol (for example: the symbol to the left shows that the power plug should be disconnected from the power outlet).

Safety Instructions

WARNING

If a problem should occur

If smoke or strange odors arise, continued use could result in fire or electrical shock. In such case, immediately turn off the power switch and then disconnect the power plug from the power outlet. After making sure that the smoke or odor has stopped, contact your dealer for repairs. Never attempt to make repairs yourself because this is dangerous.

Do not use this projector if there is no image or sound, or if the sound is distorted. Continued use could result in fire or electrical shock. In such case, immediately turn off the power switch; disconnect the power plug from the power outlet and contact your dealer.

If water would enter the inside of this projector, immediately turn off the power switch, disconnect the power plug from the power outlet and contact your dealer.

Do not install on an unstable surface.

Do not install this projector on an unstable surface such as a wobbly stand or incline because this could result in the projector falling and causing injury.



Do not open the cabinet.

Never open the cabinet. There is high voltage inside which can cause electrical shock. Contact your dealer for internal inspection, adjustment and repair.



Do not modify.

Do not modify this projector because this could result in fire or electrical shock.



Do not place the projector upon either side to project an image.

NO SIDEWARD

Do not use in the bathroom or near water site.

Do not expose this unit to rain or use near water... for example, in the bathroom, a wet basement, near a swimming pool, etc...

Do not insert objects into the Projector.

Do not insert metal objects through the ventilation openings, etc., of this projector or drop such objects inside because this could result in fire or electrical shock.

If a foreign object should enter this projector, immediately turn off the power switch, disconnect the power plug from the power outlet and contact your dealer.

Continued use could result in fire or electrical shock. Use special caution in household and where children are present.

Safety Instructions

WARNING

Do not look through the lens when the lamp is on.

Never look through the lens when the lamp is on. The powerful light could adversely affect vision. Use special caution in households where children are present.



Avoid shock or impact on the projector.

If the projector should fall, resulting in damage to the cabinet, immediately turn off the power switch, disconnect the power plug from the power outlet and contact your dealer.



Continued use could result in fire or electrical shock.

Do not place this projector in a container containing liquid. Do not place flower vases, flowerpots, cups, cosmetics, liquids such as water, etc., on top of this projector.

Do not use any power cable except those supplied with the projector.

The use of any other power cable could result in fire or electrical shock.

Do not shine the laser beam onto yourself or other.

The laser pointer function of projector remote control emits class II laser beam.

Do not look directly into the laser beam outlet or direct the laser beam at other people.

Vision can be impaired if the laser beam enters the eyes. Especially pay attention if children are present.

High temperatures are generated when the lamp is lit; so do not place objects in front of the lens.

Allowing the proper amount of space on the top, sides, and rear of the projector cabinet is critical for proper air circulation and cooling of the unit.

The dimension shown here indicate the minimum space required. If the projector is to be built into a compartment or similarly enclosed, these minimum distances must be maintained.

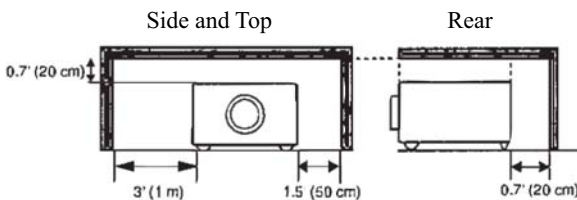

Safety Instructions



CAUTION

Placing heavy objects on top of this projector could result in loss of balance or falling and cause personal injury or damage the projector.



Do not block the ventilation openings of this projector.

Blocking ventilation could lead to internal overheating which could result in fire.

Do not place this projector on its side during use or push it into a small, poorly ventilated location.

Do not place this projector on a carpet or bedding or cover it with a tablecloth, etc.

Care and maintenance.

For safety purposes, disconnect the power plug from the power outlet before starting the care and maintenance of this projector.



Battery usage.

Replace the batteries with the same type only.

Do not mix old and new batteries; this could result in fire or personal injury due to battery cracking or leakage.

Make sure the plus and minus terminals are correctly aligned when loading the batteries.

Incorrect loading could result in personal injury or contamination of the surroundings due to battery cracking or leakage.



Have the projector interior cleaned regularly.

Contact your dealer to arrange for the service.

Accumulations of dust inside the projector can result in fire or malfunction if not cleaned for an extended period.

Ask your dealer for details about internal cleaning.

Safety Labels

Safety labels are used on or within the projector to alert you to items or areas requiring your attention.

WARNING LABEL

<p>WARNING</p> <ul style="list-style-type: none"> • BEFORE OPERATING, PLEASE READ USER'S MANUAL. • BEFORE REMOVING SCREWS, DISCONNECT POWER CABLE. • DO NOT BLOCK VENTING OPENINGS. 	<p>WARNUNG</p> <ul style="list-style-type: none"> • VOR DEM EINSATZ DIE BEDIENUNGSANLEITUNG LESEN. • VOR DEM ENTFERNEN DER SCHRAUBEN DAS NETZKABEL ABTRENNEN. • LÜFTUNGSÖFFNUNGEN NICHT BLOCKIEREN. 	<p>AVIS</p> <ul style="list-style-type: none"> • VEUILLEZ LIRE LE MODE D'EMPLOI AVANT L'USAGE. • DÉBRANCHEZ LE CABLE D'ALIMENTATION AVANT DE RETIRER LES VIS. • NE BOUCHEZ PAS LES ORIFICES DE VENTILATION.
<p>警告</p> <ul style="list-style-type: none"> • ご使用前に、取扱説明書をお読みください。 • 器具を多くはなす前に、必ず電源プラグをコンセントから抜いてください。 <p><small>(注) 本製品は水銀を含有しています。水銀の廃棄は環境規制の対象となります。廃棄またはリサイクル情報は、ご当地の自治当局または電子産業連合会 (EIAA) のウェブサイト (www.eiaa.org) を参照してください。</small></p>	<p>警告</p> <ul style="list-style-type: none"> • 操作前、取扱説明書を使用説明書。 • 部品を多くはなす前に、必ず電源プラグをコンセントから抜いてください。 	<p>警告</p> <ul style="list-style-type: none"> • 操作前、取扱説明書を使用説明書。 • 部品を多くはなす前に、必ず電源プラグをコンセントから抜いてください。

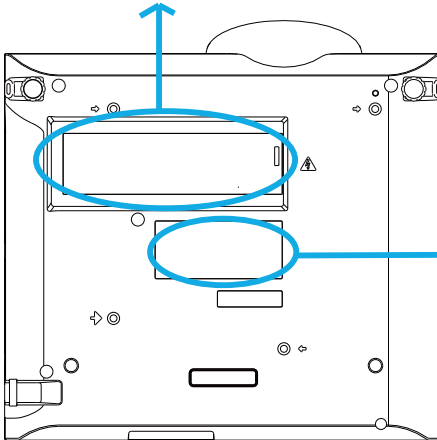

EMI Label

<p>LCD Projector</p> <p>Model:</p> <p>INPUT: AC 100V-240V~50/60Hz 3.6A-1.6A</p> <p>Serial no.:</p> <p>XXXXXXXXXXXX</p>	<p>CE, FCC, and other regulatory marks.</p>
---	---

LAMP DOOR WARNING LABEL

<p>CAUTION HOT</p> <p>TURN THE POWER OFF AND WAIT 1 HOUR BEFORE CHANGING THE LAMP.</p> <p>WARNING HEISS!</p> <p>SCHALTEN SIE DAS GERÄT AUS UND WARTEN SIE 1 STUNDE BIS SIE DIE LAMPE WECHSELN.</p>	<p>ATTENTION CHAUD</p> <p>COUPER L'ALIMENTATION ET ATTENDRE 1 HEURE AVANT DE CHANGER LA LAMPE.</p> <p>高温注意</p> <p>ランプ交換は、電源を切った後、1時間待ってか行ってください。</p> <p>关闭投影机电源后，必须冷却至少1小时后才进行更换灯泡。</p>
<p>CAUTION</p> <p>HIGH-PRESSURE LAMP MAY EXPLODE IF IMPROPERLY HANDLED.</p> <p>REPLACE WITH SAME TYPE NUMBER LAMP. DO NOT CLEAN THE AIR FILTER WITH WATER OR ANY LIQUID.</p> <p>DO NOT OPERATE THE PROJECTOR WITHOUT THE AIR FILTER.</p> <p>VORSICHT!</p> <p>DIE HOCHDRUCKLAMPE KANN BEI FALSCHER HANDHABUNG EXPLODIEREN. NUR MIT EINER LAMPE DES GLEICHEN TYPES AUSTAUSCHEN.</p> <p>VERWENDEN SIE ZUR REINIGUNG DES LUFFILTERS WEDER WASSER NOCH ANDERE FLÜSSIGKEITEN.</p> <p>BETRIEBEN SIE IHREN PROJEKTOR NICHT OHNE DEN LUFFILTERS.</p>	<p>ATTENTION</p> <p>LA LAMPE À HAUTE PRESSION PEUT EXPLOSER SI ELLE EST MANIPULÉE INCORRECTEMENT.</p> <p>REMPLEZ PAR UNE LAMPE AVEC UN NUMERO DE TYPE IDENTIQUE.</p> <p>N'UTILISEZ PAS D'EAU NI UN AUTRE LIQUIDE POUR NETTOYER LE FILTRE À AIR. NE FAITES PAS FONCTIONNER VOTRE PROJECTEUR SANS LE FILTRE À AIR.</p> <p>注意</p> <p>ランプは、同じタイプのものと交換してください。</p> <p>誤った取り扱いはしたときに、高圧ランプが破裂する恐れがあります。</p> <p>水やお湯で洗わないでください。</p> <p>フィルタをはずした状態で電源を入れしないでください。</p> <p>故障 不正な地処理灯泡也许会致爆裂。</p> <p>请使用同类型的灯泡。</p> <p>请不要用水或液体清洗滤网。</p> <p>没有装置滤网，请勿操作投影机。</p>

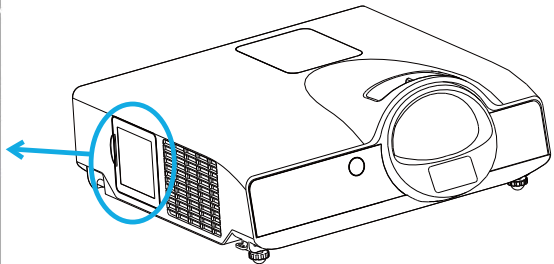

Projector

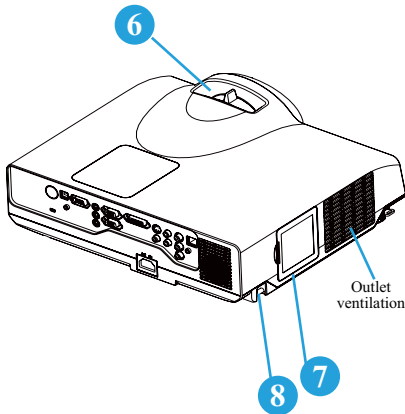
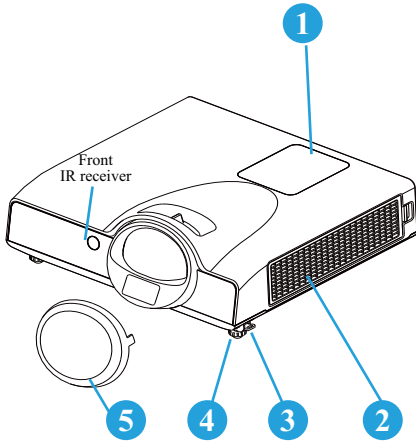

1 Touch Keypad

Operating system.

2 Filter cover

Prevents dust and other foreign particles from being drawn into projector.

Remove the filter cover to clean the air filter.

3 Foot adjust button

Lock / unlock the adjustable foot.

4 Front adjustable foot

Extend and retract to adjust the projection angle.

5 Lens Cover

Attach when not using to protect the lens from becoming dirty or damaged.

6 Focus ring

Use the focus ring to focus the projector image.

Rotate the focus ring until the image is clear.

7 Lamp door

The lamp unit is inside

8 Security Bar

Touch Keypad

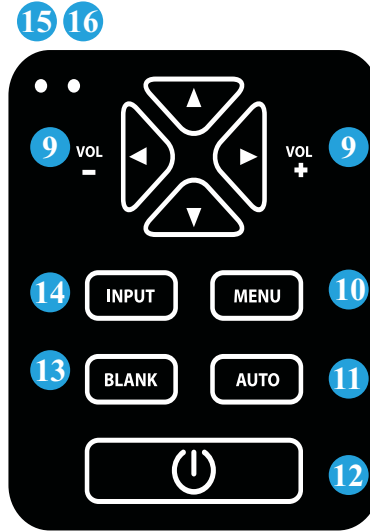

9 VOLUME + / -

Sound louder or lower.

10 MENU

Display or hide the OSD main menu

11 AUTO

Automatically adjust the setting to match the current input.

12 (POWER)

Power On / Off.

13 BLANK

Blank the projected image. The time of Blank mode can be set in 15 minutes, 30 minutes or 60 minutes. The projector will shut down automatically after passing each set time.

14 INPUT

Select input source:



Note :

If the projector can not be captured the signals within 15 minutes, it will be shut down automatically.

15 POWER INDICATOR

Light on or flash to indicate the operating status of the projector.

16 LAMP INDICATOR

Indicate a status in the projector.

Rear

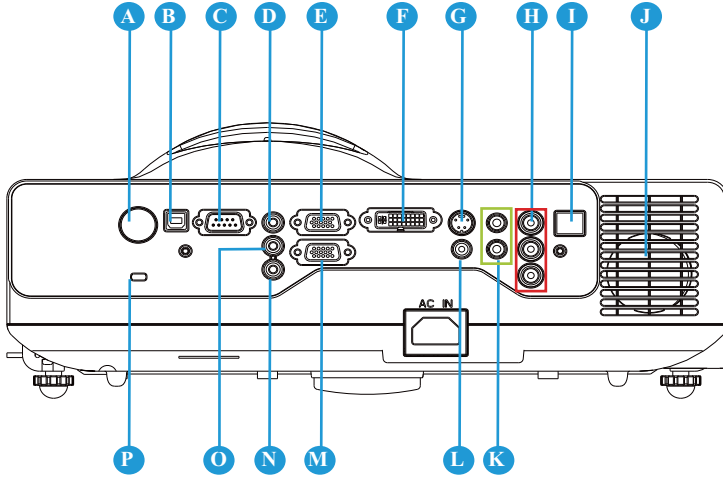

A REAR IR RECEIVER

B USB

Connect a USB cable to a computer to control Interactive functions.

C RS232

Serial data port for controlling the projector with a computer or other RS-232 control device.

D AUDIO IN 1 & O AUDIO IN 2

Mini jack port corresponds to computer input. (RGB IN→AUDIO IN 1, DVI-1 IN →AUDIO IN 2)

E RGB IN

Input analog RGB signal from a computer.

F DVI-I IN

Input digital DVI-I signal from a computer.

G S-VIDEO

S-Video signal from a video source.

H COMPONENT (Y, Pb, Pr / Y, Cb, Cr)

Input Component signal from a DVD player.

I LAN

Please see page 37 Network Control Application for details.

J SPEAKER

K AUDIO IN 3, R / L

RCA type corresponds to video input.

L VIDEO

Composite video signal from a video source.

M RGB OUT

Connect an external monitor to this connection to view the “RGB IN” input.

N AUDIO OUT

This jack outputs the audio signal from computer & audio signal to external audio equipment.

P Slot for Kensington Micro Saver Security System

Built-in Security Slot

This security slot supports the MicroSaver® Security System. MicroSaver® is a registered trademark of Kensington Microware Inc. The logo is trademarked and owned by Kensington Microware Inc.

Arrangement

1. Before installation, make sure that the projector is turned off and the power cord is disconnected.
2. Do not set up and move the projector, while it is hot.
3. The distance between the projector and screen determines the actual image size. Refer to the table below to determine the screen size at a given distance.

Note: The dimensions in the table below are approximate.

4:3

Image size (inch)	Distance (cm)	Offset(cm)
50	61.0	7.62
60	74.0	9.10
70	87.0	10.60
80	100.0	12.20
90	113.0	13.70
100	126.0	15.20
110	139.0	16.76

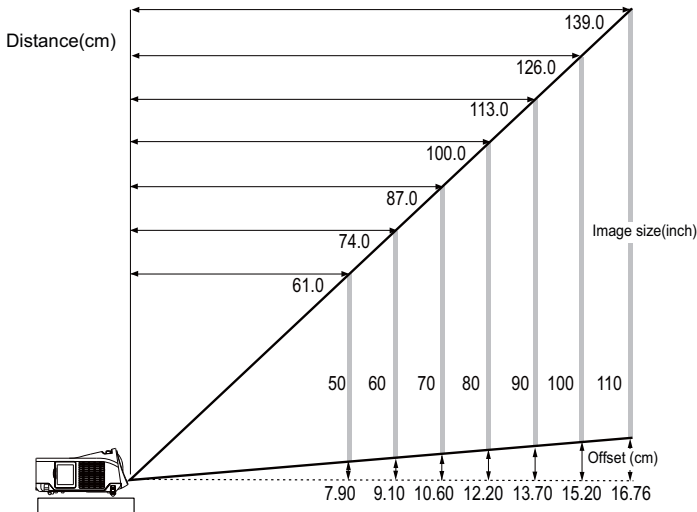

When installed against a wall, leave about 20cm (7.9in.) between the projector and the wall. Please see the detail of the minimum required space on page 6.

Setting Up

Power ON / OFF

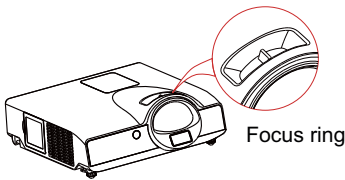
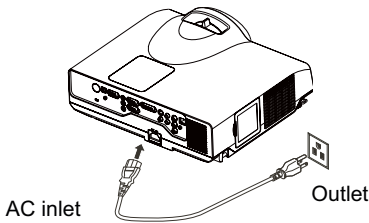

Turning On The Power

1. Make sure that power cord is firmly and correctly connected to the projector.
2. The green Power indicator blinks slowly.
3. Remove the lens cover.
4. Press POWER button on the Touch Keypad or the remote control to turn on the projector.
5. Rotate the focus ring to adjust the focus.

WARNING

- ★ A strong light is emitted when the projector's power is on. Do not look into the lens of the projector or look inside of the projector through any of the projector's openings.

1.

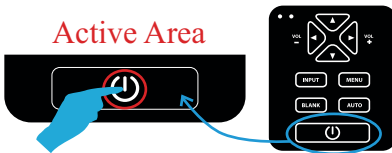

2.



3.-4.

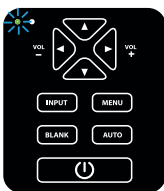

5.

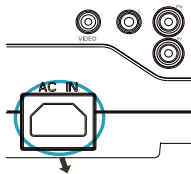

Turning Off The Power

1. Press the POWER button on the Touch Keypad or the remote control. The "power off" confirmation message will appear.
2. Press the POWER button again while the message is shown on the screen.
3. When the projector enters "Standby" mode, the green Power indicator blinks slowly.
4. The projector cannot be turned on while red "Lamp indicator" is blinking slowly in cooling mode.
5. If you don't use the projector for a long time, remove power cord.

WARNING

- ★ Do not touch around the lamp cover and the exhaust vents during use or just after use, since it is too hot.

CAUTION

- ★ Do not turn off the AC power for 120 seconds after the lamp is turned on. Doing so could cause premature lamp failure.

Setting Up

Setting Up The Projector

The projector supports the following four different projection methods.

1. Front projection

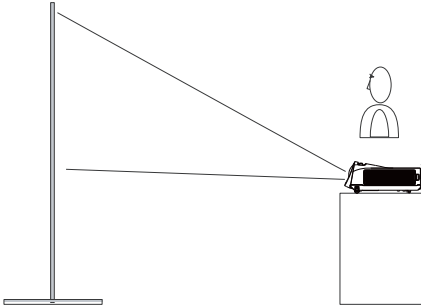

2. Rear projection

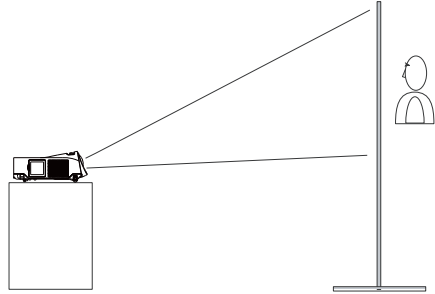

3. Rear ceiling projection

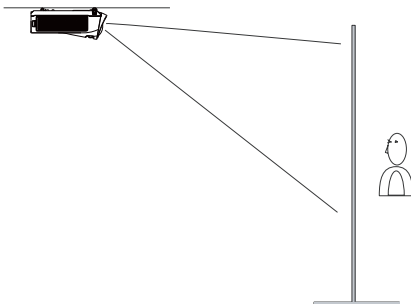

4. Front ceiling projection

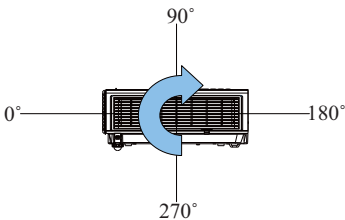
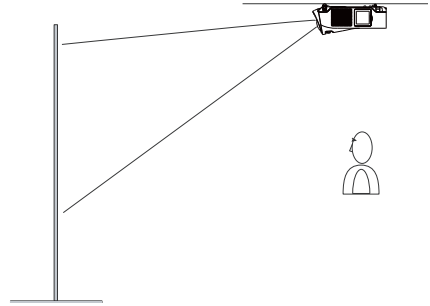

The projector can be installed pitched by any angle (360 degree) without any setting in fan mode. As for rolling it must be within 10 degree.

Special installation is required in order to suspend the projector from the ceiling. Please ask your dealer for details.

Ceiling Mounted Installation Guide

Attach ceiling mount at four-suspension bracket fixing points when suspending from a ceiling. Special installation is required in order to suspend the projector from the ceiling. Please ask your dealer for details.

MAX M4x8 mm For Mounting

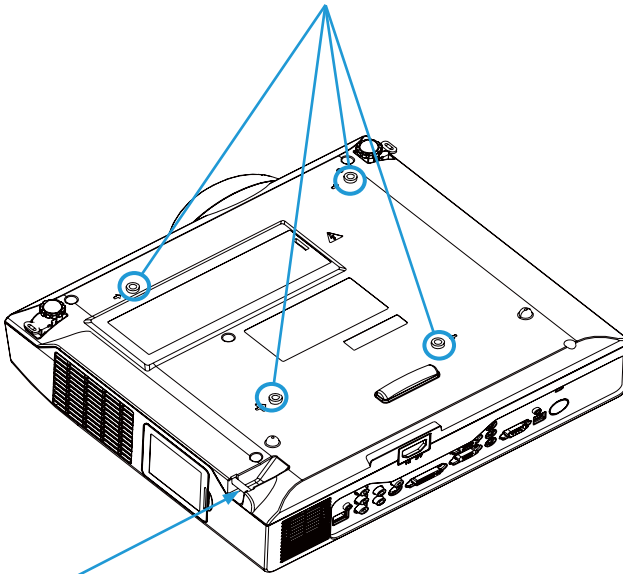

Security Anchor

The product is equipped with security anchor and PIN LOCK (See page 33 for details) functions to help prevent unauthorized removal of the projector.

WARNING

- ▶ Do not grasp the security anchor to carry projector, since it is not designed for it.
- ▶ The security anchor is not for comprehensive theft prevention measures. It is intended to be used as supplemental theft prevention measure.

Adjusting The Projector's Elevation

Use the adjustable foot at the front of the projector to set the image height.

- 1 Holding the projector, push the foot adjust buttons to loosen the front adjustable foot.
- 2 Position the front side of the projector to the desired height.
- 3 Release the foot adjust buttons in order to lock the front adjustable feet.
- 4 Please make sure that the front adjustable feet are locked.
- 5 Please rotate the adjustable feet when fine adjustment of tilt is needed.

CAUTION

- * The adjustment range of front adjustable foot is 0 to 7 degrees.
- * When the feet are adjusted, it may cause the shape of the projected image to become distorted. Use the keystone correction function to correct this distortion.

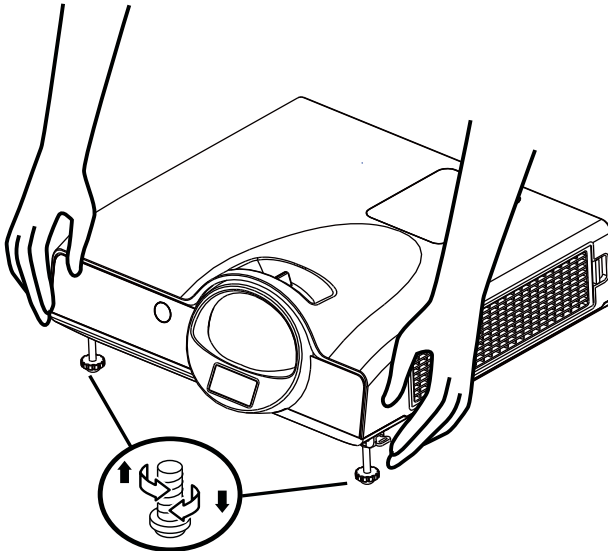

How To Connect

Laptop or desktop computer

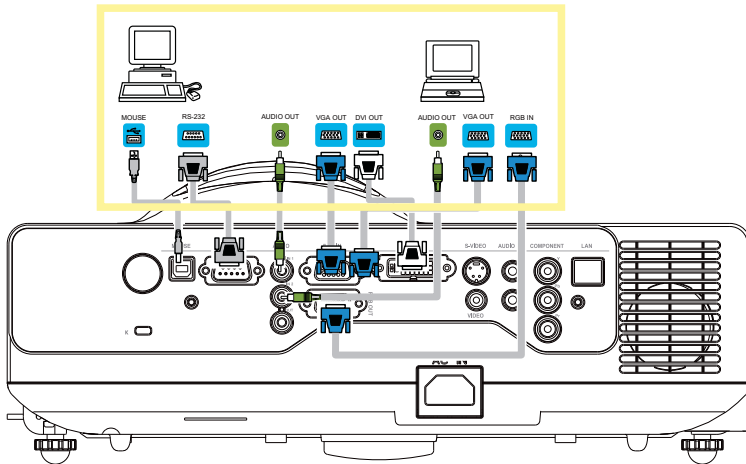

Speaker or DVD Player

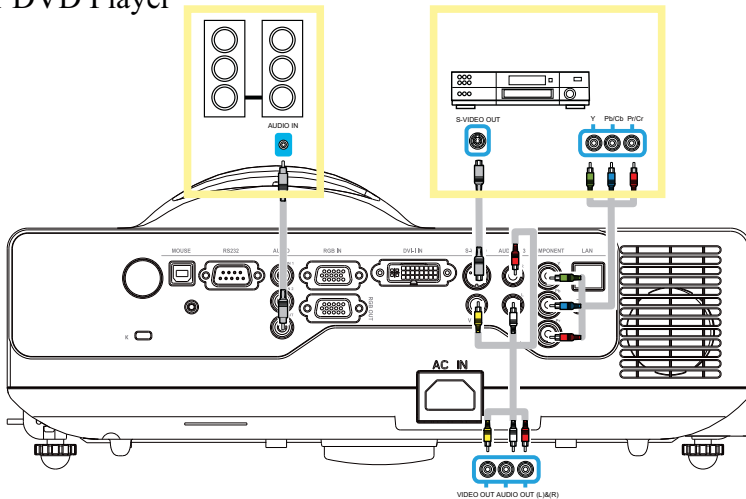

Before starting, make sure that the projector and computer are both turned off.

Connect the computer

Connect the computer cable from the computer to the projector's RGB IN or DVI-I IN. Connect a computer cable from the MONITOR OUT to an external monitor to view the signal on RGB IN or DVI-I IN. Tighten the screw on all connectors. Connect the supplied USB cable from computer to the projector's MOUSE for interactive function.

How To Connect

Laptop or desktop computer

Connect the audio cable if necessary

1. Please connect the audio cable to the AUDIO IN 1 if the computer cable is connected to the projector's RGB IN.
2. Please connect the audio cable to the AUDIO IN 2 if the computer cable is connected to the projector's DVI-I IN.
3. Please connect the audio cable to the AUDIO IN 3 if the video cables are connected to the VIDEO / S-VIDEO / Component port of the projector.

 If the selected video image is not displayed after the projector is turned on and the correct video source has been selected, please check whether the video source device is turned on and operating correctly. Also check whether the signal cables have been connected correctly.

 Many laptop computers may need to change the setting for monitor output when connecting to the projector. Usually a key combination like **Fn + F3** or CRT/LCD key turns the external display on / off. Locate a function key labeled CRT/LCD or a function key with a monitor symbol on the laptop. Press Fn and the labeled function key simultaneously. Refer to your laptop's documentation to find out your laptop's key combination.

Remote Control Batteries Installation

1. Remove the battery cover.
2. Load the batteries.
Make sure the poles are correctly oriented.
3. Close the battery cover.

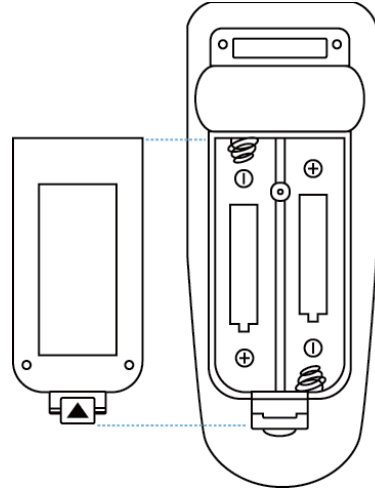

Caution

- ▶ Avoid excessive heat and humidity.
- ▶ Do not drop the remote control.
- ▶ If the remote control will not be used for an extended period, remove the batteries.
- ▶ Do not expose the remote control to water or moisture. This could result in malfunction.
- ▶ Replace the battery when remote control operation becomes sluggish or unresponsive.
- ▶ Do not place the remote control close to the exhaust ventilation opening of the projector, because the exhaust air is hot.
- ▶ Do not use batteries of different types at the same time.
- ▶ Do not mix a new battery with used one. Make sure the plus and negative terminals are correctly aligned when loading batteries.
- ▶ Dispose of batteries in accordance with environmental laws of your area.
- ▶ Do not disassemble the remote control. If the remote control needs service, please contact your dealer.
- ▶ The batteries (battery pack or batteries installed) shall not be exposed to excessive heat such as sunshine, fire or the like.

Remote Control

POWER

Power on / operation mode, Standby mode, Cool down mode.

INPUT

Select input source :



Note :

If the projector can not be captured the signals within 15 minutes, it will be shut down automatically.

MENU

Display or hide the On-Screen Display main menu page.



Press or to select On-Screen Display menu item.



Press or to select and adjust the function of On-Screen Display menu item or value.

LASER

Aim the remote control at the screen, press and hold button to activate the laser pointer.

MUTE

Mute audio.

Keystone +/-

Adjusts the vertical keystone function.

Vol +/-

Sound louder or lower.

AUTO

Refresh the current image.

BLANK

Hide the current image, become black color on the screen.

ESC

Press "ESC" button, it will close "Menu" picture.

Still

Keep the current image on the Screen.

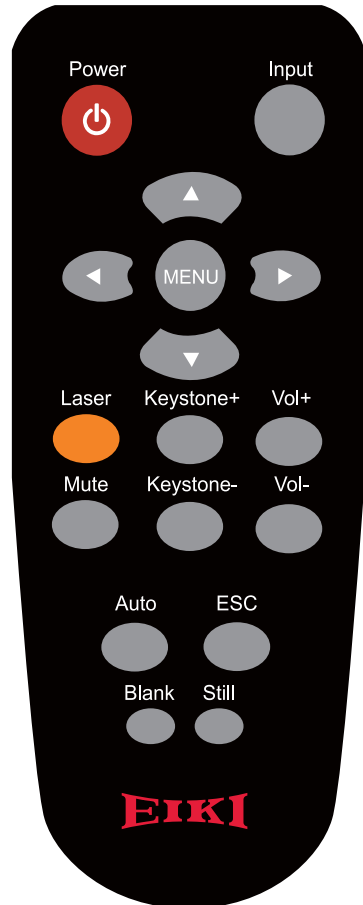

Menu Operation

How To Operate On-Screen Display

1. Press "Menu" button. Following menu will appear.
2. Press up / down / left / right button on touch keypad or remote control to select item or adjust value.



Up / Down / Right / Left button

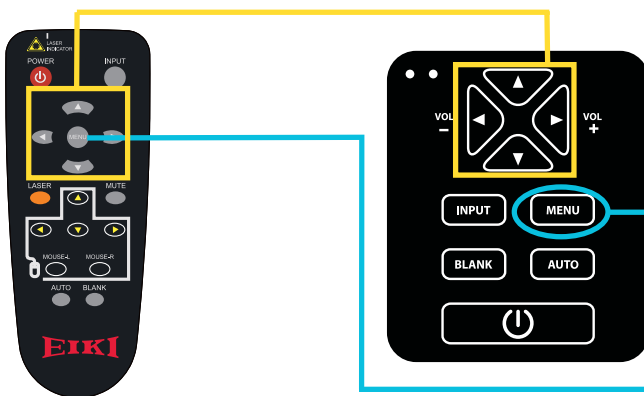

Menu button

Picture Menu

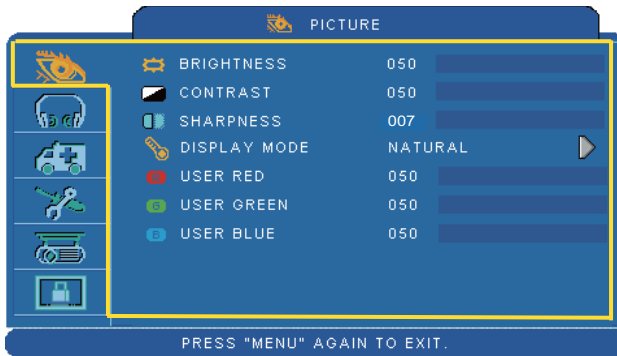

Step:

1. Use the ▲ / ▼ buttons to select an item.
2. Use the ◀ / ▶ cursor buttons to select an item or adjust the value.

Item	Selection	Description
BRIGHTNESS	000/100	Adjust the image brightness level.
CONTRAST	000/100	Adjust the image contrast level.
SHARPNESS	000/015	Adjust the image sharpness.
DISPLAY MODE	NATURAL	Natural color.
	CINEMA	Enhance contrast ratio when displaying DVD contents.
	DAYLIGHT	Suitable when ambient light is strong.
	GREEN BOARD WHITE BOARD BLACK BOARD	Adjust the color settings to make the projected image on a (green, white, black) board more visible.
	USER	User Red 000/100 User Green 000/100 User Blue 000/100

*Only USER mode in Display mode USER RED/GREEN/BLUE can be adjusted.

*The setting data in this Picture Menu is not shown correctly if no signal is fed and projected.

Audio Menu

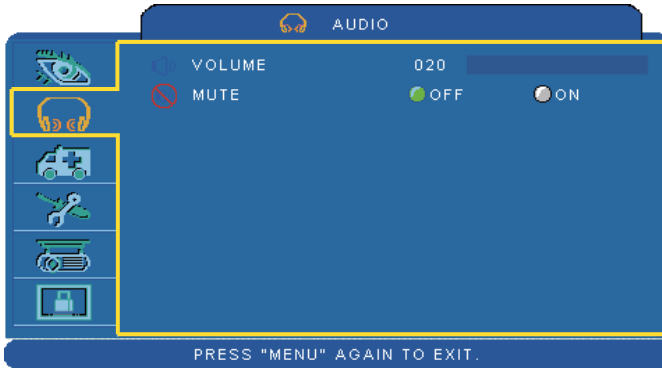

Step:

1. Use the ▲ / ▼ buttons to select an item.
2. Use the ◀ / ▶ buttons to select an item or adjust the value.

Item	Selection	Description
VOLUME	00/40	Adjust the volume.
MUTE	OFF/ON	Mute the volume OFF / ON.

Setting Menu



Step:

1. Use the ▲ / ▼ buttons to select an item.
2. Use the ◀ / ▶ buttons to select an item or adjust the value.

Item	Selection	Description
H POSITION	000/100	Move the image position horizontally. This function can be used under computer signal input only.
V POSITION	000/100	Move the image position vertically. This function can be used under computer signal input only.
PHASE	000/100	Adjust the image sharpness.
FREQUENCY	000/200	Set the horizontal scanning frequency.
AUTO KEYSTONE	OFF/ON	Correct keystone distortion in image automatically.
KEYSTONE V	-70/+70	Correct vertical keystone distortion in image manually.
AUTO SYNC	EXECUTE	Set all of the above setting automatically.
AUTO SEARCH	OFF/ON	Search signal source manually or automatically.
KEYPAD BEEP	OFF/ON	Turn the Beep of Keypad OFF / ON.

* H POSITION, V POSITION, PHASE, FREQUENCY and AUTO SYNC does not work for Digital RGB signal.

* The setting data in this Setting Menu is not shown correctly if no signal is fed and projected.

Picture Menu



Step:

1. Use the ▲ / ▼ buttons to select an item.
2. Use the ◀ / ▶ cursor buttons to select an item or adjust the value.

Item	Selection	Description
BRIGHTNESS	000/100	Adjust the image brightness level.
CONTRAST	000/100	Adjust the image contrast level.
SHARPNESS	000/015	Adjust the image sharpness.
COLOR	000/100	Adjust the strength of whole color. This function can be used under video signal, S-Video signal, or component video signal input only.
TINT	000/100	Adjust the image tint. This function can be used under video signal, S-Video signal, or component video signal.
DISPLAY MODE	NATURAL	Natural color.
	CINEMA	Enhance contrast ratio when displaying DVD contents.
	DAYLIGHT	Suitable when ambient light is strong.
	GREEN BOARD WHITE BOARD BLACK BOARD	Adjust the color settings to make the projected image on a (green, white, black) board more visible.
	USER	User Red 000/100 User Green 000/100 User Blue 000/100

*Only USER mode in Display mode USER RED/GREEN/BLUE can be adjusted.

*The setting data in this Picture Menu is not shown correctly if no signal is fed and projected.

Audio Menu

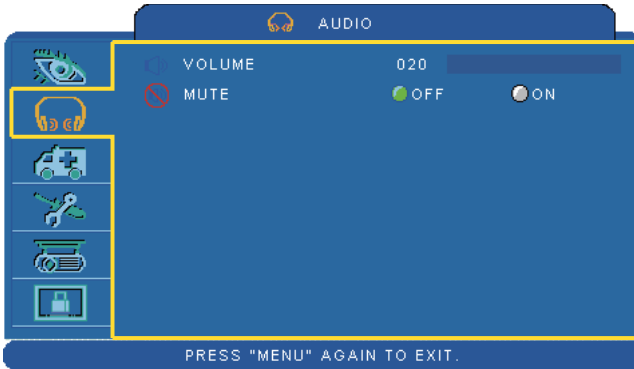

Step:

1. Use the ▲ / ▼ buttons to select an item.
2. Use the ◀ / ▶ buttons to select an item or adjust the value.

Item	Selection	Description
VOLUME	00/40	Adjust the volume.
MUTE	OFF/ON	Mute the volume OFF / ON.

Setting Menu



Step:

1. Use the ▲ / ▼ buttons to select an item.
2. Use the ◀ / ▶ buttons to select an item or adjust the value.

Item	Selection	Description
AUTO KEYSTONE	OFF/ON	Automatically Correct keystone distortion in image.
V KEYSTONE	-70/+70	Correct vertical keystone distortion in image manually.
AUTO SEARCH	OFF/ON	Search signal source manually or automatically.
KEYPAD BEEP	OFF/ON	Turn the Beep of Keypad OFF / ON.

Advanced Menu



Step:

1. Use the ▲ / ▼ buttons to select an item.
2. Use the ◀ / ▶ buttons to select an item or adjust the value.

Item	Selection	Description
ZOOM / PAN	EXECUTE	Execute digital zoom and pan function.
FREEZE	OFF/ON	Freeze the current image on the screen.
BLANK	OFF/ON	Hide the image. Display on the screen turns into black.
BLANK POWER OFF	15/30/60 Minute	Set power off time after "Blank".
RESET	EXECUTE	Reset all menu function to their factory default values.
RESIZE		4:3, 16:9, 1:1
LANGUAGE	ENGLISH	Select the language of the menu and on screen display message. ▶ English → 繁體中文 → 简体中文 → 日本語 → 한국어 Italiano ← Deutsch ← Français ← Dutch ← ▶ Polski → Português → Русский → Español قىـبـرـع ← ไทย ← Українська ← Svenska ←
SELECT SOURCE	EXECUTE	Select the input source from: ▶ RGB 1 → RGB 2 → DVI-I S-Video ← Video ← Y,Pb,Pr ← The search starts from the current port. When an input is found, the projector will stop searching and display the image.
LOGO SETTING	EXECUTE	Customize the start-up logo. IMPORTANT: To implement Logo setting function, please enter PIN code first. Without inputting the PIN code, you cannot modify Logo setting function.

Advanced Menu



LOGO SETTING

This function allows you to customize the start-up logo.

In order to access this page PIN code is required.

Item	Selection	Description
LOGO MODE	DEFAULT	Select Mode(► cursor button)
	USER	The factory logo.
	OFF	The image you captured. The blank image. You can select color with background function.
LOGO CAPTURE	EXECUTE	Start to capture the image.(PC mode only)
BACKGROUND	BLACK BLUE WHITE	Set background color.
LOGO SIZE	ORIGINAL FULL	Display the captured image in original size and put in the center of the screen. Expand the image to full screen.

Advanced Menu

Logo Capture

How to use this function?

- 1 Select Logo Capture item in the logo setting menu, then press ► button.
- 2 Red frame will appear to select captures area.
- 3 Use 4 direction buttons to adjust the position of the frame.
- 4 Press "MENU" to start capturing and display a dialog.

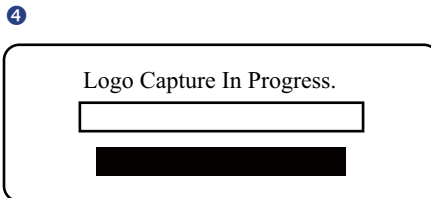
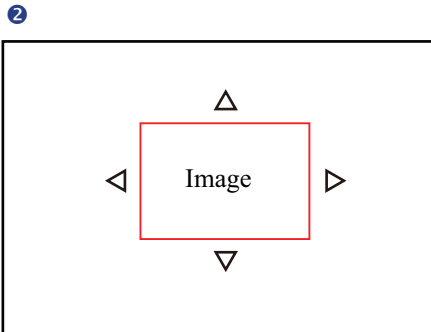

NOTE ► You can capture an image only in computer mode.
► The area that can be captured is 512 x 384 dots.

Presentation Menu

Step:

1. Use the ▲ / ▼ buttons to select an item.
2. Use the ◀ / ▶ buttons to select an item or adjust the value.



Item	Selection	Description
AUTO CEILING	OFF / ON	Automatically invert the image when the projector is turned upside down, i.e. when the projector is mounted on the ceiling.
FRONT	EXECUTE	Normal projection mode.
CEILING	EXECUTE	Mirror the image vertically, only for the projector mounted upside down.
REAR	EXECUTE	Mirror the image horizontally, only for projecting onto rear projection screen.
CEILING AND REAR	EXECUTE	Mirror the image horizontally and vertically. Projecting onto a rear projection screen while projector is upside down.
LAMP MODE	POWERFUL / NORMAL	Switch lamp mode between normal or ECO mode.
LAMP		Show lamp used time.
RESET LAMP TIMER	EXECUTE	After changing a new lamp, execute this function to reset the lamp timer.
Power Management	15/30/60/off Minites	Set power off time after detecting no signal.

Presentation Menu

Reset Lamp Timer

The lamp timer is the time counted after the last resetting. The usage time of the lamp is shown in the PRESENTATION Menu. Select the “RESET LAMP TIMER” if the lamp timer is required to reset. The dialog of “Reset Lamp Timer ?” is shown on the screen as below. To reset the lamp time, select “yes” of Lamp Reset and push the button on the top cabinet.

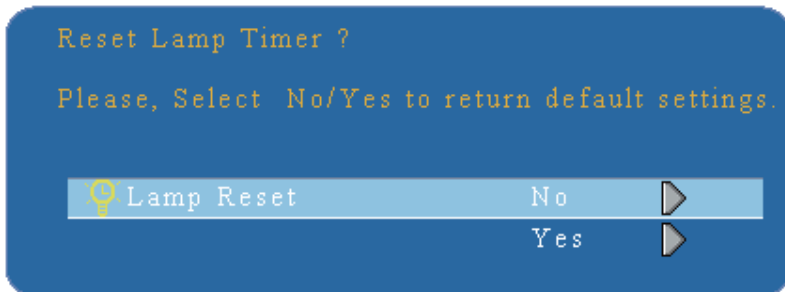

NOTE

- ▶ The replacement warning message is set to appear after about 2500 hours of lamp use in order to maintain the initial brightness. When replacement message appears, replace the lamp with a new one as soon as possible, even if the lamp is still workable.

Security Menu



Step:

1. Use the ▲ / ▼ buttons to select an item.
2. Use the ◀ / ▶ buttons to select an item or adjust the value.

Item	Selection	Description
PIN LOCK PROTECTION	OFF ON 1 ON 2	<p>OFF: Turn off PIN lock protection.</p> <p>ON 1: After plugging in AC power, you need to key in PIN code at the first time of use. If the AC power stays unplugged, you do not need to key in PIN code next time when you use the projector.</p> <p>ON 2: You need to key in PIN code every time when you turn on the projector.</p> <div style="border: 1px solid black; padding: 5px; margin-top: 10px;"> <p>⚠ CAUTION: Once the PIN code had been set, the projector cannot be used unless you enter the correct PIN code.</p> </div>
MODIFY PIN	EXECUTE	<ol style="list-style-type: none"> 1. Press " MENU " on the projector or remote control. 2. Use the ▶ button to select the MODIFY PIN item in the SECURITY category. 3. Press the ▶ button to change PIN LOCK PROTECTION mode. 4. Please enter the original PIN code. <ol style="list-style-type: none"> (a) If the PIN is correct, system will allow you to change a new PIN code. (b) If the PIN is incorrect, a " Code Error " message will appear. 5. Please enter a new PIN code. And then enter again to confirm. <div style="border: 1px solid black; padding: 5px; margin-top: 10px;"> <p>NOTE:</p> <ol style="list-style-type: none"> (1) To change the PIN lock protection state, you must enter the PIN code first. (2) Please enter: 0000 for first-time use. (3) To avoid unnecessary trouble, if you activate the [PIN Lock Protection], it is highly recommended that you write down the PIN code and store it in a safe place. </div>

Security Menu



Step:

1. Use the ▲ / ▼ buttons to select an item.
2. Use the ◀ / ▶ buttons to select an item or adjust the value.

Item	Selection	Description
FILTER TIMER		Show the filter use time.
RESET FILTER TIMER	EXECUTE	Reset the filter timer after cleaning / changing filter.
FILTER COUNTER	500 hours 800 hours 1000 hours	Select (500 / 800 / 1000 hours) depending on the environment.(default : 500 hours). Please see next page.
MAC ADDR.		For LAN control module, "MAC ADDR." will be shown in "SECURITY" Menu. MAC address stands for unique Media Access Control address of LAN control module and displays with six groups of two hexadecimal digits.
CLOSED CAPTION	OFF(Default) C.C1 C.C2 C.C3 C.C4 T1 T2 T3 T4	The Closed Caption function intimates the sound effects, dialogue, and narration in the content of the television program or video source. Caption (C.C1~C.C4) : Display closed caption Text (T1~T4) : Display text data, which is for additional information such as news reports or a TV program guide. NOTE : This function is available only in Video / S-Video source.
LAN MODULE	OFF ON	Select ON/OFF to turn on/off LAN control feature.
LAN SETTING	EXECUTE	Enter LAN SETTING to set up projector network configuration.

Security Menu

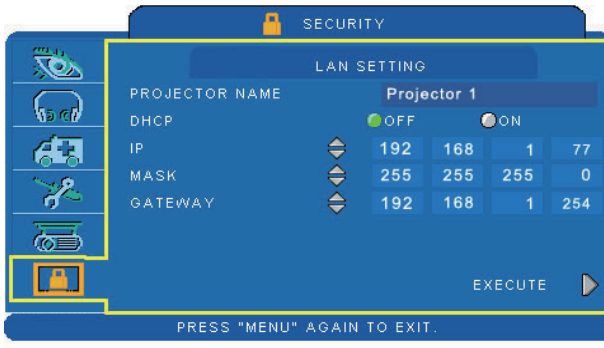

Step:

1. Use the ▲ / ▼ buttons to select an item.
2. Use the ◀ / ▶ buttons to select an item or adjust the value.

Item	Selection	Description
PROJECTOR NAME	Default is Projector	Projector network setting display which shows bits that can be recognized by ASCII.
DHCP	OFF / ON	When setting ON, projector's IP address will be assigned by DHCP server automatically. When setting OFF, you can use remote control to do setting manually.
IP		Key in IP address manually. Press "ENTER" to do digit setting. When appears, press ▲ / ▼ to adjust value. When finishing value adjustment, press MENU to exit.
MASK		Enter MASK address manually. Press "ENTER" to do digit setting. When appears, press ▲ / ▼ to adjust value. When finishing value adjustment, press MENU to exit.
GATEWAY		Enter GATEWAY address manually. Press "ENTER" to do digit setting. When appears, press ▲ / ▼ to adjust value. When finishing value adjustment, press MENU to exit.

Auto Filter Alert

Auto Filter Alert in SECURITY category shows the air filter use time and alerts user to change filter. When the operating time reaches the set time, a warning message will appear on the screen to remind user of filter cleaning /replacing.

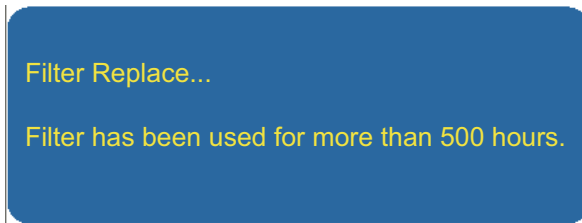

NOTE

► Please reset the Filter time only when you replace the filter.

PIN Key In Operation

When the projector is turned on and the PIN LOCK PROTECTION is set to [ON], the image will show as on the right side.

1. Press the MENU button on the projector or remote control. Enter PIN code by keypad or remote control.
2. How to enter a PIN code?
You can use control panel or remote control.

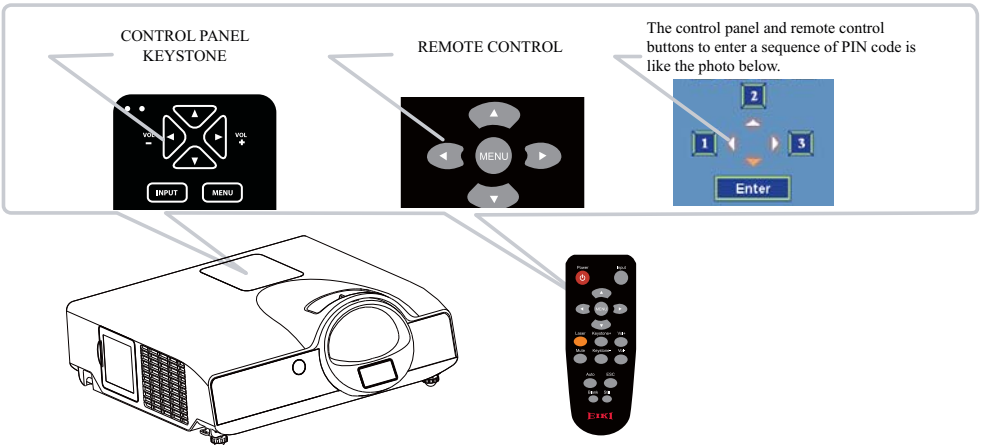
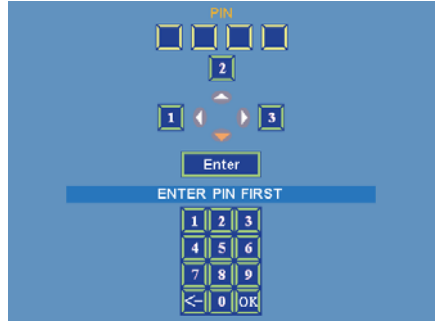

Refer to photo below to enter a sequence of PIN code by touch keypad or remote control buttons.

- (1) Press ◀ button: Select the [1]
- (2) Press ▲ button: Select the [2]
- (3) Press ▶ button: Select the [3]
- (4) Press ▼ button: Select the [Enter] to move to next row.(4~6,7~9, ◀~OK)
- (5) Press ◀ (backspace) item:
In case you enter a wrong digit, select ◀ to delete the wrong digit you entered.
- (6) Press OK item:
Once all four digits of the PIN are entered, select OK to confirm.

NOTE

- (1) Please enter: 0000 for first-time use.
- (2) If the PIN is incorrect, a "Enter new code" message will be shown. Please try again. If the PIN code input is incorrect for three times, a warning message will show up and the projector will shut itself down in 30 seconds.
- (3) If you have no idea about the PIN, please contact your dealer for help.

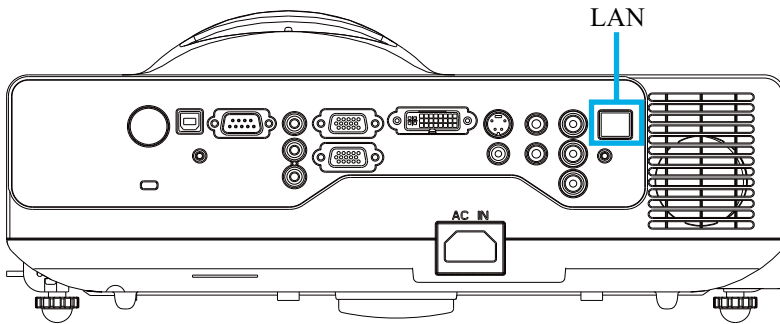

Procedure to utilize this function

Network Control is provided in visual interface, it can help user to monitor and manage the projector(s) status in the local area network.

1. Register the projector(s) which needs to be controlled.
" Auto search " can help you to seek the projector(s) source easily.
After registering in the work group, you can start to control the projector.
2. Group the projector(s) into different sections.
You can monitor the status easily by the sort of group name function in the network.
3. Monitor the status for each projector.
 - a. You can manage and change the monitoring content by System Parameter Setting.
 - b. The Lamp timer, filter working time or system warning feedback etc. can be known by checking the status for projector(s).
4. Control the booked projector(s).
The status can be refreshed and acquired by monitoring functions; you can also operate the function easily by Network Control.

NOTE:

To monitor and control the projector(including stand-by mode), the following conditions need to be ready:

- (1) Projector should already be powered on.
- (2) Projector is connected to network.
- (3) LED light of the projector network port shows normal. (Green light on, Orange twinkle)

* Stand-by mode indicator: Green LED (Power) on the projector's touch keypad flashes.

Network Control Software Application

Before Using Network Control Software

1. If the system is Windows 2000, XP or Vista, the PC should be started by the Administrator.
2. Before starting the Network Control software, please check the following.
 - (2-1) The computer must have Network Control software installed.
 - (2-2) The projector should be powered on and the LAN wire is well connected to projector.
 - (2-3) The LAN module ON/OFF item in SECURITY menu of OSD should be setting ON.
 - (2-4) Make sure the computer and projector can connect to network. Network Control software needs to arrange in TCP/IP network communication and the network cable.

NOTE:

IE8 browser & 1024x768 viewing resolution is recommended.

Network Control Software Application-Browser Control

There are two ways to connect to the network control: Browser Control and Software control.

Browser Control

Auto IP address setting (DHCP setting is "ON"):

- (1) Enable DHCP from the projector on-screen-display menu, under "SECURITY \ LAN SETTING".
- (2) Please wait for the PC server to release IP address to the projector.
- (3) Enter "Given IP address (For example http://192.168.1.176/)" into the address bar of the web browser and press "Enter" key or click "Go" button.



PROJECTOR NETWORK CONTROL

status	control	network	alert	schedule
STATUS				
IP Address	192.168.1.147			
System Status	Standby			
Projector Name	Projector			
Group Name	Group			
Lamp Hours	0 hrs			
Filter Hours	0 hrs			
Input Status	inactive			
Date (y/m/d)	10/30/01			
Time	03:02			
MAC address	00:26:47:1b:00:d1			

Network Control Software Application-Browser Control

Item Setting description:

ITEM SETTING	DESCRIPTION
Status	Show current projector status and network configuration settings.
Control	Select projector's detailed setting from this page.
Network	Set up network configuration and password from this page.
Alert	Show and setup Alert configurations.
Schedule	Show and set up Schedule, including Weekly Schedule and Specific Day.

If the Administrative & User password is enabled, select your User Name and enter password to login.



ADMINISTRATOR MODE

adminstrator name: admin
default password: 0000

USER MODE

user name: user
default password: 1234

Network Control Software Application-Browser Control

Status :

Show current projector status and network configuration settings.

PROJECTOR NETWORK CONTROL

status	control	network	alert	schedule
STATUS				
IP Address	192.168.1.147			
System Status	Standby			
Projector Name	Projector			
Group Name	Group			
Lamp Hours	0 hrs			
Filter Hours	0 hrs			
Input Status	inactive			
Date (y/m/d)	16/09/01			
Time	03:02			
MAC address	00:26:47:1b:09:d1			

ITEM SETTING	DESCRIPTION
IP Address	Show current IP address.
System Status	Show if projector is Power On or Inactive *.
Projector Name	Show projector name.
Group Name	Show group name.
Lamp Hours	Show lamp used hours on current projector.
Filter Hours	Show filter used hours on current projector.
Input Source	Show current input source.
Date(y/m/d)	Show date set on current projector.
Time	Show time set on current projector.
MAC Address	Show current MAC Address.

* When system status shows "Inactive", it could either mean the projector is "Stand By Mode".

Network Control Software Application-Browser Control

Control:

Select projector's detailed setting from this page.

The screenshot shows a web-based control interface for a projector. At the top, there is a 'CONTROL' header. Below it, several tabs are visible: BASIC, PICTURE, SETTING, AUDIO, and PRESENTATION. The BASIC tab is active, showing options for Projector Name, System Status, Power Switch, Input Source, Date, and Time. The PICTURE tab shows settings for Brightness, Contrast, Sharpness, Color, Tint, and Display Mode. The SETTING tab includes Keystone, Auto Search, and Auto Sync. The AUDIO tab has Volume and Mute options. The PRESENTATION tab shows Projection and Lamp Mode settings. Each setting is accompanied by a slider or dropdown menu, and some have 'EXECUTE' buttons.

ITEM SETTING	DESCRIPTION
Basic	
Projector Name	Show projector name on the current projector.
System Status	how if projector is Power On or Inactive .
Power Switch	Power On or Power Off the projector via network.
Input Source	Select input source.
Date Setting	Update date setting on the projector. Click "Submit" button to update the settings.
Time Setting	Update time setting on the projector. Click "Submit" button to update the settings.
Picture	
Brightness	Adjust the image brightness level.
Contrast	Adjust the image contrast level.
Sharpness	Adjust the image sharpness.
Color	Adjust the strength of whole color. This function can only be used under Video signal, S-Video signal, or component video signal input.
Tint	Adjust the image tint. This function can be used under Video signal, S-Video signal, or component video signal.
Display Mode	Adjust Natural/Cinema/Daylight/Green Board/White Board/Black/User Mode.
Audio	
Volume	Adjust the volume.
Mute	Mute the volume OFF / ON.
Setting	
V Keystone	Manually correct vertical keystone distortion in image.
Auto Sync	Set all of the above setting automatically. (This function can only be used under PC mode)
Auto Search	Search signal source manually or automatically.
Advanced	
Freeze	Freeze the current image on the screen.
Resize	4:3,16:9, 1:1, 16:10
Reset	Reset all menu function to their factory default values.
Presentation	
Projection	Select Front/Ceiling/Rear/Celing and Rear
Lamp Mode	Switch lamp mode between normal or ECO mode.

Network Control Software Application-Browser Control

Network :

Set up network configuration and password from this page.

NETWORK

NETWORK	PASSWORD : ADMIN
DHCP Enable: <input checked="" type="radio"/> ON <input type="radio"/> OFF	Administrator <input checked="" type="radio"/> ON <input type="radio"/> OFF
IP Address : <input type="text" value="192.168.1.147"/>	New Password : <input type="password"/>
Subnet Mask : <input type="text" value="255.255.255.0"/>	Confirm Password : <input type="password"/>
Gateway : <input type="text" value="192.168.1.254"/>	<input type="button" value="Submit"/>
DNS Server : <input type="text" value="192.168.1.246"/>	
Group Name : <input type="text" value="Group"/>	
Projector Name : <input type="text" value="Projector"/>	
<input type="button" value="Submit"/>	
PASSWORD : USER	
	User <input checked="" type="radio"/> ON <input type="radio"/> OFF
	New Password : <input type="password"/>
	Confirm Password : <input type="password"/>
	<input type="button" value="Submit"/>

ITEM SETTING	DESCRIPTION
Network	
DHCP	Assign an IP address to the projector from the DHCP server automatically.
IP Address	Set up IP Address when DHCP is disabled.
Subnet Mask	Set up Subnet Mask when DHCP is disabled.
Gateway	Set up Gateway when DHCP is disabled.
DNS Server	Set up DNS Server address when DHCP is disabled.
Group Name	Create projector group. (Max length: 14 characters)
Projector Name	Create projector naming of the current projector. (Max length: 14 characters)
Password:ADMIN	
Administrator	Turn ON/OFF administrative password function.Administrator mode can control the conditions on web.
New Password	Enter administrative password.(Max length: 15 characters)
Confirm Password	Re-enter administrative password.
Password:USER	
User	Turn ON/OFF user password function. User mode only can read the conditions on web.
New Password	Enter user password.(Max length: 15 characters)
Confirm Password	Re-enter user password.

Network Control Software Application-Browser Control

Alert:

Show and setup Alert configurations.

ALERT

EMAIL SETTING	ALERT CONDITION
To : <input style="width: 90%;" type="text"/> CC : <input style="width: 90%;" type="text"/> Subject: <input style="width: 90%;" type="text"/> From: <input style="width: 90%;" type="text"/> Server : <input style="width: 90%;" type="text"/> User Name : <input style="width: 90%;" type="text"/> Password : <input style="width: 90%;" type="password"/> <div style="text-align: center;"> <input type="button" value="Submit"/> <input type="button" value="Issue Test Mail"/> </div>	<input type="checkbox"/> Fan Lock. <input checked="" type="checkbox"/> Over Temperature. <input checked="" type="checkbox"/> Lamp Fail. <input type="checkbox"/> Lamp Time Alert. <input checked="" type="checkbox"/> Lamp Cover Opened. <input type="checkbox"/> Filter Time Alert. <div style="text-align: center;"> <input type="button" value="Submit"/> </div>

When problem occurs to the projector, it will automatically send e-mail to remind user.

How to operate:

1. Enter Email Setting columns.
2. Enter SMTP Setting columns.
3. Select Alert Condition. Multiple choices are fine.
4. Press Submit to confirm.
5. After completing Alert Setting for the first time, it is recommended that you press Issue Test Mail to see if the attendees can receive the e-mail. If the attendees cannot receive the e-mail, please check if the setting is correct or not. If you have questions with the Alert Setting, please contact your network service provider.

ITEM SETTING	DESCRIPTION
Email Setting	
To	Set up the mail alert attendee. (Max length: 40 characters)
Cc	Set up the backup mail alert attendee. (Max length: 40 characters)
Subject	Set up the subject of the alert e-mail. (Max length: 40 characters)
From	Set up the sender e-mail address. (Max length: 40 characters)
SMTP Setting	
Server	To enter the SMTP server (Mail server) name of the company or IP address.(Max length: 40 characters)
User Name	Enter the sender's e-mail address. (Max length: 40 characters) For example: david@xxxxx.com
Password	Enter password of the sender's e-mail account. (Max length: 15 characters)
Alert Condition	
Fan Lock	The cooling fan is not operating.
Over Temperature	The projector internal is over heated.
Lamp fail	The lamp does not light up.
Lamp Time Alert	Lamp has reached its life time. Suggest changing the lamp.
Lamp Cover Opened	Lamp Cover does not close well.
Filter Time Alert	Filter has reached its life time. Suggest cleaning the filter.

Network Control Software Application-Browser Control

Schedule :

Show and set up Schedule, including Weekly Schedule and Specific Day.

Weekly Schedule

SCHEDULE

WEEKLY

Power On Time : 16 : 6
Power Off Time : 16 : 6
Week : Sunday
Input Source : R G B 1

No.	Week	Power On	Power Off	Input Source	Cancel
1	Sa	10:0	16:20	VIDEO	<input type="button" value="cancel"/>
2					<input type="button" value="cancel"/>
3					<input type="button" value="cancel"/>
4					<input type="button" value="cancel"/>
5					<input type="button" value="cancel"/>
6					<input type="button" value="cancel"/>

To power on and power off projector based on Weekly Schedule.

How to set up:

1. Choose week days.
2. Set up power-on or power-off time.
(Please be sure that the interval between power-on and off setting is more than 5 minutes.)
3. Enter Input Source and select input source.
4. After completing setting, press ADD to confirm.
5. To cancel items, select the item and press "Cancel" button.

Specific Day

SPECIFIC DAY

Power On Time : 2010 / 3 / 26 16 : 0
Power Off Time : 2010 / 3 / 26 16 : 0
Input Source : R G B 1

No.	Power On	Power Off	Input Source	Cancel
1	2010/3/26 19:10	2010/3/26 19:58	D V 1	<input type="button" value="cancel"/>
2				<input type="button" value="cancel"/>
3				<input type="button" value="cancel"/>
4				<input type="button" value="cancel"/>
5				<input type="button" value="cancel"/>
6				<input type="button" value="cancel"/>

Based on Specific Day to set up power-on and power-off time.

How to set up:

1. Choose power-on days and time.
2. Choose power-off days and time.
(Please be sure the setting period between power-on time and off time is greater than 5 minutes.)
3. Enter Input Source and select input source.
4. After completing setting, press ADD to confirm.
5. To cancel items, select the item and press "Cancel" button.

Software Control

Activate Network Control Software

- 1 Execute the Network Control Software.

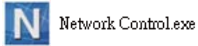

- 2 Monitor window below appears.

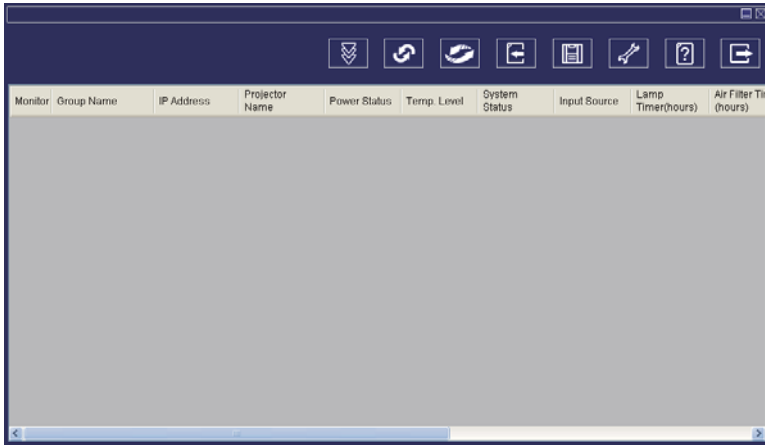

<Graph 1>

Network Control Software Application-Software Control

Projector Auto Search.

- 1 Click the  (Projector search), then the Search Window below appears.

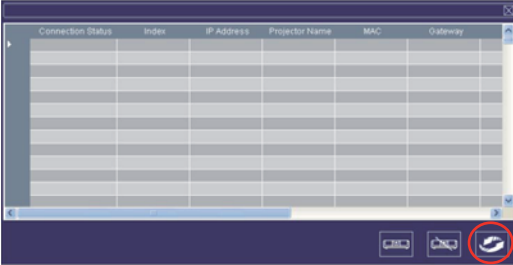

<Graph 2>

NOTE

If the security warning window appears, please select "Unblock" to allow the Network Control software to work.

- 2 Click  (search again), then the target projectors will be listed as follows.

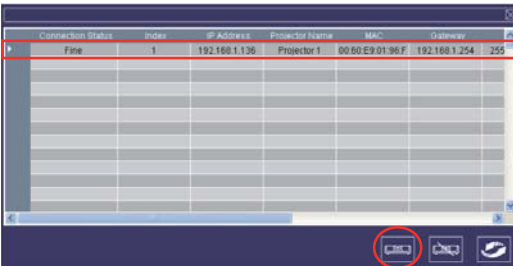

<Graph 3>

NOTE

If there is no projector found on the display window, the following maybe the causes:

1. There is no DHCP server available on the LAN. The LAN module is shipping with DHCP-configured client enabled in default.
2. If there is no DHCP server available on the LAN. The LAN module default IP address should be 169.254.1.1. Please modify the PC/Laptop IP address setting to make the PC/Laptop IP address located on the same segment as 169.254.xxx.xxx and try again .

Modify The Projector Setting

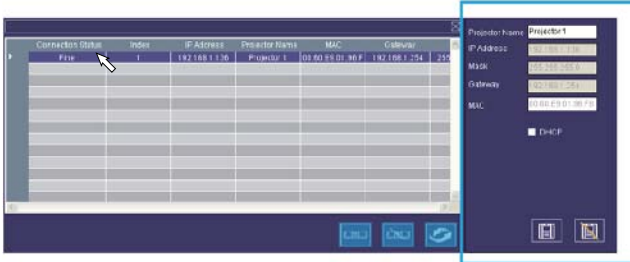

- 1 If you need to modify the projector's setting, please move mouse cursor to the table on the left and press button on the column. The contents of the setting will appear on the right side table.



< Graph 5 > : Register Table.

Note

When DHCP setting is changed, in order to make the change effective AC power to the projector needs to be disconnected and reconnected.

- 2 After changing the projector setting, you can save the data by clicking  button or cancel by clicking  button.

Item	Description
Projector name	Show the Host name. (16 characters at most in ASCII.)
IP Address	Show the IP Address.
Mask	Show the Subnet Mask.
Gateway	Show the Gateway.
MAC	Show up the MAC Address. (The default value can not be modified.)
DHCP	Capture IP address from network Server automatically.

< Table 1 > : Setting Windows.

- 3 Click  (register projector), then the projectors will be shown in the Monitor Window as shown below.

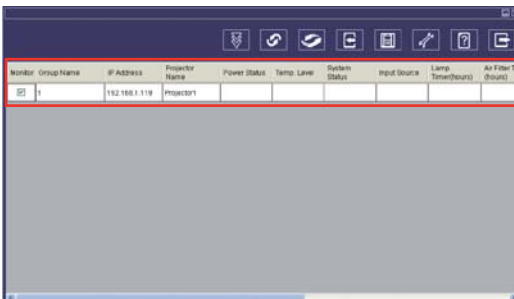



<Graph > Monitor window

Sorting the projectors

- Projector can be sorted easily by clicking the monitor window title (Group Name) or (Projector Name).

Monitor	Group Name	IP Address	Projector Name	Power Status	Temp. Level	System Status	Input Source	Lamp Timer(hours)	Air Filter Tim(hours)
<input checked="" type="checkbox"/>	1	192.168.1.136	Projector 1						
<input checked="" type="checkbox"/>	1	192.168.1.137	Projector 2						
<input checked="" type="checkbox"/>	1	192.168.1.138	Projector 3						
<input checked="" type="checkbox"/>	1	192.168.1.139	Projector 4						

<Graph >

- After registering, you can click  button (Data single capture) in the tool bar or click  button (Start Auto Scan) to update the status.

NOTE

While Auto Scan is running to update the status, the scroll bar for the window is grayed out and the hidden column can not be shown. Therefore before starting Auto Scan place the column in the window by using drag-drop or scroll bar in advance.

Meaning of Status Icons

The following table can be displayed by pressing "  " Help button.

Power Status	Other Message	Input Source
Standby	Can't Get Data	RGB1
Projector On	Data Update	DVI
Cooling	NG	Video
		S-Video
		YPbPr
System Status	Temp. Level	
No warnings	High Temp. Warning	
Fan Error	Extreme High Temp.	
Lamp Error		
Lamp Cover Door Error		
High Temp.	Normal Temp.	

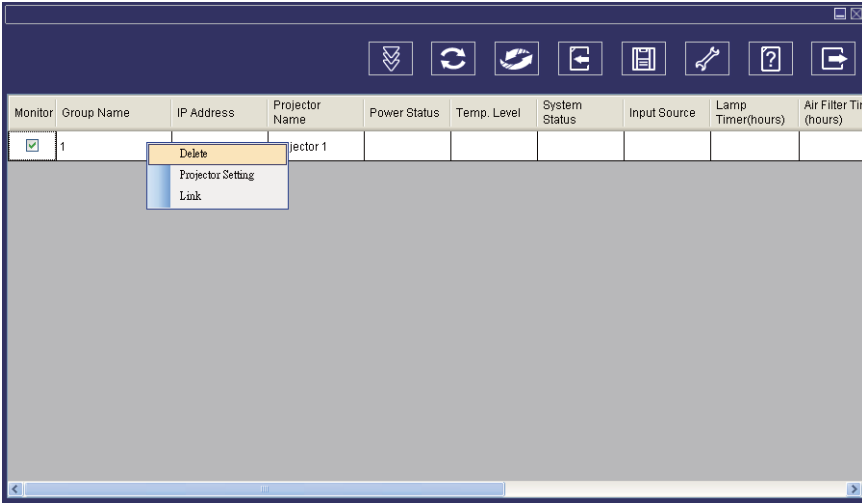

Delete

- 1 Select the registered projector in monitor window. Click mouse right key and select "Delete" to erase the registered projector data.



< Graph 6 > : Register Table.

Projector Setting (Setting for individual projector)

- 1 Select the registered projector in monitor window. Click mouse right key and select "projector setting" to modify the registered projector data. After finishing the setting, you can save by clicking  button or cancel by clicking  button.

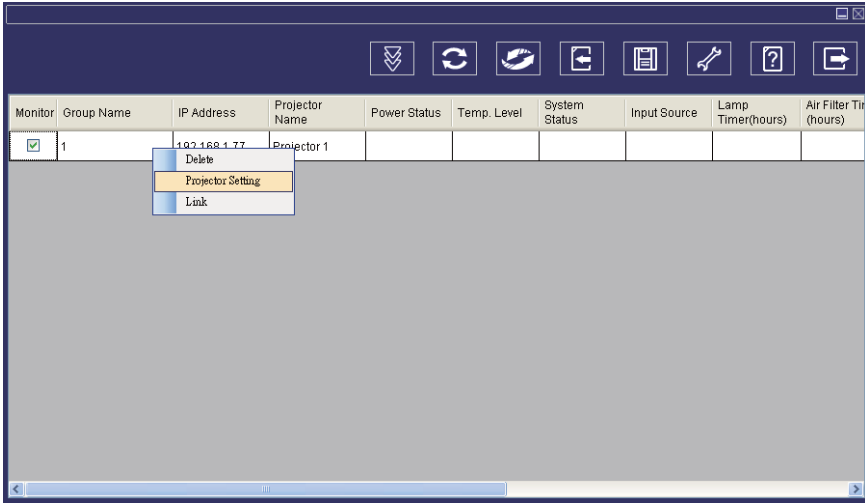

< Graph 7 > : Register table.

Group Name: 1

Projector Name: Projector 1

IP Address: 192.168.1.77

Mask: 255.255.255.0

Gateway: 192.168.1.254

MAC: 00:60:E9:01:C9:85

Monitor Air Filter Alert (hours): 500

DHCP Lamp Timer Alert (hours): 1500

< Graph 8 > :Setting table.

System Setting (Setting for all projectors)

2 Click  button (system setting) to modify system alert setting.

Saving the setting

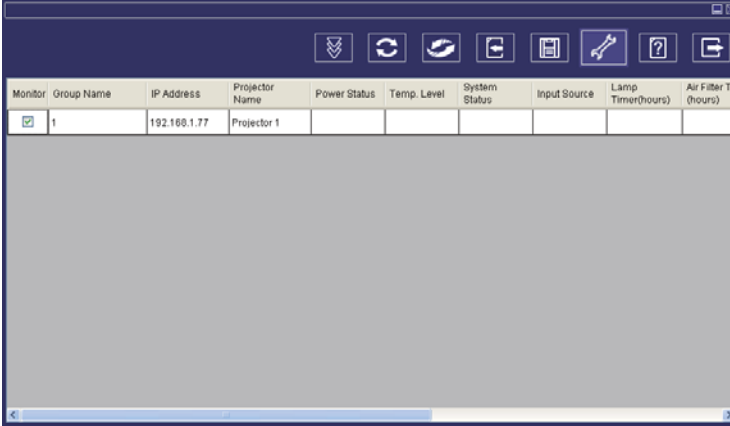

< Graph 9 >

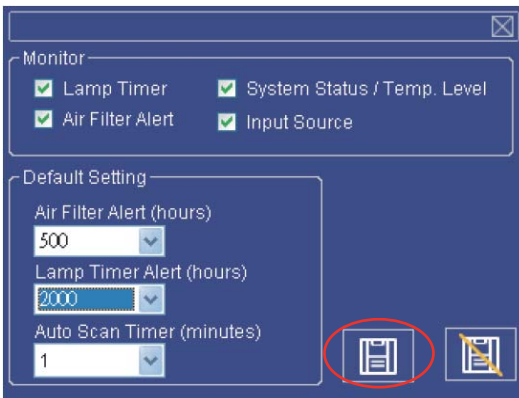

<Graph 10>

Note:

Alert setting in System Setting vs Projector Setting

Whenever the " " Save button is pressed in System Setting, the value becomes effective for all the projectors registered.

After this if the value in Projector Setting is changed and saved, the value becomes effective only for the projector.

System Setting

Monitor

Item	Description
Lamp Timer	Read lamp use time from projector.
Air Filter Alert	Read Air Filter Timer from projector.
System Status/ Tempeture Level	Read System Status and Temperature from projector in Power On status.
Input Source	Read Input Source Selection from projector in Power ON status.

< Table 2 >

Default Setting

Item	Description
Lamp Timer Alert (Hr.)	Default Setting Includes 1000/1500/2000/3000 Hours. When Lamp Timer reaches alert target, window will show lamp timer in red color to remind user to replace the lamp.
Air Filter Alert (Hr.)	Default setting includes 500/1000/1500/2000/2500 Hours. When Filter Timer reaches alert target, window will show filter timer in red color to remind user to replace the filter.
Auto Scan Timer (minutes)	Auto Detect setting. Default setting includes 1/3/5/10 minutes; user can set the optimal default listed in Table 4.

< Table 3 >

Auto Scan Timer

Projector Number (Sets)	Timer Interval (Minutes)
1~25	1/3/5/10
26~50	3/5/10
51~100	5/10
101~255	10<

* The maximum quantity of projector monitored is 255.

< Table 4 >

Network Control Software Application-Software Control

Saving the Project File

Save the Configuration above as Project File by clicking the save button in the Tool bar in the Monitor window before closing Network Control Software.

If it is not saved, all the configuration above will be lost.

From next time after starting this Network Control Software the configuration can be recovered easily by opening the Project File.

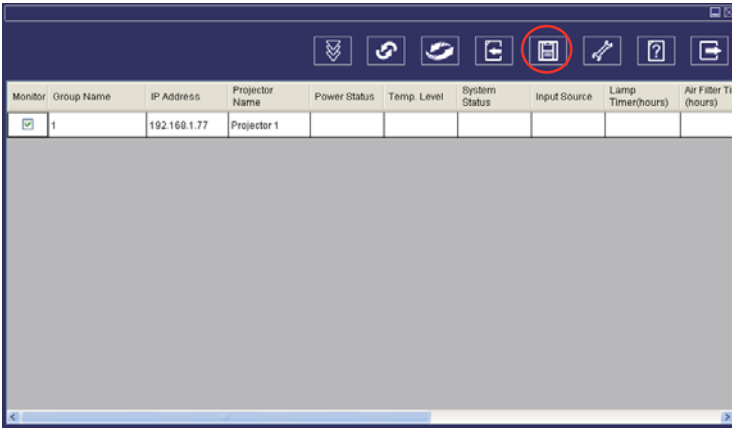

Network Control Software Application-Software Control

Link(Controlling Projector)

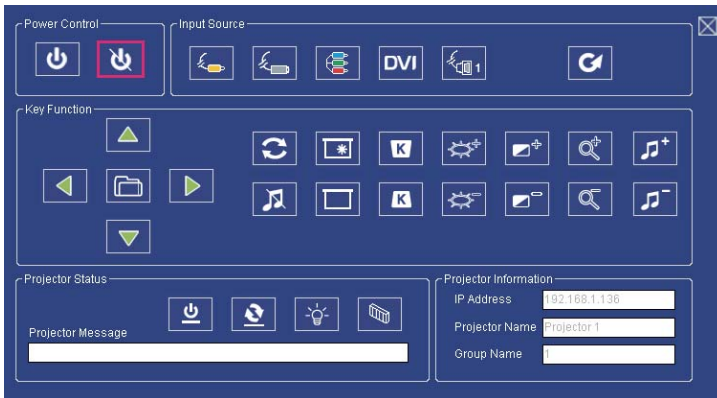
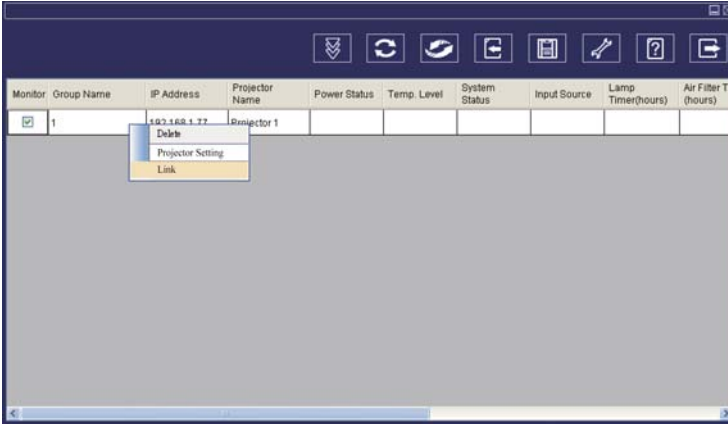

- 3 Select the registered projector in monitor window. Click mouse right key and select "Link" to show the control panel table and the projector connecting status.









< Graph 12 > : The control panel table

Network Control Software Application-Software Control















1 Power Control

Icon	Name
	Power on
	Power off





2 Input Source

Icon	Name
	Video
	S-Video
	Y, Pb, Pr / Y, Cb, Cr
	DVI-I
	RGB 1
	Change Input Source





3 Function Key

Icon	Name	Icon	Name
	Up		Freeze
	Down		Blank
	Left		Keystone Correction +
	Right		Keystone Correction -
	Menu		Increase Brightness
	Auto Sync		Decrease Brightness
	Mute		Higher Contrast

3 Function Key











Icon	Name
	Lower Contrast
	Zoom In
	Zoom Out
	Volume Up
	Volume Down

4 Projector Status

Icon	Name
	System Status
	Input Source Status
	Lamp Timer
	Air Filter Timer

Network Control Software Application-Software Control

1 Network Control Window introduction

Icon	Name	Description
	Scan all	Capture the all registered projectors' information one time only.
	Start Auto Scan	According to the system setting, get the projector information automatically.
	Stop Auto Capture	Stop scanning the projector information.
	Auto Search	Search the projector in the same network to register and modify the setting.
	Open Project File	Open project file which was saved.
	Save Project File	Save the registered projector in this project.
	System Setting	Setting the projector system reminder message.
	About	Icon content description.
	Exit	Exit the Network software.
	Register projector	Register projector's information.
	Exit	Cancel registered information.

Maintenance of Projector

Filter

When a warning message appears to remind you to clean the air filter, please replace a new one as soon as possible. Please check and clean the air filter periodically.

How to clean or replace the filters

Turn off the projector, and unplug the power cord. Wait to allow the projector to cool down sufficiently.

1. Push up the white stopper of the Filter cover and remove it from the side of projector as shown below.
2. Remove the Filter cover by pushing and sliding it as shown below.
3. Clean the filters with a vacuum cleaner except for the back side of the sponge, because the vacuum cleaner may suck it. Brush the sponge gently by a brush. (Do not clean the filters with water.)

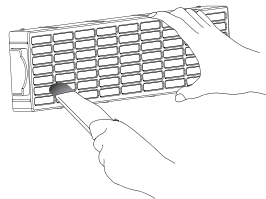
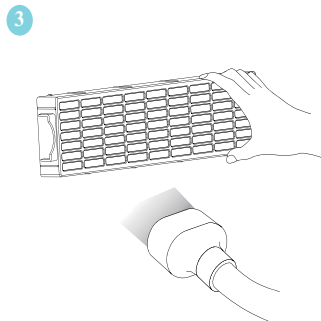
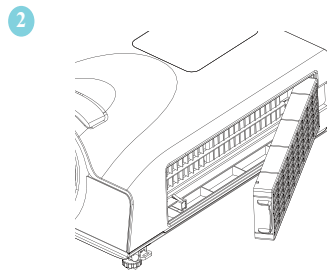
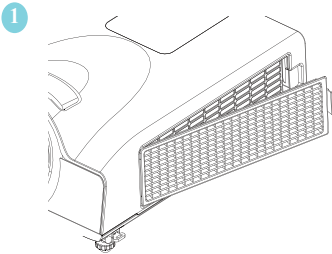

Lamp

Please turn off the projector and unplug the AC power cord. And then, let the projector cool down at least 60 minutes.

Replacing New Lamp(Part Number:23040035)

1. Remove the lamp door.
2. Loosen 2 screws of the lamp holder. Hold the handle on the top of the lamp, pull out the lamp straight off the projector.
3. Insert new lamp, lock the lamp door firmly with 2 screws.
4. Put the lamp door on.
5. Please reset the lamp timer after replacing lamp. (P.32)

When changing lamp, it is recommended that you change the filter at the same time.

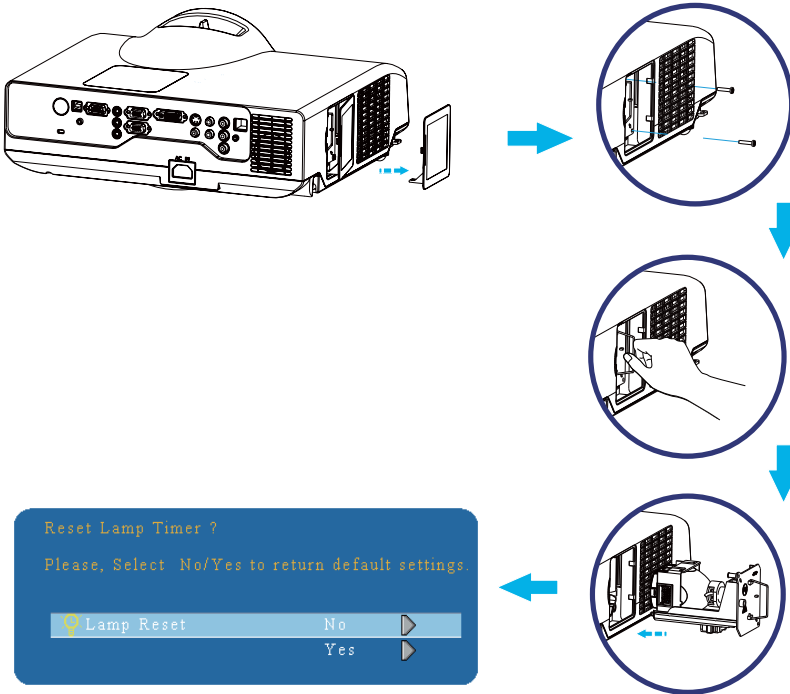



WARNING

The projector uses a high-pressure mercury lamp.

The explosion of lamp with a loud bang or burn out could possibly cause injury or a fire.

When the bulb bursts, it is possible for shards of glass to fly into the lamp housing; and for gas containing mercury to escape from the projector's vent holes.

If the lamp has broken, do not check the inside of the projector. Please ventilate the room immediately.

Do not touch or bring your face close to the broken pieces since it might get into your eyes or mouth. In case of injury, seek medical advice immediately.

Disposal of a Lamp

Dispose of a lamp in accordance with the local recycling laws.

Do not put it to your trash.

Recycling Lamp's laws of the USA, go to www.lamprecycle.org.

Recycling Product's laws of USA, go to www.eiae.org.

Recycling Product's laws of Canada, go to www.epsc.ca.

For more information about recycling laws, please contact local government agency or dealer.

CAUTION HOT

Before replacing the Lamp unit, pay attention to the following items:

1. The Lamp is optional part. Contact the dealer for replacement lamp.
2. The lamp becomes very hot when in use. Turn the power off and disconnect the power cord.
3. Wait for 1 Hour before replacing the lamp.
4. Do not use old lamp unit.

Additional

- In order to ensure the safe use of your projector, please contact your dealer to inspect about once a year.
- Before maintenance, make sure the power cable is unplugged, allow the projector to cool sufficiently. The high temperature state of the projector could cause a burn in and/or malfunction to the projector.
- Never try to maintain the inside of the projector by yourself.

Troubleshooting

Indicator

The power and lamp indicators show the status of the projector. Before requesting repair, check the projector status using the chart below. If the problem cannot be resolved, contact your dealer.

In normal status~~~

POWER	LAMP	CONDITIONS	DESCRIPTION
Blinking In <i>Green</i>	Off	Stand by mode	Projector is ready to be turned on.
Lighting In <i>Green</i>	Off	On mode	Projector is on and operating.
Lighting In <i>Green</i>	Blinking In <i>Red</i> (Slow)	Cool down mode	Projector is in cool down mode and will not respond to user input.
Lighting In <i>Green</i>	Blinking In <i>Red</i> (Fast)	Cool down mode	When the projector is turned on in 2 minutes after it was turned off.

In abnormal status~~~

POWER	LAMP	CONDITIONS	DESCRIPTION
Blinking In <i>Green</i>	Blinking In <i>Red</i> (Fast)	Fan fault mode	The projector has detected a problem of a slow internal fan speed. The lamp will shut off automatically. Contact your dealer.
Blinking In <i>Green</i>	Lighting In <i>Red</i>	Lamp cover open	The lamp cover is open or not closed well. Please check lamp cover again.
Blinking In <i>Green</i> (Fast)	Blinking In <i>Red</i> (Fast)	High temperature	The projector has overheated and shut itself down. Correct the over temperature condition immediately. 1. Check that the ventilation slots are free from obstructions. 2. Check the cleanliness of the air filter.
Blinking In <i>Green</i> (Slow)	Blinking In <i>Red</i> (Slow)	Lamp fail	The lamp does not light. Come to "stand by mode", and press the power button again. If the situation is the same, please contact your dealer.

Troubleshooting

Error For Machine Defects

The following problems may be confused with a machine defect. Check and follow the table. If it couldn't be improved, contact your dealer.

Symptom	Cause / Remedy
Projector power does not turn on	The power cord is disconnected. Plug the power cord into an AC outlet.
	Intending to turn on the projector again during the cool down mode. Wait until the cool down mode has completed.
	There is no lamp and/or lamp cover is not firmly closed. Please turn off the power and disconnect the power plug from the power outlet. Check if the lamp is installed or the lamp cover is firmly closed and turn on the power again.
	Power cord has impaired. When you touch the power cord, the indicator goes on then off, please remove the power cord and connect it again. If the situation is repeated, remove the power cord and contact your dealer.
No Image	The input is not connected correctly. Select the appropriate input source.
	No signal input. Connect correctly.
	The lens cover is attached to the lens. Remove the lens cover.
Colors are pale	Color density and color matching are not adjusted correctly. Adjust the RGB setting.
	Color lose. Caused by poor VGA cable connection.
Abnormal brightness & contrast	Brightness and contrast are not adjusted correctly. Adjust the brightness and contrast setting.
	The lamp is near the end of its service life. Replace with a new lamp.
Image is blurred	The projection lens is not focused. Adjust the focus using the focus ring.
	The lens is dirty or misty. Clean the lens.

Troubleshooting

Error For Machine Defects

Symptom	Cause / Remedy
No audio	The projector is not connected correctly. Check audio cable if connect correctly.
	The volume is set to minimum. Adjust the volume.
	Mute is turned on. Press the MUTE button.
Remote control is not working	No battery. Before using the remote control, please check the battery of remote control.
	Remote signal is obstructed. Remove the obstacle between projector and remote control.

Troubleshooting

List of Supported Monitor Displays

Computer mode / DVI-I mode		
Signal	Refresh Rate (Hz)	Resolution (dots)
VGA	60	640x480
VESA	60 / 72 / 75 / 85	640x480
SVGA	56 / 60 / 72 / 75 / 85	800x600
XGA	60 / 70 / 75 / 85	1024x768
SXGA	70 / 75	1152x864
SXGA	60 / 75	1280x960
SXGA	60	1280x1024
WXGA	60 / 75	1280x800
WXGA+	60 / 75 / 85	1440x900
SXGA +	60 / 75	1400x1050
UXGA	60	1600x1200
WSXGA+	60	1680x1050
MAC	67	1280x1024 / 640x480
MAC	75	832x624
MAC	75	1024x768
MAC	75	1152x870
Component (Y, Pb, Pr/ Y, Cb, Cr)		
Signal	Refresh Rate (Hz)	Resolution (dots)
SDTV(480i / 576i)	30 / 25	720x480 / 720x576
SDTV(480p / 576p)	60 / 50	720x480 / 720x576
HDTV(720p)	60	1280x720
HDTV(1080i / 1080p)	30 / 60	1920x1080
Composite / S-Video		
Signal	Refresh Rate (Hz)	Resolution (dots)
TV(NTSC)	60	720x480
TV(PAL,SECAM)	50	720x576

Technical Specifications

Mechanical Information

Projector Type	Short-Throw Interactive Projector
Dimensions(WxHxD)	360 x 348 x 132 mm
Net Weight	4.1 kg
Feet Adjustment	up to 7°

Panel Resolution

LCD Panel System	0.63" TFT LCD Panel, 3 panels
Panel Resolution	1,024 x 768 dots
Number of Pixels	2,359,296 (1,024 x 768 x 3 panels)

Signal Compatibility

Color System	PAL, SECAM, NTSC
SD/HD TV Signal	480i, 480p, 575i, 575p, 720p, 1080i and 1080p
Input Scanning Frequency	H-sync. 31~92kHz, V-sync. 48~120Hz

Optical Information

Projection Image Size	50"~110" Diagonal
Throw Distance	0.61M~1.39M
Projection Lens	F=1.8 / f=13.78 mm
Projection Lamp	210W Lamp

Interface

Input Terminals	D-SUB 15 pin x 1 DVI-I x 1 Composite Video, RCA x 1 S-Video, Mini Din-4 x 1 Component Video, RCA x 3 3.5mm Mini-Stereo Audio Jack x 2 Audio RCA (Right /Left) x 2
Output Terminals	D-SUB 15 pin x 1 3.5mm Mini-Stereo Audio Jack x 1
Control Terminals	RS232 DB-9 x 1 USB Type B x 1 RJ45 x 1

Audio

Speaker	8W mono speaker built-in
---------	--------------------------

Power

Voltage and Power Consumption	AC100~240V, 50/60Hz(full range)
-------------------------------	---------------------------------

Operating Environment

Operating Temperature	5°C~35°C / 41°F~95°F
Storage Temperature	-20°C~50°C / -4°F~122°F

•The specifications are subject to change without notice.

Appendix

Menu Tree (PC Mode)

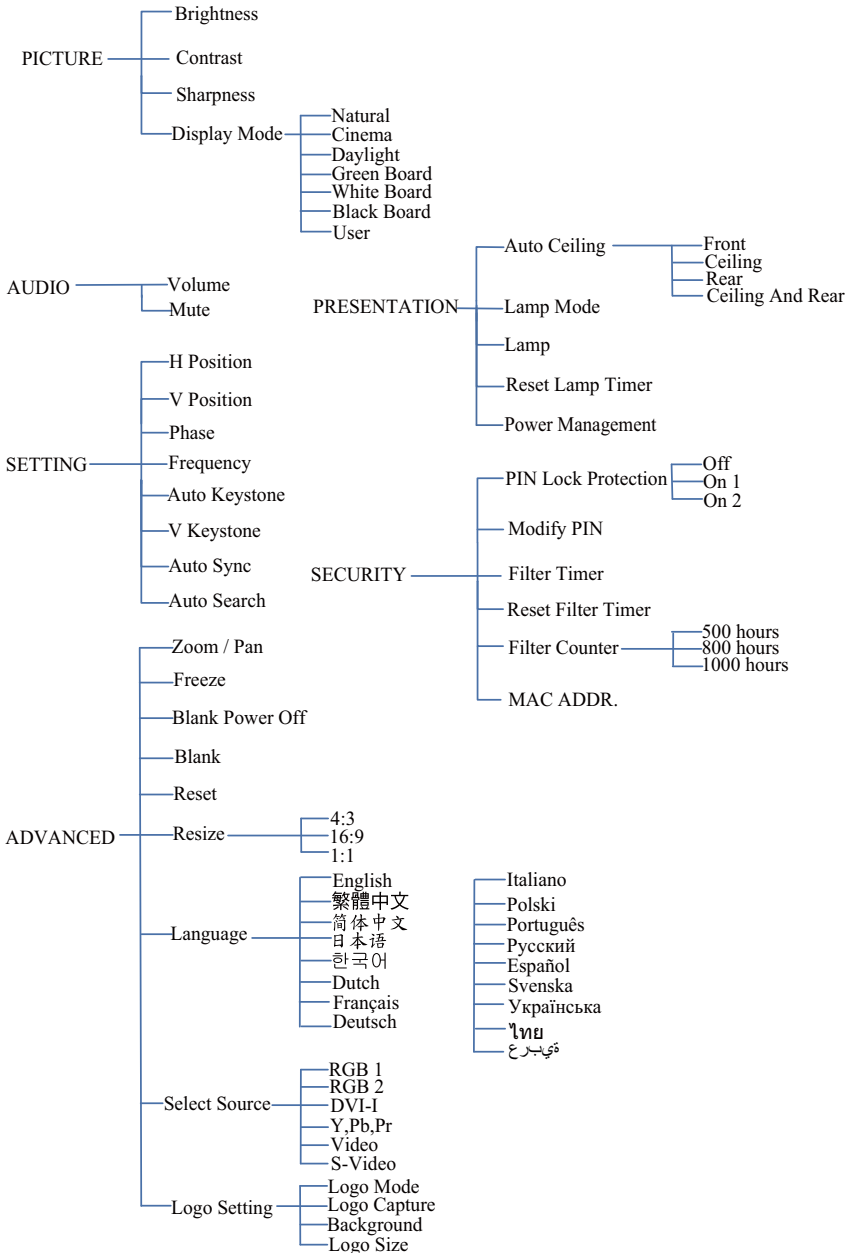

***DVI doesn't support H / V POSITION, PHASE, FREQUENCY, AUTO SYNC function.**

Appendix

Menu Tree (Video Mode)

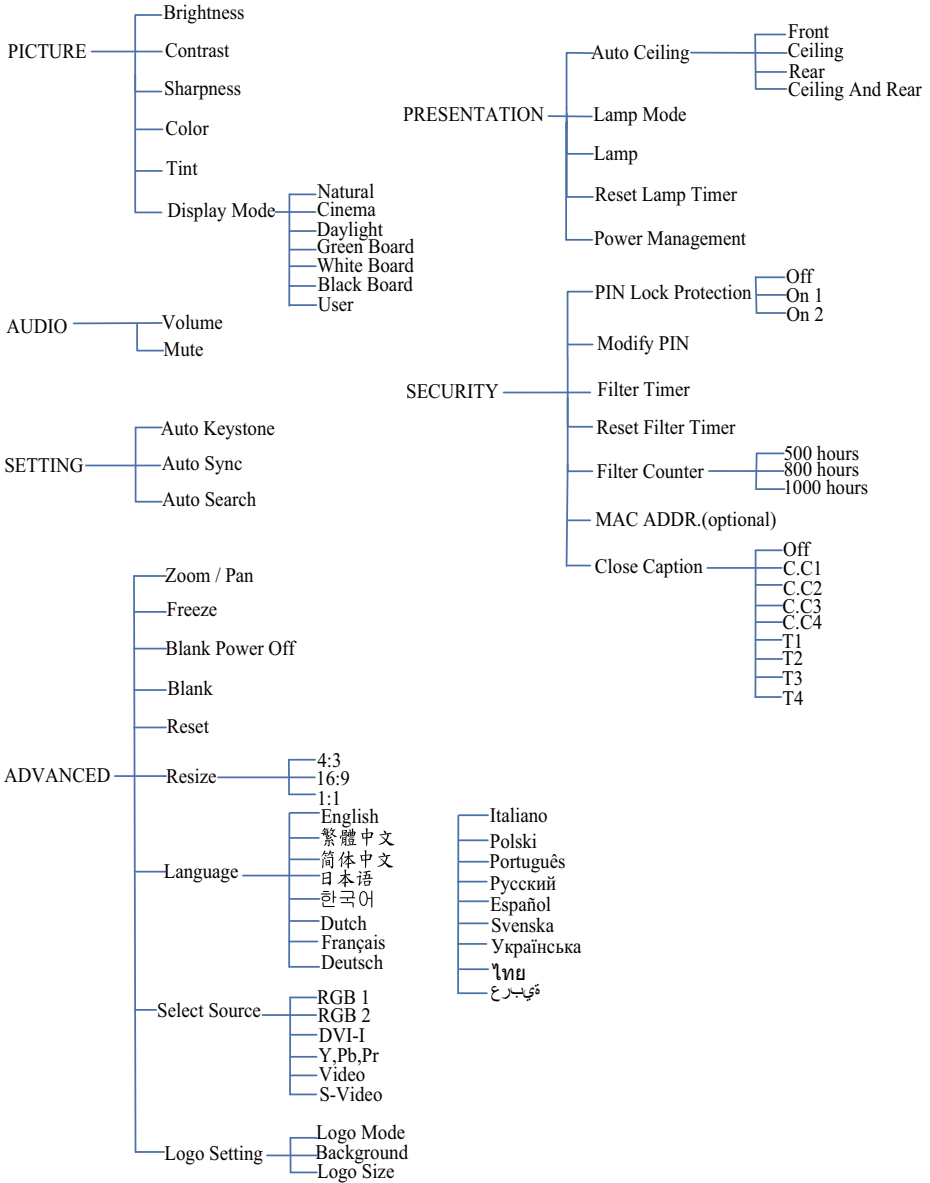

Appendix

Appearance

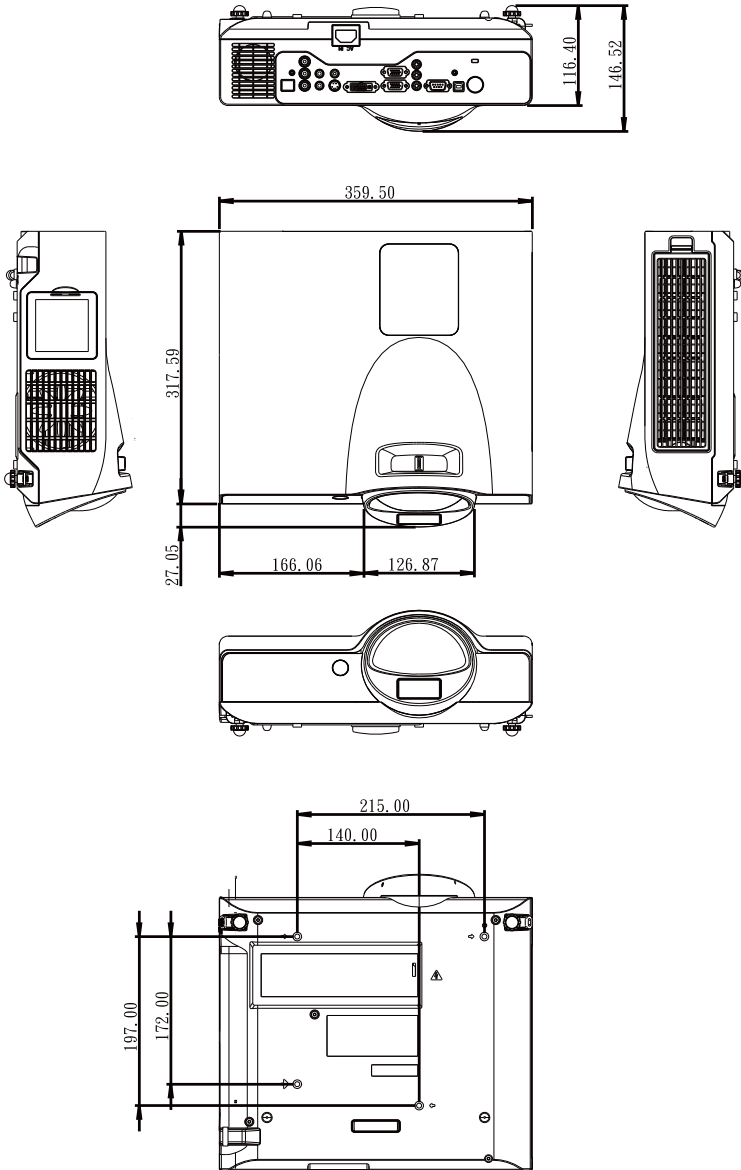

Screw for Ceiling Mounted M4x8mm 4pcs

Appendix

Configurations of Terminal

Analog RGB Input/Output

(1) Connections(15P HD-Sub)

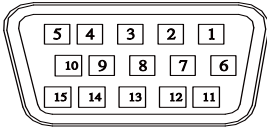

(2) Pin Number Define

Pin NO.	Signal Name	Connection
1	R signal Input	R
2	G signal Input	G/Sync. On G
3	B signal Input	B
4	N.C.	N.C.
5	GND	GND
6	R return(GND)	GND
7	G return(GND)	GND
8	B return(GND)	GND
9	N.C.	N.C.
10	N.C.	GND
11	Signal return(GND)	N.C.
12	DDC data	DDC/SDA
13	HSYNC/TTL/Comp.sync	H
14	VSYNC	V
15	DDC clock	DDC/SCL

(3) Connector

- 15P HD-Sub

(4) Input signal polarity

- Video signal (RGB): Positive
- Sync: Positive, Negative

(5) Input level

- Signal: 0.7V \pm 0.2V p-p 75 Ω terminate, NRZ
- Sync: TTL

(6) Composite Sync.

- TTL:Negative

Appendix

Digital Visual Intergrace(DVI-I)

(1) Connections

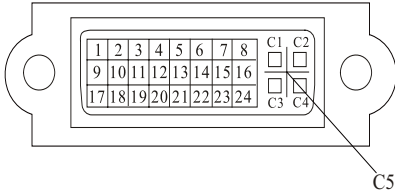

(2) Pin Number Define

Pin NO.	Signal Name	Pin NO.	Signal Name	Pin NO.	
1	T.M.D.S. Data2-	9	T.M.D.S. Data1-	17	T.M.D.S. Data0-
2	T.M.D.S. Data2+	10	T.M.D.S. Data1+	18	T.M.D.S. Data0+
3	T.M.D.S. Data2/4 Shield	11	T.M.D.S. Data1/3 Shield	19	T.M.D.S. Data0/5 Shield
4	T.M.D.S. Data4-	12	T.M.D.S. Data3-	20	T.M.D.S. Data5-
5	T.M.D.S. Data4+	13	T.M.D.S. Data3+	21	T.M.D.S. Data5+
6	DDC Clock/CLOCK	14	5V Power	22	T.M.D.S. Clock Shield
7	DDC Data	15	Ground(for +5V)	23	T.M.D.S. Clock+
8	No Connect	16	Hot Plug Detect	24	T.M.D.S. Clock-
C1	Analog red	C2	Analog green	C3	Analog blue
C4	Analog horizontal sync	C5	Analog ground (Analog R,G,B return)		

Appendix

Component(Y,Pb,Pr/Y,Cb,Cr)

(1) Connections

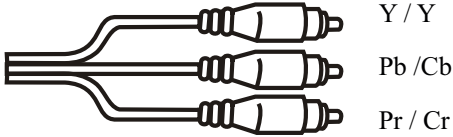

(2) Pin Number Define

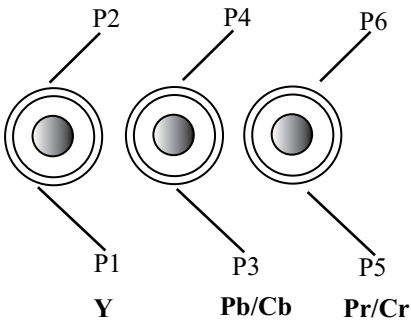

Pin NO.	Signal Name	Connection
2	Y	Y
4	Pb/Cb	Cb
6	Pr/Cr	Cr
1	Signal return(GND)	GND
3	Signal return(GND)	GND
5	Signal return(GND)	GND

(3) Connector:RCA Jack

Appendix

Composite Video Signal

(1) Connections

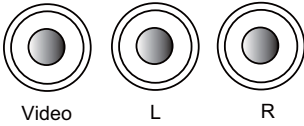

(2) Pin Number Define

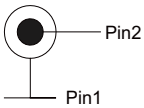

Pin NO.	Signal Name	Connection
1	Video Signal(GND)	GND
2	Video Input	V

(3) Connector: RCA jack

(4) Input signal polarity: Composite signal, Sync: Negative

(5) Input level: Video signal: $1.0V \pm 0.2V$ p-p 75Ω terminate, NRZ

Appendix

S-Video Signal

(1) S-Video Connections and Connector

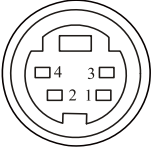

(2) Pin Number Define

Pin NO.	Signal Name	Connection
1	Y Signal(GND)	GND
2	C Signal(GND)	GND
3	Y Signal Input	Y
4	C Signal Input	C

(3) Input signal polarity

- Composite signal sync: Negative

(4)Input level

- Y Signal:1.0V \pm 0.2V p-p 75 Ω terminate, NRZ
- Sync:0.286V \pm 0.1V p-p
- Chromatic:75 Ω terminate, NRZ
- Burst:0.286V \pm 20%

Appendix

RS232 Control

Communication Protocol

Items	Specification
Standard Baud rate	9600 bps
Data length	8 bits
Parity	None
Stop bit	1 bit
Flow Control	None

RS232 Cable Define

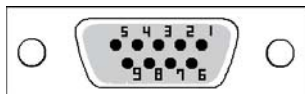

PC Side	Projector side with D-Sub Pin
RX 2	RX 3
TX 3	TX 2
GND 5	GND 5

USB Connector

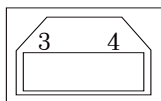

1 2

Pin NO.	Signal Name
1	Data+
2	GND
3	Data-
4	VCC

EIKI

Touchboards

205 Westwood Ave, Long Branch, NJ 07740

Phone: 866-94 BOARDS (26273) / (732)-222-1511

Fax: (732)-222-7088 | E-mail: sales@touchboards.com

WorldWide Website <http://www.eiki.com>