

PERMA-TITE® 2 Plugs & Connectors
PERMA-GRIP™ Plugs & Connectors
PERMA-LINK® Plugs & Connectors
PERMA-WATCH® Plugs & Connectors

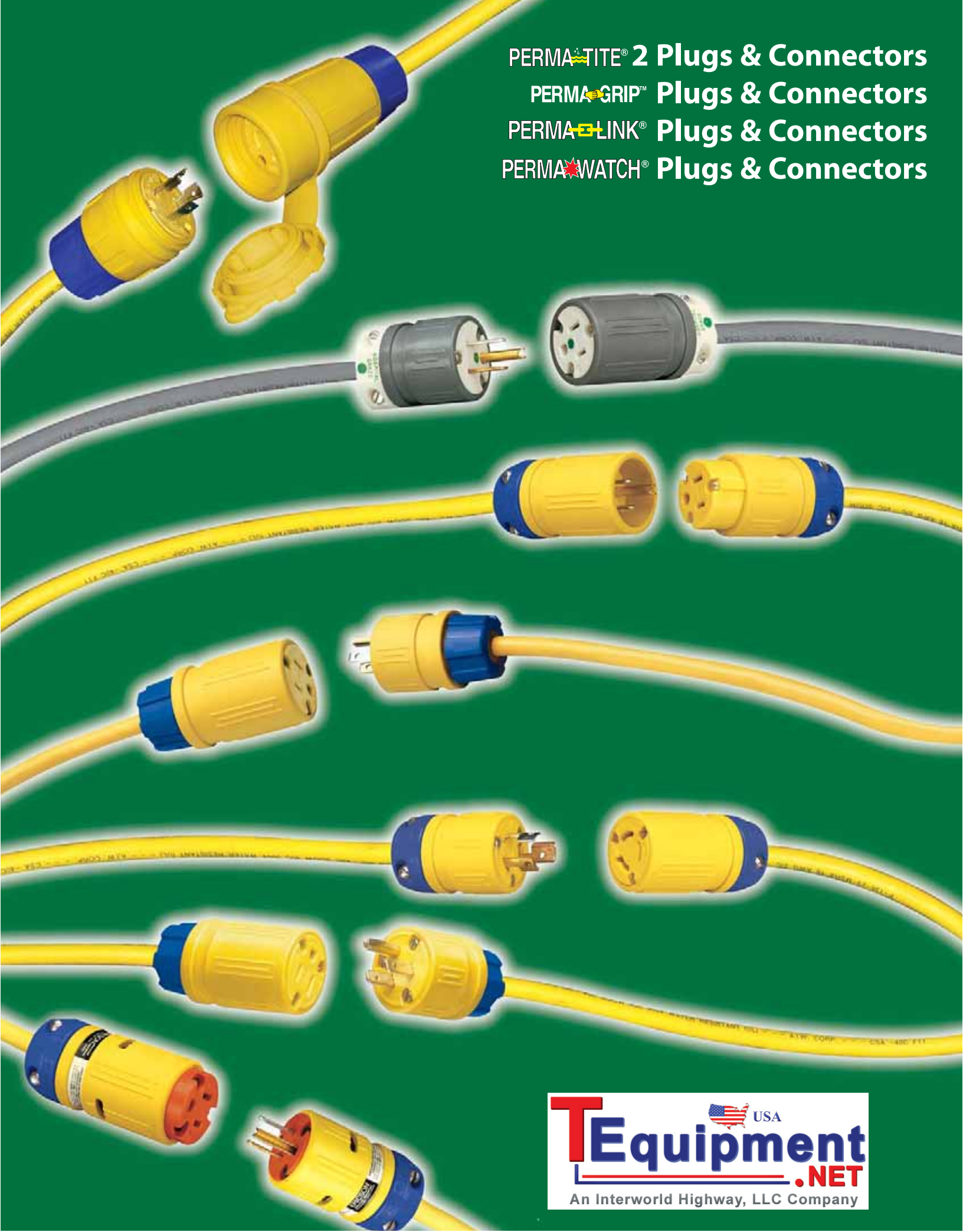

Ericson Manufacturing Company engineers and produces a comprehensive range of plugs and connectors for demanding industrial and construction environments. From the invention of the first "dead-front, back-wired" electrical plug in 1929 and patent in 1936 to present day innovations such as Perma-Tite® 2 devices that are designed to meet or exceed UL & IEC watertight standards. In the following pages you will find:

- Perma-Tite® 2, Perma-Grip™, Perma-Link® & Perma-Watch® plugs & connectors all engineered with:
 - Dead-front, back-wired design
 - Solid brass blades
 - Transparent back-plate for easy inspection of individual wiring chamber
- Captive assembly and terminal screws reduce the risk of losing small parts
- No-Slip elastomeric housing with finger-grips
- Keyed body and housing eliminate mis-alignment
- High visibility Ericson dual-color safety system
- NEMA configurations and a variety of specialty NON-NEMA Devices
- 15Amp, 20Amp, 30Amp and 50Amp models
- Standard voltages from 120Volts through 600Volts
- Easy to use charts and drawings simplify the selection/specification process making it quick and user friendly
- Technical reference information including OSHA regulations and dimensional drawings

PERMA-TITE® 2 Plugs & Connectors

- UL Listed & CSA certified
- NEMA Type 4, 4X, 6, 6P & IP67
- Corrosion resistant nickel plated blades
- Impact, corrosion, crushing and chemical resistant
- High visibility Ericson safety yellow and blue colors

PERMA-GRIP™ Plugs & Connectors

- UL Listed and CSA Certified
- Compression Cord Grip Nut speeds installation by eliminating the need to "screw-down" the cable clamp and eliminates pinching of the cord
- Impact, corrosion, crush proof and chemical resistant
- Ericson "reverse-boot" design for added environmental protection

PERMA-LINK® Plugs & Connectors

- UL Listed and CSA Certified
- Double-lead screws on self-centering cord clamp
- Internal cord seal provides added environmental protection
- Impact, corrosion, crush proof and chemical resistant
- Ericson "reverse-boot" design for added environmental protection

PERMA-WATCH® Plugs & Connectors

- UL Listed
- Continuously monitors ground continuity and wiring conditions from the GCM to the source
- Monitors line-side requirements for OSHA's AEGCP (Assured Equipment Grounding Conductor Program)

Custom Built Devices

As always you can turn to Ericson Manufacturing Company to engineer a solution to your plug & connector application if you do not find a standard catalog item to fit your need. Contact the factory or your local sales representative to find out more.

Plugs & Connectors

Industrial Wiring Device Innovations

Ericson's Industrial Wiring Device Innovations Revolutionized Electrical Safety

Sixty cents. That's what it would have cost in 1918 to purchase one of the first insulating Rubber Handles for one of your Extension Light, or Drop Lights as they were called in those days. The C & E Universal Safety Handle was molded of a heavy duty rubber compound and was designed for use with either keyed or keyless sockets to protect workers from electrical shocks and to add to the service life of the lights. Many lamp guards up to that point were made of wood which proved too fragile to withstand the many industrial uses to which they were put.

C & E was the forerunner of today's Ericson Manufacturing Co., founded by Edward O. Ericson. Ericson pioneered the development of a variety of important safety electrical devices.

Ericson devoted his attention to industrial applications. There was a great need for safe products for workers using electricity. Simple, molded rubber hand lamp handles (which he had patented in 1918) gave way to more sophisticated designs made of a variety of materials, each providing increasingly better electrical safety, durability and price advantages.

Ericson also pioneered in this area, and in 1927 introduced the first Insulated Hand Lamp Guards. The basic guard included a 1/16-in. thick electrolytically bonded insulation coating of the "toughest kind of rubber" that withstood dielectric tests of more than 4,000 volts. They provided a high degree of electrical safety and added to a lamp's service life under the roughest conditions.

Ericson's invention of the first "Dead-Front, Back-Wired" Electrical Plug in 1929 is perhaps the single most important development in the wiring device industry in the past seventy-plus years. U.S. Patent # 2,061,190 was assigned to it in 1936.

Older plugs and connectors had the wiring come through from the back. They were wired in the front end where the connections were visible and were susceptible to damage from moisture, dirt, tools, etc. (Fiber discs, and later plastic discs, were used to cover these wiring areas, but they often came off during use.) The Ericson "Dead-Front, Back-Wired" design placed the wiring connections at the rear of the plug with the front end closed off by a structural member of the device. The blades were held firmly and permanently in alignment.

There were no rivets to loosen or fiber to warp. Connections on the inside were protected. Cord grips kept tension off the terminals. Flexible shanks took the wear off the cord. They were easy to wire in the field. Newer variations are now even quicker and easier to wire: the stripped wires are inserted in holes, where simple screw tightening secures them in place.

Many products available today reach beyond being simple plugs or connectors. They are all, however, dead-front, back-wired devices. Our Perma-Tite® 2 Plugs and Connectors have unique features to protect the internals from moisture, dust and dirt. And covers using new, high tech materials resist chemicals, acids and oils to provide greater service life in extremely hazardous environments.



Plug into history: Before 1929 (top), plug connections were exposed. The first dead-front, back-wired plug created by Ericson (middle) revolutionized the industry, and eventually led to modern plugs (bottom) with such amenities as built-in ground and continuity monitors.

Ericson's Perma-Watch® Plugs and Connectors have built-in Ground and Continuity Monitor Devices to help workers determine at a glance whether their electrical power source's grounding system is safe. The GCM's have internal LED lamps that glow when the line has ground continuity. These devices also can help cut as much as 90% of the cost of maintaining OSHA required records for extension cord sets and temporary job site receptacles.

Ericson's dead-front, back-wired 1929 design is important: both the National Electrical Code and OSHA still require its use.

Plugs & Connectors

Perma-Tite® 2 Devices

NEW!



NEMA TYPE 4, 4X, 6, 6P & IP67

- Excels in demanding outdoor & in-plant environments
- Resists hose directed water, the entry of water during prolonged submersion at a limited depth & damage from external ice formation

Typical Applications

- Food processing
- Pulp and paper mills
- Refineries and Petro Chem Facilities
- Ship yards
- Utilities
- Marine



PERMA-TITE® 2 Plugs and Connectors

Perma-Tite®2 plugs and connectors are engineered and manufactured to the highest quality standards to provide the ultimate in electrical service and protection. They are designed and proven to do their best under the worst conditions in a broad array of the most severe food processing, industrial, marine, construction and petro-chemical work environments.

- UL Listed & CSA Certified
- Tongue & groove sealing system provides environmental protection of:
 - NEMA Type 4, 4X, 6, 6P & IP67
- Devices resist high-pressure hose down of 1,000psi.
- Plug & Connector bodies made with PBT chosen for its high resistance to moisture absorption, high voltage arcing and carbon tracking.
- Keyed body and cover for easy alignment/assembly
- Color coded sealing bushings are provided to fit a variety of cord diameters
- Removable/replaceable self-retained sealing cap provided with connector to keep out contaminants when not in use
- Optional plug cover available for 15Amp straight blade & locking and 20Amp straight blade devices
- Transparent back-plate makes for quick visual wiring checks
- Ericson's new brilliant Blue and Radiant Yellow High Visibility Dual Color Safety System symbolizes that legendary Ericson Quality.

PERMA-TITE® 2

EXTRA GROMMETS Color coded rubber cord sealer grommets supplied for a variety of diameters.



UNIQUE WATER/DUST WIPER

Seals out moisture, mud and particles.

PBT BODY

Rugged thermoplastic polyester body in plug and connector.

ORIGINAL DEAD-FRONT BACK-WIRED CONSTRUCTION

We set industry standards with this design with no exposed current carrying parts.

FINGER GRIPS

Non-slip finger grips aid in assembly

CORROSION RESISTANT ASSEMBLY SCREWS

Stainless double lead assembly screws made for plastics exclusively to insure fast assembly and withstand high torque and pullout

EIGHT POINT SEALING

Unique rubber to rubber tongue and groove eight point seal-tite system when mated.

CORROSION RESISTANT NICKEL PLATED

Current carrying blades and contacts of high conductivity copper alloy with nickel plating for corrosion resistance.

DOUBLE INSULATED

Superior PBT body with TPE thermoplastic elastomer cover for extra safety, protection and durability.

SAFETY COMPRESSION CORD GRIP

Non-conductive, long life rugged PBT, powerful cord grip, unique design accepts a variety of wire sizes with no crushing and no inserts to change or add.

Plugs & Connectors

Perma-Tite® 2 Devices

PERMA-TITE® 2 Devices Selection Guide



Face View	NEMA Configuration	Electrical Ratings		Perma-Tite® 2	
		Amps	Volts	Plugs	Connectors
Straight Blade, 2-Pole, 3-Wire Grounding					
	5-15	15	125	1510-PW6P	1610-CW6P
	5-20	20	125	1512-PW6P	1612-CW6P
	6-15	15	250	1514-PW6P	1614-CW6P
	6-20	20	250	1516-PW6P	1616-CW6P
Locking, 2-Pole, 3-Wire Grounding					
	L5-15	15	125	1520-PW6P	1620-CW6P
	L6-15	15	250	1522-PW6P	1622-CW6P
	L7-15	15	277	1524-PW6P	1624-CW6P
	L5-20	20	125	2310-PW6P	2410-CW6P
	L6-20	20	250	2312-PW6P	2412-CW6P
	L7-20	20	277	2314-PW6P	2414-CW6P
Straight Blade, 3-Pole, 3-Wire					
	Non-NEMA	15/10	125/250	1507-PW6P	1607-CW6P
Locking, 3-Pole, 3-Wire Non-Grounding					
	Non-NEMA	20	125/250	2316-PW6P	2416-CW6P
	Non-NEMA	20/10	125/600	2317-PW6P ⁽¹⁾	2417-CW6P ⁽¹⁾
Locking, 3-Pole, 4-Wire Grounding					
	L14-20	20	125/250	2320-PW6P	2420-CW6P
	L15-20	20	250, 3Ø	2322-PW6P	2422-CW6P
	L16-20	20	480, 3Ø	2324-PW6P	2424-CW6P
Locking, 2-Pole, 3-Wire Grounding					
	L5-30	30	125	2510-PW6P	2610-CW6P
	L6-30	30	250	2512-PW6P	2612-CW6P
	L7-30	30	277	2514-PW6P	2614-CW6P
Locking, 3-Pole, 3-Wire Non-Grounding					
	Non-NEMA	30	125/250	2516-PW6P	2616-CW6P
Locking, 3-Pole, 4-Wire Grounding					
	L14-30	30	125/250	2520-PW6P	2620-CW6P
	L15-30	30	250, 3Ø	2522-PW6P	2622-CW6P
	L16-30	30	480, 3Ø	2524-PW6P	2624-CW6P
	L17-30	30	600, 3Ø	2526-PW6P	2626-CW6P
Locking, 4-Pole, 4-Wire					
	L18-30	30	120/208, 3Ø wye	2530-PW6P	2630-CW6P
Locking, 4-Pole, 4-Wire Non-Grounding					
	Non-NEMA	30	120/208, 3Ø wye	2528-PW6P	2628-CW6P



Notes:

1. For replacement use only. Not recommended for new installations
2. Insert "A" for 25 ft. cord set, "B" for 50 ft. cord set or "D" for 100 ft. cord set



Plugs & Connectors

Perma-Tite® 2 Devices

 Single Outlet FS Cover Plates	 Perma-Tite Factory Assembled Cord Sets(2)			
	#16 SOW	#14 SOW	#12 SOW	#10 SOW
2715-FS10	1510PW6P163__	1510PW6P143__		
2715-FS12			1512PW6P143__	1512PW6P123__
2715-FS14	1514PW6P163__	1514PW6P143__		
2715-FS16			1516PW6P143__	1516PW6P123__
2715-FS20	1520PW6P163__	1520PW6P143__		
2715-FS22	1522PW6P163__	1522PW6P143__		
2715-FS24	1524PW6P163__	1524PW6P143__		
2820-FS10		2310PW6P143__	2310PW6P123__	
2820-FS12		2312PW6P143__	2312PW6P123__	
2820-FS14		2314PW6P143__	2314PW6P123__	
2820-FS16				
2820-FS17				
2920-FS20		2320PW6P144__	2320PW6P124__	
2920-FS22		2322PW6P144__	2322PW6P124__	
2920-FS24		2324PW6P144__	2324PW6P124__	
2830-FS10			2510PW6P123__	2510PW6P103__
2830-FS12			2512PW6P123__	2512PW6P103__
2830-FS14			2514PW6P123__	2514PW6P103__
2830-FS16				
2930-FS20			2520PW6P124__	2520PW6P104__
2930-FS22			2522PW6P124__	2522PW6P104__
2930-FS24			2524PW6P124__	2524PW6P104__
2930-FS26			2526PW6P124__	
2930-FS30			2530PW6P124__	2530PW6P104__



Refer to the section on IEC 309 Pin & Sleeve Devices for a complete listing of North American & Internationally rated plugs, connectors, receptacles, inlets, mechanical interlocks & accessories.

Plugs & Connectors

Perma-Tite® 2 Devices

FEAR NO

...CONSTRUCTION SITE!

...IN-PLANT ENVIRONMENT!

...WET ENVIRONMENT!

PERMA-TITE® 2

- The only NEMA Type 4, 4X, 6, 6P and IP67 devices that maintain these ratings when properly mated with competitive devices that share the same ratings
- UL Listed & CSA Certified
- Resists High-Pressure hose-down of 1,000 psi

*Go **Yellow** & **Blue**...Go Ericson!*

Plugs & Connectors

Non-NEMA "Crowsfoot" Devices

NEW!

This Non-NEMA configuration, commonly called the "crowsfoot", is widely used in critical applications that require equipment be plugged into a specific electrical system to ensure proper function or to prevent equipment damage.

Typical Applications

- Low-voltage hand lamps and matching transformers
- Data acquisition/logging equipment to detect level and flow measurements on tanks and valves
- Sensitive electronic equipment that must be used on voltage regulated circuits

Features Guide

- Plug and connector bodies made with PBT chosen for its high resistance to moisture absorption, high voltage arcing and carbon tracking.
- Transparent back-plate makes for quick visual wiring checks.
- Keyed body and cover for easy alignment/assembly.
- Color-coded sealing bushings are provided to fit a variety of cord diameters.
- Perma-Tite® 2 devices have the eight-point rubber tongue and groove sealing system to provide environmental protection.
- Rubber sealing cap provided with Perma-Tite® 2 connector to keep out contaminants when not in use.
- Optional plug cover available - order catalog number 15PW.
- Ericson's exclusive Brilliant Blue and Radiant Yellow High Visibility Dual Color Safety System.
- Perma-Tite® 2 devices rated NEMA 4, 4X, 6, 6P & IP67.

PERMA-GRIP™ plug and connector with industry exclusive cord grip nut for rapid field assembly



1607-CG

1507-PG

Perma-Grip™ & Perma-Tite® 2 plugs & connectors come with color coded rubber cord seal bushings for a variety of cable diameters.

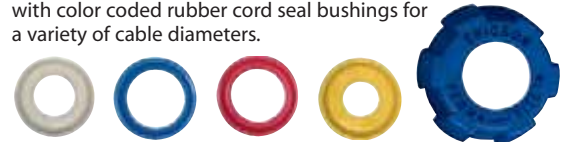

1507-PW6P

PERMA-TITE® 2
plug and connector

1607-CW6P

Selection Guide

Face View	NEMA Config.	Electrical Ratings		Perma-Grip™		Perma-Tite® 2	
		Amps	Volts	Plug	Connector	Plug	Connector
	Non-NEMA	15A 10A	125V 250V	1507-PG	1607-CG	1507-PW6P	1607-CW6P

Plugs & Connectors

PowerPak™

PowerPak™

15 Amp straight blade plug & connector



The innovative merchandising tool from Ericson Manufacturing Company

- **Products that Sell** - Each PowerPak tube holds an Ericson 15A/120V Straight blade Perma-Grip™ Plug (1510-PG) and Connector (1610-CG) that feature the exclusive safety compression cord grip that eliminates “pinching” of the cord caused by screw-down type cable clamps and provides quick field assembly because here are no cable clamp screws to tighten.
- **Sturdy, Reusable Packaging** - Display holds 25 transparent PowerPak™ tubes that clearly display the product inside and can be used by your customer to store their “odds-n-ends”.
- **Quick & Easy Set-Up** - Corrugated cardboard display pulls easily from shipping carton and is ready to display on your countertop - No Assembly Required!
- **High-Impact Graphics** - Attention getting black on yellow attracts your customer’s interest.
- **Space Saver** - Display tray measures only 9-1/2”L x 9-1/2”W x 9-3/8”H.
- **Additional Savings and Additional Profits!** Fast selling items generate more profits for your organization.
- **Contact your local Ericson Representative or the Factory Today!**

Selection Guide

Description	Catalog Number
PowerPak 15Amp Straight Blade Plug & Connector - 25 pack display	1447PP-25

Plugs & Connectors

Perma-Grip™ Devices



PERMA-GRIP™ Plugs and Connectors

Ericson's industry exclusive design combines the Perma-Tite® cord grip with the industry proven design of its Perma-Link® devices to provide a line of **incredibly tough plugs and connectors** that stand up to the most demanding industrial and construction environments.

- UL Listed and CSA Certified
- Quick field assembly, no cable clamp screws to tighten, simply twist on the cord grip nut
- Water/mud/dust resistance provided by safety compression cord grips
- Keyed body and cover for easy alignment/assembly
- Color coded rubber cord-seal bushings accommodate a wide range of cable diameters
- Molded-in non-slip fingers grips makes devices easy to assemble and handle
- Withstand high impact, corrosion, oils, greases, solvents and other chemicals across -20 °C - +65 °C
- Individual wire pockets help prevent flashovers
- Transparent back plate speeds wiring inspection
- Selected models available with Ground Continuity Monitor
- Available individually or on factory assembled cord sets
- Flexibility of reverse-cover design (straight blade devices) creates weather-resistant connections by interchanging covers
- Ericson's exclusive Brilliant Blue and Radiant Yellow High Visibility Dual Color Safety System

Safety Compression Cord Grip

Non-conductive, long life rugged PBT, powerful cord grip, unique design accepts all AWG wire range sizes from #18 through #12 with no crushing and no inserts to change or add

High-Visibility Safety Colors
Added safety in dull work areas With Brilliant Blue and Radiant Yellow colors.

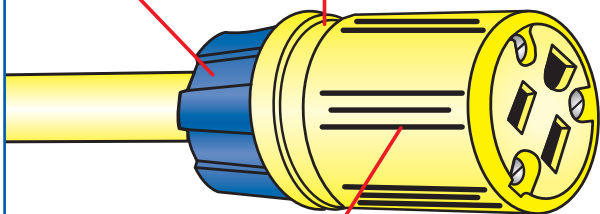

Non-Slip Finger Grips

EXTRA GROMMETS Color coded rubber cord sealer grommets supplied for a variety of diameters.



Transparent Back Plate

Clear polycarbonate permits visual wiring inspection without disassembly

Keyed PBT Body
Adds to quick alignment and assembly.

Double Insulated
Superior PBT body with TPE thermoplastic elastomer cover for extra safety, protection and durability.

Internal Cord Seal

Built-in cord entrance seal in cover seals out moisture and most foreign material that can cause short circuit.

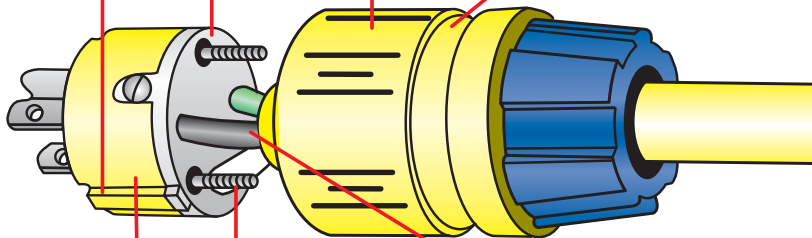

Captive Assembly Screws

Double lead screws provide rigid assembly, no bulging of cover, maximum pull out resistance, fast assembly.

Individual Wire Chambers

Accepts up to #12 AWG conductors and prevents flash overs and short circuits.

Dead-Front Back-Wired Design

We set industry standards with this design, no exposed current carrying parts, meets NEC article #410-56 (d).



Listed











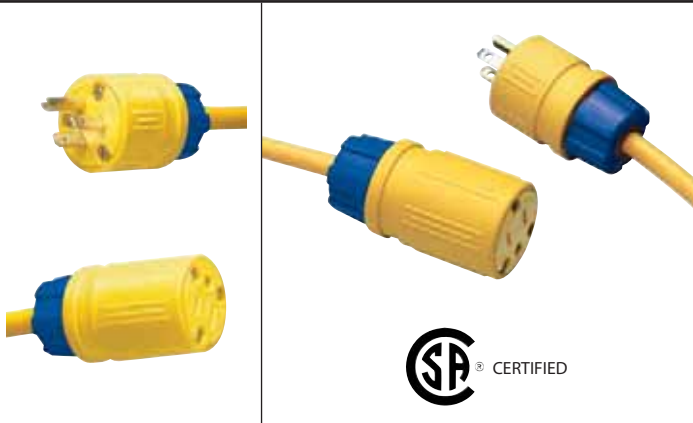











Certified

Plugs & Connectors

Perma-Grip™ Devices

PERMA-GRIP™ Devices Selection Guide

								
Face View	NEMA Configuration	Electrical Ratings		Perma-Grip™		Perma-Grip™ Factory Assembled Cord Sets(1)		
		Amps	Volts	Plugs	Connectors	#16 SOW	#14 SOW	#12 SOW
Straight Blade, 2-pole, 3-wire Grounding Devices								
	5-15	15	125	1510-PG	1610-CG	1510PG163__	1510PG143__	1510PG123__
	5-20	20	125	1512-PG	1612-CG	1512PG163__	1512PG143__	1512PG123__
	6-15	15	250	1514-PG	1614-CG	1514PG163__	1514PG143__	
	6-20	20	250	1516-PG	1616-CG	1516PG143__	1516PG143__	1516PG123__
Locking, 2-pole, 3-wire Grounding Devices								
	L5-15	15	125	1520-PG	1620-CG	1520PG163__	1520PG143__	
	L6-15	15	250	1522-PG	1622-CG	1522PG163__	1522PG143__	
	L7-15	15	277	1524-PG	1624-CG	1524PG163__	1524PG143__	
	L5-20	20	125	2310-PG	2410-CG		2310PG143__	2310PG123__
	L6-20	20	250	2312-PG	2412-CG		2312PG143__	2312PG123__
	L7-20	20	277	2314-PG	2414-CG			
Locking, 2-Pole, 3-Wire Grounding								
	L5-30	30	125	2510-PG	2610-CG			
	L6-30	30	250	2512-PG	2612-CG			
	L7-30	30	277	2514-PG	2614-CG			
Straight Blade, 3-pole, 3-wire Non-Grounding Devices								
	Non-NEMA	15/10	125V/250V	1507-PG	1607-CG			
Locking, 3-Pole, 3-Wire Non-Grounding								
	Non-NEMA	20	125/250	2316-PG	2416-CG			
	Non-NEMA	20/10	125/600	2317-PG	2417-CG			
Straight Blade, PERMA-GRIP™ Ground Continuity Monitors								
2-pole, 3-wire Grounding Devices								
	5-15	15	125	1510-PMG	1610-CMG	1610CMG163__	1610CMG143__	
	5-20	20	125	1512-PMG	1612-CMG		1612CMG143__	1612CMG123__

Notes:

1. Insert "A" for 25 ft. cord set, "B" for 50 ft. cord set or "D" for 100 ft. cord set
2. Contact factory for custom assemblies

 Refer to the section on IEC 309 Pin & Sleeve Devices for a complete listing of North American & Internationally rated plugs, connectors, receptacles, inlets, mechanical interlocks & accessories.

Plugs & Connectors

Perma-Link® Devices



PERMA-LINK® Plugs and Connectors

United States patent number 4,021,092 was assigned to today's Perma-Link® plugs and connectors which are classified among the most rugged and safest wiring devices available. They incorporate many of the same features as Ericson Perma-Tite® 2 and Perma-Grip™ devices and utilize a two-screw cable clamp. Perma-Link® plugs and connectors are designed to provide many years of trouble-free service in the most demanding industrial and construction environments.

- UL Listed and CSA Certified
- Two-screw cable clamp secures wire and provides strain-relief
- Solid brass blades for optimum electrical and mechanical performance
- Keyed body and cover for easy alignment/assembly
- Molded-in non-slip finger-grips makes devices easy to assemble and handle
- Withstand high impact, corrosion, oils, greases, solvents and other chemicals across -20 °C to 100 °C
- Individual wire pockets help prevent flashovers
- Transparent back plate speeds wiring inspection
- Selected models available with Ground Continuity Monitor
- Available individually or on factory assembled cord sets
- Flexibility of reverse-cover design creates weather-resistant connections by interchanging covers
- Ericson's exclusive Brilliant Blue and Radiant Yellow High Visibility Dual Color Safety System

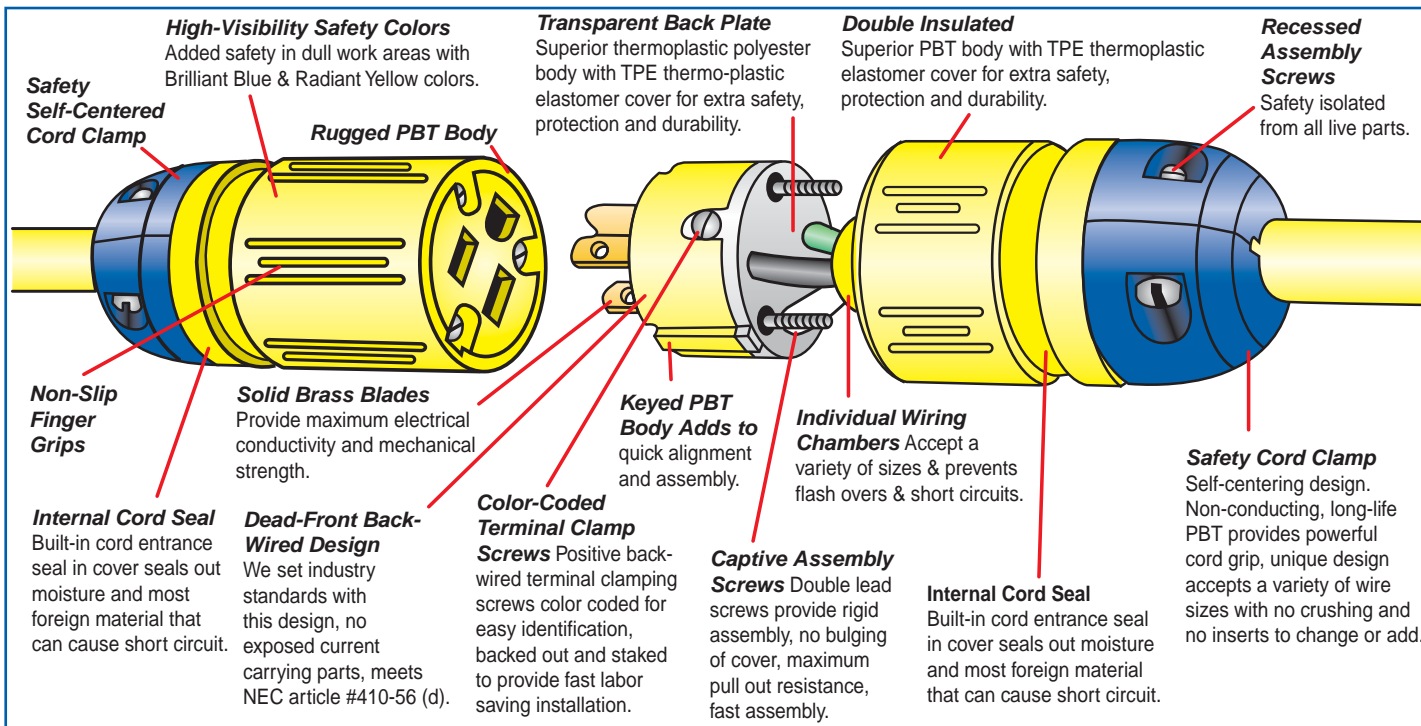

Plugs & Connectors

Perma-Link® Devices

Versatile Weather-Resistant Field Conversion

Our Perma-Link® plugs and connectors (straight blade only) are designed so they can easily be converted to create weather-resistant connections by interchanging the internal assemblies. Insert the plug body into the connector cover, and the connector body into the plug cover. There are no extra parts to purchase.



Hospital Grade Perma-Link® Plugs and Connectors

The same rugged internal construction as our standard Perma-Link line is found in these units, and in addition they meet UL Hospital Grade standards.

Designed for reliable long life, built to withstand exceptional abuse, these dead-front, back-wired devices save installation time, provide maximum protection and can be used for straight blade installations in hospitals, schools, and extended care facilities.

Constructed of rugged polybutylene terephthalate (PBT) and a high-tech thermoplastic elastomer (TPE), they have passed tests for ground pin retention, ground resistance, face impact, ground temperature contact, fault current, line blade retention and abrupt removal.

Please refer to following pages for configuration reference, ratings and Catalog Numbers.



INSULATED/INSTITUTION GRAY RUBBER COVER

White and light "institution" gray colors identify this style which provides superior insulation. They are clearly marked "Hospital Grade" and clearly marked with a green dot to signify UL Hospital Grade. Non-conductive cord clamp to accommodate cord sizes #16/3 SJ through #12/3 SO.

FAST WIRING CHECK THROUGH CLEAR COVER





























White PBT and transparent polycarbonate housing identify this type which permits visual inspection of wiring terminations without disassembly. Impact resistance, and non-conductive. Cord clamp has removable insert to accommodate #16/3 SJTW through #12/3 SO cord sizes.



Plugs & Connectors

Perma-Link® Devices





PERMA-LINK® Devices Selection Guide

								 Certified	
Face View	NEMA Configuration	Electrical Ratings		Perma-Link®		Perma-Link® Factory Assembled Cord Sets(2)			
		Amps	Volts	Plugs	Connectors	#16 SOW	#14 SOW	#12 SOW	#10 SOW
Straight Blade, 2-pole, 3-wire Grounding Devices									
	5-15	15	125	1510-P	1610-C	1510P163__	1510P143__		
	5-20	20	125	1512-P	1612-C		1512P143__	1512P123__	
	6-15	15	250	1514-P	1614-C	1514P163__	1514P143__		
	6-20	20	250	1516-P	1616-C		1516P143__	1516P123__	
Locking, 2-pole, 3-wire Grounding Devices									
	L5-15	15	125	1520-P	1620-C	1520P163__	1520P143__		
	L6-15	15	250	1522-P	1622-C	1522P163__	1522P143__		
	L7-15	15	277	1524-P	1624-C	1524P163__	1524P143__		
	L5-20	20	125	2310-P	2410-C		2310P143__	2310P123__	
	L6-20	20	250	2312-P	2412-C		2312P143__	2312P123__	
	L7-20	20	277	2314-P	2414-C		2314P143__	2314P123__	
Locking, 3-pole, 3-wire Non-Grounding Devices									
	Non-NEMA	20	125/250	2316-P	2416-C				
	Non-NEMA	20 10	125 600	2317-P(1)	2417-C(1)				
Locking, 3-pole, 4-wire Grounding Devices									
	L14-20	20	125/250	2320-P	2420-C		2320P144__	2320P124__	
	L15-20	20	250, 3Ø	2322-P	2422-C		2322P144__	2322P124__	
	L16-20	20	480, 3Ø	2324-P	2424-C		2324P144__	2324P124__	
Locking, 2-pole, 3-wire Grounding Devices									
	L5-30	30	125	2510-P	2610-C			2510P123__	2510P103__
	L6-30	30	250	2512-P	2612-C			2512P123__	2512P103__
	L7-30	30	277	2514-P	2614-C			2514P123__	2514P103__
Locking, 3-pole, 3-wire Non-Grounding Devices									
	Non-NEMA	30	125/250	2516-P	2616-C				
Locking, 3-pole, 4-wire Grounding Devices									
	L14-30	30	125/250	2520-P	2620-C			2520P124__	2520P104__
	L15-30	30	250, 3Ø	2522-P	2622-C			2522P124__	2522P104__
	L16-30	30	480, 3Ø	2524-P	2624-C			2524P124__	2524P104__
	L17-30	30	600, 3Ø	2526-P	2626-C			2526P124__	2526P104__
Locking, 4-pole, 4-wire Devices									
	L18-30	30	120/208 3Ø wye	2530-P	2630-C			2530P124__	2530P104__
Locking, 4-pole, 4-wire Non-Grounding Devices									
	Non-NEMA	30	120/208 3Ø wye	2528-P	2628-C				

Notes:

1. For replacement use only. Not recommended for new installations
2. Insert "A" for 25 ft. cord set, "B" for 50 ft. cord set or "D" for 100 ft. cord set







PERMA-LINK® Ground Continuity Monitors Selection Guide

					
Ground Continuity Monitors (1) Straight Blade, 2-pole, 3-wire Grounding					
Face View	NEMA Configuration	Electrical Ratings		Perma-Link	
		Amps	Volts	Plugs	Connectors
	5-15	15	125	1510-PM	1610-CM
	5-20	20	125	1512-PM	1612-CM
Locking, 2-pole, 3-wire Grounding					
	L5-20	20	125	2310-PM	2410-CM

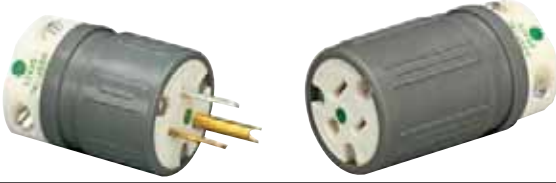
Notes:

1. See pages 134-135 for detailed information on GCMs.

PERMA-LINK® Hospital Grade Selection Guide

					
Hospital Grade Devices with Gray Covers Straight Blade, 2-pole, 3-wire Grounding					
Face View	NEMA Configuration	Electrical Ratings		Perma-Link	
		Amps	Volts	Plugs	Connectors
	5-15	15	125	1530-PH	1630-CH
	5-20	20	125	1532-PH	1632-CH
					
Hospital Grade Devices with Clear Covers Straight Blade, 2-pole, 3-wire Grounding					
	5-15	15	125	1530-PHC	1630-CHC
	5-20	20	125	1532-PHC	1632-CHC



Refer to the section on IEC 309 Pin & Sleeve Devices for a complete listing of North American & Internationally rated plugs, connectors, receptacles, inlets, mechanical interlocks & accessories.

Plugs & Connectors

Perma-Watch® Devices



PERMA-WATCH®

Ground and Continuity Monitors

Ericson's Perma-Watch® line of Ground and Continuity Monitors help employers comply with OSHA's Assured Equipment Grounding Conductor Program (AEGCP)-OSHA 1926.404(b)(1)(iii). Ericson's GCMs monitor the line side requirements of OSHA's AEGCP, which represent approximately 85%-90% of the total program requirements. Perma-Watch® plugs and connectors are designed to provide many years of trouble-free service in the most demanding industrial and construction environments.

- UL Listed
- Available in Perma-Link® or Perma-Grip™ styles
- Built-in monitoring lamp automatically and continuously monitors ground continuity and wiring conditions from the GCM to the source
- Lamp glows when equipment grounding conductor has continuity
- Also constantly checks for:
 - Reverse polarity
 - Open hot
 - Hot on neutral/hot unwired
 - Open neutral
 - Hot and ground reversed
- Solid brass blades for optimum electrical and mechanical performance
- Keyed body and cover for easy alignment/assembly
- Molded-in non-slip finger-grips makes devices easy to assemble and handle
- Withstand high impact, corrosion, oils, greases, solvents and other chemicals across -20° C - 100° C
- Individual wire pockets help prevent flashovers
- Transparent back plate speeds wiring inspection
- Available individually or on factory assembled cord sets
- Ericson's exclusive Dual Color Safety System

The OSHA Compliance Problem

In order to comply with OSHA requirements on construction sites, employers have two alternative methods per OSHA Standards.

FIRST ALTERNATIVE: G.F.C.I. utilization on construction sites for all 120 volt, single phase, 15-20 ampere temporary receptacle outlets...Realizing the many positive safety attributes associated with G.F.C.I. concept, there are also negative factors involved-- 1. nuisance tripping, 2. high cost, 3. damage prone, 4. pilferage.

SECOND ALTERNATIVE: Employer must establish the Assured Equipment Grounding Conductor Program in lieu of the G.F.C.I. Program covering all extension cord sets, job site receptacles and equipment connected by cord and plug.

Many contractors have opted for the Assured Equipment Grounding Conductor Program in lieu of the G.F.C.I. Program -- even though it entails a considerable amount of administrative record keeping and testing on a regular and frequent basis. Tests required are:

1. All equipment ground conductors shall be tested for continuity...
2. Each temporary job site receptacle, attachment plug and cord set must be tested for correct attachment of the equipment grounding conductor...

These tests must be performed before first use; --Before equipment is returned to service following repairs; --Before equipment is used after any incident that may have caused damage; -- And at intervals not to exceed three months. Finally, the above tests Must be recorded, AND the records kept at the job site for inspection by OSHA officials.

Plugs & Connectors

Perma-Watch® Devices

HIGH-VISIBILITY SAFETY COLORS
Added safety in dull work areas with Brilliant Orange and Radiant Yellow colors.

DEAD-FRONT BACK-WIRED DESIGN
We set industry standards with this design, no exposed current carrying parts, meet NEC article #410-56(d).

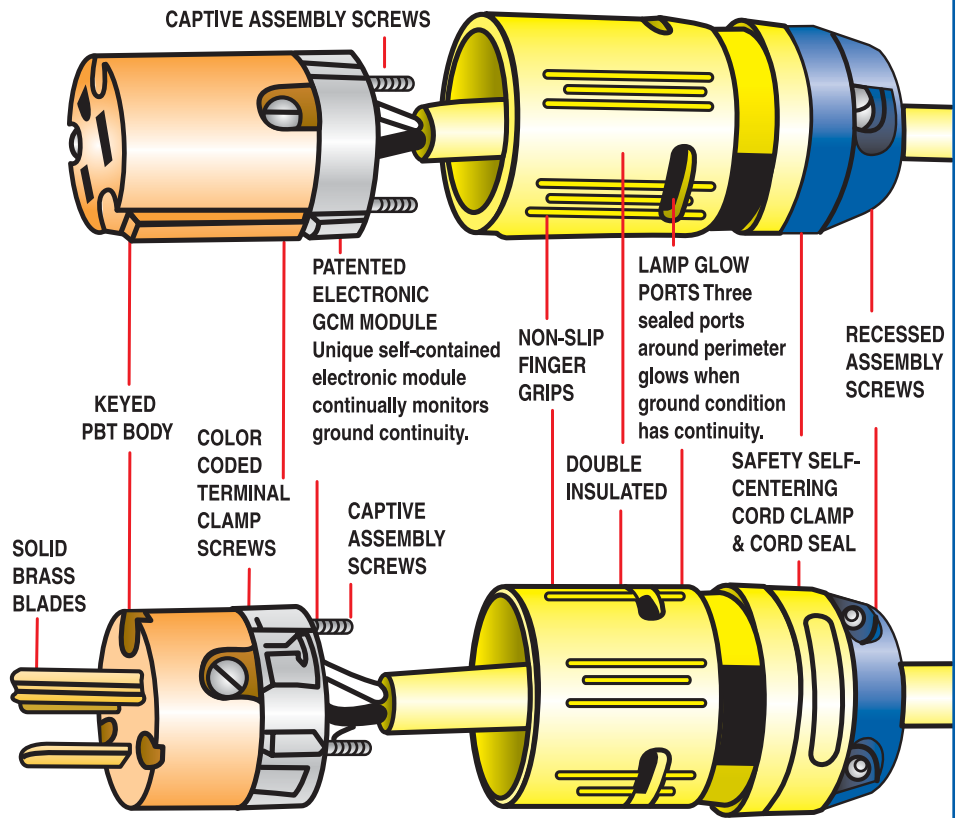

Please refer to page 130 for detail on general features of Perma-Link® Devices .

PERMA-WATCH® Devices Selection Guide

Face View	NEMA Configuration	Electrical Ratings		Perma-Link®		Perma-Grip®	
		Amps	Volts	Plugs	Connectors	Plugs	Connectors
Straight Blade, 2-pole, 3-wire Grounding Devices							
	5-15	15	125	1510-PM	1610-CM	1510-PMG	1610-CMG
	5-20	20	125	1512-PM	1612-CM	1512-PMG	1612-CMG
Locking, 2-pole, 3-wire Grounding							
	L5-20	20	125	2310-PM	2410-CM		

Notes:

1. Contact factory for custom assemblies

Use on Extension Cords

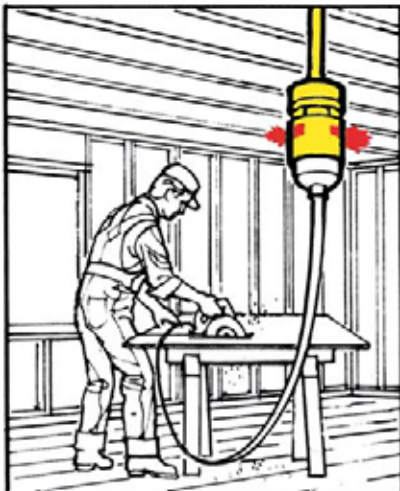

Use Wired to a Handlamp



Use Wired to Small Equipment



Plugs & Connectors

Perma-Link® 50 Amp Devices



PERMA-LINK® 50Amp Locking Plugs and Connectors

Ericson's 50 Amp plugs and connectors incorporate the latest technologies to provide wiring devices that are safer, faster to wire, lighter and easier to identify. These devices are available as plugs, connectors, inlets and receptacles and are available in 3 and 4 wire configurations.

- UL Listed and CSA Certified
- Rugged nylon construction resists impact, corrosion and jobsite oils/chemicals
- Quick field assembly, no need to disassemble the entire device
- Nickel plated blades and stainless steel screws provide optimum corrosion resistance
- Optional heavy-duty weather-proof boots are available and provide added environmental protection and UV resistance
- Boots can be threaded together with the optional sealing collar system to provide maximum environmental protection
- Available in plugs, connectors, inlets and receptacles



Sealing Collar System

Our exclusive sealing collar system is available to provide maximum moisture protection between cordsets. The two boots are securely sealed together with threaded polycarbonate rings.



Plugs & Connectors

Perma-Link® 50 Amp Devices

PERMA-LINK® 50-Amp Devices Selection Guide

Face View	NEMA Configuration	Electrical Ratings		Perma-Link®		Receptacles	Flanged Inlets
		Amps	Volts	Plugs	Connectors		
Locking, 2-pole, 3-wire Grounding							
	Non-NEMA	50	250VDC, 600VAC	3763-P	3762-C	3771	3777
Locking, 3-pole, 4-wire Grounding							
	Non-NEMA	50	250VDC, 600VAC	3765-P	3764-C	3769	3775
	Non-NEMA	50	250VDC, 600VAC	7765-P(1)	7764-C(1)		7958
Locking, California Style, 2-pole, 3-wire Grounding							
	Non-NEMA	50	125	CS6361-P	CS6360-C	CS6370	CS6377
	Non-NEMA	50	250	CS8265-P	CS8264-C	CS8269	CS8275
	Non-NEMA	50	480	CS8465-P	CS8464-C	CS8469	CS8475
Locking, California Style, 3-pole, 4-wire Grounding							
	Non-NEMA	50	125/250	CS6365-P	CS6364-C	CS6369	CS6375
	Non-NEMA	50	250, 3Ø	CS8365-P	CS8364-C	CS8369	CS8375
	Non-NEMA	50	480, 3Ø	CS8165-P	CS8164-C	CS8169	CS8175

Notes:

1. For replacement use only, not recommended for new installations
2. Contact factory for custom assemblies

PERMA-LINK® 50-Amp Accessories Selection Guide

Perma-Link® 50-Amp Accessories	Cat. Number
Weatherproof boot for plug or connector	7717
Sealing Collar for weatherproof boots	510-RR
Weatherproof receptacle cover	7788-CR



7788-CR

 Refer to the section on IEC 309 Pin & Sleeve Devices for a complete listing of North American & Internationally rated plugs, connectors, receptacles, inlets, mechanical interlocks & accessories.

Plugs & Connectors

Perma-Tite® 2 In-Line GFCI Cord Sets

NEW!



XG2-12-25PT



XG2-12-2BW



PERMA-TITE® 2 In-Line GFCI Cord Sets

These cord sets combine the reliability of Ericson's Perma-Tite® 2 plugs and connectors and the personnel protection of Ericson's industry leading portable GFCIs. They are designed for and proven to do their best under the worst conditions in a broad array for the most severe environments: food processing, industrial, marine, construction and petro-chemical work. Engineered and manufactured to the highest quality standards to provide the ultimate in electrical service and protection.

- UL & cUL Listed
- Perma-Tite®2 devices and XG2 GFCI enclosure meet UL water tight requirements and are rated NEMA Type 4, 4X, 6, 6P
- This unit combines a rugged cord set with the personal protection of a GFCI
- Compact & portable, this unit is easy to use, store and transport
- Meets NEC & OSHA construction site requirements
- Fast response trip time; less than .025 seconds
- Molded polycarbonate enclosure is corrosion and impact resistant, and stands up to the toughest jobsite conditions
- Engineered strain relief protects cord from excessive bending and pulling
- Test and Reset Buttons are clearly marked for easy identification and each is protected from accidental activation
- Plug and connector bodies made with PBT chosen for its high resistance to moisture absorption, high voltage arcing and carbon tracking.
- Eight-point rubber tongue and groove sealing system provides environmental protection
- Additional protection provided by a unique internal water/dust wiper
- Ericson's exclusive dual-color safety system for easy identification
- Custom Configurations available for your in-plant or OEM application- Contact the factory or your local Ericson Representative

PERMA-TITE® 2 In-Line GFCI Cord Sets Selection Guide

NEMA Configuration	Electrical Ratings		Cord Size/Type	w/ Perma-Tite® 2 Plug & Connector			Perma-Tite® 2 Plug & 6100 Box 1' Cord
	Amps	Volts		1' Cord	6' Cord	25' Cord	
5-15	15	125	#14 SJTW	XG2-14-2W	XG2-14-6W	XG2-14-25W	
5-20	20	125	#12 SJTW	XG2-12-2W	XG2-12-6W	XG2-12-25W	XG2-12-2BW

Consult factory for custom assemblies

Plugs & Connectors

Configuration Adapters & Perma-Tite® 2 Plug Cover



NEMA Configuration Adapters

Now make quick, secure connections between straight-blade and locking plugs and connectors with Ericson's NEMA configuration adapters.

- Heavy-duty non-conducting housing and using heavy gauge solid brass blades
- Compact size makes them easy to use and transport
- Available in four of the most popular models

NEMA Configuration Adapters Selection Guide

Catalog Number	NEMA Configuration		Description
	Male	Female	
1705			Male 15A, 125V twist (L5-15P) to 20A, 125V straight (5-20R)
1712			Male 15A, 125V straight (5-15P) to 15A, 125V twist (L5-15R)
1740			Male 20A, 125V twist (L5-20P) to 20A, 125V straight (5-20R)
1744			Male 15A, 125V straight (5-15P) to 20A, 125V twist (L5-20R)

PERMA-TITE® 2 Plug Cover

- Use with Ericson's Perma-Tite® plugs to seal out water, dust and other contaminants and to protect blades from damage when plug is not in-use
- Eight-point rubber tongue and groove sealing system provides environmental protection
- Additional protection provided by a unique internal water/dust wiper
- Easy to assemble
- Ericson's Radiant Yellow for High Visibility on job sites

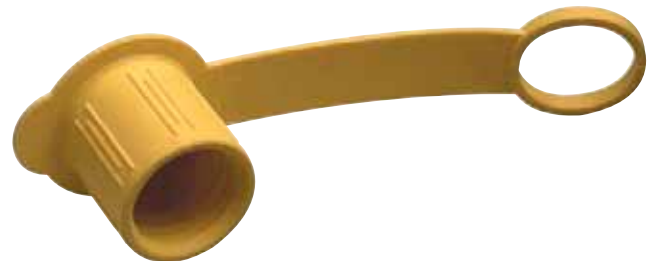

PERMA-TITE® 2 Plug Cover Selection Guide

Catalog Number	Description
15PW	Male closure cap, for use with 15A Straight Blade & Locking devices and 20A Straight Blade devices.

Male Closure Cap with plug

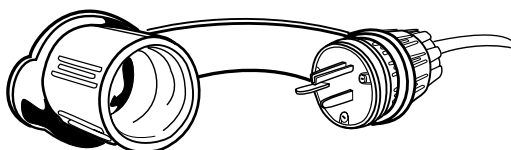

Male Closure Cap Only

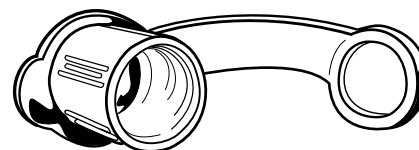

Plugs & Connectors

NEMA Configuration Charts

Face View	NEMA Configuration	Electrical Ratings		PERMA-TITE® 2		PERMA-GRIP™	
		Amps	Volts	Plugs	Connectors	Plugs	Connectors
Straight Blade, 2-pole, 3-wire grounding							
	5-15	15	125	1510-PW6P	1610-CW6P	1510-PG	1610-CG
	5-20	20	125	1512-PW6P	1612-CW6P ⁽³⁾	1512-PG	1612-CG ⁽³⁾
	6-15	15	250	1514-PW6P	1614-CW6P	1514-PG	1614-CG
	6-20	20	250	1516-PW6P	1616-CW6P	1516-PG	1616-CG
Locking, 3-pole, 3-wire non-grounding							
	Non-NEMA	20	125/250	2316-PW6P	2416-CW6P	2316-PG	2416-CG
	Non-NEMA	20 10	125 600	2317-PW6P ⁽¹⁾	2417-CW6P ⁽¹⁾	2317-PG	2417-CG
Locking, 3-pole, 4-wire grounding							
	L14-20	20	125/250	2320-PW6P	2420-CW6P		
	L15-20	20	250, 3Ø	2322-PW6P	2422-CW6P		
	L16-20	20	480, 3Ø	2324-PW6P	2424-CW6P		
Locking, 2-pole, 3-wire grounding							
	L5-30	30	125	2510-PW6P	2610-CW6P	2510-PG	2610-CG
	L6-30	30	250	2512-PW6P	2612-CW6P	2512-PG	2612-CG
	L7-30	30	277	2514-PW6P	2614-CW6P	2514-PG	2614-CG
Locking, 3-pole, 3-wire non-grounding							
	Non-NEMA	30	125/250	2516-PW6P	2616-CW6P	2516-PG	2616-CG
Locking, 3-pole, 4-wire grounding							
	L14-30	30	125/250	2520-PW6P	2620-CW6P		
	L15-30	30	250, 3Ø	2522-PW6P	2622-CW6P		
	L16-30	30	480, 3Ø	2524-PW6P	2624-CW6P		
	L17-30	30	600, 3Ø	2526-PW6P	2626-CW6P		
Locking, 4-pole, 4-wire							
	L18-30	30	120/208 3Ø wye	2530-PW6P	2630-CW6P		
Locking, 4-pole, 4-wire non-grounding							
	Non-NEMA	30	120/208 3Ø wye	2528-PW6P	2628-CW6P		

Notes:

1. For replacement use only. Not recommended for new installations
2. Locking Style
3. In Canada add "CAN-" to front of catalog number

Plugs & Connectors

NEMA Configuration Charts

PERMA-LINK®		Single Outlet FS Cover Plates
Plugs	Connectors	
1510-P	1610-C	2715-FS10
1512-P	1612-C ⁽³⁾	2715-FS12 ⁽³⁾
1514-P	1614-C	2715-FS14
1516-P	1616-C	2715-FS16
1520-P	1620-C	2715-FS20
1522-P	1622-C	2715-FS22
1524-P	1624-C	2715-FS24
2310-P	2410-C	2820-FS10
2312-P	2412-C	2820-FS12
2314-P	2414-C	2820-FS14
2316-P	2416-C	2820-FS16
2317-P ⁽¹⁾	2417-C ⁽¹⁾	2820-FS17 ⁽¹⁾
2320-P	2420-C	2920-FS20
2322-P	2422-C	2920-FS22
2324-P	2424-C	2920-FS24
2510-P	2610-C	2830-FS10
2512-P	2612-C	2830-FS12
2514-P	2614-C	2830-FS14
2516-P	2616-C	2830-FS16
2520-P	2620-C	2930-FS20
2522-P	2622-C	2930-FS22
2524-P	2624-C	2930-FS24
2526-P	2626-C	2930-FS26
2530-P	2630-C	2930-FS30

PERMA-TITE® 2

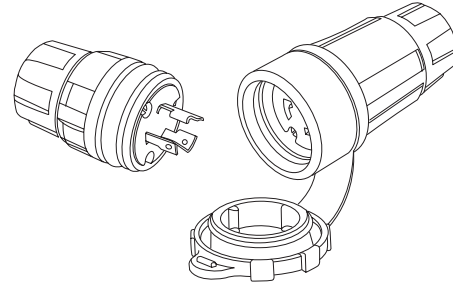

PERMA-GRIP™

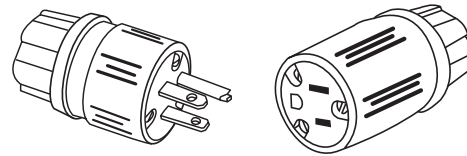

PERMA-LINK®

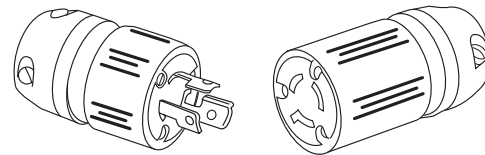

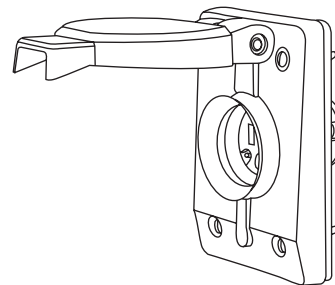

Single Outlet FS Cover Plate







Plugs & Connectors

NEMA Configuration Charts

PERMAWATCH® Devices







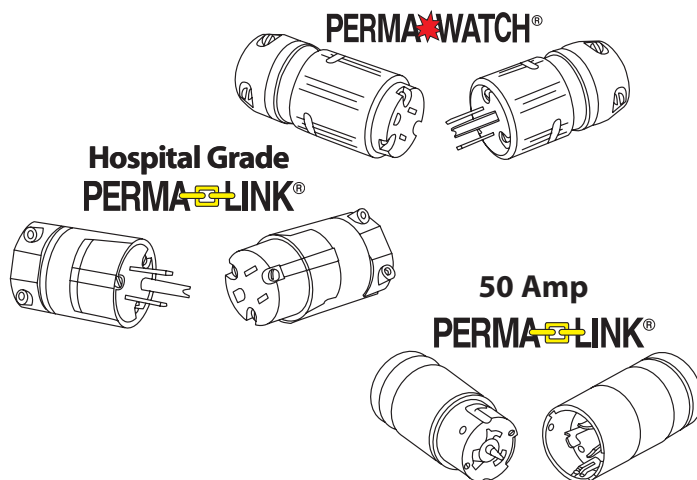

Face View	NEMA Configuration	Electrical Ratings		Perma-Link®		Perma-Grip™	
		Amps	Volts	Plugs	Connectors	Plugs	Connectors
Straight Blade, 2-pole, 3-wire Grounding Devices							
	5-15	15	125	1510-PM	1610-CM	1510-PMG	1610-CMG
	5-20	20	125	1512-PM	1612-CM	1512-PMG	1612-CMG
Locking, 2-pole, 3-wire Grounding							
	L5-20	20	125	2310-PM	2410-CM		

PERMALINK® Hospital Grade Devices

Hospital Grade Devices with Gray Covers Straight Blade, 2-pole, 3-wire Grounding					
Face View	NEMA Configuration	Electrical Ratings		Perma-Link®	
		Amps	Volts	Plugs	Connectors
	5-15	15	125	1530-PH	1630-CH
	5-20	20	125	1532-PH	1632-CH
Hospital Grade Devices with Clear Covers Straight Blade, 2-pole, 3-wire Grounding					
	5-15	15	125	1530-PHC	1630-CHC
	5-20	20	125	1532-PHC	1632-CHC



PERMALINK® 50-Amp Devices

Face View	NEMA Configuration	Electrical Ratings		Perma-Link®		Receptacles	Flanged Inlets
		Amps	Volts	Plugs	Connectors		
Locking, 2-pole, 3-wire Grounding							
	Non-NEMA	50	250VDC, 600VAC	3763-P	3762-C	3771	3777
Locking, 3-pole, 4-wire Grounding							
	Non-NEMA	50	250VDC, 600VAC	3765-P	3764-C	3769	3775
	Non-NEMA	50	250VDC, 600VAC	7765-P	7764-C		7958
Locking, California Style, 2-pole, 3-wire Grounding							
	Non-NEMA	50	125	CS6361-P	CS6360-C	CS6370	CS6377
	Non-NEMA	50	250	CS8265-P	CS8264-C	CS8269	CS8275
	Non-NEMA	50	480	CS8465-P	CS8464-C	CS8469	CS8475
Locking, California Style, 3-pole, 4-wire Grounding							
	Non-NEMA	50	125/250	CS6365-P	CS6364-C	CS6369	CS6375
	Non-NEMA	50	250, 3Ø	CS8365-P	CS8364-C	CS8369	CS8375
	Non-NEMA	50	480, 3Ø	CS8165-P	CS8164-C	CS8169	CS8175

Plugs & Connectors

Dimensions - Perma-Tite® 2 Devices

PERMA-TITE® 2 Devices

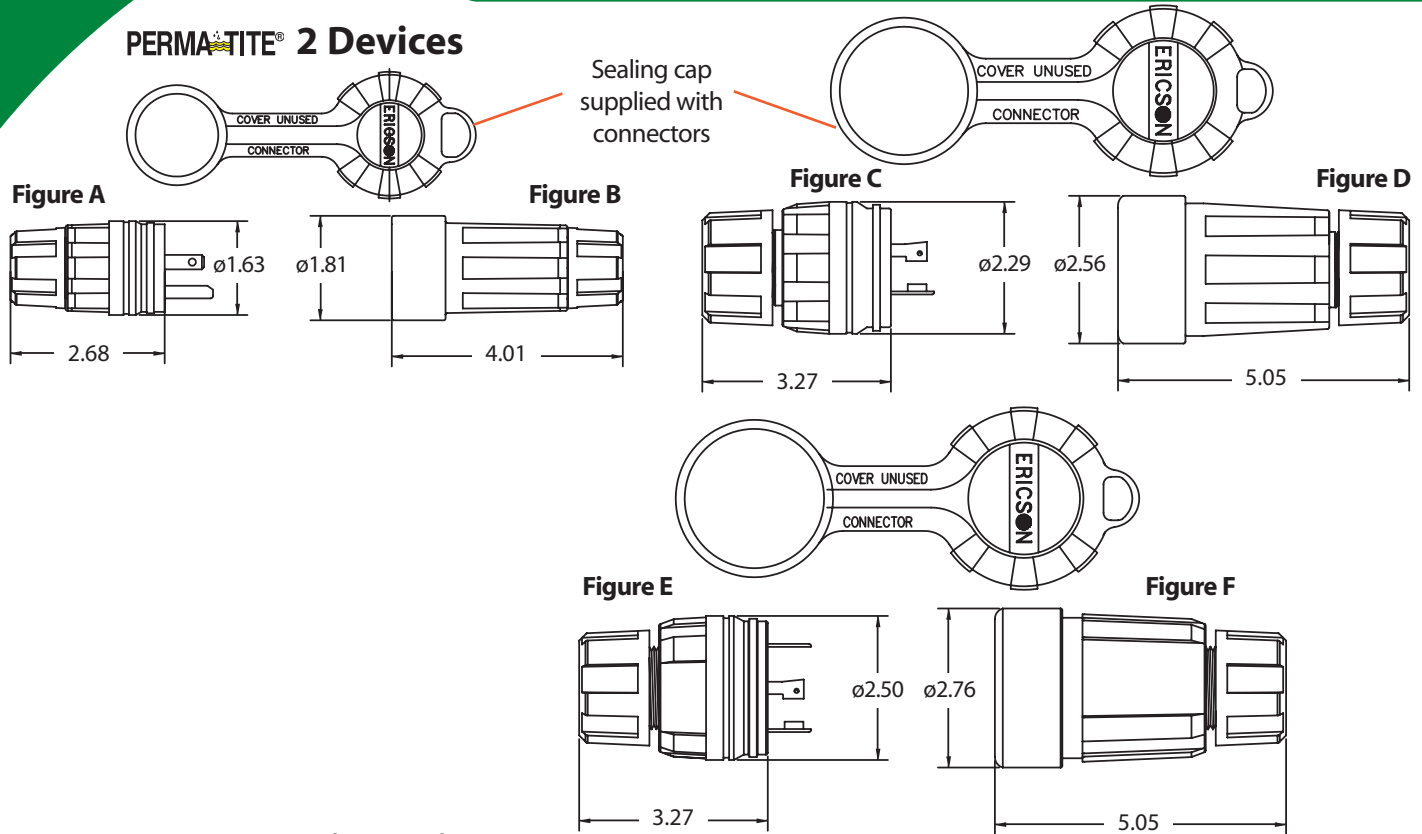

PERMA-TITE® Dimensions

NEMA Configuration	Electrical Ratings		Plugs	Figure	Connectors	Figure
	Amps	Volts				
5-15	15	125	1510-PW6P	A	1610-CW6P	B
5-20	20	125	1512-PW6P	A	1612-CW6P	B
6-15	15	250	1514-PW6P	A	1614-CW6P	B
6-20	20	250	1516-PW6P	A	1616-CW6P	B
L5-15	15	125	1520-PW6P	A	1620-CW6P	B
L6-15	15	250	1522-PW6P	A	1622-CW6P	B
L7-15	15	277	1524-PW6P	A	1624-CW6P	B
L5-20	20	125	2310-PW6P	C	2410-CW6P	D
L6-20	20	250	2312-PW6P	C	2412-CW6P	D
L7-20	20	277	2314-PW6P	C	2414-CW6P	D
Non-NEMA	20	125/250	2316-PW6P	C	2416-CW6P	D
Non-NEMA	20	125	2317-PW6P	C	2417-CW6P	D
	10	600				
L14-20	20	125/250	2320-PW6P	C	2420-CW6P	D
L15-20	20	250, 3 \varnothing	2322-PW6P	C	2422-CW6P	D
L16-20	20	480, 3 \varnothing	2324-PW6P	C	2424-CW6P	D
L5-30	30	125	2510-PW6P	C	2610-CW6P	D
L6-30	30	250	2512-PW6P	C	2612-CW6P	D
L7-30	30	277	2514-PW6P	C	2614-CW6P	D
Non-NEMA	30	125/250	2516-PW6P	C	2616-CW6P	D
L14-30	30	125/250	2520-PW6P	E	2620-CW6P	F
L15-30	30	250, 3 \varnothing	2522-PW6P	E	2622-CW6P	F
L16-30	30	480, 3 \varnothing	2524-PW6P	E	2624-CW6P	F
L17-30	30	600, 3 \varnothing	2526-PW6P	E	2626-CW6P	F
L18-30	30	120/208 3 \varnothing wye	2530-PW6P	E	2630-CW6P	F
Non-NEMA	30	120/208 3 \varnothing wye	2528-PW6P	E	2628-CW6P	F

Plugs & Connectors

Dimensions- Perma-Grip™ Devices

PERMA-GRIP™ Devices

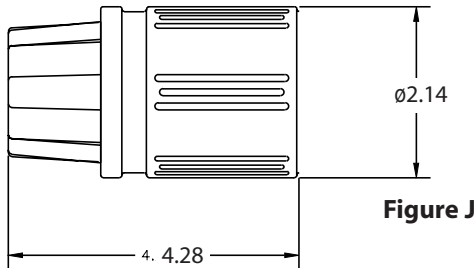
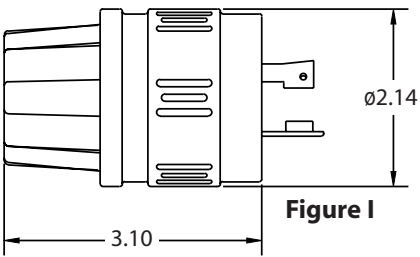
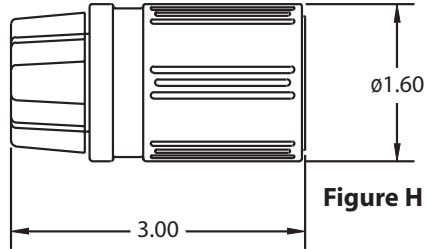
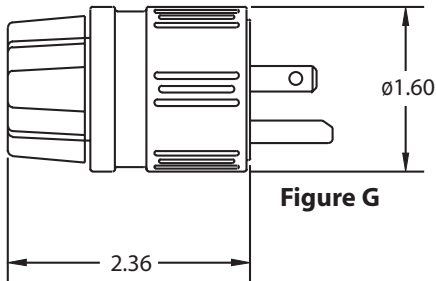

PERMA-GRIP™ Dimensions

NEMA Configuration	Electrical Ratings		Plugs	Figure	Connectors	Figure
	Amps	Volts				
5-15	15	125	1510-PG	G	1610-CG	H
5-20	20	125	1512-PG	G	1612-CG	H
6-15	15	250	1514-PG	G	1614-CG	H
6-20	20	250	1516-PG	G	1616-CG	H
L5-15	15	125	1520-PG	G	1620-CG	H
L6-15	15	250	1522-PG	G	1622-CG	H
L7-15	15	277	1524-PG	G	1624-CG	H
L5-20	20	125	2310-PG	I	2410-CG	J
L6-20	20	250	2312-PG	I	2412-CG	J
Non-NEMA	20	125/250	2316-PG	I	2416-CG	J
L5-30	30	125	2510-PG	I	2610-CG	J
Non-NEMA	30	125/250	2516-PG	I	2616-CG	J

Plugs & Connectors

Dimensions - Perma-Link® Devices

PERMA-LINK® Devices

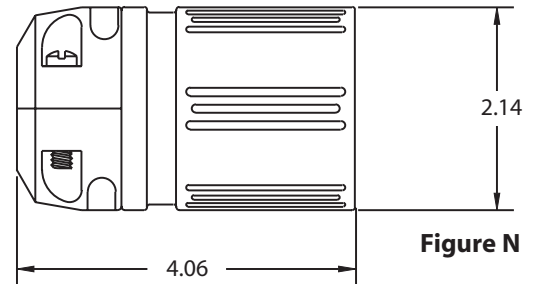
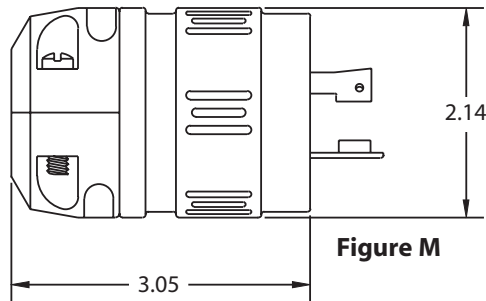
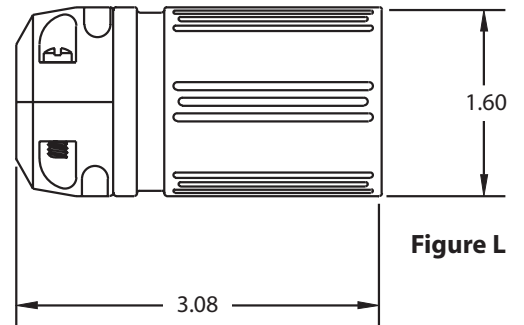
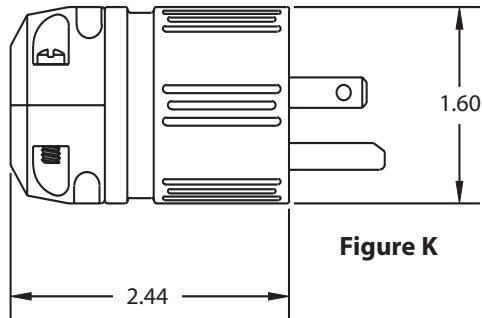

PERMA-LINK® Dimensions

NEMA Configuration	Electrical Ratings		Plugs	Figure	Connectors	Figure
	Amps	Volts				
5-15	15	125	1510-P	K	1610-C	L
5-20	20	125	1512-P	K	1612-C	L
6-15	15	250	1514-P	K	1614-C	L
6-20	20	250	1516-P	K	1616-C	L
L5-15	15	125	1520-P	K	1620-C	L
L6-15	15	250	1522-P	K	1622-C	L
L7-15	15	277	1524-P	K	1624-C	L
L5-20	20	125	2310-P	M	2410-C	N
L6-20	20	250	2312-P	M	2412-C	N
L7-20	20	277	2314-P	M	2414-C	N
Non-NEMA	20	125/250	2316-P	M	2416-C	N
Non-NEMA	20	125	2317-P	M	2417-C	N
	10	600				
L14-20	20	125/250	2320-P	M	2420-C	N
L15-20	20	250, 3Ø	2322-P	M	2422-C	N
L16-20	20	480, 3Ø	2324-P	M	2424-C	N
L5-30	30	125	2510-P	M	2610-C	N
L6-30	30	250	2512-P	M	2612-C	N
L7-30	30	277	2514-P	M	2614-C	N
Non-NEMA	30	125/250	2516-P	M	2616-C	N
L14-30	30	125/250	2520-P	M	2620-C	N
L15-30	30	250, 3Ø	2522-P	M	2622-C	N
L16-30	30	480, 3Ø	2524-P	M	2624-C	N
L17-30	30	600, 3Ø	2526-P	M	2626-C	N
L18-30	30	120/208 3Ø wye	2530-P	M	2630-C	N
Non-NEMA	30	120/208 3Ø wye	2528-P	M	2628-C	N

Plugs & Connectors

OSHA Regulations

OSHA 1926.404 Wiring Design and Protection

SubPart Number: K - Electrical - Installation Safety Requirements

OSHA 1926.404 (a)(3)

Use of grounding terminals and devices. A grounding terminal or grounding-type device on a receptacle, cord connector, or attachment plug shall not be used for purposes other than grounding.

OSHA 1926.404 (b)(1)(iii)

Assured equipment grounding conductor program. The employer shall establish and implement an assured equipment grounding conductor program on construction sites covering all cord sets, receptacles which are not a part of the building or structure, and equipment connected by cord and plug which are available for use or used by employees. This program shall comply with the following minimum requirements:

OSHA 1926.404 (b)(1)(iii)(A)

A written description of the program, including the specific procedures adopted by the employer, shall be available at the jobsite for inspection and copying by the Assistant Secretary and any affected employee.

OSHA 1926.404 (b)(1)(iii)(B)

The employer shall designate one or more competent persons (as defined in 1926.32(f)) to implement the program.

OSHA 1926.404 (b)(1)(iii)(C)

Each cord set, attachment cap, plug and receptacle of cord sets, and any equipment connected by cord and plug, except cord sets and receptacles which are fixed and not exposed to damage, shall be visually inspected before each day's use for external defects, such as deformed or missing pins or insulation damage, and for indications of possible internal damage. Equipment found damaged or defective shall not be used until repaired.

OSHA 1926.404 (b)(1)(iii)(D)

The following tests shall be performed on all cord sets, receptacles which are not a part of the permanent wiring of the building or structure, and cord- and plug-connected equipment required to be grounded:

OSHA 1926.404 (b)(1)(iii)(D)(1)

All equipment grounding conductors shall be tested for continuity and shall be electrically continuous.

OSHA 1926.404 (b)(1)(iii)(D)(2)

Each receptacle and attachment cap or plug shall be tested for correct attachment of the equipment grounding conductor. The equipment grounding conductor shall be connected to its proper terminal.

OSHA 1926.404 (b)(1)(iii)(E)

All required tests shall be performed:

OSHA 1926.404 (b)(1)(iii)(E)(1)

Before first use;

OSHA 1926.404 (b)(1)(iii)(E)(2)

Before equipment is returned to service following any repairs;

OSHA 1926.404 (b)(1)(iii)(E)(3)

Before equipment is used after any incident which can be reasonably suspected to have caused damage (for example, when a cord set is run over); and

OSHA 1926.404 (b)(1)(iii)(E)(4)

At intervals not to exceed 3 months, except that cord sets and receptacles which are fixed and not exposed to damage shall be tested at intervals not exceeding 6 months.

OSHA 1926.404 (b)(1)(iii)(F)

The employer shall not make available or permit the use by employees of any equipment which has not met the requirements of this paragraph (b)(1)(iii) of this section.

OSHA 1926.404 Wiring Design and Protection

SubPart Number: K - Electrical - Installation Safety Requirements

OSHA 1926.404 (b)(1)(iii)(G)

Tests performed as required in this paragraph shall be recorded. This test record shall identify each receptacle, cord set, and cord- and plug-connected equipment that passed the test and shall indicate the last date it was tested or the interval for which it was tested. This record shall be kept by means of logs, color coding, or other effective means and shall be maintained until replaced by a more current record. The record shall be made available on the jobsite for inspection by the Assistant Secretary and any affected employee.

OSHA 1926.404 (f)(7)(iv)

Equipment connected by cord and plug. Under any of the conditions described in paragraphs (f)(7)(iv)(A) through (f)(7)(iv)(C) of this section, exposed noncurrent-carrying metal parts of cord- and plug-connected equipment which may become energized shall be grounded:

OSHA 1926.404 (f)(7)(iv)(A)

If in a hazardous (classified) location (see 1926.407).

OSHA 1926.404 (f)(7)(iv)(B)

If operated at over 150 volts to ground, except for guarded motors and metal frames of electrically heated appliances if the appliance frames are permanently and effectively insulated from ground.

OSHA 1926.404 (f)(7)(iv)(C)

If the equipment is one of the types listed in paragraphs (f)(7)(iv)(C)(1) through (f)(7)(iv)(C)(5) of this section. However, even though the equipment may be one of these types, it need not be grounded if it is exempted by paragraph (f)(7)(iv)(C)(6).

OSHA 1926.404 (f)(7)(iv)(C)(1)

Hand held motor-operated tools;

OSHA 1926.404 (f)(7)(iv)(C)(2)

Cord- and plug-connected equipment used in damp or wet locations or by employees standing on the ground or on metal floors or working inside of metal tanks or boilers;

OSHA 1926.404 (f)(7)(iv)(C)(3)

Portable and mobile X-ray and associated equipment;

OSHA 1926.404(f)(7)(iv)(C)(4)

Tools likely to be used in wet and/or conductive locations;

OSHA 1926.404 (f)(7)(iv)(C)(5)

Portable hand lamps.

OSHA 1926.404 (f)(7)(iv)(C)(6)

Tools likely to be used in wet and/or conductive locations need not be grounded if supplied through an isolating transformer with an ungrounded secondary of not over 50 volts. Listed or labeled portable tools and appliances protected by a system of double insulation, or its equivalent, need not be grounded. If such a system is employed, the equipment shall be distinctively marked to indicate that the tool or appliance utilizes a system of double insulation.

Plugs & Connectors

OSHA Regulations

OSHA 1926.404 (f)(8)

Methods of grounding equipment -

OSHA 1926.404 (f)(8)(ii)

Grounding conductor. A conductor used for grounding fixed or movable equipment shall have capacity to conduct safely any fault current which may be imposed on it.

OSHA 1926.405 Wiring Methods, Components, and Equipment for General Use

Subpart Number: K - Electrical - Installation Safety Requirements

OSHA 1926.405 (g)(1)(ii)

Attachment plugs for cords. If used as permitted in paragraphs (g)(1)(i)(C), (g)(1)(i)(F), or (g)(1)(i)(H) of this section, the flexible cord shall be equipped with an attachment plug and shall be energized from a receptacle outlet.

OSHA 1926.405 (j)(2)(i)

Configuration. Receptacles, cord connectors, and attachment plugs shall be constructed so that no receptacle or cord connector will accept an attachment plug with a different voltage or current rating than that for which the device is intended. However, a 20-ampere T-slot receptacle or cord connector may accept a 15-ampere attachment plug of the same voltage rating. Receptacles connected to circuits having different voltages, frequencies, or types of current (ac or dc) on the same premises shall be of such design that the attachment plugs used on these circuits are not interchangeable.

