



## **Introduction**

### **⚠️⚠️ Warning**

**To avoid electric shock or injury, do not perform the performance tests or calibration adjustment procedures unless qualified to do so.**

**The information provided in this document is for the use of qualified personnel only.**

The *113 Calibration Information* provides the information necessary to adjust and verify the performance of the Fluke Model 113 Electrical Multimeter (hereafter known as the Meter).

The following information is included in this document:

- Safety Information and International Electrical Symbols (page 2)
- Specifications (page 3)
- Replacing the Battery (page 5)
- Cleaning (page 5)
- Performance Tests (page 5)
- Calibration Adjustment (page 7)
- Replacement Parts and Accessories (page 11)
- Complete Warranty (page 12)

See the *113 Users Manual* for complete operating instructions.

## **Contacting Fluke**

To contact Fluke, call one of the following telephone numbers:

USA: 1-888-99-FLUKE (1-888-993-5853)

Canada: 1-800-36-FLUKE (1-800-363-5853)

Europe: +31 402-675-200

Japan: +81-3-3434-0181

Singapore: +65-738-5655

Anywhere in the world: +1-425-446-5500

Or, visit Fluke's Web site at [www.fluke.com](http://www.fluke.com).

To register your product, visit <http://register.fluke.com>

## **Safety Information**

### **"Warning" and "Caution" Statements**

A "Warning" identifies hazardous conditions and actions that could cause bodily harm or death.

A "Caution" identifies conditions and actions that could damage the Meter, the equipment under test, or cause permanent loss of data.

### **⚠ ⚠ Warnings and Precautions**







**To avoid possible electric shock or personal injury, follow these guidelines:**

- **Use the Meter only as specified in this manual or the protection provided by the Meter might be impaired.**
- **Do not use the Meter or test leads if they appear damaged, or if the Meter is not operating properly.**
- **Always use proper terminals, switch position, and range for measurements.**
- **Verify the Meter's operation by measuring a known voltage. If in doubt, have the Meter serviced.**
- **Do not apply more than the rated voltage, as marked on Meter, between terminals or between any terminal and earth ground.**
- **Use caution with voltages above 30 V ac rms, 42 V ac peak, or 60 V dc. These voltages pose a shock hazard.**
- **Disconnect circuit power and discharge all high-voltage capacitors before testing resistance, continuity, diodes, or capacitance.**
- **Do not use the Meter around explosive gas or vapor.**
- **When using test leads or probes, keep your fingers behind the finger guards.**
- **Remove test leads from Meter before opening the battery door or Meter case.**
- **Comply with local and national safety requirements when working in hazardous locations.**
- **Use proper protective equipment, as required by local or national authorities when working in hazardous areas.**
- **Avoid working alone.**
- **Check the test leads for continuity before use. Do not use if the readings are high or noisy.**

## International Electrical Symbols

Table 1 lists the international symbols that appear in this document and on the Meter.

**Table 1. Electrical Symbols**

Symbol	Description	Symbol	Description
~	AC (Alternating Current)		Fuse
≡	DC (Direct Current)		Double Insulated
	Hazardous voltage		Important Information; Refer to manual
	Battery (Low battery when shown on the display.)		Earth ground
	Do not dispose of this product as unsorted municipal waste. Go to Fluke's website for recycling information.		

## Specifications

Accuracy is specified for 1 year after calibration at operating temperatures of 18 °C to 28 °C, with relative humidity at 0 % to 95 %. Extended specifications are available at [www.fluke.com](http://www.fluke.com).

## General Specifications

<b>Maximum voltage between any terminal and earth ground</b> .....	600 V
<b>Surge Protection</b> .....	6 kV peak per IEC 61010-1 600V CAT III, Pollution Degree 2
<b>Display</b> .....	Digital: 3¾-digits, 6,000 counts, updates 4/sec
<b>Temperature</b> .....	Operating: -10 °C to 50 °C (14 °F to 122 °F) Storage: -40 °C to 60 °C (-22 °F to 140 °F)
<b>Temperature Coefficient</b> .....	0.1 x (specified accuracy)/°C (<18 °C or >28 °C)
<b>Operating Altitude</b> .....	2,000 meters
<b>Storage Altitude</b> .....	10,000 meters
<b>Battery</b> .....	9 Volt Alkaline, NEDA 1604A / IEC 6F22
<b>Battery Life</b> .....	Alkaline: 300 hours typical, without backlight
<b>Shock</b> .....	1 Meter drop per IEC 61010-1-2001
<b>Vibration</b> .....	Per MIL-PRF-28800 for Class 2 instrument
<b>Size</b> .....	6.58 in X 3.35 in X 1.81 in (167.1 mm X 85.1 mm X 46.0 mm)
<b>Weight</b> .....	13.0 oz (404 g)
<b>Safety Compliances</b> .....	Complies with ANSI/ISA 82.02.01 (61010-1) 2004, CAN/CSA-C22.2 No 61010-1-04, UL 6101-1 (2004) and IEC/EN 61010-1 2 <sup>nd</sup> Edition for measurement Category III, 600 V, Pollution Degree 2, EMC EN61326-1
<b>EMI Regulations</b> .....	Complies with FCC Part 15, Class B
<b>Certifications</b> .....	UL, CE, CSA, TÜV,  , VDE

**Accuracy Specifications**

Function	Range	Resolution	Accuracy ± ([% of Reading] + [Counts])	
			DC, 45 to 500 Hz	500 Hz to 1 kHz
$\checkmark$ Chek <sup>[1,2]</sup>	6.000 V 60.00 V 600.0 V	0.001 V 0.01 V 0.1 V	2.0 % + 3	4.0 % + 3
<b>Function</b>	<b>Range</b>	<b>Resolution</b>	<b>Accuracy</b>	
$\text{   })$ [3]	600 $\Omega$	1 $\Omega$	Beeper on <20 $\Omega$ , off >250 $\Omega$ ; detects opens or shorts of 500 $\mu$ s or longer.	
$\Omega$ [3]	600.0 $\Omega$ 6.000 k $\Omega$ 60.00 k $\Omega$	0.1 $\Omega$ 0.001 k $\Omega$ 0.01 k $\Omega$	0.9 % + 2 0.9 % + 1 0.9 % + 1	
$\rightarrow$ [3]	2.000 V	0.001 V	2.0 % + 3	
$\text{+}$ [3]	1000 nF 10.00 $\mu$ F 100.0 $\mu$ F 9999 $\mu$ F	1 nF 0.01 $\mu$ F 0.1 $\mu$ F 1 $\mu$ F	1.9 % + 2 1.9 % + 2 1.9 % + 2 100 $\mu$ F - 1000 $\mu$ F: 1.9 % + 2 >1000 $\mu$ F: 5 % + 20	
<p>[1] All <math>\checkmark</math> Chek voltage ranges are specified from 60 counts to 100 % of range. Because inputs below 60 counts are not specified, it is possible and normal for this and other true-rms meters to display non-zero readings when the test leads are disconnected from a circuit or are shorted together.</p> <p>[2] Crest factor of <math>\leq 3</math> at 4000 counts, decreasing linearly to 1.5 at full scale.</p> <p>[3] After measuring voltage, a wait time of 1 minute is required to maintain accuracy of ohms, capacitance, diode test, and continuity.</p>				

**Input Characteristics**

Function	Input Impedance (Nominal)	Common Mode Rejection Ratio (1 k $\Omega$ Unbalanced)	Normal Mode Rejection
$\checkmark$ Chek	$\sim 3$ k $\Omega$ <300 pF	>60 dB at dc, 50 or 60 Hz	
	<b>Open Circuit Test Voltage</b>	<b>Full Scale Voltage</b>	<b>Short Circuit Current</b>
$\Omega$	<2.7 V dc	<0.7 V dc	<350 $\mu$ A
$\rightarrow$	<2.7 V dc	2.000 V dc	<1.0 mA

**MIN MAX Recording Accuracy and Response Time**

Specified accuracy of the measurement function  $\pm 40$  counts in  $\checkmark$  Chek for changes >500 ms in duration,  $\pm 12$  counts in Ohms for changes >325 ms in duration. Typical 100 ms response to 80 %. Response time not specified for Capacitance.

## Basic Maintenance

### Replacing the Battery

#### **⚠ ⚠ Warning**

**To avoid shock, injury, or damage to the Meter, remove test leads from the Meter before opening the case or battery door.**

To remove the battery door for battery replacement, refer to Figure 1 while performing the following:

1. Remove the test leads from the Meter.
2. Remove the battery door screw.
3. Use the finger recess to lift the door slightly.
4. Lift the door straight up to separate it from the case.

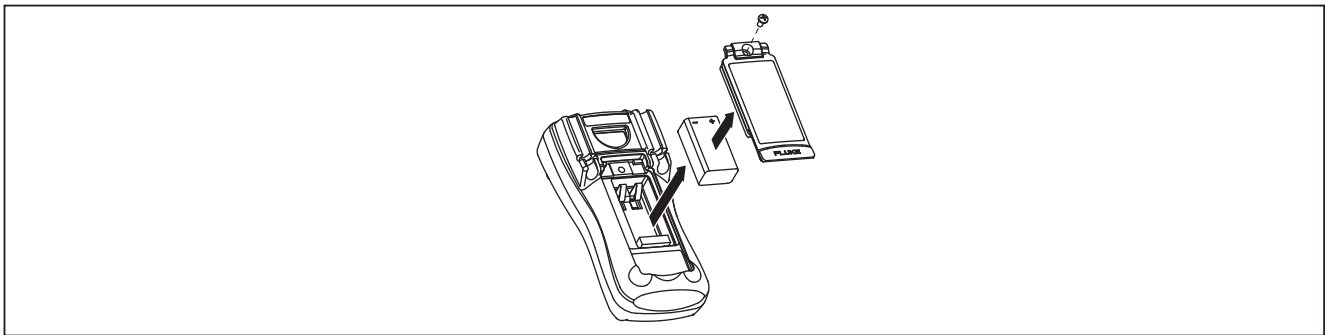

Figure 1. Battery Replacement

erc011f.emf

The battery fits inside the battery door, which is then inserted into the case, bottom edge first, until it is fully seated. Do not attempt to install the battery directly into the case. Once installed, tighten the battery door screw.

### Cleaning the Meter

Wipe the case with a damp cloth and mild detergent. Do not use abrasives or solvents. Dirt or moisture in the terminals can affect readings.

## Performance Tests

#### **⚠ ⚠ Warning**

**To avoid electric shock, do not perform the performance test procedures unless the Meter is fully assembled.**

The following performance tests verify the complete operation of the Meter and check the accuracy of each Meter function against its specifications. The recommended calibration interval is 12 months. If the Meter fails any part of the test, calibration adjustment and/or repair is indicated.

In the performance tests, the Meter is referred to as the unit under test (UUT).

### Required Equipment

Table 2 lists the equipment required to conduct a performance test on the Meter.

Table 2. Required Equipment

Recommended Equipment	Measurement Function	Accuracy
5500A Multi-product Calibrator (or equivalent)	DC Volts	10 mV to 600 V $\pm 0.125\%$
	AC Volts	6 mV to 600 V $\pm 0.25\%$ @ 45 Hz to 1 kHz
	Resistance	0 to 60 k $\Omega$ $\pm 0.225\%$
	Capacitance (115, 116, and 117)	9 to 900 $\mu$ F $\pm 0.475\%$

### Testing the Display

Push **HOLD** and turn the rotary switch to the  $\checkmark$  Check position. Compare the display with the example in Figure 2. Check all segments for clarity and contrast.

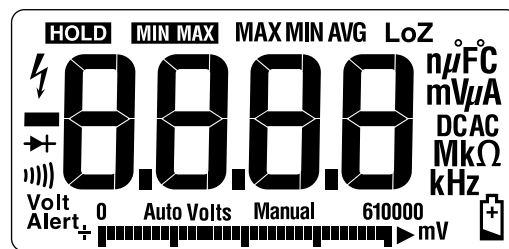

Figure 2. Display Segments

erc022f.emf

### Backlight Test

To Test the Backlight, press  $\odot$  and verify that the backlight comes on.

### Keypad Test

To test the keypad, turn the Meter to  $\Omega$   $\rightarrow$  and push each button separately. Each button push should cause the Meter to beep and activate a display annunciator.

Reset the Meter by turning it **Off** and then back to an On position.

### Preparing for the Performance Tests

#### **⚠️ Warning**

To avoid possible electric shock or personal injury:

- Do not perform the following procedures unless qualified to do so. Some procedures involve the use of high voltages.
- Before handling the test connections and in between tests, make sure the calibrator is in standby mode (STBY).

To prepare for the performance test:

1. Make sure that you have the required equipment (refer to Table 2).
2. Warm up the calibrator as required by its specifications.
3. Allow the temperature of the UUT to stabilize at room temperature ( $23\text{ }^{\circ}\text{C} \pm 5\text{ }^{\circ}\text{C}$  [ $73\text{ }^{\circ}\text{F} \pm 9\text{ }^{\circ}\text{F}$ ]).
4. Check the Battery, and replace it if necessary. Refer to “Replacing the Battery”.

To verify the accuracy of the Meter functions, do the following:

1. Connect the Calibrator to the + and COM input terminals on the Meter.
2. Turn the rotary switch to the function listed in each step of Table 3.
3. Apply the input level for each step listed in Table 3.
4. Compare the reading on the Meter display with the Display Reading in Table 3.
5. If the display reading falls outside of the range shown in Table 3, the Meter requires calibration adjustment or repair.

**Table 3. Meter Performance Tests**

Step	Function	Range	Applied	Display Reading	
1	Ω Ohms	600.0	0.0 Ω	0.0 to 0.2 (2-Wire comp)	
2		600.0	500 Ω	495.3 to 504.7	
3		6.000 k	5 kΩ	4.954 to 5.046	
4		60.00 k	50 kΩ	49.54 to 50.46	
5	ⓧ Chek Continuity	NA	20 Ω	Beeper On	
6		NA	250 Ω	Beeper Off	
7	ⓧ Chek → Diode Test	NA	1.9 V	1.859 to 1.941	
8	ⓧ Chek Volts <sup>[1]</sup>	6.000 V	0.1 V	0.095 to 0.105	
9		6.000 V	5 V	4.897 to 5.103	
10		6.000 V	-5 V	-5.103 to -4.897	
11		6.000 V	5 V, 45 Hz	4.897 to 5.103	
12		6.000 V	5 V, 1 kHz	4.797 to 5.203	
13		60.00 V	50 V	48.97 to 51.03	
14		60.00 V	-50 V	-51.03 to -48.97	
15		60.00 V	50 V, 500 Hz	48.97 to 51.03	
16		60.00 V	50 V, 1 kHz	47.97 to 52.03	
17		600.0 V <sup>[2]</sup>	600 V	587.7 to 612.3	
18		600.0 V <sup>[2]</sup>	-600 V	-612.3 to -587.7	
19		600.0 V <sup>[2]</sup>	600 V, 45 Hz	587.7 to 612.3	
20		600.0 V <sup>[2]</sup>	600 V, 1 kHz	575.7 to 624.3	
21		ⓧ Capacitance	1000 nF	Open	0 to 2
22			9999 μF	900 μF	881 to 919

[1] Manually select the range by pressing **RANGE** .

[2] To keep from tripping the calibrator to standby, ramp up the voltage in 50 V increments with a five-second delay between increments.

## Calibration Adjustment

The Meter features closed-case calibration adjustment using known reference sources. The Meter measures the applied reference source, calculates correction factors, and stores the correction factors in nonvolatile memory.

The following sections present the features and Meter pushbutton functions available during the Calibration Adjustment Procedure. Should the Meter fail any of the performance tests, perform the Calibration Adjustment Procedure.

Use the following steps to view the Meter's calibration counter.

1. While pressing **RANGE**, turn the rotary switch from **OFF** to  $\Omega$  function. The Meter should display “ $\Omega$  CAL”.
2. Press **□** once to view the calibration counter. For example, “n000”
3. Turn the rotary switch to **OFF**.

### Calibration Adjustment Password

To start the Calibration Adjustment Procedure, the correct 4-digit password must be entered. The default password is “1234”. The password can be changed or reset to the default as described in following paragraphs.

### Changing the Password

Use the following steps to change the Meter's password:

1. While pressing **RANGE**, turn the rotary switch from **OFF** to  $\Omega$  function. The Meter should display “ $\Omega$  CAL”.
2. Press **□** once to see the calibration counter.
3. Press **□** again to start the password entry. The Meter displays “????”.
4. The Meter buttons indicated below represent the numbers 1 through 5 when entering or changing the password:

**HOLD** = 1      **MIN MAX** = 2      **RANGE** = 3      **□** = 4      **⊕** = 5

5. Press 4 buttons to enter the current password. If changing the password for the first time, enter **HOLD** (1), **MIN MAX** (2), **RANGE** (3), and **□** (4).
6. Press **RANGE** to change the password. The Meter displays “----” if the entered password is correct. If the password is not correct, the Meter emits a double beep, displays “????”, and the password must be entered again. Repeat step 5.
7. Press the 4 buttons of the new password.
8. Press **□** to store the new password.

### Restoring the Default Password

If the calibration password is forgotten, the default password (1234) can be manually restored using the following steps:

### Warning

**To avoid electric shock or personal injury, remove the test leads and any input signal before removing the Meter's back case.**

1. Remove the Meter's back case. Leave the pca in the top case.
2. Apply 9.0 V across the battery contacts (XBT1) + and (XBT2) – on the back of the PCA. See Figure 3.
3. Turn the rotary switch from **OFF** to any on position.
4. Short across the S7 CAL keypad on the back of the PCA. See Figure 3. The Meter should beep. The default password is now restored.
5. Remove the 9.0 V supply and replace the Meter's back case.



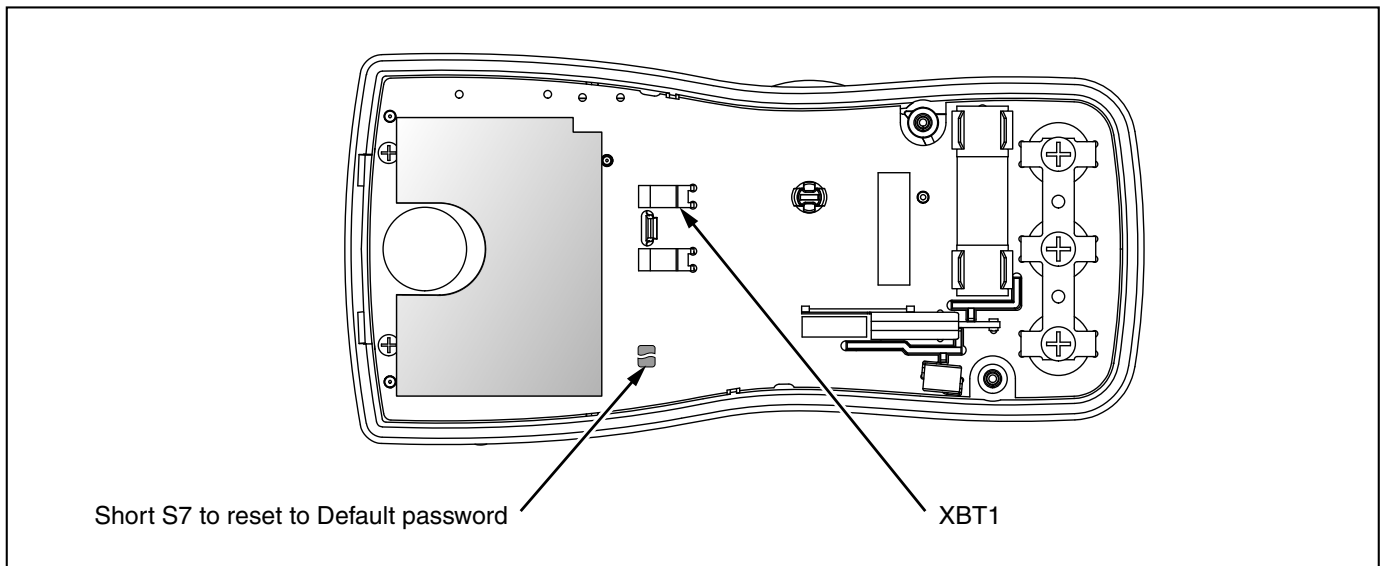

**Figure 3. Calibration Password Reset**

erc12f.emf

### **Meter Buttons Used in the Calibration Steps**

When performing the Calibration Adjustment Procedure, the Meter buttons behave as follows. This may be of help determining why a calibration step is not accepted and for determining the input value without referring to Table 4.

- Press and hold **HOLD** to show the measured value. The measured value is not calibrated so it may not match the input value. This is normal.
- Press and hold **MIN MAX** to display the required input value.
- Press  to store the calibration value and advance to the next step. This button is also used to exit calibration mode after the calibration adjustment sequence is complete.
- Press  to toggle the backlight on and off.

### **Calibration Adjustment Procedure**

To adjust the Meter's calibration, use the following steps. If the Meter is turned off before completion of the adjustment procedure, the calibration constants are not changed.

1. While holding down  turn the rotary switch from **OFF** to  $\Omega$  function. The Meter should display "CAL".
2. Press  once to see the calibration counter.
3. Press  again to start the password entry. The Meter displays "????".
4. Press the 4 button password.
5. Press  to go to the first calibration step. The Meter displays "[ - 0 ]" if the password is correct. If the password is not correct, the Meter emits a double beep, displays "????" and the password must be entered again. Repeat step 4.
6. Apply the input value listed for each calibration adjustment step. For each step, select the rotary switch position and apply the input to the terminals as indicated in the Table 4.

#### *Note*

*Some adjustment steps require additional wait time after the calibrator settles, as noted in Table 4.*

7. After each input value is applied, press  to accept the value and proceed to the next step ([ -02 and so forth).

*Note*

*After pressing , wait until the step number advances before changing the calibrator source or turning the Meter's rotary knob. Some adjustment steps can take up to several seconds to execute before moving to the next step.*

*If the knob is not in the correct position for a given step, the meter will flash the unit annunciators until the knob is put in a valid position. The keys that show the reading and required input values are not allowed until the knob is correct.*

*Likewise, if the rotary switch is not in the correct position or the measured value is not within the anticipated range of the input value, the Meter will emit a double beep and will not continue to the next step when  is pressed.*



8. After the final step, the display shows “**End**” to indicate that the calibration adjustment is complete. Press  to return to meter mode.

*Note*

*Set the calibrator to Standby prior to changing the function switch position and after completing adjustment of each function.*

*If the calibration adjustment procedure is not properly completed, the Meter will not operate correctly.*

**Table 4. Calibration Adjustment Steps**

Rotary Switch Position	Calibration Steps	Input Terminals	Calibrator Source Value
 mV ac/dc	[ -01	+ and COM	0 V, 0 Hz
	[ -02	+ and COM	300 mV, 0 Hz
	[ -03	+ and COM	100 mV, 0 Hz
	[ -04	+ and COM	-300 mV, 0 Hz
	[ -05	+ and COM	60 mV, 0 Hz
	[ -06	+ and COM	600 mV, 0 Hz
	[ -07	+ and COM	600 mV, 60 Hz
 Ohms	[ -08	+ and COM	600 Ω, 2-wire comp
	[ -09	+ and COM	6 kΩ
	[ -10	+ and COM	60 kΩ
	[ -11	+ and COM	600 kΩ
 V ac	[ -12	+ and COM	6 V, 60 Hz
	[ -13	+ and COM	60 V, 60 Hz
	[ -14	+ and COM	600 V, 60 Hz <sup>[1]</sup>

[1] To keep from tripping the calibrator to standby, ramp up the voltage in 50 V increments with a 5 second delay between increments.

## Replacement Parts

Table 5 lists the Meter's replaceable parts identified in Figure 4.

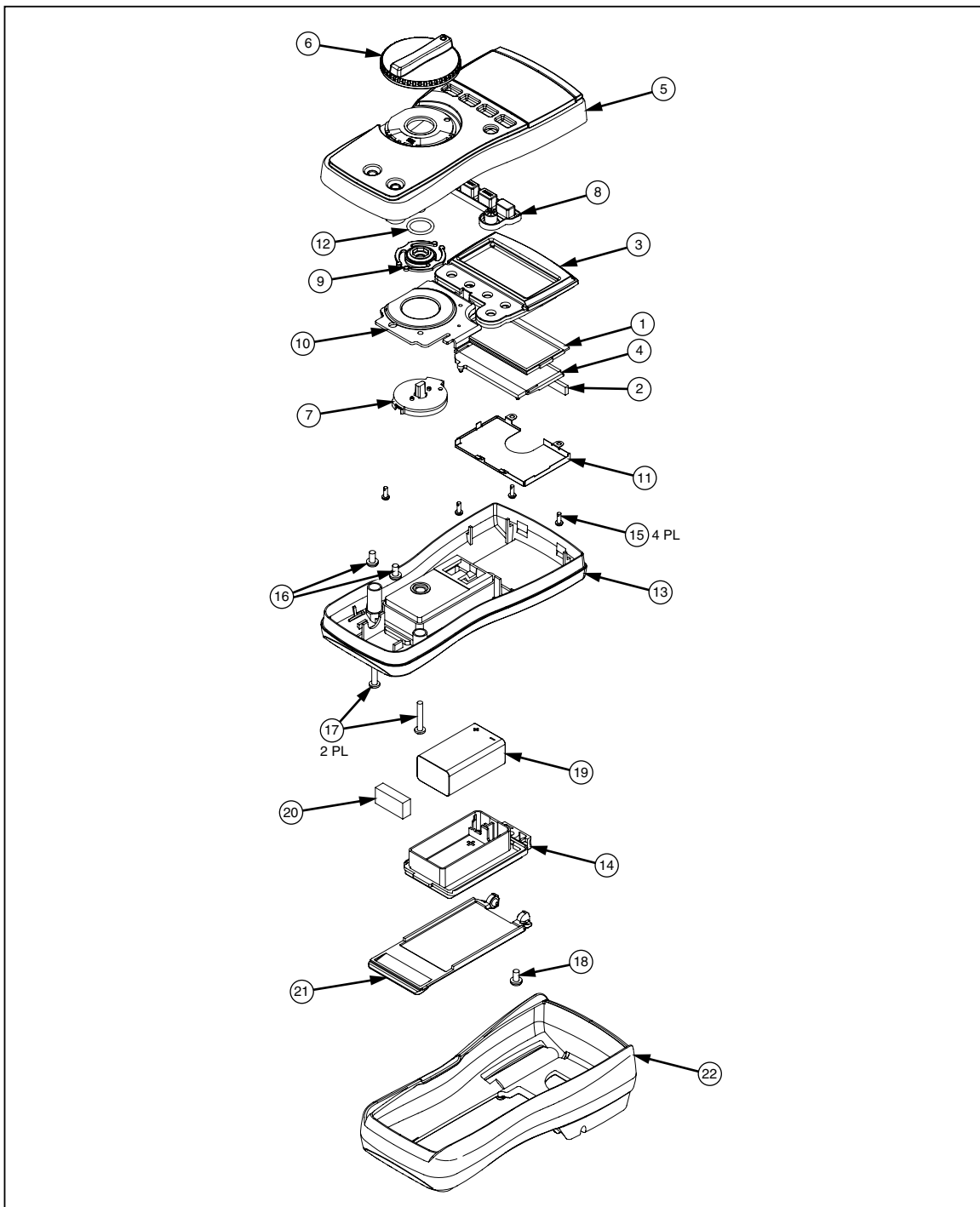

Figure 4. Exploded View of Meter

erc14.eps

Table 5. Replaceable Parts List

Item	Description	Part Number	Qty.
1	LCD,FLUKE-11X,3.2V,TN,4-DIGIT,1/4-DUTY,1/3-BIAS,LEPTON	2509955	1
2	CONNECTOR,ELASTOMERIC,.010 IN CTR,.218 IN HIGH,.090 IN THK,2.284 IN LONG,BULK	2534229	1
3	FLUKE-117-2006-08, BRACKET MASK, 113	3088082	1
4	FLUKE-117-8005,DIFFUSER, BACKLIGHT	2535203	1
5	FLUKE-117-2001-04,CASE TOP, 113	3092058	1
6	FLUKE-117-2008,KNOB	2525624	1
7	FLUKE-117-7602,RSOB HOUSING ASSEMBLY	2787083	1
8	FLUKE-117-8001,KEYPAD	2526276	1
9	FLUKE-117-2009,SPRING DETENT	2525636	1
10	FLUKE-117-8009,SHIELD, TOP	2571277	1
11	FLUKE-117-8010,IC SHIELD	2571292	1
12	O-RING,NITRILE,SHORE A 70,15.6MM OD,12.0MM ID ,1.8MM W	2535215	1
13	FLUKE-117-2002,CASE BOTTOM	2525566	1
14	FLUKE-117-2003,BATTERY DOOR	2525575	1
15	SCREW,2-28,.250,PAN,PHILLIPS,STEEL,ZINC-CHROMATE,PLASTITE 48 THREAD FORMING	2516493	4
16	SCREW,M3,4MM,PAN,PHILLIPS,STEEL,ZINC-CHROMATE	2032811	2
17	SCREW,5-14,.750,PAN,PHILLIPS,STEEL,BLACK CHROMATE,THD FORMING	832246	2
18	SCREW,M3X0.5,6MM,PAN,PHILLIPS,STEEL,ZINC-BLACK CHROMATE	2032792	1
19	BATTERY,PRIMARY,MNO2-ZN,9V,505MAH,6LR61,ALKALINE, 17X26X48MM,BULK	614487	1
20	FLUKE 12-8004,SHOCK ABSORBER	878983	1
21	FLUKE-117-2005-02, TILT STAND, 113	3093970	1
22	FLUKE-117-2010,HOLSTER	2525649	1
Not shown	INSTRUCTION SHEET,INSTRUCTION SHEET SET, 12 LANG, FLUKE-113	3083192	1

## **Warranty**

This Fluke product will be free from defects in material and workmanship for three years from the date of purchase. This warranty does not cover fuses, disposable batteries, or damage from accident, neglect, misuse, alteration, contamination, or abnormal conditions of operation or handling. Resellers are not authorized to extend any other warranty on Fluke's behalf. To obtain service during the warranty period, contact your nearest Fluke authorized service center to obtain return authorization information, then send the product to that Service Center with a description of the problem.

THIS WARRANTY IS YOUR ONLY REMEDY. NO OTHER WARRANTIES, SUCH AS FITNESS FOR A PARTICULAR PURPOSE, ARE EXPRESSED OR IMPLIED. FLUKE IS NOT LIABLE FOR ANY SPECIAL, INDIRECT, INCIDENTAL OR CONSEQUENTIAL DAMAGES OR LOSSES, ARISING FROM ANY CAUSE OR THEORY. Since some states or countries do not allow the exclusion or limitation of an implied warranty or of incidental or consequential damages, this limitation of liability may not apply to you.

Fluke Corporation  
P.O. Box 9090  
Everett, WA 98206-9090  
U.S.A.

Fluke Europe B.V.  
P.O. Box 1186  
5602 BD Eindhoven  
The Netherlands

11/99

		<p><b>205 Westwood Ave Long Branch, NJ 07740 1-877-742-TEST (8378) Fax: (732) 222-7088 salesteam@Tequipment.NET</b></p>
---	---	---

