

FLUKE®

Tequipment
_____.NET



USA

205 Westwood Ave
Long Branch, NJ 07740
1-877-742-TEST (8378)
Fax: (732) 222-7088
salesteam@Tequipment.NET

Fluke 123/124/125

Industrial ScopeMeter

Service Manual

4822 872 05398

March 2007

© 2007 Fluke Corporation, All rights reserved.

All product names are trademarks of their respective companies.

Limited Warranty & Limitation of Liability

Each Fluke product is warranted to be free from defects in material and workmanship under normal use and service. The warranty period is three years for the Analyzer and one year for its accessories. The warranty period begins on the date of shipment. Parts, product repairs and services are warranted for 90 days. This warranty extends only to the original buyer or end-user customer of a Fluke authorized reseller, and does not apply to fuses, disposable batteries or to any product which, in Fluke's opinion, has been misused, altered, neglected or damaged by accident or abnormal conditions of operation or handling. Fluke warrants that software will operate substantially in accordance with its functional specifications for 90 days and that it has been properly recorded on non-defective media. Fluke does not warrant that software will be error free or operate without interruption.

Fluke authorized resellers shall extend this warranty on new and unused products to end-user customers only but have no authority to extend a greater or different warranty on behalf of Fluke. Warranty support is available if product is purchased through a Fluke authorized sales outlet or Buyer has paid the applicable international price. Fluke reserves the right to invoice Buyer for importation costs of repair/replacement parts when product purchased in one country is submitted for repair in another country.

Fluke's warranty obligation is limited, at Fluke's option, to refund of the purchase price, free of charge repair, or replacement of a defective product which is returned to a Fluke authorized service center within the warranty period.

To obtain warranty service, contact your nearest Fluke authorized service center or send the product, with a description of the difficulty, postage and insurance prepaid (FOB Destination), to the nearest Fluke authorized service center. Fluke assumes no risk for damage in transit. Following warranty repair, the product will be returned to Buyer, transportation prepaid (FOB Destination). If Fluke determines that the failure was caused by misuse, alteration, accident or abnormal condition of operation or handling, Fluke will provide an estimate of repair costs and obtain authorization before commencing the work. Following repair, the product will be returned to the Buyer transportation prepaid and the Buyer will be billed for the repair and return transportation charges (FOB Shipping Point).

THIS WARRANTY IS BUYER'S SOLE AND EXCLUSIVE REMEDY AND IS IN LIEU OF ALL OTHER WARRANTIES, EXPRESS OR IMPLIED, INCLUDING BUT NOT LIMITED TO ANY IMPLIED WARRANTY OF MERCHANTABILITY OR FITNESS FOR A PARTICULAR PURPOSE. FLUKE SHALL NOT BE LIABLE FOR ANY SPECIAL, INDIRECT, INCIDENTAL OR CONSEQUENTIAL DAMAGES OR LOSSES, INCLUDING LOSS OF DATA, WHETHER ARISING FROM BREACH OF WARRANTY OR BASED ON CONTRACT, TORT, RELIANCE OR ANY OTHER THEORY.

Since some countries or states do not allow limitation of the term of an implied warranty, or exclusion or limitation of incidental or consequential damages, the limitations and exclusions of this warranty may not apply to every buyer. If any provision of this Warranty is held invalid or unenforceable by a court of competent jurisdiction, such holding will not affect the validity or enforceability of any other provision.

Fluke Corporation, P.O. Box 9090, Everett, WA 98206-9090 USA, or
Fluke Industrial B.V., P.O. Box 90, 7600 AB, Almelo, The Netherlands.

Table of Contents

Chapter	Title	Page
	Limited Warranty & Limitation of Liability	ii
	Introduction and Safety Instructions.....	1-1
1.1	Introduction to Service Manual	1-3
1.2	Safety	1-3
1.2.1	Introduction.....	1-3
1.2.2	Safety Precautions.....	1-3
1.2.3	Caution and Warning Statements.....	1-3
1.2.4	Symbols used in this Manual and on Instrument	1-4
1.2.5	Impaired Safety	1-4
1.2.6	General Safety Information.....	1-4
	Characteristics	2-1
2.1	Introduction.....	2-3
2.2	Dual Input Oscilloscope.....	2-3
2.2.1	Vertical.....	2-3
2.2.2	Horizontal	2-4
2.2.3	Trigger	2-4
2.2.4	Advanced Scope Functions	2-5
2.3	Dual Input Meter.....	2-5
2.3.1	Input A and Input B	2-5
2.3.2	Input A	2-8
2.3.3	Advanced Meter Functions	2-9
2.4	Cursor Readout (Fluke 124, 125).....	2-10
2.5	Harmonics Measurements (Fluke 125).....	2-10
2.6	Field Bus Measurements (Fluke 125).....	2-11
2.7	Miscellaneous	2-11
2.8	Environmental.....	2-12
2.9	Service and Maintenance	2-13
2.10	Safety	2-13
2.11	EMC Immunity	2-15

Performance Verification.....	3-1
3.1 Introduction.....	3-3
3.2 Equipment Required For Verification	3-3
3.3 How To Verify.....	3-4
3.4 Display and Backlight Test.....	3-4
3.5 Input A and Input B Tests.....	3-5
3.5.1 Input A and B Base Line Jump Test	3-6
3.5.2 Input A Trigger Sensitivity Test	3-8
3.5.3 Input A Frequency Response Upper Transition Point Test	3-9
3.5.4 Input A Frequency Measurement Accuracy Test	3-9
3.5.5 Input B Frequency Measurement Accuracy Test.....	3-10
3.5.6 Input B Frequency Response Upper Transition Point Test.....	3-11
3.5.7 Input B Trigger Sensitivity Test	3-12
3.5.8 Input A and B Trigger Level and Trigger Slope Test	3-13
3.5.9 Input A and B DC Voltage Accuracy Test	3-16
3.5.10 Input A and B AC Voltage Accuracy Test	3-18
3.5.11 Input A and B AC Input Coupling Test.....	3-19
3.5.12 Input A and B Volts Peak Measurements Test	3-20
3.5.13 Input A and B Phase Measurements Test	3-21
3.5.14 Harmonics (Fluke 125)	3-21
3.5.15 Input A and B High Voltage AC/DC Accuracy Test.....	3-22
3.5.16 Resistance Measurements Test	3-24
3.5.17 Continuity Function Test	3-25
3.5.18 Diode Test Function Test.....	3-26
3.5.19 Capacitance Measurements Test.....	3-26
3.5.20 Video Trigger Test.....	3-27
Calibration Adjustment.....	4-1
4.1 General.....	4-3
4.1.1 Introduction.....	4-3
4.1.2 Calibration number and date	4-3
4.1.3 General Instructions	4-3
4.2 Equipment Required For Calibration	4-4
4.3 Starting Calibration Adjustment	4-4
4.4 Contrast Calibration Adjustment	4-6
4.5 Warming Up & Pre-Calibration.....	4-7
4.6 Final Calibration	4-7
4.6.1 HF Gain Input A&B	4-7
4.6.2 Delta T Gain, Trigger Delay Time & Pulse Adjust Input A	4-9
4.6.3 Pulse Adjust Input B	4-10
4.6.4 Gain DMM (Gain Volt)	4-10
4.6.5 Volt Zero.....	4-12
4.6.6 Zero Ohm	4-12
4.6.7 Gain Ohm.....	4-13
4.6.8 Capacitance Gain Low and High	4-14
4.6.9 Capacitance Clamp & Zero.....	4-14
4.6.10 Capacitance Gain	4-15
4.7 Save Calibration Data and Exit.....	4-15

Disassembling the Test Tool	5-1
5.1. Introduction.....	5-3
5.2. Disassembling Procedures	5-3
5.1.1 Required Tools.....	5-3
5.2.2 Removing the Battery Pack	5-3
5.2.3 Removing the Bail	5-3
5.2.4 Opening the Test Tool	5-3
5.2.5 Removing the Main PCA Unit.....	5-5
5.2.6 Removing the Display Assembly.....	5-6
5.2.7 Removing the Keypad and Keypad Foil.....	5-6
5.3 Disassembling the Main PCA Unit.....	5-6
5.4 Reassembling the Main PCA Unit.....	5-8
5.5 Reassembling the Test Tool.....	5-8
List of Replaceable Parts	6-1
6.1 Introduction.....	6-3
6.2 How to Obtain Parts.....	6-3
6.3 Service Centers	6-3
6.4 Final Assembly Parts	6-4
6.5 Main PCA Unit Parts	6-6
6.6 Service Tools	6-7
6.7 Accessory Replacement Parts	6-7

List of Tables

Table	Title	Page
2-1.	No Visible Trace Disturbance	2-15
2-2.	Trace Disturbance < 10%	2-15
2-3.	Multimeter Disturbance < 1%.....	2-15
3-1.	Input A,B Frequency Measurement Accuracy Test	3-10
3-2.	Volts DC Measurement Verification Points	3-17
3-3.	Volts AC Measurement Verification Points	3-19
3-4.	Input A and B AC Input Coupling Verification Points.....	3-20
3-5.	Volts Peak Measurement Verification Points	3-21
3-6.	Phase Measurement Verification Points.....	3-21
3-7.	V DC and V AC High Voltage Verification Tests.....	3-24
3-8.	Resistance Measurement Verification Points	3-25
3-9.	Capacitance Measurement Verification Points	3-27
4-1.	HF Gain Calibration Points Fast	4-8
4-2.	HF Gain Calibration Points Slow	4-9

4-3.Volt Gain Calibration Points <300V	4-11
4-4.Ohm Gain Calibration Points	4-13
6-1.Final Assembly Parts.....	6-4
6-2.Main PCA Unit	6-6
6-3.Standard Accessories	6-7
6-4.Optional Accessories	6-8

List of Figures

Figure	Title	Page
2-2.	Max. Input Voltage v.s. Frequency for VP40 10:1 Voltage Probe	2-14
3-1.	Display Pixel Test Pattern	3-5
3-2.	Menu item selection.....	3-6
3-3.	Test Tool Input A to 5500A Scope Output 50 Ω	3-8
3-4.	Test Tool Input B to 5500A Scope Output 50 Ω	3-10
3-5.	Test Tool Input A-B to 5500A Normal Output.....	3-13
3-6.	Bargraph Harmonics Ampere	3-22
3-7.	Bargraph Harmonics Volt.....	3-22
3-8.	Test Tool Input A-B to 5500A Normal Output for >300V	3-23
3-9.	Test Tool Input A to 5500A Normal Output 4-Wire.....	3-24
3-10.	Test Tool Input A to TV Signal Generator.....	3-28
3-11.	Test Tool Screen for PAL/SECAM line 622	3-29
3-12.	Test Tool Screen for NTSC line 525	3-29
3-13.	Test Tool Screen for PAL/SECAM line 310.....	3-30

3-14. Test Tool Screen for NTSC line 262	3-30
3-15. Test Tool Input A to TV Signal Generator Inverted	3-30
3-16. Test Tool Screen for PAL/SECAM line 310 Negative Video	3-31
3-17. Test Tool Screen for NTSC line 262 Negative Video	3-31
4-1. Version & Calibration Screen	4-3
4-2. Display Test Pattern	4-6
4-3. HF Gain Calibration Input Connections	4-7
4-4. 5500A Scope Output to Input A	4-9
4-5. 5500A Scope Output to Input B	4-10
4-6. Volt Gain Calibration Input Connections <300V	4-11
4-7. Volt Gain Calibration Input Connections 500V	4-12
4-8. Four-wire Ohms calibration connections	4-13
4-9. Capacitance Gain Calibration Input Connections	4-14
5-1. Fluke 123 Main Assembly	5-4
5-2. Flex Cable Connectors	5-5
5-3. Main PCA Unit Assembly	5-7
5-4. Mounting the display shielding bracket	5-9
6-1. Fluke 123 Final Assembly	6-5
6-2. Main PCA Unit	6-6

Chapter 1

Introduction and Safety Instructions

Title	Page
1.1 Introduction to Service Manual	1-3
1.2 Safety	1-3
1.2.1 Introduction.....	1-3
1.2.2 Safety Precautions.....	1-3
1.2.3 Caution and Warning Statements.....	1-3
1.2.4 Symbols used in this Manual and on Instrument	1-4
1.2.5 Impaired Safety.....	1-4
1.2.6 General Safety Information.....	1-4

1.1 Introduction to Service Manual

The Fluke 123, 124, 125 Industrial Scopemeters (hereafter referred to as ‘test tool’) offers an extensive and powerful set of measurement capabilities.

This Service Manual provides the information necessary to maintain the test tool at customer level.

The following information is presented in this Service Manual:

Chapter 1. *Introduction and safety Instructions.* Read carefully before using or servicing the test tool.

Chapter 2. *Characteristics.* A complete set of detailed specifications.

Chapter 3. *Performance Verification.*

Chapter 4. *Calibration Adjustment.*

Chapter 5. *Disassembling the test tool.*

Chapter 6. *List of Replaceable Parts.*

Important. The Main PCA in this test tool is only available to Fluke Service Centers due to the programming that is necessary after installation.

1.2 Safety

1.2.1 Introduction

Read these pages carefully before beginning to install and use the instrument.

The following paragraphs contain information, cautions and warnings which must be followed to ensure safe operation and to keep the instrument in a safe condition.

Warning

Servicing described in this manual is to be done only by qualified service personnel. To avoid electrical shock, do not service the instrument unless you are qualified to do so.

1.2.2 Safety Precautions

For the correct and safe use of this instrument it is essential that both operating and service personnel follow generally accepted safety procedures in addition to the safety precautions specified in this manual. Specific warning and caution statements, where they apply, will be found throughout the manual. Where necessary, the warning and caution statements and/or symbols are marked on the instrument.

1.2.3 Caution and Warning Statements









Caution

Used to indicate correct operating or maintenance procedures to prevent damage to or destruction of the equipment or other property.

Warning

Calls attention to a potential danger that requires correct procedures or practices to prevent personal injury.

1.2.4 Symbols used in this Manual and on Instrument

	Read the safety information in the Users Manual		DOUBLE INSULATION (Protection Class)
	Equal potential inputs, connected internally		Static sensitive components (black/yellow).
	Live voltage		Recycling information
	Earth		Disposal information
	Conformité Européenne		Do not dispose of this product as unsorted municipal waste. Go to Fluke's website for recycling information

1.2.5 Impaired Safety

Whenever it is likely that safety has been impaired, the instrument must be turned off and disconnected from line power. The matter should then be referred to qualified technicians. Safety is likely to be impaired if, for example, the instrument fails to perform the intended measurements or shows visible damage.

1.2.6 General Safety Information

Warning

Removing the instrument covers or removing parts, except those to which access can be gained by hand, is likely to expose live parts and accessible terminals which can be dangerous to life.

The instrument shall be disconnected from all voltage sources before it is opened.

Capacitors inside the instrument can hold their charge even if the instrument has been separated from all voltage sources.

Components which are important for the safety of the instrument may only be replaced by components obtained through your local FLUKE organization. These parts are indicated with an asterisk (*) in the List of Replaceable Parts, Chapter 6.

Chapter 2

Characteristics

Title	Page
2.1 Introduction.....	2-3
2.2 Dual Input Oscilloscope.....	2-3
2.2.1 Vertical.....	2-3
2.2.2 Horizontal	2-4
2.2.3 Trigger	2-4
2.2.4 Advanced Scope Functions.....	2-5
2.3 Dual Input Meter.....	2-5
2.3.1 Input A and Input B	2-5
2.3.2 Input A	2-8
2.3.3 Advanced Meter Functions	2-9
2.4 Cursor Readout (Fluke 124, 125).....	2-10
2.5 Harmonics Measurements (Fluke 125).....	2-10
2.6 Field Bus Measurements (Fluke 125).....	2-11
2.7 Miscellaneous	2-11
2.8 Environmental.....	2-12
2.9 Service and Maintenance	2-13
2.10 Safety	2-13
2.11 EMC Immunity	2-15

2.1 Introduction

Performance Characteristics

FLUKE guarantees the properties expressed in numerical values with the stated tolerance. Specified non-tolerance numerical values indicate those that could be nominally expected from the mean of a range of identical ScopeMeter test tools.

Specifications are based on a one year calibration cycle.

Environmental Data

The environmental data mentioned in this manual are based on the results of the manufacturer's verification procedures.

Safety Characteristics

The test tool has been designed and tested in accordance with Standards ANSI/ISA S82.02.01, EN 61010-1: 2001, CAN/CSA-C22.2 No.61010-1-04 (including cCSA_{us} approval), Safety Requirements for Electrical Equipment for Measurement, Control, and Laboratory Use.

Use of this equipment in a manner not specified by the manufacturer may impair protection provided by the equipment.

2.2 Dual Input Oscilloscope

2.2.1 Vertical

Frequency Response

DC Coupled:

excluding probes and test leads:

Fluke 123 (via BB120) DC to 20 MHz (-3 dB)

Fluke 124, 125 (via BB120) DC to 40 MHz (-3 dB)

with STL120 1:1 shielded test leads: DC to 12.5 MHz (-3 dB)

DC to 20 MHz (-6 dB)

with VP40 10:1 probe:

Fluke 123 (*optional accessory*) DC to 20 MHz (-3 dB)

Fluke 124, 125 (*standard accessory*) DC to 40 MHz (-3 dB)

AC Coupled (LF roll off):

excluding probes and test leads <10 Hz (-3 dB)

with STL120 <10 Hz (-3dB)

with 10:1 10MΩ Probe <1 Hz (-3 dB)

Rise Time

excluding probes and test leads:

Fluke 123 <17.5 ns

Fluke 124, 125 <8.75 ns

Input Impedance

excluding probes and test leads 1 MΩ//12 pF

with BB120 1 MΩ//20 pF

with STL120 1 MΩ//225 pF

with VP40 10:1 Probe 5 MΩ//15.5 pF

Sensitivity	5 mV to 500 V/div
Display Modes	A, -A, B, -B
△Max. Input Voltage A and B	
Direct, with test leads, or with VP40 Probe	600 Vrms
with BB120	300 Vrms
(For detailed specifications see “2.8 Safety”)	
△Max. Floating Voltage	
from any terminal to ground	600 Vrms, up to 400Hz
Resolution	8 bit
Vertical Accuracy	±(1% + 0.05 range/div)
Max. Vertical Move	±4 divisions
Max. Base Line Jump	After changing time base or sensitivity
Normal & Single mode	±0.04 divisions (= ±1 pixel)

2.2.2 Horizontal

Scope Modes	Normal, Single, Roll
Ranges	
Normal:	
equivalent sampling (Fluke 123)	20 ns to 500 ns/div
equivalent sampling (Fluke 124, 125)	10 ns to 500 ns/div
real time sampling	1 μs to 5 s/div
Single (real time)	1 μs to 5 s/div
Roll (real time)	1s to 60 s/div
Sampling Rate (for both channels simultaneously)	
Equivalent sampling (repetitive signals)	up to 1.25 GS/s
Real time sampling:	
1 μs to 5 ms/div	25 MS/s
10 ms to 5 s/div	5 MS/s
Time Base Accuracy	
Equivalent sampling	±(0.4% +0.04 time/div)
Real time sampling	±(0.1% +0.04 time/div)
Glitch Detection	
	≥40 ns @ 20 ns to 5 ms/div
	≥200 ns @ 10 ms to 60 s/div
	Glitch detection is always active.
Horizontal Move	
	10 divisions
	Trigger point can be positioned anywhere across the screen.

2.2.3 Trigger

Screen Update	Free Run, On Trigger
----------------------	----------------------

Source	A, B, EXT EXTernal via optically isolated trigger probe ITP120 (<i>optional accessory</i>)
Sensitivity A and B (Fluke 123)	
@ DC to 5 MHz	0.5 divisions or 5 mV
@ 25 MHz	1.5 divisions
@ 40 MHz	4 divisions
Sensitivity A and B (Fluke 124, 125)	
@ DC to 5 MHz	0.5 divisions or 5 mV
@ 40 MHz	1.5 divisions
@ 60 MHz	4 divisions
Voltage level error	±0.5 div. max.
Slope	Positive, Negative
Video on A	Interlaced video signals only
Modes	Lines, Line Select
Standards	PAL , NTSC, PAL+, SECAM
Polarity	Positive, Negative
Sensitivity	0.6 divisions sync.

2.2.4 Advanced Scope Functions

Display Modes

Normal	Captures up to 40 ns glitches and displays analog-like persistence waveform.
Smooth	Suppresses noise from a waveform.
Envelope	Records and displays the minimum and maximum of waveforms over time.

Auto Set (Connect-and-View™)

Continuous fully automatic adjustment of amplitude, time base, trigger levels, trigger gap, and hold-off. Manual override by user adjustment of amplitude, time base, or trigger level.

2.3 Dual Input Meter

The accuracy of all measurements is within \pm (% of reading + number of counts) from 18 °C to 28 °C.

Add 0.1x (specific accuracy) for each °C below 18 °C or above 28 °C. For voltage measurements with 10:1 probe, add probe uncertainty +1%.

More than one waveform period must be visible on the screen.

2.3.1 Input A and Input B

DC Voltage (VDC)

Ranges	500 mV, 5V, 50V, 500V, 1250V
Accuracy	±(0.5% +5 counts)
Turnover	±12 counts
Normal Mode Rejection (SMR)	>60 dB @ 50 or 60 Hz ±1%

Common Mode Rejection (CMRR)	>100 dB @ DC >60 dB @ 50, 60, or 400 Hz
Full Scale Reading	5000 counts
Move influence	±6 counts max.
True RMS Voltages (VAC and VAC+DC)	
Ranges	500 mV, 5V, 50V, 500V, 1250V
Accuracy for 5 to 100% of range	
DC coupled:	
DC to 60 Hz (VAC+DC)	±(1% +10 counts)
1 Hz to 60 Hz (VAC)	±(1% +10 counts)
AC or DC coupled:	
60 Hz to 20 kHz	±(2.5% +15 counts)
20 kHz to 1 MHz	±(5% +20 counts)
1 MHz to 5 MHz	±(10% +25 counts)
5 MHz to 12.5 MHz	±(30% +25 counts)
5 MHz to 20 MHz	±(30% +25 counts), excluding test leads or probes
AC coupled with 1:1 (shielded) test leads:	
60 Hz (6 Hz with 10:1 probe)	-1.5%
50 Hz (5 Hz with 10:1 probe)	-2%
33 Hz (3.3 Hz with 10:1 probe)	-5%
10 Hz (1 Hz with 10:1 probe)	-30%
DC Rejection (only VAC)	>50 dB
Common Mode Rejection (CMRR)	>100 dB @ DC >60 dB @ 50, 60, or 400 Hz
Full Scale Reading	5000 counts The reading is independent of any signal crest factor.
Move influence	±6 counts max.
Peak	
Modes	Max peak, Min peak, or pk-to-pk
Ranges	500 mV, 5V, 50V, 500V, 1250V
Accuracy:	
Max peak or Min peak	5% of full scale
Peak-to-Peak	10% of full scale
Full Scale Reading	500 counts
Frequency (Hz)	
Ranges	1Hz, 10Hz, 100Hz, 1 kHz, 10 kHz, 100 kHz, 1 MHz, 10 MHz, and 50 MHz (Fluke 123) or 70 MHz (Fluke 124, 125).
Frequency Range for Continuous Autoset	15Hz (1Hz) to 50 MHz

Accuracy:	
@1Hz to 1 MHz	±(0.5% +2 counts)
@1 MHz to 10 MHz	±(1.0% +2 counts)
@10 MHz to 50 MHz (Fluke 123)	±(2.5% +2 counts)
@10 MHz to 70 MHz (Fluke 124, 125) (50 MHz in Autorange)	±(2.5% +2 counts)

Full Scale Reading 10 000 counts

RPM (Fluke 125)

Max reading	50.00 kRPM
Accuracy	±(0.5% +2 counts)

Duty Cycle (DUTY)

Range	2% to 98%
Frequency Range for Continuous Autoset	15Hz (1Hz) to 30 MHz
Accuracy:	
@1Hz to 1 MHz	±(0.5% +2 counts)
@1 MHz to 10 MHz	±(1.0% +2 counts)

Pulse Width (PULSE)

Frequency Range for Continuous Autoset	15Hz (1Hz) to 30 MHz
Accuracy:	
@1Hz to 1 MHz	±(0.5% +2 counts)
@1 MHz to 10 MHz	±(1.0% +2 counts)
@10 MHz to 40 MHz	±(2.5% +2 counts)
Full Scale reading	1000 counts

Amperes (AMP)

	with optional current probe
Ranges	same as VDC, VAC, VAC+DC, or PEAK
Scale Factor	0.1 mV/A, 10 mV/A, 100 mV/A, 1 V/A
Accuracy	same as VDC, VAC, VAC+DC, or PEAK (add current probe uncertainty)

Temperature (TEMP)

	with optional temperature probe
Range	200 °C/div (200 °F/div)
Scale Factor	1 mV/°C and 1 mV/°F
Accuracy	as VDC (add temperature probe uncertainty)

Decibel (dB)

0 dBV	1V
0 dBm (600Ω /50Ω)	1 mW, referenced to 600Ω or 50Ω
dB on	VDC, VAC, or VAC+DC
Full Scale Reading	1000 counts

Crest Factor (CREST)

Range	1 to 10
Accuracy	±(5% +1 count)
Full Scale Reading	100 counts

Phase

Modes	A to B, B to A
Range	0 to 359 degrees
Accuracy	±(1 degree +1 count)
Resolution	1 degree

Power (Fluke 125)

Configurations	1 phase 3 phase 3 conductor balanced loads (3 phase: fundamental component only AUTOSET mode only)
Power Factor (PF) Range	ratio between Watts and VA 0.00 to 1.00
Watt Full Scale reading	RMS reading of multiplying corresponding samples of input A (volts) and input B (amperes) 999 counts
VA Full Scale Reading	$V_{rms} \times A_{rms}$ 999 counts
VA Reactive (VAR) Full Scale Reading	$\sqrt{((VA)^2 - W^2)}$ 999 counts

VPWM (Fluke 125)

Purpose	to measure on pulse width modulated signals, like motor drive inverter outputs
Principle	readings show the effective voltage based on the average value of samples over a whole number of periods of the fundamental frequency
Accuracy	as V_{rms} for sinewave signals

2.3.2 Input A

Ohm (Ω)

Ranges	50 Ω (Fluke 125), 500 Ω , 5 k Ω , 50 k Ω , 500 k Ω , 5 M Ω , 30 M Ω
Accuracy	±(0.6% +5 counts)
Full Scale Reading 500 Ω to 5 M Ω 30 M Ω	5000 counts 3000 counts
Measurement Current	0.5 mA to 50 nA decreases with increasing ranges

Open Circuit Voltage	<4V
Continuity (CONT)	
Beep	30Ω ± 5Ω in 50Ω range
Measurement Current	0.5 mA
Detection of shorts of	≥1 ms
Diode	
Maximum Voltage:	
@0.5 mA	>2.8V
@open circuit	<4V
Accuracy	±(2% +5 counts)
Measurement Current	0.5 mA
Polarity	+ on input A, - on COM
Capacitance (CAP)	
Ranges	50 nF, 500 nF, 5 μF, 50 μF, 500 μF
Accuracy	±(2% +10 counts)
Full Scale Reading	5000 counts
Measurement Current	5 μA to 0.5 mA, increases with increasing ranges
Measurement principle	Dual slope integrating measurement with parasitic serial and parallel resistance cancellation.
 2.3.3 Advanced Meter Functions	
Zero Set	Set actual value to reference
Fast/Normal/Smooth	
Meter settling time Fast	1s @ 1μs to 10 ms/div
Meter settling time Normal	2s @ 1μs to 10 ms/div
Meter settling time Smooth	10s @ 1μs to 10 ms/div
Touch Hold (on A)	Captures and freezes a stable measurement result. Beeps when stable. Touch Hold works on the main meter reading, with thresholds of 1 Vpp for AC signals and 100mV for DC signals.
TrendPlot	Graphs meter readings of the Min and Max values from 15 s/div (120 seconds) to 2 days/div (16 days) with time and date stamp. Automatic vertical scaling and time compression. Displays the actual and Minimum, Maximum, or average (AVG) reading.
Fixed Decimal Point	Possible by using attenuation keys.

2.4 Cursor Readout (Fluke 124, 125)

Sources	A,B
Single Vertical Line	Average, Min and Max Readout. Average, Min, Max and Time from Start of Readout (in ROLL mode, instrument in HOLD). Min, Max and Time from Start of Readout (in TRENDPLOT mode, instrument in HOLD).
Dual Vertical Lines	Peak-Peak, Time Distance and Reciprocal Time Distance Readout. Average, Min, Max and Time Distance Readout (in ROLL mode, instrument in HOLD).
Dual Horizontal Lines	High, Low and Peak-Peak Readout.
Rise or Fall Time	Transition Time, 0%-Level and 100%-Level Readout (Manual or Auto Leveling: Auto Leveling only possible in Single Channel Mode).
Accuracy	As Oscilloscope Accuracy.

2.5 Harmonics Measurements (Fluke 125)

Number of Harmonics	DC ... 33 (< 60 Hz), DC ... 24 (400 Hz)
Readings / Cursor readings (fundamental	40...70 Hz)
V rms / A rms	fund. $\pm(3\% + 2 \text{ counts})$, 33st $\pm(5\% + 3 \text{ counts})$
Watt	fund. $\pm(5\% + 10 \text{ counts})$, 33st $\pm(10\% + 10 \text{ counts})$
Frequency of fundamental	$\pm 0.25 \text{ Hz}$
Phase Angle	fund. $\pm 3^\circ$... 33st $\pm 15^\circ$
K-factor (in Amp and Watt)	$\pm 10\%$
Time base	fixed

2.6 Field Bus Measurements (Fluke 125)

Type	Subtype	Protocol
AS-i		NEN-EN50295
CAN		ISO-11898
Interbus S	RS-422	EIA-422
ControlNet		61158 type 2
Modbus	RS-232 RS-485	RS-232/EIA-232 RS-485/EIA-485
Foundation Fieldbus	H1 H2	61158 type 1, 31.25 kBit 61158 type 1 ≤ 10 Mbit
Profibus	DP PA	EIA-485 61158 type 1
Ethernet	Coax TP	10Base2 10BaseT
RS-232		EIA-232
RS-485		EIA-485

2.7 Miscellaneous

Display

Size	72 x 72 mm (2.83 x 2.83 in)
Resolution	240 x 240 pixels
Waveform display:	
Vertical	8 divisions of 20 pixels
Horizontal	9.6 divisions of 25 pixels
Backlight	Cold Cathode Fluorescent (CCFL)

Power

External:	via Power Adapter PM8907
Input Voltage	10 to 21V DC
Power	5W typical
Input Connector	5 mm jack
Internal Battery Pack BP120MH:	
Battery Power	Rechargeable Ni-MH 4.8V
Operating Time	6 hours with bright backlight 6.5 hours with dimmed backlight
Charging Time	7 hours with test tool off 60 hours with test tool on 12 ... 20 hours with refresh cycle
Allowable ambient temperature during charging	0 to 45 °C (32 to 113 °F)

Memory

Number of Screen + Setup Memories

Fluke 123	10
Fluke 124	20

Number of Data Set memories

Fluke 125	20
-----------	----

Mechanical

Size	232 x 115 x 50 mm (9.1 x 4.5 x 2 in)
Weight	1.2 kg (2.5 lbs), including battery pack.

Interface

To Printer	RS-232, optically isolated supports Epson FX, LQ, and HP Deskjet®, Laserjet®, and Postscript Serial via PM9080 (optically isolated RS232 adapter/cable, optional). Parallel via PAC91 (optically isolated print adapter cable, optional).
To PC	Dump and load settings and data. Serial via OC4USB (optically isolated RS232/USB adapter/cable, optional), using SW90W (FlukeView software for Windows).

2.8 Environmental

Environmental

MIL-PRF-28800F, Class 2

Temperature

Operating	0 to 50 °C (32 to 122 °F)
Storage	-20 to 60 °C (-4 to 140 °F)

Humidity

Operating:	
@0 to 10 °C (32 to 50 °F)	noncondensing
@10 to 30 °C (50 to 86 °F)	95%
@30 to 40 °C (86 to 104 °F)	75%
@40 to 50 °C (104 to 122 °F)	45%
Storage:	
@-20 to 60 °C (-4 to 140 °F)	noncondensing

Altitude

Operating	5 km (16 400 feet) Max. Input and Floating Voltage 600 Vrms Cat III up to 2 km, > 2 km 300 Vrms Cat III < 5 km
Storage	12 km (40 000 feet)

Vibration (Sinusoidal)

MIL28800F, Class 2, 3.8.4.2, 4.5.5.3.1,
Max. 3g

Shock

MIL28800F, Class 2, 3.8.5.1, 4.5.5.4.1,
Max. 30g

Fungus Resistance

MIL28800F, Class 3, 3.8.7 & 4.5.6.1

Salt Exposure	MIL28800F, Class 2, 3.8.8.2 & 4.5.6.2.2. Structural parts meet 48 hours 5% salt solution test.
Electromagnetic Compatibility (EMC)	
Emission	EN 50081-1 (1992): EN55022 and EN60555-2
Immunity	EN 50082-2(1992): IEC1000-4-2, -3, -4, -5 (see also Section 2.9, Tables 2-1 to 2-3)
Enclosure Protection	IP51, ref: IEC529

2.9 Service and Maintenance

Calibration Interval 1 Year

2.10 Safety

△ Designed for measurements on 600 Vrms Category III Installations, Pollution Degree 2, per:

- ANSI/ISA S82.02.01
- EN 61010-1: 2001
- CAN/CSA-C22.2 No.61010-1-04 (including cCSA_{us} approval)

△ Max. Input Voltage Input A and B

Direct on input, with leads, with VP40	600 Vrms. For derating see Figure 2-1/2.
With Banana-to-BNC Adapter BB120	300V rms. For derating see Figure 2-1.

△ Max. Floating Voltage

from any terminal to ground 600 Vrms up to 400Hz

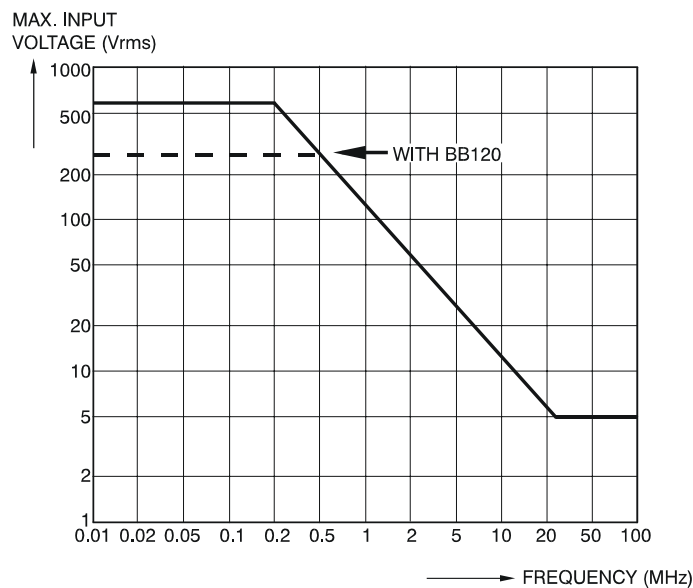

Figure 2-1. Maximum Input Voltage vs Frequency

ST8112.CGM

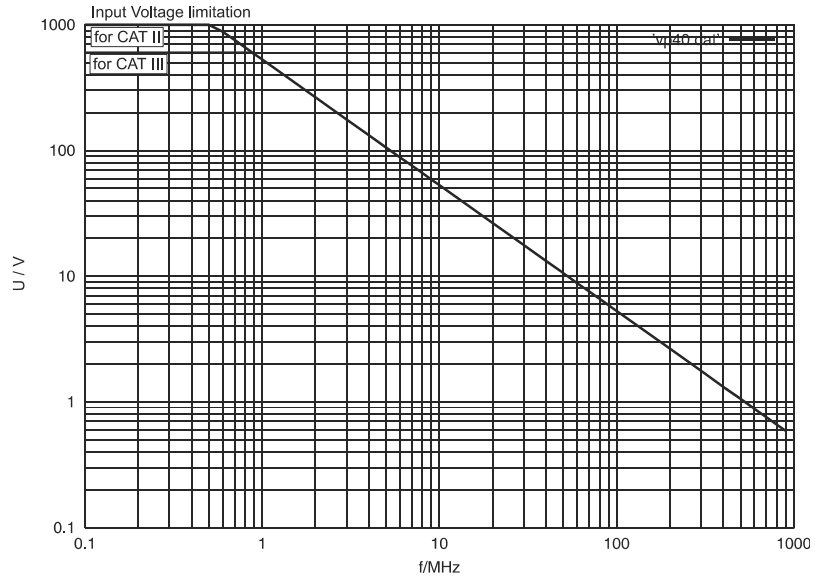

Figure 2-2. Max. Input Voltage v.s. Frequency for VP40 10:1 Voltage Probe

2.11 EMC Immunity

The Fluke 123/124/125, including standard accessories, conforms with the EEC directive 89/336 for EMC immunity, as defined by IEC1000-4-3, with the addition of tables 2-1 to 2-3.

Trace Disturbance with STL120

See Table 2-1 and Table 2-2.

Table 2-1. No Visible Trace Disturbance

No visible disturbance	E= 3 V/m	E= 10 V/m
Frequency range 10 kHz to 27 MHz	100 mV/div to 500 V/div	500 mV/div to 500 V/div
Frequency range 27 MHz to 1 GHz	100 mV/div to 500 V/div	100 mV/div to 500 V/div

Table 2-2. Trace Disturbance < 10%

Disturbance less than 10% of full scale	E= 3 V/m	E= 10 V/m
Frequency range 10 kHz to 27 MHz	20 mV/div to 50 mV/div	100 mV/div to 200 mV/div
Frequency range 2 MHz to 1 GHz	10 mV/div to 20 mV/div	-

(-): no visible disturbance

Test tool ranges not specified in Table 2-1 and Table 2-2 may have a disturbance of more than 10% of full scale.

Multimeter disturbance

See Table 2-3.

- VDC, VAC, and VAC+DC with STL 120 and short ground lead
- OHM, CONT, DIODE, and CAP with STL120 and black test lead to COM

Table 2-3. Multimeter Disturbance < 1%

Disturbance less than 1% of full scale	E= 3 V/m	E= 10 V/m
Frequency range 10 kHz to 27 MHz		
VDC, VAC, VAC+DC	500 mV to 1250V	500 mV to 1250V
OHM, CONT, DIODE	50Ω to 30 MΩ	500Ω to 30 MΩ
CAP	50 nF to 500 μF	50 nF to 500 μF
Frequency range 27 MHz to 1 GHz		
VDC, VAC, VAC+DC	500 mV to 1250V	500 mV to 1250V
OHM, CONT, DIODE	50Ω to 30 MΩ	500Ω to 30 MΩ
CAP	50 nF to 500 μF	50 nF to 500 μF

Test tool ranges not specified in Table 2-3 may have a disturbance of more than 10% of full scale.

Chapter 3

Performance Verification

Title	Page
3.1 Introduction.....	3-3
3.2 Equipment Required For Verification	3-3
3.3 How To Verify.....	3-4
3.4 Display and Backlight Test.....	3-4
3.5 Input A and Input B Tests.....	3-5
3.5.1 Input A and B Base Line Jump Test	3-6
3.5.2 Input A Trigger Sensitivity Test	3-8
3.5.3 Input A Frequency Response Upper Transition Point Test	3-9
3.5.4 Input A Frequency Measurement Accuracy Test	3-9
3.5.5 Input B Frequency Measurement Accuracy Test.....	3-10
3.5.6 Input B Frequency Response Upper Transition Point Test.....	3-11
3.5.7 Input B Trigger Sensitivity Test	3-12
3.5.8 Input A and B Trigger Level and Trigger Slope Test	3-13
3.5.9 Input A and B DC Voltage Accuracy Test	3-16
3.5.10 Input A and B AC Voltage Accuracy Test	3-18
3.5.11 Input A and B AC Input Coupling Test	3-19
3.5.12 Input A and B Volts Peak Measurements Test	3-20
3.5.13 Input A and B Phase Measurements Test	3-21
3.5.14 Harmonics (Fluke 125)	3-21
3.5.15 Input A and B High Voltage AC/DC Accuracy Test.....	3-22
3.5.16 Resistance Measurements Test	3-24
3.5.17 Continuity Function Test	3-25
3.5.18 Diode Test Function Test.....	3-26
3.5.19 Capacitance Measurements Test.....	3-26
3.5.20 Video Trigger Test.....	3-27

3.1 Introduction

Warning

Procedures in this chapter should be performed by qualified service personnel only. To avoid electrical shock, do not perform any servicing unless you are qualified to do so.

The test tool should be calibrated and in operating condition when you receive it.

The following performance tests are provided to ensure that the test tool is in a proper operating condition. If the test tool fails any of the performance tests, calibration adjustment (see Chapter 4) and/or repair (see Chapter 7) is necessary.

The Performance Verification Procedure is based on the specifications, listed in Chapter 2 of this Service Manual. The values given here are valid for ambient temperatures between 18 °C and 28 °C.

The Performance Verification Procedure is a quick way to check most of the test tool's specifications. Because of the highly integrated design of the test tool, it is not always necessary to check all features separately. For example: the duty cycle, pulse width, and frequency measurement are based on the same measurement principles; so only one of these functions needs to be verified.

3.2 Equipment Required For Verification

The primary source instrument used in the verification procedures is the Fluke 5500A. If a 5500A is not available, you can substitute another calibrator as long as it meets the minimum test requirements.

- Fluke 5500A Multi Product Calibrator, including 5500A-SC Oscilloscope Calibration Option.
- Stackable Test Leads (4x), supplied with the 5500A.
- 50Ω Coax Cables (2x), Fluke PM9091 (1.5m) or PM9092 (0.5m).
- 50Ω feed through terminations (2x), Fluke PM9585.
- Fluke BB120 Shielded Banana to Female BNC adapters (2x), supplied with the Fluke 123.
- Dual Banana Plug to Female BNC Adapter (1x), Fluke PM9081/001.
- Dual Banana Jack to Male BNC Adapter (1x), Fluke PM9082/001.
- TV Signal Generator, Philips PM5418.
- 75Ω Coax cable (1x), Fluke PM9075.
- 75Ω Feed through termination (1x), ITT-Pomona model 4119-75.
- PM9093/001 Male BNC to Dual Female BNC Adapter

Note: if you have a Fluke 5500A with 600 MHz Oscilloscope Option, you do not require a separate TV Signal Generator, a 75Ω Coax cable, a 75Ω Feed through termination, and a Fluke PM9082/001 Adapter. Fluke 5500A with 600 MHz option can generate video signals.

These video signals must be applied to the test tool via a 50Ω Coax Cable and terminated with a 50Ω feed through termination.

3.3 How To Verify











Verification procedures for the display function and measure functions follow. For each procedure the test requirements are listed. If the result of the test does not meet the requirements, the test tool should be recalibrated or repaired if necessary. Some of the tests are slightly different for Fluke 123, 124, and Fluke 125. This is caused by the higher vertical and trigger bandwidth in Fluke 124 and 125. Moreover Fluke 125 has extra measuring functions and a slightly different way of operation. Differences in requirements for Fluke 123, 124, and 125 are clearly indicated.

Follow these general instructions for all tests:

- For all tests, power the test tool with the PM8907 power adapter. A charged The battery pack must be installed.
- Allow the 5500A to satisfy its specified warm-up period.
- For each test point , wait for the 5500A to settle.
- Allow the test tool a minimum of 20 minutes to warm up.

3.4 Display and Backlight Test

Proceed as follows to test the display and the backlight:

1. Press  to turn the Test tool on.
2. Fluke 123: press  and verify that the backlight is dimmed. Then select maximum backlight brightness again.
Fluke 124/125: press , then press . Verify that the test tool can be switched between dimmed backlight and maximum brightness with the  keys. During the tests, use maximum brightness for the best visibility.
3. Remove the adapter power, and verify that the backlight is dimmed.
4. Apply the adapter power and verify that the backlight brightness is set to maximum.
5. Press and hold .
6. Press and release .
7. Release .
The test tool shows the calibration menu in the bottom of the display.
Do not press  now! If you did, turn the test tool off and on, and start at 5.
8. Press  (PREV) three times.
The test tool shows **Contrast (CL 0100):MANUAL**
9. Press  (CAL) .
The test tool shows a dark display; the test pattern as shown in Figure 3-1 may not be

visible or hardly visible.

Observe the display closely, and verify that no light pixels are shown.

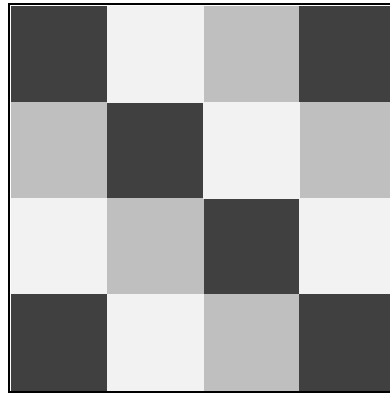

Figure 3-1. Display Pixel Test Pattern

11. Press **F2**.
 The test pattern is removed; the test tool shows **Contrast (CL 0110):MANUAL**
12. Press **F3** (CAL) .
 The test tool shows the display test pattern shown in Figure 3-1, at default contrast.
 Observe the test pattern closely, and verify that the no pixels with abnormal contrast are present in the display pattern squares. Also verify that the contrast of the upper left and upper right square of the test pattern are equal.
13. Press **F2**.
 The test pattern is removed; the test tool shows **Contrast (CL 0120):MANUAL**
14. Press **F3** (CAL) .
 The test tool shows a light display; the test pattern as shown in Figure 3-1 may not be visible or hardly visible.
 Observe the display closely, and verify that no dark pixels are shown.
15. Turn the test tool OFF and ON to exit the calibration menu and to return to the normal operating mode.

3.5 Input A and Input B Tests

During verification you must open menus, and to choose items from the menu.

Proceed as follows to make choices in a menu (see Figure 3.2):

- Open the menu, for example press **MENU** (new) or **SCOPE MENU** (old) .
- Press **▲** **▼** to highlight the item to be selected in a menu.
- Press **F4** to confirm the selection and to jump to the next item group (if present). Item groups in a menu are separated by a vertical line.
- After pressing **F4** in the last menu item group, the menu is closed.

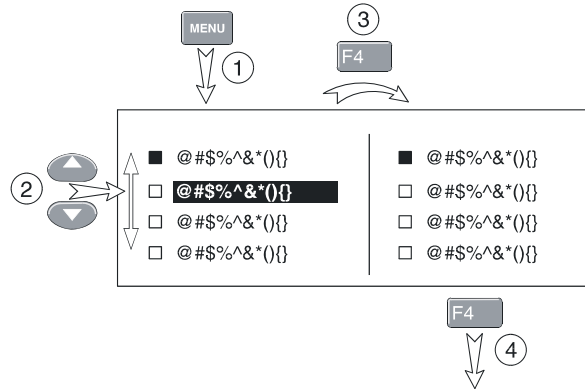

Figure 3-2. Menu item selection

ST7968.WMF

If an item is selected, it is marked by . Not selected items are marked by . If a selected item is highlighted, an then **F4** is pressed, the item remains selected.

You can also navigate through the menu using . To conform the highlighted item you must press **F4**.

Before performing the Input A and Input B tests, the test tool must be set in a defined state, by performing a RESET.

Proceed as follows to reset the test tool:

- Press to turn the test tool off.
- Press and hold .
- Press and release to turn the test tool on.

Wait until the test tool has **beeped twice**, and then release . When the test tool has beeped twice, the RESET was successful.

For most tests, you must turn Input B on. Input A is always on.

Proceed as follows to turn Input B on:

- Press **VHzA** to open the Meter B menu.
- Using select **INPUT B: ON** .
- Press **F4** to confirm the selection; the mark changes to . The active setting from the next item group will be highlighted (for example **Vac**), and maintained after leaving the menu.
- Press **F4** to exit the menu.

3.5.1 Input A and B Base Line Jump Test

Proceed as follows to check the Input A and Input B base line jump:

1. Short circuit the Input A and the Input B shielded banana sockets of the test tool. Use the BB120 banana to BNC adapter, and a 50Ω (or lower) BNC termination.
2. Select the following test tool setup:
 - Turn Input B on (if not already on).
 - Press **AUTO** to select auto ranging (**AUTO** in top of display).
(**AUTO** toggles between **AUTO** and **MANUAL** ranging).
 - Fluke 123/124: press **MENU** / **SCOPE MENU** to open the SCOPE INPUTS menu.
 - Fluke 123/124: press **F1** to open the SCOPE OPTIONS menu, and choose :
SCOPE MODE: ● NORMAL | WAVEFORM MODE: ● SMOOTH
 - Fluke 125: press **MENU** to open MENU.
 - Fluke 125: press **F1** to open the TRIGGER menu, and choose :
UPDATE: ● FREE RUN
 - Fluke 125: press **F2** to open the SMOOTH menu, and choose :
WAVEFORM: ● SMOOTH
 - Press **F4** to leave the menus.
3. Using **TIME ns** toggle the time base between 10 ms/div and 5 ms/div.
(the time base ranging is set to manual now, the input sensitivity is still automatic; no indication **AUTO** or **MANUAL** is displayed).
After changing the time base wait some seconds until the trace has settled.
Observe the Input A trace, and check to see if it returns to the same position after changing the time base. The allowed difference is ±0.04 division (= 1 pixel).
Observe the Input B trace for the same conditions.
4. Using **TIME ns** toggle the time base between 1 μs/div and 500 ns/div. After changing the time base wait some seconds until the trace has settled.
Observe the Input A trace, and check to see if it is set to the same position after changing the time base. The allowed difference is ±0.04 division (= 1 pixel).
Observe the Input B trace for the same conditions.
5. Using **TIME ns** set the time base to 10 ms/div.
6. Using **mV** **V** toggle the sensitivity of Input A between 5 and 10 mV/div. After changing the sensitivity wait some seconds until the trace has settled.
Observe the Input A trace, and check to see if it is set to the same position after changing the sensitivity. The allowed difference is ±0.04 division (= 1 pixel).
7. Using **mV** **V** toggle the sensitivity of Input B between 5 and 10 mV/div. After changing the sensitivity wait some seconds until the trace has settled.

Observe the Input B trace, and check to see if it is set to the same position after changing the sensitivity. The allowed difference is ± 0.04 division (= 1 pixel).

8. When you are finished, remove the Input A and Input B short.

3.5.2 Input A Trigger Sensitivity Test

Proceed as follows to test the Input A trigger sensitivity:

1. Connect the test tool to the 5500A as shown in Figure 3-3.

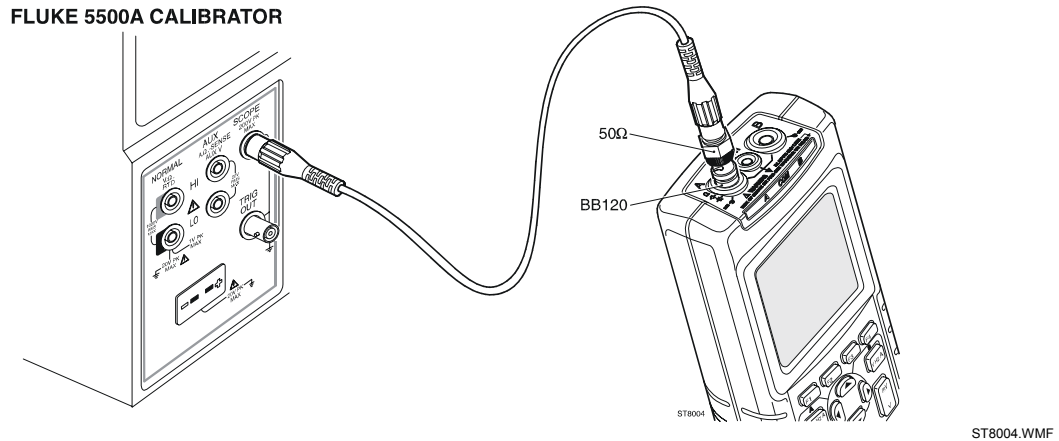

Figure 3-3. Test Tool Input A to 5500A Scope Output 50Ω

2. Select the following test tool setup:
 - Press **AUTO** to select auto ranging (**AUTO** in top of display). Do not press **TIME ns** anymore!
 - Using **mV** **V** change the sensitivity to select manual sensitivity ranging, and lock the Input A sensitivity on 200 mV/div.
3. Set the 5500A to source a 5 MHz leveled sine wave of 100 mV peak-to-peak (SCOPE output, MODE levsine). Set the 5500A to Operate (OPR).
4. Adjust the amplitude of the sine wave to 0.5 division on the display.
5. Verify that the signal is well triggered.
If it is not, press **F3** to enable the up/down arrow keys for Trigger Level adjustment; adjust the trigger level using **▲** **▼** and verify that the signal will be triggered now. The trigger level is indicated by the trigger icon (⌋).
6. Set the 5500A to source a 25 MHz (Fluke 123) or 40 MHz (Fluke 124/125) leveled sine wave of 400 mV peak-to-peak.
7. Adjust the amplitude of the sine wave to 1.5 divisions on the test tool display.
8. Verify that the signal is well triggered.
If it is not, press **F3** to enable the up/down arrow keys for Trigger Level adjustment; adjust the trigger level and verify that the signal will be triggered now.

9. Set the 5500A to source a 40 MHz (Fluke 123) or 60 MHz (Fluke 124/125) leveled sine wave of 1.8V peak-to-peak.
10. Adjust the amplitude of the sine wave to 4 divisions on the test tool display.
11. Verify that the signal is well triggered.
If it is not, press **F0** to enable the up/down arrow keys for Trigger Level adjustment; adjust the trigger level and verify that the signal will be triggered now.
12. When you are finished, set the 5500A to Standby.

3.5.3 Input A Frequency Response Upper Transition Point Test

Proceed as follows to test the Input A frequency response upper transition point:

1. Connect the test tool to the 5500A as for the previous test (see Figure 3-3).
2. Select the following test tool setup:
 - Press **AUTO** to select auto ranging (**AUTO** in top of display).
Do not press **TIME ns** anymore!
 - Using **mV** **V** change the sensitivity to select manual sensitivity ranging, and lock the Input A sensitivity on 200 mV/div.
3. Set the 5500A to source a leveled sine wave of 1.2V peak-to-peak, 50 kHz (SCOPE output, MODE levsine). Set the 5500A to Operate (OPR).
4. Adjust the amplitude of the sine wave to 6 divisions on the test tool display.
5. Set the 5500A to 20 MHz (Fluke 123) or 40 MHz (Fluke 124/125), without changing the amplitude.
6. Observe the Input A trace check to see if it is ≥ 4.2 divisions.
7. When you are finished, set the 5500A to Standby.

Note

The lower transition point is tested in Section 3.5.11.

3.5.4 Input A Frequency Measurement Accuracy Test

Proceed as follows to test the Input A frequency measurement accuracy:

1. Connect the test tool to the 5500A as for the previous test (see Figure 3-3).
2. Select the following test tool setup:
 - Press **AUTO** to select auto ranging (**AUTO** in top of display).
 - Press **VHzA** **Ω *** to open the INPUT A MEASUREMENTS menu, and choose:
MEASURE on A: • Hz
3. Set the 5500A to source a leveled sine wave of 600 mV peak-to-peak (SCOPE output, MODE levsine). Set the 5500A to Operate (OPR).
4. Set the 5500A frequency according to the first test point in Table 3-1.



205 Westwood Ave
Long Branch, NJ 07740
1-877-742-TEST (8378)
Fax: (732) 222-7088
salesteam@Tequipment.NET

5. Observe the Input A main reading on the test tool and check to see if it is within the range shown under the appropriate column.
6. Continue through the test points.
7. When you are finished, set the 5500A to Standby.

Table 3-1. Input A,B Frequency Measurement Accuracy Test

5500A output, 600 mVpp	Input A, B Reading
1 MHz	0.993 to 1.007 MHz
10 MHz	09.88 to 10.12 MHz
40 MHz	38.98 to 41.02 MHz
60 MHz (Fluke 124/125 only)	58.48 to 61.52 MHz

Note

Duty Cycle and Pulse Width measurements are based on the same principles as Frequency measurements. Therefore the Duty Cycle and Pulse Width measurement function will not be verified separately.

3.5.5 Input B Frequency Measurement Accuracy Test

Proceed as follows to test the Input B frequency measurement accuracy:

1. Connect the test tool to the 5500A as shown in Figure 3-4.

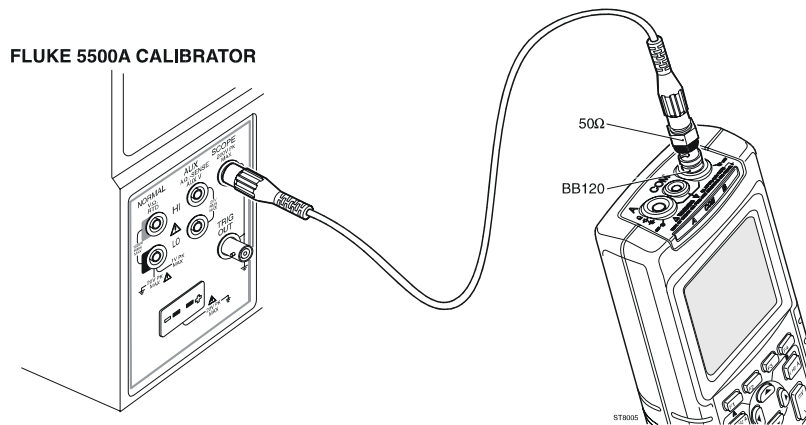

Figure 3-4. Test Tool Input B to 5500A Scope Output 50Ω

ST8005.WMF

2. Select the following test tool setup:
 - Press **AUTO** select auto ranging (**AUTO** in top of display).
 - Press **VHzA** to open the INPUT B MEASUREMENTS menu, and choose:
INPUT B: ● ON | MEASURE on B: ● Hz
 - Fluke 123/124: press **MENU** / **SCOPE MENU** to open the SCOPE INPUTS menu.

- Fluke 123/124: press **F3** to open the TRIGGER menu, and choose:
INPUT: ● B | SCREEN UPDATE: ● FREE RUN | AUTO RANGE: ● >15Hz
 - Fluke 125: press **MENU** to open MENU.
 - Fluke 125: press **F1** to open the TRIGGER menu, and choose :
INPUT: ● B | UPDATE: ● FREE RUN | AUTO RANGE: ● >15Hz
3. Set the 5500A to source a leveled sine wave of 600 mV peak-to-peak (SCOPE output, MODE levsine). Set the 5500A to Operate (OPR).
 4. Set the 5500A frequency according to the first test point in Table 3-1.
 5. Observe the Input B main reading on the test tool and check to see if it is within the range shown under the appropriate column.
 6. Continue through the test points.
 7. When you are finished, set the 5500A to Standby.

3.5.6 Input B Frequency Response Upper Transition Point Test

Proceed as follows to test the Input B frequency response upper transition point:

1. Connect the test tool to the 5500A as for the previous test (see Figure 3-4).
2. Select the following test tool setup:
 - Turn Input B on (if not already on).
 - Press **AUTO** to select auto ranging (**AUTO** in top of display).
Do not press **TIME** anymore!
 - Using **mV** **V** change the sensitivity to select manual sensitivity ranging, and lock the Input B sensitivity on 200 mV/div.
 - Fluke 123/124: press **MENU** / **SCOPE MENU** to open the SCOPE INPUTS menu.
 - Fluke 123/124: press **F3** to open the TRIGGER menu, and choose:
INPUT: ● B | SCREEN UPDATE: ● FREE RUN | AUTO RANGE: ● >15Hz
 - Fluke 125: press **MENU** to open MENU.
 - Fluke 125: press **F1** to open the TRIGGER menu, and choose :
INPUT: ● B | UPDATE: ● FREE RUN | AUTO RANGE: ● >15Hz
3. Set the 5500A to source a leveled sine wave of 1.2V peak-to-peak, 50 kHz (SCOPE output, MODE levsine). Set the 5500A to Operate (OPR).
4. Adjust the amplitude of the sine wave to 6 divisions on the test tool display.
5. Set the 5500A to 20 MHz (Fluke 123) or 40 MHz (Fluke 124/125), without changing the amplitude.
6. Observe the Input B trace check to see if it is ≥ 4.2 divisions.
7. When you are finished, set the 5500A to Standby.

Note

The lower transition point is tested in Section 3.5.11.

3.5.7 Input B Trigger Sensitivity Test

Proceed as follows to test the Input B trigger sensitivity:

1. Connect the test tool to the 5500A as for the previous test (see Figure 3-4).
2. Select the following test tool setup:
 - Turn Input B on (if not already on).
 - Press **AUTO** to select auto ranging (**AUTO** in top of display).
Do not press **TIME ns** anymore!
 - Using **mV** / **V** change the sensitivity to select manual sensitivity ranging, and lock the Input B sensitivity on 200 mV/div.
 - Fluke 123/124: press **MENU** / **SCOPE MENU** to open the SCOPE INPUTS menu.
 - Fluke 123/124: press **F3** to open the TRIGGER menu, and choose:
INPUT: ● B | SCREEN UPDATE: ● FREE RUN | AUTO RANGE: ● >15Hz
 - Fluke 125: press **MENU** to open MENU.
 - Fluke 125: press **F1** to open the TRIGGER menu, and choose :
INPUT: ● B | UPDATE: ● FREE RUN | AUTO RANGE: ● >15Hz
3. Set the 5500A to source a 5 MHz leveled sine wave of 100 mV peak-to-peak (SCOPE output, MODE levsine). Set the 5500A to Operate (OPR).
4. Adjust the amplitude of the sine wave to 0.5 division on the display.
5. Verify that the signal is well triggered.
If it is not, press **F3** to enable the up/down arrow keys for Trigger Level adjustment; adjust the trigger level and verify that the signal will be triggered now. The trigger level is indicated by the trigger icon (⌋).
6. Set the 5500A to source a 25 MHz (Fluke 123) or 40 MHz (Fluke 124/125) leveled sine wave of 400 mV peak-to-peak.
7. Adjust the amplitude of the sine wave 1.5 divisions on the test tool display.
8. Verify that the signal is well triggered.
If it is not, press **F3** to enable the up/down arrow keys for Trigger Level adjustment; adjust the trigger level and verify that the signal will be triggered now.
9. Set the 5500A to source a 40 MHz (Fluke 123) or 60 MHz (Fluke 124/125) leveled sine wave of 1.8V peak-to-peak.
10. Adjust the amplitude of the sine wave to exactly 4 divisions on the test tool display.
11. Verify that the signal is well triggered.
If it is not, press **F3** to enable the up/down arrow keys for Trigger Level adjustment; adjust the trigger level and verify that the signal will be triggered now.

12. When you are finished, set the 5500A to Standby.

3.5.8 Input A and B Trigger Level and Trigger Slope Test

Proceed as follows:

1. Connect the test tool to the 5500A as shown in Figure 3-5.

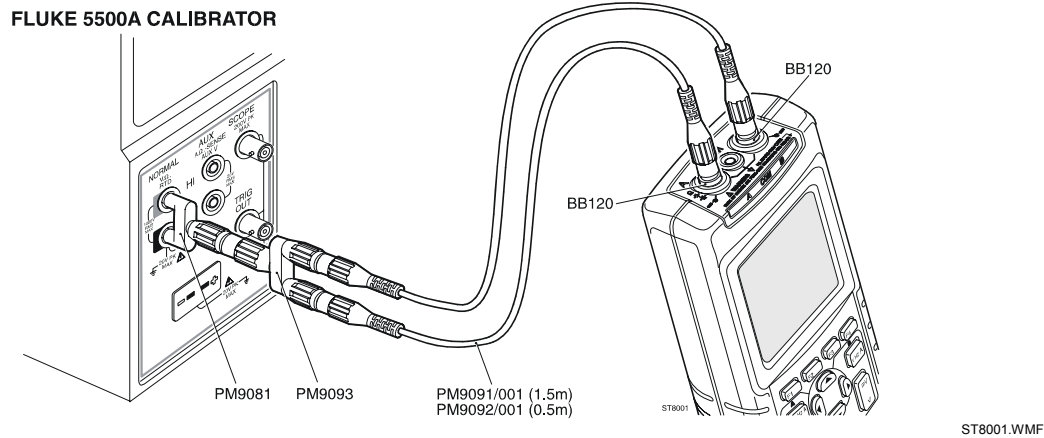





























Figure 3-5. Test Tool Input A-B to 5500A Normal Output

























2. Select the following test tool setup:

- Turn Input B on (if not already on).
- Using **mV** **v** change the sensitivity to select manual sensitivity ranging, and lock the Input A and Input B sensitivity on 1V/div.
- Move the Input A and Input B ground level (indicated by zero icon) to the center grid line. Proceed as follows:
 - ⇒ Press **F1** to enable the arrow keys for moving the Input A ground level.
 - ⇒ Press **F2** to enable the arrow keys for moving the Input B ground level.
 - ⇒ Using the **▲** **▼** keys move the ground level.
- Using **s TIME ns** change the time base to select manual time base ranging, and lock the time base on 10 ms/div.
- Fluke 123/124: press **MENU** / **SCOPE MENU** to open the SCOPE INPUTS menu.
- Fluke 123/124: press **F3** to open the TRIGGER menu, and choose:

INPUT: ● A | SCREEN UPDATE: ● FREE RUN | AUTO RANGE: ● >15Hz
- Fluke 125: press **MENU** to open MENU.
- Fluke 125: press **F1** to open the TRIGGER menu, and choose :

INPUT: ● A | UPDATE: ● FREE RUN | AUTO RANGE: ● >15Hz
- Press **F3** to enable the arrow keys for Trigger Level and Slope adjustment.

- Using   select positive slope triggering (trigger icon ).
 - Using   set the trigger level to +2 divisions from the screen center. For **positive slope** triggering, the trigger level is the **top** of the trigger icon (.
 - Fluke 123/124: press  /  to open the SCOPE INPUTS menu.
 - Fluke 123/124: press  to open the SCOPE OPTIONS menu, and choose :
SCOPE MODE: ● SINGLE SHOT | WAVEFORM MODE: ● NORMAL
 - Fluke 125: press  to open MENU.
 - Fluke 125: press  to open the TRIGGER menu, and choose :
UPDATE: ● SINGLE
 - Fluke 125: press  to open the SMOOTH menu, and choose :
WAVEFORM: ● NORMAL
3. Set the 5500A to source 0.4V DC and to OPR.
 4. Verify that no trace is shown on the test tool display, and that the status line at the display bottom shows **Wait:A** . If the display shows the traces and status **Hold:A** , then press  to re-arm the test tool for a trigger.
 5. Increase the 5500A voltage slowly in 0.1V steps, using the 5500A EDIT FIELD function, until the test tool is triggered, and the traces are shown.
 6. Verify that the 5500A voltage is between **+1.5V and +2.5V** when the test tool is triggered. To repeat the test, start at step 3.
 7. Set the 5500A to Standby.
 8. Press  to clear the display.
 9. Press  to enable the arrow keys for Trigger Level and Slope adjustment.
 10. Using   select negative slope triggering (.
 11. Using   set the trigger level to +2 divisions from the screen center. For **negative slope** triggering, the trigger level is the **bottom** of the trigger icon (.
 12. Set the 5500A to source +3V DC and to OPR.
 13. Verify that no trace is shown on the test tool display, and that the status line at the display bottom shows **Wait:A** . If the display shows the traces and status **Hold:A** , then press  to re-arm the test tool for a trigger.
 14. Decrease the 5500A voltage slowly in 0.1V steps, using the 5500A EDIT FIELD function, until the test tool is triggered, and the traces are shown.
 15. Verify that the 5500A voltage is between **+1.5V and +2.5V** when the test tool is triggered. To repeat the test, start at step 12.
 16. Set the 5500A to Standby.
 17. Press  to clear the display.

















18. Select the following test tool setup:
 - Fluke 123/124: press  /  to open the SCOPE INPUTS menu.
 - Fluke 123/124: press  to open the TRIGGER menu, and choose:
INPUT: ● A | SCREEN UPDATE: ● FREE RUN | AUTO RANGE: ● >15Hz
 - Fluke 125: press  to open MENU.
 - Fluke 125: press  to open the TRIGGER menu, and choose :
INPUT: ● A | UPDATE: ● FREE RUN | AUTO RANGE: ● >15Hz
 - Press  to enable the arrow keys for Trigger Level and Slope adjustment.
 - Using  select positive slope triggering (trigger icon ).
 - Using   set the trigger level to +2 divisions from the screen center. For **positive slope** triggering, the trigger level is the **top** of the trigger icon (.
19. Set the 5500A to source 0.4V DC and to OPR.
20. Verify that no trace is shown on the test tool display, and that the status line at the display bottom shows **Wait:B** . If the display shows the traces and status **Hold:B** , then press  to re-arm the test tool for a trigger.
21. Increase the 5500A voltage slowly in 0.1V steps, using the 5500A EDIT FIELD function, until the test tool is triggered, and the traces are shown.
22. Verify that the 5500A voltage is between **+1.5V and +2.5V** when the test tool is triggered.
To repeat the test, start at step 19.
23. Set the 5500A to Standby.
24. Press  to clear the display.
25. Press  to enable the arrow keys for Trigger Level and Slope adjustment.
26. Using  select negative slope triggering (.
27. Using   set the trigger level to +2 divisions from the screen center. For **negative slope** triggering, the trigger level is the **bottom** of the trigger icon (.
28. Set the 5500A to source +3V DC and to OPR.
29. Verify that no trace is shown on the test tool display, and that the status line at the display bottom shows **Wait:B** . If the display shows the traces and status **Hold:B** , then press  to re-arm the test tool for a trigger.
30. Decrease the 5500A voltage in 0.1V steps, using the 5500A EDIT FIELD function, until the test tool is triggered, and the traces are shown.
31. Verify that the 5500A voltage is between **+1.5V and +2.5V** when the test tool is triggered. To repeat the test, start at step 28.
32. When you are finished, set the 5500A to Standby.

3.5.9 Input A and B DC Voltage Accuracy Test

WARNING

Dangerous voltages will be present on the calibration source and connecting cables during the following steps. Ensure that the calibrator is in standby mode before making any connection between the calibrator and the test tool.

Proceed as follows:

1. Connect the test tool to the 5500A as for the previous test (see Figure 3-5).
2. Select the following test tool setup:
 - Press  select auto ranging (**AUTO** in top of display).
 - Press  to open the INPUT A MEASUREMENTS menu, and choose:
MEASURE on A: ● Vdc
 - Press  to open the INPUT B MEASUREMENTS menu, and choose:
INPUT B: ● ON | MEASURE on B: ● Vdc
 - Using  change the time base to select manual time base ranging, and lock the time base on 10 ms/div.
 - Fluke 123/124: press  /  to open the SCOPE INPUTS menu.
 - Fluke 123/124: press  to open the SCOPE OPTIONS menu, and choose :
SCOPE MODE: ● NORMAL | WAVEFORM MODE: ● SMOOTH
 - Fluke 125: press  to open MENU.
 - Fluke 125: press  to open the TRIGGER menu, and choose :
UPDATE: ● FREE RUN
 - Fluke 125: press  to open the SMOOTH menu, and choose :
WAVEFORM: ● SMOOTH
 - Move the Input A and Input B ground level (indicated by zero icon ) to the center grid line. Proceed as follows:
 - ⇒ Press  to enable the arrow keys for moving the Input A ground level.
 - ⇒ Press  to enable the arrow keys for moving the Input B ground level.
 - ⇒ Using the   keys move the ground level.
3. Using   set the Input A and B sensitivity to the first test point in Table 3-2. The corresponding range is shown in the second column of the table.
4. Set the 5500A to source the appropriate DC voltage. Set the 5500A to Operate (OPR).
5. Observe the main reading and check to see if it is within the range shown under the appropriate column.

6. Continue through the test points.
7. When you are finished, set the 5500A to 0 (zero) Volt, and to Standby.

Table 3-2. Volts DC Measurement Verification Points

Sensitivity (Oscilloscope)	Range ¹⁾ (Meter)	5500A output, V DC	Input A-B DC Reading
5 mV/div	500 mV	15 mV	014.4 to 015.6 ²⁾
10 mV/div	500 mV	30 mV	029.3 to 030.7 ²⁾
20 mV/div	500 mV	60 mV	059.2 to 060.8
50 mV/div	500 mV	150 mV	148.7 to 151.3
100 mV/div	500 mV	300 mV	298.0 to 302.0
200 mV/div	500 mV	500 mV	497.0 to 503.0
		-500 mV	-497.0 to -503.0
		0 mV	-000.5 to + 000.5
500 mV/div	5V	1.5V	1.487 to 1.513
1 V/div	5V	3V	2.980 to 3.020
2 V/div	5V	5V	4.970 to 5.030
		-5V	-4.970 to -5.030
		0V	-0.005 to +0.005
5 V/div	50V	15V	14.87 to 15.13
10 V/div	50V	30V	29.80 to 30.20
20 V/div	50V	50V	49.70 to 50.30
		-50V	-49.70 to -50.30
		0V	-00.05 to +00.05
50 V/div	500V	150V	148.7 to 151.3
100 V/div	500V	300V	298.0 to 302.0

¹⁾ The 500V and 1250V range will be tested in Section 3.5.14

²⁾ Due to calibrator noise, occasionally OL (overload) can be shown.

3.5.10 Input A and B AC Voltage Accuracy Test

Warning

Dangerous voltages will be present on the calibration source and connecting cables during the following steps. Ensure that the calibrator is in standby mode before making any connection between the calibrator and the test tool.

Proceed as follows to test the Input A and B AC Voltage accuracy:











1. Connect the test tool to the 5500A as for the previous test (see Figure 3-5).
2. Select the following test tool setup:
 - Press  to select auto ranging (**AUTO** in top of display).
Do not press  anymore!
 - Press  to open the INPUT A MEASUREMENTS menu, and choose:
MEASURE on A: ● Vac
 - Press  to open the INPUT B MEASUREMENTS menu, and choose:
INPUT B: ● ON | MEASURE on B: ● Vac
 - Move the Input A and Input B ground level (indicated by zero icon ) to the center grid line. Proceed as follows:
 - ⇒ Press  to enable the arrow keys for moving the Input A ground level.
 - ⇒ Press  to enable the arrow keys for moving the Input B ground level.
 - ⇒ Using the   keys move the ground level.
3. Using   set the Input A and B sensitivity to the first test point in Table 3-3. The corresponding range is shown in the second column of the table.
4. Set the 5500A to source the required AC voltage (NORMAL output, WAVE sine). Set the 5500A to Operate (OPR).
5. Observe the Input A and Input B main reading and check to see if it is within the range shown under the appropriate column.
6. Continue through the test points.
7. When you are finished, set the 5500A to Standby.

Table 3-3. Volts AC Measurement Verification Points

Sensitivity (Oscilloscope)	Range ¹⁾ (Meter)	5500A output Volts rms	5500A Frequency	Reading A-B
200 mV/div	500 mV	500 mV	60 Hz	494.0 to 506.0
		500 mV	20 kHz	486.0 to 514.0
2V/div	5V	5V	20 kHz	4.860 to 5.140
		5V	60 Hz	4.940 to 5.060
20V/div	50V	50V	60 Hz	49.40 to 50.60
		50V	20 kHz	48.60 to 51.40

¹⁾ The 500V and 1250V range will be tested in Section 3.5.14

3.5.11 Input A and B AC Input Coupling Test

Proceed as follows to test the Input A and B AC coupled input lower transition point:

1. Connect the test tool to the 5500A as for the previous test (see Figure 3-5).
2. Select the following test tool setup:
 - Use the setup of the previous step (AUTO time base, traces at vertical center).
 - Using mV V select 200 mV/div for Input A and B (500 mV range).
 - Fluke 123/124: press MENU / SCOPE MENU to open the SCOPE INPUTS menu, and choose:
INPUT A: ● AC | ● NORMAL | INPUT B: ● AC | NORMAL ●
 - Fluke 123/124: press MENU / SCOPE MENU to open the SCOPE INPUTS menu.
 - Fluke 123/124: press F3 to open the TRIGGER menu, and choose:
INPUT: A | SCREEN UPDATE: ● FREE RUN | AUTO RANGE: ● > 1Hz
 - Fluke 125: press VHzA
Ω + to open the A MEASUREMENTS menu, and choose:
 - Fluke 125: press F1 to open the A INPUT menu, and choose:
INPUT A: ● AC | ● NORMAL
 - Fluke 125: press VHzA to open the B MEASUREMENTS menu, and choose:
 - Fluke 125: press F1 to open the B INPUT menu, and choose:
INPUT B: ● AC | NORMAL ●
 - Fluke 125: press MENU to open MENU.
 - Fluke 125: press F1 to open the TRIGGER menu, and choose:
UPDATE: ● FREE RUN | AUTO RANGE: ● > 1Hz
3. Set the 5500A to source an AC voltage, to the first test point in Table 3-4 (NORMAL output, WAVE sine). Set the 5500A to Operate (OPR).

4. Observe the Input A and Input B main reading and check to see if it is within the range shown under the appropriate column.
5. Continue through the test points.
6. When you are finished, set the 5500A to Standby.

Table 3-4. Input A and B AC Input Coupling Verification Points









5500A output, V rms	5500A Frequency	Reading A-B
500.0 mV	10 Hz	> 344.0
500.0 mV	33 Hz	> 469.0
500.0 mV	60 Hz	> 486.5

3.5.12 Input A and B Volts Peak Measurements Test

WARNING

Dangerous voltages will be present on the calibration source and connecting cables during the following steps. Ensure that the calibrator is in standby mode before making any connection between the calibrator and the test tool.

Proceed as follows to test the Volts Peak measurement function:

1. Connect the test tool to the 5500A as for the previous test (see Figure 3-5).
2. Select the following test tool setup:
 - Fluke 123/124: press  /  to open the SCOPE INPUTS menu.
 - Fluke 123/124: press  to open the TRIGGER menu, and choose:
INPUT: A | SCREEN UPDATE: ● FREE RUN | AUTO RANGE: ● > 15Hz
 - Fluke 125: press  to open MENU.
 - Fluke 125: press  to open the TRIGGER menu, and choose :
INPUT: A | UPDATE: ● FREE RUN | AUTO RANGE: ● > 15Hz
 - Press  to select auto ranging (**AUTO** in top of display).
 - Press  to open the INPUT A MEASUREMENTS menu, and choose:
MEASURE on A: ● PEAK
From the INPUT A PEAK sub-menu choose:
PEAK TYPE : ● PEAK-PEAK
 - Press  to open the INPUT B MEASUREMENTS menu, and choose:
INPUT B: ● ON | MEASURE on B: ● PEAK
From the INPUT B PEAK sub-menu choose:

PEAK TYPE : ● PEAK-PEAK



- Using   select 1V/div for input A and B.
3. Set the 5500A to source a sine wave, to the first test point in Table 4-5 (NORMAL output, WAVE sine). Set the 5500A to Operate (OPR).
 4. Observe the Input A and Input B main reading and check to see if it is within the range shown under the appropriate column.
 5. Continue through the test points.
 6. When you are finished, set the 5500A to Standby.

Table 3-5. Volts Peak Measurement Verification Points

5500A output, Vrms (sine)	5500A Frequency	Reading A-B
1.768 (5V peak)	1 kHz	4.50 to 5.50

3.5.13 Input A and B Phase Measurements Test

Proceed as follows:





1. Connect the test tool to the 5500A as for the previous test (see Figure 3-5).
2. Select the following test tool setup:
 - Press  to select auto ranging (**AUTO** in top of display).
 - Press  to open the INPUT A MEASUREMENTS menu, and choose:
MEASURE on A: ● PHASE
 - Press  to open the INPUT B MEASUREMENTS menu, and choose:
INPUT B: ● ON | MEASURE on B: ● PHASE
 - Using   select 1V/div for input A and B.
3. Set the 5500A to source a sine wave, to the first test point in Table 3-6 (NORMAL output, WAVE sine). Set the 5500A to Operate (OPR).
4. Observe the Input A and Input B main reading and check to see if it is within the range shown under the appropriate column.
5. Continue through the test points.
6. When you are finished, set the 5500A to Standby.

Table 3-6. Phase Measurement Verification Points

5500A output, Vrms (sine)	5500A Frequency	Reading A-B
1.5V	1 kHz	-2 to +2 Deg

3.5.14 Harmonics (Fluke 125)

Proceed as follows:

1. Connect the test tool to the 5500A as for the previous test (see Figure 3-5).
2. Press **MENU** to open MENU.
3. Operate the **▲ ▼** keys to highlight HARMONICS.
4. Press **F4** to open the B AMPERE PROBE menu, and choose:
SENSITIVITY: ● 10 mV/A
5. Press **F4** to open the HARMONICS AMP menu.
6. Set the 5500A to source a square wave 2.5 Vpp, 60 Hz (NORMAL output, WAVE square). Set the 5500A to Operate (OPR).
7. Check if the bargraphs of AMP HARMONICS look like the the ones in Figure 3-6.
8. Press **F1** to two times to activate HARMONICS VOLT menu.
9. Check if the bargraphs of VOLT HARMONICS look like the the ones in Figure 3-7.
10. When you are finished, set the 5500A to Standby.

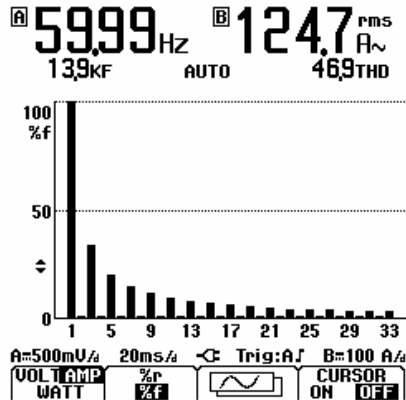

Figure 3-6. Bargraph Harmonics Ampere

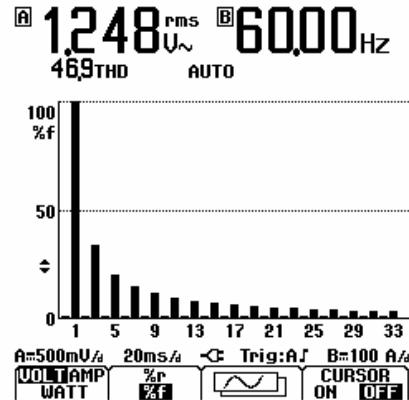

Figure 3-7. Bargraph Harmonics Volt

3.5.15 Input A and B High Voltage AC/DC Accuracy Test

Warning

Dangerous voltages will be present on the calibration source and connecting cables during the following steps. Ensure that the calibrator is in standby mode before making any connection between the calibrator and the test tool.

Proceed as follows to test the Input A&B High Voltage AC and DC Accuracy:

1. Connect the test tool to the 5500A as shown in Figure 3-8.

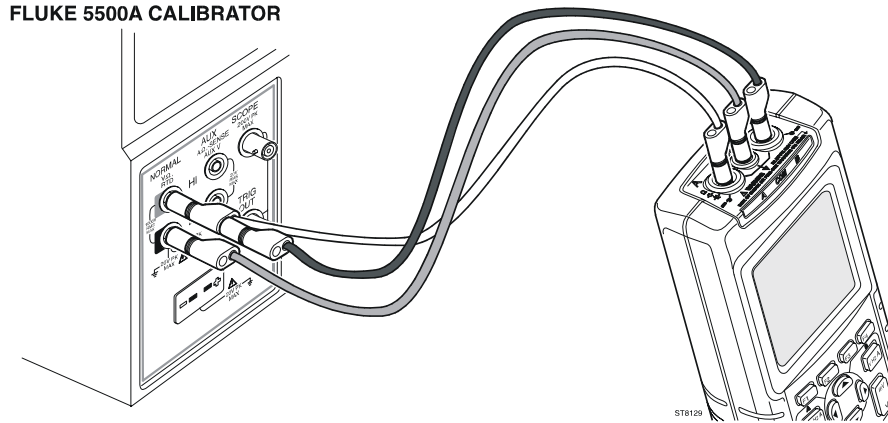

Figure 3-8. Test Tool Input A-B to 5500A Normal Output for >300V

ST8129.WMF

2. Select the following test tool setup:
 - Press **AUTO** to select auto ranging (**AUTO** in top of display).
Do not press **TIME ns** anymore!
 - Press **VHzA** to open the INPUT A MEASUREMENTS menu, and choose:
MEASURE on A: • Vac
 - Press **VHzA** to open the INPUT A MEASUREMENTS menu, and choose:
MEASURE on A: • Vdc (Vdc becomes main reading, Vac secondary reading)
 - Press **VHzA** to open the INPUT B MEASUREMENTS menu, and choose:
INPUT B: • ON | MEASURE on B: • Vac
 - Press **VHzA** to open the INPUT B MEASUREMENTS menu, and choose:
INPUT B: • ON | MEASURE on B: • Vdc
 - Move the Input A and Input B ground level (indicated by zero icon **■**) to the center grid line. Proceed as follows:
 - ⇒ Press **F1** to enable the arrow keys for moving the Input A ground level.
 - ⇒ Press **F2** to enable the arrow keys for moving the Input B ground level.
 - ⇒ Using the **▲ ▼** keys move the ground level.
3. Using **mV** **v** set the Input A and B sensitivity to the first test point in Table 3-7. The corresponding range is shown in the second column of the table.
4. Set the 5500A to source the required AC voltage (NORMAL output, WAVE sine). Set the 5500A to Operate (OPR).
5. Observe the Input A and B main reading (V-dc) and secondary reading (V-ac) and check to see if it is within the range shown under the appropriate column.
6. Continue through the test points.

- When you are finished, set the 5500A to Standby

Table 3-7. V DC and V AC High Voltage Verification Tests

Sensitivity (Scope)	Range (Meter)	5500A output Vrms	5500A Frequency	Main (DC) Reading A-B	Secondary (AC) Reading A-B
200V/div	500V	0V	DC	-000.5 to +000.5	
		+500V	DC	+497.0 to +503.0	
		-500V	DC	-497.0 to -503.0	
		500V	60Hz		494.0 to 506.0
		500V	10 kHz		486.0 to 514.0
500V/div	1250V	600V	10 kHz		0.570 to 0.630
		600V	60Hz		0.584 to 0.616
		+600V	DC	+0.592 to +0.608	
		-600V	DC	-0.592 to -0.608	
		0V	DC	-0.005 to +0.005	

3.5.16 Resistance Measurements Test

Proceed as follows:

- Connect the test tool to the 5500A as shown in Figure 3-9.

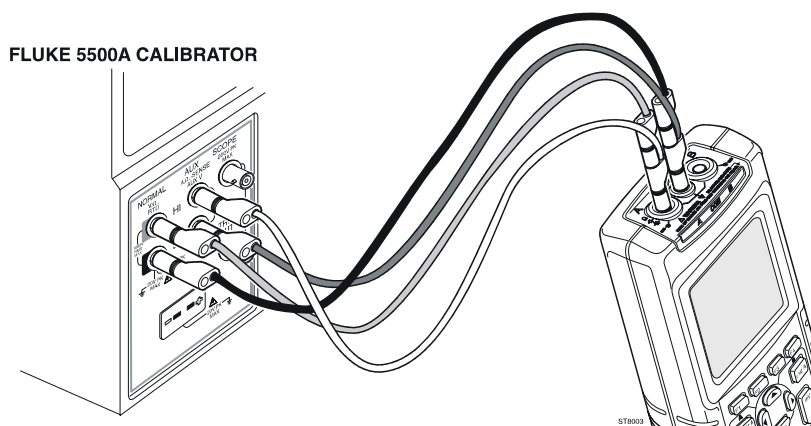

Figure 3-9. Test Tool Input A to 5500A Normal Output 4-Wire

ST8003.WMF

- Select the following test tool setup:
 - Press **AUTO** to select auto ranging (**AUTO** in top of display).

- Press  to open the INPUT A MEASUREMENTS menu, and choose:

MEASURE on A: • OHM Ω



3. Set the 5500A to the first test point in Table 4-8. Set the 5500A to Operate (OPR). Use the 5500A “COMP 2 wire” mode for the verifications up to and including 50 kΩ. For the higher values, the 5500A will turn off the “COMP 2 wire” mode.
4. Observe the Input A main reading and check to see if it is within the range shown under the appropriate column.
5. Continue through the test points.
6. When you are finished, set the 5500A to Standby.

Table 3-8. Resistance Measurement Verification Points

5500A output	Reading
0Ω	000.0 to 000.5
400Ω	397.1 to 402.9
4 kΩ	3.971 to 4.029
40 kΩ	39.71 to 40.29
400 kΩ	397.1 to 402.9
4 MΩ	3.971 to 4.029
30 MΩ	29.77 to 30.23

3.5.17 Continuity Function Test

Proceed as follows:

1. Connect the test tool to the 5500A as for the previous test (see Figure 3-9).
2. Select the following test tool setup:
 - Press  to select auto ranging (**AUTO** in top of display).
 - Press  to open the INPUT A MEASUREMENTS menu, and choose:

MEASURE on A: • CONT)))
3. Set the 5500A to 25Ω. Use the 5500A “COMP 2 wire” mode. Set the 5500A to Operate (OPR).
4. Listen to hear that the beeper sounds continuously.
5. Set the 5500A to 35Ω.
6. Listen to hear that the beeper does not sound.
7. When you are finished, set the 5500A to Standby.







3.5.18 Diode Test Function Test

Proceed as follows to test the Diode Test function :

1. Connect the test tool to the 5500A as for the previous test (see Figure 3-9).
2. Press  to open the INPUT A MEASUREMENTS menu, and choose:
MEASURE on A: ● DIODE
3. Set the 5500A to **1 kΩ**. Use the 5500A “COMP 2 wire” mode. Set the 5500A to Operate (OPR).
4. Observe the main reading and check to see if it is within 0.425 and 0.575V.
5. Set the 5500A to **1V DC**.
6. Observe the main reading and check to see if it is within 0.975 and 1.025V.
7. When you are finished, set the 5500A to Standby.

3.5.19 Capacitance Measurements Test

Proceed as follows:

1. Connect the test tool to the 5500A as for the previous test (see Figure 3-9). Ensure that the 5500A is in Standby.
2. Select the following test tool setup:
 - Press  to open the INPUT A MEASUREMENTS menu, and choose:
MEASURE on A: ● CAP
 - Press  to select auto ranging (**AUTO** in top of display).
 - Press  to open the INPUT A MEASUREMENTS menu.
 - Fluke 123/124: press  to select the METER A OPTIONS MENU, and choose:
SMOOTHING: ● NORMAL | ZERO REF: ● ON
The ZERO REF function is used to eliminate the capacitance of the test leads.
 - Fluke 125: press  to select ZERO reference. This function is used to eliminate the capacitance of the test leads.
 - Fluke 125: press  to select MENU
 - Fluke 125: press  to select:
SMOOTHING READING A: ● NORMAL
3. Set the 5500A to the first test point in Table 3-9. Use the 5500A “COMP OFF” mode. Set the 5500A to Operate (OPR).
4. Observe the Input A main reading and check to see if it is within the range shown under the appropriate column.
5. Continue through the test points.
6. When you are finished, set the 5500A to Standby.



7. Remove all test leads from the test tool to check the zero point.
8. Press  to open the INPUT A MEASUREMENTS menu.
9. Fluke 123/124: press  to select the METER A OPTIONS MENU, and choose:
SMOOTHING: ● NORMAL | ZERO REF: ● OFF
10. Fluke 125: press  to switch off ZERO reference.
11. Observe the Input A reading and check to see if it is between 00.00 and 00.10 nF.

Table 3-9. Capacitance Measurement Verification Points

5500A output	Reading
40 nF	39.10 to 40.90
300 nF	293.0 to 307.0
3 μF	2.930 to 3.070
30 μF	29.30 to 30.70
300 μF	293.0 to 307.0
0 (remove test tool input connections)	00.00 to 00.10 (see steps 7...10)

3.5.20 Video Trigger Test

This test is based upon use of a TV signal generator. If you have a Fluke 5500A Calibrator with 600 MHz Oscilloscope Option, there is no need to use a separate TV signal generator. Fluke 5500A with 600 MHz option can generate video signals. These video signals must be applied to the test tool via a 50Ω Coax Cable and terminated with a 50Ω feed through termination. The video signal is simpler than that from a TV signal generator. It consists of sync pulses and one marker that can be adjusted to appear in the video line the test tool triggers on.

Only one of the systems NTSC, PAL, or SECAM has to be verified.

Proceed as follows:

1. Connect the test tool to the VIDEO output of the TV Signal Generator as shown in Figure 3-9.

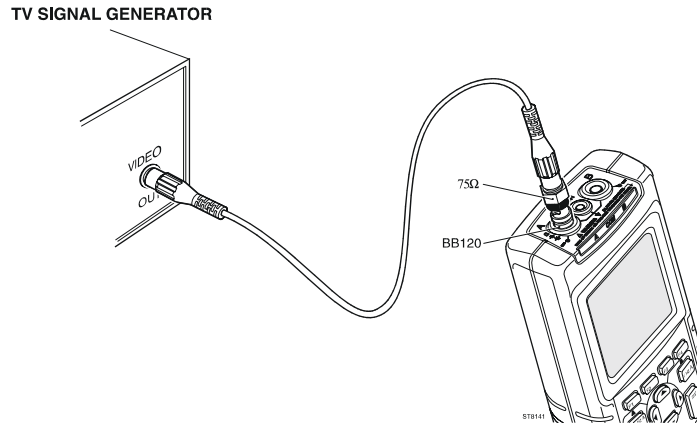

Figure 3-10. Test Tool Input A to TV Signal Generator

ST8141.WMF

2. Select the following test tool setup:

- Reset the test tool (power off and then on with).
- Fluke 123/124: press / to open the SCOPE INPUTS menu.
- Fluke 123/124: Press to open the TRIGGER menu and choose:
 - **VIDEO on A...**From the shown VIDEO TRIGGER menu choose:
SYSTEM: • NTSC or • PAL or • SECAM
LINE: • SELECT
POLARITY: • POSITIVE
- Fluke 125: press to open MENU.
- Fluke 125: Press to open the TRIGGER menu and choose:
 - **VIDEO on A...**From the shown VIDEO TRIGGER menu choose:
SYSTEM: • NTSC or • PAL or • SECAM
LINE: • SELECT
POLARITY: • POSITIVE
- Using set the Input A sensitivity to 200 mV/div.
- Using select 20 μ s/div.
- Press to enable the arrow keys for selecting the video line number.
- Using select the line number:
 - \Rightarrow 622 for PAL or SECAM
 - \Rightarrow 525 for NTSC.

3. Set the TV Signal Generator to source a signal with the following properties:
 - the system selected in step 2
 - gray scale
 - video amplitude 1V (5 divisions on the test tool)
 - chroma amplitude zero.
4. Observe the trace, and check to see if the test tool triggers on line number:
 - ⇒ 622 for PAL or SECAM, see Figure 3-11
 - ⇒ 525 for NTSC, see Figure 3-12.

Note

Numerical readings in the pictures shown below may deviate from those shown in the test tool display during verification.

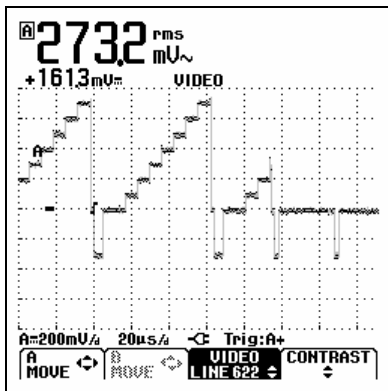

PAL622.BMP

Figure 3-11. Test Tool Screen for PAL/SECAM line 622

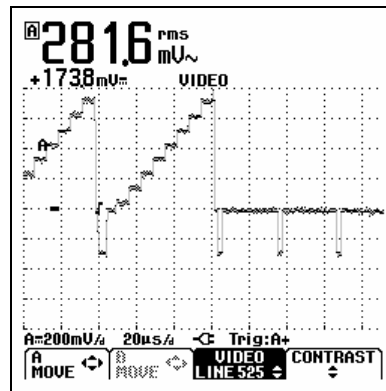

NTSC525.BMP

Figure 3-12. Test Tool Screen for NTSC line 525

5. Using select the line number:
 - ⇒ 310 for PAL or SECAM
 - ⇒ 262 for NTSC
6. Observe the trace, and check to see if the test tool triggers on:
 - ⇒ line number 310 for PAL or SECAM, see Figure 3-13.
 - ⇒ line number 262 for NTSC, see Figure 3-14.

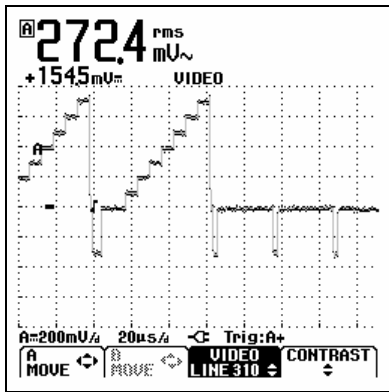

PAL310.BMP

Figure 3-13. Test Tool Screen for PAL/SECAM line 310

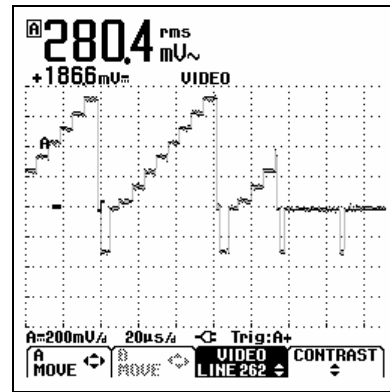

NTSC262.BMP

Figure 3-14. Test Tool Screen for NTSC line 262

7. Apply the inverted TV Signal Generator signal to the test tool.
You can invert the signal by using a Banana Plug to BNC adapter (Fluke PM9081/001) and a Banana Jack to BNC adapters (Fluke PM9082/001), as shown in Figure 3-15.

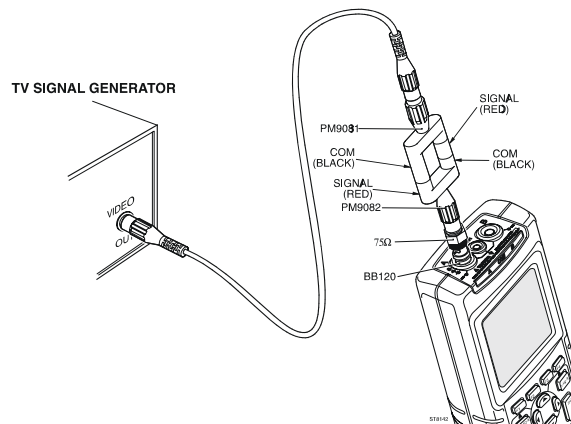

ST8142.WMF

Figure 3-15. Test Tool Input A to TV Signal Generator Inverted

8. Select the following test tool setup:
 - Fluke 123/124: press **MENU** / **SCOPE MENU** to open the SCOPE INPUTS menu.
 - Fluke 123/124: press **F3** to open the TRIGGER menu and choose:
 - **VIDEO on A**

The VIDEO TRIGGER sub-menu is shown now. From the VIDEO TRIGGER menu choose:

SYSTEM: • NTSC or • PAL or • SECAM or • PALplus |

LINE: • SELECT | **POLARITY:** • NEGATIVE

- Fluke 125: press **MENU** to open MENU.

- Fluke 125: press **F1** to open the TRIGGER menu and choose:
 - **VIDEO on A**

The VIDEO TRIGGER sub-menu is shown now. From the VIDEO TRIGGER menu choose:

SYSTEM: • NTSC or • PAL or • SECAM or • PALplus |

 - **LINE: • SELECT | POLARITY: • NEGATIVE**
 - Using **mV** **V** set the Input A sensitivity to 200 mV/div.
 - Using **s TIME ns** select 20 μ s/div.
- 9. Using **▲ ▼** select the line number:
 - ⇒ 310 for PAL or SECAM
 - ⇒ 262 for NTSC
- 10. Observe the trace, and check to see if the test tool triggers on:
 - ⇒ line number 311 for PAL or SECAM, see Figure 3-16
 - ⇒ line number 262 for NTSC, see Figure 3-17.

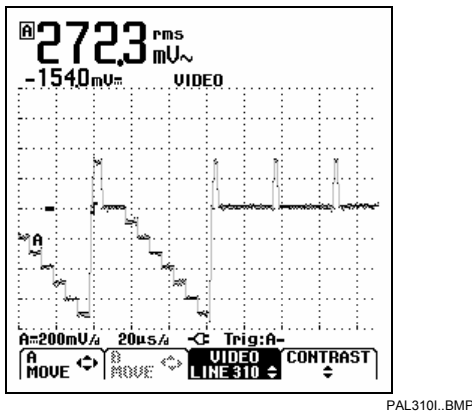

Figure 3-16. Test Tool Screen for PAL/SECAM line 310 Negative Video

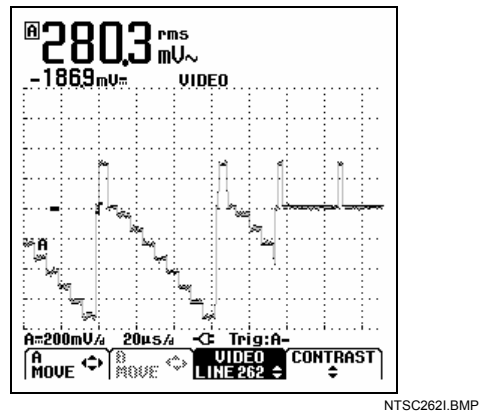

Figure 3-17. Test Tool Screen for NTSC line 262 Negative Video

This is the end of the Performance Verification Procedure.

Chapter 4

Calibration Adjustment

Title	Page
4.1 General.....	4-3
4.1.1 Introduction.....	4-3
4.1.2 Calibration number and date.....	4-3
4.1.3 General Instructions.....	4-3
4.2 Equipment Required For Calibration.....	4-4
4.3 Starting Calibration Adjustment.....	4-4
4.4 Contrast Calibration Adjustment.....	4-6
4.5 Warming Up & Pre-Calibration.....	4-7
4.6 Final Calibration.....	4-7
4.6.1 HF Gain Input A&B.....	4-7
4.6.2 Delta T Gain, Trigger Delay Time & Pulse Adjust Input A.....	4-9
4.6.3 Pulse Adjust Input B.....	4-10
4.6.4 Gain DMM (Gain Volt).....	4-10
4.6.5 Volt Zero.....	4-12
4.6.6 Zero Ohm.....	4-12
4.6.7 Gain Ohm.....	4-13
4.6.8 Capacitance Gain Low and High.....	4-14
4.6.9 Capacitance Clamp & Zero.....	4-14
4.6.10 Capacitance Gain.....	4-15
4.7 Save Calibration Data and Exit.....	4-15

4.1 General



4.1.1 Introduction

The following information, provides the complete Calibration Adjustment procedure for the test tools Fluke 123 and 124 with **firmware V02.00** and onwards and for Fluke 125. The test tool allows closed-case calibration using known reference sources. It measures the reference signals, calculates the correction factors, and stores the correction factors in RAM. After completing the calibration, the correction factors can be stored in FlashROM.

The test tool should be calibrated after repair, or if it fails the performance test. The test tool has a normal calibration cycle of one year. The Calibration Adjustment procedure is identical for Fluke 123, 124 and 125.

4.1.2 Calibration number and date

When storing valid calibration data in FlashROM after performing the calibration adjustment procedure, the calibration date is set to the actual test tool date, and calibration number is raised by one. To display the calibration date and - number:

1. Press  to open the USER OPTIONS menu.
2. Press  to show the VERSION&CALIBRATION screen (see Figure 4.1).
3. Press  to return to normal mode.

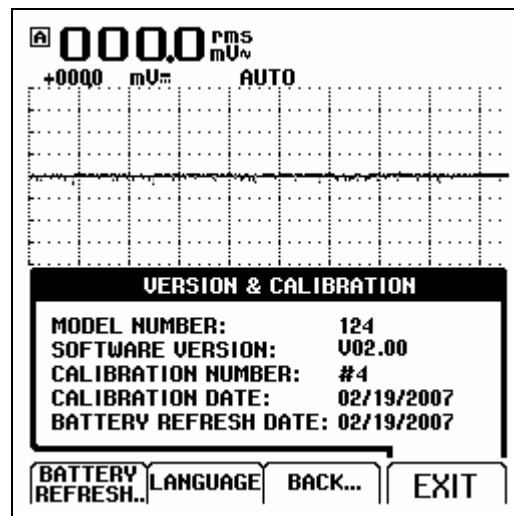

Figure 4-1. Version & Calibration Screen

VERSION.BMP

4.1.3 General Instructions

Follow these general instructions for all-calibration steps:

- Allow the 5500A to satisfy its specified warm-up period. For each calibration point , wait for the 5500A to settle.
- The required warm up period for the test tool is included in the WarmingUp & PreCal calibration step.
- Ensure that the test tool battery is charged sufficiently.





4.2 Equipment Required For Calibration

The primary source instrument used in the calibration procedures is the Fluke 5500A. If a 5500A is not available, you can substitute another calibrator as long as it meets the minimum test requirements.

- Fluke 5500A Multi Product Calibrator, including 5500A-SC Oscilloscope Calibration Option.
- Stackable Test Leads (4x), supplied with the 5500A.
- 50Ω Coax Cables (2x), Fluke PM9091 or PM9092.
- 50Ω feed through terminations (2x), Fluke PM9585.
- Fluke BB120 Shielded Banana to Female BNC adapters (2x), supplied with the Fluke 123/124/125.
- Dual Banana Plug to Female BNC Adapter (1x), Fluke PM9081/001.
- Male BNC to Dual Female BNC Adapter (1x), Fluke PM9093/001.



4.3 Starting Calibration Adjustment

Follow the steps below to start calibration adjustments.

1. Power the test tool via the power adapter input, using the PM8907 power adapter.
2. Check the actual test tool date, and adjust the date if necessary:
 - Press  to open the USER OPTIONS menu
 - Using   select DATE ADJUST
 - press  to open the DATE ADJUST menu
 - adjust the date if necessary.
3. Select the Maintenance mode.

The Calibration Adjustment Procedure uses built-in calibration setups, that can be accessed in the Maintenance mode.

To enter the Maintenance mode proceed as follows:

- Press and hold 
- Press and release 
- Release 
- The display shows the Calibration Adjustment Screen.

The display shows the first calibration step **Warming Up (CL 0200)** , and the calibration status **:IDLE (valid)** or **:IDLE (invalid)**.

4. Continue with either a. or b. below:
 - a. To calibrate the display contrast adjustment range and the default contrast, go to Section 4.4 Contrast Calibration Adjustment.
This calibration step is only required if the display cannot be made dark or light enough, or if the display after a test tool reset is too light or too dark.
 - b. To calibrate the test tool without calibrating the contrast, go to Section 4.5 Warming Up & Pre-calibration.

Explanation of screen messages and key functions.

When the test tool is in the Maintenance Mode, only the F1 to F4 soft keys, the ON/OFF key, and the backlight key can be operated, unless otherwise stated.





The calibration adjustment screen shows the actual calibration step (name and number) and its status :

Cal Name (CL nnnn) :Status Calibration step nnnn

Status can be:

- | | |
|-----------------------|--|
| IDLE (valid) | After (re)entering this step, the calibration process is not started. The calibration data of this step are valid. This means that the last time this step was done, the calibration process was successful. It does not necessarily mean that the unit meets the specifications related to this step! |
| IDLE (invalid) | After (re)entering this step, the calibration process is not started. The calibration data are invalid. This means that the unit will not meet the specifications if the calibration data are saved. |
| BUSY aaa% bbb% | Calibration adjustment step in progress; progress % for Input A and Input B. |
| READY | Calibration adjustment step finished. |
| Error :xxxx | Calibration adjustment failed, due to wrong input signal(s) or because the test tool is defective. The error codes xxxx are shown for production purposes only. |

Functions of the keys F1-F4 are:

- | | |
|---|--|
|  | PREV select the previous step |
|  | NEXT select the next step |
|  | CAL start the calibration adjustment of the actual step |
|  | EXIT leave the Maintenance mode |

Readings and traces

After completing a calibration step, readings and traces are shown using the new calibration data.

4.4 Contrast Calibration Adjustment

After entering the Maintenance mode, the test tool display shows **Warming Up (CL 0200):IDLE (valid)**.

Do not press **F3** now! If you did, turn the test tool off and on, and enter the Maintenance mode again.

Proceed as follows to adjust the maximum display darkness (CL0100), the default contrast (CL0110), and the maximum display brightness (CL0120).

1. Press **F1** a three times to select the first calibration step. The display shows:
Contrast (CL 0100) :MANUAL
 2. Press **F3** CAL. The display will show a dark test pattern, see Figure 4-2
 3. Using **▲▼** adjust the display to the maximum darkness, at which the test pattern is only just visible.
 4. Press **F2** to select the default contrast calibration. The display shows:
Contrast (CL 0110) :MANUAL
 5. Press **F3** CAL. The display shows the test pattern at default contrast.
 6. Using **▲▼** set the display to optimal (becomes default) contrast.
 7. Press **F2** to select maximum brightness calibration. The display shows:
Contrast (CL 0120) :MANUAL
 8. Press **F3** CAL. The display shows a bright test pattern.
 9. Using **▲▼** adjust the display to the maximum brightness, at which the test pattern is only just visible.
 10. You can now :
 - Exit, if only the Contrast had to be adjusted. Continue at Section 4.7.
- OR
- Do the complete calibration. Press **F2** to select the next step (Warming Up), and continue at Section 4.5.

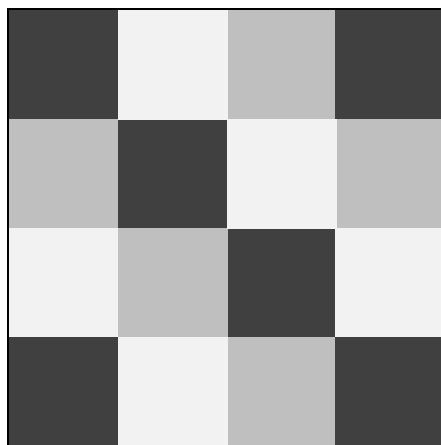

Figure 4-2. Display Test Pattern

4.5 Warming Up & Pre-Calibration

After entering the Warming-Up & Pre-Calibration state, the display shows:
WarmingUp (CL 0200):IDLE (valid) or (invalid).

You must always start the Warming Up & Pre Calibration at **Warming Up (CL0200)** .
Starting at another step will make the calibration invalid!

Proceed as follows:

1. Remove all input connections from the test tool.
2. Press **F3** to start the Warming-Up & Pre-Calibration.
The display shows the calibration step in progress, and its status.
The first step is **WarmingUp (CL0200) :BUSY 00:29:59** . The warming-up period is counted down from 00:29:59 to 00:00:00. Then the other pre-calibration steps are performed automatically. The procedure takes about 60 minutes.
3. Wait until the display shows **End Precal :READY**
4. Continue at Section 4.6.

4.6 Final Calibration

You must always start the Final Calibration at the first step of Section 4.6.1. Starting at another step will make the calibration invalid!

If you proceeded to step N (for example step CL 0615), then return to a previous step (for example step CL 0613) , and then calibrate this step, the complete final calibration becomes invalid. You must do the final calibration from the beginning (step CL 0600) again.

You can repeat a step that shows the status **:READY** by pressing **F3** again.

4.6.1 HF Gain Input A&B

Proceed as follows to do the HF Gain Input A&B calibration:

1. Press **F2** to select the first calibration step in Table 4-1 (**HFG & FI AB (CL 0600):**)
2. Connect the test tool to the 5500A as shown in Figure 4-3. Do NOT use 50Ω terminations!

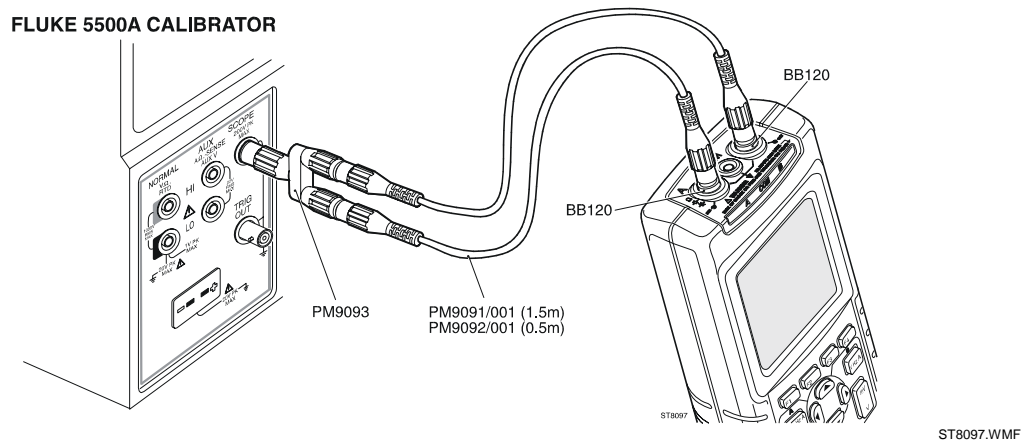

Figure 4-3. HF Gain Calibration Input Connections

3. Set the 5500A to source a 1 kHz fast rising edge square wave (Output SCOPE, MODE edge) to the first calibration point in Table 4-1.
4. Set the 5500A in operate (OPR).
5. Press **F3** to start the calibration.
6. Wait until the display shows calibration status **READY**.
7. Press **F2** to select the next calibration step, set the 5500A to the next calibration point, and start the calibration. Continue through all calibration points in Table 4-1.
8. Set the 5500A to source a 1 kHz square wave (Output SCOPE, MODE wavegen, WAVE square), to the first calibration point in Table 4-2.
9. Press **F2** to select the first step in Table 4-2.
10. Press **F3** to start the calibration.
11. Wait until the display shows calibration status **READY**.
12. Press **F2** to select the next calibration step, set the 5500A to the next calibration point, and start the calibration. Continue through all calibration points Table 4-2.
13. When you are finished, set the 5500A to Standby.
14. Continue at Section 4.6.2.

Table 4-1. HF Gain Calibration Points Fast

Cal step	5500A Setting ¹⁾ (1 kHz, no 50Ω!)	Test Tool Input Signal Requirements ¹⁾ (1 kHz, $t_{rise} < 100$ ns, flatness after rising edge: <0.5% after 200 ns)
HFG & FI AB (CL 0600)	10 mV	20 mV
HFG & FI AB (CL 0601)	25 mV	50 mV
HFG & FI AB (CL 0602)	50 mV	100 mV
HFG & FI AB (CL 0603)	100 mV	200 mV
HFG & FI AB (CL 0604)	250 mV	500 mV
HFG & FI AB (CL 0605)	500 mV	1V
HFG & FI AB (CL 0606)	1V	2V
HFG & FI AB (CL 0607) [HFG & FI A (CL 0608), HFG & FI B (CL 0628)] ²⁾	2.5V	5V

¹⁾ As the 5500A output is not terminated with 50Ω, its output voltage is two times its set voltage

²⁾ After starting the first step in this table cell, these steps are done automatically.

Table 4-2. HF Gain Calibration Points Slow

Cal step	5500A Setting (1 kHz, MODE wavegen, WAVE square)	Test Tool Input Signal Requirements (1 kHz square, $t_{rise} < 2 \mu s$, flatness after rising edge: <0.5% after 4 μs)
HF-Gain AB (CL 0609)	25V	25V
HF-Gain A (CL 0612), HF-Gain B (CL 0632) HF-Gain A (CL 0615), HF-Gain B (CL 0635)] ¹⁾	50V	50V

¹⁾ After starting the first step in this table cell, these steps are done automatically.

4.6.2 Delta T Gain, Trigger Delay Time & Pulse Adjust Input A

Proceed as follows to do the calibrations:

1. Press **F2** to select calibration step **Delta T (CL 0700):IDLE**
2. Connect the test tool to the 5500A as shown in Figure 4-4.

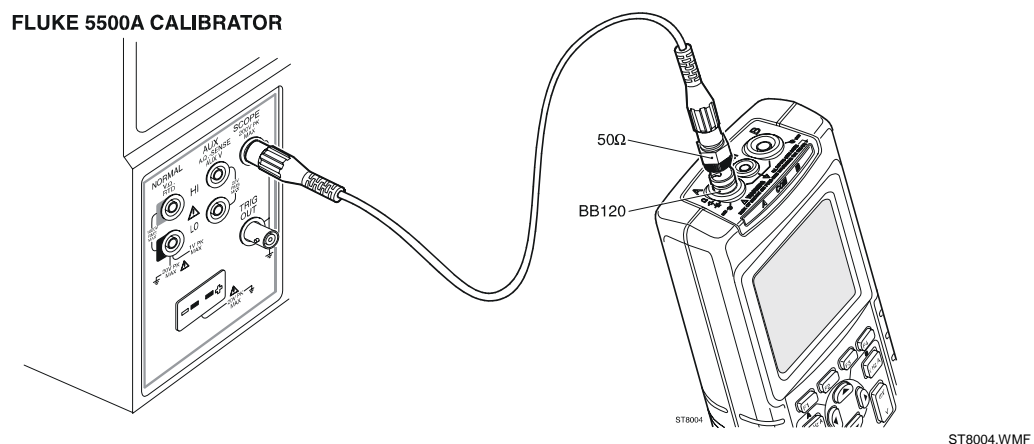

Figure 4-4. 5500A Scope Output to Input A

3. Set the 5500A to source a 1V, 1 MHz fast rising (rise time ≤ 1 ns) square wave (SCOPE output, MODE edge).
4. Set the 5500A to operate (OPR).
5. Press **F3** to start the calibration.
The Delta T gain, Trigger Delay (CL0720), and Pulse Adjust Input A (CL0640) will be calibrated.
6. Wait until the display shows **Pulse Adj A (CL 0640):READY**.
7. When you are finished, set the 5500A to Standby.
8. Continue at Section 4.6.3.

4.6.3 Pulse Adjust Input B

Proceed as follows to do the Pulse Adjust Input A calibration:

1. Press **F2** to select calibration step **Pulse Adj B (CL 0660):IDLE**
2. Connect the test tool to the 5500A as shown in Figure 4-5.

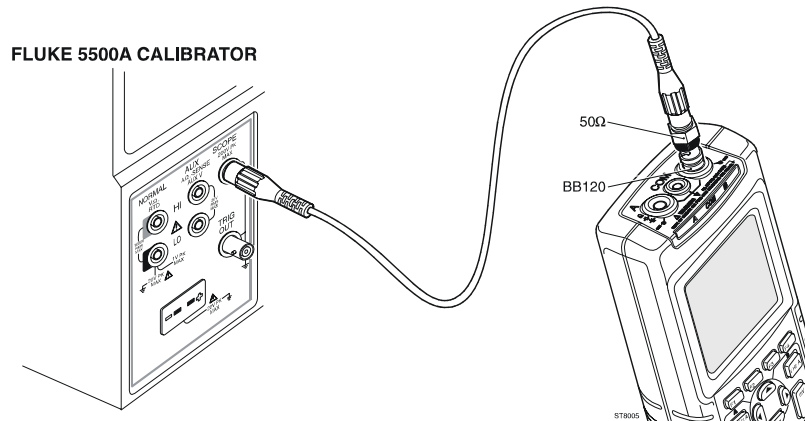

Figure 4-5. 5500A Scope Output to Input B

ST8005.WMF

3. Set the 5500A to source a 1V, 1 MHz fast rising square wave (SCOPE output, MODE edge) (rise time ≤ 1 ns, aberrations $<2\%$ pp).
4. Set the 5500A to operate (OPR).
5. Press **F3** to start the calibration.
6. Wait until the display shows **Pulse Adj B (CL 0660):READY**.
7. When you are finished, set the 5500A to Standby.
8. Continue at Section 4.6.4.

4.6.4 Gain DMM (Gain Volt)

Warning

Dangerous voltages will be present on the calibration source and connection cables during the following steps. Ensure that the calibrator is in standby mode before making any connection between the calibrator and the test tool.

Proceed as follows to do the Gain DMM calibration.

1. Press **F2** to select the first calibration step in Table 4-3.
2. Connect the test tool to the 5500A as shown in Figure 4-6.

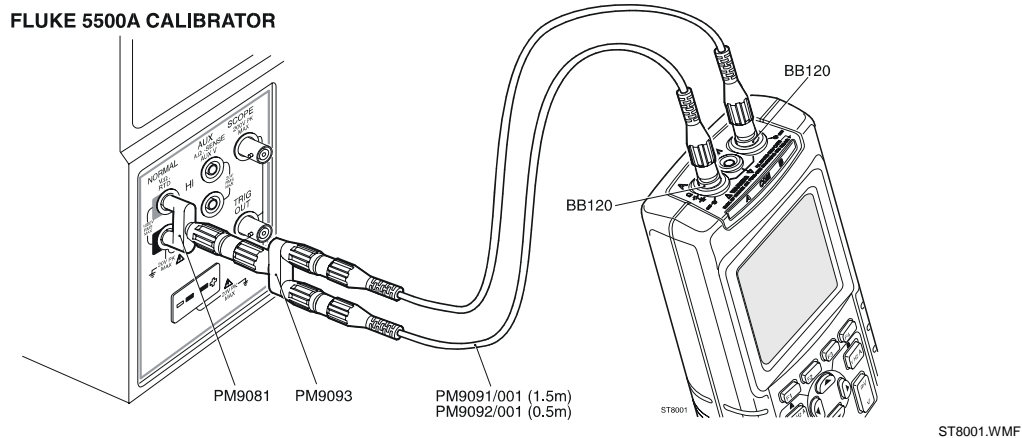

Figure 4-6. Volt Gain Calibration Input Connections <300V

3. Set the 5500A to supply a DC voltage, to the first calibration point in Table 4-3.
4. Set the 5500A to operate (OPR).
5. Press **F3** to start the calibration.
6. Wait until the display shows calibration status **:READY**.
7. Press **F2** to select the next calibration step, set the 5500A to the next calibration point, and start the calibration. Continue through all calibration points of Table 4-3
8. Set the 5500A to Standby, and continue with step 9.

Table 4-3. Volt Gain Calibration Points <300V

Cal step	Input value
Gain DMM (CL0800)	12.5 mV
Gain DMM (CL0801)	25 mV
Gain DMM (CL0802)	50 mV
Gain DMM (CL0803)	125 mV
Gain DMM (CL0804)	250 mV
Gain DMM (CL0805)	500 mV
Gain DMM (CL0806)	1.25V
Gain DMM (CL0807)	2.5V
Gain DMM (CL0808)	5V
Gain DMM (CL0809)	12.5V
Gain DMM (CL0810)	25V
Gain DMM (CL0811)	50V (set 5500A to OPR!)
Gain DMM (CL0812)	125V
Gain DMM (CL0813)	250V

9. Press **F2** to select calibration step **Gain DMM (CL0814) :IDLE**

10. Connect the test tool to the 5500A as shown in Figure 4-7.

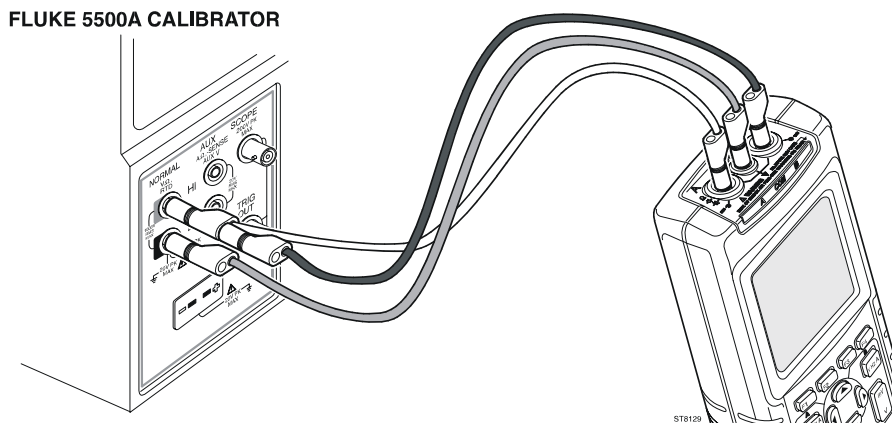

Figure 4-7. Volt Gain Calibration Input Connections 500V

ST8129.WMF

11. Set the 5500A to supply a DC voltage of 500V.
12. Set the 5500A to operate (OPR).
13. Press **F3** to start the calibration.
Gain DMM (CL0814) and Gain DMM (CL0815) will be calibrated now.
14. Wait until the display shows calibration status **Gain DMM (CL0815):READY**.
15. Set the 5500A to 0V (zero) and to Standby.
16. Continue at Section 4.6.5.

4.6.5 Volt Zero

Proceed as follows to do the Volt Zero calibration:

1. Press **F2** to select calibration adjustment step **Volt Zero (CL 0820):IDLE**.
2. Terminate Input A and Input B with the BB120 and a 50Ω or lower termination.
3. Press **F3** to start the zero calibration of all mV/d settings (CL0820...CL0835)
4. Wait until the display shows **Volt Zero (CL 0835):READY**.
5. Remove the 50Ω terminations from the inputs.
6. Continue at Section 4.6.6.

4.6.6 Zero Ohm

Proceed as follows to do the Zero Ohm calibration:

1. Press **F2** to select calibration adjustment step **Zero Ohm (CL 0840):IDLE**
2. Make a short circuit between the Input A banana socket and the COM input .
3. Press **F3** to start the Ohm Zero calibration of all ranges (CL 0840...CL 0846).
4. Wait until the display shows the calibration status **Zero Ohm (CL 0846):READY**.
5. Remove the Input A to COM short.
6. Continue at Section 4.6.7.

4.6.7 Gain Ohm

Proceed as follows to do the Gain Ohm calibration:

1. Press **F2** to select calibration adjustment step **Gain Ohm (CL 0860):IDLE**
2. Connect the UUT to the 5500A as shown in Figure 4-8.
Notice that the sense leads must be connected directly to the test tool.

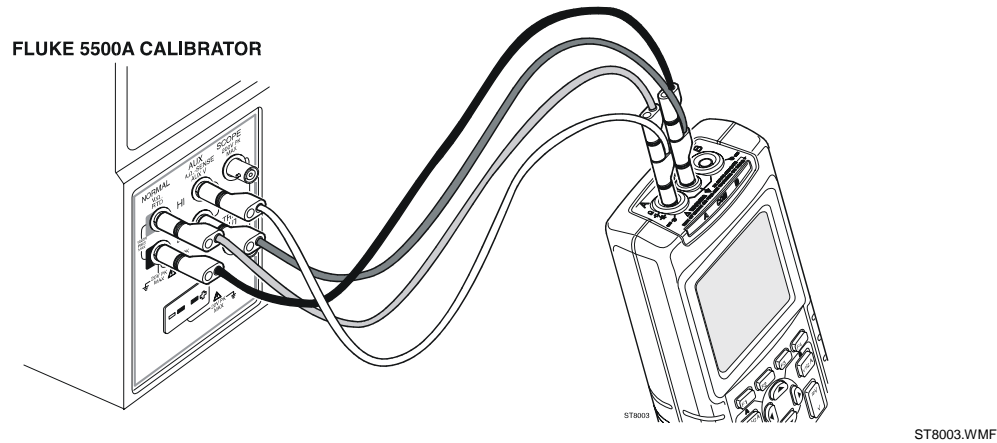

Figure 4-8. Four-wire Ohms calibration connections

3. Set the 5500A to the first test point in Table 4-4. Use the 5500A “COMP 2 wire” mode for the calibration adjustments up to and including 100 kΩ. For the higher values, the 5500A will turn off the “COMP 2 wire” mode.
4. Set the 5500A to operate (OPR).
5. Press **F3** to start the calibration.
6. Wait until the display shows the calibration status **:READY**.
7. Press **F2** to select the next calibration step, set the 5500A to the next calibration point, and start the calibration. Continue through all calibration points.
8. When you are finished, set the 5500A to Standby.
9. Continue at Section 4.6.8.

Table 4-4. Ohm Gain Calibration Points

Cal Step	Input Value
Gain Ohm (CL 0860)[Cap. Pos. (CL 0920), Cap.Neg. (CL 0921)] ¹⁾	100Ω
Gain Ohm (CL 0861)[Cap. Pos. (CL 0922), Cap.Neg. (CL 0923)] ¹⁾	1 kΩ
Gain Ohm (CL 0862)[Cap. Pos. (CL 0924), Cap.Neg. (CL 0925)] ¹⁾	10 kΩ
Gain Ohm (CL 0863)[Cap. Pos. (CL 0926), Cap.Neg. (CL 0927)] ¹⁾	100 kΩ
Gain Ohm (CL 0864)	1 MΩ
Gain Ohm (CL 0865)[Gain Ohm (CL 0866)] ²⁾	10 MΩ

¹⁾ The capacitance measurement current calibrations (Cap.Pos. and Cap.Neg) are done automatically after the Gain Ohm calibration.

²⁾ The Gain Ohm (CL0866) calibration step is done automatically after the Gain Ohm (CL0865) calibration.

4.6.8 Capacitance Gain Low and High

Proceed as follows to do the Capacitance Gain calibration:

1. Press **F2** to select calibration adjustment step **Cap. Low (CL 0900):IDLE**
2. Connect the test tool to the 5500A as shown in Figure 4-9.

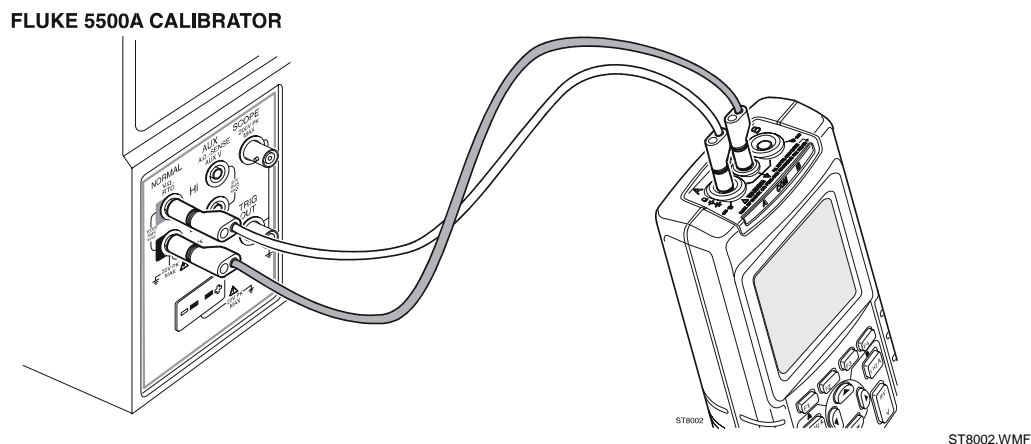

Figure 4-9. Capacitance Gain Calibration Input Connections

3. Set the 5500A to supply 250 mV DC.
4. Set the 5500A to operate (OPR).
5. Press **F3** to start the calibration.
6. Wait until the display shows **Cap. Low (CL 0900):READY**.
7. Press **F2** to select calibration adjustment step **Cap. High (CL 0910):IDLE**
8. Set the 5500A to supply 50 mV DC.
9. Press **F3** to start the calibration.
10. Wait until the display shows **Cap High (CL 910):READY**.
11. Set the 5500A to Standby.
12. Continue at Section 4.6.9.

4.6.9 Capacitance Clamp & Zero

Proceed as follows to do the Capacitance Clamp Voltage & Zero calibration:

1. Press **F2** to select calibration adjustment step **Cap. Clamp (CL 0940):IDLE**
2. Remove any input connection from the test tool (open inputs).
3. Press **F3** to start the calibration.
The capacitance measurement clamp voltage **Cap. Clamp (CL 0940)**, and the zero of the capacitance ranges **Cap. Zero (CL 0950)...** **Cap. Zero (CL 0953)** will be calibrated now.
4. Wait until the display shows **Cap. Zero (CL 0953): READY**.
5. Continue at Section 4.6.10.

4.6.10 Capacitance Gain

Proceed as follows to do the Capacitance Gain calibration:

1. Press **F2** to select calibration adjustment step **Cap. Gain (CL 0960):IDLE**
2. Connect the test tool to the 5500A as shown in Figure 4-9 (Section 4.6.8).
3. Set the 5500A to 500 nF.
4. Set the 5500A to operate (OPR).
5. Press **F3** to start the calibration.
6. Wait until the display shows **Cap. Gain (CL 0960):READY**.
7. Continue at Section 4.7 to save the calibration data.

4.7 Save Calibration Data and Exit

Proceed as follows to save the calibration data, and to exit the Maintenance mode:

1. Remove all test leads from the test tool inputs. Do NOT turn off the test tool!
2. Press **F4** (EXIT). The test tool will display:

**Calibration data is valid
Save data and EXIT maintenance?**

Note

Calibration data valid indicates that the calibration adjustment procedure is performed correctly. It does not indicate that the test tool meets the characteristics listed in Chapter 2.

4. Press **F4** (YES) to save and exit.

Notes

- *The calibration number and date will be updated only if the calibration data have been changed and the data are valid.*
- *The calibration data will change when a calibration adjustment has been done. The data will not change when just entering and then leaving the maintenance mode without doing a calibration adjustment.*
- *The calibration number and date will NOT be updated if only the display contrast has been adjusted.*

Possible error messages.

The following messages can be shown on the test tool display:

**WARNING.Calibration data NOT valid.
Save data and EXIT?**

Proceed as follows:

- To return to the Maintenance mode:
⇒ Press **F3** NO.
Now press **F1** until the display shows **WarmingUp (CL 0200):IDLE**, and calibrate the test tool, starting at Section 4.5.
- To exit and save the INVALID calibration data:
⇒ Press **F4** YES.

The test tool will show the message **The test tool needs calibration. Please contact your service center** at power on. The calibration date and number will not be updated. A complete recalibration must be done.

- To exit and maintain the old calibration data:
⇒ Turn the test tool off.

**WARNING.No adapter present.
Calibration data will not be saved.
Exit maintenance mode?**

- To save the calibration data:
⇒ Press **F3** NO
The test tool returns to the maintenance mode. Then supply the correct adapter input voltage, and press **F4** to exit and save.
- To exit without saving the calibration data: Press **F4** YES

Chapter 5

Disassembling the Test Tool

Title	Page
5.1. Introduction.....	5-3
5.2. Disassembling Procedures	5-3
5.1.1 Required Tools.....	5-3
5.2.2 Removing the Battery Pack	5-3
5.2.3 Removing the Bail	5-3
5.2.4 Opening the Test Tool	5-3
5.2.5 Removing the Main PCA Unit.....	5-5
5.2.6 Removing the Display Assembly.....	5-6
5.2.7 Removing the Keypad and Keypad Foil.....	5-6
5.3 Disassembling the Main PCA Unit.....	5-6
5.4 Reassembling the Main PCA Unit.....	5-8
5.5 Reassembling the Test Tool.....	5-8

5.1. Introduction

This section provides the required disassembling procedures. The printed circuit board removed from the test tool must be adequately protected against damage.

Warning

To avoid electric shock, disconnect test leads, probes and power supply from any live source and from the test tool itself. Always remove the battery pack before completely disassembling the test tool. If repair of the disassembled test tool under voltage is required, it shall be carried out only by qualified personnel using customary precautions against electric shock.

5.2. Disassembling Procedures

5.1.1 Required Tools

To access all the assemblies, you need the following:

- Static-free work surface, and anti-static wrist wrap.
- #8, and #10 Torx screwdrivers.
- Cotton gloves (to avoid contaminating the lens, and the PCA).

5.2.2 Removing the Battery Pack

Referring to Figure 5-1, use the following procedure to remove the battery pack.

1. Loosen the M3 Torx screw (item 15) (do not remove it) from the battery door.
2. Lift the battery door at the screw edge to remove it.
3. Lift out the battery pack, and unplug the cable leading to the Main PCA (pull the cable gently backwards).

5.2.3 Removing the Bail

Referring to Figure 5-1, use the following procedure to remove the bail (item 16).

1. Set the bail to a 45 degree position respective to the test tool bottom.
2. Holding the test tool tight, rotate the bail firmly sideways.

5.2.4 Opening the Test Tool

Referring to Figure 5-1, use the following procedure to open the test tool.

1. Remove the battery pack (see Section 5.2.2)
2. Unscrew the four M3 Torx screws (item 12) that secure the bottom case to the top case.
3. Hold the test tool upside down, and lift off the bottom case.



205 Westwood Ave
Long Branch, NJ 07740
1-877-742-TEST (8378)
Fax: (732) 222-7088
salesteam@Tequipment.NET

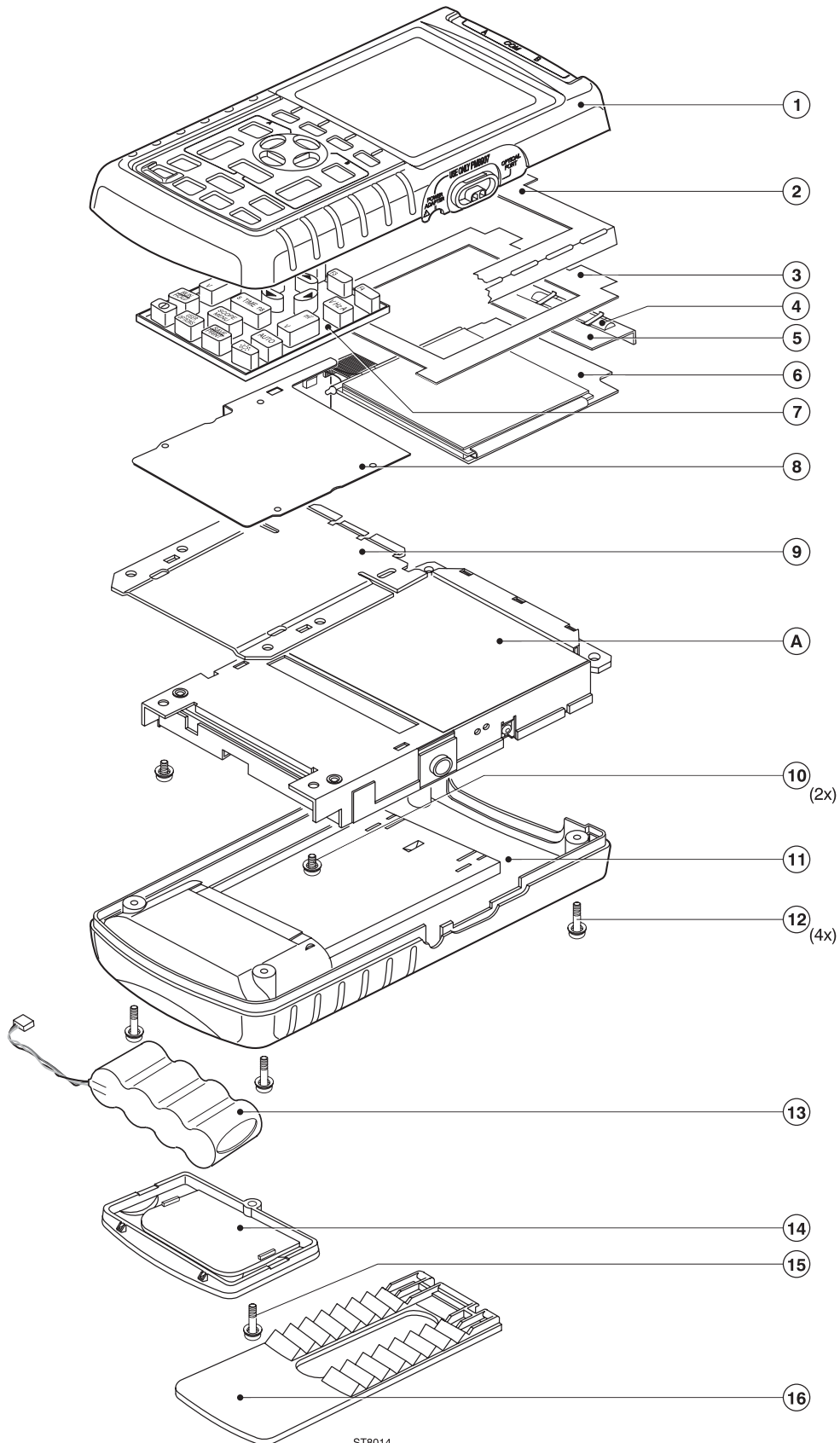

ST8014

ST8014.EPS

Figure 5-1. Fluke 123/124/125 Main Assembly

5.2.5 Removing the Main PCA Unit

Referring to Figure 5-1, use the following procedure to remove the main PCA unit.

1. Open the test tool (see Section 5.2.4).
2. Disconnect the LCD flex cable, and the keypad foil flat cable, see Figure 5-2. Unlock the cables by lifting the connector latch. The latch remains attached to the connector body. The keypad foil is provided with a shielding flap that covers the LCD flat cable. The end of the flap is put under the main PCA unit shielding plate, and can be easily pulled out.

Caution

To avoid contaminating the flex cable contacts with oil from your fingers, do not touch the contacts (or wear gloves). Contaminated contacts may not cause immediate instrument failure in controlled environments. Failures typically show up when contaminated units are operated in humid areas.

3. Unplug the backlight cable.

Warning

If the battery pack or the power adapter is connected, the LCD backlight voltage on the wire cable is 400V ! (when the test tool is on).

4. Remove the two screws (item 10) that secure the Main PCA unit to the top case.
5. Lift the screw end of the Main PCA unit and remove the unit by gently wiggling the assembly from side to side as you pull backwards.

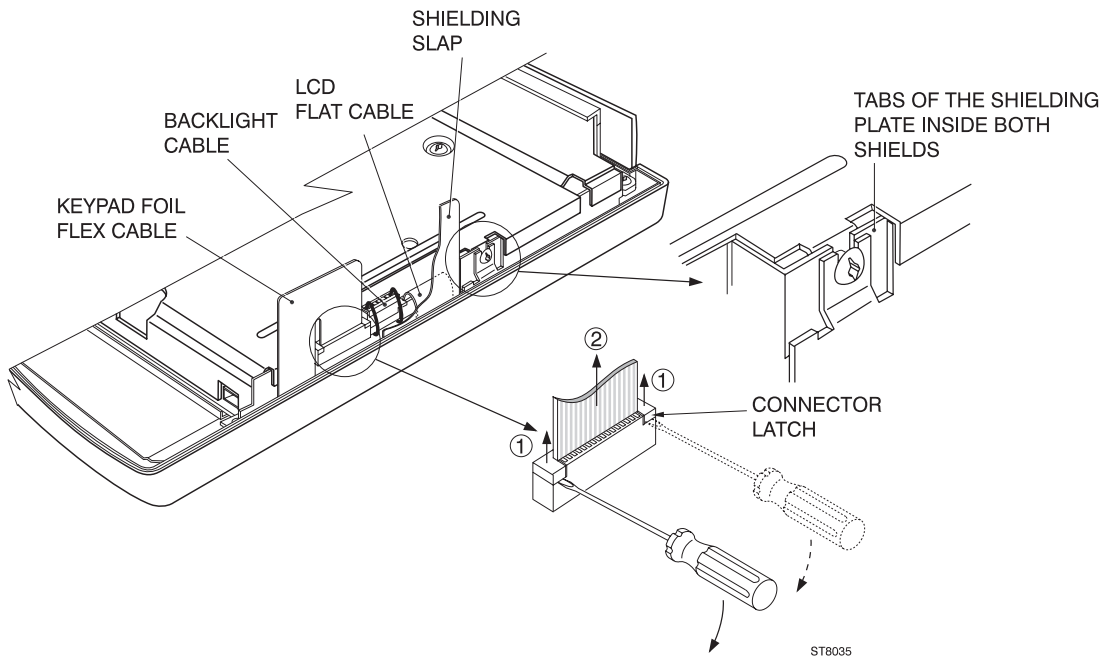

Figure 5-2. Flex Cable Connectors

ST8035.EPS

5.2.6 Removing the Display Assembly

Caution

Read the Caution statement in Section 5.5 when installing the display assembly. An incorrect installation can damage the display assembly.

There are no serviceable parts in the display assembly. Referring to Figure 5-1, use the following procedure to remove the display assembly.

1. Remove the main PCA unit (see Section 5.2.5).
2. The keypad pressure plate (item 9) is captivated by four plastic keeper tabs in the top case. Press the plate down, carefully slide the plate to release it from the tabs, and then remove it.
3. Remove the display assembly (item 6). To prevent finger contamination, wear cotton gloves, or handle the display assembly by its edge.

After removing the display assembly, the shielding bracket (item 5) with the conductive foam strip (item 4), the dust seal (item 3), and the shielding foil (item 2) can be removed.

5.2.7 Removing the Keypad and Keypad Foil

Referring to Figure 5-1, use the following procedure to remove the keypad and the keypad foil.

1. Remove the display assembly (see Section 5.2.6).
2. Remove the keypad foil. Notice the four keypad foil positioning pins in the top case.
3. Remove the keypad.

Caution

To avoid contaminating the keypad contacts, and the keypad foil contacts with oil from your fingers, do not touch the contacts (or wear gloves). Contaminated contacts may not cause immediate instrument failure in controlled environments. Failures typically show up when contaminated units are operated in humid areas.

5.3 Disassembling the Main PCA Unit

Referring to Figure 5-3, use the following procedure disassemble the main PCA unit.

1. Remove the M2.5 Torx screws (items 1 and 8) that secure the main shielding plate (item 7) to the main PCA shielding box (item 5).
2. Pull the shielding plate away from the input banana jacks as you rotate the far end upwards, and then remove it.
3. Remove the power input insulator (item 3), and the LED guide piece (item 6).
4. Remove the M2.5 Torx screws (item 2) that secure the PCA to the shielding box.
5. Lift the PCA at the screw end approximately 2 cm, and pull it away from the input banana jack holes to remove it.

Note

Each input banana jacket is provided with a rubber sealing ring (Input A,B item 9, COM input item 10). Ensure that the rings are present when reassembling the main PCA unit!

Caution

To avoid contaminating the main PCA with oil from your fingers, do not touch the contacts (or wear gloves). A contaminated PCA may not cause immediate instrument failure in controlled environments. Failures typically show up when contaminated units are operated in humid areas.

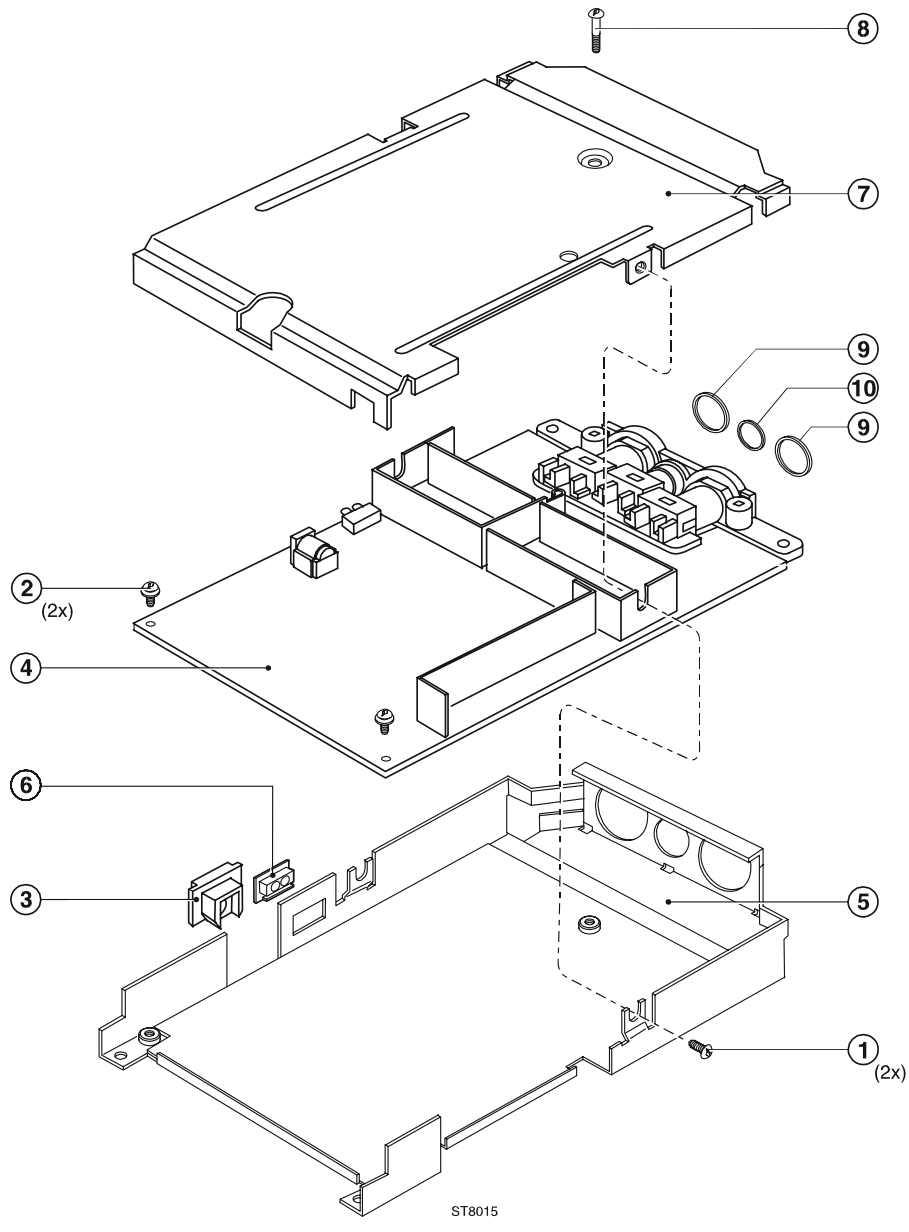

5-3. Main PCA Unit Assembly

5.4 Reassembling the Main PCA Unit

Reassembling the main PCA is the reverse of disassembly. However you must follow special precautions when reassembling the main PCA unit.

1. Ensure the input banana jacks have the rubber sealing ring in place (Input A, B item 9, COM input item 10, see Figure 5-3).
2. Do not forget to install the power connector insulator (item 3) and the LED holder (item 6).
3. Notice the correct position of the shielding box, main PCA (notice the shielding plates on the PCA), and shielding plate, as shown in Figure 5-2. The tabs of the shielding plate must be inside both shields.

5.5 Reassembling the Test Tool

Reassembling the test tool is the reverse of disassembly. However you must follow special precautions when reassembling the test tool. Refer also to figure 5-1.

Caution

The first shipped units are provided with a yellow tube on the two notches with the screw inserts at the top in the top case,. The reason for this is that the display assembly in these units is smaller than in the later units. All display assemblies supplied as spare part are of the latest type, and do not need the yellow tubes in the top case.

- **Remove the tube from both notches when installing a new display assembly!**
- **Transfer the tubes to the new top case, if you replace a top case that has the tubes installed, and you re-install the unit's original display assembly.**

Reassembling procedure for a completely disassembled unit:

1. Clean the inside of the lens with a moist soft cloth if necessary. Keep the lens free of dust and grease.
2. Install the keypad. Press the edge of the keypad into the sealing groove of the top case. Ensure that the keypad lays flat in the top case, and that all keys are correctly seated.
3. Install the shielding foil (item 2). Remove the protection foil from the shielding foil, by pulling it off in one rapid movement! If you pull it off slowly, the protection foil may crack. Keep the shielding foil free of dust and grease.
4. Install the dust seal (item 3).
5. Install the display shielding bracket (item 5) provided with the conductive foam strip (item 4).

Note

Figure 5-4 shows how the shielding bracket (with conductive foam strip), the shielding foil, the dust seal, and the display assembly (see step 7) are clamped in the top cover edge.

6. Install the keypad foil. Align the positioning holes in the keypad foil to the positioning pins in the top case.

7. Clean the display glass with a moist soft cloth if necessary. Install the display assembly. Ensure that the display is secured correctly by the four alignment tabs in the top case. It is secured correctly when it cannot be moved horizontally.
8. Install the keypad pressure plate. Press the plate firmly, and slide it under the four plastic keeper tabs in the top case.
9. Install the main PCA unit, and re-attach the cables. Secure the flat cables in the connectors with the connector latches. **Keep the backlight wires twisted to minimize interference voltages!** Insert the shielding flap below the main PCA shielding plate.
10. Put the bottom case and the top case together at the flat cable side, and hinge the cases to each other. This ensures the keypad foil flat cable is folded correctly.
11. Install the battery pack, and the battery door, see figure 5-5.

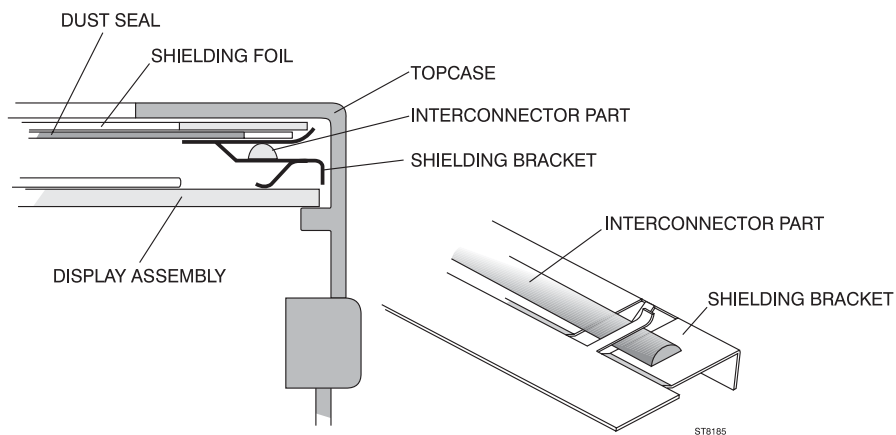

Figure 5-4. Mounting the display shielding bracket

ST8185.EPS

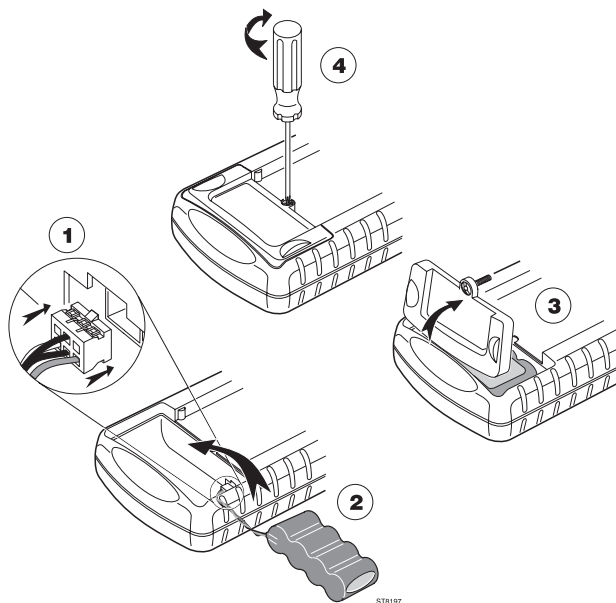

Figure 5-5. Battery pack installation

ST8197.EPS

Chapter 6

List of Replaceable Parts

Title	Page
6.1 Introduction.....	6-3
6.2 How to Obtain Parts.....	6-3
6.3 Service Centers	6-3
6.4 Final Assembly Parts	6-4
6.5 Main PCA Unit Parts	6-6
6.6 Service Tools	6-7
6.7 Accessory Replacement Parts	6-7

6.1 Introduction

This chapter contains an illustrated list of replaceable parts for the model 123, 124 or 125 ScopeMeter test tool. Parts are listed by assembly; alphabetized by item number or reference designator. Each assembly is accompanied by an illustration showing the location of each part and its item number or reference designator. The parts list gives the following information:

- Item number or reference designator
- An indication if the part is subject to static discharge: the * symbol
- Description
- Ordering code
- Location on the Main PCA (e.g. 'C 4 Top' or 'B 3 Bottom' on Top Side or Bottom Side of PCA).

Caution

A * symbol indicates a device that may be damaged by static discharge.

6.2 How to Obtain Parts

Contact an authorized Fluke service center.

To locate an authorized service center refer to the second page of this manual (back of the title page).

In the event that the part ordered has been replaced by a new or improved part, the replacement will be accompanied by an explanatory note and installation instructions, if necessary.

To ensure prompt delivery of the correct part, include the following information when you place an order:

- Instrument model (Fluke 123, 124 or 125), 12 digit instrument code (9444), and serial number (DM.....). The items are printed on the type plate on the bottom cover.
- Ordering code
- Item number - Reference designator
- Description
- Quantity

6.3 Service Centers

To locate an authorized service center, call Fluke using any of the phone numbers listed below, or visit on the World Wide Web: www.fluke.com
USA and Canada: 1-888-99-FLUKE (1-888-993-5853)
Europe: +31-40-2675200
Japan: +81-3-3434-0181
Singapore: +65-679 95588
Anywhere in the world: +1-425-446-5500

6.4 Final Assembly Parts

See Table 6-1 and Figure 6-1 for the Final Assembly parts.

Table 6-1. Final Assembly Parts

Item	Description	Ordering Code
1	top case assembly	5322 442 00272
1	window/decal (lens) Fluke 123	4022 240 12431
1	window/decal (lens) Fluke 124	4022 240 13031
1	window/decal (lens) Fluke 125	0040 243 00801
2	shielding foil	5322 466 11434
3	dust seal	5322 466 11435
4	conductive foam strip	5322 466 11436
5	display shielding bracket	5322 402 10204
6	display assembly	5322 135 00029
7	keypad	5322 410 10397
8	keypad foil	5322 276 13711
9	keyboard pressure plate	5322 466 10963
10	combiscrew M3x10	5322 502 21507
11	bottom case	5322 442 00273
12	combiscrew M3x10	5322 502 21507
13	battery pack (Ni-MH)	BP120MH
14	battery door	4022 244 98491
15	combiscrew M3x10	5322 502 21507
16	bail	5322 466 10975
A	Main PCA unit for Fluke 123/124 or 125. The Main PCA in this Analyzer is only available to Fluke Service Centers due to the programming that is necessary after installation.	---



Note

The Test Tool contains a Rechargeable Ni-MH battery. Do not mix with the solid wastestream. Spent batteries should be disposed of by a qualified recycler or hazardous materials handler.

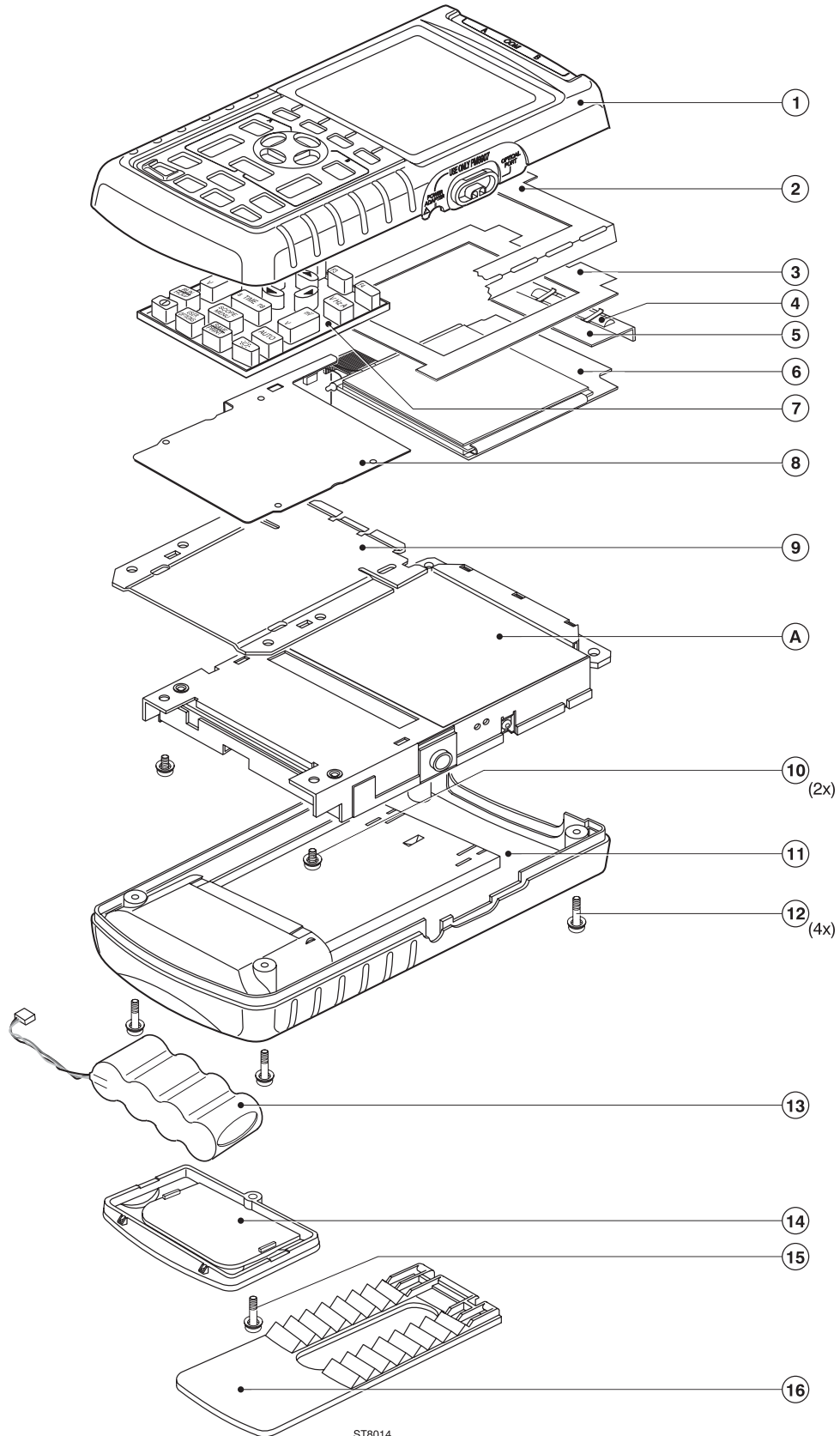

ST8014

Figure 6-1. Fluke 123/124/125 Final Assembly

ST8014.EPS

6.5 Main PCA Unit Parts

See Table 6-2 and Figure 6-2 for the Main PCA Unit parts.

Table 6-2. Main PCA Unit

Item	Description	Ordering Code
1	screw M2.5x5	5322 502 21206
2	combiscrew M3x10	5322 502 21507
3	insulator for power input	5322 325 10163
5	main PCA shielding box	5322 466 10976
6	guide piece for optical gate LEDs	5322 256 10201
7	main PCA shielding plate	5322 466 10964
8	screw M2.5x16	5322 502 14132
9	O-ring \varnothing 17 mm Input A,B	5322 530 10272
10	O-ring \varnothing 12 mm COM input	5322 530 10273

Note

If the main PCA must be replaced, you must order the complete Main PCA Unit.

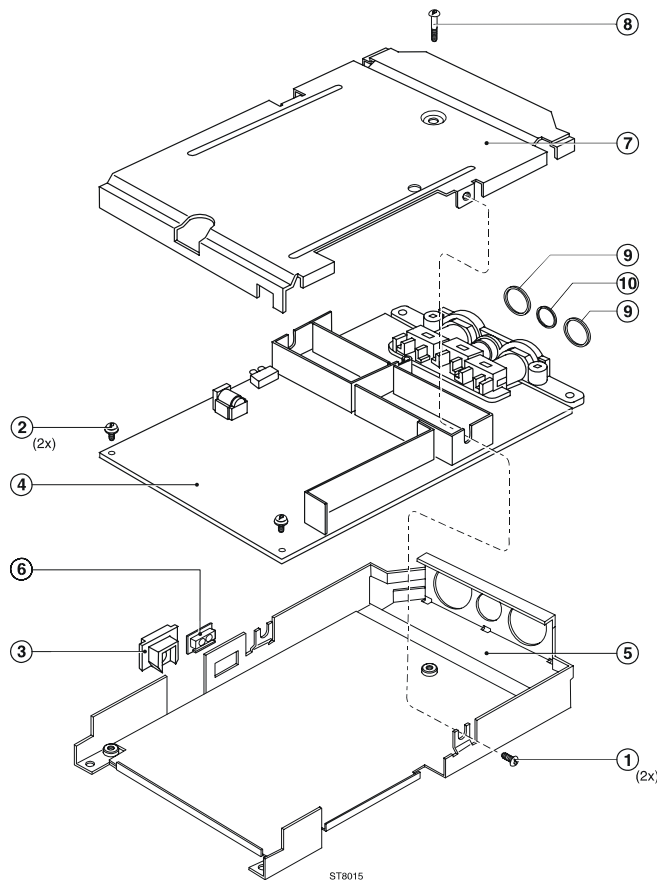

Figure 6-2. Main PCA Unit

ST8015.CGM

6.6 Service Tools

Power adapter cable to check supply current 5322 320 11707

6.7 Accessory Replacement Parts

Table 6-3. Standard Accessories







Description	Model Number/Ordering Code
<p>Power Adapter/Battery Charger, available models:</p> <p>Universal Europe 230V, 50Hz</p> <p>North America 120V, 60Hz </p> <p>United Kingdom 240V, 50Hz</p> <p>Japan 100V, 60Hz</p> <p>Australia 240V, 50Hz</p> <p>Universal 115V/230V (*) </p> <p>(*) <i>UL listing applies to PM8907/808 with UL listed line plug adapter for North America. The 230 V rating of the PM8907/808 is not for use in North America. For other countries, a line plug adapter complying with the applicable National Requirements must be used.</i></p>	<p>PM8907/801</p> <p>PM8907/803</p> <p>PM8907/804</p> <p>PM8907/806</p> <p>PM8907/807</p> <p>PM8907/808</p>
<p>Set of two Shielded Test Leads (Red and Gray), designed for use only with the Fluke ScopeMeter 120 series test tool. </p> <p>Set contains the following replaceable part: Ground Lead with Alligator Clip (Black)</p>	<p>STL120</p> <p>5322 320 11354</p>
<p>One 10:1 Scope Probe VP40 </p>	<p>VPS40 (is VP40 probe including hook clip and ground lead)</p>
<p>AC Current Clamp 40 A / 400 A (Fluke 125)</p>	<p>i400s</p>
<p>Test Lead for Grounding (Black) </p>	<p>TL75 (red + black lead)</p>
<p>Set of two Hook Clips (Red and Gray) </p>	<p>HC120</p>
<p>Set of three Alligator Clips (Red, Gray, and Black)</p>	<p>AC120</p>
<p>Banana-to-BNC Adapter (Black) </p>	<p>BB120 (Set of two)</p>
<p>CD-ROM with Users Manual (All languages)</p> <p><i>Note: all manuals can be downloaded from Fluke's website www.fluke.com</i></p>	<p>4022 240 12370</p>

Table 6-4. Optional Accessories

Description	Model Number/Ordering Code
Software & Cable Carrying Case Kit (Supplied with Fluke 123/S, 124/S, 125/S) Set contains the following parts: Optically Isolated RS-232/USBAdapter/Cable Hard Carrying Case. Supplied with Fluke 123/S, 124/S, 125/S FlukeView [®] ScopeMeter [®] Softwarefor Windows [®]	SCC 120 OC4USB C120 SW90W
Hard Carrying Case	C120
Compact Soft Case	C125
Isolated Trigger Probe	ITP120
Print Adapter Cable for Parallel Printers	PAC91



205 Westwood Ave
Long Branch, NJ 07740
1-877-742-TEST (8378)
Fax: (732) 222-7088
salesteam@Tequipment.NET