

**T**equipment  
.**NET**



205 Westwood Ave  
Long Branch, NJ 07740  
1-877-742-TEST (8378)  
Fax: (732) 222-7088  
salesteam@Tequipment.NET

**FLUKE**®

# Fluke 125

Industrial ScopeMeter

Users Manual

GB

Dec 2006, Rev. 3, 09/2009

© 2006, 2007, 2008, 2009 Fluke Corporation. All rights reserved.

All product names are trademarks of their respective companies.



## **LIMITED WARRANTY & LIMITATION OF LIABILITY**

Each Fluke product is warranted to be free from defects in material and workmanship under normal use and service. The warranty period is three years for the Fluke 120 Series Test Tool and one year for its accessories. The warranty period begins on the date of shipment. Parts, product repairs and services are warranted for 90 days. This warranty extends only to the original buyer or end-user customer of a Fluke authorized reseller, and does not apply to fuses, disposable batteries or to any product which, in Fluke's opinion, has been misused, altered, neglected or damaged by accident or abnormal conditions of operation or handling. Fluke warrants that software will operate substantially in accordance with its functional specifications for 90 days and that it has been properly recorded on non-defective media. Fluke does not warrant that software will be error free or operate without interruption.

Fluke authorized resellers shall extend this warranty on new and unused products to end-user customers only but have no authority to extend a greater or different warranty on behalf of Fluke. Warranty support is available if product is purchased through a Fluke authorized sales outlet or Buyer has paid the applicable international price. Fluke reserves the right to invoice Buyer for importation costs of repair/replacement parts when product purchased in one country is submitted for repair in another country.

Fluke's warranty obligation is limited, at Fluke's option, to refund of the purchase price, free of charge repair, or replacement of a defective product which is returned to a Fluke authorized service center within the warranty period.

To obtain warranty service, contact your nearest Fluke authorized service center or send the product, with a description of the difficulty, postage and insurance prepaid (FOB Destination), to the nearest Fluke authorized service center. Fluke assumes no risk for damage in transit. Following warranty repair, the product will be returned to Buyer, transportation prepaid (FOB Destination). If Fluke determines that the failure was caused by misuse, alteration, accident or abnormal condition of operation or handling, Fluke will provide an estimate of repair costs and obtain authorization before commencing the work. Following repair, the product will be returned to the Buyer transportation prepaid and the Buyer will be billed for the repair and return transportation charges (FOB Shipping Point).

**THIS WARRANTY IS BUYER'S SOLE AND EXCLUSIVE REMEDY AND IS IN LIEU OF ALL OTHER WARRANTIES, EXPRESS OR IMPLIED, INCLUDING BUT NOT LIMITED TO ANY IMPLIED WARRANTY OF MERCHANTABILITY OR FITNESS FOR A PARTICULAR PURPOSE. FLUKE SHALL NOT BE LIABLE FOR ANY SPECIAL, INDIRECT, INCIDENTAL OR CONSEQUENTIAL DAMAGES OR LOSSES, INCLUDING LOSS OF DATA, WHETHER ARISING FROM BREACH OF WARRANTY OR BASED ON CONTRACT, TORT, RELIANCE OR ANY OTHER THEORY.**

Since some countries or states do not allow limitation of the term of an implied warranty, or exclusion or limitation of incidental or consequential damages, the limitations and exclusions of this warranty may not apply to every buyer. If any provision of this Warranty is held invalid or unenforceable by a court of competent jurisdiction, such holding will not affect the validity or enforceability of any other provision.

Fluke Corporation, P.O. Box 9090, Everett, WA 98206-9090 USA, or

Fluke Industrial B.V., P.O. Box 90, 7600 AB, Almelo, The Netherlands

## **SERVICE CENTERS**

To locate an authorized service center, visit us on the World Wide Web:

**<http://www.fluke.com>**

or call Fluke using any of the phone numbers listed below:

+1-888-993-5853 in U.S.A. and Canada

+31-402-675-200 in Europe

+1-425-446-5500 from other countries

# Table of Contents

Chapter	Title	Page
	Declaration of Conformity.....	0-1
	Unpacking the Test Tool Kit.....	0-2
	Safely Using the Test Tool.....	0-4
	<b>General Operating Instructions .....</b>	<b>1-1</b>
	Introduction.....	1-1
	Preparations for Use.....	1-1
	Powering the Test Tool.....	1-1
	Resetting the Test Tool.....	1-2
	Changing Backlight.....	1-3
	Changing Contrast.....	1-3
	Making Selections in a Menu.....	1-4
	Looking at the Measurement Connections.....	1-5
	Input A.....	1-5

Input B .....	1-5
COM .....	1-5
Measurement Probes & Settings .....	1-6
<b>Scope/Meter Mode .....</b>	<b>2-1</b>
Introduction .....	2-1
Selecting the Scope/Meter Mode .....	2-1
Reading the Screen .....	2-2
Displaying an Unknown Signal with Connect-and-View™ (Auto Set) .....	2-3
Making Measurements .....	2-4
Connecting the Inputs .....	2-4
Selecting a measurement function. ....	2-6
Freezing the Screen .....	2-8
Holding a Stable Reading .....	2-8
Making Relative Measurements.....	2-9
Selecting Auto/Manual Ranges.....	2-10
Changing the Graphic Representation on the Screen.....	2-10
Changing the Amplitude.....	2-10
Changing the Time Base.....	2-10
Positioning the Waveform on the Screen .....	2-11
Smoothing Waveforms and Readings.....	2-12
Displaying the Envelope of a Waveform .....	2-13
Acquiring the Waveform .....	2-14
Making a Single Acquisition .....	2-14
Recording Slow Signals over a Long Period of Time .....	2-15
Selecting AC-Coupling .....	2-16

---

Reversing the Polarity of the Displayed Waveform .....	2-16
Triggering on a Waveform .....	2-17
Setting Trigger Level and Slope .....	2-17
Selecting the Trigger Parameters .....	2-18
Isolated Triggering .....	2-19
Triggering on Video Signals .....	2-20
Triggering on a Specific Video Line .....	2-21
Making Cursor Measurements .....	2-22
Using Horizontal Cursors on a Waveform .....	2-22
Using Vertical Cursors on a Waveform .....	2-23
Using the 10:1 Probe for High Frequency Measurements .....	2-25
Probe Attenuation .....	2-25
Probe Adjustment .....	2-25
<b>Harmonics .....</b>	<b>3-1</b>
Introduction .....	3-1
Measuring Harmonics .....	3-1
Performing Harmonics Measurements .....	3-2
Zooming Harmonics .....	3-4
Using Cursors .....	3-4
Reading the Harmonics Screen .....	3-5
<b>Field Bus Measurements .....</b>	<b>4-1</b>
Introduction .....	4-1
Performing Fieldbus Measurements .....	4-2
Reading the Screen .....	4-4
Viewing the Bus Waveform Screen .....	4-7
Setting the Test Limits .....	4-8
Saving and Recalling Test Limits .....	4-9

<b>Plotting Measurements over Time (TrendPlot™)</b> .....	<b>5-1</b>
Introduction .....	5-1
Starting/Stopping a TrendPlot™ .....	5-1
Changing the TrendPlot Reading .....	5-3
Making TrendPlot Cursor Measurements .....	5-3
<b>Saving and Recalling Data Sets</b> .....	<b>6-1</b>
Introduction .....	6-1
Saving Data Sets .....	6-1
Recalling, Renaming, Deleting Data Sets .....	6-3
<b>Using a Printer and FlukeView</b> .....	<b>7-1</b>
Introduction .....	7-1
Using a Printer .....	7-1
Using FlukeView® Software .....	7-3
<b>Maintaining the Test Tool</b> .....	<b>8-1</b>
Introduction .....	8-1
Cleaning the Test Tool .....	8-1
Storing the Test Tool .....	8-1
Charging the Rechargeable Battery Pack .....	8-2
Keeping Batteries in Optimal Condition .....	8-3
Replacing and Disposing of the Rechargeable Battery Pack .....	8-4
Using and Adjusting 10:1 Scope Probes .....	8-5
Calibration Information .....	8-7
Parts and Accessories .....	8-7



---

Service Manual .....	8-7
Standard Accessories .....	8-7
Optional Accessories .....	8-10
<b>Tips and Troubleshooting.....</b>	<b>9-1</b>
Introduction .....	9-1
Using the Tilt Stand.....	9-1
Changing the Information Language .....	9-2
Setting the Grid Display .....	9-2
Changing Date and Time .....	9-3
Saving Battery Life.....	9-4
Setting the Power Down Timer.....	9-4
Changing the Auto Set Options.....	9-5
Using Proper Grounding .....	9-6
Solving Printing and Other Communication Errors.....	9-7
Battery Testing of Fluke Accessories.....	9-7
<b>Specifications .....</b>	<b>10-1</b>
Introduction .....	10-1
Dual Input Oscilloscope .....	10-2
Dual Input Meter .....	10-4
Cursor readout.....	10-8
Harmonics Measurements .....	10-9
Field Bus Measurements .....	10-9
Miscellaneous .....	10-10
Environmental .....	10-11
⚠ Safety .....	10-11

Appendices.....	0-1
<b>Bushealth Measurements .....</b>	<b>A-1</b>
Introduction .....	A-1
General .....	A-1
Use of Probes and Accessories.....	A-2
Tips and Hints per Bustype.....	A-3
AS-i Bus .....	A-3
CAN Bus/DeviceNet.....	A-4
Interbus S .....	A-5
ControlNet.....	A-5
Modbus IEA-232/RS-232 .....	A-6
Modbus IEA-485/RS-485 .....	A-7
Foundation Fieldbus H1 31.25 kBits/s.....	A-7
Profibus DP/RS-485.....	A-8
Profibus PA/31.25 kBits/s .....	A-9
Ethernet Coax/10Base2.....	A-9
Ethernet Twisted pair/10BaseT .....	A-10
RS-232 Bus.....	A-11
RS-485 Bus.....	A-11
Overview of Female DB-connectors.....	A-12

***Declaration of Conformity***

for

Fluke 125

ScopeMeter® test tool

**Manufacturer**

Fluke Industrial B.V.  
Lelyweg 14  
7602 EA Almelo  
The Netherlands

**Statement of Conformity**

Based on test results using appropriate standards,  
the product is in conformity with  
Electromagnetic Compatibility Directive 2004/108/EC  
Low Voltage Directive 2006/95/EC

**Sample tests**

Standards used:

EN 61010-1: 2001

Safety Requirements for Electrical Equipment for  
Measurement, Control, and Laboratory Use

EN61326-1: 2006

Electrical equipment for  
measurements and laboratory  
use -EMC requirements-

The tests have been performed in a  
typical configuration

The tests have been performed in a  
typical configuration.

This Conformity is indicated by the symbol **CE**,  
i.e. "Conformité Européenne".

## Unpacking the Test Tool Kit

The following items are included in your test tool kit. (see Figure 1.):

### Note

*When new, the rechargeable battery pack is not fully charged. See Chapter 2.*

#	Description	Fluke 125	Fluke 125/S
1	Fluke Test Tool	Model 125	Model 125
2	Rechargeable NiMH Battery Pack	●	●
3	Power Adapter/Battery Charger	●	●
4	Shielded Test Leads with Black Ground Leads	●	●
5	Test Lead Black (for Grounding)	●	●
6	Alligator Clips (red, gray, black)	●	●
7	Banana-to-BNC Adapters (black)	● (1x)	● (2x)
8	Safety Information+ CD-ROM with Users Manuals	●	●
9	10:1 Voltage Probe	●	●
10	Current Clamp	●	●
11	Shipment Box	●	
12	Optically Isolated RS-232/USB Adapter/Cable		●
13	FlukeView® ScopeMeter® Software for Windows®		●
14	Hard Carrying Case		●

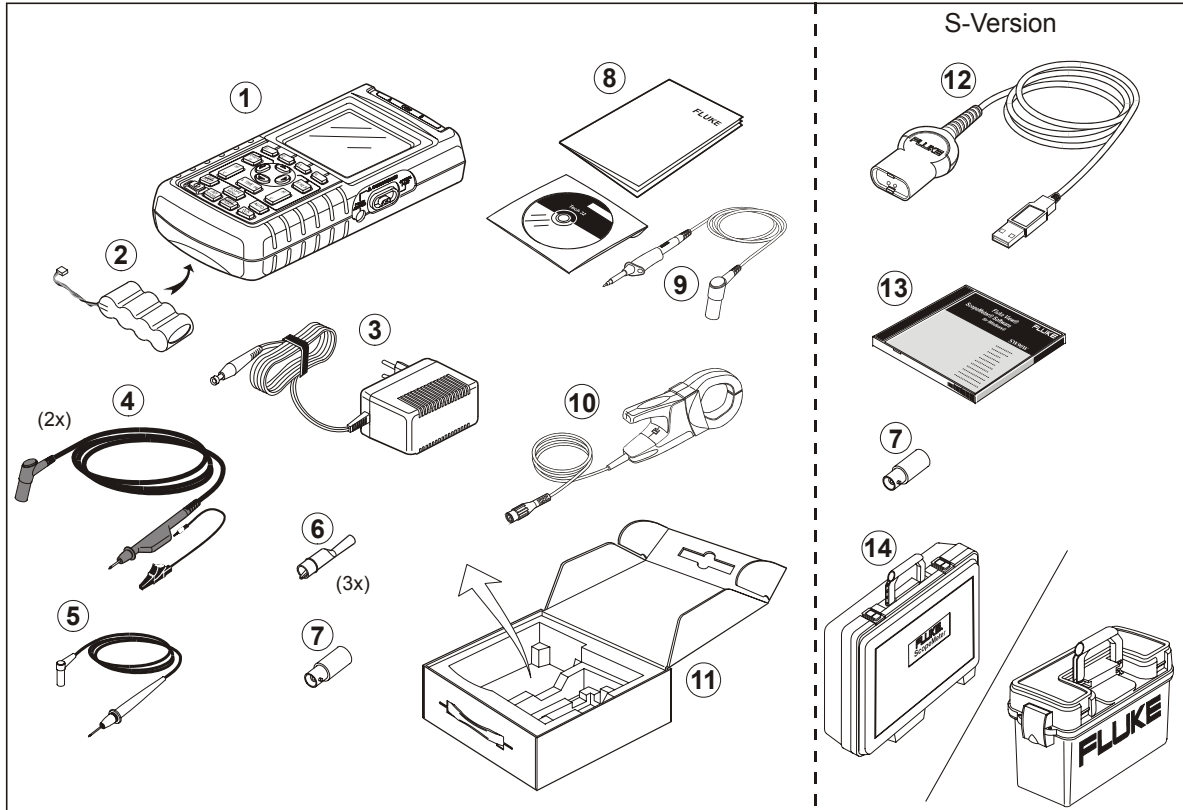

Figure 1. ScopeMeter Test Tool Kit

## **Safely Using the Test Tool**

### **Attention**

**Carefully read the following safety information before using the test tool.**

### **Safety Precautions**

Specific warning and caution statements, where they apply, will be found throughout the manual.









**A Caution identifies conditions and actions that may damage the test tool.**

**A Warning identifies conditions and actions that pose hazard(s) to the user.**

Symbols used on the test tool and in this manual are explained in the next table.

### **Warning**

**To avoid electrical shock, use only Fluke power supply, Model PM8907 (Power Adapter/Battery Charger).**

	See explanation in manual		Equal potential inputs
	Disposal information		Earth
	Recycling information		Conformité Européenne
	Double Insulation (Protection Class)		Conforms to applicable Canadian and US standards
	Do not dispose of this product as unsorted municipal waste. Go to Fluke's website for recycling information.		

### **Warning**

**Should this test tool be used with AC coupling selected, or manual operation of amplitude or time base ranges, the measuring results displayed on the screen may not be representative of the total signal. This can result in the presence of dangerous voltages of more than 42V peak (30V rms), not being detected. To guarantee user safety, all signals should first be measured with DC coupling selected and in fully automatic mode. This ensures that the full signal content is measured.**

 **Warning** 

To avoid electrical shock or fire:

- Use only the power supply, Model PM8907 (Battery Charger / Power Adapter).
- Before use check that the selected/indicated voltage range on the PM8907 matches the local line power voltage and frequency.
- For the PM8907/808 universal Battery Charger/Power Adapter use only line cords that comply with the local safety regulations.

*Note*

*To accommodate connection to various line power sockets, the PM8907/808 universal Battery Charger / Power Adapter is equipped with a male plug that must be connected to a line cord appropriate for local use. Since the adapter is isolated, the line cord does not need to be equipped with a terminal for connection to protective ground. Since line cords with a protective grounding terminal are more commonly available you might consider using these anyhow.*

 **Warning**

To avoid electrical shock or fire if a Test Tool input is connected to more than 42 V peak (30 Vrms) or on circuits of more than 4800 VA:

- Use only insulated voltage probes, test leads and adapters supplied with the Test Tool, or indicated as suitable for the Fluke 125 Test Tool.
- Before use, inspect voltage probes, test leads and accessories for mechanical damage and replace when damaged.
- Remove all probes, test leads and accessories that are not in use.
- Always connect the battery charger first to the ac outlet before connecting it to the Test Tool.
- Do not apply input voltages above the rating of the instrument. Use caution when using 1:1 test leads because the probe tip voltage will be directly transmitted to the Test Tool.
- Do not use exposed metal BNC or banana plug connectors.
- Do not insert metal objects into connectors.
- Always use the Test Tool only in the manner specified.

 **Max. Input Voltages**

Input A and B directly .....	600 V CAT III
Input A and B via BB120 .....	300 V CAT III
Input A and B via STL120 .....	600 V CAT III

 **Max. Floating Voltage**

From any terminal to ground .....	600 V CAT III
-----------------------------------	---------------

**Voltage ratings are given as “working voltage”. They should be read as Vac-rms (50-60 Hz) for AC sine wave applications and as Vdc for DC applications.**

Measurement Category III refers to distribution level and fixed installation circuits inside a building.

The terms ‘Isolated’ or ‘Electrically floating’ are used in this manual to indicate a measurement in which the Test Tool’s Shielded Banana inputs or banana jack is connected to a voltage different from earth ground.

The isolated input connectors have no exposed metal and are fully insulated to protect against electrical shock.

***If Safety Features are Impaired***

**Use of the Test Tool in a manner not specified may impair the protection provided by the equipment.**

Before use, inspect the test leads for mechanical damage and replace damaged test leads!

Whenever it is likely that safety has been impaired, the Test Tool must be turned off and disconnected from the line power. The matter should then be referred to qualified personnel. Safety is likely to be impaired if, for example, the Test Tool fails to perform the intended measurements or shows visible damage.



# Chapter 1

## General Operating Instructions

### Introduction

This Chapter provides a step-by-step introduction to the general test tool functions.

### Preparations for Use

At delivery, the batteries may be empty and must be charged for at least 7 hours. Deeply discharged batteries may even cause the test tool not to start up when it is turned on. Refer to chapter 8 for charging instructions.

### Powering the Test Tool

Follow the procedure (step 1 to 3) in Figure 1-1 to power the test tool from a standard ac outlet. See Chapter 8 for battery power instructions.

The test tool powers up in its last setup configuration.

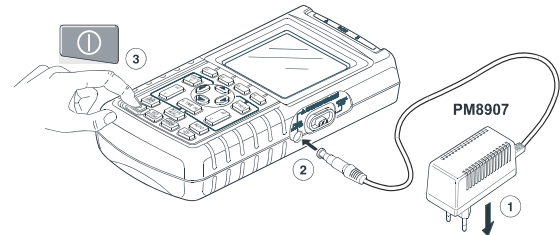



**Figure 1-1. Powering the Test Tool**

#### Note

When battery powered, the battery indicator informs you about the condition of the battery from full to empty: .

## **Resetting the Test Tool**

If you want to restore the test tool settings as delivered from the factory, do the following:

- ①  Turn the test tool off.
- ②  Press and hold.
- ③  Press and release.

The test tool turns on, and you should hear a double beep, indicating the Reset was successful.

- ④  Release.

Now look at the display; you will see a screen that looks like Figure 1-2.

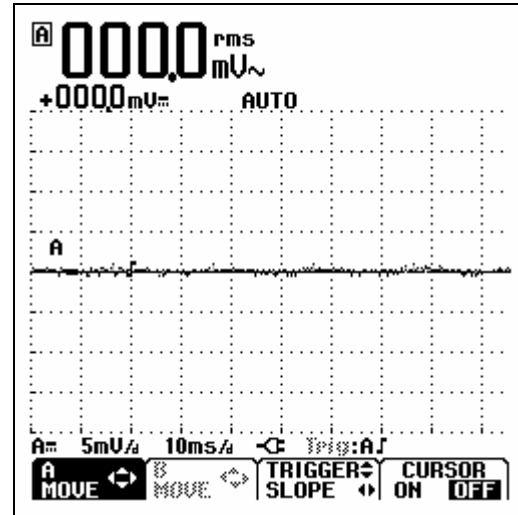

**Figure 1-2. The Screen After Reset**

## Changing Backlight



After power-up, the screen has a high bright display.

To save battery power, the screen has an economic brightness display when operated on the battery pack (no power adapter connected).

### Note

*Using dimmed display lengthens maximum battery power operation time.*



To change the brightness of the display,, do the following:

- ①  Invoke the LIGHT-CONTRAST button bar.
- ②  Select LIGHT
- ③  Dim or brighten the backlight.

The high brightness increases when you connect the power adapter.







## Changing Contrast

To change the screen contrast, do the following:



- ①  Invoke the LIGHT-CONTRAST button bar.
- ②  Select CONTRAST.
- ③  Press and hold to change the contrast.

## **Making Selections in a Menu**

How to use the menus is illustrated in the example below on how to adjust the test tool for use with a certain printer type:

①		The user options menu pops up.
②		Highlight PRINTER SETUP...
③		Open the PRINTER SETUP menu
④		Highlight the required printer type
⑤		Accept the printer type.
⑥		Highlight the required baud rate
⑦		Accept the baud rate. The menu will be closed.

### Notes

- Pressing  a second time closes this menu and resumes normal measurement. This toggling enables you to check the menu without changing your settings.
- When you do not change an item with the blue arrow keys, repeatedly pressing  enables you to step through a menu without changing the setup of the test tool.
- Gray text in a menu or button bar indicates that the function is disabled or the status is not valid.

## Looking at the Measurement Connections

Look at the top of the test tool. The test tool provides two 4-mm safety shielded banana jack inputs (red input A and gray input B) and a black safety 4-mm banana jack input (COM). (See Figure 1-3.)

### Input A

You can always use the red input A for all single input measurements possible with the test tool.



### Input B

For measurements on two different signals you can use the gray input B together with the red input A .

### COM

You can use the black COMmon as single ground for low frequency measurements, and for Continuity, Ohm ( $\Omega$ ), Diode, and Capacitance measurements.

### Warning

To avoid electrical shock or fire, use only one COM  (common) connection, or ensure that all connections to COM  are at the same potential.

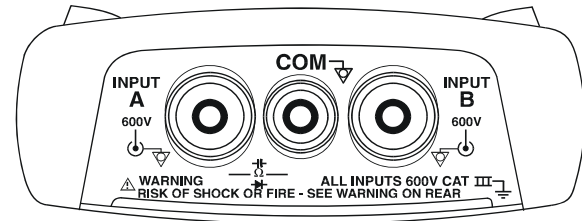









Figure 1-3. Measurement Connections

## **Measurement Probes & Settings**

For the SCOPE/METER mode and the HARMONICS mode various probes can be used for the test tool measurement functions, for example a 10:1 voltage probe, a 1mV/°C Temperature probe, or a 10 mV/A current clamp.

To adapt the test tool readout to the used probe, do the following:

- |   |   |   |
|---|---|---|
| ① |  (A) | The Input A or Input B MEASUREMENTS menu and a F1....F4 button bar pops up. |
|   |  (B) |   |
| ② |      | Open the INPUT... menu.   |
| ③ |      | Highlight SELECT...   |
| ④ |      | Open the PROBE on A (B) menu  |
| ⑤ |      | Highlight the required probe type   |
| ⑥ |      | Accept the probe type. The menu will be closed.                             |
| ⑦ |  2x  | Close the INPUT... menu.  |

# Chapter 2

## Scope/Meter Mode

### Introduction

The Scope/Meter mode offers you

- a dual-input 40 MHz digital oscilloscope
- two 5,000 counts true-RMS digital multimeters

This Chapter provides a step-by-step introduction to the Scope and Meter measurements. The introduction does not cover all of the capabilities of the test tool but gives basic examples to show how to use the menus perform basic operations.

### Selecting the Scope/Meter Mode

To select the Scope/Meter mode do the following:

① **MENU** Open the application mode menu.

**MENU**

- **SCOPE/METER**
- HARMONICS
- BUSHEALTH
- TRENDPLOT

TRIGGER... SMOOTH... ENTER

② **↑ ↓** Highlight SCOPE/METER

③ **F4** Enter the SCOPE/METER mode.

## Reading the Screen

The screen is divided into three areas: Reading area, Waveform area, and Menu area. Refer to Figure 2-1 during the following.

**Reading area (A):** Displays the numeric readings. If only input A is on, you will see the input A readings only.

**Waveform area (B):** Displays the waveforms. The bottom line displays the ranges/div and the power indicator (line or battery). If only input A is on, you will see the input A waveform only.

### Note

When battery powered, the battery indicator informs you about the condition of the battery from full to empty: .

**Menu area (C):** Displays the menu that provides choices available through the blue function keys.

When you change a setup, a part of the screen is used to display the choices. The area displays one or more menus with choices accessed with the arrow keys:

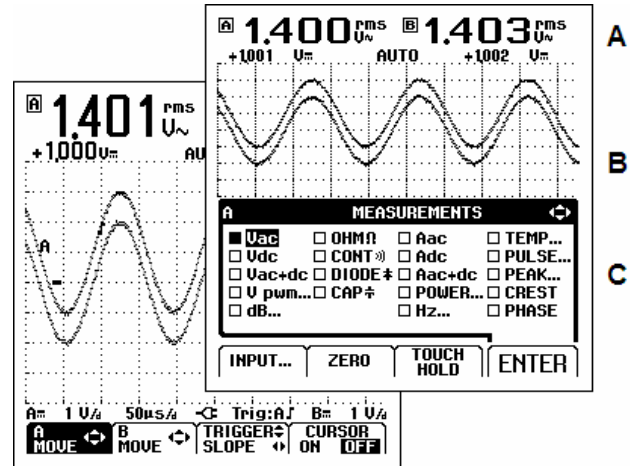

Figure 2-1. The Screen Area's



## Displaying an Unknown Signal with Connect-and-View™ (Auto Set)

The Connect-and-View™ function enables hands-off operation to display complex unknown signals. This function optimizes the position, range, time base, and triggering and assures a stable display on nearly all waveforms. If the signal changes, the setup will track these changes.

To enable the Connect-and-View™ function, do the following:

- Connect the red test lead from red input A to the unknown signal to be measured .

AUTO

Press to select the AUTO (automatic) or the MANUAL mode (toggle function).

In the next example, the screen displays “1.411” in large numbers and “+1.000” in smaller numbers. A scope trace gives a graphical representation of the waveform.

The trace identifier (A) is visible at the left side of the waveform area. The zero icon (⊖) identifies the ground level of the waveform.

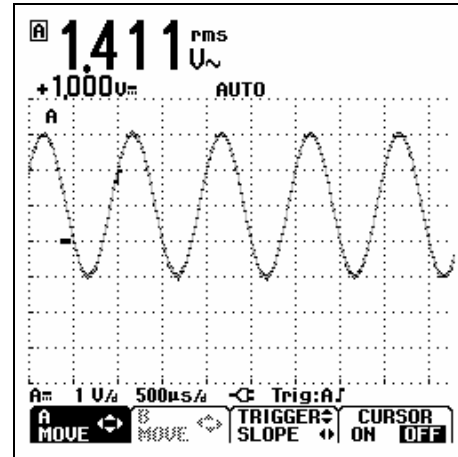

Figure 2-2. Scope Screen After an Auto Set

## **Making Measurements**

The reading area displays the numeric readings of the chosen measurements on the waveform that is applied to the input jack.

### **Connecting the Inputs**

#### **Voltage measurements**

See figure 2-3. For proper grounding connect the short ground leads ② to the same ground potential. You can also use test lead ① for grounding. See also Using Proper Grounding in chapter 9.

#### **Ohm ( $\Omega$ ), continuity, diode, and capacitance measurements**

See figure 2-4. Use the red shielded test lead from input A and the black unshielded ground lead from COM (common).

#### **Current measurements**

See figure 2-5. Select the probe setting that matches the used current clamp and its setting (e.g. 1 mV/A), see Chapter 1, Measurement Probes and Settings.

#### **Temperature measurements**

See figure 2-6. Use a 1 mV/°C temperature transmitter (not available in all countries) to get the correct temperature reading.

#### **Power measurements**

See figure 2-7. Select correct probe settings for voltage measurement on input A, and current measurement on input B.

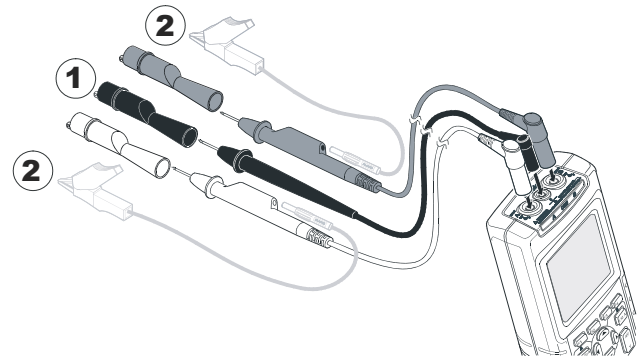

**Figure 2-3. Volts Measurement Setup**

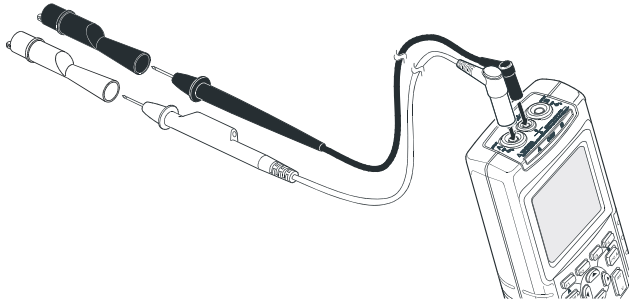

**Figure 2-4. Ohms, Continuity, Diode, Capacitance Measurement Setup**

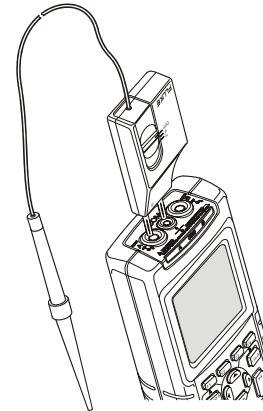

**Figure 2-6. Temperature Measurement Setup**

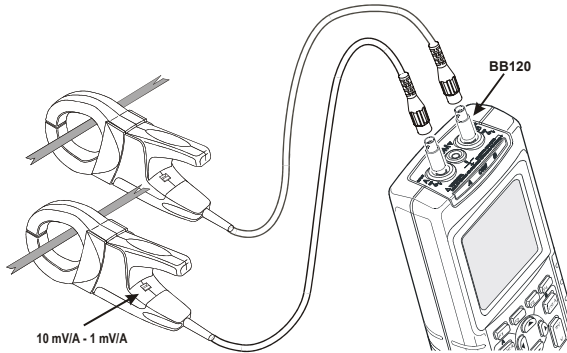

**Figure 2-5. Current Measurement Setup**

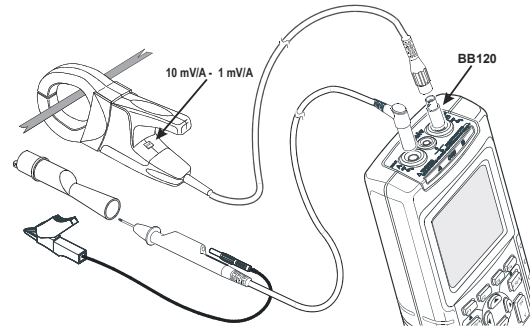



**Figure 2-7. Power Measurement Setup**

### Selecting a measurement function.

To choose a frequency measurement for Input A, do the following:

①  Open the A MEASUREMENTS menu.



②  Highlight Hz....

③  Open the Hz-RPM submenu.

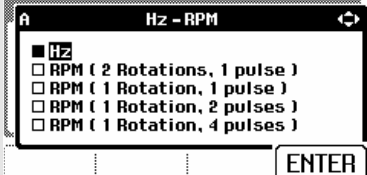

④  Highlight Hz.

⑤  Accept the Hz measurement.

Observe that Hz is now the main reading. The former main reading has now moved to the smaller secondary reading position. (See Figure 2-8.)

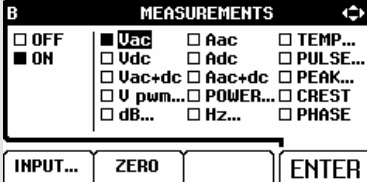

To choose also a Peak-to-Peak measurement for Input B, do the following:

①  Open the B MEASUREMENTS menu.



②  Highlight ON.

③  Turn Input B on. Observe that the highlight jumps to the present main measurement.

- ④  Highlight PEAK...
- ⑤  Open the PEAK submenu.
 



B PEAK

PEAK TYPE:

PEAK MAX

PEAK-PEAK

PEAK MIN

ENTER
- ⑥  Highlight PEAK-PEAK.
- ⑦  Accept the pk-pk measurement.

Now, you will see a screen like Figure 2-8.

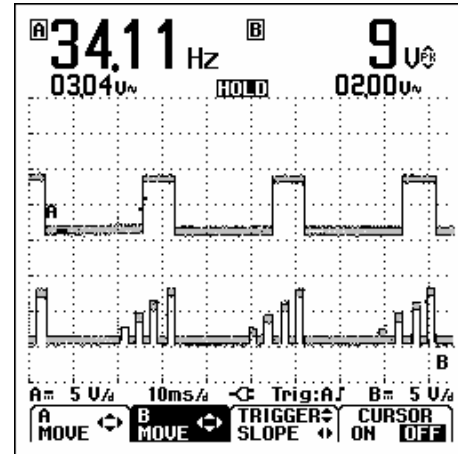



Figure 2-8. Hz and V<sub>pp</sub> as Main Readings

## Freezing the Screen



You can freeze the screen (all readings and waveforms) at any time.

- ①  Freeze the screen. **HOLD** appears at the bottom of the reading area.
- ②  Resume your measurement.

## Holding a Stable Reading



The Touch Hold® mode captures a stable main (large) reading on the display. When a new stable reading is detected, the test tool beeps and displays the new reading.

Use the following procedure for the Touch Hold function:

- ①  Open the INPUT A menu.
- ②  Enter the Touch Hold mode, **THOLD** appears at the bottom of the reading area.
- ③ BEEP))) Wait until an audible beep: now you have a stable reading.
- ④  Turn Touch Hold off and return to normal measurement.

## Making Relative Measurements

Zero Reference displays the present measurement result with respect to the defined value. This feature is useful when you need to monitor the measured value in relation to a known good value.

- |   |   |  |
|---|---|--|
| ① |  | Open the A MEASUREMENTS menu.              |
| ② |  | Activate the relative measurement. (ZERO). |

Note

*In the OHM  $\Omega$  measurement function the F1 ZERO ON OFF soft key enables you to turn relative measurements on and off.*

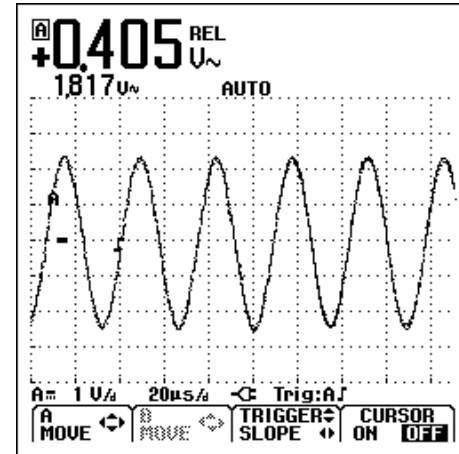



Figure 2-9. Making a Relative Measurement

The relative measurement now becomes the main reading, while the former main measurement has moved to the smaller secondary reading position. (See Figure 2-9.)

Do step1 and step 2 again to de-activate the relative measurement.

## Selecting Auto/Manual Ranges



Press  to automatically adjust the position, range, time base, and triggering (Connect-and-View). This assures a stable display on nearly all waveforms. The bottom line shows the range, the time base for both inputs, and the trigger information. **AUTO** appears at the bottom of the reading area.

Press  a second time to select the manual range. **MANUAL** appears at the bottom of the reading area.

## Changing the Graphic Representation on the Screen



From Auto range, you can use the light-gray rocker keys to change the graphic representation on the screen manually. This will turn off the Connect-and-View function! Observe that **AUTO** at the bottom of the reading area disappears.

### Changing the Amplitude

①		Enlarge the waveform.
②		Reduce the waveform.

Available settings are from 5 mV/div to 500 V/div when using the test leads.

### Changing the Time Base

①		Increase the number of periods.
②		Decrease the number of periods.



Available settings are from 10 ns/div to 5 s/div in normal mode.



### Positioning the Waveform on the Screen

Considerable flexibility is offered in moving the waveform(s) around the screen.

- ①  Press until you have left any open menu. Observe that the following main menu appears on bottom of the screen.
 

A MOVE	B MOVE	TRIGGER SLOPE	CURSOR ON
--------	--------	---------------	-----------
- ②  Choose A MOVE
- ③  Position the waveform of INPUT A on the screen.

Waveform positioning is demonstrated in Figure 2-10.

Observe that the trigger identifier ( $\lrcorner$ ) moves horizontally on the screen.

*Note:*

*For 3 phase power measurements the waveform positions are fixed.*

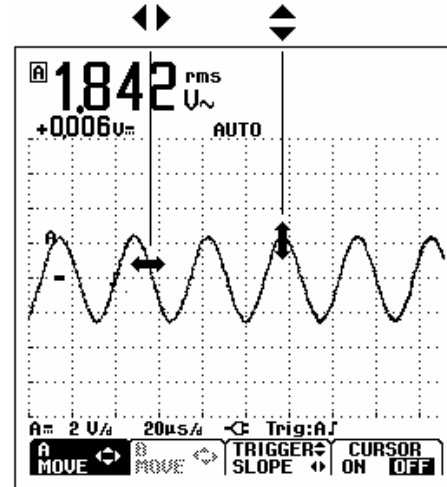









Figure 2-10. Positioning the Waveform

### Smoothing Waveforms and Readings

To smooth the waveform, do the following:

- ①  Open the application menu.
- ②  Open the SMOOTH.. submenu.
 

SMOOTH		
WAVEFORM:	READING A:	READING B:
<input type="checkbox"/> ENVELOPE	<input type="checkbox"/> FAST	<input type="checkbox"/> FAST
<input checked="" type="checkbox"/> NORMAL	<input checked="" type="checkbox"/> NORMAL	<input checked="" type="checkbox"/> NORMAL
<input type="checkbox"/> SMOOTH	<input type="checkbox"/> SMOOTH	<input type="checkbox"/> SMOOTH

TRIGGER...
BACK...
ENTER
- ③   Highlight WAVEFORM: SMOOTH to smooth the input A and input B waveform.
- ④  Accept SMOOTH.
- ⑤   Highlight READING A: FAST NORMAL or SMOOTH.
- ⑥  Accept your choice and repeat ⑤ and ⑥ for reading B.

WAVEFORM SMOOTH suppresses noise without loss of bandwidth. Waveform samples with and without smoothing are shown in Figure 2-11.

READING SMOOTH: long averaging, stable reading  
READING FAST: short averaging, fast response

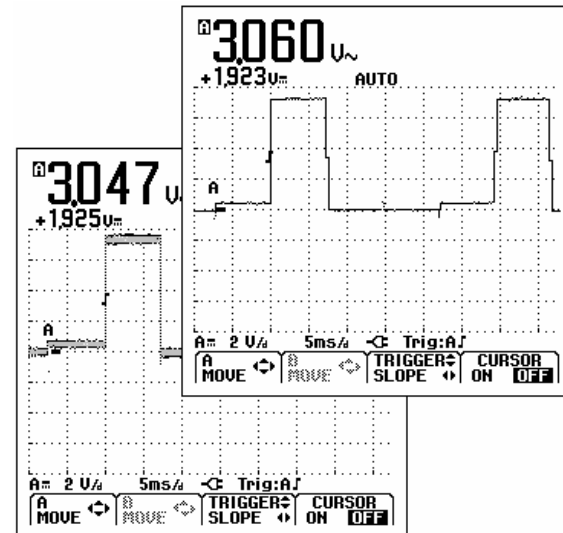





Figure 2-11. Smoothing the Waveform

### Displaying the Envelope of a Waveform

The test tool records the envelope (minimum and maximum) of the live waveforms A and B.

Repeat the first two actions of 'Smoothing the Waveform', and then do the following:

- ③   Highlight ENVELOPE.
- ④  (3x) Start monitoring the envelope of the waveform.

The screen shows the resultant envelope in a gray waveform. See Figure 2-12.

You can use ENVELOPE to observe variations in time or amplitude of input waveforms over a longer period of time.

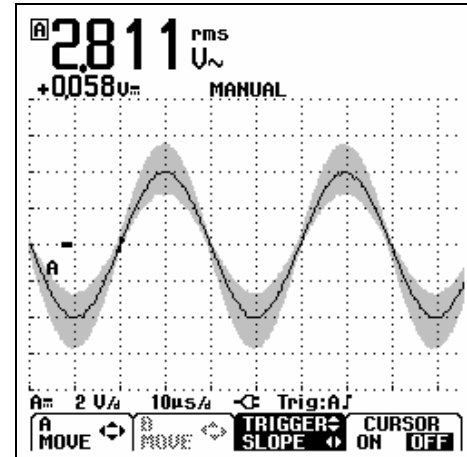

Figure 2-12. Displaying the Envelope of a Waveform











**205 Westwood Ave**  
**Long Branch, NJ 07740**  
**1-877-742-TEST (8378)**  
**Fax: (732) 222-7088**  
**salesteam@Tequipment.NET**

## Acquiring the Waveform

### Making a Single Acquisition

To catch single events, you can perform a single shot. (One time screen update.) To set up the test tool for a single shot on the input A waveform, do the following:

- Connect the probe to the signal to be measured.

①		Open the application menu.
②		Open the TRIGGER... submenu.
		
③		Highlight A.
④		Accept INPUT: A.
⑤		Highlight SINGLE.
⑥	 (2x)	Accept the Single shot setup.

The test tool will now have a screen like Figure 2-13.

**Wait:** appears on bottom of the screen to indicate that the test tool is waiting for a trigger.

**Run:** appears on bottom of the screen when the single acquisition is triggered.

**Hold:** appears on bottom of the screen when the single acquisition has been completed.

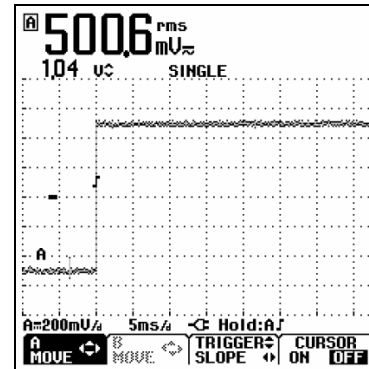









Figure 2-13. Making a Single Acquisition

To perform a next single acquisition, do the following:

⑦		Wait for another single acquisition trigger.
---	---	--

### Recording Slow Signals over a Long Period of Time

The roll mode function supplies a visual log of waveform activity and is especially useful when you measure lower frequency waveforms.

①		Open the application menu..
②		Open the TRIGGER... submenu.
		
③		Highlight A.
④		Accept INPUT: A.
⑤		Highlight ROLL
⑥	 (2x)	Start Recording.

The waveform moves across the screen from right to left like a normal chart recorder. Observe that during recording no measurements are made. (See Figure 2-14.)

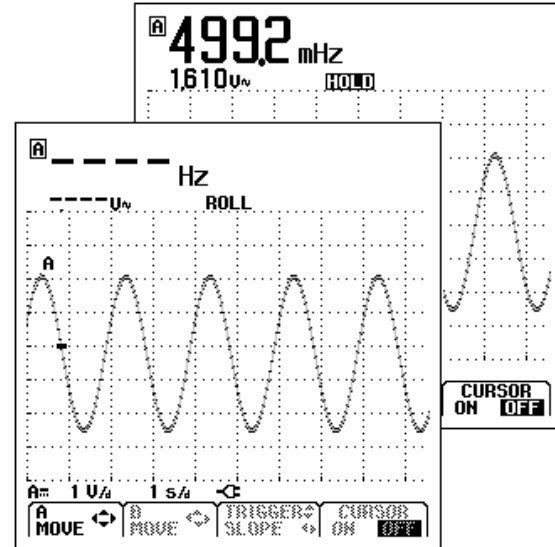



Figure 2-14. Recording Waveforms over Longer Period of Time

⑤		Freeze Recording.
---	--	-------------------

Observe that the measurement values are only displayed after  is pressed. (See figure 2-14.)

## Selecting AC-Coupling

Use AC-coupling when you wish to observe a small AC signal that rides on a DC signal.

To select AC-coupling on input A, do the following:

①		Open the A MEASUREMENTS menu.
②		Open the INPUT menu:
③		Jump to the COUPLING: field
④		Highlight AC.
⑤	(2x)	Accept AC-coupling.

## Reversing the Polarity of the Displayed Waveform

To invert the input A waveform, do the following:

①		Open the A MEASUREMENTS menu.
②		Open the INPUT menu:
③	2x	Jump to the WAVEFORM: field
④		Highlight INVERT.
⑤		Accept inverted waveform display.

For example, a negative-going waveform is displayed as positive-going, providing a more meaningful viewing perspective in some cases. An inverted display is identified by trace identifier **A** on left of the waveform area.

## Triggering on a Waveform

Triggering tells the test tool when to begin displaying the waveform. You can select which input signal should be used, on which edge this should occur, and you can define the condition for a new update of the waveform. You can setup the test tool to trigger on video signals.

The bottom line of the waveform area identifies the trigger parameters being used. Trigger icons on the screen indicate the trigger level and slope. (See Figure 2-15.)

*Note:*

*For 3 phase power measurements the trigger settings are fixed.*

## Setting Trigger Level and Slope

For quick operation, use the AUTO SET key to automatically trigger on nearly all signals.



①  Perform an AUTO SET.

To optimize trigger level and slope manually, do the following:

①  Press until you have left any open menu.



②  Enable the arrow keys for Trigger Level and Slope adjustment.

③  Adjust the Trigger Level continuously. Observe the trigger icon  on the second time division line indicates the trigger level.

④  Trigger on either positive Slope or negative Slope of the chosen waveform.

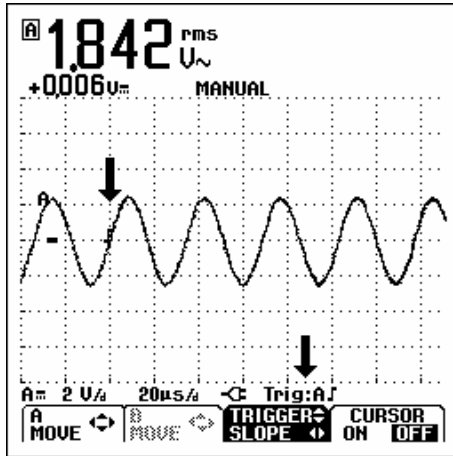



Figure 2-15. Screen with all Trigger Information





### Selecting the Trigger Parameters

To trigger on the input A waveform, with automatic screen update, and to configure the auto range triggering for waveforms down to 1 Hz, do the following:

- ①  Open the applications menu.
- ②  Open the TRIGGER submenu
 

**TRIGGER**

<b>INPUT:</b> <input checked="" type="checkbox"/> A <input type="checkbox"/> B <input type="checkbox"/> EXT <input type="checkbox"/> VIDEO on A...	<b>UPDATE:</b> <input checked="" type="checkbox"/> FREE RUN <input type="checkbox"/> ON TRIG. <input type="checkbox"/> SINGLE <input type="checkbox"/> ROLL	<b>AUTO RANGE:</b> <input checked="" type="checkbox"/> >15Hz <input type="checkbox"/> >1Hz
--	---	--

BACK...
SMOOTH...
ENTER
- ③  Highlight INPUT: A.
- ④  Select INPUT: A.
- ⑤  Highlight FREE RUN.
- ⑥  Select FREE RUN.
- ⑦  Highlight >1 Hz



⑧ F4 Accept all trigger selections and return to normal measurement.

*Note*

*Setting the automatic triggering to >1Hz will slow down the auto range.*

**TRIG:A** appears in gray text on bottom of the screen when no trigger is found.

*Note*

*Gray text in a menu or button bar indicates that the function is disabled or the status is not valid.*

**FREE RUN:** the test tool automatically updates the trace even if there are no triggers.

**ON TRIG.:** the screen is updated only when valid triggers occur.

### Isolated Triggering

Use the optically isolated trigger probe (ITP120, optional) to trigger on an external source, and to isolate the test tool from a trigger waveform. See Figure 2-16.

To choose the isolated trigger probe, select 'EXT' in point ③ of the previous example. Trigger level is fixed and is TTL compatible.

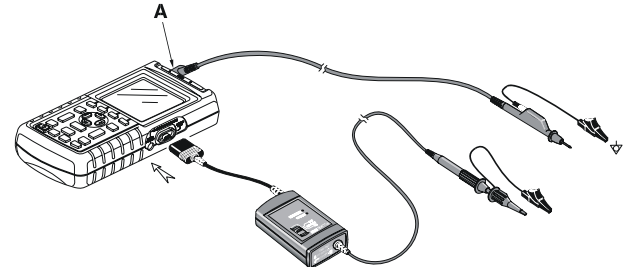



**Figure 2-16. Isolated Triggering**

### Triggering on Video Signals

- Apply an interlaced video signal to the red input A.

To trigger on a random video line, continue from point ② of the previous example as follows:

③  Highlight VIDEO on A....

④  Open the VIDEO TRIGGER submenu.

**VIDEO TRIGGER**

SYSTEM:	LINE:	POLARITY
<input checked="" type="checkbox"/> PAL	<input type="checkbox"/> RANDOM	<input checked="" type="checkbox"/> POSITIVE
<input type="checkbox"/> NTSC	<input checked="" type="checkbox"/> SELECT	<input type="checkbox"/> NEGATIVE
<input type="checkbox"/> PALplus		
<input type="checkbox"/> SECAM		





⑤  Highlight PAL.

⑥  Select PAL.

⑦  Highlight RANDOM.

⑧  Select RANDOM.

⑨  Highlight POSITIVE.

⑩  Accept the video trigger selections .

Trigger level and slope are now fixed. (See Figure 2-17.) Positive video is indicated as a “+” icon on bottom of the screen.

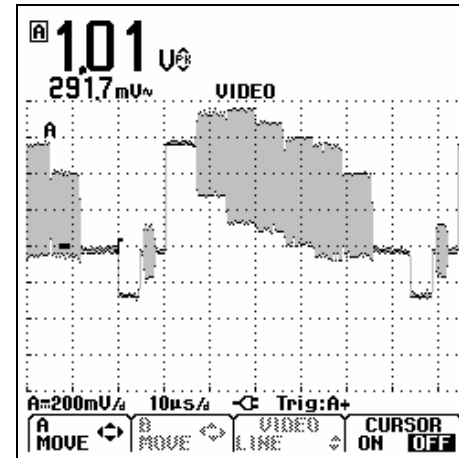
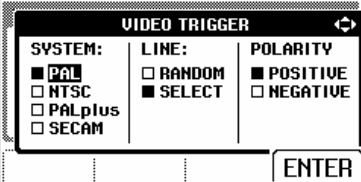



**Figure 2-17. Measuring Video Signals**

### Triggering on a Specific Video Line

To view a specific video line in more detail you can select the line number. To measure on a selected video line, continue from point ⑥ of the previous example as follows:

⑦  Highlight SELECT





⑧  Select SELECT

⑨  Highlight POSITIVE.

⑩  Accept the video trigger selections .

To choose line 135, do the following:

①  Enable video line selection.









②  Select number 135.

## Making Cursor Measurements

Cursors allow you to make precise digital measurements on waveforms. For 3 phase power measurements cursors are disabled.

### Using Horizontal Cursors on a Waveform

To use the cursors for a voltage measurement, do the following:

- ①  From Scope/Meter mode, display the Cursor Key functions:  

- ②  Press to highlight . Observe that two horizontal cursor lines are displayed.
- ③  Highlight the upper cursor.
- ④  Move the upper cursor to the desired position on the screen.
- ⑤  Highlight the lower cursor.
- ⑥  Move the lower cursor to the desired position on the screen.

### Note

Even when the key labels are not displayed at the bottom of the screen, you can still use the arrow keys.

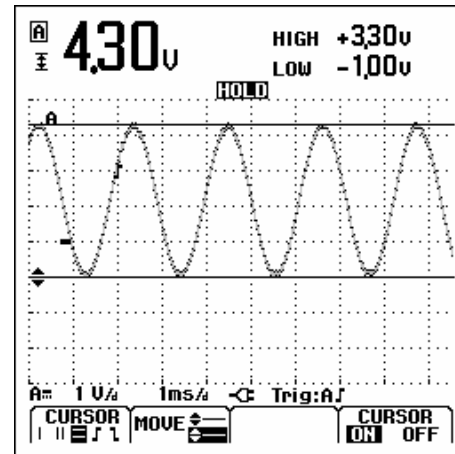

Figure 2-18. Voltage Measurement with Cursors

The readout shows the voltage difference between the two cursors and the voltages at the cursors in relation to the zero icon (-). (See Figure 2-18).

Use horizontal cursors to measure the amplitude, high and low value, or overshoot of a waveform.

### Using Vertical Cursors on a Waveform

To use the cursors for a time measurement, do the following:

- ① F4 From Scope mode, display the Cursor Key functions.

CURSOR | | MOVE ↑ ↓ TRACE B CURSOR ON OFF
- ② F1 Press to highlight |. Observe that two vertical cursors are displayed. Markers (-) identify the point where the cursors cross the waveform.
- ③ F3 If necessary, choose the trace A or B.
- ④ F2 Highlight the left cursor.
- ⑤ ◀▶ Move the left cursor to the desired position on the waveform.
- ⑥ F2 Highlight the right cursor.
- ⑦ ◀▶ Move the right cursor to the desired position on the waveform.

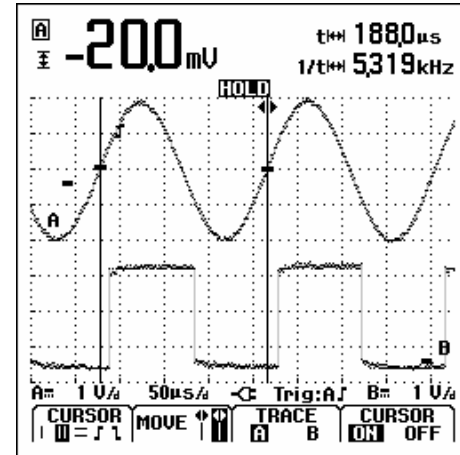

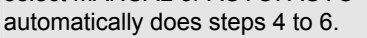

**Figure 2-19. Time Measurement with Cursors**

The readout shows the time difference 't' between the cursors and the voltage difference between the two markers (See Figure 2-19).

The signal frequency is displayed behind 1/t if exactly 1 signal period is between the cursors.

## Making Rise Time Measurements

To measure rise time, do the following:

- ① **F4** From Scope mode, display the Cursor Key functions.  
The menu shows: CURSOR | II = F1 | MOVE | AUTO | MANUAL | CURSOR | ON | OFF
- ② **F1** Press to highlight **RT** (rise time). Observe that two horizontal cursors are displayed.
- ③ **F3** If only one trace is displayed, select MANUAL or AUTO. AUTO automatically does steps 4 to 6. For multiple traces select the required trace A or B.  
The menu shows: CURSOR | II = F1 | MOVE | AUTO | MANUAL | CURSOR | ON | OFF
- ④  Move the upper cursor to 100% of the trace height. A marker is shown at 90%.
- ⑤ **F2** Highlight the other cursor.
- ⑥  Move the lower cursor to 0% of the trace height. A marker is shown at 10%.

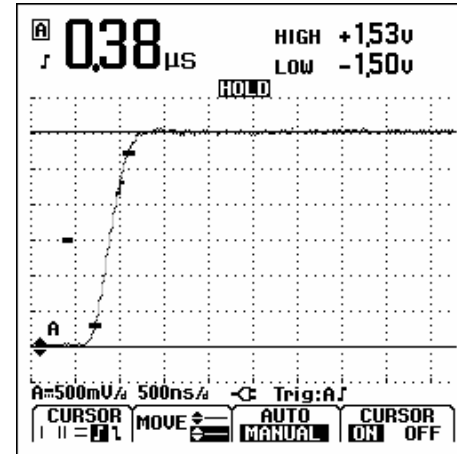

Figure 2-20. Risetime Measurement with Cursors

The reading now shows the risetime from 10%-90% of the trace amplitude and the voltage at the cursors in relation to the zero icon (-). See Figure 2-20.

- ⑦ **F4** Turn off the cursors.



## Using the 10:1 Probe for High Frequency Measurements.



The test tool is supplied with a model VP40 10:1 Probe. Use of this Probe is recommended when you measure high frequency signals in circuits with a high impedance. The loading of the circuit by a 10:1 Probe is much lower than that of a 1:1 Shielded Test Lead.

Probe attenuation and probe adjustment must be observed when using a 10:1 Probe.

### Probe Attenuation.

The Probe attenuates the signal 10 times. Proceed as follows to adapt the Test Tool's voltage readout to this attenuation. The example below is for a Probe connected to input A:

①		The Input A MEASUREMENTS menu and a F1....F4 button bar pops up.
②		Open the INPUT... menu
③		Highlight PROBE: SELECT...

④		Open the PROBE on A menu
⑤		Highlight 10:1 V
⑥		Accept the probe type. The menu will be closed.

Observe that the 10 times attenuation of the Probe is compensated in the voltage readout.

### Probe Adjustment.

The Probe of model VP40 such as supplied with the Test Tool is always adapted correctly to its inputs: high frequency adjustment is not necessary. Other 10:1 Probes however must be adjusted for optimal High Frequency performance. How to adjust these Probes is explained in Chapter 8 under 'Using and Adjusting 10:1 Scope Probes'.





# Chapter 3

## Harmonics

### Introduction

In the Harmonics function the test tool measures harmonics to the 33<sup>rd</sup> (for 400 Hz up to 25<sup>th</sup>). Related data such as DC components., THD (Total Harmonic Distortion), and K-factor are measured.

Harmonics are periodic distortions of voltage, current, or power sinewaves. A waveform can be considered as a combination of various sinewaves with different frequencies and magnitudes. The contribution of each of these components to the full signal is measured.

Harmonics power distribution systems are often caused by non-linear loads such as switched mode DC power supplies in computers, TV's and adjustable speed motor drives. Harmonics can cause transformers, conductors, and motors to overheat.

### Measuring Harmonics

You can display harmonics of:

- Voltage measurements on Input A
- Current measurements on Input B
- Power measurements calculated from Voltage measurements on Input A and Current measurements on Input B.

In the Harmonics mode the test tool always uses the AUTO mode. The vertical sensitivity range and the time base range are automatically adjusted to the most suitable range for the applied input signal. The ranging keys (**mV V** and **s TIME ns**) and the **AUTO** key are locked.

Input A is forced to measure voltage, input B is forced to measure current.

## Performing Harmonics Measurements

To perform harmonics measurements do the following:

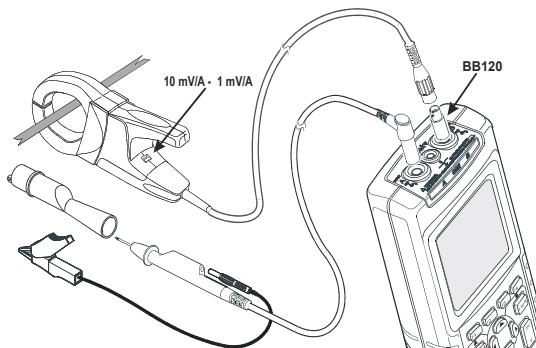

- 1 Connect the inputs as indicated in figure 3-1

Connect input A for VOLT and for WATT, connect input B for AMP and for WATT.

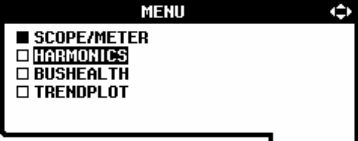

**Figure 3-1. Input Connections for Harmonics**

- 2  Open the application mode menu.  

The screenshot shows the 'MENU' screen with the following options:  SCOPE/METER,  HARMONICS,  BUSHEALTH, and  TRENDPLOT. Below the menu are buttons for TRIGGER..., SMOOTH..., and ENTER.
- 3  Highlight HARMONICS
- 4  Accept your choice. You will see a screen like figure 3-2

If input A was already set to V, and input B was already set to AMP, the actual probe settings will be used. If not, a PROBE menu will be shown to enable you to select the appropriate probe setting.

To change the probe settings if the PROBE menu is not automatically opened see Measurement Probes & Settings in chapter 1 .

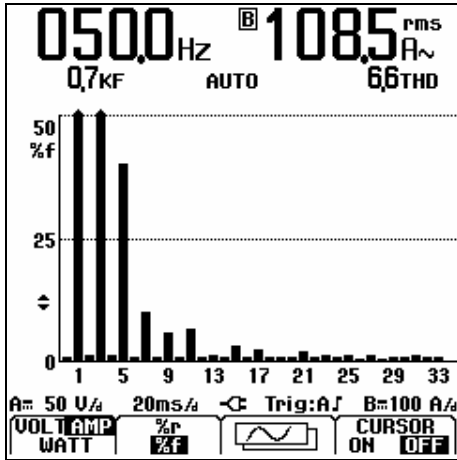

Figure 3-2. Harmonics Screen

- ⑤ F1 Show the input A voltage (VOLT), input B current (AMP), or power (WATT) harmonics.

- ⑥ F2 Select %f to display harmonics bars as a percentage of the fundamental signal.

Select %r to display harmonics bars as a percentage of the total rms signal

- ⑦ F3 Show the waveform screen.

Show the bars screen.

For the waveform screen use the F1 key to display the voltage (input A), the current (input B), or both waveforms.

If the waveform screen is shown, the arrow keys key are locked.

- ⑧ F4 Set cursor measurements ON or OFF, see Using Cursors below.

### **Zooming Harmonics**

If the harmonics bars screen is displayed you can zoom vertically for a more detailed view.

①  Press to vertically zoom in or out.

Observe the top of the long bars in figure 3-2. The arrow shape indicates that the harmonics are zoomed in. The scale at the left side changes when zooming in or out.

### **Using Cursors**

Cursors allow you to make precise digital measurements on harmonics bars.

①  Select CURSOR ON.  
Notice the cursor sign ◀▶ on top of the harmonic bar. The display shows the readings of the marked bar.

②  Move the cursor to select another harmonics bar.

*Note:*

*In the harmonics waveform mode cursor measurements are disabled.*

### Reading the Harmonics Screen

Depending on the test tool settings the readings show different measurement units.

Table 3-1 shows the readings for VOLT/AMP/WATT and CURSOR OFF .

Table 3-2 shows the readings for VOLT/AMP/WATT and CURSOR ON .

**Table 3-1. Harmonics Readings cursor OFF**

Mode	Main A	Secondary A	Main B	Secondary B
Volt	V rms	THD	Hz	
Amp	Hz	K-Factor	A rms	THD
Watt	W rms	THD	Hz	K-Factor

**Table 3-2. Harmonics Readings Cursor ON**

Mode	Main A	Secondary A	Main B	Secondary B
Volt	V	Relative value (%r or %f)	Hz	Angle (°)
Amp	Hz	Angle (°)	A	Relative value (%r or %f)
Watt	W rms	Relative value (%r or %f)	Hz	Angle (°)

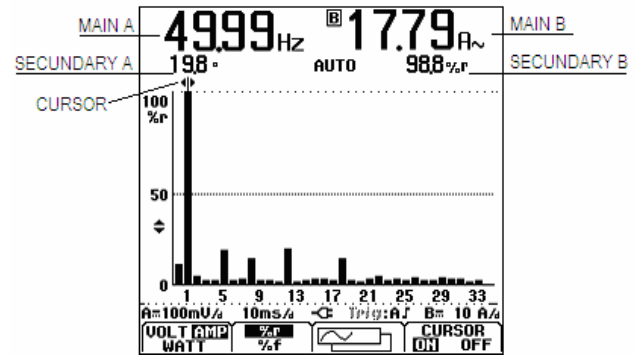

**Figure 3-3. Reading the Harmonics Screen**

**THD** : total harmonic distortion is the amount of harmonics in a signal as a percentage of the total rms value (%r) or as a percentage of the fundamental (%f).

**K-factor** : indicates the losses in transformers due to harmonic currents.

**Relative value** : value of the bar marked by the cursor, %f as a percentage of the fundamental VOLT/AMP/WATT value, %r as a percentage of the total rms VOLT/AMP/WATT value.

**Angle°**: the phase angle between the harmonic component and the fundamental voltage or current.



# Chapter 4

## Field Bus Measurements

### Introduction

Fieldbuses are bi-directional, digital, serial control networks used in process control and industrial automation.

The test tool can indicate the status of the following aspects of the OSI model Physical Layer:

- Voltage levels (bias, high level, low level)
- Bit width – baud rate
- Rise and fall time
- Distortion

Moreover the test tool can show the bus signal waveform in the Eye-pattern mode, see page 4-7.

The test tool operates in full automatic (ranging and triggering) mode. Test limits are preset, but can be changed, see page 4-8.

For supported bus types and protocols see Chapter 10, section Fieldbus Measurements.

For extended information on Fieldbuses and fieldbus measurement please consult Appendix A of this manual.

#### Note

*To check a suspected cable you can perform resistance measurements and capacitance measurements using the Scope/Meter mode.*

## Performing Fieldbus Measurements

To perform fieldbus measurements do the following:

①  Open the application mode menu.



②  Highlight BUSHEALTH.

③  Open the bus selection menu:

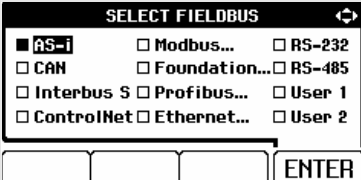

④



Select the bus type.



Select **User 1** or **User 2** if you want to create a customized set of limits to test other (non standard) bus systems. See page 4-8 for setting the limits. Default settings are ControlNet for User1 and Foundation Fieldbus H1 for User2.

⑤



Accept your choice.

For bus types followed by 3 dots ... a new menu will open:

Use  to select the required item and press .

You will see a screen like fig 4.2.

⑥



Select the appropriate input A and input B test leads or probe type.

⑦

Connect the inputs as indicated in figure 4-1.

Use the test tool inputs as shown in table 4-1.



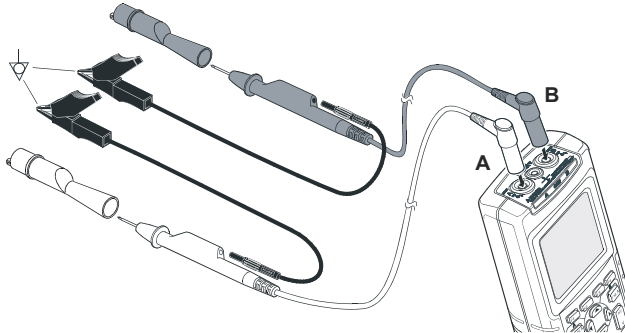

**Figure 4-1. Fieldbus Measurement Input Connections**

*Note*

*Use the BB120 Banana-to-BNC Adapter to connect a BNC cable for bus measurements.*

*You can use the optional BHT190 Bushealth Test adapter to connect the probe tip in an easy way to busses that use a DB9, RJ-45 or a M12 connector.*

**Table 4-1. Bus Measurement Inputs**

Bus	Subtype	Input		Advised Probe
		A	B	
AS-i		x	-	STL120
CAN		x	x	STL120
Interbus S	RS-422	x	-	VP40
ControlNet		x	-	Coax-BB120
Modbus	RS-232	x	-	STL120
	RS-485	x	x	STL120
Foundation fieldbus	H1	x	-	STL120
Profibus	DP/RS-485	x	x	STL120
	PA/31.25 kBit/s	x	-	STL120
Ethernet	Coax	x	-	Coax-BB120
	Twisted pair	x	-	VP40
RS-232		x	-	STL120
RS-485		x	x	STL120

## Reading the Screen

The bus test screen (see the example in figure 4-2) shows the status of the various signal properties.

Information is represented in four columns:

- A. signal property that is being tested, for example **VHigh**. Rows 1 to 6 show each signal property and corresponding data. See table 4-2 for a description of the signal properties for the various bus types.
- B. status indicator, for example . See table 4-3 for a description of the indicators.
- C. most recent measurement value, for example **3.5**.  
--- indicates that no reading is available
- OL indicates that the signal is out of the measurement range (overload)
- D. used low (**LOW**) and high (**HIGH**) test limits (**LIMIT**), for example **18.5 31.6V**.  
**LIMIT \*** the \* indicates that one or more of the limits are not set to the default value!  
**N/A** indicates that limit does Not Apply to this bus type.

The F1...F4 function key labels are explained in Table 4-4.

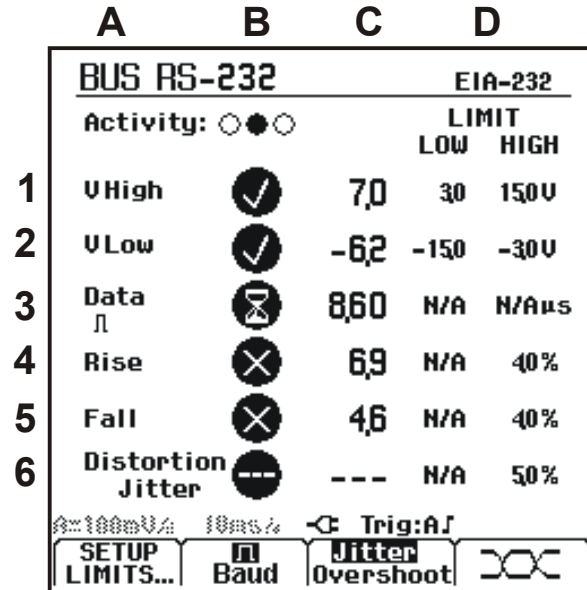

Figure 4-2. Field Bus Test Screen Example

Table 4-2. Tested Signal Properties

Property	Explanation
----------	-------------

	Property	Explanation
1	VBias CAN-Rec. H-L CAN-Rec. H CAN-Rec. L V High Vpk-pk	Bias voltage CAN-recessive high to low level voltage CAN-recessive high level voltage CAN-recessive low level voltage High level voltage Peak to peak voltage
2	V-Level High-Bias V-Level Bias-Low CAN-DOM. H-L CAN-DOM. H CAN-DOM. L V Low V-Level pk-pk V-level high V-level low	High level to bias level voltage Bias level to low level voltage CAN-dominant high to low level voltage CAN-dominant high level voltage CAN-dominant low level voltage Low level voltage Peak to peak voltage High level voltage Low level voltage
3	Data  Data Baud	Bit width Baud rate
4	Rise	Rise time as % of bit width
5	Fall	Fall time as % of bit width
6	Distortion Jitter Distortion Overshoot Distortion Amplitude	Jitter distortion Signal distortion, over- and undershoot Amplitude distortion (AS-i bus)

Table 4-3. Bus Test Screen Indicators













	<b>Activity:</b>  : bus activity indicators.
<sup>1</sup> 	Bus activity indicator 1: ● (filled) : voltage measured ○ (open) : no voltage measured
<sup>2</sup> <sup>3</sup> 	Bus activity indicators 2 and 3: ○ ○ (both open) : no activity * * (blinking) : activity
	Busy, the test tool is measuring/processing data.
	No reading available.
	Test OK. Measurement results are within 80% of allowable range, see figure 4-3.
	Warning. Measurement results are between 80% and 100% of allowable range, see figure 4-3.
	Test failed. Measurement results are out of allowable range, see figure 4-3.

Figure 4-3 shows the bust health indicator boundaries.

Example:





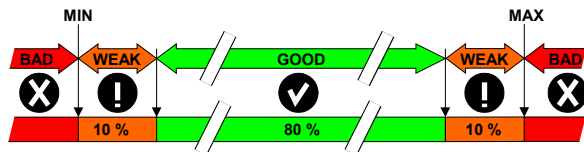







the high level voltage of a bus must be between +3.0 V (MIN) and +15.0 V (MAX). Depending on the measurement result the displayed indicator will be:

-  If the result is between 4.2 and 13.8V. (10% of 12 V = 1.2 V)
-  If the result is between 3 V and 4.2 V, or between 13.8 V and 15 V.
-  If the result is < 3 V or >15 V.



**Figure 4-3. Bus Health Indicator Boundaries**

**Table 4-4. F1...F4 Key Functions**



 	Select the Limit Setup function, see page 4-8.
    	Depending on the bus type select the following to be displayed: High-Bias ( <b>High</b> , default) or Bias-Low ( <b>Low</b> ) voltage. Low level voltage ( <b>L</b> ), high level voltage ( <b>H</b> ), or high to low level voltage ( <b>H-L</b> , default). High-Bias ( <b>High</b> ), Bias-Low ( <b>Low</b> ), or peak-peak voltage ( <b>Pk-Pk</b> , default). Bit width (  ) or baud rate ( <b>Baud</b> )
  	Select the distortion aspect to be tested: jitter ( <b>Jitter</b> ), overshoot and undershoot ( <b>Overshoot</b> ), amplitude distortion ( <b>Amplitude</b> ) for AS-i.
 	Select the Eye-pattern screen mode, see Viewing the Bus Waveform Screen on page 4-7.

## Viewing the Bus Waveform Screen

To view the waveform eye pattern of the bus voltage, do the following:

- ①  In the main screen select eye pattern mode. You will see a screen like figure 4-4.

The screen shows the waveforms of one bit time triggered on a positive as well as on a negative edge in persistence mode.

- ②  Clear the persisted waveforms and restart showing the waveform.
- ③  Return to the test screen.
- ④  Exit the Bushealth mode and enter the Scope/Meter mode.

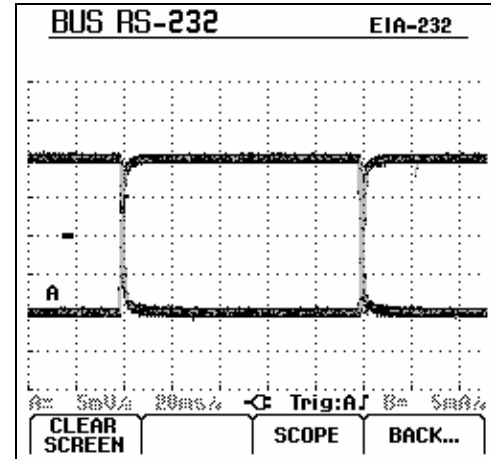







Figure 4-4. Eye Pattern Screen

### Note

Press  to freeze the screen. Pressing  again will clear the persistence waveform and restart showing the waveform eye pattern.

## Setting the Test Limits



You can change the test limits used to generate the messages OK , WARNING , and NOT OK .

The test limits apply to the selected bus type. To change the test limits for another bus type do steps 1-5 on page 4-2 first.

To change the test limits, do the following:

①  From the test screen open the SETUP LIMITS menu. You will see a screen like Figure 4-5. The header shows the bus type.

②  Select the signal property for which you want to set the limit.

③  Select the level to be adjusted: LOW, HIGH or ! WARNING  
Press  to set all limits to the default setting.

④ 

Change the limits.

A \* in the SETUP LIMITS screen indicates that a signal property has limits that differ from the default setting.

Press  N/A if a limit should not be involved in the test.

⑤ 

Accept the limits and return to the test screen.

In the test screen the text **LIMIT** will be followed by a \* if any of the limits is not the default limit.

### Note

*Changed limits will persist until:*

- *you change them again,*
- *you reset the test tool; resetting will restore the default limits.*

The screenshot shows a terminal window titled 'BUS AS-i' with the identifier 'MEN-EN50295'. The main menu is 'SETUP LIMITS' with a right arrow icon. Below the title is a table of parameters. The 'Vbias' parameter is currently selected, with its value '185V' highlighted and flanked by left and right arrows. At the bottom of the screen are four buttons: 'DEFAULTS', 'N/A', 'LOW HIGH WARNING!' (with 'LOW' and 'HIGH' on the top line and 'WARNING!' on the bottom line), and 'ENTER'.

	LOW	HIGH	WARNING!
Vbias	185V	316V	100%
Vhigh-Bias	15V	40V	100%
Vbias-Low	15V	40V	100%
Rate	588µs	612µs	100%
Rise	N/A	N/A	100%
Fall	N/A	N/A	100%
Jitter	N/A	0.4%	100%
Amplitude	N/A	350%	100%

Figure 4-5. Setup Limits Menu Screen

### Saving and Recalling Test Limits

You can save a screen, plus the test setup with (adjusted) test limits, plus the most recent eye pattern trace as a new dataset. By recalling this dataset you can do a bus test according to your own pre-defined test limits.

Refer to chapter 6 ‘Saving and Recalling Datasets’.





# Chapter 5

## Plotting Measurements over Time (TrendPlot™)

### Introduction

The TrendPlot™ function plots a graph derived from the **MAIN** (large) readings in the SCOPE/METER mode or in the HARMONICS mode as a function of time.

The secondary (small) reading shows:

- the average (AVG) reading and the date and time,
- or
- the minimum (MIN) or the maximum (MAX) reading **since the TrendPlot start** and the date and time of the most recent change.

### Starting/Stopping a TrendPlot™

To start a TrendPlot™ do the following:

① **MENU** Open the application mode menu.

**MENU**

- SCOPE/METER
- HARMONICS
- BUSHEALTH
- **TRENDPLOT**

TRIGGER... SMOOTH... ENTER

② **↑ ↓** Highlight TRENDPLOT

③ **F4** Start the TrendPlot. You will see a screen like figure 5-1.

You can restart a TrendPlot by pressing the F2 RESTART key.

④ **F1** Stop the TrendPlot.

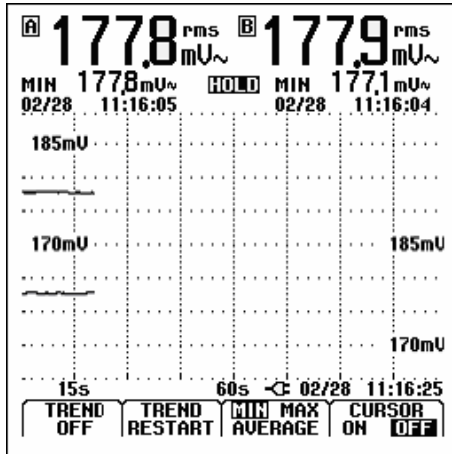

**Figure 5-1. TrendPlot Reading**

The test tool continuously logs all readings to memory and displays these as graphs. If input A and input B are on, the upper graph belongs to input A.



Automatic vertical scaling and horizontal time compression resizes the TrendPlot to fit on the screen. The TrendPlot is built up on the screen from left to right until the screen is full. The automatic time scaling then compresses this information to about half the screen.

*Note*

*When a new minimum or maximum value is detected a beep occurs.*

## Changing the TrendPlot Reading

To toggle the secondary TrendPlot reading between MIN (minimum), MAX (maximum), and AVERAGE, do the following:





- ①  Change MIN into MAX reading.
- ②  Change MAX into AVERAGE (AVG) reading.

Note that the date and time stamp now updates continuously to indicate the most recent change in a reading.

## Making TrendPlot Cursor Measurements

Cursors allow you to make precise digital measurements on the plotted graph(s). The display shows the measurement results and the date and time at the cursor position.

To use cursors do the following

- ①  Stop updating the graph and freeze the screen.
- ②  Select CURSOR ON.
- ③  Select the maximum or minimum plotted reading to be displayed.  
  
From multiple readings during a time slot, the minimum and the maximum main are plotted.
- ④  Move the cursor to the desired position on the graph.

*Note*

To resume updating the graph press  again.



# Chapter 6

## Saving and Recalling Data Sets

### Introduction

This Chapter explains how to save data sets into the test tool's Flash EEPROM memory and how to view, rename and delete them.

The test tool has 20 data memories. In each memory you can save a data set.

A data set consists of the screen data, the waveform data, and the test tool setup.

### Saving Data Sets

To save a data set do the following:

①  Open the SAVE/RECALL mode.



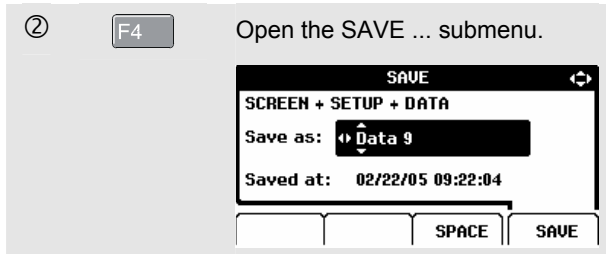

	PRINT SCREEN	RECALL DELETE...	SAVE...
--	-----------------	---------------------	---------

The screen is frozen until you leave the SAVE/RECALL mode again. You can leave the SAVE/RECALL mode by pressing the SAVE/PRINT key again.



The menu shows the default name for the data set to be stored 'Data n'. The n indicates the first free memory location number. You can change the name, or save the data set using the default name.

Continue as follows:

- ③  Select the character you want to change.
- ④  Change the selected character.
-  The SPACE softkey replaces the highlighted character with a space and highlights the next character.
- ⑤  When finished save the data set.

The instrument returns to normal signal acquisition again.

If no free memory locations are available message pops up that proposes to you to overwrite the oldest data set.

Do one of the following:

- ①  Reject the proposal to overwrite the oldest data set, then delete one or more memory locations, and save again.

or

- ①  Overwrite the oldest data set .

## Recalling, Renaming, Deleting Data Sets

To recall a data set, do the following:



①  Open the SAVE/RECALL mode.



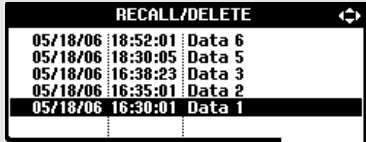

If no data sets are stored  
 RECALL DELETE... is disabled  
 (grey text).

②  Open the RECALL/DELETE menu.



③   Highlight the data set you want to recall, rename, or delete.

④  Press F1 to **delete** the data set

 Press F2 to **rename** the data set; do steps 3...5 of the 'Saving Data Sets procedure.

 Press F4 to **recall** the data set. Observe that the recalled waveform is displayed and that HOLD appears on the screen. From this point you can use cursors for analysis or you can print the recalled screen. The test tool returns to signal acquisition if you press the HOLD/RUN key, using the setting of the recalled data set.

⑤  Go back to the save/print mode.





# **Chapter 7**

## ***Using a Printer and FlukeView***

### ***Introduction***

This Chapter explains how to setup the test tool for communication with :

- a printer to make a hardcopy of the test tool screen
- a PC or laptop to use the FlukeView software.

### ***Using a Printer***

To print a (graphic) hard copy of the present screen, you need to use one of the following:

- The Optically Isolated RS-232 Adapter/Cable (PM9080, optional) to connect a serial printer to the OPTICAL PORT of the test tool. See Figure 7-1.
- The Print Adapter Cable (PAC91, optional) to connect a parallel printer to the OPTICAL PORT of the test tool. See Figure 7-2.

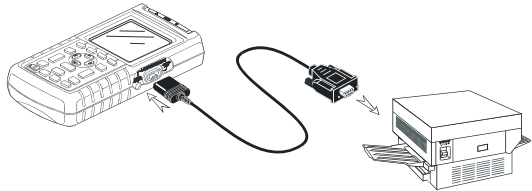

Figure 7-1. Connecting a Serial Printer

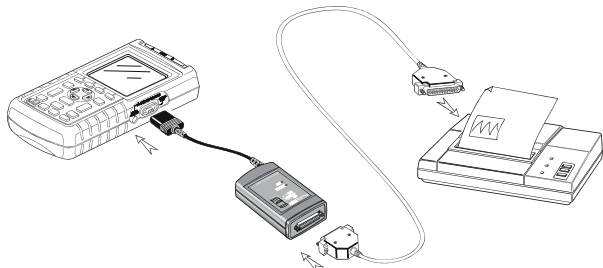



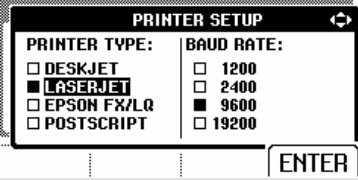







Figure 7-2. Connecting a Parallel Printer

This example covers how to set up the test tool to print on a HP Deskjet printer with a baud rate of 9600 baud:

①		Open the USER OPTIONS menu.
②		Highlight PRINTER SETUP...
		Open the PRINTER SETUP submenu.
		
③		Highlight DESKJET.
④		Select DESKJET.
⑤		Highlight 9600.
⑥		Accept the print selections.

Now you are ready to print.

To print a screen, do the following:

⑦		Open the SAVE&PRINT menu. Observe that the screen is frozen.
⑧		Start printing.

A message that indicates that the test tool is printing appears on bottom of the screen.

*Note:*

*Printers must be compatible with HP PCL or EPSON protocol.*

## Using FlukeView® Software

To connect the test tool to a computer for using the FlukeView software for Windows® (SW90W), do the following:

- Use the Optically Isolated RS-232/USB Adapter/Cable (OC4USB) to connect a computer to the OPTICAL PORT of the test tool. See Figure 7-3.

For all information relating to installing and using the FlukeView ScopeMeter software, see the SW90W Users Manual.

A Software & Cable Carrying Case Kit is optional available as model number SCC 120.

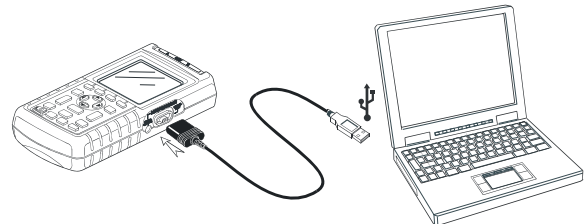

**Figure 7-3. Connecting a Computer**



# **Chapter 8**

## ***Maintaining the Test Tool***

### ***Introduction***

This chapter covers basic maintenance procedures that can be performed by the user. For complete service, disassembly, repair, and calibration information, see the Service Manual. You will find the part number of the Service Manual in the section 'Parts and Accessories' in this manual.

### ***Cleaning the Test Tool***







Clean the test tool with a damp cloth and a mild soap to avoid abrasion of text on the test tool. Do not use abrasives, solvents, or alcohol.

### ***Storing the Test Tool***

If you are storing the test tool for an extended period of time, charge the rechargeable battery pack before storing. It is not necessary to remove the battery pack.

## Charging the Rechargeable Battery Pack

At delivery, the batteries may be empty and must be charged to fill them completely. Charging time is 7 hours (test tool is off). When fully charged, the batteries typically provide 6 hours of use at full brightness. Operating time is extended at normal brightness.

When battery powered, the battery indicator on the bottom of the screen informs you about the condition of the battery. The battery symbols are:      . The battery symbol  indicates that there are typically five minutes of operating time left.

Use the setup as shown in Figure 8-1 to charge the battery pack and power the instrument.

Turn the test tool off to charge the batteries more quickly.

### Note

*The test tool uses a trickle charge for the batteries, so no damage can occur if you leave it charging for long periods, e.g., through the weekend.*

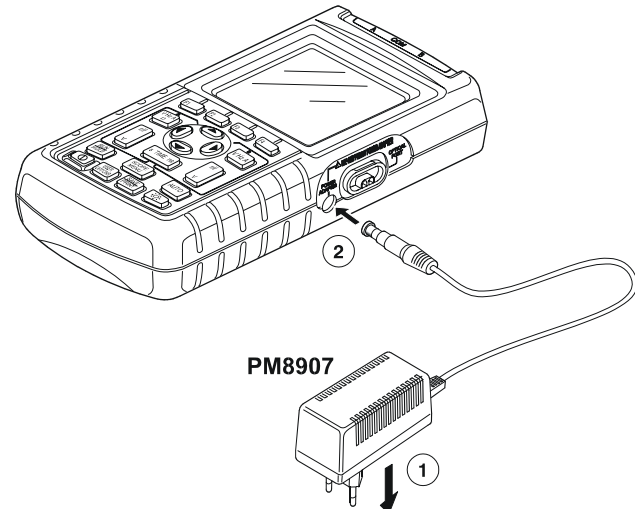

**Figure 8-1. Charging the Battery Pack**

## Keeping Batteries in Optimal Condition

Always operate the test tool on batteries until an -icon appears on the bottom line of the screen. This indicates that the battery level is low and that the batteries need to be recharged.

Frequent charging of the batteries when they are not completely empty can reduce the operating time for the test tool.





You can refresh the battery pack at any time. This battery refresh cycle fully discharges and charges the battery pack. A complete refresh cycle takes about 20 hours and should be done at least four times a year.

*Note*

*Be sure not to disconnect the Power Adapter during the complete refresh cycle. Doing so will interrupt the refresh cycle.*

To refresh the battery pack, do the following:

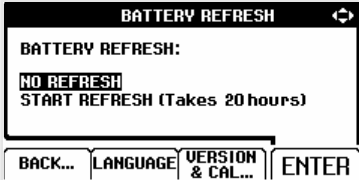
- Be sure that the test tool is line powered.

①		Open the USER OPTIONS menu.
②		Open the BATTERY REFRESH submenu.
		
③		Highlight START REFRESH.
④		Start the refresh cycle.

*Note*

*After start of the refresh cycle, the screen will be black. The backlight is on during discharging within the refresh cycle.*

## Replacing and Disposing of the Rechargeable Battery Pack

### Warning

To avoid electrical shock, remove the test leads and probes before replacing the battery pack.



*This instrument contains Ni-MH batteries. Do not dispose of this battery pack with other solid waste. Used batteries should be disposed of by a qualified recycler or hazardous materials handler. Contact your authorized FLUKE Service Center for recycling information.*

To replace the battery pack, do the following: (See Figure 8-2.)

1. Disconnect the test leads and probes both at the source and at the test tool.
2. Disconnect the Power Adapter.
3. Locate the battery access cover on the bottom rear. Loosen the screw with a flat-blade screwdriver.

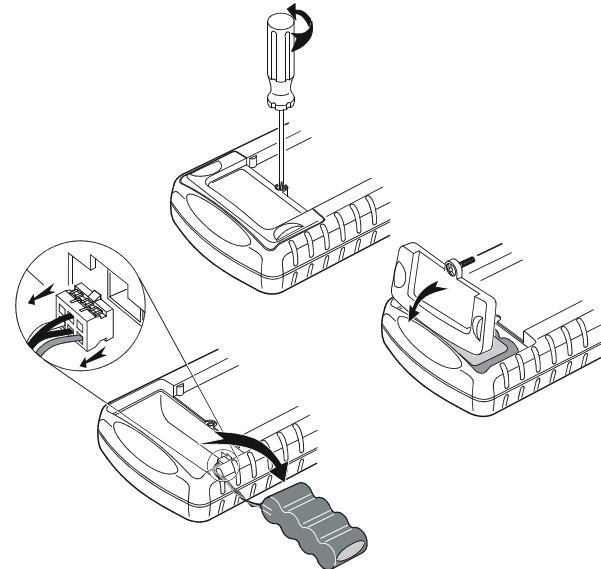

**Figure 8-2. Replacing the Battery Pack**

4. Lift the battery access cover away from the test tool.
5. Take the battery pack out of the battery compartment.
6. Remove the battery plug from the connector.
7. Install a new battery pack.



*Note*

*Ensure that the battery pack is placed in the battery compartment as shown in Figure 8-2.*

8. Reinstall the battery cover and secure the screw.

### Using and Adjusting 10:1 Scope Probes

*Note*

*The 10:1 voltage probe VPS40 that is supplied with Fluke 125 is always adjusted correctly to the Test Tool and needs no further adjustment.*

You need to adjust other 10:1 scope probes for optimal response.

**⚠ Warning**

**To avoid electrical shock use the BB120 Banana-to-BNC adapter (delivered with the test tool) to connect a 10:1 scope probe to the input of the test tool.**

To adjust probes, do the following:

- Connect the 10:1 scope probe from the gray input B jack to the red input A jack. Use the red 4-mm banana adapter (delivered with the probe) and the banana-to-BNC adapter (BB120). See Figure 8-3.

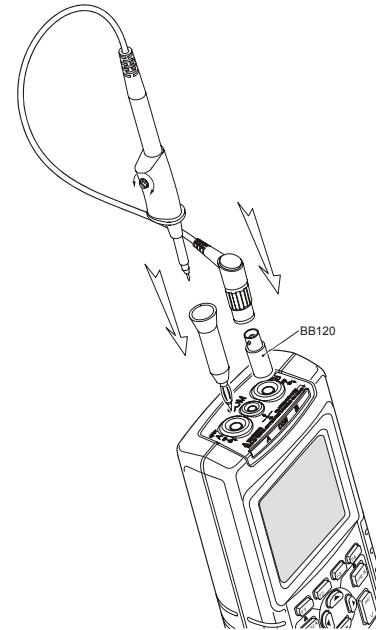







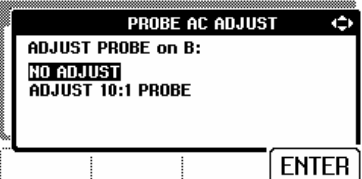

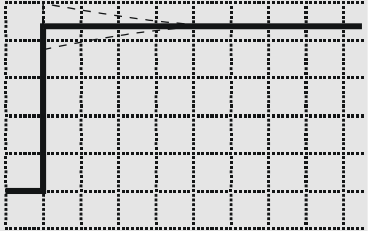





Figure 8-3. Adjusting Scope Probes

- ①  Open the application mode menu.
- ②  Highlight SCOPE/METER
- ③  Enter the SCOPE/METER mode.
- ④  (A) Open the Input A or the Input B MEASUREMENTS menu. The F1....F4 button bar pops up.  
 (B)
- ⑤  Open the INPUT... menu
- ⑥  Highlight AC ADJUST...
- ⑦  Open the PROBE AC ADJUST submenu.  

- ⑧  Highlight ADJUST 10:1 PROBE.

- ⑨  A square wave appears on the screen.  
Adjust the trimmer screw in the probe housing to give an optimum square wave.  

- ⑩  Return to normal mode.

## Calibration Information

You can ask for the model identity (version and calibration data) at any time. To display the identity, do the following:

- ①  Open the USER OPTIONS menu.
- ②  Open the VERSION&CALIBRATION submenu.  

The screen gives you information about the model number with software version, the calibration number with latest calibration date, and the latest battery refresh date.

- ③  Return to normal mode.

Recalibration must be carried out by qualified personnel only. Contact your local Fluke representative for recalibration.

Note:

*The test tool specifications are based on a one year calibration cycle.*

## Parts and Accessories





### Service Manual

A service manual can downloaded from Fluke's website [www.fluke.com](http://www.fluke.com)



### Standard Accessories

The next tables list the user-replaceable parts for the various test tool models. To order replacement parts, contact your nearest service center.

Standard Accessories (cont)

Item	Ordering Code
Ni-MH Battery Pack	BP120MH
Power Adapter/Battery Charger, available models: Universal Europe 230V, 50Hz North America 120V, 60Hz  United Kingdom 240V, 50Hz Japan 100V, 60Hz Australia 240V, 50Hz Universal 115V/230V *  <i>* UL listing applies to PM8907/808 with UL listed line plug adapter for North America. The 230 V rating of the PM8907/808 is not for use in North America. For other countries, a line plug adapter complying with the applicable National Requirements must be used.</i>	PM8907/801 PM8907/813 PM8907/804 PM8907/806 PM8907/807 PM8907/808
Set of two Shielded Test Leads (Red and Gray), designed for use only with the Fluke ScopeMeter 120 series test tool.  Set contains the following replaceable part: Ground Lead with Alligator Clip (Black)	STL120  5322 320 11354
One 10:1 Scope Probe VP40 	VPS40 (is VP40 probe including hook clip and ground lead)
AC Current Clamp 40 A/400 A	i400s

Standard Accessories (cont)

Item	Ordering Code
Test Lead for Grounding (Black) 	TL75 (red + black lead)
Set of three Alligator Clips (Red, Gray, and Black)	AC120
Banana-to-BNC Adapter (Black). 	BB120 (set of two)
<i>Note: manuals can be downloaded from Fluke's website <a href="http://www.fluke.com">www.fluke.com</a></i>	

**Optional Accessories**

Item	Ordering Code
Software & Cable Carrying Case Kit (Supplied with Fluke 125/S) Set contains the following parts: Optically Isolated RS-232/USB Adapter/Cable Hard Carrying Case. Supplied with Fluke 125/S FlukeView <sup>®</sup> ScopeMeter <sup>®</sup> Software for Windows <sup>®</sup>	SCC 120  OC4USB C120 SW90W
Set of two Hook Clips (Red and Gray) 	HC120
Optically Isolated RS-232 Adapter/Cable.	PM9080
Hard Carrying Case.	C120
Compact Soft Case	C125
Isolated Trigger Probe	ITP120
Print Adapter Cable for Parallel Printers	PAC91
Bushealth Test adapter to connect the probe tip in an easy way to busses that use a DB9, RJ-45 or a M12 connector	BHT190

## Chapter 9 Tips and Troubleshooting

### **Introduction**

This Chapter gives you information and tips on how you can make the best use of the test tool.

### **Using the Tilt Stand**

The test tool is equipped with a tilt stand, allowing viewing from an angle. You can also use the tilt stand to hang the test tool at a convenient viewing position. Simply tilt the stand and hang the test tool. Typical positions are shown in Figure 9-1.

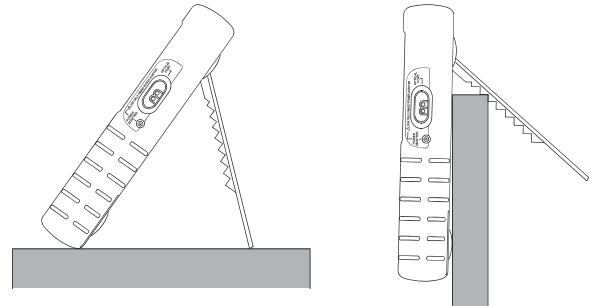





**Figure 9-1. Using the Tilt Stand**

## Changing the Information Language

When you operate the test tool, messages appear on the screen. These messages are always displayed in a box, and can be displayed in various languages.



If you want to change the language of the messages into e.g. Italian, do the following:



-  Open the USER OPTIONS menu.
-  Open the LANGUAGE SELECT submenu.  

The LANGUAGE SELECT menu shows the following options: ENGLISH, PORTUGUÉS, 中文, FRANÇAIS, ITALIANO, 日本語, DEUTSCH, **NEDERLANDS**, 한국어, and ESPAÑOL. The bottom of the menu has buttons for BATTERY REFRESH..., BACK..., VERSION & CAL..., and ENTER.
-  Highlight ITALIANO (Italian).
-  Accept ITALIANO as language.

## Setting the Grid Display

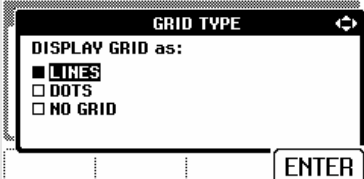
To choose a dotted grid, do the following:

-  Open the USER OPTIONS menu.
-  Highlight GRID TYPE.
-  Open the GRID TYPE submenu.  



The GRID TYPE submenu shows the following options: DISPLAY GRID as: **LINES**, DOTS, and NO GRID. An ENTER button is at the bottom right.
-  Choose DOTS.
-  Accept the new grid display.

Use LINES when you need a cross hatch pattern based on the horizontal time and vertical divisions on the screen. Use DOTS when you need vertical and horizontal division dots as added reference points to the screen.





## Changing Date and Time

The test tool has a date and time clock. To change the date to (e.g.) 20 June, 2007, do the following:

①  Open USER OPTIONS menu.



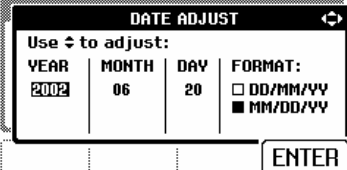

②  Highlight DATE ADJUST.

③  Open DATE ADJUST submenu.





④  Choose 2007.

⑤  Jump to MONTH.

⑥  Choose 06.

⑦  Jump to DAY.

⑧  Choose 20.

⑨  Jump to FORMAT.

⑩  Choose DD/MM/YY.

⑪  Accept the new date.

You can change the time in a similar way by opening the TIME ADJUST submenu. (steps ② and ③.)

## **Saving Battery Life**

When operated on the battery pack (no Power Adapter connected), the test tool conserves power by shutting itself down. If you have not pressed a key for at least 30 minutes, the test tool turns itself off automatically.



### *Note*



*If the Power Adapter is connected, there is no automatic power shutdown.*

Although automatic power shutdown will not occur if TrendPlot is on, the backlight will dim. Recording will continue until the battery pack is low. The remaining battery capacity ensures that the recorded data will not be lost.

## **Setting the Power Down Timer**

The power shutdown time is set to 30 minutes after the last key press. To set the power shutdown to five minutes, do the following:

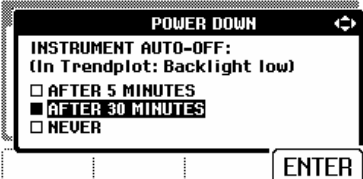
- ①  Open the USER OPTIONS menu.
- ②  Highlight POWER DOWN ...

- ③  Open the submenu.  

- ④  Highlight AFTER 5 MINUTES
- ⑤  Accept the new power down time.



## Changing the Auto Set Options

On delivery or after a reset, the Auto Set function captures waveforms from 15 Hz and faster and sets the input coupling to DC.

To configure Auto Set for capturing slow waveforms down to 1 Hz, do the following:

### Note



*Setting the Auto Set adjust to 1 Hz will slow down the Auto Set response. The display will show LF-AUTO.*

①		Open the User Options menu.
②		Highlight AUTOSSET ADJUST...
③		Open the AUTOSSET ADJUST submenu.



**AUTOSSET ADJUST** ↔

SEARCH for: <input checked="" type="checkbox"/> SIGNAL > 15Hz <input type="checkbox"/> SIGNAL > 1Hz	COUPLING: <input checked="" type="checkbox"/> SET to DC <input type="checkbox"/> UNCHANGED
---	--

**ENTER**

④		Highlight SIGNAL > 1 Hz.
⑤	 2x	Accept the new Auto Set configuration.

To configure Auto Set to maintain the actual input coupling (AC or DC), continue from step 3 as follows:

④		Select COUPLING.
⑤		Highlight UNCHANGED.
⑥		Accept the new Auto Set configuration.

## Using Proper Grounding

Incorrect grounding can cause various problems. This Section gives you guidelines for proper grounding.

- Use the short ground lead(s) when measuring DC or AC signals on input A and input B. (See Figure 9-2.)

### Warning

**To avoid electrical shock or fire, use only one COM (common) connection , or ensure that all connections to COM  are at the same potential.**

- Use the unshielded black ground lead to COM (common) for Ohm ( $\Omega$ ), Continuity, Diode, and Capacitance measurements. (See Figure 9-3.)

Using the unshielded ground lead is also possible for single or dual input measurements for waveforms with a frequency up to 1 MHz. This may add some hum or noise to the waveform display due to the unshielded ground lead.

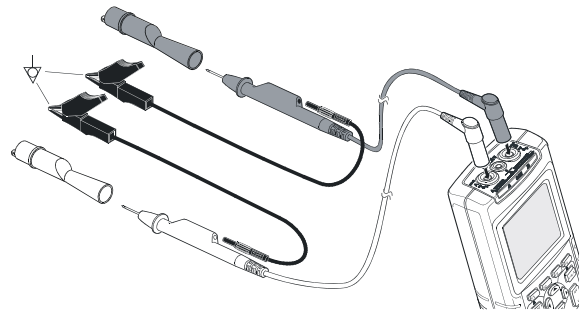

Figure 9-2. Grounding with Short Ground Lead

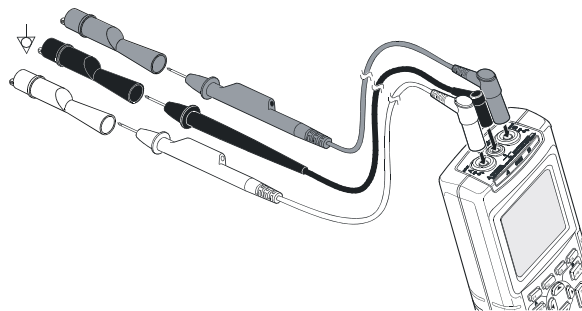

Figure 9-3. Grounding with Unshielded Ground Lead

## ***Solving Printing and Other Communication Errors***

RS-232 communication may cause problems. When experiencing communication problems, try the following remedies:

- Make sure that you have selected the correct printer type. (To select printer type, see Chapter 7.)
- Make sure that the baud rate matches with the printer or computer. (To set the baud rate, see Chapter 7.)
- PM9080: make sure that the interface cable is connected to the correct port on the printer or computer. If necessary use a 9 pin to 25 pin adapter or gender changer.
- OC4USB: make sure that the OC4USB cable's COM port matches the application program's (e.g. FlukeView) COM port. See also the OC4USB Instruction Sheet.
- OC4USB: make sure that the drivers for the USB cable are installed properly.

## ***Battery Testing of Fluke Accessories***

When using battery operated Fluke accessories, always check the battery condition of the accessory first on a **Fluke multimeter**.





205 Westwood Ave  
Long Branch, NJ 07740  
1-877-742-TEST (8378)  
Fax: (732) 222-7088  
salesteam@Tequipment.NET

## ***Chapter 10 Specifications***

### ***Introduction***

#### **Performance Characteristics**

FLUKE guarantees the properties expressed in numerical values with the stated tolerance. Specified non-tolerance numerical values indicate those that could be nominally expected from the mean of a range of identical ScopeMeter test tools.

Specifications are based on a one year calibration cycle.

#### **Environmental Data**

The environmental data mentioned in this manual are based on the results of the manufacturer's verification procedures.

#### **Safety Characteristics**

The test tool has been designed and tested in accordance with Standards ANSI/ISA-82.02.01, EN 61010-1: 2001, CAN/CSA-C22.2 No.61010-1-04 and UL no. 61010-1-04 (including cCSA<sub>US</sub> approval), Safety Requirements for Electrical Equipment for Measurement, Control, and Laboratory Use.

This manual contains information and warnings that must be followed by the user to ensure safe operation and to keep the instrument in a safe condition. Use of this equipment in a manner not specified by the manufacturer may impair protection provided by the equipment.

## Dual Input Oscilloscope

### Vertical

#### Frequency Response

DC Coupled:

excluding probes and test leads (via BB120): .....	
	DC to 40 MHz (-3 dB)
with STL120 1:1 shielded test leads: .....	
	DC to 12.5 MHz (-3 dB)
	DC to 20 MHz (-6 dB)
with VP40 10:1 probe:.....	
	DC to 40 MHz (-3 dB)

AC Coupled (LF roll off):

excluding probes and test leads.....	<10 Hz (-3 dB)
with STL120 .....	<10 Hz (-3 dB)
with 10 M $\Omega$ 10:1 Probe .....	<1 Hz (-3 dB)

#### Rise Time

excluding probes, test leads.....	<8.75 ns
-----------------------------------	----------

#### Input Impedance

excluding probes and test leads .....	1 M $\Omega$ //12 pF
with BB120 .....	1 M $\Omega$ //20 pF
with STL120 .....	1 M $\Omega$ //225 pF
with VP40 10:1 Probe.....	5 M $\Omega$ //15.5 pF

**Sensitivity** .....

**Display Modes** .....

#### **Max. Input Voltage A and B**

direct, with test leads, or with VP40 Probe .....	600 Vrms
with BB120 .....	300 Vrms

(For detailed specifications, see "Safety", Figs. 4-1/4-2)

#### **Max. Floating Voltage**

from any terminal to ground .....	600 Vrms
	up to 400 Hz

**Resolution** .....

**Vertical Accuracy** .....

**Max. Vertical Move** .....



**Horizontal**

**Scope Modes**..... Normal, Single, Roll

**Ranges**

Normal:

equivalent sampling ..... 10 ns to 500 ns/div

real time sampling ..... 1  $\mu$ s to 5 s/div

Single (real time)..... 1  $\mu$ s to 5 s/div

Roll (real time)..... 1s to 60 s/div

**Sampling Rate (for both channels simultaneously)**

Equivalent sampling (repetitive signals) .....  
up to 1.25 GS/s

Real time sampling:

1  $\mu$ s to 5 ms/div .....25 MS/s

10 ms to 60 s/div .....5 MS/s

**Time Base Accuracy**

Equivalent sampling .....  $\pm(0.4\% + 0.04 \text{ time/div})$

Real time sampling.....  $\pm(0.1\% + 0.04 \text{ time/div})$

**Glitch Detection** ..... $\geq 40 \text{ ns @ } 20 \text{ ns to } 5 \text{ ms/div}$

$\geq 200 \text{ ns @ } 10 \text{ ms to } 60 \text{ s/div}$

Glitch detection is always active.

**Horizontal Move** ..... 10 divisions

Trigger point can be positioned anywhere across the screen.

**Trigger**

**Screen Update** ..... Free Run, On Trigger

**Source** ..... A, B, EXT

EXTernal via optically isolated trigger probe ITP120  
(optional accessory)

**Sensitivity A and B**

@ DC to 5 MHz ..... 0.5 divisions or 5 mV

@ 40 MHz ..... 1.5 divisions

@ 60 MHz ..... 4 divisions

**Slope** ..... Positive, Negative

**Video on A** ..... interlaced video signals only

Modes ..... Lines, Line Select

Standards ..... PAL, NTSC, PAL+, SECAM

Polarity ..... Positive, Negative

Sensitivity ..... 0.6 divisions sync.

## **Advanced Scope Functions**

### **Display Modes**

- Normal ..... Captures up to 40 ns glitches and displays analog-like persistence waveform.
- Smooth ..... Suppresses noise from a waveform.
- Envelope .... Records and displays the minimum and maximum of waveforms over time.

### **Auto Set (Connect-and-View™)**

Continuous fully automatic adjustment of amplitude, time base, trigger levels, trigger gap, and hold-off. Manual override by user adjustment of amplitude, time base, or trigger level.

## **Dual Input Meter**

The accuracy of all measurements is within  $\pm$  (% of reading + number of counts) from 18 °C to 28 °C. Add 0.1x (specific accuracy) for each °C below 18 °C or above 28 °C. For voltage measurements with 10:1 probe, add probe uncertainty +1%. More than one waveform period must be visible on the screen.

### **Input A and Input B**

#### **DC Voltage (VDC)**

- Ranges.....500 mV, 5V, 50V, 500V, 1250V
- Accuracy .....  $\pm(0.5\% + 5 \text{ counts})$
- Normal Mode Rejection (SMR).....>60 dB  
@ 50 or 60 Hz  $\pm 1\%$
- Common Mode Rejection (CMRR)..... >100 dB @ DC  
>60 dB @ 50, 60, or 400 Hz
- Full Scale Reading .....5000 counts

#### **True RMS Voltages (VAC and VAC+DC)**

- Ranges.....500 mV, 5V, 50V, 500V, 1250V
- Accuracy for 5 to 100% of range
- DC coupled:
  - DC to 60 Hz (VAC+DC).....  $\pm(1\% + 10 \text{ counts})$
  - 1 Hz to 60 Hz (VAC).....  $\pm(1\% + 10 \text{ counts})$

AC or DC coupled:  
 60 Hz to 20 kHz.....  $\pm(2.5\% +15 \text{ counts})$   
 20 kHz to 1 MHz.....  $\pm(5\% +20 \text{ counts})$   
 1 MHz to 5 MHz.....  $\pm(10\% +25 \text{ counts})$   
 5 MHz to 12.5 MHz.....  $\pm(30\% +25 \text{ counts})$   
 5 MHz to 20 MHz (excl. test leads or probes).....  
 $\pm(30\% +25 \text{ counts})$

AC coupled with 1:1 (shielded) test leads  
 60 Hz (6 Hz with 10:1 probe)..... -1.5%  
 50 Hz (5 Hz with 10:1 probe)..... -2%  
 33 Hz (3.3 Hz with 10:1 probe)..... -5%  
 10 Hz (1 Hz with 10:1 probe)..... -30%

DC Rejection (only VAC)..... >50 dB  
 Common Mode Rejection (CMRR)..... >100 dB @ DC  
 >60 dB @ 50, 60, or 400 Hz

Full Scale Reading ..... 5000 counts  
 The reading is independent of any signal crest factor.

**Peak**

Modes ..... Max peak, Min peak, or pk-to-pk  
 Ranges..... 500 mV, 5V, 50V, 500V, 1250V  
 Accuracy:  
 Max peak or Min peak ..... 5% of full scale  
 Peak-to-Peak ..... 10% of full scale  
 Full Scale Reading ..... 500 counts

**Frequency (Hz)**

Ranges..... 1 Hz, 10 Hz, 100 Hz, 1 kHz, 10 kHz,  
 100 kHz, 1 MHz, 10 MHz, and 70 MHz

Frequency Range in Continuous Autoselect .....  
 15 Hz (1 Hz) to 50 MHz

Accuracy:  
 @1 Hz to 1 MHz .....  $\pm(0.5\% +2 \text{ counts})$   
 @1 to 10 MHz .....  $\pm(1.0\% +2 \text{ counts})$   
 @10 to 70 MHz.....  $\pm(2.5\% +2 \text{ counts})$   
 (50 MHz in Autorange)  
 Full Scale Reading ..... 10 000 counts

**RPM**

Max reading ..... 50.00 kRPM  
 Accuracy .....  $\pm(0.5\% +2 \text{ counts})$

**Duty Cycle (PULSE)**

Range..... 2% to 98%  
 Frequency Range in Continuous Autoselect .....  
 15 Hz (1 Hz) to 30 MHz  
 Accuracy (Logic or Pulse waveforms):  
 @1Hz to 1 MHz .....  $\pm(0.5\% +2 \text{ counts})$   
 @1 MHz to 10 MHz .....  $\pm(1.0\% +2 \text{ counts})$

**Pulse Width (PULSE)**

Frequency Range in Continuous Autoselect .....  
 15 Hz (1 Hz) to 30 MHz  
 Accuracy (Logic or Pulse waveforms):  
 @1 Hz to 1 MHz .....  $\pm(0.5\% +2 \text{ counts})$   
 @1 MHz to 10 MHz .....  $\pm(1.0\% +2 \text{ counts})$   
 Full Scale Reading ..... 1000 counts

## Fluke 125

### Users Manual

---

**Amperes (AMP)** .....with current clamp  
Ranges ..... same as VDC, VAC, VAC+DC, or PEAK  
Scale Factors..0.1 mV/A, 1 mV/A, 10 mV/A, 100 mV/A,  
400 mV/A, 1 V/A, 10 mV/mA  
Accuracy ..... same as VDC, VAC, VAC+DC, or PEAK  
(add current clamp uncertainty)

**Temperature (TEMP)**.... with optional temperature probe  
Range .....200 °C/div (200 °F/div)  
Scale Factor..... 1 mV/°C and 1 mV/°F  
Accuracy .....as VDC (add temp. probe uncertainty)

#### Decibel (dB)

0 dBV ..... 1V  
0 dBm (600Ω /50Ω)..... 1 mW  
referenced to 600Ω or 50Ω  
dB on ..... VDC, VAC, or VAC+DC  
Full Scale Reading..... 1000 counts

#### Crest Factor (CREST)

Range .....1 to 10  
Accuracy ..... ±(5% +1 count)  
Full Scale Reading..... 100 counts

#### Phase

Modes ..... A to B, B to A  
Range .....0 to 359 degrees  
Accuracy up to 1 MHz.....2 degrees  
Accuracy 1 MHz to 5 MHz .....5 degrees  
Resolution..... 1 degree

#### Power

Configurations .....1 phase  
..... 3 phase 3 conductor balanced loads  
(3 phase: fundamental component only,  
AUTOSSET mode only)  
Power Factor (PF)..... ratio between Watts and VA  
Range..... 0.00 to 1.00  
Watt.....RMS reading of multiplying  
corresponding samples of input A (volts)  
and input B (amperes)  
Full Scale reading..... 999 counts  
VA .....Vrms x Arms  
Full Scale Reading ..... 999 counts  
VA Reactive (VAR).....  $\sqrt{((VA)^2 - W^2)}$   
Full Scale Reading ..... 999 counts

#### Ppwm

Purpose ..... to measure on pulse width modulated  
signals, like motor drive inverter outputs  
Principle ..... readings show the effective voltage based  
on the average value of samples over a  
whole number of periods of the fundamental  
frequency  
Accuracy ..... as Vrms for sinewave signals

**Input A**

**Ohm ( $\Omega$ )**

Ranges.....50 $\Omega$ , 500 $\Omega$ , 5 k $\Omega$ , 50 k $\Omega$ , 500 k $\Omega$ ,  
 ..... 5 M $\Omega$ , 30 M $\Omega$   
 Accuracy: .....  $\pm(0.6\% + 5 \text{ counts})$   
 .....50  $\Omega \pm(2 \% + 20 \text{ counts})$   
 Full Scale Reading:  
 50  $\Omega$  to 5 M $\Omega$ ..... 5000 counts  
 30 M $\Omega$  ..... 3000 counts  
 Measurement Current ..... 0.5 mA to 50 nA  
 decreases with increasing ranges  
 Open Circuit Voltage ..... <4V

**Continuity (CONT)**

Beep..... <(30 $\Omega \pm 5\Omega$ ) in 50  $\Omega$  range  
 Measurement Current ..... 0.5 mA  
 Detection of shorts of .....  $\geq 1 \text{ ms}$

**Diode**

Measurement Voltage:  
 @0.5 mA ..... >2.8V  
 @open circuit..... <4V  
 Accuracy.....  $\pm(2\% + 5 \text{ counts})$   
 Measurement Current..... 0.5 mA  
 Polarity ..... + on input A, - on COM

**Capacitance (CAP)**

Ranges ..... 50 nF, 500 nF, 5  $\mu$ F, 50  $\mu$ F, 500  $\mu$ F  
 Accuracy.....  $\pm(2\% + 10 \text{ counts})$   
 Full Scale Reading ..... 5000 counts  
 Measurement Current..... 5  $\mu$ A to 0.5 mA  
 increases with increasing ranges  
 Dual slope integrating measurement with parasitic  
 serial and parallel resistance cancellation.

## **Advanced Meter Functions**

### **Zero Set**

Set actual value to reference

### **Fast/Normal/Smooth**

Meter settling time Fast: 1s @ 1  $\mu$ s to 10 ms/div.

Meter settling time Normal: 2s @ 1  $\mu$ s to 10 ms/div.

Meter settling time Smooth: 10s @ 1  $\mu$ s to 10 ms/div.

### **Touch Hold (on A)**

Captures and freezes a stable measurement result.

Beeps when stable. Touch Hold works on the main meter reading, with thresholds of 1 Vpp for AC signals and 100 mV for DC signals.

### **TrendPlot**

Graphs meter readings of the Min and Max values from 15 s/div (120 seconds) to 2 days/div (16 days) with time and date stamp. Automatic vertical scaling and time compression.

Displays the actual and Minimum, Maximum, or average (AVG) reading.

### **Fixed Decimal Point**

Possible by using attenuation keys.

## **Cursor readout**

### **Sources:**

A, B

### **Single Vertical Line:**

Average, Min and Max Readout

Average, Min, Max and Time from Start of Readout (in ROLL mode; instrument in HOLD)

Min, Max and Time from Start of Readout (in TRENDPLOT mode; instrument in HOLD)

### **Dual Vertical Lines:**

Peak-Peak, Time Distance and Reciprocal Time Distance Readout

Average, Min, Max and Time Distance Readout (in ROLL mode; instrument in HOLD)

### **Dual Horizontal Lines:**

High, Low and Peak-Peak Readout

### **Rise or Fall Time:**

Transition Time, 0%-Level and 100%-Level Readout (Manual or Auto Leveling; Auto Leveling only possible in Single Channel Mode)

### **Accuracy:**

As Oscilloscope Accuracy

**Harmonics Measurements**

Number of Harmonics	
..... DC..33 (< 60 Hz)	
..... DC..24 (400 Hz)	
Readings / Cursor readings (fundamental 40...70 Hz)	
V rms / A rms	fund. $\pm(3\% + 2 \text{ counts})$
.....	33st $\pm(5\% + 3 \text{ counts})$
Watt	fund. $\pm(5\% + 10 \text{ counts})$
.....	33st $\pm(10\% + 10 \text{ counts})$
Frequency of fundamental	$\pm 0.25 \text{ Hz}$
Phase Angle	fund. $\pm 3^\circ$ ... 33st $\pm 15^\circ$
K-factor (in Amp and Watt)	$\pm 10\%$
Time base	fixed

**Field Bus Measurements**

Type	Subtype	Protocol
AS-i		NEN-EN50295
CAN		ISO-11898
Interbus S	RS-422	EIA-422
ControlNet		61158 type 2
Modbus	RS-232 RS-485	RS-232/EIA-232 RS-485/EIA-485
Foundation Fieldbus	H1	61158 type 1, 31.25 kBit
Profibus	DP PA	EIA-485 61158 type 1
Ethernet	Coax TP	10Base2 10BaseT
RS-232		EIA-232
RS-485		EIA-485

## **Miscellaneous**

### **Display**

Size .....	72 x 72 mm (2.83 x 2.83 in)
Resolution .....	240 x 240 pixels
Waveform Display:	
Vertical .....	8 div of 20 pixels
Horizontal .....	9.6 div of 25 pixels
Backlight .....	Cold Cathode Fluorescent (CCFL)

### **Power**

External: .....	via Power Adapter PM8907
Input Voltage .....	10 to 21V DC
Power .....	5W typical
Input Connector .....	5 mm jack
Internal: .....	via Battery Pack BP120MH
Battery Power .....	Rechargeable Ni-MH 4.8V
Operating Time .....	6 hours with bright backlight 6.30 hours with dimmed backlight
Charging Time .....	7 hours with test tool off 60 hours with test tool on 12 .. 20 hours with refresh cycle
Allowable ambient temperature:	
during charging .....	0 to 45 °C (32 to 113 °F)

### **Memory**

Number of Data set Memories .....	20
-----------------------------------	----

### **Mechanical**

Size .....	232 x 115 x 50 mm (9.1 x 4.5 x 2 in)
Weight .....	1.2 kg (2.5 lbs) including battery pack

### **Interface** .....

To Printer .....	RS-232, optically isolated supports Epson FX, LQ, and HP Deskjet <sup>®</sup> , Laserjet <sup>®</sup> , and Postscript
Serial via PM9080 (optically isolated RS-232 adapter/cable, optional).	
Parallel via PAC91 (optically isolated print adapter cable, optional).	
To PC .....	Dump and load settings and data Serial via OC4USB (optically isolated RS-232/USB adapter/cable, optional), using SW90W (FlukeView <sup>®</sup> software for Windows <sup>®</sup> ).



## Environmental

**Environmental** ..... MIL-PRF-28800F, Class 2

### Temperature

Operating ..... 0 to 50 °C (32 to 122 °F)  
Storage ..... -20 to 60 °C (-4 to 140 °F)

### Humidity

Operating:  
 @0 to 10 °C (32 to 50 °F).....noncondensing  
 @10 to 30 °C (50 to 86 °F)..... 95%  
 @30 to 40 °C (86 to 104 °F).....75%  
 @40 to 50 °C (104 to 122 °F).....45%  
 Storage:  
 @-20 to 60 °C (-4 to 140 °F) .....noncondensing

### Altitude

Operating ..... 5 km (16 400 feet)  
 Max. Input and Floating Voltage 600 Vrms upto 2 km,  
 > 2 km 300 Vrms <5 km.  
 Storage ..... 12 km (40 000 feet)

**Vibration (sinusoidal)** .....  
 ..... MIL28800F, class 2, 3.8.4.2, 4.5.5.3.1: Max. 3g

**Shock** .....  
 ..... MIL28800F, class 2, 3.8.5.1, 4.5.5.4.1: Max. 30g

## Electromagnetic Compatibility (EMC)

Emission and Immunity .....EN/IEC61326-1: 2006

**Enclosure Protection** ..... IP51, ref: EN/IEC60529

### Safety

Designed for measurements on 600 Vrms Measurement Category III, Pollution Degree 2, per:

- ANSI/ISA S82-02.01
- EN/IEC 61010-1: 2001
- CAN/CSA-C22.2 No.61010-1-04 and UL no. 61010-1-04 (including cCSA<sub>US</sub> approval)

### Max. Input Voltage Input A and B

Direct on input or with leads ..... 600 Vrms  
 for derating, see Figure 10-1.  
 With Banana-to BNC Adapter BB120 ..... 300 Vrms  
 for derating, see Figure 10-1.

### Max. Floating Voltage

from any terminal to ground ..... 600 Vrms  
 up to 400 Hz

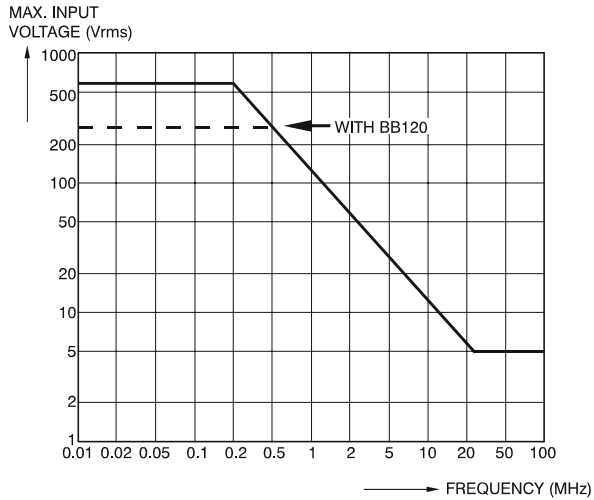

**Figure 10-1. Max. Input Voltage v.s. Frequency for BB120 and STL120**

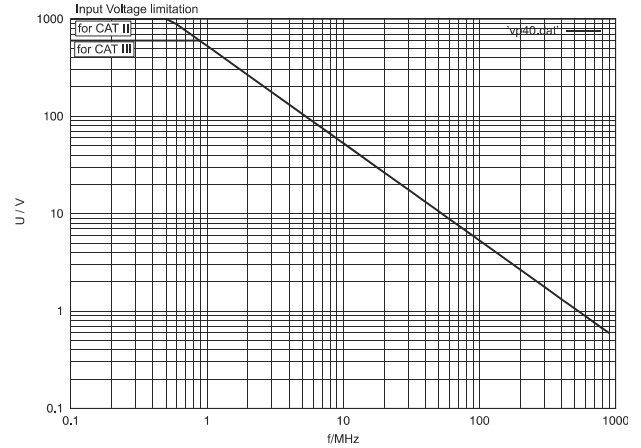

**Figure 10-2. Max. Input Voltage v.s. Frequency for VP40 10:1 Voltage Probe**

The Fluke 125, including standard accessories, conforms with the EEC directive 2004/108/EC for EMC immunity, as defined by EN61326-1: 2006, with the addition of the following tables.

**Trace disturbance with STL120**

**Table 1**

<b>No visible disturbance</b>	<b>E= 3 V/m</b>	<b>E= 10 V/m</b>
Frequency range 10 kHz to 27 MHz Frequency range 27 MHz to 1 GHz	100 mV/div to 500 V/div 100 mV/div to 500 V/div	500 mV/div to 500 V/div 100 mV/div to 500 V/div
<b>No visible disturbance</b>	<b>E= 3 V/m</b>	<b>E= 1 V/m</b>
Frequency range 1.4 GHz to 2.0 GHz Frequency range 2.0 GHz to 2.7 GHz	5 mV/div to 500 V/div	5 mV/div to 500 V/div

**Table 2**

<b>Disturbance less than 10% of full scale</b>	<b>E= 3 V/m</b>	<b>E= 10 V/m</b>
Frequency range 10 kHz to 27 MHz Frequency range 27 MHz to 1 GHz	20 mV/div to 50 mV/div 10 mV/div to 20 mV/div	100 mV/div to 200 mV/div -

(-): no visible disturbance

Test tool ranges not specified in tables 1 and 2 may have a disturbance of more than 10% of full scale.

**Multimeter disturbance:**

- **VDC, VAC, and VAC+DC with STL120 and short ground lead.**
- **OHM, CONT, DIODE, and CAP with STL120, and black test lead to COM.**

**Table 3**

<b>Disturbance less than 1% of full scale</b>	<b>E= 3 V/m</b>	<b>E= 10 V/m</b>
Frequency range 10 kHz to 27 MHz VDC, VAC, VAC+DC OHM, CONT, DIODE CAP	500 mV to 1250V 50 Ω to 30 MΩ 50 nF to 500 μF	500 mV to 1250V 50 Ω to 30 MΩ 50 nF to 500 μF
Frequency range 27 MHz to 1 GHz VDC, VAC, VAC+DC OHM, CONT, DIODE CAP	500 mV to 1250V 50 Ω to 30 MΩ 50 nF to 500 μF	500 mV to 1250V 50 Ω to 30 MΩ 50 nF to 500 μF
<b>Disturbance less than 1% of full scale</b>	<b>E= 3 V/m</b>	<b>E= 1 V/m</b>
Frequency range 1.4 GHz to 2 GHz VDC, VAC, VAC+DC OHM, CONT, DIODE CAP	500 mV to 1250V 50 Ω to 30 MΩ 50 nF to 500 μF	
Frequency range 2 GHz to 2.7 GHz VDC, VAC, VAC+DC OHM, CONT, DIODE CAP		500 mV to 1250V 50 Ω to 30 MΩ 50 nF to 500 μF

Test tool ranges not specified in table 3 may have a disturbance of more than 10% of full scale.

# ***Appendices***

<b>Appendix</b>	<b>Title</b>	<b>Page</b>
	Bushealth Measurements .....	A-1



# **Appendix A**

## **Bushealth Measurements**

### **Introduction**

This Appendix contains information to extend the information presented in the Fluke 125 Users Manual.

This concerns Chapter 4 – Fieldbus Measurements and more in particular Table 4-1. This table shows for each Fieldbus type the ScopeMeter channels and probe types to be used for testing.

The purpose of this Appendix is to give more information on how to connect Probe(s) and Ground Lead to the Fieldbus system under test. Bear in mind however that due to the variety of Bus Standards and Connectors used worldwide it is impossible to cover all situations. The connection solutions in this Supplement cover those most commonly found.

### **General**

The Bushealth measurement is based upon the instrument's Scope mode. In Scope mode the instrument displays the waveforms of the bus signals. Once a signal is captured it requires expert knowledge on how to interpret these signals. Bushealth makes signal interpretation very easy. The captured waveform(s) are compared against voltage and timing criteria as specified for the tested Bus Type, resulting in clear quality information of these criteria (OK, marginal, or out of range).

**Caution**

**Fieldbusses often are controlling delicate processes that must not be disturbed. It is strongly recommended to contact the system manager before any connections are made.**

**Use of Probes and Accessories**

Use of Probes: refer to page 0-2 and 0-3 of this Manual for an overview of accessories as supplied with Fluke 125.

For most measurements the Shielded Test Leads STL120 (1:1) are used. To hook up the ScopeMeter's COM terminal to a Bus System you can use the Black Test Lead. In noisy environments however it is advised to use the shorter ground lead with alligator clip (supplied with STL120) instead of the Black Test Lead.

To hook up to bus line nodes you can use the Alligator Clips or Hook Clips that fit on to the STL120 tip. TP88 Back Probe Pins (optional) can be used to probe screw terminals at the wire entry point.

Alligator Clips, Hook Clips, and the optional Back Probe Pins also fit on the tip of the VPS40 Probe (10:1) that is used to test some of the Fieldbus types. VPS40 is used on bus systems that are sensitive to the capacitive load of

STL120 (225 pF against 15.5 pF for VPS40). When using a 10:1 probe other than VPS40, it must be adjusted for a good pulse response! A poorly calibrated probe can introduce measurement errors or the measurement may not be possible. How to adjust is explained in chapter 2.

The Banana-to-BNC Adapter BB120 may be used when testing systems with coaxial connection cables. If the system requires so you must add a coaxial 50 or 75  $\Omega$  termination at the BB120. As an alternative you may connect the VPS40 10:1 probe across a terminator in the system under test.

You can use the optional BHT190 Bushealth Test adapter to connect the probe tip in an easy way to busses that use a DB9, RJ-45 or a M12 connector.

In some bus systems (AS-i for instance) the protocol uses continuous polling of all devices in a fixed time schedule so that there is continuous data traffic. Other systems such as RS-232 only carry data when settings are changed. Bushealth requires continuous data traffic to perform its measurements. In case of very low data repetition rates, the banner 'NO DATA' is displayed. In systems with low data rates, it is recommended to increase the data rate by e.g. knob operation. Contact the system manager for this.



For Bus measurements that use input A and B (CAN, Modbus RS-485, Profibus DP, RS-485) it is important that the Common Mode component at the inputs is as small as possible. This component may consist of 50 or 60 Hz hum or other noise. Common mode signals may affect measurement results. In case of doubt, use SCOPE mode to investigate the waveforms at A and B. In case of visible interference, look for a ground lead attachment point in the system under test that shows the smallest interference.

### **Tips and Hints per Bustype**

#### **AS-i Bus**

The Actuator-Sensor-Interface (AS-i) is used to control on/off devices at the factory floor. The bus consists of 2 wires marked + and – that carry a 30 Vdc supply with superimposed data. The AS-i protocol uses continuous polling of all devices in a fixed time schedule so that there is continuous data traffic.

To check AS-i, ScopeMeter Channel A is on and alternately AC coupled for data or DC coupled to test 30 Vdc. The recommended probe is STL120 (1:1). The probe tip must be connected to the + (positive) wire; the COM input (or Black Ground Lead) to the – (negative) wire.

Connection between controller and devices is made using a dedicated yellow flat cable as shown in the figure below (cross section). Connection to the devices is done with piercing connectors. To connect Probe Tip and Black Ground Lead to + (brown conductor) and – (blue), the TP88 Back Probe Pins (optional) can be used to probe screw terminals at the end of the flat cable or as piercing probes. The material of the flat cable also allows to pierce the pin into it. After removal of the pin the material closes again.

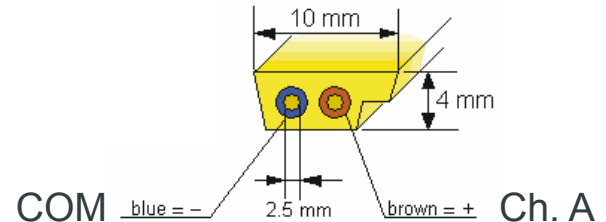

As-i also uses M12-connectors for data as well as on/off signals. The figure below shows where to find + and – on such a connector.

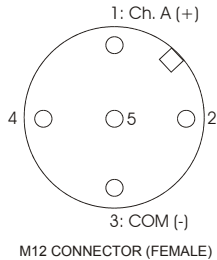

### **CAN Bus/DeviceNet**

The Controller Area Network (CAN) is used on board of automobiles and also in industrial applications. The industrial bussystem DeviceNet is based on CAN hardware. CAN is a two-wire differential bus used to control actuators and to read out sensors. The bus allows data exchange between different devices. The signal behavior in time is shown in the figure below. The signal wires are marked CAN\_L and CAN\_H. There is also a common (reference wire) CAN\_GND. Data traffic is continuous. Each of the CAN bus lines can be in either two logical states: recessive and dominant. The state changes occur on both wires simultaneously. The voltage level for recessive (logical 1) is 2.5 V for both bus lines. The voltage level for dominant (logical 0) is 3.5 V for CAN\_H and 1.5 V for CAN\_L.

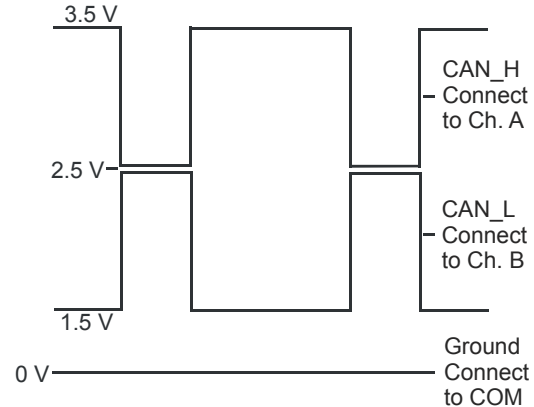

To check CAN Bus, ScopeMeter Channel A and B are on and DC coupled. The recommended probes are STL120 (1:1). Probe Tip A must be connected to CAN\_H, B to CAN\_L, and COM to CAN\_GND.

Bus lines can be reached with Back Probe Pins at screw terminals at a device's wire entry point: wire colors commonly used are white for CAN\_H, blue for CAN\_L, and black for CAN\_GND.

Alternatively you can use a third party DB-9 to 4 mm banana breakout box. In addition the figure below shows the pinning of a DB-9 female connector and a typical Automotive (OBD2) connector. Bear in mind that some

automobile manufacturers leave bus signals at the connector default on, other manufacturers require bus signals to be enabled via an external controller.

**DB-9 (FEMALE)**

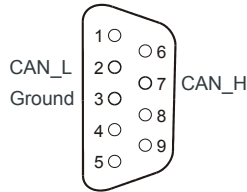

**1 OBD2 (FEMALE) 8**

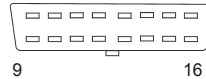

High Speed:  
HS\_CAN\_H: Pin 6 / HS\_CAN\_L: Pin 14  
Medium Speed:  
MS\_CAN\_H: Pin 3 / MS\_CAN\_L: Pin 11  
Common (Signal Ground): Pin 5  
Battery: Plus: Pin 16 / Minus: Pin 4

**Interbus S**

Is used in Process Industry and Factory Automation such as Assembly, Welding, and Materials Handling machines. Controller and Devices are arranged in a ring system as shown in the figure below. Interconnection between the devices is achieved via a Twisted Pair of lines DO (Data Out, yellow wire) / Not-DO (green) and another pair DI (Data In, gray) / Not-DI (pink). Data traffic is continuous, passing data packets through the chain of devices.

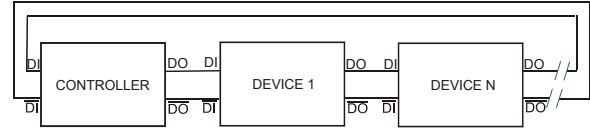

To check Interbus S, ScopeMeter Channel A is on and DC coupled. The recommended probe is VPS40 (10:1). The probe tip must be connected to the DO (or DI) wire; the COM input (or Black Ground Lead) to the Not-DO (or Not-DI) wire. The wires can be reached with Back Probe Pins at screw terminals at a device's wire entry point: for instance at a Junction Box. In addition the figure below shows the pinning of a DB-9 female connector wired for Interbus S.

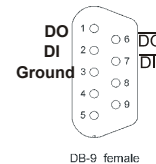

**ControlNet**

Is a network system used for high performance automation and process control. Connection between devices is achieved via 75 Ω coaxial cables. The figure

## Fluke 125 Users Manual

below shows a typical system layout. Data traffic is continuous.

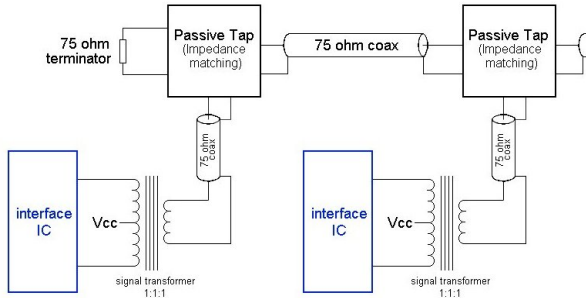

To check ControlNet, ScopeMeter Channel A is on and DC coupled. The recommended Banana to BNC Adapter BB120 (1:1) allows Channel A to connect to BNC cables. To connect to the System Under Test use a PM9083 male BNC to dual Female BNC adapter (T-piece, optional), and an extra BNC cable (PM9092, optional) as shown in the figure below.

Bear in mind that in ControlNet cabling must not be disconnected during normal process operation. Some systems provide a Coaxial Breakout to make connection to BB120. Use a short coaxial cable to minimize load on to the system.

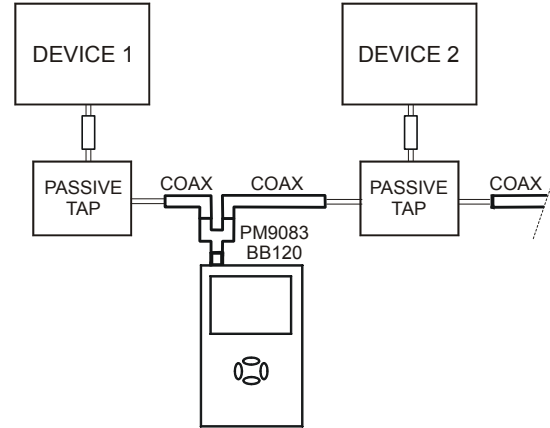

### **Modbus IEA-232/RS-232.**

Is in use in Process Industry, Building and Factory Automation. Modbus RS-232 is used for point-to-point communication. System layout is shown in the figure below. Continuous Data traffic is not ensured. To check this type of bus, ScopeMeter Channel A is on and DC coupled. The recommended probe is STL120 (1:1). The probe tip must be connected to the Tx (Transmit) or Rx (Receive) wire; the COM input (or Black Ground Lead) to the Signal Ground. In case there are handshake lines,

they can be measured as well as far as V-Levels are concerned.

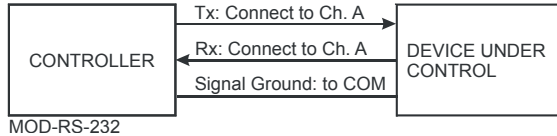

### **Modbus IEA-485/RS-485**

Is in use in Process Industry, Building and Factory Automation. Modbus System layout is shown in the figure below. Continuous Data traffic is not ensured. To check this type of bus, ScopeMeter Channel A and B are on and DC coupled. The recommended probes are STL120 (1:1). Probe tip A must be attached to the + (positive) wire; Probe tip B to the – (negative) wire, and the COM input (or Black Ground Lead) to Signal Ground (GND).

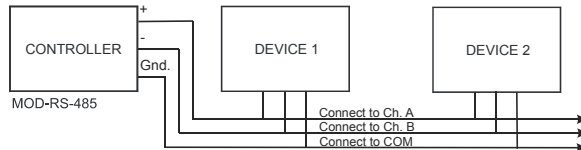

### **Foundation Fieldbus H1 31.25 kBits/s**

Is used to control 'field equipment' such as sensors, actuators, valves, and I/O devices via a two-wire connection. The system allows two-way communication between controller and the devices. Data traffic is continuous. The wires are marked + and – and carry a DC supply of about 24 Vdc with superimposed data of about 800 mVpp. The figure below shows the bus structure.

To check Foundation Fieldbus, ScopeMeter Channel A is on and alternately AC coupled for data or DC coupled to test 24 Vdc. The recommended probe is STL120 (1:1). The probe tip must be connected to the + (positive) wire; the COM input (or Black Ground Lead) to the – (negative) wire. Suitable measuring spots are the screw terminals that are present in a system's junction boxes. If preferred, you can use the TP88 Back Probe Pins (optional) to probe these terminals at the wire entry point. Commonly used wire colors are orange for + and blue for –.

**Fluke 125  
Users Manual**

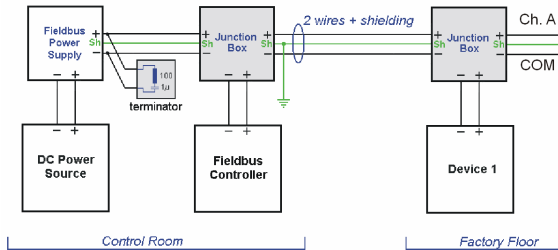

**Profibus DP/RS-485**

Profibus DP (Decentralized Periphery) is an open Fieldbus standard used in Process Industry and Factory Automation. It is optimized for speed, efficiency, and low connection costs and allows for multiple data senders and receivers to be connected to an ongoing cable. Data traffic is continuous.

To check this bustype, ScopeMeter Channel A and B are on and DC coupled. The recommended probes are STL120 (1:1). Probe tip A must be attached to the A (positive; usually green) wire; Probe tip B to the B (negative; usually red) wire, and the COM input (or Black Ground Lead) to Data Ground (DGND). Cabling and some connector examples are shown in the figures

below. Please note that cables often incorporate termination resistors at the end of the network chain.

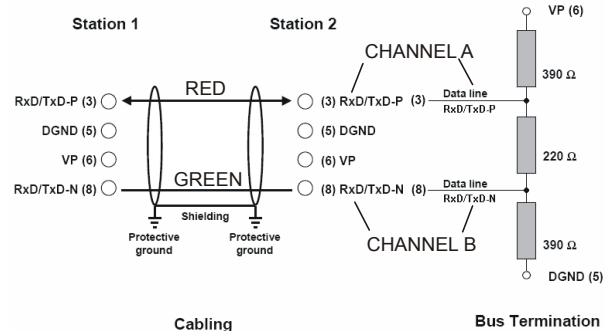

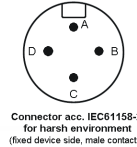
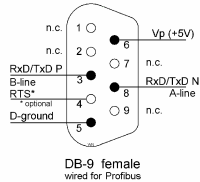
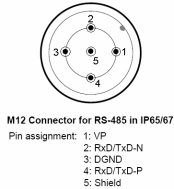

A: Data+ and Pwr  
 B: Data- and Pwr  
 C: Optional Pwr+  
 D: Optional Pwr-

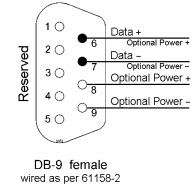

### Profibus PA/31.25 kBits/s

Profibus PA (Process Automation) is optimized for process control with focus on explosion safety. The wires are marked Data + and Data – and carry a DC supply with superimposed data. Additionally there are wires with DC power only. Data traffic is continuous.

To check this bustype, ScopeMeter Channel A is on and alternately AC coupled for data or DC coupled to test the DC supply. The recommended probe is STL120 (1:1). The probe tip must be connected to the Data + line; the COM input (or Black Ground Lead) to the Data – line. The figures below show some connector types.

### Caution

**When planning tests on this bustype, make sure the proper safety rules are adhered to!**

### Ethernet Coax/10Base2

To check this bustype, ScopeMeter Channel A is on and DC coupled. The recommended Banana to BNC Adapter BB120 (1:1) allows Channel A to connect with BNC cables. To connect to the System Under Test use a PM9083 male BNC to dual Female BNC adapter (T-piece, optional), and an extra BNC cable (PM9092, optional) as shown in the figure below. Bear in mind that in Ethernet cabling should only be interrupted for a few seconds during normal process operation. Data traffic usually is continuous.

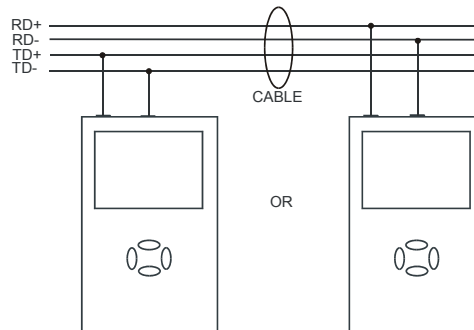
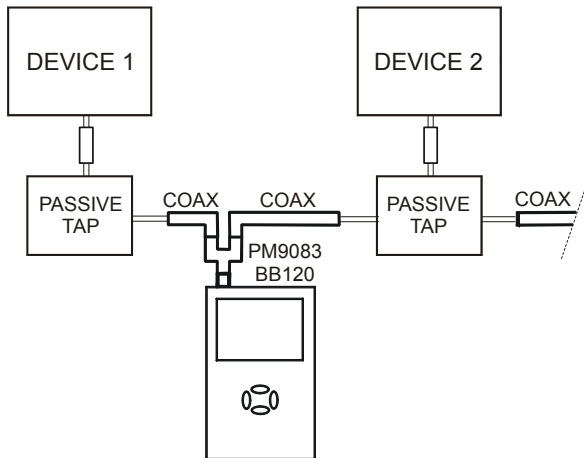

The wires can be reached with Back Probe Pins TP88 (optional) at screw terminals at a device's wire entry point: for instance at a Junction Box. The right-hand figure shows pinning and wire colors of a RJ-45 connector.

### **Ethernet Twisted pair/10BaseT**

To check this bustype, ScopeMeter Channel A is on and DC coupled. The recommended probe is VPS40 (10:1), Channel A is on and DC coupled. The probe tip must be connected to the TD+ or RD+ wire; the COM input (or Black Ground Lead) to the TD- or RD- wire. Data traffic is not always continuous.

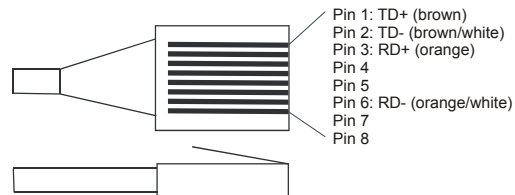



### **RS-232 Bus**

RS-232 allows two-way communication between a controller and a device such as modem, printer, or sensor. Per device a dedicated link is needed. Initially the RS-232 definition offered an extensive handshake protocol with separate handshake lines (hardware handshake); later software handshake allowed data exchange via only 2 lines (plus ground). Data rates may be low, depending on the application.

To check this bustype, ScopeMeter Channel A is on and DC coupled. The recommended probe is STL120 (1:1). The probe tip must be connected to the Tx (Transmit) or Rx (Receive) wire; the COM input (or Black Ground Lead) to the Signal Ground. In case there are handshake lines, they each can be checked individually because all use the same voltage levels. The figure below shows a Female DB-9 connector wired for hardware handshake. Lines used for software handshake are indicated with black dots.

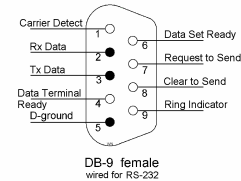

### **RS-485 Bus**

The RS-485 definition specifies differential (balanced) data lines that are referenced to a ground level. Because of this, noise immunity is better than for RS-232. The impedance between the lines is 120 Ω. RS-485 allows for multiple transmitters and receivers to be connected to the same bus. Data transmission is addressed to a dedicated receiver. Data traffic is not continuous.

To check this bustype, ScopeMeter Channel A and B are on and DC coupled. The recommended probes are STL120 (1:1). Probe tip A must be attached to the + line; Probe tip B to the – line, and the COM input (or Black Ground Lead) to DGND (Data Ground, Signal Ground).

**Fluke 125  
Users Manual**

---

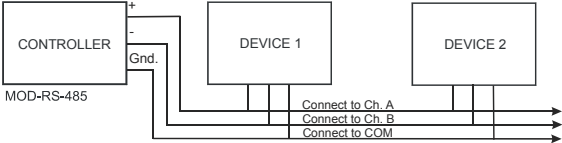

**Overview of Female DB-connectors**

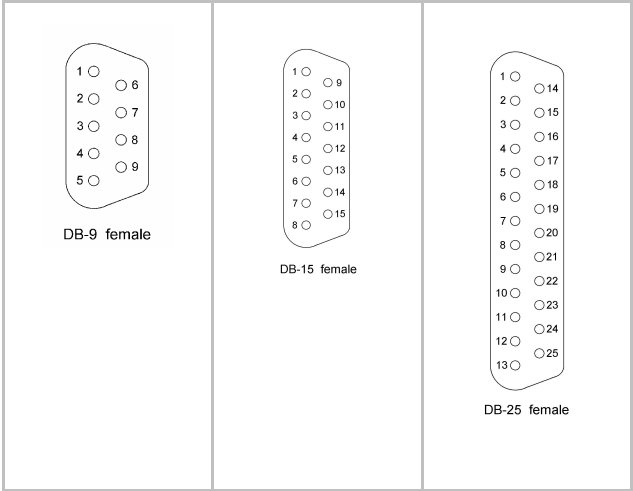



## *Index*

### **—1—**

10

1 Probe, 2-25

### **—A—**

AC coupling, 0-4

AC120 Alligator Clips, 8-9

Accessories, 8-7

**AC-Coupling**, 2-16

Acquiring the Waveform, 2-14

Acquisition Modes, 10-3

Adjusting Scope Probes, 8-5

Advanced Meter Functions, 10-8

Advanced Scope Functions, 10-4

Alligator Clips, 8-9

Altitude, 10-11

Amperes Measurement, 10-6

Amplitude, 2-10

Auto Set, 2-3, 10-4

Auto Set Configuration, 9-5

Auto/Manual, 2-10

Automatic Power Shutdown, 9-4

Avoid Electrical Shock, 1-5

### **—B—**

Backlight, 1-3

Banana Jack Inputs, 1-5

Banana-to-BNC Adapter, 8-9

Bandwidth, 10-2

Battery Charger, 8-8

Battery Disposing, 8-4

Battery Indicator, 1-1, 2-2

Battery Life, 9-4

Battery Pack, 0-2, 8-2, 8-8

Battery Power, 10-10

battery refresh, 8-3

Battery Refresh Date, 8-7

Battery Replacing, 8-4

BB120 Adapters, 8-9

Blue Function Keys, 2-2

BP120MH Battery Pack, 8-8

Bright Display, 1-3

Bus test limits, 4-4

bus type, 4-2

BUSHEALTH, 4-2

### **—C—**

C120 Hard Case, 8-10

C125 Compact Soft Case, 8-10

Capacitance, 9-6, 10-7

Case, 8-10

Cat.III, 0-6

**Caution**, 0-4

Changing the Amplitude, 2-10

Changing the Time Base, 2-10

Charge Time, 10-10

Charger, 8-8

Charging, 8-2

Cleaning, 8-1

Common, 1-5

Communication Errors, 9-7

Compact Soft Case, 8-10

Computer, 3

Connect-and-View function, 2-3

Connecting a Computer, 4

Connecting the Inputs, 2-4

Continuity, 9-6, 10-7

Contrast, 1-3

Crest Factor, 10-6

Current Measurement, 10-6

Cursors, 2-22, 10-8

**—D—**

Data set, 6-1

Dataset name, 6-2

Date, 9-3

DC Voltage (VDC), 10-4

DC-Coupling, 2-16

Decibel (dB), 10-6

Declaration of Conformity, 0-1

Deleting Data Sets, 6-3

Dimmed Display, 1-3

Diode, 9-6, 10-7

Display, 10-10

Disposing Batteries, 8-4

Duty Cycle, 10-5

**—E—**

Earth Ground, 0-6

Electrical Shock, 0-5

Electrically Floating, 0-6

Electromagnetic Compatibility, 10-11

Emission, 10-11

Envelope, 10-4

Envelope of a Waveform, 2-13

Environmental, 10-11

Environmental Data, 10-1

Eye pattern, 4-7

**—F—**

Fast/Smooth, 10-8

*Field Bus Measurements*, 10-9

Fieldbus, 4-1

Fixed Decimal Point, 10-8

FlukeView, 3, 8-10

**FREE RUN**, 2-19

Freeze Recording, 2-15

Freezing the Screen, 2-8

Frequency (Hz), 10-5

Frequency Response, 10-2

Function Keys, 2-2

**—G—**

Glitch Detection, 10-3

glitches, 10-4

Gray Text, 1-4, 2-19

Grey INPUT B, 1-5

Grid Display, 9-2

ground, 0-6

Ground Test Lead, 8-9

Grounding Problems, 9-6

**—H—**

Hard Carrying Case, 8-10

Harmonics, 3-1

Harmonics Measurements, 10-9

HC120 Hook Clips, 8-9

High Frequency Measurements, 2-25

Holding a Stable Reading, 2-8

Hook Clips, 8-9

Horizontal Cursors, 2-22

Horizontal Move, 10-3  
Humidity, 10-11  
Hz, 10-5

—|—

Information Language, 9-2  
Input A, 1-5  
Input B, 1-5  
Input Coupling, 2-16  
Input Impedance, 10-2  
insulated  
    isolated, 0-5  
Isolated, 0-6  
Isolated Trigger Probe, 2-19, 8-10  
Isolated Triggering, 2-19  
ITP120, 2-19, 8-10

—K—

K-factor, 3-1, 3-5

—L—

Language, 9-2  
Level, 2-17

—M—

Maintenance, 8-1  
Making Measurements, 2-4  
Manual, 8-9  
Manual Override, 10-4  
Manual Ranges, 2-10  
**Max. Floating Voltage**, 0-6, 10-2, 10-11  
Max. Input Voltage, 10-2, 10-11  
**Max. Input Voltages**, 0-6  
Maximum (MAX) Reading, 5-3  
Measurement Category III, 0-6  
Measurement Connections, 1-5  
Measurements, 2-4  
Mechanical, 10-10  
mechanical damage, 0-5  
Memory, 10-10  
Menu Area, 2-2  
Meter A Measurement, 2-6  
Meter B Measurement, 2-6  
Min Max Reading, 5-3  
Multimeter Disturbance, 10-14

—N—

Ni-MH Battery Pack, 0-2, 8-2

—O—

OC4USB, 3, 8-10  
Ohm ( $\Omega$ ), 9-6, 10-7  
Operating Time, 10-10  
Optical Interface, 1, 3, 10-10

—P—

PAC91, 8-10  
Parallel Print Cable, 8-10  
Parallel Printer, 2  
Parts, 8-7  
Peak, 10-5  
Performance Characteristics, 10-1  
Phase, 10-6  
PM8907, 8-8  
PM8918 Probe, 10-2  
PM9080, 1, 8-10  
Polarity, 2-16  
Positioning the Waveform, 2-11  
Power Adapter, 8-8, 9-4  
Power Down Timer, 9-4  
**Power Measurement**, 10-6  
Powering the Test Tool, 1-1  
Print Cable, 8-10  
Printing, 1  
Printing Errors, 9-7  
Probe, 8-5, 8-8, 10-2

Probe 10  
1, 2-25  
Probe Adjustment, 2-25  
Probe Attenuation, 2-25  
Probe Settings, 1-6  
Pulse Width, 10-5

## —R—

Reading Area, 2-2, 2-4  
Reading the Screen, 2-2  
Recalibrating, 8-7  
Recalling Data Sets, 6-3  
Record a Waveform, 2-13  
Recording Slow Signals, 2-15  
recycling information, 0-4  
Red INPUT A, 1-5  
Refreshing the Batteries, 8-7  
Relative Measurements, 2-9  
Renaming Data Sets, 6-3  
Replaceable Parts, 8-7  
Replacing Batteries, 8-4  
Resetting the Test Tool, 1-2  
Reversing the Polarity, 2-16  
Rise Time, 10-2  
**Rise Time Measurements**, 2-24  
**RMS Voltages**, 10-4  
Roll Mode Function, 2-15

**RPM**, 10-5  
RS-232 Adapter/Cable, 1, 8-10  
RS-232 Communication Errors, 9-7  
RS-232/USB Adapter/Cable, 3

## —S—

**Safety**, 10-11  
Safety Characteristics, 10-1  
Safety Precautions, 0-4  
Safety Requirements, 0-1  
Sampling Rate, 10-3  
Saving Data Sets, 6-1  
SCC 120, 3, 8-10  
Scope Modes, 10-3  
Scope Probes, 8-8  
Scope/Meter Mode, 2-1  
Sensitivity, 10-2  
Serial Printer, 2  
Service Manual, 8-7  
Shielded Test Leads, 8-8  
Shock, 10-11  
Single Shot, 2-14  
Slope, 2-17, 10-3  
Slow Signals, 2-15  
Smooth, 2-12, 10-4  
Software, 8-10  
Software Version, 8-7

Specifications, 10-1  
Stable Reading, 2-8  
Stand, 9-1  
STL120 Test Leads, 8-8  
Storing, 8-1  
SW90W Software, 3, 8-10

## —T—

Temperature Measurement, 10-6  
Temperature, Environmental, 10-11  
Test Leads, 8-8  
Test Limits, 4-8, 4-9  
THD, 3-1, 3-5  
Tilt Stand, 9-1  
Time, 9-3  
Time Base, 2-10  
Time Base Accuracy, 10-3  
Time Base Ranges, 10-3  
time measurement, 2-23  
TL75, 8-9  
Touch Hold<sup>®</sup> function, 2-8, 10-8  
Trace Disturbance, 10-13  
TrendPlot™ function, 10-8  
TrendPlot™ Function, 5-1  
Trigger, 10-3  
Trigger Icons, 2-17  
Trigger Level, 2-17

Trigger Parameters, 2-18  
Trigger Sensitivity, 10-3  
Triggering, 2-17  
**True RMS Voltages**, 10-4

**—Z—**

Zero Reference, 2-9

**—U—**

Unpacking, 0-2  
USB Adapter/Cable, 8-10  
User Manual, 8-9  
Using a Printer, 1  
Using FlukeView Software, 3

**—V—**

Vertical Accuracy, 10-2  
Vertical Cursors, 2-23  
Vibration, 10-11  
Video Line, 2-21  
Video on A, 10-3  
Video Signals, 2-20  
VP40 Probe, 2-25  
VPS40 Probe Set, 8-8  
**Vpwm Measurement**, 10-6

**—W—**

**Warning**, 0-4  
Waveform Area, 2-2

