

FLUKE®

1507/1503

Insulation Testers

Users Manual



Tequipment
.NET

USA

205 Westwood Ave
Long Branch, NJ 07740
1-877-742-TEST (8378)
Fax: (732) 222-7088
salesteam@Tequipment.NET

June 2005

© 2005 Fluke Corporation. All rights reserved.

All product names are trademarks of their respective companies.

LIMITED WARRANTY AND LIMITATION OF LIABILITY

Each Fluke product is warranted to be free from defects in material and workmanship under normal use and service. The warranty period is one year and begins on the date of shipment. Parts, product repairs, and services are warranted for 90 days. This warranty extends only to the original buyer or end-user customer of a Fluke authorized reseller, and does not apply to fuses, disposable batteries, or to any product which, in Fluke's opinion, has been misused, altered, neglected, contaminated, or damaged by accident or abnormal conditions of operation or handling. Fluke warrants that software will operate substantially in accordance with its functional specifications for 90 days and that it has been properly recorded on non-defective media. Fluke does not warrant that software will be error free or operate without interruption.

Fluke authorized resellers shall extend this warranty on new and unused products to end-user customers only but have no authority to extend a greater or different warranty on behalf of Fluke. Warranty support is available only if product is purchased through a Fluke authorized sales outlet or Buyer has paid the applicable international price. Fluke reserves the right to invoice Buyer for importation costs of repair/replacement parts when product purchased in one country is submitted for repair in another country.

Fluke's warranty obligation is limited, at Fluke's option, to refund of the purchase price, free of charge repair, or replacement of a defective product which is returned to a Fluke authorized service center within the warranty period.

To obtain warranty service, contact your nearest Fluke authorized service center to obtain return authorization information, then send the product to that service center, with a description of the difficulty, postage and insurance prepaid (FOB Destination). Fluke assumes no risk for damage in transit. Following warranty repair, the product will be returned to Buyer, transportation prepaid (FOB Destination). If Fluke determines that failure was caused by neglect, misuse, contamination, alteration, accident, or abnormal condition of operation or handling, including overvoltage failures caused by use outside the product's specified rating, or normal wear and tear of mechanical components, Fluke will provide an estimate of repair costs and obtain authorization before commencing the work. Following repair, the product will be returned to the Buyer transportation prepaid and the Buyer will be billed for the repair and return transportation charges (FOB Shipping Point).

THIS WARRANTY IS BUYER'S SOLE AND EXCLUSIVE REMEDY AND IS IN LIEU OF ALL OTHER WARRANTIES, EXPRESS OR IMPLIED, INCLUDING BUT NOT LIMITED TO ANY IMPLIED WARRANTY OF MERCHANTABILITY OR FITNESS FOR A PARTICULAR PURPOSE. FLUKE SHALL NOT BE LIABLE FOR ANY SPECIAL, INDIRECT, INCIDENTAL, OR CONSEQUENTIAL DAMAGES OR LOSSES, INCLUDING LOSS OF DATA, ARISING FROM ANY CAUSE OR THEORY.

Since some countries or states do not allow limitation of the term of an implied warranty, or exclusion or limitation of incidental or consequential damages, the limitations and exclusions of this warranty may not apply to every buyer. If any provision of this Warranty is held invalid or unenforceable by a court or other decision-maker of competent jurisdiction, such holding will not affect the validity or enforceability of any other provision.

Fluke Corporation
P.O. Box 9090
Everett, WA 98206-9090
U.S.A.

Fluke Europe B.V.
P.O. Box 1186
5602 BD Eindhoven
The Netherlands

11/99

To register your product online, visit register.fluke.com

Table of Contents

Title	Page
Introduction	1
Contacting Fluke	1
Safety Information	2
Unsafe Voltage.....	4
Battery Saver (Sleep Mode)	4
Rotary Switch Positions.....	4
Buttons and Indicators.....	5
Understanding the Display	7
Input Terminals.....	9
Power-Up Options	9
Making Measurements	10
Measuring Volts.....	11
Measuring Earth-Bond Resistance	11
Measuring Insulation Resistance.....	13
Measuring Polarization Index and Dielectric Absorption Ratios (Model 1507)	14
Using the Compare Function (Model 1507).....	16
Cleaning	17

Testing the Batteries	17
Testing the Fuse	18
Replacing the Batteries and Fuse	19
Specifications.....	20
General Specifications	20
AC/DC Voltage Measurement	21
Earth-bond Resistance Measurement.....	22
Insulation Specifications.....	22
Model 1507	23
Model 1503	24
EN61557 Specification	24
Insulation Resistance Maximum and Minimum Display Values.....	26
Earth-Bond Resistance Maximum Display Values	30

List of Tables

Table	Title	Page
1.	Symbols.....	3
2.	Rotary Switch Selections.....	5
3.	Buttons and Indicators.....	6
4.	Display Indicators.....	7
5.	Error Messages.....	8
6.	Input Terminal Descriptions.....	9
7.	Power-Up Options.....	10

List of Figures

Figure	Title	Page
1.	Rotary Switch	4
2.	Buttons and Indicators.....	5
3.	Display Indicators	7
4.	Input Terminals.....	9
5.	Measuring Volts.....	11
6.	Measuring Earth-bond Resistance	12
7.	Measuring Insulation Resistance.....	14
8.	Measuring Polarization Index and Dielectric Absorption Ratios	16
9.	Using the Compare Function.....	17
8.	Testing the Fuse.....	18
9.	Replacing the Fuse and Battery	19

1507/1503 Insulation Testers

Introduction

The Fluke model 1507 and model 1503 are battery-powered insulation testers (hereafter, "the Tester"). Although this manual describes the operation of both Models 1507 and 1503, all illustrations and examples assume use of model 1507.

These Testers meet CAT IV IEC 61010 standards. The IEC 61010 standard defines four measurement categories (CAT I to IV) based on the magnitude of danger from transient impulses. CAT IV Testers are designed to protect against transients from the primary supply level (overhead or underground utility service).

The Tester measures or tests the following:

- AC / DC Voltage
- Insulation Resistance
- Earth-Bond Resistance

Contacting Fluke

To contact Fluke, call:

1-888-993-5853 in USA

1-800-363-5853 in Canada

+31-402-678-200 in Europe

+81-3-3434-0181 in Japan

+65-738-5655 in Singapore

+1-425-446-5500 from anywhere in the world

Visit Fluke's web site at: www.fluke.com

Register your Tester at: register.fluke.com

Safety Information

Use the Tester only as specified in this manual. Otherwise, the protection provided by the Tester may be impaired. See Table 1 for a list of symbols used on the Tester and in this manual.

A **⚠⚠ Warning** identifies hazardous conditions and actions that could cause bodily harm or death.

A **⚠⚠ Caution** identifies conditions and actions that could damage the Tester, the equipment under test, or cause permanent loss of data.









⚠⚠ Warning

To avoid possible electric shock or personal injury, follow these guidelines:

- Use the Tester only as specified in this manual or the protection provided by the Tester might be impaired.
- Do not use the Tester or test leads if they appear damaged, or if the Tester is not operating properly. If in doubt, have the Tester serviced.
- Always use the proper terminal, switch position, and range for measurements before connecting Tester to circuit under test.
- Verify the Tester's operation by measuring a known voltage.
- Do not apply more than the rated voltage as marked on the Tester, between the terminals or between any terminal and earth ground.
- Use caution with voltages above 30 V ac rms, 42 V ac peak, or 60 V dc. These voltages pose a shock hazard.
- Replace the battery as soon as the low battery indicator () appears.
- Disconnect circuit power and discharge all high-voltage capacitors before testing resistance, continuity, diodes, or capacitance.
- Do not use the Tester around explosive gas or vapor.
- When using the test leads, keep your fingers behind the finger guards.

- Remove test leads from the Tester before opening the Tester case or battery door. Never operate the Tester with the cover removed or the battery door open.
- Comply with local and national safety requirements when working in hazardous locations.
- Use proper protective equipment, as required by local or national authorities when working in hazardous areas.
- Avoid working alone.
- Use only the replacement fuse specified or the protection may be impaired.
- Check the test leads for continuity before use. Do not use if the readings are high or noisy.

Table 1. Symbols

	AC (Alternating Current)		Earth Ground
	DC (Direct Current)		Fuse
	WARNING: risk of electric shock		Double Insulated
	Battery (Low battery when shown on display)		Important information; see manual

Unsafe Voltage

To alert you to the presence of a potentially hazardous voltage, when the Tester detects a voltage ≥ 30 V in insulation test, ≥ 2 V in resistance, or a voltage overload (OL), the f symbol is displayed.

Battery Saver (Sleep Mode)

The Tester enters the "Sleep mode" and blanks the display if there is no function change or button press for 10 minutes. This is done to conserve battery power. The Tester comes out of Sleep mode when a key is pressed or when the rotary switch is turned.

The 10 minute timer is disabled during any insulation resistance or earth bond resistance measurement. The time period starts immediately following any measurement.

Rotary Switch Positions

Turn the Tester on by selecting any measurement function. The Tester presents a standard display for that function (range, measurement units, modifiers, etc.). Use the blue button to select any rotary switch alternate functions (labelled with blue letters). Rotary switch selections are shown in Figure 1 and described in Table 2.

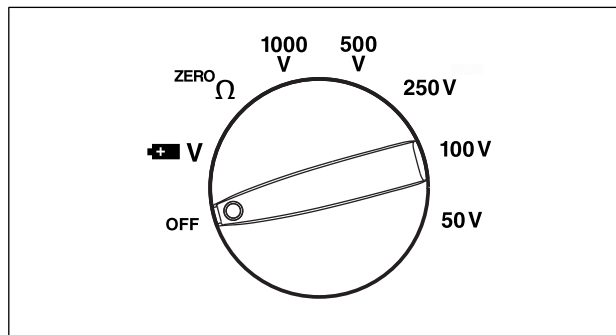

bbw03f.eps

Figure 1. Rotary Switch

Table 2. Rotary Switch Selections

Switch Position	Measurement Function
 V	AC or DC voltage from 0.1 V to 600.0 V.
ZERO Ω	Ohms from 0.01 Ω to 20.00 k Ω .
1000 V 500 V 250V 100V 50V	Ohms from 0.01 M Ω to 10.0 G Ω for the Model 1507 and 0.01 to 2000 M Ω for the Model 1503. Performs insulation tests with 50, 100, 250, 500 and 1000 V source on the 1507 or 500 and 1000 V source on the 1503.

Buttons and Indicators



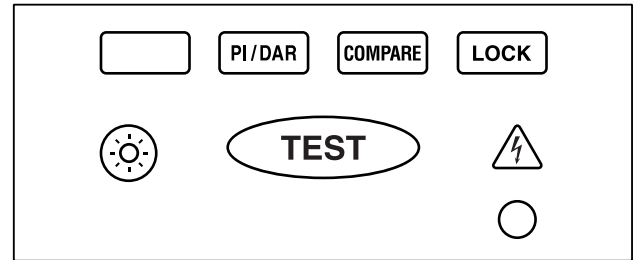

Use the buttons to activate features that augment the function selected with the rotary switch. There are also two indicators on the front of the Tester which light up when active. The buttons and indicators are shown in Figure 2 and described in Table 3.





bbw02f.eps

Figure 2. Buttons and Indicators

Table 3. Buttons and Indicators

Button/ Indicator	Description
	Press the blue button to select alternate measurement functions.
	Press to configure the Tester for a polarization index or dielectric absorption ratio test. The test will start when you press the TEST button.
	Sets a pass/fail limit for insulation tests.
	Test lock. When pressed before the TEST button, the test remains active until you press the lock or test button again to release the lock.
	Turns the backlight on and off. The backlight goes off after 2 minutes.

Button/ Indicator	Description
	Initiates an insulation test when the rotary switch is in an INSULATION position. Causes the Tester to source (output) a high voltage and measure insulation resistance. Initiates a resistance test when the rotary switch is in the ohms position.
	Unsafe voltage warning. Indicates 30 V or greater (ac or dc depending on the rotary switch position) is detected on the input. Also appears when the display shows OL in the + V switch positions, and when batt appears on the display. The ⚡ also appears when insulation test is active.
	Pass indicator. Indicates when the insulation resistance measurement is greater than the selected compare limit.

Understanding the Display

Display indicators are shown in Figure 3 and described in Table 4. Error messages that may appear on the display are described in Table 5.

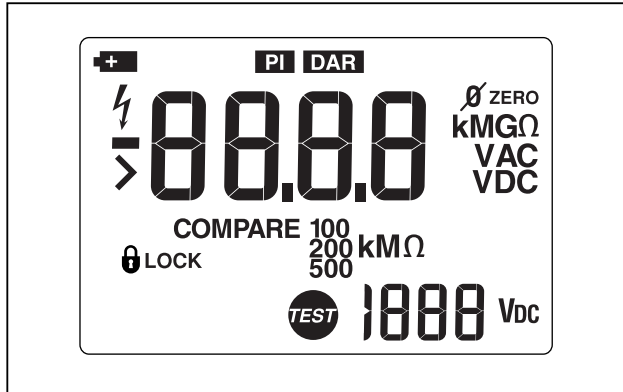

bbw01f.eps

Figure 3. Display Indicators

Table 4. Display Indicators

Indicator	Description
🔒 LOCK	Indicates an insulation or resistance test is locked on.
- >	Minus or greater than symbols
⚡	Unsafe voltage warning.
+	<p>Low battery. Indicates when it is time to replace the battery. When + is on, the backlight button is disabled to conserve battery life.</p> <p style="text-align: center;">⚠️ ⚠️ Warning</p> <p>To avoid false readings, which could lead to possible electric shock or personal injury, replace the battery as soon as the low battery indicator appears.</p>

Table 4 Display Indicators (cont.)

Indicator	Description
PI DAR	Polarization index or dielectric absorption ratio test is selected
ZERO	Ohms lead zero is active.
VAC, VDC, Ω, kΩ, MΩ, GΩ	Measurement units
88.88	Primary display
V_{DC}	Volts
1888	Secondary display
COMPARE	Indicates selected pass/fail compare value.
TEST	Insulation test indicator. Appears when insulation test voltage is present.

Table 5. Error Messages

Message	Description
batt	Appears on the primary display and indicates that the battery is too low for reliable operation. The Tester will not operate at all until the battery is replaced. The + also appears when batt is on the primary display.
>	Indicates an out of range value.
[CAL Err	Invalid calibration data. Calibrate the Tester.

Input Terminals

Input terminals are shown in Figure 4 and described in Table 6.

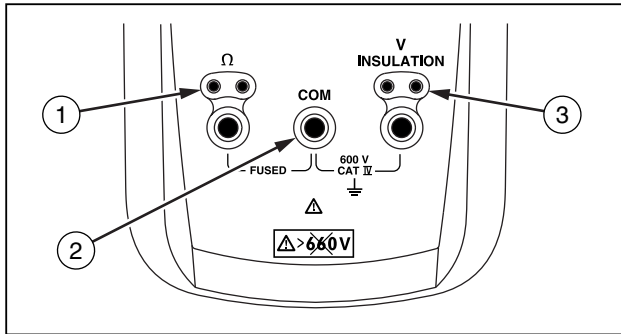

bbw08f.eps

Figure 4. Input Terminals



Table 6. Input Terminal Descriptions

Item	Description
①	Input terminal for resistance measurement.
②	Common (return) terminal for all measurements.
③	Input terminal for volts or insulation test.

Power-Up Options

Holding a button down while turning the Tester on activates a power-up option. Power-up options allow you to use additional features and functions of the Tester. To select a power-up option, hold down the appropriate button indicated while turning the Tester from **OFF** to any switch position. Power-up options are cancelled when the Tester is turned **OFF**. Power-up options are described in Table 7.

Table 7. Power-Up Options

Button	Description
	<p>+ V switch position turns on all LCD segments.</p> <p>^{ZERO}Ω switch position displays the software version number.</p> <p>¹⁰⁰⁰_V switch position displays the model number.</p>
	Starts the Calibration mode. The Tester displays $\square RL$ and enters Calibration mode when the button is released.

Note

Power Up options are active when the button is pressed.

Making Measurements

The figures on the following pages show how to make measurements.

When connecting the test leads to the circuit or device, connect the common (**COM**) test lead before connecting the live lead; when removing the test leads, remove the live lead before removing the common test lead.

⚠ ⚠ Warning

To avoid electric shock, injury, or damage to the Tester, disconnect circuit power and discharge all high-voltage capacitors before testing.

Measuring Volts

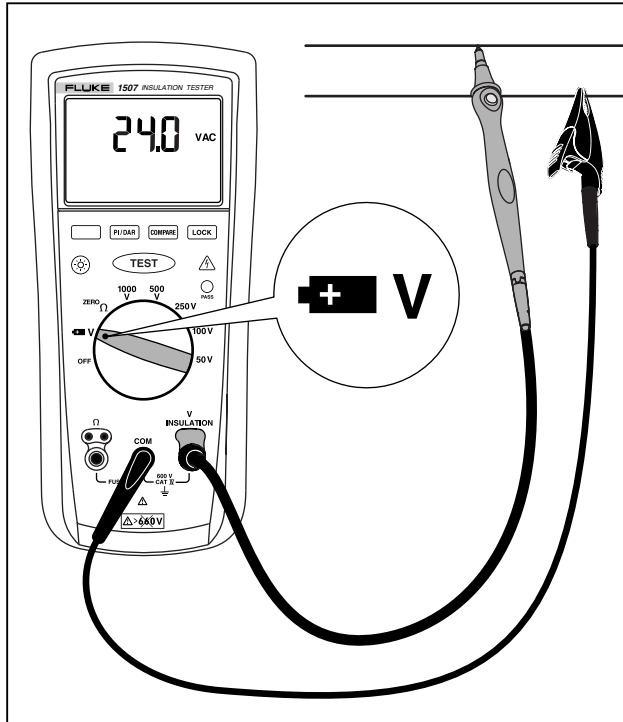

bbw09f.eps

Figure 5. Measuring Volts

Measuring Earth-Bond Resistance

Resistance tests should only be performed on de-energized circuits. Check the fuse before testing. See Testing the Fuse later in this manual. Connecting to an energized circuit while the test is active will blow the fuse.

Note

Measurements can be adversely affected by impedances of additional operating circuits connected in parallel or by transient currents.

To measure resistance:

1. Insert test probes in the Ω and com input terminals.
2. Turn the rotary switch to the $\text{ZERO } \Omega$ position.
3. Short the ends of the probes together, press the blue button and wait until dashes appear on the display. The Tester measures the probe resistance, stores the reading in memory, and subtracts it from readings. The probe resistance reading is saved even when the Tester is turned off. If the probe resistance is $>2 \Omega$, the resistance will not be saved.
4. Connect the probes to the circuit to be measured. The Tester automatically detects if the circuit is energized.

- The primary display shows ---- until you press the **TEST** button and a valid resistance reading is obtained.
 - The high voltage symbol (⚡) along with a primary display of >2 V warns if voltage greater than 2 V ac or dc is present. In this condition, the test is inhibited. Disconnect the Tester and remove power before proceeding.
 - If the Tester chirps when you press the **TEST** button, the test is inhibited because voltage is present at the probes.
5. Push and hold the **TEST** button to start the test. The **TEST** icon appears on the lower portion of the display until you release the **TEST** button. The resistance reading appears on the primary display until a new test is started or a different function or range is selected.

When resistance is higher than the maximum display range, the Tester displays the $>$ symbol and the maximum resistance for the range.

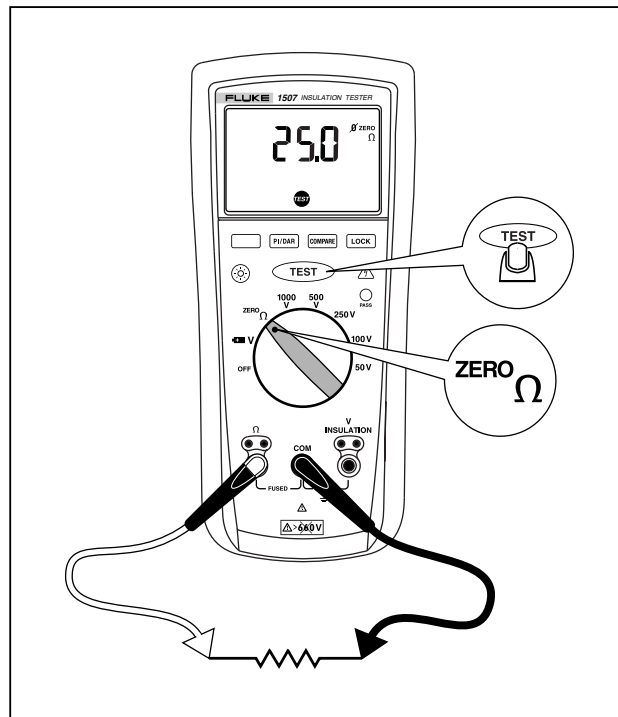

bbw04f.eps

Figure 6. Measuring Earth-Bond Resistance

Measuring Insulation Resistance

Insulation tests should only be performed on de-energized circuits. To measure insulation resistance set up the Tester as shown in Figure 7 and follow the steps below:

1. Insert test probes in the **v** and **com** input terminals.
2. Turn the rotary switch to the desired test voltage.
3. Connect the probes to the circuit to be measured. The Tester automatically detects if the circuit is energized.
 - The primary display shows - - - - until you press **TEST** and a valid insulation resistance reading is obtained.
 - The high voltage symbol (⚡) along with a primary display of >30 V warns if voltage more than 30 V ac or dc is present. In this condition, the test is inhibited. Disconnect the Tester and remove power before proceeding.
4. Push and hold **TEST** to start the test. The secondary display shows the test voltage applied to the circuit under test. The high voltage symbol (⚡) along with a primary display showing the resistance in $\text{M}\Omega$ or $\text{G}\Omega$ appears. The **TEST** icon appears on the lower portion of the display until **TEST** is released.

When resistance is higher than the maximum display range, the Tester displays the > symbol and the maximum resistance for the range.
5. Keep the probes on the test points and release the **TEST** button. The circuit under test then discharges through the Tester. The resistance reading appears on the primary display until a new test is started or a different function or range is selected or > 30 V is detected.

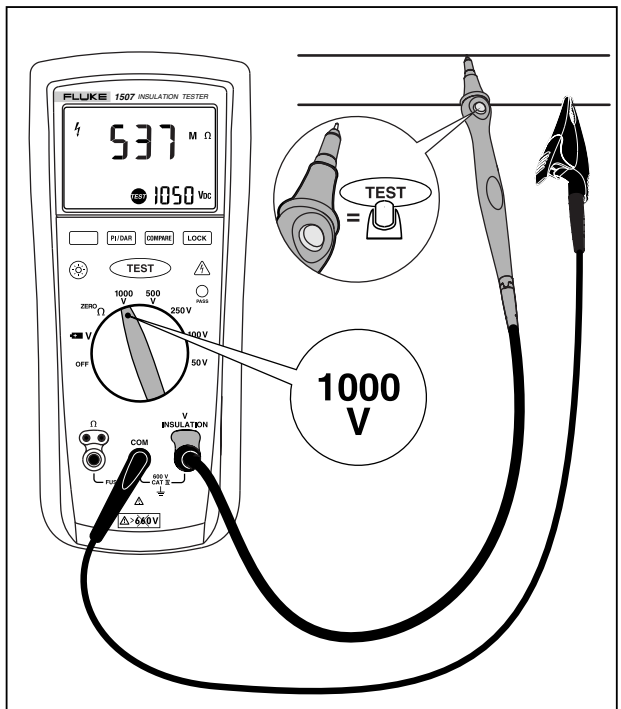

Figure 7. Measuring Insulation Resistance

Measuring Polarization Index and Dielectric Absorption Ratios (Model 1507)

Polarization Index (PI) is the ratio of the 10-minute insulation resistance to the 1 minute insulation resistance. Dielectric Absorption Ratio (DAR) is the ratio of the 1-minute insulation resistance to the 30 second insulation resistance.

Insulation tests should only be performed on de-energized circuits. To measure the polarization index or dielectric absorption ratio:

1. Insert test probes in the INSULATION and COM input terminals.

Note

Because of the time required to perform the PI and DAR tests, use of test clips is recommended.

2. Turn the rotary switch to the desired test voltage position.
3. Press the **PI/DAR** button to select polarization index or dielectric absorption ratio.
4. Connect the probes to the circuit to be measured. The Tester automatically detects if the circuit is energized.

- The primary display shows ---- until you press the **TEST** button and a valid resistance reading is obtained.
 - The high voltage symbol (f) along with a primary display of >30 V warns if voltage greater than 30 V ac or dc is present. If high voltage is present, the test is inhibited.
5. Press and release **TEST** to start the test. During testing, the secondary display shows the test voltage applied to the circuit under test. The high voltage symbol (f) along with a primary display showing the resistance in M Ω or G Ω . The **TEST** icon appears on the lower portion of the display until the test is finished.

When the test is completed, the PI or DAR value is displayed on the primary display. The circuit under test will automatically be discharged through the Tester. If either value used to calculate PI or DAR was greater than the maximum display range, or the 1-minute value was greater than 5000 M Ω , the primary display will show Err.

- When resistance is higher than the maximum display range, the Tester displays the > symbol and the maximum resistance for the range.

- To interrupt a PI or DAR test before it is completed, momentarily press **TEST**. When you release **TEST**, the circuit under test will automatically be discharged through the Tester.

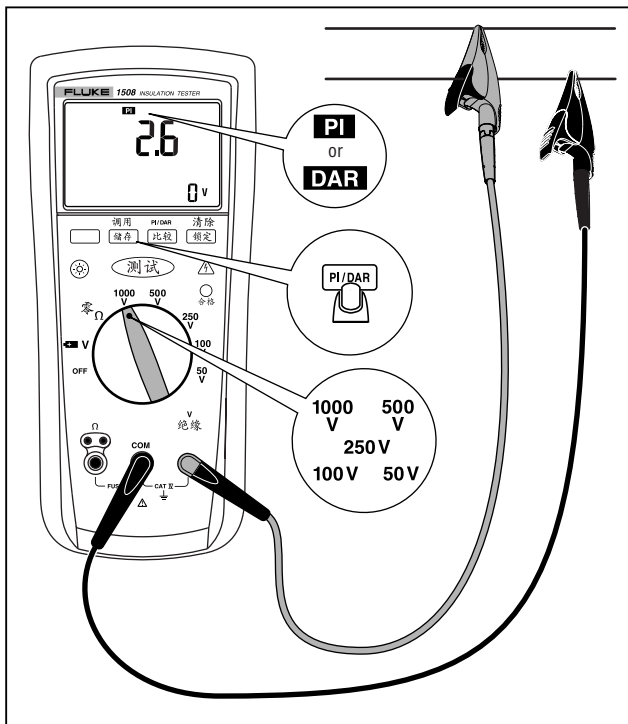

bbw10f.eps

Figure 8. Measuring Polarization Index and Dielectric Absorption Ratios

Using the Compare Function (Model 1507)

Use the Compare function to set a pass/fail compare level for the insulation measurements. To use the Compare function:

1. Press the **COMPARE** button to select the desired compare value. You can choose from 100 k Ω , 200 k Ω , 500 k Ω , 1 M Ω , 2 M Ω , 5 M Ω , 10 M Ω , 20 M Ω , 50 M Ω , 100 M Ω , 200 M Ω , and 500 M Ω .
2. Perform insulation tests as described earlier in this manual.
3. The green pass indicator will appear if the measured value is greater than the selected value.
4. Press and hold the **COMPARE** button for 1 second to disable the Compare function. The pass indicator will turn off when you start a new test or choose a new compare value.

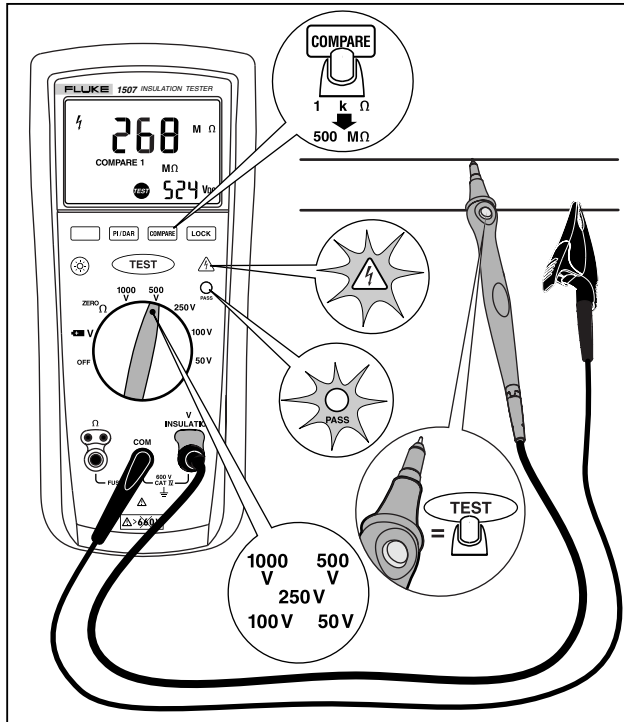

bbw11f.eps

Figure 9. Using the Compare Function

Cleaning

Periodically wipe the case with a damp cloth and mild detergent. Do not use abrasives or solvents. Dirt or moisture in the terminals can affect readings. Allow time for drying before using the Tester.

Testing the Batteries

The Tester continuously monitors battery voltage. If the low battery icon (⚡) appears on the display, there is minimal battery life left. To test the batteries:

1. Turn the rotary switch to the **+ V** position with no probes inserted.
2. Press the blue button to initiate the fully loaded battery test. The voltage function displays clear and the measured battery voltage is shown in the primary display for 2 seconds, the voltage display then returns.

Testing the Fuse

⚠⚠ Warning

To avoid electrical shock or injury, remove the test leads and any input signals before replacing the fuse.

Test the fuse as described below and shown in Figure 10. Replace the fuse as shown in Figure 11.

1. Turn the rotary switch to the $\text{ZERO } \Omega$ position.
2. Press and hold **TEST**. If the display reading is **FUSE**, the fuse is bad and should be replaced.

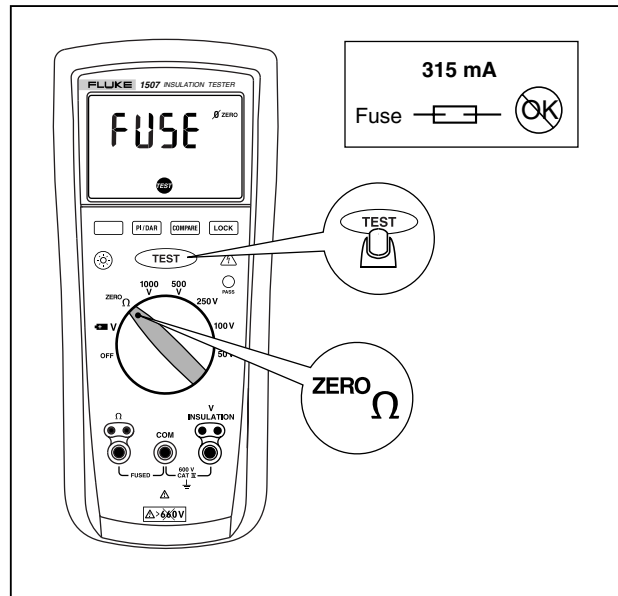

Figure 10. Testing the Fuse

bbw06f.eps

Replacing the Batteries and Fuse

Replace the fuse and batteries as shown in Figure 11. Follow the steps below to replace the batteries.

⚠ ⚠ Warning

To avoid shock, injury, or damage to the Tester:

- **To avoid false readings, which could lead to possible electric shock or personal injury, replace the batteries as soon as the battery indicator (🔋) appears.**
- **Use ONLY fuses with the amperage, interrupt, voltage, and speed ratings specified.**
- **Turn the rotary switch to OFF and remove the test leads from the terminals.**

1. Remove the battery door by using a standard screwdriver to turn the battery door lock until the unlock symbol aligns with the arrow.
2. Remove and replace the batteries.
3. Replace the battery door and secure by turning the battery door lock until the lock symbol aligns with the arrow.

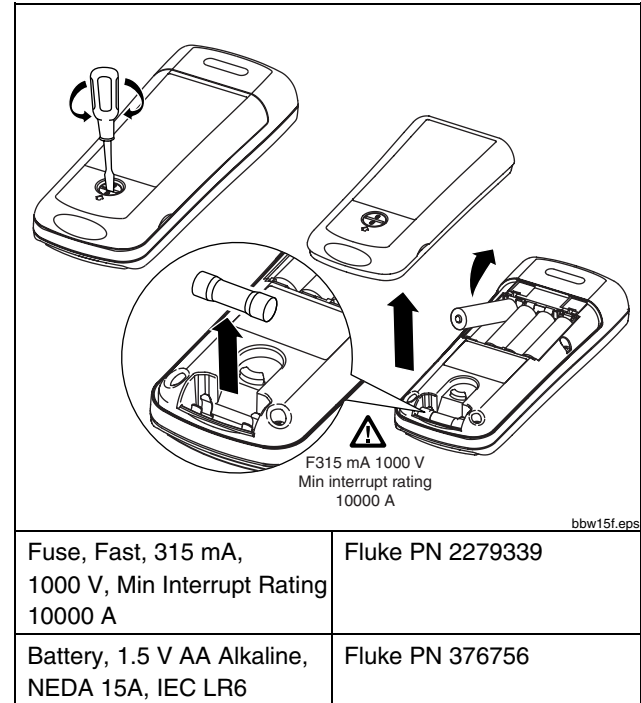

Figure 11. Replacing the Fuse and Battery

Specifications

General Specifications

Maximum Voltage Applied to any Terminal	600 V ac rms or dc
Storage Temperature	-40 °C to 60 °C (-40 °F to 140 °F)
Operating Temperature.....	-20 °C to 55 °C (-4 °F to 131 °F)
Temperature Coefficient.....	0.05 x (specified accuracy) per °C for temperatures < 18 °C or > 28 °C (< 64 °F or > 82 °F)
Relative Humidity	Noncondensing 0 % to 95 % @ 10 °C to 30 °C (50 °F to 86 °F) 0 % to 75 % @ 30 °C to 40 °C (86 °F to 104 °F) 0 % to 40 % @ 40 °C to 55 °C (104 °F to 131 °F)
Vibration	Random, 2 g, 5-500 Hz per MIL-PRF-28800F, Class 2 instrument
Shock	1 meter drop per IEC 61010-1 2 nd Edition (1 meter drop test, six sides, oak floor)
Electromagnetic Compatibility.....	In an RF field of 3 V/M, accuracy = specified accuracy (EN 61326-1:1997).
Safety	Complies with ANSI/ISA 82.02.01 (61010-1) 2004, CAN/CSA-C22.2 NO. 61010-1-04, and IEC/EN 61010-1 2 nd Edition for measurement category IV 600 V (CAT IV)
Certifications	CSA per standard CSA/CAN C22.2 No. 61010.1-04; TUV per standard IEC/EN 61010-1 2 nd Edition
Batteries	Four AA batteries (NEDA 15A or IEC LR6)
Battery Life	Insulation test use: Tester can perform at least 1000 insulation tests with fresh alkaline batteries at room temperature. These are standard tests of 1000 V into 1 M Ω with a duty cycle of 5 seconds on and 25 seconds off. Resistance Measurements: Tester can perform at least 2500 earth-bond resistance measurements with fresh alkaline batteries at room temperature. These are standard tests of 1 Ω with a duty cycle of 5 seconds on and 25 seconds off.
Size	5.0 cm H x 10.0 cm W x 20.3 cm L (1.97 in H x 3.94 in W x 8.00 in L)
Weight.....	550 g (1.2 lb.)

Earth-bond Resistance Measurement

Range	Resolution	Accuracy ¹ ± (% of Rdg + Digits)
20.00 Ω	0.01 Ω	± (1.5 % + 3)
200.0 Ω	0.1 Ω	
2000 Ω	1 Ω	
20.00 kΩ	0.01 kΩ	
1. Accuracies apply from 0 to 100% of range.		

Overload Protection2 V rms or dc
 Open Circuit Test Voltage> 4.0 V, < 8 V
 Short Circuit Current> 200.0 mA

Insulation Specifications

Measurement Range.....0.01 MΩ to 10 GΩ model 1507, 0.01 MΩ to 2000 MΩ model 1503
 Test Voltages50, 100, 250, 500, 1000 V model 1507, 500 and 1000 V model 1503
 Test Voltage Accuracy+ 20 %, - 0 %
 Short-Circuit Test Current1 mA nominal
 Auto Discharge.....Discharge time <0.5 second for C = 1 μF or less
 Live Circuit Detection:Inhibit test if terminal voltage > 30 V prior to initialization of test.
 Maximum Capacitive Load.....Operable with up to 1 μF load.

Model 1507

Output Voltage	Display Range	Resolution	Test Current	Accuracy ± (% of Rdg + Digits)
50 V (0 % to + 20 %)	0.01 to 20.00 MΩ	0.01 MΩ	1 mA @ 50 kΩ	± (3 % + 5)
	20.0 to 50.0 MΩ	0.1 MΩ		
100 V (0 % to + 20 %)	0.01 to 20.00 MΩ	0.01 MΩ	1 mA @ 100 kΩ	± (3 % + 5)
	20.0 to 100.0 MΩ	0.1 MΩ		
250 V (0 % to + 20 %)	0.01 to 20.00 MΩ	0.01 MΩ	1 mA @ 250 kΩ	± (1.5 % + 5)
	20.0 to 200.0 MΩ	0.1 MΩ		
500 V (0 % to + 20 %)	0.01 to 20.00 MΩ	0.01 MΩ	1 mA @ 500 kΩ	± (1.5 % + 5)
	20.0 to 200.0 MΩ	0.1 MΩ		
	200 to 500 MΩ	1 MΩ		
1000 V (0 % to + 20 %)	0.1 to 200.0 MΩ	0.1 MΩ	1 mA @ 1 MΩ	± (1.5 % + 5)
	200 to 2000 MΩ	1 MΩ		
	2.0 to 10.0 GΩ	0.1 GΩ		± (10 % + 3)

Model 1503

Output Voltage	Display Range	Resolution	Test Current	Accuracy ± (% of Rdg + Digits)
500 V (0 % to + 20 %)	0.1 to 20.00 MΩ	0.01 MΩ	1 mA @ 500 kΩ	± (2.0 % + 5)
	20.0 to 200.0 MΩ	0.1 MΩ		
	200 to 500 MΩ	1 MΩ		
1000 V (0 % to + 20 %)	0.1 to 200.0 MΩ	0.1 MΩ	1 mA @ 1 MΩ	± (2.0 % + 5)
	200 to 2000 MΩ	1 MΩ		

EN61557 Specification

The following tables are a requirement for European labeling.

Measurement	Intrinsic Uncertainty	Operating Uncertainty ¹
Volts	± (2.0 % + 3)	30 %
Earth-Bond Resistance	± (1.5 % + 3)	30 %
Insulation Resistance	Depends on test voltage and range. See Insulation Test specifications.	30 %

1. This specification comes from the standard and indicates the maximum amount allowable by the standard.

EN61557 Influence Variables and Uncertainties

Earth-Bond Resistance Influence Variable	Designation per EN61557	Uncertainty for Insulation Resistance ¹	Uncertainty for Earth-Bond Resistance ¹
Supply Voltage	E2	5 %	5 %
Temperature	E3	5 %	5 %
1. Specification confidence level 99 %.			

The following tables can be used to determine the maximum or minimum display values considering maximum instrument operating error per EN61557-1, 5.2.4.

Insulation Resistance Maximum and Minimum Display Values

50 V		100 V		250 V		500 V		1000 V	
Limit Value	Minimum Display Value	Limit Value	Minimum Display Value	Limit Value	Minimum Display Value	Limit Value	Minimum Display Value	Limit Value	Minimum Display Value
0.05	0.07	0.05	0.07	0.05	0.07	0.05	0.07		
0.06	0.08	0.06	0.08	0.06	0.08	0.06	0.08		
0.07	0.09	0.07	0.09	0.07	0.09	0.07	0.09		
0.08	0.10	0.08	0.10	0.08	0.10	0.08	0.10		
0.09	0.12	0.09	0.12	0.09	0.12	0.09	0.12		
0.1	0.13	0.1	0.13	0.1	0.13	0.1	0.13	0.1	0.1
0.2	0.26	0.2	0.26	0.2	0.26	0.2	0.26	0.2	0.3
0.3	0.39	0.3	0.39	0.3	0.39	0.3	0.39	0.3	0.4
0.4	0.52	0.4	0.52	0.4	0.52	0.4	0.52	0.4	0.5
0.5	0.65	0.5	0.65	0.5	0.65	0.5	0.65	0.5	0.7

Insulation Resistance Maximum and Minimum Display Values (cont.)

50 V		100 V		250 V		500 V		1000 V	
Limit Value	Minimum Display Value	Limit Value	Minimum Display Value	Limit Value	Minimum Display Value	Limit Value	Minimum Display Value	Limit Value	Minimum Display Value
0.6	0.78	0.6	0.78	0.6	0.78	0.6	0.78	0.6	0.8
0.7	0.91	0.7	0.91	0.7	0.91	0.7	0.91	0.7	0.9
0.8	1.04	0.8	1.04	0.8	1.04	0.8	1.04	0.8	1.0
0.9	1.17	0.9	1.17	0.9	1.17	0.9	1.17	0.9	1.2
1.0	1.30	1.0	1.30	1.0	1.30	1.0	1.30	1.0	1.3
2.0	2.60	2.0	2.60	2.0	2.60	2.0	2.60	2.0	2.6
3.0	3.90	3.0	3.90	3.0	3.90	3.0	3.90	3.0	3.9
4.0	5.20	4.0	5.20	4.0	5.20	4.0	5.20	4.0	5.2
5.0	6.50	5.0	6.50	5.0	6.50	5.0	6.50	5.0	6.5
6.0	7.80	6.0	7.80	6.0	7.80	6.0	7.80	6.0	7.8

Insulation Resistance Maximum and Minimum Display Values (cont.)

50 V		100 V		250 V		500 V		1000 V	
Limit Value	Minimum Display Value	Limit Value	Minimum Display Value	Limit Value	Minimum Display Value	Limit Value	Minimum Display Value	Limit Value	Minimum Display Value
7.0	9.10	7.0	9.10	7.0	9.10	7.0	9.10	7.0	9.1
8.0	10.40	8.0	10.40	8.0	10.40	8.0	10.40	8.0	10.4
9.0	11.70	9.0	11.70	9.0	11.70	9.0	11.70	9.0	11.7
10.0	13.0	10.0	13.0	10.0	13.0	10.0	13.0	10.0	13.0
20.0	26.0	20.0	26.0	20.0	26.0	20.0	26.0	20.0	26.0
30.0	39.0	30.0	39.0	30.0	39.0	30.0	39.0	30.0	39.0
40.0	52.0	40.0	52.0	40.0	52.0	40.0	52.0	40.0	53.0
		50.0	65.0	50.0	65.0	50.0	65.0	50.0	65.0
		60.0	78.0	60.0	78.0	60.0	78.0	60.0	78.0
		70.0	91.0	70.0	91.0	70.0	91.0	70.0	91.0
		80.0	104.0	80.0	104.0	80.0	104.0	80.0	104.0

Insulation Resistance Maximum and Minimum Display Values (cont.)

50 V		100 V		250 V		500 V		1000 V	
Limit Value	Minimum Display Value	Limit Value	Minimum Display Value	Limit Value	Minimum Display Value	Limit Value	Minimum Display Value	Limit Value	Minimum Display Value
		90.0	117.0	90.0	117.0	90.0	117.0	90.0	117.0
				100.0	130.0	100.0	130.0	100.0	130.0
						200.0	260.0	200.0	260.0
						300.0	390.0	300.0	390.0
						400.0	520.0	400.0	520.0
								500.0	650.0
								600.0	780.0
								700.0	910.0
								800.0	1040.0
								900.0	1170.0
								1000.0	1300.0
								2000.0	2600.0

Earth-Bond Resistance Maximum Display Values

Limit Value	Maximum Display Value	Limit Value	Maximum Display Value	Limit Value	Maximum Display Value
0.4	0.28	7.0	4.9	100.0	70.0
0.5	0.35	8.0	5.6	200.0	140.0
0.6	0.42	9.0	6.3	300.0	210.0
0.7	0.49	10.0	7.0	400.0	280.0
0.8	0.56	20.0	14.0	500.0	350.0
0.9	0.63	30.0	21.0	600.0	420.0
1.0	0.7	40.0	28.0	700.0	490.0
2.0	1.4	50.0	35.0	800.0	560.0
3.0	2.1	60.0	42.0	900.0	630.0
4.0	2.8	70.0	49.0	1000.0	700.0
5.0	3.5	80.0	56.0	2000.0	1400.0
6.0	4.2	90.0	63.0		



205 Westwood Ave
Long Branch, NJ 07740
1-877-742-TEST (8378)
Fax: (732) 222-7088
salesteam@Equipment.NET