

FLUKE®

Tequipment
_____.NET



205 Westwood Ave
Long Branch, NJ 07740
1-877-742-TEST (8378)
Fax: (732) 222-7088
salesteam@Tequipment.NET

1745

Power Quality Logger

Users Manual

PN 2560366

April 2006 Rev.1, 7/06

© 2006 Fluke Corporation, All rights reserved.

All product names are trademarks of their respective companies.

LIMITED WARRANTY AND LIMITATION OF LIABILITY

Each Fluke product is warranted to be free from defects in material and workmanship under normal use and service. The warranty period is two years and begins on the date of shipment. Parts, product repairs, and services are warranted for 90 days. This warranty extends only to the original buyer or end-user customer of a Fluke authorized reseller, and does not apply to fuses, disposable batteries, or to any product which, in Fluke's opinion, has been misused, altered, neglected, contaminated, or damaged by accident or abnormal conditions of operation or handling. Fluke warrants that software will operate substantially in accordance with its functional specifications for 90 days and that it has been properly recorded on non-defective media. Fluke does not warrant that software will be error free or operate without interruption.

Fluke authorized resellers shall extend this warranty on new and unused products to end-user customers only but have no authority to extend a greater or different warranty on behalf of Fluke. Warranty support is available only if product is purchased through a Fluke authorized sales outlet or Buyer has paid the applicable international price. Fluke reserves the right to invoice Buyer for importation costs of repair/replacement parts when product purchased in one country is submitted for repair in another country.

Fluke's warranty obligation is limited, at Fluke's option, to refund of the purchase price, free of charge repair, or replacement of a defective product which is returned to a Fluke authorized service center within the warranty period.

To obtain warranty service, contact your nearest Fluke authorized service center to obtain return authorization information, then send the product to that service center, with a description of the difficulty, postage and insurance prepaid (FOB Destination). Fluke assumes no risk for damage in transit. Following warranty repair, the product will be returned to Buyer, transportation prepaid (FOB Destination). If Fluke determines that failure was caused by neglect, misuse, contamination, alteration, accident, or abnormal condition of operation or handling, including overvoltage failures caused by use outside the product's specified rating, or normal wear and tear of mechanical components, Fluke will provide an estimate of repair costs and obtain authorization before commencing the work. Following repair, the product will be returned to the Buyer transportation prepaid and the Buyer will be billed for the repair and return transportation charges (FOB Shipping Point). THIS WARRANTY IS BUYER'S SOLE AND EXCLUSIVE REMEDY AND IS IN LIEU OF ALL OTHER WARRANTIES, EXPRESS OR IMPLIED, INCLUDING BUT NOT LIMITED TO ANY IMPLIED WARRANTY OF MERCHANTABILITY OR FITNESS FOR A PARTICULAR PURPOSE. FLUKE SHALL NOT BE LIABLE FOR ANY SPECIAL, INDIRECT, INCIDENTAL OR CONSEQUENTIAL DAMAGES OR LOSSES, INCLUDING LOSS OF DATA, ARISING FROM ANY CAUSE OR THEORY.

Since some countries or states do not allow limitation of the term of an implied warranty, or exclusion or limitation of incidental or consequential damages, the limitations and exclusions of this warranty may not apply to every buyer. If any provision of this Warranty is held invalid or unenforceable by a court or other decision-maker of competent jurisdiction, such holding will not affect the validity or enforceability of any other provision.

Fluke Corporation
P.O. Box 9090
Everett, WA 98206-9090
U.S.A.

Fluke Europe B.V.
P.O. Box 1186
5602 BD Eindhoven
The Netherlands

LIMITES DE GARANTIE ET DE RESPONSABILITE

La société Fluke garantit l'absence de vices de matériaux et de fabrication de ses produits dans des conditions normales d'utilisation et d'entretien. La période de garantie est de deux ans et prend effet à la date d'expédition. Les pièces, les réparations de produit et les services sont garantis pendant une période de 90 jours. Cette garantie ne s'applique qu'à l'acheteur d'origine ou à l'utilisateur final s'il est client d'un distributeur agréé par Fluke, et ne s'applique pas aux fusibles, aux batteries/piles interchangeables ni à aucun produit qui, de l'avis de Fluke, a été malmené, modifié, négligé, contaminé ou endommagé par accident ou soumis à des conditions anormales d'utilisation et de manipulation. Fluke garantit que le logiciel fonctionnera en grande partie conformément à ses spécifications fonctionnelles pendant une période de 90 jours et qu'il a été correctement enregistré sur des supports non défectueux. Fluke ne garantit pas que le logiciel est exempt d'erreurs ou qu'il fonctionnera sans interruption.

Les distributeurs agréés par Fluke appliqueront cette garantie à des produits vendus neufs et qui n'ont pas servi, mais ne sont pas autorisés à offrir une garantie plus étendue ou différente au nom de Fluke. Le support de garantie est offert uniquement si le produit a été acquis par l'intermédiaire d'un point de vente agréé par Fluke ou bien si l'acheteur a payé le prix international applicable. Fluke se réserve le droit de facturer à l'acheteur les frais d'importation des pièces de réparation ou de remplacement si le produit acheté dans un pays a été expédié dans un autre pays pour y être réparé.

L'obligation de garantie de Fluke est limitée, au choix de Fluke, au remboursement du prix d'achat, ou à la réparation/remplacement gratuit d'un produit défectueux retourné dans le délai de garantie à un centre de service agréé par Fluke.

Pour avoir recours au service de la garantie, mettez-vous en rapport avec le centre de service agréé Fluke le plus proche pour recevoir les références d'autorisation de renvoi, ou envoyez le produit, accompagné d'une description du problème, port et assurance payés (franco lieu de destination), à ce centre de service. Fluke décline toute responsabilité en cas de dégradations survenues au cours du transport. Après la réparation sous garantie, le produit est renvoyé à l'acheteur, frais de port payés d'avance (franco lieu de destination). Si Fluke estime que le problème est le résultat d'une négligence, d'un traitement abusif, d'une contamination, d'une modification, d'un accident ou de conditions de fonctionnement ou de manipulation anormales, notamment de surtensions liées à une utilisation du produit en dehors des spécifications nominales, ou de l'usure normale des composants mécaniques, Fluke fournira un devis des frais de réparation et ne commencera la réparation qu'après en avoir reçu l'autorisation. Après la réparation, le produit est renvoyé à l'acheteur, en port payé (franco point d'expédition) et les frais de réparation et de transport lui sont facturés.

**LA PRESENTE GARANTIE EST EXCLUSIVE ET TIENT LIEU DE TOUTES AUTRES GARANTIES, EXPRESSES OU IMPLICITES, Y COMPRIS, MAIS NON EXCLUSIVE-
MENT, TOUTE GARANTIE IMPLICITE DE VALEUR MARCHANDE OU D'ADEQUATION
A UN USAGE PARTICULIER. FLUKE NE POURRA ETRE TENU RESPONSABLE
D'AUCUN DOMMAGE PARTICULIER, INDIRECT, ACCIDENTEL OU CONSECUTIF, NI
D'AUCUN DEGAT OU PERTE, DE DONNEES NOTAMMENT, SUR UNE BASE
CONTRACTUELLE, EXTRA-CONTRACTUELLE OU AUTRE.**

Etant donné que certaines juridictions n'admettent pas les limitations d'une condition de garantie implicite, ni l'exclusion ou la limitation des dommages directs ou indirects, il se peut que les limitations et les exclusions de cette garantie ne s'appliquent pas à chaque acheteur. Si une disposition quelconque de cette garantie est jugée non valide ou inapplicable par un tribunal ou un autre pouvoir décisionnel compétent, une telle décision n'affectera en rien la validité ou le caractère exécutoire de toute autre disposition.

Fluke Corporation
P.O. Box 9090
Everett, WA 98206-0777
Etats-Unis

Fluke Europe B.V.
P.O. Box 1186
5602, boul. Eindhoven
Pays-Bas

BESCHRÄNKTE GARANTIE UND HAFTUNGSBEGRENZUNG

Fluke gewährleistet, dass jedes Fluke-Produkt unter normalem Gebrauch und Service frei von Material- und Fertigungsdefekten ist. Die Garantiedauer beträgt zwei Jahre ab Versanddatum. Ersatzteile, Produktreparaturen und Servicearbeiten haben eine Garantie von 90 Tagen. Diese Garantie wird ausschließlich dem Ersterwerber bzw. dem Endverbraucher, der das betreffende Produkt von einer von Fluke autorisierten Verkaufsstelle erworben hat, geleistet und erstreckt sich nicht auf Sicherungen, Einwegbatterien oder irgendwelche anderen Produkte, die nach dem Ermessen von Fluke unsachgemäß verwendet, verändert, vernachlässigt, verunreinigt, durch Unfälle beschädigt oder abnormalen Betriebsbedingungen oder einer unsachgemäßen Handhabung ausgesetzt wurden. Fluke garantiert für einen Zeitraum von 90 Tagen, dass die Software im Wesentlichen in Übereinstimmung mit den einschlägigen Funktionsbeschreibungen funktioniert und dass diese Software auf fehlerfreien Datenträgern gespeichert wurde. Fluke übernimmt jedoch keine Garantie dafür, dass die Software fehlerfrei ist und störungsfrei arbeitet.

Von Fluke autorisierte Verkaufsstellen dürfen diese Garantie ausschließlich für neue und nicht benutzte, an Endverbraucher verkaufte Produkte leisten. Die Verkaufsstellen sind jedoch nicht dazu berechtigt, diese Garantie im Namen von Fluke zu verlängern, auszudehnen oder in irgendeiner anderen Weise abzuändern. Der Käufer hat nur dann das Recht, aus der Garantie abgeleitete Unterstützungsleistungen in Anspruch zu nehmen, wenn das Produkt bei einer von Fluke autorisierten Vertriebsstelle erworben oder der jeweils geltende internationale Preis gezahlt wurde. Fluke behält sich das Recht vor, dem Käufer Einfuhrgebühren für Ersatzteile in Rechnung zu stellen, falls der Käufer das Produkt nicht in dem Land zur Reparatur einsendet, in dem er das Produkt ursprünglich erworben hat.

Die Garantieverpflichtung von Fluke beschränkt sich darauf, dass Fluke nach eigenem Ermessen den Kaufpreis ersetzt oder aber das defekte Produkt unentgeltlich repariert oder austauscht, wenn dieses Produkt innerhalb der Garantiefrist einem von Fluke autorisierten Servicezentrum zur Reparatur übergeben wird.

Um die Garantieleistung in Anspruch zu nehmen, wenden Sie sich bitte an das nächstgelegene von Fluke autorisierte Servicezentrum, um Rücknahmeinformationen zu erhalten, und senden Sie dann das Produkt mit einer Beschreibung des Problems und unter Vorauszahlung von Fracht- und Versicherungskosten (FOB-Bestimmungsort) an das nächstgelegene von Fluke autorisierte Servicezentrum. Fluke übernimmt keine Haftung für Transportschäden. Im Anschluss an die Reparatur wird das Produkt unter Vorauszahlung der Frachtkosten (Frachtfrei-Bestimmungsort) an den Käufer zurückgesandt. Wenn Fluke feststellt, dass der Defekt auf Vernachlässigung, unsachgemäße Handhabung, Verunreinigung, Veränderungen am Gerät, einen Unfall oder auf anormale Betriebsbedingungen, einschließlich durch außerhalb der für das Produkt spezifizierten Belastbarkeit verursachter Überspannungsfehler oder normaler Abnutzung mechanischer Komponenten, zurückzuführen ist, wird Fluke dem Erwerber einen Voranschlag der Reparaturkosten zukommen lassen und erst die Zustimmung des Erwerbers einholen, bevor die Arbeiten in Angriff genommen werden. Nach der Reparatur wird das Produkt unter Vorauszahlung der Frachtkosten an den Käufer zurückgeschickt, und es werden dem Käufer die Reparaturkosten und die Versandkosten (Frachtfrei-Versandort) in Rechnung gestellt.

DIE VORSTEHENDEN GARANTIEBESTIMMUNGEN STELLEN DEN EINZIGEN UND ALLEINIGEN RECHTSANSPRUCH AUF SCHADENERSATZ DES KÄUFERS DAR UND GELTEN AUSSCHLIESSLICH UND AN STELLE ALLER ANDEREN VERTRAGLICHEN ODER GESETZLICHEN GEWÄHRLEISTUNGSPFLICHTEN, EINSCHLIESSLICH - JEDOCH NICHT DARAUF BESCHRÄNKT - DER GESETZLICHEN GEWÄHRLEISTUNG DER MARKTFÄHIGKEIT UND DER EIGNUNG FÜR EINEN BESTIMMTEN ZWECK. FLUKE HAFTET NICHT FÜR SPEZIELLE, UNMITTELBARE, MITTELBARE, BEGLEIT- ODER FOLGESCHÄDEN ODER VERLUSTE, EINSCHLIESSLICH VERLUST VON DATEN, UNABHÄNGIG VON DER URSACHE ODER THEORIE.

In einigen Ländern ist die Begrenzung einer gesetzlichen Gewährleistung und der Ausschluss oder die Begrenzung von Begleit- oder Folgeschäden nicht zulässig, sodass die oben genannten Einschränkungen und Ausschlüsse möglicherweise nicht für jeden Käufer gelten. Sollte eine Klausel dieser Garantiebestimmungen von einem zuständigen Gericht oder einer anderen Entscheidungsinstanz für unwirksam oder nicht durchsetzbar befunden werden, so bleiben die Wirksamkeit oder Durchsetzbarkeit anderer Klauseln dieser Garantiebestimmungen von einem solchen Spruch unberührt.

Fluke Corporation
P.O. Box 9090
Everett, WA 98206-9090
USA

Fluke Europe B.V.
P.O. Box 1186
5602 BD Eindhoven
Niederlande

GARANZIA LIMITATA E LIMITAZIONE DI RESPONSABILITÀ

Si garantisce che ogni prodotto Fluke è esente da difetti nei materiali e nella manodopera per normali situazioni di uso. Il periodo di garanzia è di due anni a decorrere dalla data di spedizione. La garanzia sulle parti sostituite, sulle riparazioni e sugli interventi di assistenza è di 90 giorni. La garanzia è valida solo per l'acquirente originale o l'utente finale che abbia acquistato il prodotto presso un rivenditore Fluke autorizzato. Sono esclusi i fusibili, le pile monouso e i prodotti che, a parere della Fluke, siano stati adoperati in modo improprio, alterati, trascurati, contaminati o danneggiati in seguito a incidente o condizioni anomale d'uso e maneggiamento. La Fluke garantisce che il software funzionerà sostanzialmente secondo le specifiche per un periodo di 90 giorni e che è stato registrato su supporti non difettosi. Non garantisce che il software sarà esente da errori o che funzionerà senza interruzioni.

I rivenditori autorizzati Fluke estenderanno la garanzia sui prodotti nuovi o non usati esclusivamente ai clienti finali, ma non potranno emettere una garanzia differente o più completa a nome della Fluke. La garanzia è valida solo se il prodotto è stato acquistato attraverso la rete commerciale Fluke o se l'acquirente ha pagato il prezzo internazionale pertinente. La Fluke si riserva il diritto di fatturare all'acquirente i costi di importazione per la riparazione/sostituzione delle parti nel caso in cui il prodotto acquistato in un Paese sia sottoposto a riparazione in un altro.

L'obbligo di garanzia è limitato, a scelta della Fluke, al rimborso del prezzo d'acquisto, alla riparazione gratuita o alla sostituzione di un prodotto difettoso che sia inviato ad un centro di assistenza autorizzato Fluke entro il periodo di garanzia.

Per usufruire dell'assistenza in garanzia, rivolgersi al più vicino centro di assistenza autorizzato Fluke per ottenere informazioni sull'autorizzazione alla restituzione, quindi spedire il prodotto al centro di assistenza, allegando una descrizione del difetto, franco destinatario e assicurato. La Fluke declina ogni responsabilità di danni durante il trasporto. Una volta eseguite le riparazioni in garanzia, il prodotto sarà restituito all'acquirente, franco destinatario. Se la Fluke stabilisce che il guasto è stato causato da negligenza, uso improprio, contaminazione, alterazione, incidente o condizioni anomale di uso o maneggiamento (comprese le sovratensioni causate dall'uso dello strumento oltre la portata nominale e l'usura dei componenti meccanici dovuta all'uso normale dello strumento), la Fluke darà una stima dei costi di riparazione e attenderà l'autorizzazione dell'utente prima di procedere con la riparazione. A seguito della riparazione, il prodotto sarà restituito all'acquirente con addebito delle spese di riparazione e di spedizione.

LA PRESENTE GARANZIA È L'UNICO ED ESCLUSIVO RICORSO DISPONIBILE ALL'ACQUIRENTE ED È EMessa IN SOSTITUZIONE DI OGNI ALTRA GARANZIA, ESPRESSA O IMPLICITA, COMPRESA, MA NON LIMITATA A ESSA, QUALSIASI GARANZIA IMPLICITA DI COMMERCIALIZZABILITÀ O DI IDONEITÀ PER SCOPI PARTICOLARI. LA FLUKE NON SARÀ RESPONSABILE DI NESSUN DANNO O PERDITA SPECIALI, INDIRETTI O ACCIDENTALI, DERIVANTI DA QUALUNQUE CAUSA O TEORIA.

Poiché alcuni Paesi non consentono di limitare i termini di una garanzia implicita né l'esclusione o la limitazione di danni accidentali o indiretti, le limitazioni e le esclusioni della presente garanzia possono non valere per tutti gli acquirenti. Se una clausola qualsiasi della presente garanzia non è ritenuta valida o attuabile dal tribunale o altro foro competente, tale giudizio non avrà effetto sulla validità delle altre clausole.

Fluke Corporation
P.O. Box 9090
Everett, WA 98206-9090
USA

Fluke Europe B.V.
P.O. Box 1186
5602 BD Eindhoven
Paesi Bassi

GARANTIA LIMITADA E LIMITAÇÃO DE RESPONSABILIDADE

Todos os produtos da Fluke são garantidos contra defeitos de material e de mão-de-obra, sob condições de uso e serviço normal. O período de garantia é de dois anos, a partir da data de remessa do produto. As peças, reparos do produto, e serviços são garantidos por 90 dias. Esta garantia aplica-se apenas ao comprador original, ou ao cliente usuário-final de um revendedor autorizado da Fluke, e não cobre fusíveis, baterias descartáveis, nem qualquer produto que, na opinião da Fluke, tenha sido usado de forma inadequada, alterado, contaminado, ou tenha sido danificado por acidente ou condições anormais de operação ou manuseio. A Fluke garante que o software funcionará de acordo com as suas especificações técnicas pelo período de 90 dias, e que foi gravado de forma adequada em meio físico sem defeitos. A Fluke não garante que o software não apresentará erros nem que funcionará ininterruptamente.

Os revendedores Fluke autorizados devem conceder esta garantia somente para produtos novos e não-usados, mas não estão autorizados a ampliá-la ou modificá-la de qualquer forma em nome da Fluke. A assistência técnica coberta pela garantia está disponível se o produto houver sido adquirido de uma loja autorizada da Fluke, ou se o Comprador tiver pago o preço internacional aplicável. A Fluke reserva-se o direito de cobrar do Comprador os custos de importação das peças de reposição/reparo nos casos em que o produto tenha sido comprado em um país e remetido para reparos em outro país.

A obrigação da Fluke no tocante a esta garantia é limitada, a critério da Fluke, à devolução da importância correspondente ao preço pago pelo produto, a consertos gratuitos, ou à substituição de produto defeituoso que seja devolvido a um centro de assistência técnica autorizado Fluke dentro do período coberto pela garantia.

Para obter serviços cobertos pela garantia, entre em contato com o centro de assistência técnica autorizado Fluke mais próximo, ou remeta o produto, com uma descrição do problema encontrado e com frete e seguro pagos (FOB no destino), ao centro de assistência técnica mais próximo. A Fluke não se responsabiliza por nenhum dano que possa ocorrer durante o transporte. Após serem efetuados os serviços cobertos pela garantia, o produto será remetido de volta ao Comprador, com frete pago (FOB no destino). Se a Fluke constatar que a falha do produto foi causada por negligência, uso inadequado, contaminação, alterações, acidente, ou condições anormais de operação ou manuseio, inclusive falhas devidas a sobretensão causadas pelo uso do produto fora das faixas e classificações especificadas, ou pelo desgaste normal de componentes mecânicos, a Fluke dará uma estimativa dos custos de reparo, e obterá autorização do Comprador antes de efetuar tais reparos. Após a realização dos reparos, o produto será remetido de volta ao Comprador com frete pago, e este reembolsará a Fluke pelos custos do reparo e da remessa (FOB no local de remessa).

ESTA GARANTIA É O ÚNICO E EXCLUSIVO RECURSO JURÍDICO DO COMPRADOR, E SUBSTITUI TODAS AS OUTRAS GARANTIAS, EXPRESSAS OU IMPLÍCITAS, INCLUINDO, MAS NÃO SE LIMITANDO A, QUALQUER GARANTIA IMPLÍCITA DE COMERCIALIZABILIDADE OU ADEQUAÇÃO PARA UM DETERMINADO FIM. A FLUKE NÃO SE RESPONSABILIZA POR NENHUM DANO OU PERDA, INCIDENTAL OU CONSEQUENTE, QUE POSSA OCORRER POR QUALQUER MOTIVO OU QUE SEJA DECORRENTE DE QUALQUER CAUSA OU TEORIA JURÍDICA.

Como alguns estados ou países não permitem a exclusão ou limitação dos termos de garantias implícitas, nem de danos incidentais ou consequentes, esta limitação de responsabilidade poderá não se aplicar ao seu caso. Se alguma provisão desta Garantia for considerada inválida ou inexecutável por algum tribunal ou outro órgão de jurisdição competente, tal decisão judicial não afetará a validade ou executabilidade de nenhuma outra provisão.

Fluke Corporation
P.O. Box 9090
Everett, WA 98206-9090,
EUA

Fluke Europe B.V.
P.O. Box 1186
5602 BD Eindhoven
Holanda

GARANTÍA LIMITADA Y LIMITACIÓN DE RESPONSABILIDAD

Todo producto de Fluke está garantizado contra defectos en los materiales y en la mano de obra en condiciones normales de utilización y mantenimiento. El periodo de garantía es de tres años y comienza en la fecha de despacho. Las piezas de repuesto, reparaciones y servicios están garantizados por 90 días. Esta garantía se extiende sólo al comprador original o al cliente usuario final de un revendedor autorizado por Fluke y no es válida para fusibles, baterías desechables ni para ningún producto que, en opinión de Fluke, haya sido utilizado incorrectamente, modificado, maltratado, contaminado, o sufrido daño accidental o por condiciones anormales de funcionamiento o manipulación. Fluke garantiza que el software funcionará substancialmente de acuerdo con sus especificaciones funcionales durante 90 días y que ha sido grabado correctamente en un medio magnético sin defectos. Fluke no garantiza que el software no contenga errores ni que operará permanentemente.

Los revendedores autorizados por Fluke podrán extender esta garantía solamente a los Compradores finales de productos nuevos y sin uso previo, pero carecen de autoridad para extender una garantía mayor o diferente en nombre de Fluke. El soporte técnico en garantía está disponible sólo si el producto se compró a través de un centro de distribución autorizado por Fluke o si el comprador pagó el precio internacional correspondiente. Cuando un producto comprado en un país sea enviado a otro país para su reparación, Fluke se reserva el derecho de facturar al Comprador los gastos de importación de las reparaciones/repuestos.

La obligación de Fluke de acuerdo con la garantía está limitada, a elección de Fluke, al reembolso del precio de compra, la reparación gratuita o el reemplazo de un producto defectuoso que sea devuelto a un centro de servicio autorizado de Fluke dentro del período de garantía.

Para obtener servicio de garantía, póngase en contacto con el centro de servicio autorizado por Fluke más cercano para obtener la información correspondiente a la autorización de la devolución, después envíe el producto a ese centro de servicio, con una descripción del fallo, con los portes y seguro prepagados (FOB destino). Fluke no se hace responsable de los daños ocurridos durante el transporte. Después de la reparación de garantía, el producto se devolverá al Comprador con los fletes ya pagados (FOB destino). Si Fluke determina que el problema fue debido a negligencia, mala utilización, contaminación, modificación, accidente o una condición anormal de funcionamiento o manipulación, incluidas las fallas por sobretensión causadas por el uso fuera de los valores nominales especificados para el producto, o al desgaste normal de los componentes mecánicos, Fluke preparará una estimación de los costes de reparación y obtendrá la debida autorización antes de comenzar el trabajo. Al concluir la reparación, el producto se devolverá al Comprador con los fletes ya pagados, facturándosele la reparación y los gastos de transporte (FOB en el sitio de despacho).

ESTA GARANTÍA ES EL ÚNICO Y EXCLUSIVO RECURSO DEL COMPRADOR Y SUBSTITUYE A TODAS LAS OTRAS GARANTÍAS, EXPRESAS O IMPLÍCITAS, INCLUYENDO, PERO SIN LIMITARSE A, TODA GARANTÍA IMPLÍCITA DE COMERCIABILIDAD O IDONEIDAD PARA UN PROPÓSITO DETERMINADO. FLUKE NO SE RESPONSABILIZA DE PÉRDIDAS NI DAÑOS ESPECIALES, INDIRECTOS, IMPREVISTOS O CONTINGENTES, INCLUIDA LA PÉRDIDA DE DATOS, QUE SURJAN POR CUALQUIER TIPO DE CAUSA O TEORÍA.

Como algunos países o estados no permiten la limitación de la duración de una garantía implícita ni la exclusión ni limitación de los daños contingentes o resultantes, las limitaciones y exclusiones de esta garantía pueden no regir para todos los Compradores. Si una cláusula de esta Garantía es conceptualmente no válida o inaplicable por un tribunal u otra instancia de jurisdicción competente, tal concepto no afectará la validez o aplicabilidad de cualquier otra cláusula.

Fluke Corporation
P.O. Box 9090
Everett, WA 98206-9090
EE.UU.

Fluke Europe B.V.
P.O. Box 1186
5602 BD Eindhoven
Holanda

有限担保和有限责任

Fluke 担保在正常使用和保养的情况下，其产品没有材料和工艺上的缺陷。两年的担保期间由产品发货之日算起。部件、产品修理和服务的担保期限为 90 天。本担保仅限于 **Fluke** 授权零售商的原购买人或最终用户，并且不适用于一次性电池、电缆接头、电缆绝缘转换接头或 **Fluke** 认为由于误用、改装、疏忽、污染及意外或异常操作或处理引起的任何产品损坏。**Fluke** 担保软件能依照功能规格正常运行 90 天，并且软件是记录在无缺陷的媒介上。**Fluke** 并不担保软件毫无错误或在运行中不会中断。

Fluke 授权的零售商应仅对最终用户就新的和未使用的产品提供本担保，但无权代表 **Fluke** 公司提供额外或不同的担保。只有通过 **Fluke** 授权的销售店购买的产品或者买方已经按适用的国际价格付款才能享受 **Fluke** 的担保支持。在一国购买的产品需在他国修理时，**Fluke** 有权向买方要求负担重大修理/零件更换费用。

Fluke 的担保为有限责任，由 **Fluke** 决定是否退还购买金额、免费修理或更换在担保期间退还 **Fluke** 授权服务中心的故障产品。

如需要保修服务，请与您就近的 **Fluke** 授权服务中心联系，获得退还授权信息；然后将产品寄至服务中心，并附上产品问题描述，同时预付运费和保险费（目的地离岸价格）。**Fluke** 不承担运送途中发生的损坏。在保修之后，产品将被寄回给买方并提前支付运输费（目的地交货）。如果 **Fluke** 认定产品故障是由于疏忽、误用、污染、修改、意外或不当操作或处理状况而产生，包括未在产品规定的额定值下使用引起的过压故障；或是由于机件日常使用损耗，则 **Fluke** 会估算修理费用，在获得买方同意后再进行修理。在修理之后，产品将被寄回给买方并预付运输费；买方将收到修理和返程运输费用（寄发地交货）的帐单。

本担保为买方唯一能获得的全部补偿内容，并且取代所有其它明示或隐含的担保，包括但不限于适销性或满足特殊目的任何隐含担保。**FLUKE** 对任何特殊、间接、偶发或后续的损坏或损失概不负责，包括由于任何原因或推理引起的数据丢失。

由于某些国家或州不允许对隐含担保的期限加以限制、或者排除和限制意外或后续损坏，本担保的限制和排除责任条款可能并不对每一个买方都适用。如果本担保的某些条款被法院或其它具有适当管辖权的裁决机构判定为无效或不可执行，则此类判决将不影响任何其它条款的有效性或可执行性。

Fluke Corporation
P.O. Box 9090
Everett, WA 98206-9090
U.S.A.

Fluke Europe B.V.
P.O. Box 1186
5602 BD Eindhoven
The Netherlands

Table of Contents

Title	Page
Introduction	1
Information and PC Software CD	1
Logger Power Supply	2
Logging Functions	2
Symbols	4
Safety Instructions	4
Qualified Personnel.....	6
Standard Equipment and Optional Accessories	6
Features.....	8
Power Network Configurations	11
Working with Logged Data.....	11
Using the 1745 Power Quality Logger.....	12
About Logging Jobs.....	12
Preparing the Logger for Use.....	13
Test Leads - Markings	15
Connecting Current Probes	15
Logging with Voltage Converters.....	15
Connecting the Logger.....	16
Connections in 3-Phase 4-Wire (Wye) Systems	19
Connections in 3-Phase 3-Wire (Delta) Systems	20
Connections for Single-Phase Logging.....	21
Connections for Medium Voltage Networks.....	22
Logging.....	24
Completing the Logging Job.....	24
Evaluating the Logged Data.....	25
Methods of Logging.....	25
Voltage Ranges	26
Signal Sampling.....	27
Resolution Accuracy.....	27
Voltage Variations	27
Averaging Period	28
Min/Max Values	29
Voltage Interruptions	30
Voltage Dips and Swells.....	31
Voltage Harmonics	31

Current Harmonics	32
Mains Signaling.....	32
THD V – In Function A.....	33
Calculation of THD in Measuring Function P.....	34
Flicker	35
Unbalance.....	36
Frequency.....	36
Current Logging	36
Logging Function A	36
Crest Factor (CF).....	36
Power	37
Measurement Theory.....	38
Maintenance.....	42
Lithium Battery	42
Disposal.....	42
Technical Specifications.....	43
Logging Parameters – Overview	43
Maximum Number of Intervals for Logging Funtion P.....	44
General Information	44
Environmental Specifications.....	45
EMC	45
Power Supply	45
Measurement	46
Input Voltage.....	46
Current Input with Flexi Set.....	47
Current Input for Clamp.....	47
General Specifications.....	48
RMS Logging Slow Voltage Variations.....	48
Current Logging Values	48
Events Dips, Swells, Interruptions.....	48
Flicker	48
Power P, S, P 	49
Harmonics (Logging Function A Only).....	49
Statistics	49
Logging Function Parameters.....	50
Logging Values	50
Applications	51
PQ Log PC Application Software	52
Live Reading (Online Test).....	53
ASCII Export.....	54
Timeplot Diagram	55
UNIPEDE DISDIP Table.....	56
Cumulative Frequency – Harmonics	56

Index

List of Tables

Table	Title	Page
1.	Symbols.....	4
2.	Standard Equipment.....	7
3.	Optional Accessories.....	7
4.	1745 Power Quality Logger - Controls and Indicators.....	9
5.	Test Leads - Markings.....	15
6.	Measuring Ranges.....	26
7.	Logging Parameters - Overview.....	43

List of Figures

Figure	Title	Page
1.	1745 Power Quality Logger	3
2.	1745 Power Quality Logger - Front View	8
3.	Supplying Operating Power to the Logger	14
4.	Logging in a 3-Phase 4-Wire System	19
5.	Logging in a 3-Phase 3-Wire (Delta) System	20
6.	Single-Phase Logging	21
7.	Measuring 3 Phase Voltages in a 3-Wire (Delta) System with Three Voltage Converters	22
8.	Two-Element Delta Connections	23
9.	Basic Logger Setup Parameters	26
10.	Measuring Voltage Variations	28
11.	Logging Min and Max Values	29
12.	Voltage Interruption	30
13.	Voltage Dips and Swells	31
14.	Measuring Flicker Values	35
15.	Live Reading (Online Test)	53
16.	ASCII Export	54
17.	Timeplot Diagram	55
18.	UNIPEDE DISDIP Table	56
19.	Cumulative Frequency - For Voltage and Current Harmonics	56

1745 Power Quality Logger

Introduction

The Fluke 1745 Power Quality Logger, see Figure 1, is a sophisticated, easy-to-use, electrical power-recording device for the electrician or power-quality specialist.

Note

This manual also refers to the 1745 Power Quality Logger simply as “the Logger”.

The Logger contains an automatically charged 8-hour UPS (uninterruptable power supply) battery for long-term voltage interruption ride-through, and an LCD status display to provide confidence in setup before you leave the Logger in place to collect data.

You can power the logger in parallel with the test leads or through an outlet. Adapter cords for both methods of power in the Logger are included as standard equipment.

You'll prepare the Logger for use with the included PQ Log software. You can then connect the Logger to an electrical power-distribution network to log a variety of power parameters, recorded as sequential averaged values over an averaging period you can define. The Logger can measure up to three voltages and four currents simultaneously.

Information and PC Software CD

The CD included with the Logger contains the PQ Log application software for Windows, along with users manuals in multiple languages.

The PQ Log software prepares the Logger for use, and downloads data from the Logger to a connected PC. You can then view the logged data in graphical and tabular form, export it to a spreadsheet, or create reports for printing. For details and instructions, see the PQ Log Users Manual on the CD.

Logger Power Supply

The Logger does not include a power switch, but turns on automatically whenever its power supply leads are connected to a voltage in its allowed range. You can plug the Logger's power supply leads into a standard wall outlet (using the included adapter cord), or you can connect them directly to the power network under test (in parallel with the test leads) if there is no convenient wall outlet (only if the voltage at the test leads is below 660V RMS.)

Logging Functions

The Logger monitors power quality and locates disturbances in low and medium voltage distribution networks. It measures up to 3 voltages and 4 currents. Logged values are saved in your choice of sequential averaging periods. You graphically or numerically evaluated measured values with PQ Log.

The Logger has two types of logging functions: logging function A (Advanced) and logging function P (Power). Function A is the full set of parameters, and function P provides logging capability optimized for load studies and basic power logging. Function P contains every parameter in Function A except voltage and current harmonics and interharmonics. Logging function P allows longer logging periods because it does not save harmonics values.

Logging function parameters:

- RMS Voltage of each phase (average, min, max)
- RMS Current of each phase and neutral (average, min, max)
- Voltage events (dips, swells, interruptions)
- Power (kW, kVA, kVAR, Power PF, Power tangent)
- Energy, total energy
- Flicker (Pst, Plt)
- Voltage THD
- Current THD
- Current CF
- Voltage harmonics to the 50th (not in P function)
- Voltage interharmonics (not in P function)
- Mains signalling voltage
- Unbalance
- Frequency

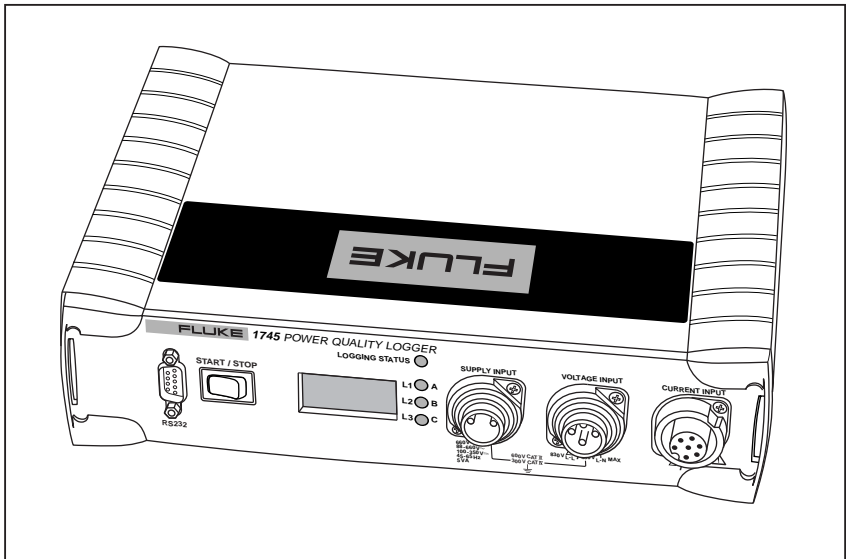











Figure 1. 1745 Power Quality Logger

egc001.eps

Symbols

Table 1 lists the symbols used on the instrument and in this manual.

Table 1. Symbols

Symbol	Description
	Important information. See the manual.
	Hazardous voltage.
	Earth ground.
	Double insulation.
	Direct Current (DC).
	Conforms to European Union requirements
	Canadian Standards Association is the certified body used for testing compliance to safety standards.
	Do not dispose of this product as unsorted municipal waste. Contact Fluke or a qualified recycler for disposal.
	Conforms to relevant Australian Standards.

Safety Instructions

Please read this section carefully. It will make you familiar with the most important safety instructions for using the Logger.

Warnings identify conditions and actions that pose safety hazards to the user and **Cautions** identify conditions and actions that can damage the Logger.

⚠ ⚠ Warnings

- **To avoid electrical shock, do not connect any part of the Logger to systems that have higher voltages to ground (earth) than are marked on the Logger.**
- **Areas between the power company meter and the source of the distribution system are characterized as CAT IV areas. To avoid electrical shock or equipment damage, never connect the Logger to power in CAT IV areas if the voltage-to-earth ground is greater than 300 V.**
- **To avoid damaging the Logger, never connect its voltage measuring inputs to phase-to-phase voltages higher than 830 V.**
- **To avoid damaging the Logger, never connect the power supply leads to voltages higher than 660 V-RMS AC.**
- **The Logger is to be used and handled only by qualified personnel (see page 8).**
- **Maintenance work on the Logger must be done only by qualified service personnel.**
- **Use only the current probes specified in this manual. If you use flexible current probes, wear suitable protective gloves or work on de-energized conductors.**
- **Do not expose the Logger to moisture or humidity.**
- **To prevent electrical shock, always connect power supply and voltage test leads to the Logger before connecting to the load.**
- **All accessories must be approved for 600 V CAT III or higher.**
- **Use the Logger only with its original standard equipment or with approved optional accessories, as listed in Table 2 and Table 3 in this manual.**

- **Connect clip-on current transformers and/or Flexi Set to insulated live conductors only.**
- **If measuring sensors are to be connected to non-insulated live conductors, additional personal protective measures must be taken as required by local government agencies.**

⚠ Caution

To avoid damage, use the 1745 Power Quality Logger, only with the following nominal voltages:

- **Single/3 phase, 4-wire (Wye) systems (P-N): 69 V to 480 V**
- **3-phase-3-wire(Delta) systems (P-P): 120 V to 830 V**

⚠⚠ Warning

To avoid electrical shock, or damaging the Logger's internal protective circuitry weatherproof seal, do not open the Logger.

Qualified Personnel

The following qualifications are required for using the Logger safely:

- Trained and authorized to switch on/off, ground (earth), and mark power distribution circuits and devices in accordance with electrical engineering safety standards.
- Trained or instructed in safety engineering standards for maintaining and using appropriate safety equipment.
- Trained in first aid.

Standard Equipment and Optional Accessories

Table 2 lists the standard equipment for the 1745 Power Quality Logger and Table 3 lists optional accessories.

Table 2. Standard Equipment

Equipment	Model/Part Number
Power Quality Logger	1745
International IEC Power Plug Adapter Set	2441372
RS232 Cable, Red, Null-Modem	2540511
Shielded 4-Phase Flexi Set (15 A/150 A/1500 A/3000 A)	FS17XX
Dolphin Clip, Black (4x)	2540726
Color Coding Wire Clips	WC17XX
Soft Case	2715509
English Users Manual	2560366
CD with Users Manual (English, German, French, Spanish, Portuguese, Simplified Chinese, Italian), and PQ Log software (same languages as the manual)	2583507
Power cord adapter for parallel connection to test leads	2651702
Power cord	2715492
USB Adapter	2539565

Table 3. Optional Accessories

Description	Accessory
3-Phase Flexi Set	MBX 3FLEX
3-Phase 1 A/10 A micro CT	EPO405A
C425 Hardcase	2654865
Permlink Software for Modem	E631820090
3-Phase Voltage Leads	2645854

Inspect the contents of the shipping box for completeness and damage. Report any damage, to the shipper.

Features

This section introduces the Logger's controls, indicators and other features. Refer to Figure 2 and Table 4.

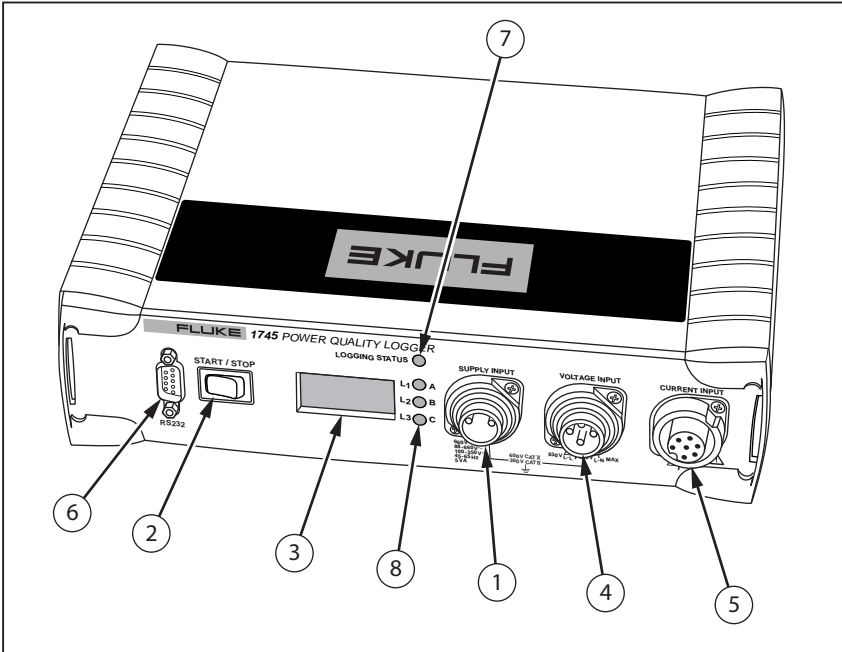

Figure 2. 1745 Power Quality Logger - Front View

egc002.eps

Table 4. 1745 Power Quality Logger - Controls and Indicators

Item	Name	Description
1	Connector for Logger power supply.	<p>This is where the power cord attaches to the Logger. The power cord connects in parallel to any two test leads as long as the voltage is below 660 V absolute maximum. Whenever there is any risk that voltage could be higher, connect the power cord to a wall outlet using the appropriate international power plug (supplied).</p> <p>Power supply voltage range: 88-660 V AC or 100-350 VDC, 50 Hz / 60 Hz, 600 V CAT III.</p>
2	START/STOP switch	The START/STOP button is used to start or end switch-operated logging sessions.
3	LCD status display	<p>Shows measured input values to provide confidence in proper setup and test lead connections. Every 3 seconds, the display changes to the next set of readings in the following sequence:</p> <ol style="list-style-type: none">1. The three voltage levels2. The main three phase currents3. Neutral current and real-time clock4. Active (true) power on each phase <p>The cycle repeats continuously. Make sure the readings look reasonable before leaving the Logger to collect data.</p>
4	Power supply leads and 3-phase plus neutral voltage test leads	<p>Fixed installed voltage input cables for L1 or A, L2 or B, L3 or C, N.</p> <p>The highest permissible nominal voltage is 830 V in a 3-wire network with Delta connection.</p> <p>In a 4-wire network with Wye connection, the highest permissible nominal voltage is 480 V.</p> <p>When using PTs and CTs for measuring voltage and current in a medium-voltage network, refer to the IEC 60044 international standard for guidelines.</p>

Table 4. 1745 Power Quality Logger - Controls and Indicators (cont)

Item	Name	Description
5	Connector for Flexi Set or current clamps	<p>Flexi sets or current clamps are detected automatically at power-up. If you change the current probe type, be sure to remove and restore power so the Logger will detect the new current probe.</p> <p>Nominal ranges for the Flexi Set are 15 A, 150 A, 1500 A, and 3000 A AC. Nominal input for current clamps is 0.5 V.</p>
6	RS232 interface port	<p>The serial RS232 interface is used to communicate with a PC. The Logger is connected to the PC's serial port (or a modem for remote communication) using the interface cable. Use a USB adapter if necessary.</p>
7	Logging Status LED	<p>Yellow blinking = Logging job not set up yet, or waiting for start time or START button.</p> <p>Green blinking = logging is in progress</p> <p>Steady green = Logging session is finished. Data are ready to upload to a PC.</p>
8	Channel LEDs	<p>The logging channel LEDs indicate whether the applied voltages are within the nominal range set using the PQ Log software.</p> <p>Red = Overload</p> <p>Green = OK</p> <p>Yellow = Underload</p> <p>(There is no detection for the current input)</p>

Power Network Configurations

You can set up the Logger to work with several power network configurations (listed below). You make these settings using PQ Log software while connected to the Logger using the interface cable. See the PQ Log Users Manual for details.

- Delta system
- Delta 2 element system (2 voltage/current transformer)
- Wye (Star) system
- Single phase
- Split single phase

Working with Logged Data

See the PQ Log manual for full details. Logged data can be evaluated using the PQ Log software to provide the following:

- Amount, date/time, and duration of quick and slow voltage variations
- Half-cycle: 10 ms-extreme values for 50 Hz (8.3 ms at 60 Hz) MIN and MAX for each measuring interval
- Depth and duration of voltage dips
- Correlation between peak current and voltage dips
- 95 %-flicker values according to EN50160
- Number and duration of interruptions
- Compliance of harmonic levels with defined limits
- Mean and peak values of phase currents
- Value of neutral conductor current
- Current total harmonic distortion (THD) of phase and neutral conductor currents
- Profile of active, reactive, and apparent power versus time
- Monitoring of power factor (PF) and information about effectiveness of compensation systems
- Graphical representations of logging data and statistics

Using the 1745 Power Quality Logger

This section explains how to operate the 1745 Power Quality Logger. You should also refer to the PQ Log Users Manual to become familiar with the software you use to prepare the Logger for use and download logged data.

A typical logging session includes four steps:

1. Preparing the Logger for use with the PQ Log software.
2. Installing the Logger at the logging site.
3. Leaving the Logger to collect data for a period.
4. Downloading and evaluating the logged data.

These steps are described in the following pages.

About Logging Jobs

Logging jobs are defined using the PQ Log software, and transferred to the Logger over the RS-232 cable. Each job contains the following information:

- Logging function P or A
- Measuring period, defined by start and end times
- Time activated, switch or immediate job
- Nominal voltage
- Power type (wye, delta, etc.)
- Averaging period length
- Logging time period
- Interharmonics and signaling voltages
- Limit values for events
- Memory model for events: circular (first-in/first-out, continuous), or linear (quit logging when logging period is finished)
- Logging of current - neutral wire
- Optional converter ratios for current and voltage if using potential transformers (PTs) and current transformers (CTs) at a medium-voltage network site

Preparing the Logger for Use

Prepare the 1745 Logger for use with PQ Log software as follows (see Figure 3):

1. Connect the Logger to line power. Use the power supply cables to connect to an outlet, or to the test leads phase and neutral for Wye configurations, or any two-phase leads for delta.

⚠ Caution

If you are powering the Logger in parallel with the test leads, and the voltage under test at the Logger power supply connections could be greater than 660 V RMS AC, plug the power supply leads into an outlet instead. Otherwise, you could damage the Logger.

2. Connect the RS232 interface cable to the serial port of your PC. Use a USB adapter if your PC does not have a serial port.
3. Run the PQ Log software as described in the PQ Log Users Manual.
4. Set up the Logging job and transfer the settings to the Logger.

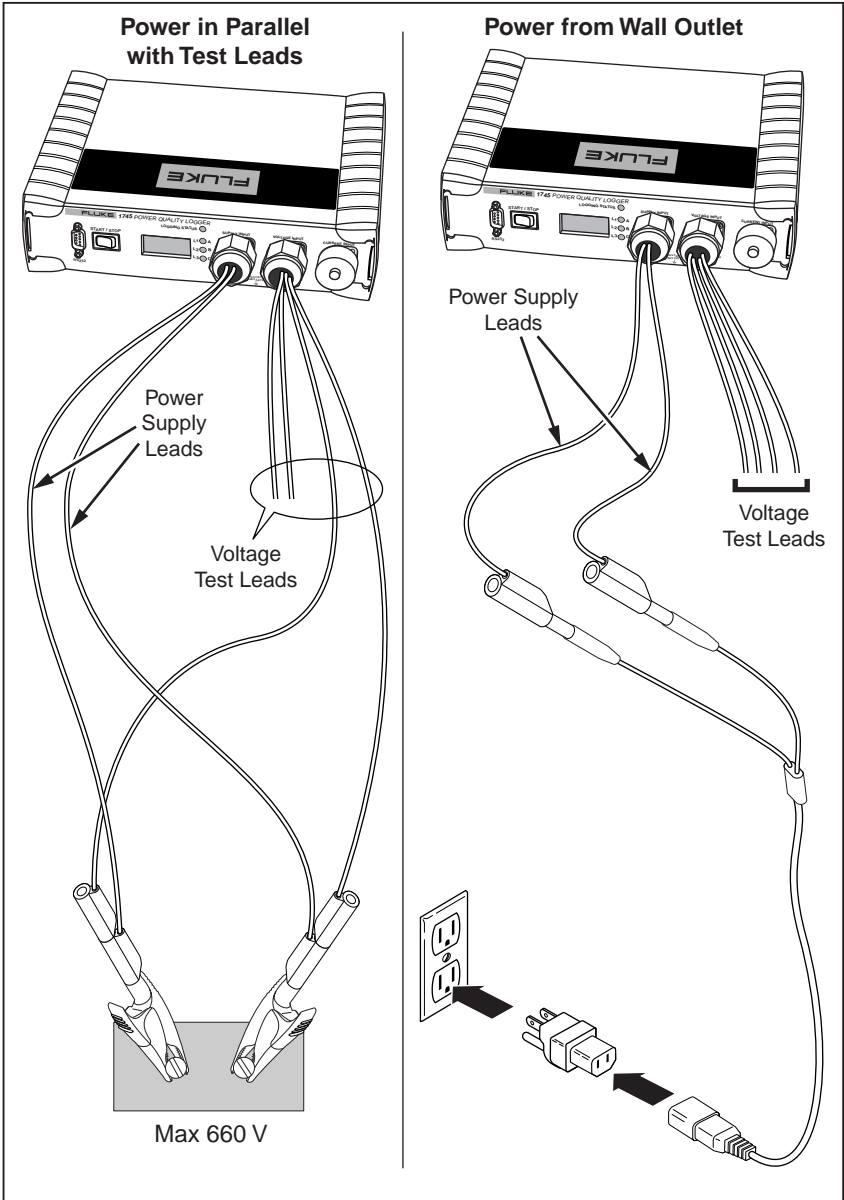

Figure 3. Supplying Operating Power to the Logger

egc031.eps

Test Leads - Markings

The 1745 Logger includes detachable labeled test leads for voltage terminals L1 or A, L2 or B, L3 or C, and N. Another detachable set of leads provides operating power to the Logger. The Flexi Set or current clamp sets are connected by a seven-pin plug to the Logger A connector. Color coding clips are provided for your convenience.

Table 5 shows the test leads and markings of the Logger.

Table 5. Test Leads - Markings

Test Leads	Markings
Phase L1 or A	L1 / A
Phase L2 or B	L2 / B
Phase L3 or C	L3 / C
Neutral wire N	N

Connecting Current Probes

Connect current clamps and Flexi Set probes so that current will flow in the direction marked by arrows on the probes. Current must flow from the energy generator to the energy consumer (the load) in order to maintain a positive active power. Orient the Flexi probe so that the arrow points towards the load. (The polarization of the test lead for neutral conductor current is not significant, because the phase angle of the neutral conductor current is not evaluated.)

Logging with Voltage Converters

The 1745 Logger includes an adjustable convertor ratio that enables it to be used with voltage convertors (potential transformers, or PTs).

Note

When logging with voltage convertors, make sure the power supply cables are not connected in parallel to the voltage test leads, or the Logger's power consumption can reduce accuracy.

The convertor ratio is defined using the PQ Log software.

Connecting the Logger

⚠ ⚠ Warnings

- **To avoid electrical shock, do not connect any part of the Logger to systems that have higher voltages to ground (earth) than are marked on the Logger.**
- **Areas between the power company meter and the source of the distribution system are characterized as CAT IV areas. To avoid electrical shock or equipment damage, never connect the Logger to power in CAT IV areas if the voltage-to-earth ground is greater than 300 V.**
- **To avoid damaging the Logger, never connect its voltage measuring inputs to phase-to-phase voltages higher than 830 V.**
- **To avoid damaging the Logger, never connect the power supply leads to voltages higher than 660 V RMS AC.**
- **The Logger is to be used and handled only by qualified personnel (see page 6).**
- **Maintenance work on the Logger must be done only by qualified service personnel.**
- **Use only the current probes specified in this manual. If you use flexible current probes, wear suitable protective gloves or work on de-energized conductors.**
- **Do not expose the Logger to moisture or humidity.**
- **To prevent electrical shock, always connect power supply and voltage test leads to the Logger before connecting to the load.**
- **All accessories must be approved for 600 V CAT III or higher.**

- Use the Logger only with its original standard equipment or with approved optional accessories as listed in Table 2 and Table 3 in this manual.
- Connect clip-on current transformers and/or Flexi Set to insulated live conductors only.
- If measuring sensors are to be connected to non-insulated live conductors, additional personal protective measures must be taken as required by local government agencies.

⚠ Caution

To avoid damage, use the 1745 Power Quality Logger only with the following nominal voltages:

Single/3-phase 4-wire (Wye) systems (P-N): 69 V to 480 V

3-phase-3-wire (Delta) systems (P-P): 120 V to 830 V

⚠⚠ Warning

To avoid electrical shock, or damaging the Logger's internal protective circuitry or weatherproof seal, do not open the Logger.

Tequipment
NET



205 Westwood Ave
Long Branch, NJ 07740
1-877-742-TEST (8378)
Fax: (732) 222-7088
salesteam@Tequipment.NET

Connect the Logger as follows.

Note

Δ - (delta) or Y- (wye) measurements.

The 1745 Logger is prepared for logging in Delta, Delta 2 Element, Wye (Star), single and split phase. Please note the different types of connection and configuration in the PQ Log software.

1. Connect all required measuring leads.
2. If you want to supply the Logger from an outlet use the supplied power cord and plug adapter. The power supply leads can also be connected in parallel to the voltage test leads, but the voltage is limited to 660 V RMS AC.
3. Connect the current clamp set or Flexi Set to the Logger.
4. Connect the current sensor to the conductor under test.
5. Connect the dolphin clips to the test leads. For 3-phase, 4-wire systems, connect the N-test lead first, and then the other phases.

Connections in 3-Phase 4-Wire (Wye) Systems

Figure 4 shows the connections for logging 3-phase 4-wire (Wye) systems:

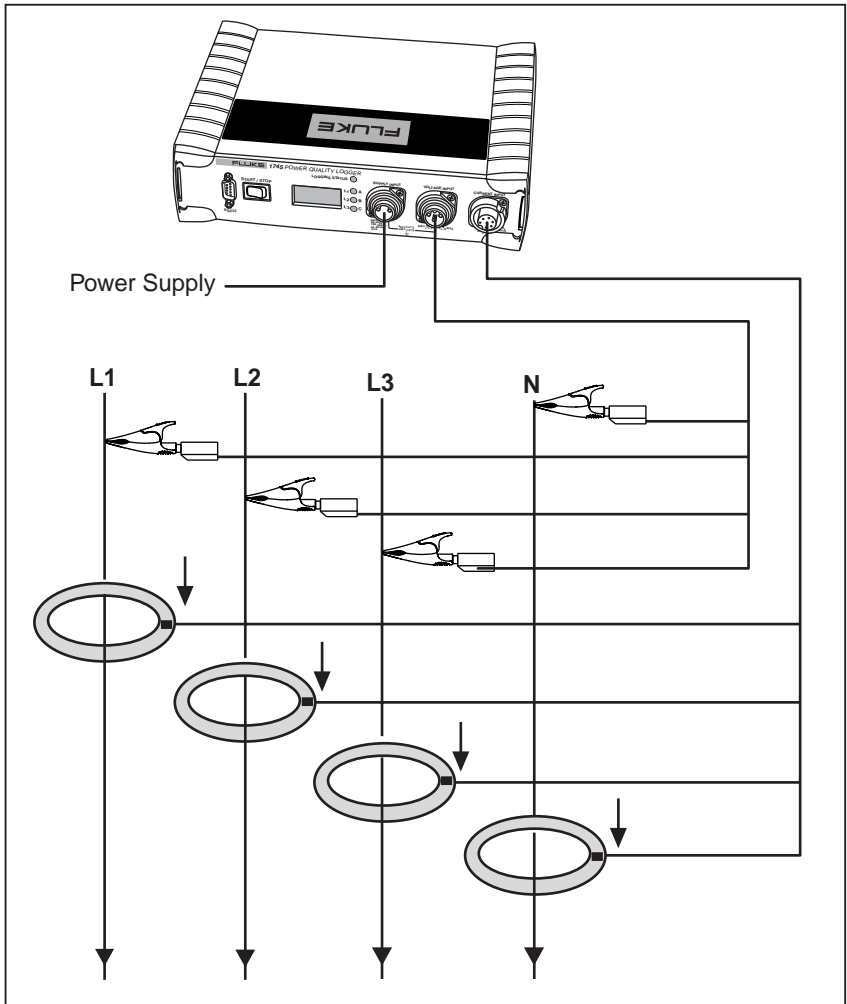

Figure 4. Logging in a 3-Phase 4-Wire (Wye) System

egc003.eps

Connections in 3-Phase 3-Wire (Delta) Systems

Figure 5 shows the connections for logging 3-phase 3-wire (Delta) systems. The test lead “N” can be left open or connected to ground potential.

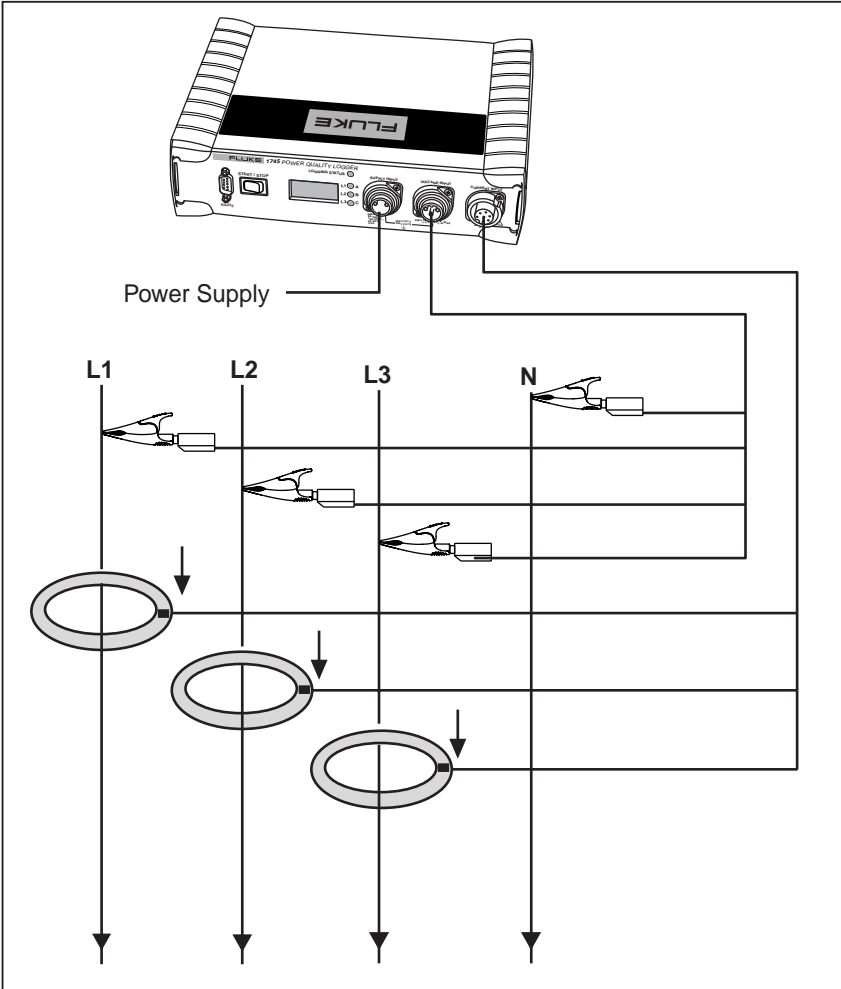

Figure 5. Logging in a 3-Phase 3-Wire (Delta) System

egc004.eps

Connections for Single-Phase Logging

Figure 6 shows the connections for logging single-phase logging systems:

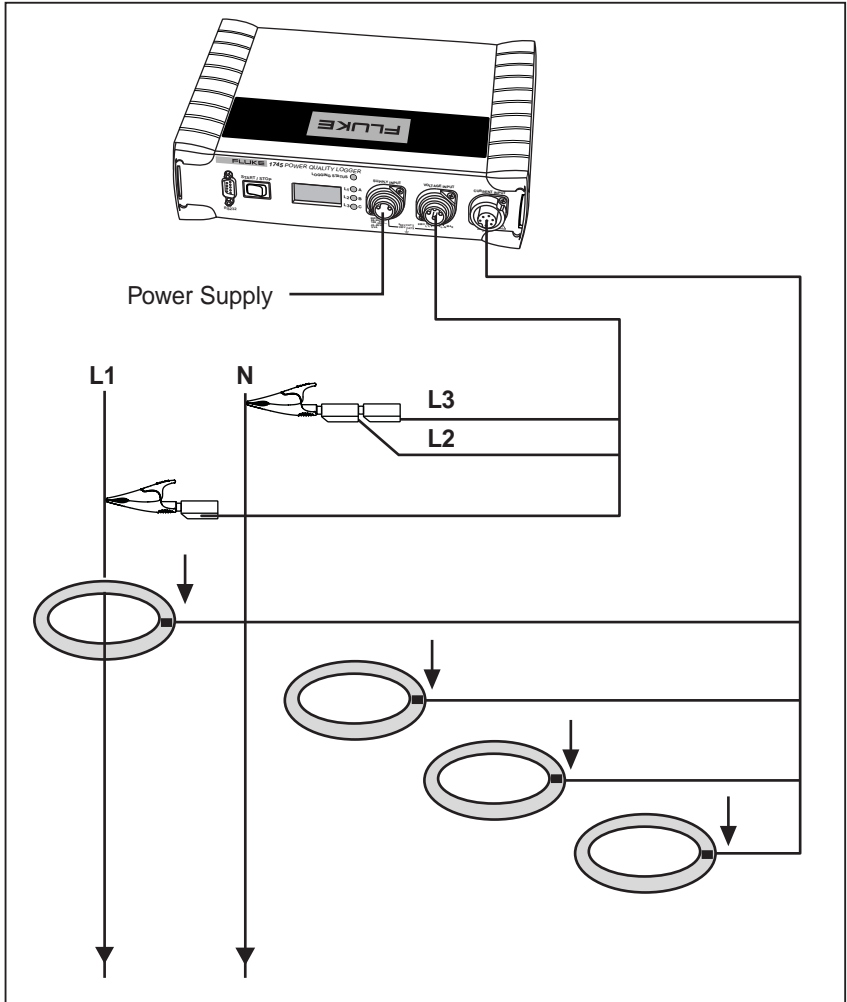
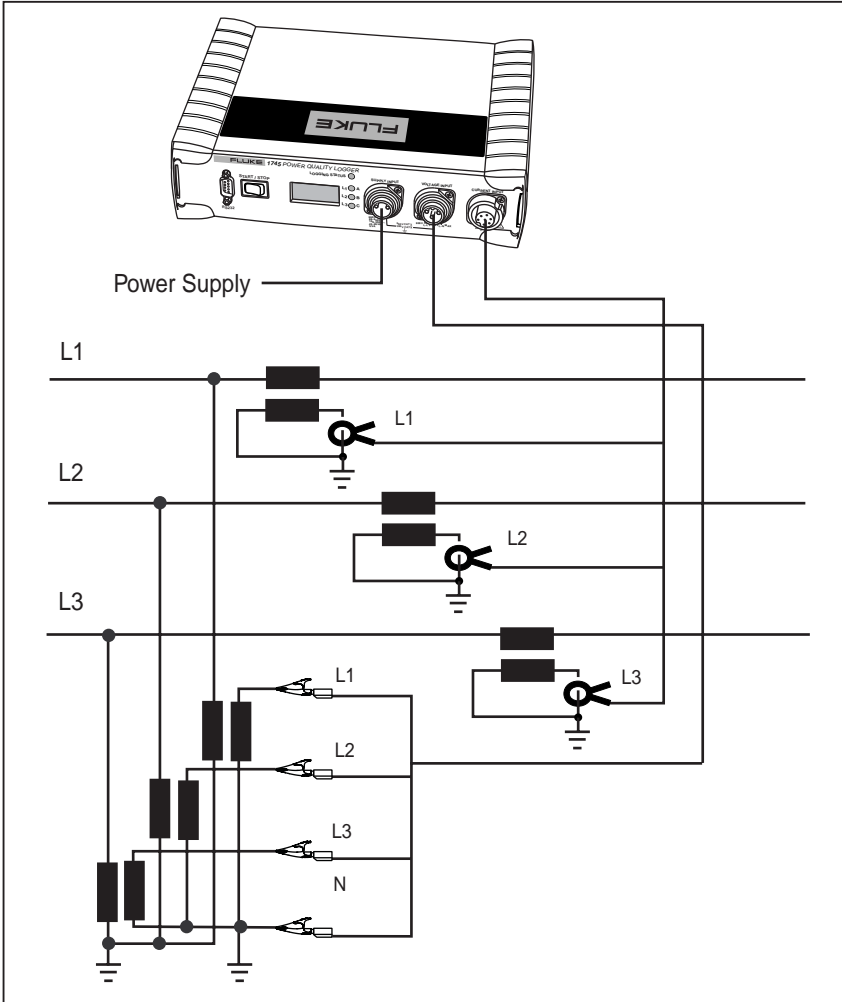

Figure 6. Single-Phase Logging

egc005.eps

Connections for Medium Voltage Networks

In a 3-phase 3-wire (Delta) system with three separate voltage converters and three current transformers, the Logger can measure phase-phase (P-P, Delta) or phase - N (P-N, Wye). See Figure 7.



egc006.eps

Figure 7. Measuring 3 Phase Voltages in a 3-Wire (Delta) System with Three Voltage Converters

Figure 9 shows the connections for two-element Delta (Aron or Blondel) metering connections.

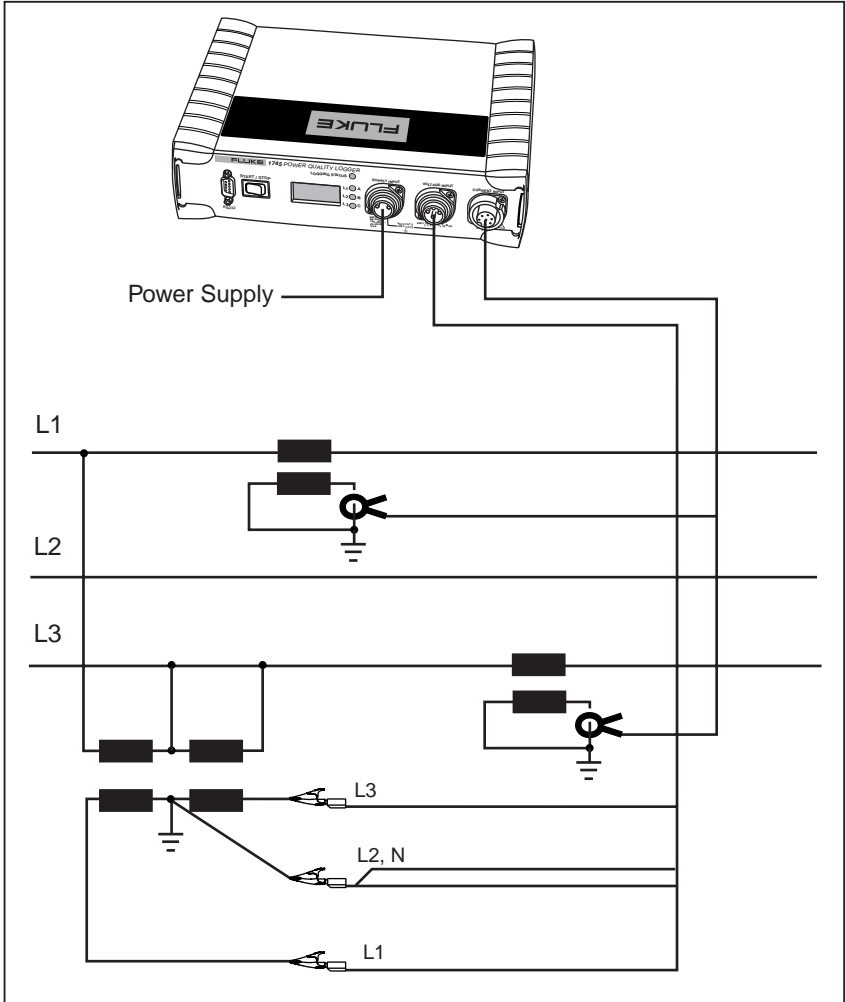

Figure 8. Two-Element Delta Connections

egc009.eps

Logging

When the Logger is connected and ready, you can perform three types of logging:

Switch-activated job: The status LED is blinking. Press the START/STOP button once. As soon as the job is active, the LED is on continuously. If needed, the job can be cancelled after running for at least one minute, and restarted later.

Time-activated job: The Logger starts logging as soon as the pre-programmed start time is reached and stops at the defined end time.

Immediate job: The Logger starts logging as soon as power is on.

Note the following about logging jobs:

1. The connection can be verified with the LCD (voltage, current, power). If all three LEDs are lit continuously, the voltage connections and signal levels are within nominal range. For details, see Table 4 in the *Features* section.
2. The Logging job status is indicated by the status LED. For details, see Table 4 in the *Features* section.

Completing the Logging Job

1. Terminate the job as follows:
 - **For switch activated jobs:** At the end of the logging period, stop the logging job by pressing the START/STOP button.
 - **For time activated and immediate jobs:** Stop the job in PQ Log with the  icon, or with menu Logger/Stop logging

Note

Make sure the logging job is stopped with the START/STOP button (switch activated jobs) or PQ Log (time activated jobs) before the test leads or power supply leads are removed. Otherwise, the Logger will record a voltage interruption.

Only switch-activated jobs can be aborted. Time activated jobs are terminated only when the programmed measuring time has elapsed.

2. Remove the test leads of the three phases. Be sure to remove the measuring cable of the neutral wire last.
3. Remove the current probes.

Evaluating the Logged Data

You'll use PQ Log to evaluate the logged data. Data can be read out during logging as well as at the end.

1. Connect the Logger to line power.
2. Connect the RS232 interface cable to your PC's serial port, then to the Logger.
3. Start the PQ Log software.
4. Use PQ Log to transfer the data from the Logger to the PC.
5. Once the data is transferred, remove the RS232 interface cable and operating power from the Logger.
6. Evaluate the data using PQ Log.

For details, refer to the PQ Log manual.

Methods of Logging

The following section describes methods of logging using the 1745 Logger.

Voltage Ranges

The software calculates the correct measuring range depending on the nominal voltage (20 % overflow with $C_F = 1.4$).

Table 6 shows the measuring ranges of the Logger and Figure 9 shows the selection for input ranges during job processing.

Table 6. Measuring Ranges

Connection	Nominal Voltages (Wye/Delta) Max. Input Voltage			
Wye/Delta	69 V / 120 V	115 V / 200 V	230 V / 400 V	480 V / 830 V
Phase/Neutral 3-phase 4 wire	69 V ~, +20 %	115 V ~, +20 %	230 V ~, +20 %	480 V ~, +20 %
Phase/Phase 3-phase 3 wire	120 V ~, +20 %	200 V ~, +20 %	400 V ~, +20 %	830 V ~, +20 %

Job processing measurement function A

Voltage

Nominal voltage: 480 V Voltage transformer

Frequency: 60 Hz

Power Type: Delta

Min-Max-value: 0.5 periods

Current

Logger type: 1744 Power Quality Logger EP04x4x

Type attached: 4 - Flexi-CT, 3-phase+N

Flexi range: 3000 A

Interval

Maximum continuous measurement: 39 days, 4 hours, 30 minutes

Averaging period: 10 minutes

Memory model: linear

Averaging period for power min-max-values: 1 minute

Measurement period

Continuous job

Switch activated job

Time activated job

Edit

Logger

PC

egb015.bmp

Figure 9. Basic Logger Setup Parameters

Signal Sampling

Input signals (up to three voltages and four currents) are filtered with an anti-aliasing filter and digitized with a 16-bit A/D converter. The sampling rate is 10.24 kHz. All parameters are calculated from this data.

Resolution Accuracy

Resolution and accuracy depend on the logging parameter. For details see “Technical Specifications”.

Voltage Variations

The interval value of the voltage is defined as the mean value of the RMS values over the interval length defined in PQ Log.

Averaging Period

Averaging period can be set in PQ Log to the following:

- 1, 3, 5, 10, or 30 seconds
- 1, 5, 10, 15, or 60 minutes

Figure 10 shows the measuring voltage variations of the Logger.

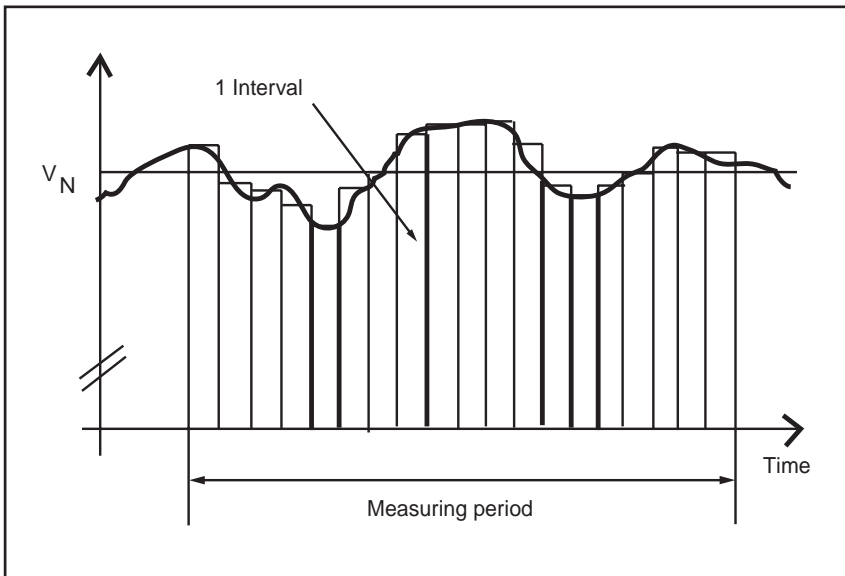

egb016.eps

Figure 10. Measuring Voltage Variations

Min/Max Values

Logging detects the highest and lowest voltage RMS values and the highest current RMS value during the test interval, using a minimum resolution of 10 ms.

The response time can be set in PQ Log to the following:

0.5, or 1 line power period

200 ms

1, 3, or 5 seconds.

Figure 11 shows the logging min and max values of the Logger.

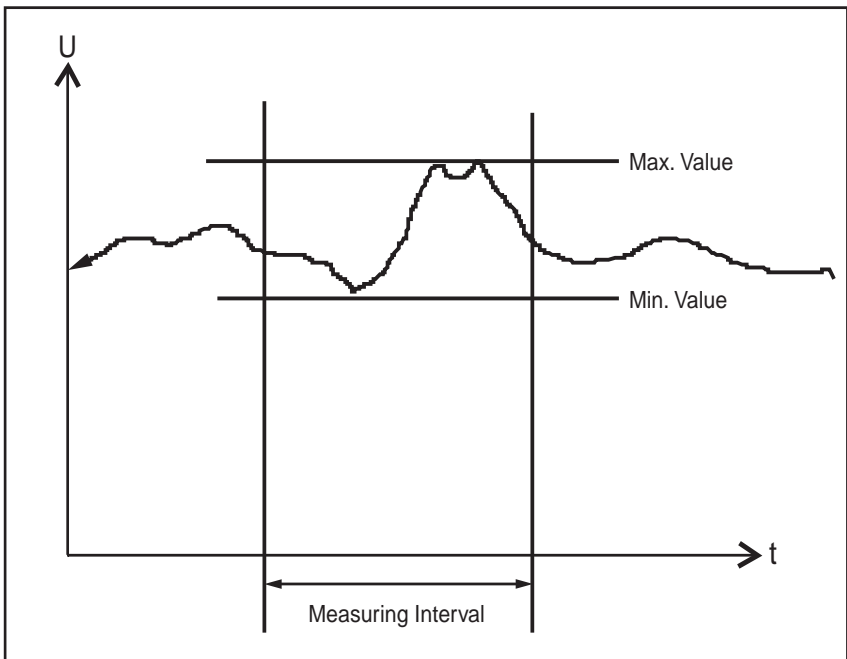

egb017.eps

Figure 11. Logging Min and Max Values

Voltage Interruptions

The Logger records two types of interruptions:

- All measured RMS values of input voltages that are $< 1\%$ of the nominal voltage. This threshold can be adjusted in PQ Log.
- Interruptions > 1 half-cycle

The start time and duration of each interruption are registered. See Figure 12.

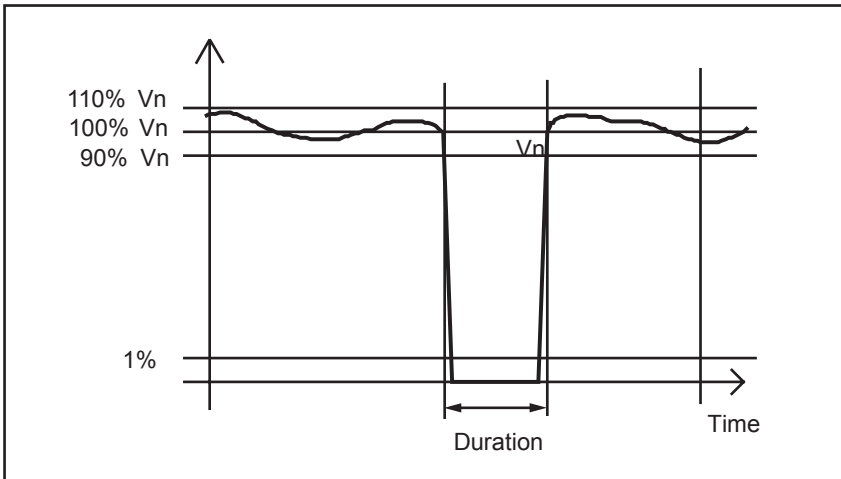

Figure 12. Voltage Interruption

egb018.eps

Voltage Dips and Swells

If the voltage passes the upper limit ($V_N + 10\%$) or lower limit ($V_N - 10\%$), the event is registered as a voltage swell or dip respectively (thresholds are adjustable in PQ Log).

The duration, time and extreme value of the dip or swell is also recorded. See Figure 13.

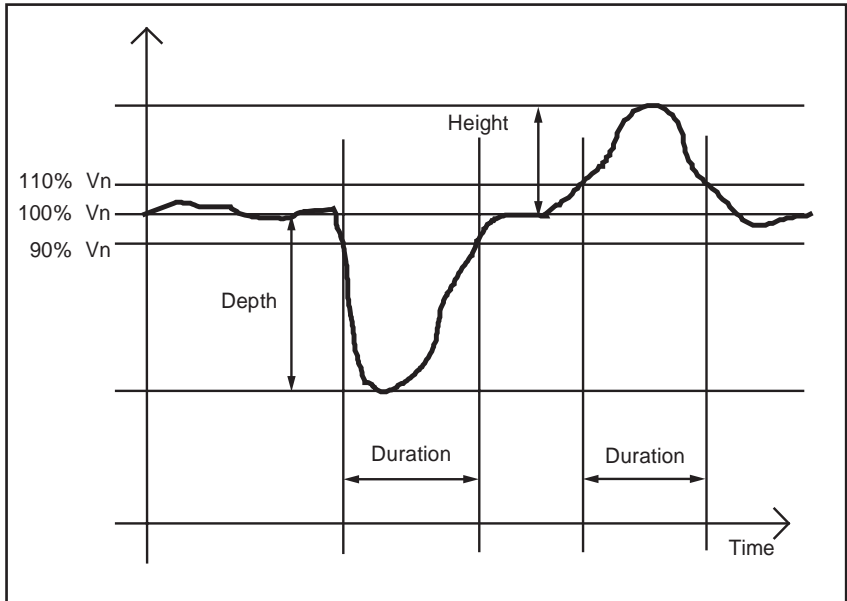

egb019.eps

Figure 13. Voltage Dips and Swells

Voltage Harmonics

Voltage harmonics are defined as voltage components that have a frequency that is an integer multiple of the fundamental frequency. Logging function A records each individual voltage harmonic, up to the 50th. These values are averaged over the interval length defined in PQ Log.

Current Harmonics

Current harmonics are defined as current components that have a frequency that is an integer multiple of the fundamental frequency of the line power current. Logging function A records each individual harmonic of the phase currents and the neutral current, up to the 50th order, and presents the harmonics as absolute values. The values are averaged over the interval length defined in PQ Log.

Mains Signaling

Voltage components that have frequencies that are not integer multiples of the fundamental frequency of the line power voltage are called Mains Signaling voltages or ripple-control voltages (“interharmonics”). The Logger can be programmed to record up to five interharmonics with a resolution of 5 Hz. This function can also be used to monitor ripple-control signals by entering the signal frequency of the local utility.

The Logger measures the three second RMS value of each interharmonic and establishes statistics for EN50160 (European standard) evaluation. These statistics are available after a minimum recording time of 24 hours, or after regular termination of the measuring job and can be exported from PQ Log and evaluated later.

Additionally, the Logger provides a long term recording of the interharmonics. You can select from the following special measurement methods in the PQ Log software:

- 200 ms maximum value (recommended for estimating ripple-control signal levels)
- 200 ms minimum value
- 3 seconds maximum value
- Average value over interval

In PQ Log, the frequency can be entered with a resolution of 0.5 Hz, but for evaluation, the values are corrected to a bandwidth of 5 Hz. One frequency can be defined for each band: for example, for a ripple-control signal of 183 Hz, the values will be corrected to 185 Hz). Interharmonics of voltages and currents with these frequencies are recorded.

See the PQ Log manual for details.

THD V – In Function A

Function A:
$$THDV = \frac{\sqrt{\sum_{n=2}^{50} V_n^2}}{V_1}$$

V_n : RMS value of harmonic frequency #n.

V_1 : RMS value of the fundamental frequency.

THDV: total contents of harmonics of the line power voltage as a percentage of the fundamental.

This algorithm is according to EN 61000-4-7.

THD of currents:

Function A:
$$THDI = \frac{\sqrt{\sum_{n=2}^{50} I_n^2}}{I_1} \quad \text{and} \quad THDI(A) = \sqrt{\sum_{n=2}^{50} I_n^2}$$

I_n : RMS value of harmonic frequency #n.

I_1 : RMS value of the fundamental frequency.

THDI: total contents of harmonics of the current as a percentage of the fundamental.

Calculation of THD in Measuring Function P

THD – Measuring Function P

Function P does not measure harmonic values.

$$\text{Voltages: } THDV = \frac{\sqrt{V_{RMS}^2 - V_1^2}}{V_1}$$

V_{RMS} : RMS value of the total signal

V_1 : RMS value of the fundamental

$$\text{Currents: } THDI = \frac{\sqrt{I_{RMS}^2 - I_1^2}}{I_1}$$

I_{RMS} : RMS value of the total signal

I_1 : RMS value of the fundamental

Note

THDI for currents < 5 % of IE (measuring range) can have additional uncertainties, or can be suppressed.

Harmonics up to 50th order are taken into account.

Flicker

Flicker is the visual impression of unsteadiness in a light source whose luminance or spectral distribution changes over time. Flicker, see Figure 14, is logged in accordance with the IEC 61000-4-15 standard. The short-term (st) flicker P_{st} is logged over a default standard interval of 10 minutes, and is used to calculate the long-term (lt) flicker P_{lt} by taking the sliding average of 12 short term values. The interval value can be changed as needed in PQ Log.

Formula for Plt Function

$$Plt = \sqrt[3]{\sum_{i=1}^{12} \frac{Pst^3}{12}}$$

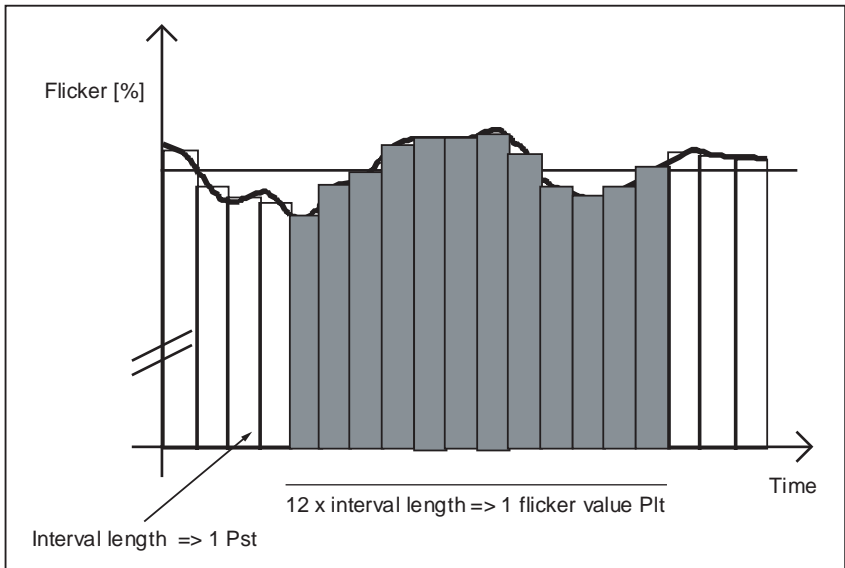

Figure 14. Measuring Flicker Values

egb020.eps

Unbalance

The ratio of negative-to-positive-sequence harmonics is calculated with the angles and magnitudes of the phase voltages taken into account. These values are averaged over the interval length defined in PQ Log.

Frequency

The line power frequency is measured and averaged over 10 seconds and the resulting values are divided into 42 classes for establishing statistics. Values are also averaged over the interval length defined in PQ Log.

Current Logging

The maximum values of the currents (L1 or A, L2 or B, L3 or C and N) are measured, and the interval value of the current is calculated using the mean value over the RMS values of the interval defined in PQ Log.

Logging Function A

If a 3-phase current sensor is connected, the neutral current is calculated on a sample basis from the phase currents. If a 3-phase+N sensor is detected, you can select between logging and calculating the neutral current in PQ Log.

I_{peak}

The peak values of the current (samples, not RMS values) are averaged in the PQ Log software over the predefined measuring interval.

Note

Short peak values do not contribute much to the average value and so I_{\max} can be higher than I_{peak} .

Crest Factor (CF)

The crest factor (CF) of the currents (L1 or A, L2 or B, L3 or C, and N) is the ratio of current peak value divided by current RMS value, and is averaged over the interval length defined in PQ Log. For sinusoidal signals, CF = 1.41, and for square waves, CF = 1.00

Power

The power values (L1 or A, L2 or B, L3 or C and N) are averaged over the interval length, and the maximum value of each is recorded.

The response time can be set to 1 second or 1 minute, and is independent of the response time for voltage and current.

In logging function P, the active power, apparent power, and reactive power of the phases and total power of all three phases is calculated.

Logging function A also calculates the distorting power D of the phases and D_{total} .

Measurement Theory

The following are the equations used by the Logger and PQ Log to produce the results you see in PQ Log. Measurement Function A logs current and voltage harmonics, while Measurement Function P does not:

TRMS value of voltage and current. Basic values on 200 ms per phase

$$V_{bas} = \sqrt{\frac{1}{N} \cdot \sum_{i=1}^N V_i^2}$$

$$I_{bas} = \sqrt{\frac{1}{N} \cdot \sum_{i=1}^N I_i^2}$$

N: Number of samples in 200 ms intervals (2048)

RMS value of voltage and current per logging interval per phase

$$V_{RMS} = \sqrt{\frac{1}{M} \cdot \sum_{j=1}^M V_{basj}^2}$$

$$I_{RMS} = \sqrt{\frac{1}{M} \cdot \sum_{j=1}^M I_{basj}^2}$$

M: Number of samples in 200 ms intervals per logging interval

Active power calculated from FFT from samples of voltage and current. Basic value on 200 ms per phase

$$P_n = V_n \cdot I_n \cdot \cos \varphi_n$$

V_n : RMS value of voltage harmonics of order n

I_n : RMS value of current harmonics of order n

n Order of the harmonics

φ_n : Phase angle between current and voltage harmonics of order n

P_n : Harmonics of the active power of order n

Fundamental

$$P_{bas} = \sum_{n=1}^{50} P_n$$

$$Ph1_{bas} = P_1$$

Active power of logging interval per phase

$$P = \frac{1}{M} \cdot \sum_{j=1}^M P_{bas\ j}$$

$P_{bas\ j}$: 200 ms value

M: Number of 200 ms intervals per logging intervals

Total active power on all three phases

$$P_{total} = \sum_{k=1}^3 P_k$$

P_k : Active power of the phase

k: Phase (k = 1, 2, 3)

Absolute value of the active power per interval per phase

$$P_{betr} = \frac{1}{M} \cdot \sum_{j=1}^M |P_{bas\ j}|$$

Sum of the absolute values of the active power on all three phases

$$P_{betr\ total} = \frac{1}{M} \sum_{j=1}^M |P_{bas\ 1} + P_{bas\ 2} + P_{bas\ 3}|$$

Apparent power based on RMS values of voltage and current. Basic values on 200 ms per phase

$$S_{bas} = V_{bas} \cdot I_{bas}$$

Apparent power per logging interval per phase

$$S = \frac{1}{M} \cdot \sum_{j=1}^M S_{bas\ j}$$

$S_{bas\ j}$: 200 ms value

M: Number of 200 ms intervals per logging intervals

Total apparent power on three phases

$$S_{total} = \sum_{K=1}^3 S_k$$

k: Phase (k = 1, 2, 3)

Distortion power. Basic value on 200 ms per phase

$$D_{bas} = \sqrt{S_{bas}^2 - P_{bas}^2 - Q_{bas}^2}$$

Distortion power per interval per phase

$$D = \frac{1}{M} \cdot \sum_{j=1}^M D_{bas\ j}$$

$D_{bas\ j}$: 200 ms value

M: Number of 200 ms intervals per logging interval

Total distortion power on three phases

$$D_{total} = \sum_{k=1}^3 D_k$$

Distortion power per phase

$$PF = \lambda = \frac{|P|}{S} \cdot \frac{Q}{|Q|}$$

Total distortion power on three phases

$$PF_{total} = \lambda_{total} = \frac{|P_{total}|}{S_{total}} \cdot \frac{Q_{total}}{|Q_{total}|}$$

Tangent φ per phase

$$\tan \varphi = \frac{Q}{P}$$

Total tangent φ on three phases

$$\tan \varphi_{total} = \frac{Q_{total}}{P_{total}}$$

Active power of the fundamental per phase
Basic value for 200 ms

$$Ph1_{bas} = P_1$$

Active power of the fundamental per phase per interval

$$Ph1_{bas} = \frac{1}{M} \cdot \sum_{j=1}^M Ph1_{bas\ j}$$

Total active power of the fundamental for three phases

$$Ph1_{total} = \sum_{k=1}^3 Ph1_k$$

Apparent power of the fundamental per phase. Basic value for 200 ms.

$$Sh1_{bas} = V_1 \cdot I_1$$

Apparent power of the fundamental per phase per interval

$$Sh1 = \frac{1}{M} \cdot \sum_{j=1}^M Sh1_{bas\ j}$$

Power factor of the fundamental per phase

$$\cos \varphi_1 = \frac{|Ph1_{total}|}{Sh1} \cdot \frac{Qh1}{|Qh1|}$$

Total power factor on all three phases

$$\cos \varphi_{total} = \frac{|Ph1_{total}|}{Sh1_1 + Sh1_2 + Sh1_3} \cdot \frac{Qh1_{total}}{|Qh1_{total}|}$$

Active energy per phase and total Active power accumulated on each logging interval

Sign of PF, $\tan \varphi$, $\cos \varphi$:

Sign “+” : Q positive (“inductive”)

Sign “-” : Q negative (“capacitive”) independent of the sign of active power P

Maintenance

⚠ Caution

Maintenance work on the device is done only by trained and qualified personnel at a company approved service center within the warranty period. For locations of Fluke Service Centers worldwide and contact information, see the Fluke website: www.fluke.com.

With the proper use, the Logger does not require special maintenance other than periodic calibration at a Fluke calibration center.

If the Logger gets dirty, wipe it off carefully with a damp cloth without cleaning agents.

Lithium Battery

The 1745 Logger contains a vanadium pentoxide lithium rechargeable battery and a sealed gel-type, lead-acid battery. These batteries are automatically recharged during normal operation. Neither one is user-servicable.

Disposal

If you discard the Logger, you must recycle it at an appropriate recycling center as required by local regulations.

Technical Specifications

Logging Parameters – Overview

Table 7 shows an overview of the logging parameters.

Table 7. Logging Parameters - Overview

Measuring Function	P	A
Voltage: mean, min, max values	●	●
Current: Mean, max-values	●	●
Neutral current N	●	●
Voltage events	●	●
Power: P, P , S, D, PF, tangent	●	●
Power total P, P , S, D, PF, tangent	●	●
Energy	●	●
Flicker: Pst, Plt	●	●
Voltage harmonics		●
Current harmonics (L1 or A, L2 or B, L3 or C, N, up to 50 th order)		●
Interharmonics, ripple-control signals	●	●
THDV (voltage)	●	●
THDI (current)	●	●
CF (crest factor current)	●	●
Unbalance	●	●
Frequency	●	●

Maximum Number of Intervals for Logging Function P

The maximum recording period can be calculated by multiplying the interval time defined in PQ Log with the maximum number of intervals in the following table.

Version	P, V+I	A, V+I
Averaged periods	> 24,000	> 10,000

General Information

Intrinsic uncertainty	Valid for reference conditions, and guaranteed for two years.
Quality system	Developed, designed, and manufactured according to DIN ISO 9001.
Recalibration interval	Fluke recommends a recalibration interval of no more than two years, depending on use.
Reference conditions	23 C \pm 2 K, 230 V \pm 10 % 50 Hz \pm 0.1 Hz / 60 Hz \pm 0.1 Hz Phase sequence: L1 or A, L2 or B, L3 or C Interval length: 10 minutes, 3-phase Wye configuration. Power supply: 88 to 265 V AC

Environmental Specifications

Working temperature range	-10°C to +55°C
Operating temperature range	0°C to +35°C
Storage temperature range	-20°C to +60°C
Reference temperature range	23°C ± 2 K
Relative humidity	10 to 90 %, no condensation
Housing	Robust, compact housing of CYCOLOY
Protection	IP50 per EN 60529
Safety	EN 61010-1 600 V CAT III, 300 V CAT IV pollution degree 2, double insulation
Type test voltage	5.2 kV AC, 50 Hz / 60 Hz, 5 s

EMC

Emission	IEC/EN 61326-1, EN 55022
Immunity	IEC/EN 61326-1

Power Supply

Functional range	88 to 660 V RMS AC absolute, 50 Hz / 60 Hz
Safety	EN 61010-1 600 V CAT III, 300 V CAT IV, pollution degree 2, double insulation
Fuse	Power supply fuse can be replaced only in service facility. Supply can be connected in parallel to measuring inputs (up to 660 V RMS AC).
Power consumption	5 W
Memory capacity	8 MB Flash-EPROM
Intervals	> 10000 intervals, > 70 days with 10 min intervals
Events	> 13000

Memory model	Linear or circular, user-selectable
Interface	RS-232, 9600 to 115.000 Baud, automatic selection, 3-wire communication.
Dimensions	170 mm x 125 mm x 55 mm
Weight	Approx. 0.9 kg

Measurement

A/D converter	16 bit
Sampling frequency	10.24 kHz
Anti-aliasing filter	FIR-Filter, $f_C = 4.9$ kHz
Frequency response	Uncertainty < 1 % of V_m for 40 Hz to 2500 Hz
Interval length	1, 3, 5, 10, or 30 seconds, 1, 5, 10, 15, or 60 minutes
Averaging time for min/max values	$\frac{1}{2}$, 1 line power period, 200 ms 1, 3, 5 s
Time base	Resolution: 10 ms (at 50 Hz) deviation: 2 s/day at 23°C.

Input Voltage

Input range V_1 P-N:	69, 115, 230, or 480 V AC
Input range V_1 P-P	120, 200, 400, or 830 V AC
Max. overload voltage	1.2 V_1
Input range selection	Automatically set by user-entered nominal voltage value.
Connections	P-P or P-N, 1- or 3-phase
Nominal voltage V_N	≤ 999 kV (using PTs and ratios)
Input resistance	Approx. 820 k Ω per channel. Lx-N Single phase (L1 or A, L2 or B, L3 or C connected): app. 300 k Ω
Intrinsic uncertainty	0.1 % of V_1
Voltage transformer	Ratio : < 999 kV / V_1
Ratio selection	Optional: user-selectable

Current Input with Flexi Set

Input ranges I_1 L1 or A, L2 or B, L3 or C, N:	15, 150, 1500, or 3000 A AC
Measuring range	0.75 A to 3000 A AC
Intrinsic uncertainty	< 2 % of I_1
Position influence	Max. ± 2 % of m.v. for distance conductor to measuring head >30 mm
Stray field influence	< ± 2 A for I_{ext} = 500 A AC and distance to measuring head >200 mm
Temperature coeff	< 0.005 % / K
Current transformer	Ratio : ≤ 999 kA / I_1
Ratio selection	Optional: user-selectable
Connection	Power type selectable in PQ Log

Current Input for Clamp

Input signal:	0.5 V AC nominal (for I_1) 1.4 V peak
Intrinsic uncertainty	< 0.3 % of I_1
Max. overload	10 V AC
Input resistance	App. 8.2 k Ω
Current transformer	Ratio : ≤ 999 kA / $\leq I_1$
Ratio selection	By job programming

General Specifications

RMS Logging Slow Voltage Variations

Logging values: Mean value	RMS values averaged over interval length
Min, Max values	Averaging with selectable averaging time from half-cycle to 5 s
Max value	Max. 10 ms RMS value per interval
Min value:	Min. 10 ms RMS value per interval

Current Logging Values

Mean value	RMS values averaged over interval length
Max value	Highest RMS value per interval

Events Dips, Swells, Interruptions

Limit value	Variable Lower limit: 0 to 95 % V_N , Upper limit: 105 to 120 % V_N Set in PQ Log
Range	0 to $V_1 + 20\%$
Logging value	Half-cycle RMS value
Operating uncertainty	< 2 % of V_1
Response time	$\frac{1}{2}$ line power period

Flicker

Logging value	Flicker severity (P_{It} / P_{st}) according to IEC 61000-4-15
Intrinsic uncertainty P_{st}	< 5 % of measured value
Measuring range P_{st}	0.4 to 4

Power P, S, |P|

Active power P	As per EN 61036, class 2
Distorting power D	As per EN 61268, class 2 (A-version only)
Max value	Highest value per interval
Min value	Smallest value per interval
Phase uncertainty	< 0.3 degrees
Conditions	Conductor centered within clamp jaws or Flexi Set.

Harmonics (Logging Function A Only)

V_m , I_m , THDV, THDI per IEC/EN 61000-4-7, class B

Voltage harmonics (function A) intrinsic uncertainty:	For $V_m < 3\% V_N$: < 0.15 % V_N
	For $V_m \geq 3\% V_N$: < 5 % V_m
Current harmonics (function A) Intrinsic uncertainty	For $I_m < 10\% I_N$: < 0.5 % I_N
	For $I_m \geq 10\% I_N$: < 5 % I_m
THD V (function A) intrinsic uncertainty at V_N	For THD V < 3 %: < 0.15 %
	For THD V $\geq 3\%$: < 5 %
THD V (function P) intrinsic uncertainty at V_N	For THD V < 3 %: < 1 %
	For THD $\geq 3\%$: < 5 %
THD I (functions A, P) intrinsic uncertainty at I_1	For THD I < 3 %: < 2 %
	For THD I $\geq 3\%$: < 5 %

Statistics

Frequency	42 classes for 10 s mean values Ripple-control signals.
Interharmonics	21 classes for 3 s mean values.

Analysis of logging data

Programming and analysis is done by PQ Log software on PC.

Logging Function Parameters

Logging Values

Voltage L1 or A, L2 or B, L3 or C: phase-phase or phase-neutral:

- Voltage (mean, max, min values)
- Voltage harmonics 1st to 50th order (Logging Function A only)
- THDV (harmonic contents of voltage)
- Interharmonics 5 to 2500 Hz (in steps of 0.5 Hz) (Logging Function A only)
- Flicker P_{st}, P_{it}
- Unbalance
- Signaling voltages
- Frequency
- Voltage events (dips, swells, interruptions)

Current L1 or A, L2 or B, L3 or C, and N:

- Current (mean, max values)
- Harmonics of phase and neutral currents up to 50th order (Logging Function A only)
- Crest factor and peak values of the currents

Power:

- Active power P (mean, min, and max values)
- Absolute values active power $|P|$ (mean, min, and max values)
- Distorting power D (mean, min, and max values)
- Apparent power S (mean, min, and max values)
- Power Factor PF, tangent
- Energy per averaging interval

Total power:

- Total power P, $|P|$, D, S
- 3-wattmeter method
- 2-wattmeter method (Aron circuitry)
- 2 ½ wattmeter method

Applications

Power quality:

- Voltage quality analysis according to EN 50160 over a 1-week period (time-activated job)
- Examination of measurement quantities per standards

Disturbance analysis:

- Long-term analysis of line power voltage
- Examination of voltage dips, swells, and harmonic problems (Logging Function A only)
- Flicker measurement
- Examination of ripple control signals (level) (Logging Function A only)
- Specific search for disturbances through correlation of relevant logging quantities (e.g. current, voltage, and flicker), time of occurrence, periodicity

Network Optimization:

- Load logging
- Current logging (with Flexi Set 5 to 3000 A or clamps 1 to 1000 A)
- Capture of current peaks

PQ Log PC Application Software

PQ Log for PCs is the application for use with the 1745 Power Quality Logger. The data are also available in ASCII format.

Programs available for setting up the Logger:

- Averaging period length
- Memory model
- Nominal voltage
- Response time for min, max values
- Power type (wye, delta, etc.)
- Thresholds for event detection, interruptions

Setup:

- Internal clock (date/time)
- Assign 1745 Power Quality Logger instrument name
- Parameters for data export
- Software updates

Analysis:

- ASCII data export
- Graphical summary of all EN50160 parameters
- Live reading viewing

Live Reading (Online Test)

Figure 15 shows a typical display of online test:

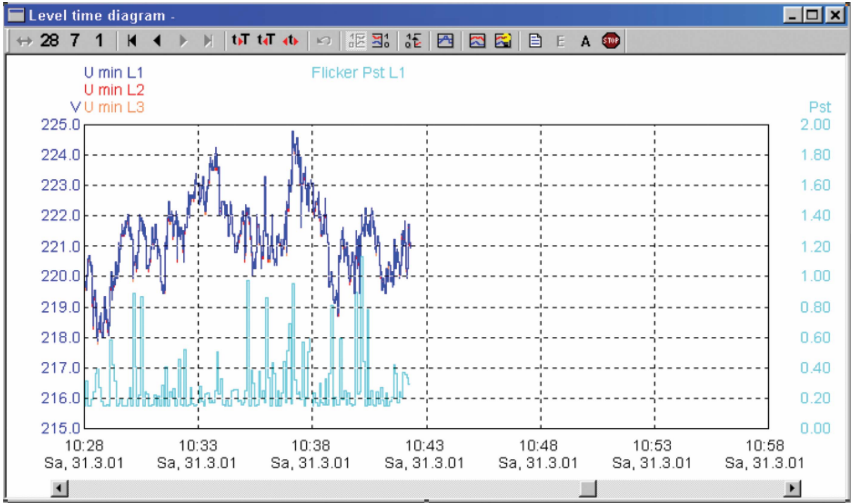

egb024.bmp

Figure 15. Live Reading (Online Test)

ASCII Export

Figure 16 shows a typical display of ASCII export.

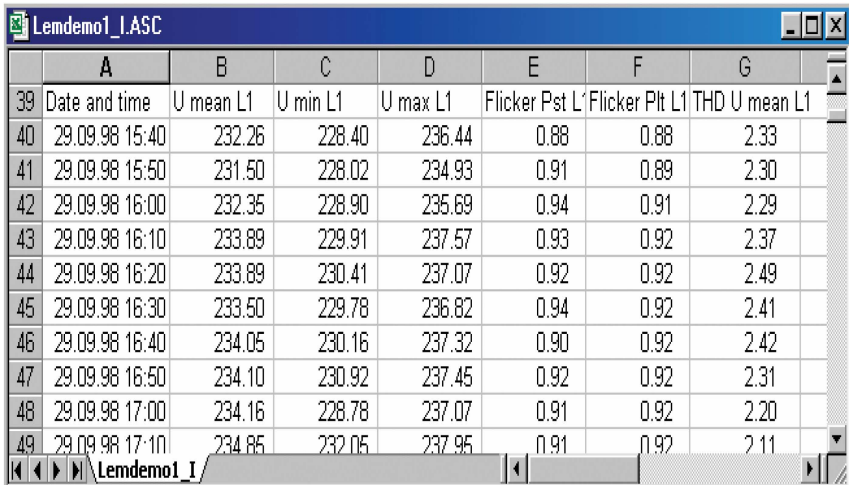

	A	B	C	D	E	F	G
39	Date and time	U mean L1	U min L1	U max L1	Flicker Pst L1	Flicker Plt L1	THD U mean L1
40	29.09.98 15:40	232.26	228.40	236.44	0.88	0.88	2.33
41	29.09.98 15:50	231.50	228.02	234.93	0.91	0.89	2.30
42	29.09.98 16:00	232.35	228.90	235.69	0.94	0.91	2.29
43	29.09.98 16:10	233.89	229.91	237.57	0.93	0.92	2.37
44	29.09.98 16:20	233.89	230.41	237.07	0.92	0.92	2.49
45	29.09.98 16:30	233.50	229.78	236.82	0.94	0.92	2.41
46	29.09.98 16:40	234.05	230.16	237.32	0.90	0.92	2.42
47	29.09.98 16:50	234.10	230.92	237.45	0.92	0.92	2.31
48	29.09.98 17:00	234.16	228.78	237.07	0.91	0.92	2.20
49	29.09.98 17:10	234.85	232.05	237.95	0.91	0.92	2.11

egb025.bmp

Figure 16. ASCII Export

For special cases, additional evaluations are available:

- Graphic representation of measured data
- Timeplot diagrams
- Application oriented analysis
- Logging value list
- Table of events (UNIPEDA DISDIP)
- Table summary
- Cumulative frequency, harmonics (Logging Function A only)
- Statistical values
- All exceeding table
- Most critical values

Timeplot Diagram

Figure 17 shows a typical display of Timeplot diagram:

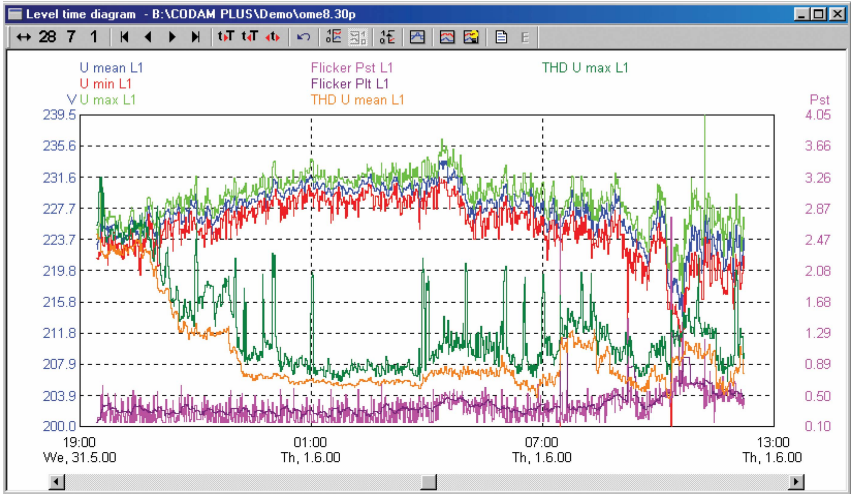
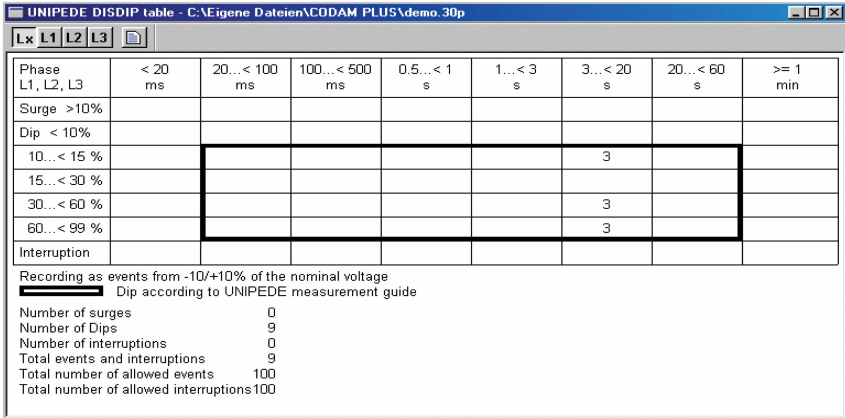

Figure 17. Timeplot Diagram

egb026.bmp

UNPEDE DISDIP Table

Figure 18 shows a typical display of UNPEDE DISDIP table:



egb027.bmp

Figure 18. UNPEDE DISDIP Table

Cumulative Frequency – Harmonics

Figure 19 shows a typical display of cumulative frequencies for current and voltage harmonics:

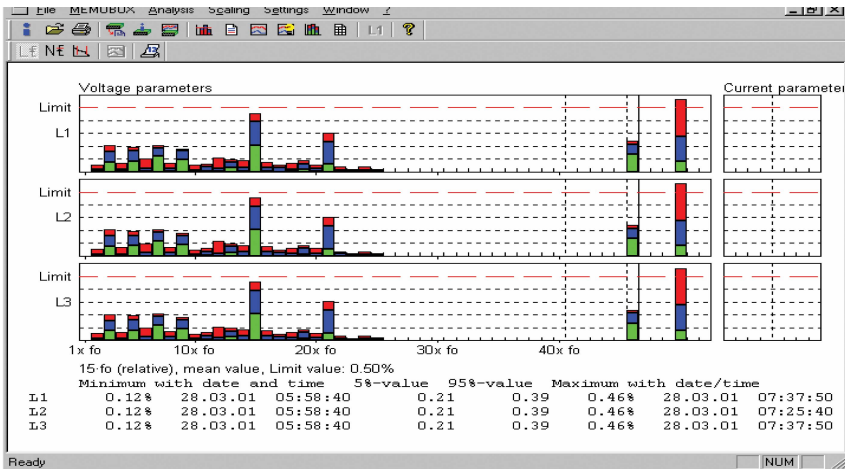

egb028.bmp

Figure 19. Cumulative Frequency - For Voltage and Current Harmonics

—A—

Anti aliasing filter, 27
Apparent Power, 37

—C—

Completing the Logging, 24
Connecting the clip on probes, 15
Connection modes, 26
Connections for Medium Voltage
 Networks, 22
Crest Factor, 36
Current, 36
Current Harmonics, 32

—D—

Disposal, 42

—E—

Evaluation, 25
Extreme values, 29

—F—

Flicker, 35
Frequency, 36

—I—

Installation at the measuring site, 18
Interharmonics, 12
Interval length, 12
Ipeak, 36

—L—

Limit values for events, 12
Lithium Battery, 42
Logging Configurations, 11

Logging input for voltages, 10
Logging segments, 12

—M—

Maximum nominal voltages, 6, 17
Methods of Logging, 25

—N—

Nominal Voltage, 26

—P—

Power factor, 37
Program a logging job, 13

—R—

Reactive Power, 37

—S—

Sampling rate, 27
signaling voltages, 12
Signaling voltages, interharmonics, 32

—T—

THD I, 34
THD V, 33

—U—

Unbalance, 36
User Interface, 1

—V—

Voltage dips/swells, 31
Voltage Harmonics, 31
Voltage interruptions, 30
Voltage variations, 28



**205 Westwood Ave
Long Branch, NJ 07740
1-877-742-TEST (8378)
Fax: (732) 222-7088
salesteam@Tequipment.NET**