



TS[®] 90

Cable Fault Finder

Users Guide

The logo for Tequipment.NET, featuring a large red letter 'T' on the left. To its right is a small American flag icon with the word "USA" above it. Below the flag, the word "Tequipment" is written in blue, and ".NET" is written in red. A blue line connects the bottom of the 'T' to the start of "Tequipment".	<p>205 Westwood Ave Long Branch, NJ 07740 1-877-742-TEST (8378) Fax: (732) 222-7088 salesteam@Tequipment.NET</p>
--	--

PN 2448335

October 2005

©2005 Fluke Corporation. All rights reserved. Printed in China.
All product names are trademarks of their respective companies.

LIMITED WARRANTY AND LIMITATION OF LIABILITY

Each Fluke Networks product is warranted to be free from defects in material and workmanship under normal use and service. The warranty period for the mainframe is 18 months and begins on the date of purchase. Parts, accessories, product repairs and services are warranted for 90 days, unless otherwise stated. Ni-Cad, Ni-MH and Li-Ion batteries, cables or other peripherals are all considered parts or accessories. The warranty extends only to the original buyer or end user customer of a Fluke Networks authorized reseller, and does not apply to any product which, in Fluke Networks' opinion, has been misused, abused, altered, neglected, contaminated, or damaged by accident or abnormal conditions of operation or handling. Fluke Networks warrants that software will operate substantially in accordance with its functional specifications for 90 days and that it has been properly recorded on non-defective media. Fluke Networks does not warrant that software will be error free or operate without interruption.

Fluke Networks authorized resellers shall extend this warranty on new and unused products to end-user customers only but have no authority to extend a greater or different warranty on behalf of Fluke Networks.

Warranty support is available only if product is purchased through a Fluke Networks authorized sales outlet or Buyer has paid the applicable international price. Fluke Networks reserves the right to invoice Buyer for importation costs of repair/replacement parts when product purchased in one country is submitted for repair in another country.

Fluke Networks warranty obligation is limited, at Fluke Networks option, to refund of the purchase price, free of charge repair, or replacement of a defective product which is returned to a Fluke Networks authorized service center within the warranty period.

To obtain warranty service, contact your nearest Fluke Networks authorized service center to obtain return authorization information, then send the product to that service center, with a description of the difficulty, postage and insurance prepaid (FOB destination). Fluke Networks assumes no risk for damage in transit. Following warranty repair, the product will be returned to Buyer, transportation prepaid (FOB destination). If Fluke Networks determines that failure was caused by neglect, misuse, contamination, alteration, accident or abnormal condition of operation or handling, or normal wear and tear of mechanical components, Fluke Networks will provide an estimate of repair costs and obtain authorization before commencing the work. Following repair, the product will be returned to the Buyer transportation prepaid and the Buyer will be billed for the repair and return transportation charges (FOB Shipping point).

THIS WARRANTY IS BUYER'S SOLE AND EXCLUSIVE REMEDY AND IS IN LIEU OF ALL OTHER WARRANTIES, EXPRESS OR IMPLIED, INCLUDING BUT NOT LIMITED TO ANY IMPLIED WARRANTY OR MERCHANTABILITY OR FITNESS FOR A PARTICULAR PURPOSE. FLUKE NETWORKS SHALL NOT BE LIABLE FOR ANY SPECIAL, INDIRECT, INCIDENTAL OR CONSEQUENTIAL DAMAGES OR LOSSES, INCLUDING LOSS OF DATA, ARISING FROM ANY CAUSE OR THEORY.

Since some countries or states do not allow limitation of the term of an implied warranty, or exclusion or limitation of incidental or consequential damages, the limitations and exclusions of this warranty may not apply to every buyer. If any provision of this Warranty is held invalid or unenforceable by a court or other decision-maker of competent jurisdiction, such holding will not affect the validity or enforceability of any other provision.

4/04-18

Fluke Networks
PO Box 777
Everett, WA 98206-0777
USA

Table of Contents

Title	Page
Introduction	1
Registration	1
Contacting Fluke Networks	1
Safety Information	2
Design Features	3
Physical Characteristics	4
Line Cords and Accessories	5
Operation	5
Installing Batteries	6
Turning on the Tester	7
Automatic Power-Down	7
Testing Cables	7
SmartTone™ Positive Identification System	8
Velocity of Propagation (VOP)	10
Applications	12
Testing Wire in Conduit	14
Testing a Wire Pair in a Conduit	14
Testing a Single Wire in a Conduit	14
Inventory Management	14
In Case of Unstable or Unusual Readings	19
Time Domain Reflectometry (TDR) Technology	19
VOP Variations	22
Maximum Length	23
Frequently Asked Questions	24
If Something Seems Wrong with the Tester	28
Maintenance	29
Specifications	30

TS90 Cable Fault Finder

Users Guide

TS[®]90 Cable Fault Finder

Introduction

The TS90 Cable Fault Finder is a portable handheld device used by installers, repair technicians and other authorized personnel for locating problems on installed cable pairs and for managing cable inventory.

Registration

Registering your product with Fluke Networks gives you access to valuable information on product updates, troubleshooting tips, and other support services. To register, fill out the online registration form on the Fluke Networks website at www.flukenetworks.com/registration.

Contacting Fluke Networks



www.flukenetworks.com



support@flukenetworks.com









+1-425-446-4519 or 1-800-283-5853

- Australia: 61 (2) 8850-3333 or 61 3 9329 0244
- Beijing: 86 (10) 6512-3435
- Brazil: 11 3044 1277
- Canada: 1-800-363-5853
- Europe: +44-(0)1923-281-300
- Hong Kong: 852 2721-3228
- Japan: 03-3434-0510
- Korea: 82 2 539-6311
- Singapore: 65-6799-5566
- Taiwan: (886) 2-227-83199

Visit our website for a complete list of phone numbers.

Safety Information

The following IEC symbols are used either on the tester or in the manual:

	Warning: Risk of personal injury. See the manual for details. Caution: Risk of damage or destruction to equipment or software. See the manual for details.
	Warning: Risk of electric shock.
	Earth ground
	Conformité Européenne. Conforms to relevant European Union directives.
	CAN/CSA-C22.2 No. 60950-1-03 CAN/CSA-C22.2 No. 1010.1-92 + CSA-C22.2 No. 1010.1B-97, UL/ANSI 3111-1
	Do not put products containing circuit boards into the garbage. Dispose of circuits boards in accordance with local regulations.

Warning

If this product is used in a manner not specified by the manufacturer, the protection provided by the product may be impaired.

Design Features

Design features of the TS90 Cable Fault Finder include:

- Easy to use
- Tests all common cable pairs
- Provides low cost protection against lost time due to cable and connector problems
- Single button operation
- Up to 2500 feet, dependent on cable type
- Accurate to ± 2 feet for short cables
- Accurate to ± 5 feet for cables from 10 feet to 200 feet and $\pm 3\%$ and ± 5 feet for cables longer than 200 feet
- Bright 0.4 inch LED display
- Up to 4 readings per second
- Audible indication of shorted wires and external voltage greater than 15 Vac
- Automatic adjustments
- Tone injection with the SmartTone™ positive identification system
- Input protected to 250 Vac
- Components protected against damage from moisture
- Fifty hour battery life, intelligent auto-off
- Low battery indicator
- Uses 4 AA batteries (included)
- High strength plastic (ABS) housing

Physical Characteristics

See Figure 1.

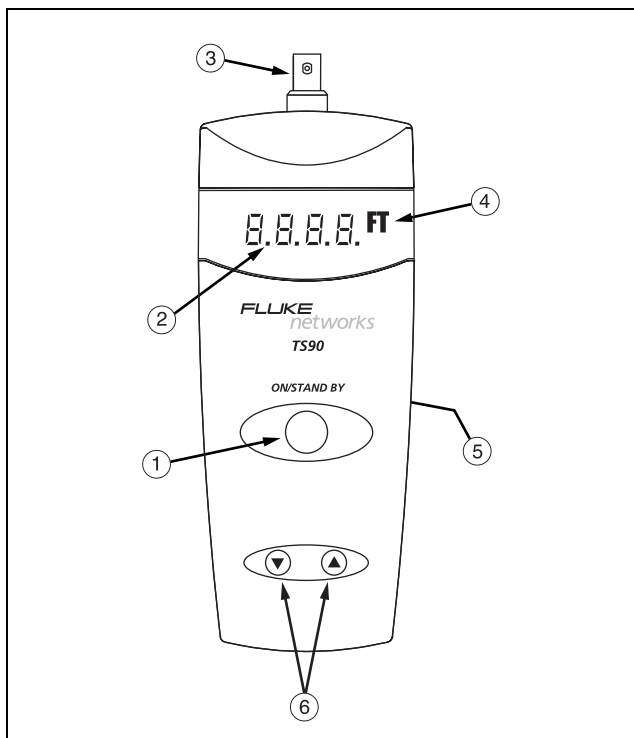

cab01.eps

Figure 1. Physical Characteristics

- ① Power button, which turns the tester on and off.
- ② Low battery LED.
- ③ Female BNC (British Naval Connector).
- ④ LCD display with units indication (feet).

- ⑤ The battery compartment is on the back of the tester. The battery cover includes a label showing some common velocity of propagation (VOP) values.
- ⑥ The two smaller buttons are used to adjust the tester's VOP up or down. See "Velocity of Propagation" on page 10.

Line Cords and Accessories

Use only line cords (test leads) approved by Fluke Networks. Other cords may cause incorrect measurements. For information on availability of additional line cords and accessories, contact your local Fluke Networks authorized distributor.

Operation



DO NOT USE the tester to test cables that may have hazardous voltages present. When the tester indicates the presence of high ac voltages, **CAREFULLY DISCONNECT IMMEDIATELY** to prevent any personal injury. Hazardous dc voltages can be present on any cable at any time. The tester does **NOT** detect or indicate the presence of dc voltages. Use care when connecting to cables.

Do not use the test set if it is damaged. Before you use the test set, inspect the case. Look for cracks or missing plastic. Pay particular attention to the insulation surrounding the connectors.

Always handle the clip leads and the cables by their insulation, NEVER directly by the conductive wire. Use only the insulated clips provided to connect to any wire or cable.

Caution

Use only line cords approved by Fluke Networks. Other cords may cause incorrect measurements.

Legal requirements may exist regarding permission to connect equipment to a Telecom network operated by a public network operator.

Installing Batteries

The tester uses 4 AA batteries (included). Install the batteries in the battery compartment on the back of the tester.

Warning

To avoid electric shock, disconnect measuring terminals before opening the battery door.

To remove the battery door, push the plastic tab in the direction of the arrow and lift off the door. Observe correct polarity when inserting the batteries. The polarity is marked on the inside of the battery compartment. Reinstall the battery door before connecting the tester to anything.

Note

To extend battery life, remove batteries when the tester is not in use.

Turning on the Tester

Turn the tester on by pressing the **ON/STANDBY** button. The tester performs a self test each time it is turned on. During the self test, the tester displays **8.8.8.8**.

Automatic Power-Down

To save battery power, the tester automatically turns off after five minutes if it is not connected to anything, or one hour after you connect to a cable. Also, if the **ON/STANDBY** button is held down for more than 20 seconds, the tester turns off. This prevents battery drain should some object in your tool box be leaning on the button.

Testing Cables

Caution

When testing telephone cables, connect only to non-working circuits. If accidentally connected to a working ADSL or hi-cap circuit, the tester will cause an outage.

To test a cable, attach line cord clips to a pair of wires at one end of the cable you are testing.

The tester displays the distance (in feet) to the closest fault it finds. Table 1 describes the tester's display and beeper indications.

Table 1. Display and Beeper Indications

Condition	Display ¹	Beeper
Open cable ²	LLLL	Off
Shorted cable	LLLL	Continuous On
Cable is too long to measure	-Err	Staggered
A dc load (light bulb, TV, etc.) is detected	-Err	Staggered
>15 Vac is detected	8888 Flashing	Rapid
Low battery, open cable	L.LLL	Off
Failed self test	8888	Off
Cable cannot be measured	-Err	Staggered
<p>1. LLLL = the length to the fault.</p> <p>2. An open may be a break in a wire or a separation between the wires in the pair. If one wire in the pair separates from the other wire for 1 ft or more, the tester indicates an open at the separation.</p>		

SmartTone™ Positive Identification System

See Figure 2.

The tester injects a tone onto the connected pair concurrently with fault locating signals. This tone is compatible with most tone probes. When you are using a tone probe to identify a wire pair, the tone volume from nearby wires may be indistinguishable from the tone from the target pair. The SmartTone Positive Identification System lets you positively identify the wire pair. The tone has 5 frequency and cadence options.

To use the SmartTone System:

- 1 Connect the tester to a wire pair; then turn on the tester.
- 2 At the other end of the cable, use your tone probe to find the wire pair by probing for the pair with the loudest tone.
- 3 Short the wire pair together, then release the short.
 - If you DO NOT hear a change in the tone, then you have not found the correct pair.
 - If you DO hear a change, then you have **POSITIVE CONFIRMATION** that you have found the correct pair.

Note

The tone is not audible on the tester's beeper.

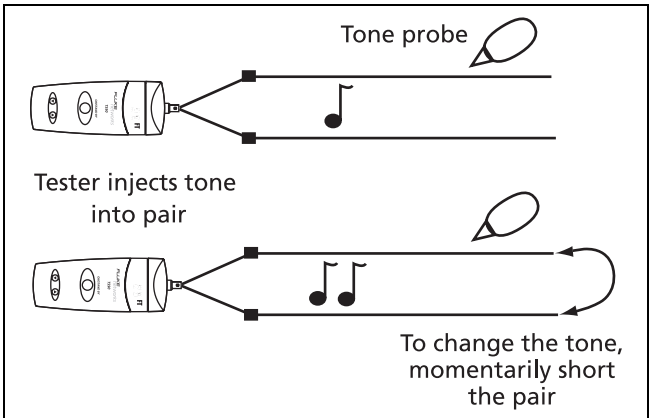

cab02.eps

Figure 2. SmartTone Positive Identification System

Velocity of Propagation (VOP)

VOP is a cable specification indicating the speed at which a signal travels down the cable. A VOP of 66 means the signal travels at 66 % of the speed of light. The tester uses VOP to calculate cable length. See “Time Domain Reflectometry (TDR) Technology” on page 19 for details.

Here are some important points about VOP:

- Different cables have different VOP settings.
- The tester’s default VOP setting of 66 is suitable for most applications.
- Using the VOP specified for a cable ensures the most accuracy in fault location, length measurements, and inventory management. Table 2 and Table 3 show VOP values for common cables. Some common VOP values are also listed on the tester’s battery door.

You can set the tester’s VOP to a known value, or you can use the tester to determine the VOP for a known length of cable.

To set the VOP to a known value:

- 1 Turn the tester on while holding down the **UP** or **DOWN** button. In this mode, the display alternately shows the VOP setting (-**VV**-) and the calculated length (**LLLL**).
- 2 When the VOP setting is displayed, press the **UP** or **DOWN** button. This keeps the VOP value on the display for adjustment.
- 3 Use the **UP** and **DOWN** buttons to set the VOP to the desired value.
- 4 To exit the VOP adjustment mode, turn the tester off.

To determine the VOP of a known length of cable:

- 1 Connect a known length of cable to the tester. The cable must be 200 feet (60 meters) or longer (such as an unopened box of wire).
- 2 Turn the tester on while holding down the **UP** or **DOWN** button. In this mode, the display alternately shows the VOP setting (**-VV-**) and the calculated length (**LLLL**).
- 3 When the length setting is displayed, press the **UP** or **DOWN** button. This keeps the length value on the display for adjustment.
- 4 Use the **UP** and **DOWN** buttons to adjust the length to the length of the cable.
- 5 To exit the VOP adjustment mode, turn the tester off.

Notes

While the tester is in VOP adjustment mode, tone is not injected into the cable.

The VOP value reverts to the default of 66 when you change the tester's batteries

Applications

See Figure 3.

The tester locates opens, short circuits, and crosses in any two metallic conductors (twisted, untwisted, coax, copper, aluminum, and steel).

It identifies conductors using the SmartTone feature and an inductive probe (not included) (see Figure 2). Tone can be sent between two technicians to ID multiple pairs. Because the tester beeps when it detects a short circuit, it also serves as a continuity tester.

Multi-Wire Environment

When testing wires in a multi-wire environment, such as 4 wire telephone cable, 8 wire CAT-5 cable, 12-2 with ground ac wire, or several THHN wires inside a conduit, a short could exist between any number of the conductors, including a shield or the conduit. To detect the short, you must connect the tester to the wires that are shorted. This means that to fully test a multi-wire cable, you must check every wire against every other wire including the shields and conduits.

While a quick way to test many conductors against conduit or shield length is to connect all the conductors to one clip lead and the shield to the other lead, this will reduce the impedance of the cable, and measurements may fall below the tester's range. It is more reliable to test the wires individually.

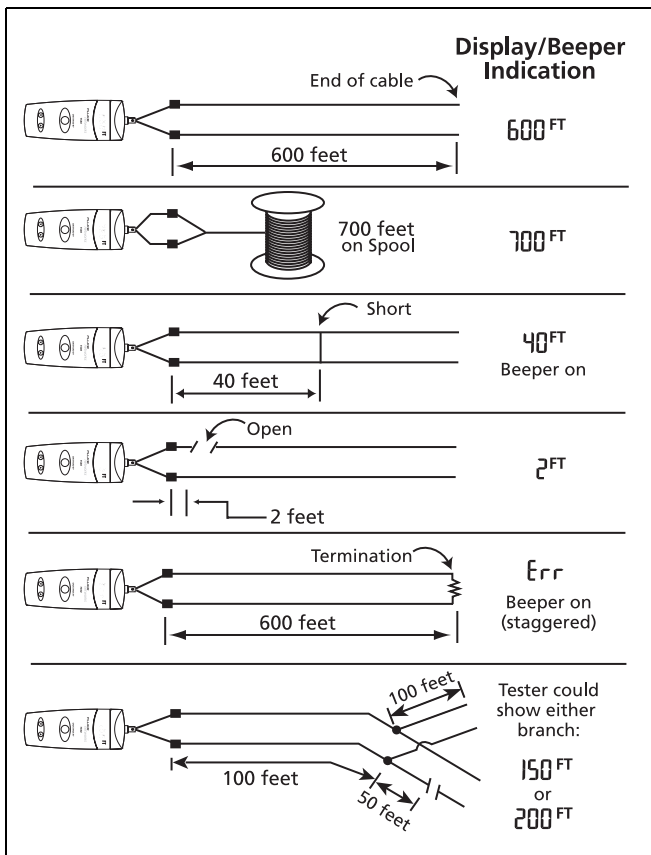

cab03.eps

Figure 3. Testing for Lengths, Shorts, Opens, and Terminations

TS90 Cable Fault Finder Users Guide

Testing Wire in Conduit

There are two methods for testing wire in conduit. You can test a wire pair or a single wire.

Testing a Wire Pair in a Conduit

To test a wire pair, connect the two test leads to the pair. If one wire separates from the other for 1 ft or more, the tester indicates an open at the separation. For example, if the wires separate after exiting the conduit, the tester indicates an open at the end of the conduit.

Testing a Single Wire in a Conduit

You can test a single wire by clipping one test lead to the wire and the other to the conduit. The tester shows the length up to a fault or to the point where the wire separates from the conduit by at least 1 ft. For example, if there is a 2 ft service loop outside the conduit, the tester shows the length up to the service loop. This is true even if the two sections of conduit are electrically connected.

Inventory Management

The tester is an inventory management tool. It measures lengths of wire or cable while still on the spools.

The ability to measure the length of multi-conductor cable remaining on its spool is valuable for both job-site and warehouse personnel. Remember that with the TS90, you can measure the length from **JUST ONE END** of a **PAIR** of wires, allowing you to take inventory without unspooling the cables or even having to move the spools at all.

At the job-site, you can determine if the cable remaining on your spool or in your box will be sufficient for the job at hand. This will save you an unnecessary trip to the warehouse for more cable, and help you avoid running out of cable in the middle of an installation.

There are two points to remember when measuring the length of wire on a spool:

- The wire length must be within the range of the tester (see Table 2).
- The accuracy of the measurement will be optimum if the VOP is set correctly for the type of wire being measured. See Table 2 for a list of specifically identified cables and Table 3 for a list of VOP values for other cable types.

In the warehouse, you can quickly measure the cable remaining on all your spools, allowing you to select the right spool for each job. Additionally, by keeping a record of the prior inventory, you can determine how much wire was used on the current job.

Note

Remember that the tester works on TWO conductors. Single conductor spools can not be measured with the TS90 Cable Fault Finder.

TS90 Cable Fault Finder Users Guide

Table 2. Values and Maximum Length for Specifically Identified Cables

VOP	Maximum Length (Feet)	Cable
64	2000	Lucent 1024 006ABE 6/24 W1000, 6 pair CAT3 (Blue-White)
63	1500	BICC General Aerial Service Wire (ASW) 2/22, 2 Pair Drop Wire
61	2000	Superior Essex, 4 pair CAT3 Plenum (not pair dependent)
60	1500	BICC General, 24 AWG CMX Outdoor CMR Station Wire
58	1000	BICC General cross-connect 24 AWG twisted pair on original spool
66	2500	Berk-Tek, CAT5 (Orange-White)
68	2500	Superior-Essex Cobra CAT5 CMR (Orange-White)
72	2500	Superior-Essex Cobra CAT5 CMP (Orange-White)
82	1000	CommScope 5726, RG6 CATV Coax
81	1000	CommScope 2275V, RG6 CATV Coax
79	1000	CommScope 5571, RG59, TV Coax

Table 2. Values and Maximum Length for Specifically Identified Cables (continued)

VOP	Maximum Length (Feet)	Cable
67	500	Belden 88760 2 wire shielded 18 AWG, Red-Black
68	500	Belden 88760 2 wire shielded 18 AWG, Red/Black-Shield
64	500	Carol C1156 RG-174/U
57	500	BICC General, E22025, Red-Black
73	1000	Channel Master Polyclad Model 9354 300 Ohm Foam Antenna Wire
71	2000	Triangle Wire and Cable, type NM-B 12/2 W/G, Black-Ground
67	2000	Triangle Wire and Cable, type NM-B 12/2W/G, Black-White

TS90 Cable Fault Finder Users Guide

Table 3. VOP Values for Other Cables

VOP	Cable Type
78	Belden Drop Foam
82	CommScope Drop
87	CommScope Trunk
63	RG58/U 50 Ohm Network Coax
80	RG59 TV Coax
64	Service Wire
83	Times Fiber Drop
90	Times Fiber Dynafoam
87	Times Fiber Trunk
93	Trilogy Trunk
68	Twisted Pair, Gel Filled 19 AWG
64	Twisted Pair, Gel Filled 22 AWG
62	Twisted Pair, Gel Filled 24 AWG
60	Twisted Pair, Gel Filled 26 AWG
68	Twisted Pair, Paper 22 AWG
66	Twisted Pair, Paper 24 AWG
65	Twisted Pair, Paper 26 AWG
72	Twisted Pair, PIC 19 AWG
67	Twisted Pair, PIC 22 AWG
66	Twisted Pair, PIC 24 AWG
64	Twisted Pair, PIC 26 AWG

In Case of Unstable or Unusual Readings

Sometimes, devices connected to the cable you are testing can prevent the TS90 from making a valid reading. Such devices include telephones, fax machines, modems, speakers, transformers, light bulbs, televisions, and dc loads. The software makes the best decisions it can when faced with unusual conditions, but may not always be able to ignore connected devices. If you get a highly unstable or clearly invalid reading, check for devices connected to the cable.

Time Domain Reflectometry (TDR) Technology

Note

This section goes deeper into the theory of operation. You can skip this section and still use the tester effectively by reading the other parts of this manual. However, it is worth reading this section if you want more insight into how the tester works.

One of the keys to understanding how the tester works is to first understand that a pair of wires has a fixed impedance as long as the wires of the pair are kept in the same geometrical relationship to each other.

A pair of wires (either standalone or within a multi-wire cable) is designed to have a constant wire-to-wire impedance. If the physical relationship of the wires in the pair is altered during the wire run, then there will be a change in impedance at the point where the physical relationship changes.

TS90 Cable Fault Finder Users Guide

For example, if one or both wires of the pair are broken (open), or they are shorted to each other, or they become sufficiently separated from each other, their impedance will change. The tester looks for these changes in impedance. If the impedance change is large enough, (e.g., such as that caused by a break in one of the wires of the pair), the tester will detect the impedance change and will display the length of the wire up to the impedance change.

From the previous information, it should be easy to deduce that the tester can measure the length of a pair of un-terminated wires, because, the open circuit at the far end causes a very large impedance change.

The TS90 Cable Fault finder uses Time Domain Reflectometry (TDR) to determine the length of the target cable. A TDR, much like RADAR, sends a pulse down the pair of wires. Part of that pulse reflects off any impedance variations in the pair of wires. All of the reflections, together with the original pulse, combine to make an electrical signal (TDR waveform) that has various flat and bumpy sections that represent the start, the impedance changes, and the end of the cable. The size and shape of the flat and bumpy sections depend on the distance to the impedance changes and the magnitude of the impedance changes.

For example, two runs of 12/2 ac wire joined with a splice will have a TDR waveform with 2 flat sections separated by a bump. The two flat sections represent the lengths of the two sections of wire. The small bump in the middle represents the small impedance change at the splice point. The large bump at the end represents the large impedance change at the end of the wire run (see Figure 4).

Time Domain Reflectometry (TDR) Technology

TDR technology examines this TDR waveform (see Figure 4), looking at the sizes of the flat sections and the bumps. The software decides which of the elements of the waveform is most representative of the common problems encountered in the wiring industries and reports the distance to that element.

In the case of the waveform in Figure 4, the tester will report the distance to the end of the wire run and will ignore the small bump in the middle because it is too small to be considered a problem.

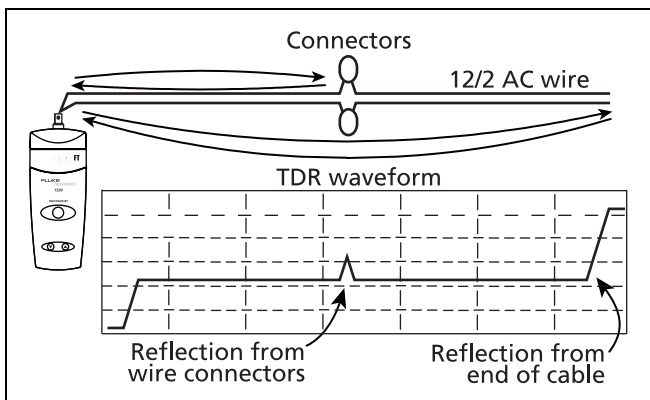

cab04.eps

Figure 4. TDR Waveform

If more than one problem exists on the cable, the software in the TS90 Cable Fault Finder only reports the nearest problem.

The actual result of the measurement is the TIME to the fault. The software in the tester converts the measured time to a length by multiplying the time by the speed of the electrical signal in that particular cable. That speed is represented as a percentage of the speed of light and is called the Velocity of Propagation (VOP).

TS90 Cable Fault Finder Users Guide

The actual formula used is as follows:

$$\text{Length} = \frac{\text{Time in billionths of a second}}{2} \times \frac{\text{VOP}}{0.9835}$$

The time is divided by two because the signal traveled the length of the cable twice. Once when it left the tester and went to the failure point, and again when it reflected back to the tester to be detected. The speed of light expressed in billionths of a second per foot is 0.9835 (about a billion feet per second).

VOP Variations

This characteristic speed of the signal for a particular cable is not normally a tightly controlled part of the cable manufacturing process and can vary widely from one manufacturer to another as well as from one box of cable to the next. As with all TDR-based cable measurement tools, the tester measures TIME within specified tolerances, but the displayed LENGTH is the result of the calculation with the user-selected VOP and is only as accurate as that selected VOP. For most uses, a length reading with an incorrectly set VOP is sufficiently accurate to locate the fault in the cable. After all, an installed cable is hardly ever run in a straight line. It can be stapled along the 2x4, laid diagonally in the ceiling, and coiled behind the junction box, all of which is not visible. Also, common sense should prevail. For example, if the tester reports an open at 80 feet, and you can see a junction box at about 70 feet, your first step should be to check at the junction box.

However, for some uses such as measuring the remaining cable in a box, it is important to set the VOP correctly in order to achieve the accuracy desired.

Depending on the cable construction (shielded, twisted, etc.), insulating material (foam, air, fiber, etc.), and conductors tested (wire-to-wire, wire-to-shield), coiling the cable on a spool or in a box may alter its VOP.

Additionally, other conductors in close proximity to the conductors being tested can affect the VOP. For example, a solitary 12 gauge THHN in a 1 inch conduit has a VOP of 82, while that same wire in a ½ inch conduit filled with other wires has a VOP of 72.

Note

The actual VOP of any particular cable is dependent on the conductor spacing and the material between the conductors and could vary by as much as ±5 feet from the value listed in Table 2.

For help with your measurements, see Table 2 and Table 3 for the VOP values for many cable types and conditions.

Maximum Length

The maximum length of cable that can correctly be measured by the tester is determined by several factors. The most significant is the signal loss of the cable itself. When the signal loss in a particular cable is large enough, the tester cannot “hear” the TDR echo and cannot determine the length of that cable. In this situation, the tester displays **Err** on the readout. The amount of signal loss in a cable is determined by the characteristics of that cable and its length. The maximum length shown in Table 2 is the length above which the tester is not expected to be able to make a valid measurement. For lengths above those stated in Table 2, the tester’s accuracy is not specified.

Frequently Asked Questions

Q: How do I calibrate the tester or perform a self test?

A: There are no adjustments inside the tester, and the internal coating protects the critical components from moisture and contaminants. There is nothing to calibrate. A self test is performed by the tester every time you turn it on. Since there is no loss of any settings when the tester is off, there is no penalty to just turning it off and on if you wish to perform a self test. The tester displays **8.8.8.8.** during the self test.

Q: Does it matter which clip lead I connect to which wire in the cable under test?

A: Not for any of the testing functions. However, when you connect the tester to a cable, if you connect the red lead first, an invalid reading may be displayed until the full connection is made with both leads. The tester's TDR technology requires both leads be connected to the wire pair or cable in order to determine its length. While using only one of the leads is useful in tracing cable position with the injected tone, both leads are required to make valid length measurements.

Q: What does the low battery indicator really indicate?

A: The LED comes on (flashes) when the battery voltage falls below 4.1 volts, indicating that you should replace the batteries. While the tester will continue to operate for at least 1 hour below this voltage, some readings may be less accurate.

Q: I tested an orange outdoor 25 foot extension cord and the display read 19 feet. Is the tester broken?

A: No. The accuracy of the reading is dependent on the setting of the VOP. While the nominal setting for general testing is -66-, the VOP for that kind of cable is -56-. To improve the accuracy of length measurements for that or any cable, change the VOP as shown in the instructions in the Velocity of Propagation section.

Q: Why does the length reading sometimes change a small amount when I open and short the far end of a test cable?

A: There are two causes. The first is that this is a characteristic of the measurement technique used in almost all low and medium cost cable length test tools.

In the case of the TS90 Cable Fault Finder, the variance occurs in only a few cable types and both readings are within the specified accuracy of the instrument. The second cause occurs when the cable is coiled, as in a box or on a spool. The magnetic field caused by the TDR signal itself couples across to other parts of the cable and changes the characteristics of the reflections.

Q: Why, on some cables, does the number displayed on the readout jump between 2 or 3 different values?

A: As the TDR signal travels down a cable, it loses some of its strength. At some point, the noise on the cable has an amplitude similar to the reduced strength TDR signal and will influence the measurement results. The tester's software filters out many of the noise related variations in the displayed length, but some variations do get through.

TS90 Cable Fault Finder Users Guide

Q: I accidentally cracked the plastic housing, does this affect the moisture protection of the components?

A: Not at all. The component protection is provided by a coating on the components and Printed Circuit Board (PCB).

However, if sufficient plastic is missing then a possible shock hazard exists. You should not use the tester until the plastic is repaired or replaced.

Q: Can this tester measure the length of single conductor wires like THHN?

A: No. All TS90 measurements must be made on TWO conductors from the SAME END of a cable.

Q: If I touch the bare metal of the wires or clip leads, will the measurement be affected?

A: After BOTH clips are connected, measurement results will ordinarily not be affected if inappropriate human contact is made with the input connectors. Under moist conditions, if a large surface area of cable is in contact with moist skin, some readings may be affected.

Q: On multi-conductor cables with a short between two of the conductors, I sometimes read an "open" at twice the known length of the cable.

A: If the cable has more than two conductors, and a short exists at the far end between one of the conductors you are connected to and a conductor you are not connected to, the displayed length will be the SUM of the lengths of the conductors joined by the short. The tester can only correctly test the two conductors you are connected to. See "Applications" on page 12 for multi-conductor cables.

Q: When testing a set of wires that go into a conduit, I sometimes get a reading of 0 or 1. Why?

A: If there is more than a foot or so of wires that are physically separated before they enter the close confinement of the conduit, this will look to the tester like an open at the start of the cable. Remember that the tester reports the FIRST failure that it finds. Try bringing the two wires of the pair closer together for the path from the tester to the entry to the conduit.

Q: When connecting to a 6 foot piece of 50 ohm Coax with the alligator clips, the tester reads 8 feet. What's up?

A: When measuring a low impedance small cable (less than 15 feet), the clip leads can add up to 2 feet of length. For longer or high impedance cables, the clip leads have no effect.

Q: How does the tester react to a speaker or a transformer at the end of a cable?

A: A speaker or a transformer is actually a large coil of wire. This will usually cause the length reading to be larger than that of the cable alone. A moderate power speaker will add 500 feet to the length reading. Some combinations of speakers and transformers connected to the cable may prevent the tester from making a valid reading.

If Something Seems Wrong with the Tester

The display remains at 8.8.8.8. after power on.

The self test has failed. The batteries may be weak or the tester has water inside. Try changing the batteries or drying the tester.

The tester reads less than 10 feet regardless of the length of the cable.

The connection to the cable is broken. Check your connection to the cable for dirt or insulation. Also, test the clip leads by shorting them and listening for the beeper. You can also visually check the center connection of the BNC for damage.

The tester does not respond to any button presses.

The batteries could be dead or inserted incorrectly, or the contacts are dirty or broken. Ensure that nothing is connected to the input connector before opening the battery door, and then check the battery installation. Remove the batteries and check the contacts for dirt or damage. Observe correct polarity when inserting the batteries.

Maintenance

Warning

These servicing instructions are for use by qualified personnel only. To avoid electric shock, do not perform any servicing other than that contained in the operating instructions unless you are qualified to do so.

Disconnect clips from any metallic connections before performing any maintenance.

Caution

Do not use CRC Cable Clean® or any similar chlorinated solvent on the tester. Doing so will damage the tester.

There are no user serviceable components or adjustments in the tester. Do not open the housing as handling of the PC board could remove the moisture protection coating or apply a static charge that will damage sensitive components.

Note

Opening the housing will void the warranty.

Moisture will not harm the tester. However, moisture can provide a leakage path that may conduct hazardous voltages to you. **DO NOT USE** the tester if wet.

If moisture should get inside the tester, let the tester dry at normal room temperature for 24 hours. **DO NOT HEAT THE** tester.

The tester may be cleaned by using a soft cloth with soap and water. Do not use a petroleum-based or chlorinated cleaning agents.

Specifications

Power	4 AA alkaline batteries, provide 50 hours of operation
Reverse Battery Protection	No damage to the tester will occur if the batteries are installed backwards.
Input Protection	250 V rms ac, continuous or intermittent
Moisture	If the tester is exposed to water, some may get inside, but it will suffer NO DAMAGE. See the moisture notes in the Maintenance section.
Impedance Range	35 Ω to 330 Ω with auto-compensation within this range. Cables with an impedance outside this range will not be properly tested and may produce erratic or incorrect readings.
Maximum Length	2500 feet on most cable types, and 500 feet on very lossy cables. The tester will display -Err if the cable is too long to be correctly measured.
Representative Maximum Cable Length	2500 feet: CAT-5 Twisted Pair 2000 feet: 12/2 ac Wire 1000 feet: RG-6/U TV Coax 500 feet (150 meters): RG-174/U Coax
Minimum Length	No minimum length Minimum non-zero reading is 2 feet

Specifications (continued)



Length Accuracy	±2 feet for cables less than 10 feet ±5 feet for cables longer than 10 feet and shorter than 200 feet ±3 % and ±5 feet for cables longer than 200 feet
High Voltage Detection	An ac voltage of more than 5 V rms will trigger the High Voltage Warning.
Measurement Rate	Maximum of 4 complete measurements per second, decreasing to 2 seconds per measurement based on cable size and uniformity.
VOP	Adjustable from -20- to -99-, retained during power off. Default to -66- when batteries are changed.
Measurement Technology	Time Domain Reflectometry (TDR) with 50 Ω drive impedance, 6 V maximum pulse height.
Low Battery	Indicator flashes when battery voltage falls below 4.1 V
Tone Injection	Approximately 1 kHz at an amplitude of 80 % of battery voltage. Variable frequency and cadence. Tone characteristic is changed as cable condition changes to "normal-open" from any other condition.
Cable Type	Virtually all two or more conductor cables

-continued-

TS90 Cable Fault Finder

Users Guide

Specifications (continued)

Temperature Range Operating Storage	32 °F to 131 °F (0 °C to 55 °C) -40 °F to 158 °F (-40 °C to 70 °C)
Humidity Operating Storage	0 % to 80 % 0 % to 100 %
Weight	1 lb with batteries and clip leads
Operating Altitude	10,000 ft max
Certifications and Compliance	 Conformité Européenne. Conforms to relevant European Union directives.  CAN/CSA-C22.2 No. 60950-1-03 CAN/CSA-C22.2 No. 1010.1-92 + CSA-C22.2 No. 1010.1B-97, UL/ANSI 3111-1
Notes <i>Patents 6160405, 6285195, 6323654, and 6509740.</i> <i>This product has been safety certified for indoor use only.</i> <i>Specifications subject to change without notice.</i>	