

**T**equipment  
|.NET



205 Westwood Ave  
Long Branch, NJ 07740  
1-877-742-TEST (8378)  
Fax: (732) 222-7088  
salesteam@Tequipment.NET

**FLUKE**®

**287/289**

True-rms Digital Multimeters

**Getting Started**

PN 2748860

June 2007

© 2007 Fluke Corporation, All rights reserved. Printed in USA  
All product names are trademarks of their respective companies.

## ***Lifetime Limited Warranty***

Each Fluke 20, 70, 80, 170, 180 and 280 Series DMM will be free from defects in material and workmanship for its lifetime. As used herein, "lifetime" is defined as seven years after Fluke discontinues manufacturing the product, but the warranty period shall be at least ten years from the date of purchase. This warranty does not cover fuses, disposable batteries, damage from neglect, misuse, contamination, alteration, accident or abnormal conditions of operation or handling, including failures caused by use outside of the product's specifications, or normal wear and tear of mechanical components. This warranty covers the original purchaser only and is not transferable.

For ten years from the date of purchase, this warranty also covers the LCD. Thereafter, for the lifetime of the DMM, Fluke will replace the LCD for a fee based on then current component acquisition costs.

To establish original ownership and prove date of purchase, please complete and return the registration card accompanying the product, or register your product on <http://www.fluke.com>. Fluke will, at its option, repair at no charge, replace or refund the purchase price of a defective product purchased through a Fluke authorized sales outlet and at the applicable international price. Fluke reserves the right to charge for importation costs of repair/replacement parts if the product purchased in one country is sent for repair elsewhere.

If the product is defective, contact your nearest Fluke authorized service center to obtain return authorization information, then send the product to that service center, with a description of the difficulty, postage and insurance prepaid (FOB Destination). Fluke assumes no risk for damage in transit. Fluke will pay return transportation for product repaired or replaced in-warranty. Before making any non-warranty repair, Fluke will estimate cost and obtain authorization, then invoice you for repair and return transportation.

**THIS WARRANTY IS YOUR ONLY REMEDY. NO OTHER WARRANTIES, SUCH AS FITNESS FOR A PARTICULAR PURPOSE, ARE EXPRESSED OR IMPLIED. FLUKE SHALL NOT BE LIABLE FOR ANY SPECIAL, INDIRECT, INCIDENTAL OR CONSEQUENTIAL DAMAGES OR LOSSES, INCLUDING LOSS OF DATA, ARISING FROM ANY CAUSE OR THEORY. AUTHORIZED RESELLERS ARE NOT AUTHORIZED TO EXTEND ANY DIFFERENT WARRANTY ON FLUKE'S BEHALF.** Since some states do not allow the exclusion or limitation of an implied warranty or of incidental or consequential damages, this limitation of liability may not apply to you. If any provision of this warranty is held invalid or unenforceable by a court or other decision-maker of competent jurisdiction, such holding will not affect the validity or enforceability of any other provision.

# Table of Contents

Title	Page
Introduction .....	1
Contacting Fluke .....	1
Safety Information .....	1
Symbols .....	3
Turning the Meter On .....	4
Setting the Meter's Language .....	4
Features .....	5
Understanding the Push Buttons .....	5
Understanding the Display .....	6
Using the Input Terminals.....	9
Battery Level Indicator.....	10
Input Alert™ Feature .....	10
Maintenance.....	10
General Maintenance .....	10
Testing the Fuses .....	10
Replacing the Fuses.....	11
Replacing the Batteries .....	11

In Case of Difficulty ..... 11

# List of Tables

Table	Title	Page
1.	Symbols.....	3
2.	Push Buttons .....	5
3.	Display Features .....	6
4.	Rotary Switch Positions.....	8
5.	Input Terminals.....	9
6.	Battery Level Indicator.....	10

## ***List of Figures***

<b>Figure</b>	<b>Title</b>	<b>Page</b>
1.	Push Buttons.....	5
2.	Display Features .....	6
3.	Rotary Switch.....	8
4.	Input Terminals .....	9

## Introduction

### Warning

Read “Safety Information” before using this Meter

Except where noted, the descriptions and instructions in this manual apply to both the Fluke 287 and 289 True-rms Digital Multimeters (hereafter referred to as “the Meter”). Model 289 appears in all illustrations.

This manual covers information for turning on the Meter, understanding its controls, and basic maintenance. For complete operational instructions, refer to the *287/289 Users Manual* contained on the accompanying CD.

## Contacting Fluke

To contact Fluke, call one of the following telephone numbers:

USA: 1-888-993-5853

Canada : 1-800-363-5853

Europe : +31 402-675-200

Japan: +81-3-3434-0181

Singapore : +65-738-5655

Anywhere in the world: +1-425-446-5500

Visit Fluke's web site at: [www.fluke.com](http://www.fluke.com)

Register your Meter at: [register.fluke.com](http://register.fluke.com)

## Safety Information

The Meter complies with:

- ANSI/ISA 82.02.01 (61010-1) 2004
- UL 61010B (2003)
- CAN/CSA-C22.2 No. 61010-1-04
- IEC/EN 61010-1 2<sup>nd</sup> Edition Pollution Degree 2
- EMC EN 61326-1
- Measurement Category III, 1000V, Pollution Degree 2
- Measurement Category IV, 600 V, Pollution Degree 2

In this manual, a **Warning** identifies hazardous conditions and actions that could cause bodily harm or death. A **Caution** identifies conditions and actions that could damage the Meter, the equipment under test, or cause permanent loss of data.

Symbols used on the Meter and in this manual are explained in Table 1.

### Warning

To avoid possible electric shock or personal injury, follow these guidelines:

- **Use this Meter only as specified in this manual or the protection provided by the Meter might be impaired.**
- **Do not use the Meter if it is damaged. Before you use the Meter, inspect the case. Look for cracks or missing plastic. Pay particular attention to the insulation surrounding the connectors.**
- **Make sure the battery door is closed and latched before operating the Meter.**











- Remove test leads from the Meter before opening the battery door.
- Inspect the test leads for damaged insulation or exposed metal. Check the test leads for continuity. Replace damaged test leads before you use the Meter.
- Do not apply more than the rated voltage, as marked on the Meter, between the terminals or between any terminal and earth ground.
- Never operate the Meter with the cover removed or the case open.
- Use caution when working with voltages above 30 V ac rms, 42 V ac peak, or 60 V dc. These voltages pose a shock hazard.
- Use only the replacement fuses specified by the manual.
- Use the proper terminals, function, and range for measurements.
- Avoid working alone.
- When measuring current, turn off circuit power before connecting the Meter in the circuit. Remember to place the Meter in series with the circuit.
- When making electrical connections, connect the common test lead before connecting the live test lead; when disconnecting, disconnect the live test lead before disconnecting the common test lead.
- Do not use the Meter if it operates abnormally. Protection may be impaired. When in doubt, have the Meter serviced.
- Do not operate the Meter around explosive gas, vapor, or dust.
- Use only 1.5 V AA batteries, properly installed in the Meter case, to power the Meter.
- When servicing the Meter, use only specified replacement parts.
- When using probes, keep fingers behind the finger guards on the probes.
- Do not use the Low Pass Filter option to verify the presence of hazardous voltages. Voltages greater than what is indicated may be present. First, make a voltage measurement without the filter to detect the possible presence of hazardous voltage. Then select the filter function.
- Only use test leads that have the same voltage, category, and amperage ratings as the meter and that have been approved by a safety agency.
- Use proper protective equipment, as required by local or national authorities when working in hazardous areas.
- Comply with local and national safety requirements when working in hazardous locations.



## Symbols

Table 1 lists and describes the symbols appearing on the Meter and in this manual.

**Table 1. Symbols**

Symbol	Description	Symbol	Description
~	AC (Alternating Current or Voltage)		Fuse
≡	DC (Direct Current or Voltage)		Double Insulated
	Hazardous voltage		Important Information; refer to manual
	Battery (Low battery when shown on the display)		Earth ground
)))	Continuity test or continuity beeper tone		Conforms to relevant Canadian and US standards
CE	Conforms to European Union directives	 N10140	Conforms to relevant Australian standards
	Underwriters Laboratory listed product.		Inspected and licensed by TÜV Product Services
<b>CAT III</b>	IEC Measurement Category III – CAT III equipment is designed to protect against transients in equipment in fixed equipment installations, such as distribution panels, feeders and short branch circuits, and lighting systems in large buildings.	<b>CAT IV</b>	IEC Measurement Category IV – CAT IV equipment is designed to protect against transients from the primary supply level, such as an electricity meter or an overhead or underground utility service.
	Do not dispose of this product as unsorted municipal waste. Go to Fluke's website for recycling information.		

**⚠ Caution**

To avoid possible damage to the Meter or the equipment under test, follow these guidelines:

- **Disconnect circuit power and discharge all high voltage capacitors before testing resistance, continuity, diodes, or capacitance.**
- **Use the proper terminals, function, and range for all measurements.**
- **Do not remove batteries while the Meter is turned on or a signal is applied to the Meter's input jacks.**
- **Before measuring current, check the Meter's fuses. (See "Testing the Fuses" in the Users Manual on the accompanying CD.)**
- **Do not use the LoZ mode to measure voltages in circuits that could be damaged by this mode's low impedance ( $\approx 3 \text{ k}\Omega$ ). (model 289 only)**

## Turning the Meter On

With the Meter off, press **Ⓞ** to turn on the Meter. Pressing **Ⓞ** while the Meter is on, causes it to turn off.

## Setting the Meter's Language

The Meter comes from the factory with the display language set to English. To select another language, open the setup menu by pressing the softkey labeled **Setup**. Move the menu selector next to the menu item labeled **Display**. Next, press the softkey labeled **Format (F2)** to open the format menu. If not already selected, move the menu selector to the left of the menu item labeled **Language** and press the softkey labeled **Edit**. The currently selected language becomes highlighted and **◆** appears to the right of the language. Use **⏪** and **⏩** to scroll through the available languages, then press the softkey labeled **OK** to set the Meter's display language. Press the softkey labeled **Close** to return to normal Meter operation.



## Understanding the Display

Display features shown in Figure 2 are described in Table 3. Major display features are described in the *287/289 Users Manual* contained on the accompanying CD.

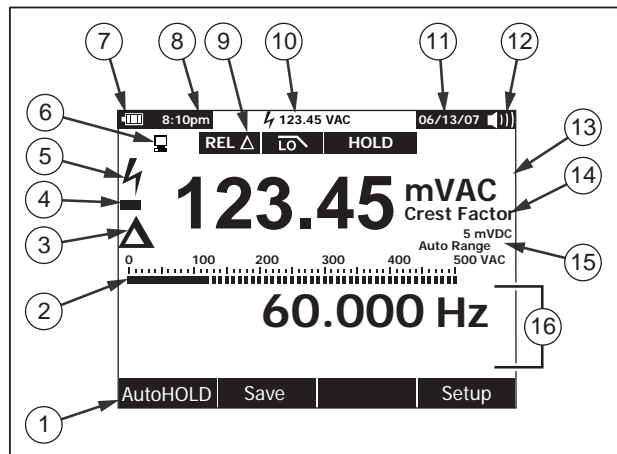

Figure 2. Display Features

est01.eps

Table 3. Display Features

Item	Function	Indication
①	Softkey labels	Indicates the function of the button just below the displayed label.
②	Bar graph	Analog display of the input signal (See the "Bar Graph" section below for more information).
③	Relative	Indicates the displayed value is relative to a reference value.
④	Minus sign	Indicates a negative reading.
⑤	Lightning bolt	Indicates hazardous voltage present at the Meter's input.
⑥	Remote communication	Indicates activity over the communication link.
⑦	Battery level	Indicates the charge level of the six AA batteries.
⑧	Time	Indicates the time set in the internal clock.
⑨	Mode annunciators	Indicates the Meter's mode.

**Table 3. Display Features (cont.)**

Item	Function	Indication
⑩	Mini-measurement	Displays the lightning bolt (when necessary) and the input value when the primary and secondary displays are covered by a menu or pop-up message.
⑪	Date	Indicates the date set in the internal clock.
⑫	Beeper	Indicates the Meter's beeper is enabled (not associated with the continuity beeper).
⑬	Units	Indicates the units of measure.
⑭	Auxiliary Units	Indicates unitless measurements like Crest Factor.
⑮	Range indicator	Indicates the range the Meter is in and the ranging mode (auto or manual).
⑯	Secondary display	Displays secondary measurement information about the input signal.

### **Bar Graph**

The analog bar graph functions like the needle on an analog meter, but without the overshoot. The bar graph updates 30 times per second. Because the graph updates faster than the digital display, it is useful for making peak and null adjustments and observing rapidly changing inputs. For frequency, duty cycle, pulse width, dBm, and crest factor functions, the bar graph represents the amplitude of the input signal (volts or amps) and not the value in the primary display. The bar graph is not shown for capacitance, temperature, LoZ, AC+DC, AC over DC, peak, or min max functions.

For dc voltage, dc current, and all relative percent modes, a zero-centered bar graph is displayed. For dc voltage and current, the bar graph range is the maximum of the selected range. For relative percent mode, the bar graph goes to  $\pm 10\%$ .

The number of lit segments indicates the measured value and is relative to the full-scale value of the selected range. In the 50 Vac range, for example, the major divisions on the scale represent 0, 5, 10, 15, 20, 25, 30, 35, 40, 45, and 50 Vac. An input of 25 Vac turns on segments up to the middle of the scale.

For off-scale values, ► appears to the right of the normal bar graph. For the zero-center bar graph, a ◀ appears at the left end of the bar graph for negative off-scale values and ► appears on the right end for positive off-scale values.

### **Adjusting Display Contrast**

When not selecting items on a menu or inputting data, ☀ increases display contrast and ☾ decreases it.

## Understanding the Rotary Switch

Select a primary measurement function by positioning the rotary switch to one of the icons around its perimeter. The model 289 offers two additional functions: low ohms ( $50\Omega$ ) and low impedance (**LoZ**) ac volts. Each position shown in Figure 3 is described in Table 4.

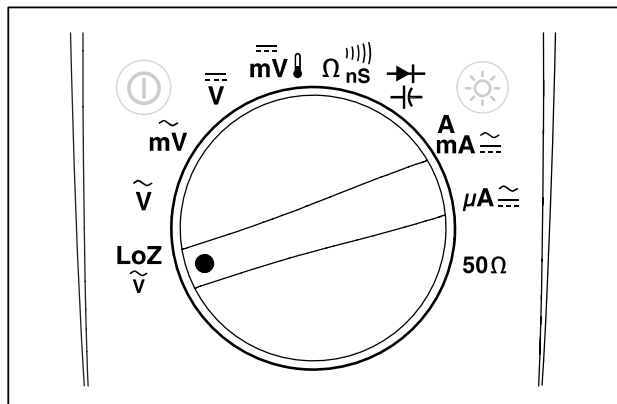

est103.emf

Figure 3. Rotary Switch

Table 4. Rotary Switch Positions

Switch Position	Function
LoZ V	AC voltage measurement using a low input impedance (model 289 only)
V	AC voltage measurements
mV	AC millivolt measurements
V	DC and ac+dc voltage measurements
mV	DC millivolts, ac+dc millivolt, and temperature measurements
Ω nS	Resistance, continuity, and conductance measurements
diode/capacitance symbol	Diode test and capacitance measurements
mA	AC and dc amps and milliamps measurements
μA	AC and dc microampere measurements
50Ω	Resistance measurements with $50\Omega$ range (model 289 only)

### Using the Input Terminals

All functions except current use the  $\text{V}\Omega$  and COM input terminals. The two current input terminals (A and mA/ $\mu$ A) are used as follows:

Current from 0 to 400 mA, use the  $\frac{\text{mA}}{\mu\text{A}}$  and COM terminals.

Current between 0 and 10 A use the A and COM terminals.

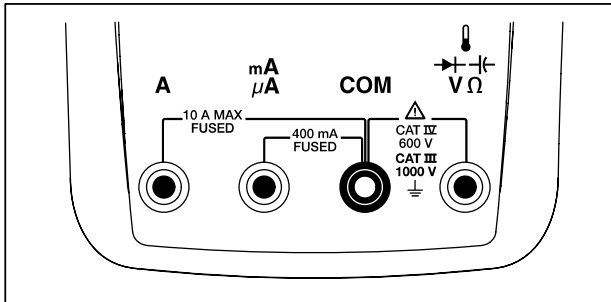

est04.emf

Figure 4. Input Terminals





Table 5. Input Terminals

Terminal	Description
<b>A</b>	Input for 0 A to 10.00 A current (20 A for 30 seconds on, 10 minutes off), frequency, and duty-cycle measurements.
$\frac{\text{mA}}{\mu\text{A}}$	Input for 0 A to 400 mA current measurements, frequency, and duty cycle.
<b>COM</b>	Return terminal for all measurements.
$\text{V}\Omega$	Input for voltage, continuity, resistance, diode test, conductance, capacitance, frequency, temperature, period, and duty-cycle measurements.

## Battery Level Indicator

The battery level indicator is in the upper left-hand corner of the display. Table 6 describes the various battery levels the indicator represents.

Table 6. Battery Level Indicator

Indication	Battery Capacity
	Full capacity
	¾ capacity
	½ capacity
	¼ capacity
 [1]	Almost empty (less than one day)
[1] When critically low, a “Replace batteries” pop-up message appears 15 seconds before the Meter shuts down.	

The Meter will display a “Batteries low” message whenever the battery level will not support a selected function.

## Input Alert™ Feature

If a test lead is plugged into the mA or A terminal, but the rotary switch is not set to the correct current position, the Meter makes a chirping sound and displays “Leads connected incorrectly”.

### Caution

To avoid circuit damage and possibly blowing the Meter’s current fuse, do not place the probes across (in parallel with) a powered circuit when a lead is plugged into a current terminal. This causes a short circuit because the resistance through the Meter’s current terminals is very low.

## Maintenance

### Warning

To avoid electrical shock or personal injury, repairs or servicing not covered in this manual should be performed only by qualified personnel as described in the 287/289 Service Information.

## General Maintenance

For general maintenance refer to the 287/289 Users Manual on the accompanying CD.

## Testing the Fuses

With the Meter in the  $\Omega_{ns}$  function, insert a test lead into the  $\mathbb{I} \rightarrow \mathbb{I} \rightarrow \mathbb{V} \Omega$  jack and place the probe tip on the other end of the test lead against the metal of the current input jack. Disregard the “Leads Connected Incorrectly” message, if it should appear. The resistance value should be between 0.00 and 0.50  $\Omega$  for the A jack and 10.00  $\pm 0.05$  k $\Omega$  for the  $\mu A$  jack.



### **Warning**

**To avoid electrical shock or personal injury, remove the test leads and any input signals before replacing the battery or fuses. To prevent damage or injury, install *only* Fluke specified replacement fuses with the amperage, voltage, and speed ratings shown in the parts list at the back of this manual.**

### **Replacing the Fuses**

To replace the Meter's fuses:

1. Turn the Meter off and remove the test leads from the terminals.
2. Remove the battery door assembly by using a standard-blade screwdriver to turn the battery door screw one-half turn counterclockwise.
3. Remove the fuse by gently prying one end loose, then sliding the fuse out of its bracket.
4. Install *only* Fluke specified replacement fuses with the amperage, voltage, and interrupt ratings shown in the parts list at the back of this manual.
5. Reinstall the battery door assembly and secure it by turning the screw one-half turn clockwise.

### **Replacing the Batteries**

To replace the batteries:

1. Turn the Meter off and remove the test leads from the terminals.
2. Remove the battery door assembly by using a standard-blade screwdriver to turn the battery door screw one-half turn counterclockwise.
3. Replace the batteries with 1.5 volt AA batteries (NEDA 15A IEC LR6). Observe proper polarity.
4. Reinstall the battery door assembly and secure it by turning the screw one-half turn clockwise.

### **In Case of Difficulty**

If the Meter does not seem to work properly:

1. Check that all batteries are installed with the correct polarity.
2. Examine the case for damage. If damage is detected, contact Fluke. See the "Contacting Fluke" section earlier in this manual.
3. Check and replace (as needed) the batteries, fuses, and test leads.
4. Review the Users manual on the accompanying CD to verify correct operation.
5. If the Meter still does not work, pack it securely and forward it, postage paid, to the location provided by the appropriate Fluke contact. Include a description of the problem. Fluke assumes no responsibility for damage in transit.

A Meter under warranty will be repaired or replaced (at Fluke's option) and returned at no charge. See the registration card for warranty terms.



**FLUKE®**

**287/289**

True-rms Digital Multimeters

PN 2748860

June 2007

© 2007 Fluke Corporation, All rights reserved. Printed in USA  
All product names are trademarks of their respective companies.

**Parts and Specifications**



# Table of Contents

Title	Page
Parts.....	1
General Specifications .....	5
AC Voltage Specifications .....	7
AC Current Specifications .....	8
DC Voltage Specification .....	9
DC Current Specifications .....	10
Resistance Specifications.....	11
Temperature Specifications .....	11
Capacitance and Diode Test Specifications .....	12
Frequency Counter Specifications.....	13
Frequency Counter Sensitivity.....	14
Input Characteristics .....	15
MIN MAX, Recording, and Peak Specifications.....	16
Burden Voltage (A, mA, $\mu$ A) .....	16



## Parts

Replacement parts and accessories are shown in Tables 1 and 2 and Figure 1. To order parts and accessories, refer to the “Contacting Fluke” section.

**Table 1. Replacement Parts**

Item	Description	Qty.	Fluke Part/Model Number	
1	Knob	1	2798434	
2	Skin	1	2798418 (289) 2798429 (287)	
3	Keypad	1	2578234	
4	O-Ring	1	2740185	
5	Case Top	1	2578178	
6	Screw, Phillips	5	2743764	
7	Mask, LCD	1	2760673 (289) 2798407 (287)	
8	LCD Module	1	2734828	
9	Shock Absorber	3	2793516	
10	Spring Detent	1	2723772	
11	RSOB Housing, Upper	1	2578283	
12	Shield	Upper	1	2578252
		Lower	1	2578265

Table 1. Replacement Parts (cont.)

Item	Description	Qty.	Fluke Part/Model Number
13	RSOB Housing, Lower	1	2578290
14	Case Bottom	1	2578184
15	Shock Absorber, Battery Compartment	1	2793525
16	Battery Contact, Negative	2	2578375
17	Battery Contact, Positive	1	2578353
18	△Fuse (F1), 0.440 A, 1000 V, FAST, Interrupt rating 10 kA	1	943121
19	△Fuse (F2), 11 A, 1000 V, FAST, Interrupt rating 20 kA	1	803293
20	Battery, 1.5 V NEDA 15C/15F or IEC R6S	6	376756
21	Battery Door Assembly (includes tilt bail)	1	2824477
22	Screw, Phillips	7	853668
23	TL71 Right-Angle Test Lead Set	1	TL71
24	Alligator Clips, one black and one red	2	1670652 (Black) 1670641 (Red)
25	Manual, Manual Pack, Fluke 287/289	1	2748851
26	287/289 Users Manual CD <sup>[1]</sup>	1	2748872

△To ensure safety, use exact replacement only.

[1] The Users and Getting Started manuals are available through [www.Fluke.com](http://www.Fluke.com). Click on **Support** and then **Product Manuals**.



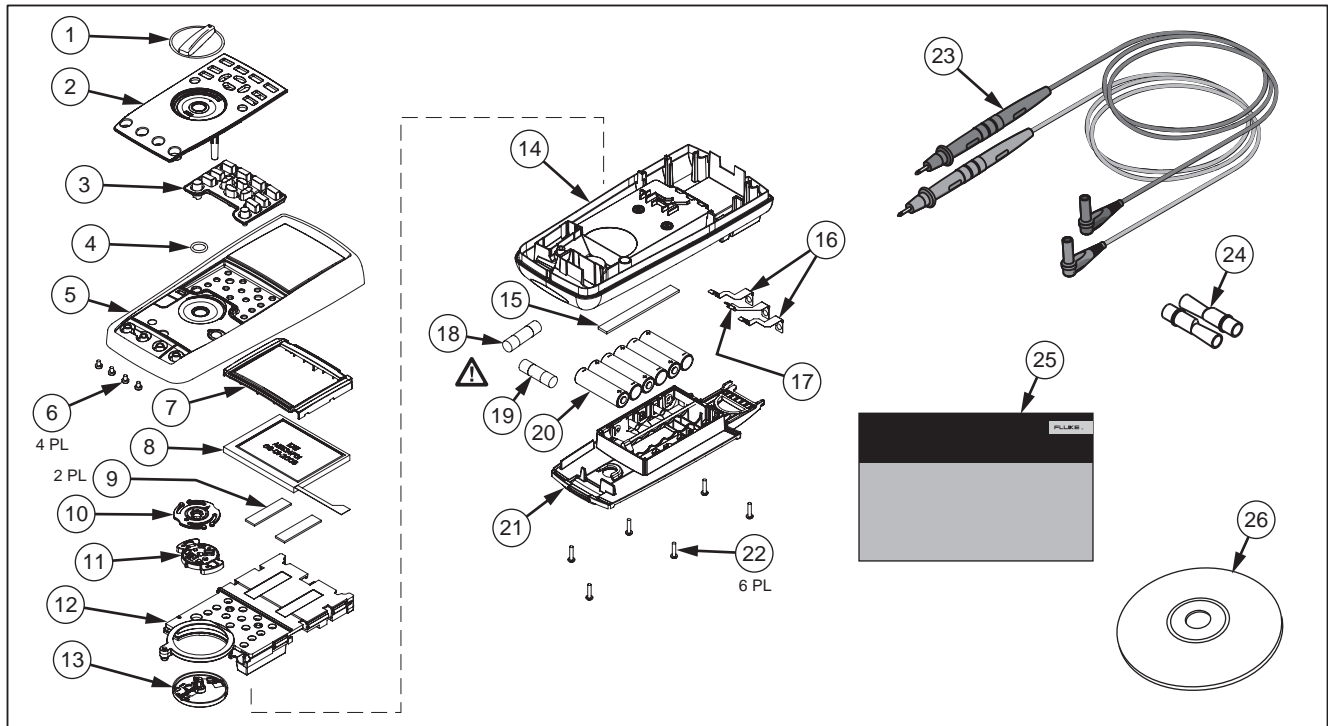

Figure 1. Replaceable Parts

est40.eps

**Table 2. Accessories**

<b>Item</b>	<b>Description</b>
AC72	Alligator Clips for use with TL75 test lead set
AC220	Safety Grip, Wide-Jaw Alligator Clips
80BK	80BK Integrated DMM Temperature Probe
TPAK	ToolPak Magnetic Hanger
C25	Carrying Case, Soft
TL76	4 mm Diameter Test Leads
TL220	Industrial Test Lead Set
TL224	Test Lead Set, Heat-Resistant Silicone
TP1	Test Probes, Flat Blade, Slim Reach
TP4	Test Probes, 4 mm diameter, Slim Reach
Fluke accessories are available from an authorized Fluke distributor.	

## General Specifications

**Maximum voltage between any Terminal and Earth Ground:** 1000 V

**⚠ Fuse Protection for mA or  $\mu$ A inputs** .....0.44 A (44/100 A, 440 mA), 1000 V FAST Fuse, Fluke specified part only

**⚠ Fuse Protection for A input**.....11 A, 1000 V FAST Fuse, Fluke specified part only

**Battery Type**.....6 AA Alkaline batteries, NEDA 15A IEC LR6

**Battery Life**.....100 hours minimum. 200 hours in Logging mode

### Temperature

Operating.....-20 °C to 55 °C

Storage.....-40 °C to 60 °C

**Relative Humidity** .....0 % to 90 % (0 °C to 37 °C), 0 % to 65 % (37 °C to 45 °C), 0 % to 45 % (45 °C to 55°C)

### Altitude

Operating.....3,000 m

Storage.....10,000 m

**Temperature Coefficient** .....0.05 X (specified accuracy) /°C (<18 °C or >28 °C)

**Vibration**.....Random Vibration per MIL-PRF-28800F Class 2

**Shock**.....1 meter drop per IEC/EN 61010-1 2<sup>nd</sup> Edition

**Size (HxWxL)**.....8.75 in x 4.03 in x 2.38 in (22.2 cm x 10.2 cm x 6.0 cm)

**Weight** .....28.0 oz (871 g)

### Safety Standards

US ANSI .....Complies with ANSI/ISA 82.02.01 (61010-1) 2004

CSA .....CAN/CSA-C22.2 No 1010-1-04 to 1000 V Measurement Category III and 600 V Measurement Category IV, Pollution Degree 2

UL.....UL 61010 (2003)



CE European.....IEC/EN 61010-1 2<sup>nd</sup> Edition Pollution Degree 2

**Electromagnetic Compatibility Standards (EMC)**

European EMC.....EN61326-1

Australian EMC .....  N10140

US FCC.....FCC CFR47: Part 15 CLASS A

**Certifications** .....UL, CE, CSA,  (N10140),  **Accuracy:**

Accuracy is specified for a period of one year after calibration, at 18 °C to 28 °C (64 °F to 82 °F), with relative humidity to 90 %. Accuracy specifications are given as:  $\pm$ ( [ % of reading ] + [ number of least significant digits ] ). Accuracy specification assumes ambient temperature stable at  $\pm 1$  °C. For ambient temperature changes of  $\pm 5$  °C, rated accuracy applies after 2 hours.

**True-rms:**

AC mV, AC V, AC  $\mu$ A, AC mA, and AC A specifications are ac-coupled, true rms, and are specified from 2 % of range to 100 % of range, except 10 A range is specified from 10 % to 100 % of range.

**Crest Factor:**

Accuracy is specified with AC crest factor  $\leq 3.0$  at full-scale, increasing linearly to 5.0 at half-scale, except the 1000 V range, where it is 1.5 at full scale, increasing linearly to 3.0 at half-scale and 500 mV and 5000  $\mu$ A, where it is  $\leq 3.0$  at 80 % of full scale, increasing linearly to 5.0 at half-scale. For non-sinusoidal waveforms add  $\pm(0.3$  % of range and 0.1 % of reading).

**AC Floor:**

When the input leads are shorted together in the ac functions, the Meter may display a residual reading up to 200 counts. A 200 count residual reading will cause only a 20 count change for readings at 2 % of range. Using REL to offset this reading may produce a much larger constant error in later measurements.

**AC+DC:**

AC+DC is defined as  $\sqrt{ac^2 + dc^2}$

### AC Voltage Specifications

Function	Range	Resolution	Accuracy				
			20 to 45 Hz	45 to 65 Hz	65 Hz to 10 kHz	10 to 20 kHz	20 to 100 kHz
AC mV <sup>[5]</sup>	50 mV <sup>[1]</sup>	0.001 mV	1.5 % + 60	0.3 % + 25	0.4 % + 25	0.7 % + 40	3.5 % + 40 <sup>[6]</sup>
	500 mV	0.01 mV	1.5 % + 60	0.3 % + 25	0.4 % + 25	0.7 % + 40	3.5 % + 40
AC V	5 V <sup>[1]</sup>	0.0001 V	1.5 % + 60	0.3 % + 25	0.4 % + 25	1.5 % + 40	3.5 % + 40
	50 V <sup>[1]</sup>	0.001 V	1.5 % + 60	0.3 % + 25	0.4 % + 25	0.7 % + 40	3.5 % + 40
	500 V <sup>[1]</sup>	0.01 V	1.5 % + 60	0.3 % + 25	0.4 % + 25	Not Spec'd	Not Spec'd
	1000 V	0.1 V	1.5 % + 60	0.3 % + 25	0.4 % + 25	Not Spec'd	Not Spec'd
dBV	-70 to -62 dB <sup>[3]</sup>	0.01 dB	3 dB	1.5 dB	2 dB	2 dB	3 dB
	-62 to -52 dB <sup>[3]</sup>	0.01 dB	1.5 dB	1.0 dB	1 dB	1 dB	2 dB
	-52 to -6 dB <sup>[3]</sup>	0.01 dB	0.2 dB	0.1 dB	0.1 dB	0.2 dB	0.8 dB
	-6 to +34 dB <sup>[3]</sup>	0.01 dB	0.2 dB	0.1 dB	0.1 dB	0.2 dB	0.8 dB
	34 to 60 dB <sup>[3]</sup>	0.01 dB	0.2 dB	0.1 dB	0.1 dB	Not Spec'd	Not Spec'd
Low pass filter <sup>[4]</sup>			2 % + 80	2 % + 40	2 % + 10 <sup>[2]</sup> -6 % -60	Not Spec'd	Not Spec'd
LoZ <sup>[4]</sup> V	1000 V	0.1 V	2 % + 80	2 % + 40	2 % + 40	Not Spec'd	Not Spec'd

[1] Below 5 % of range, add 20 counts.

[2] Specification increases linearly from -2 % at 200 Hz to -6 % at 440 Hz. Range is limited to 440 Hz.

[3] dBm (600 Ω) is specified by adding +2.2 dB to the dBV range values.

[4] 289 only.

[5] 500 mV range specification between 64.000 kHz and 67.000 kHz is +(0.0 % to -5 % of reading); 50 mV range specification between 64.000 kHz and 67.000 kHz is +(0.0 % to -6 % of reading ±40 counts). Valid from -20 °C to +55 °C.

[6] Add 2 % above 75 kHz.

See Detailed Specifications introduction for additional information.

**AC Current Specifications**

Function	Range	Resolution	Accuracy			
			20 to 45 Hz	45 to 1 kHz	1 to 20 kHz	20 to 100 kHz <sup>[4]</sup>
AC $\mu\text{A}$ <sup>[3]</sup>	500 $\mu\text{A}$	0.01 $\mu\text{A}$	1 % + 20	0.6 % + 20	0.6 % + 20	5 % + 40
	5000 $\mu\text{A}$	0.1 $\mu\text{A}$	1 % + 5	0.6 % + 5	0.6 % + 10	5 % + 40
AC mA <sup>[3]</sup>	50 mA	0.001 mA	1 % + 20	0.6 % + 20	0.6 % + 20	5 % + 40
	400 mA	0.01 mA	1 % + 5	0.6 % + 5	1.5 % + 10	5 % + 40
AC A <sup>[2]</sup>	5 A	0.0001 A	1.5 % + 20	0.8 % + 20	3 % + 40 <sup>[4]</sup>	Not Spec'd
	10 A <sup>[1]</sup>	0.001 A	1.5 % + 5	0.8 % + 5	3 % + 10 <sup>[4]</sup>	Not Spec'd

[1] 10 A range (10 % to 100 % of range).  
 [2] 20 A for 30 seconds on, 10 minutes off. >10 A not specified.  
 [3] 400 mA continuous; 550 mA for 2 minutes on, 1 minute off.  
 [4] Verified by design and type tests.  
 See Detailed Specifications introduction for additional information.

**DC Voltage Specification**

Function	Range	Resolution	Accuracy						
			DC <sup>[1][2]</sup>	AC over DC, DC over AC, AC + DC <sup>[2]</sup>					
				20 to 45 Hz	45 Hz to 1 kHz	1 to 20 kHz	20 to 35 kHz		
DC mV	50 mV <sup>[3]</sup>	0.001 mV	0.05 % + 20	2 % + 80	0.5 % + 80	1.5 % + 40	5 % + 40		
	500 mV	0.01 mV	0.025 % + 2			1.5 % + 40	5 % + 40		
DC V	5 V	0.0001 V	0.025 % + 2			2 % + 80	0.5 % + 80	1.5 % + 40	5 % + 40
	50 V	0.001 V	0.025 % + 2					1.5 % + 40	5 % + 40
	500 V	0.01 V	0.03 % + 2					Not Spec'd	Not Spec'd
	1000 V	0.1 V	0.03 % + 2	Not Spec'd	Not Spec'd				
$\overset{\text{LoZ}}{\underset{\sim}{V}}$	1000 V	0.1 V	1 % + 20	Not Spec'd	Not Spec'd	Not Spec'd	Not Spec'd		

[1] Add 20 counts in dual display ac over dc, dc over ac or ac+dc.  
 [2] AC+DC ranges are specified from 2 % to 140 % of range, except 1000 V is specified from 2 % to 100 % of range.  
 [3] When using the relative mode (REL  $\Delta$ ) to compensate for offsets.

**DC Current Specifications**

Function	Range	Resolution	Accuracy				
			DC <sup>[1][3]</sup>	AC over DC, DC over AC, AC + DC <sup>[1]</sup>			
				20 to 45 Hz	45 Hz to 1 kHz	1 to 20 kHz	20 to 100 kHz <sup>[5]</sup>
DC $\mu\text{A}$ <sup>[4]</sup>	500 $\mu\text{A}$	0.01 $\mu\text{A}$	0.075 % + 20	1 % + 20	0.6 % + 20	0.6 % + 20	5 % + 40
	5000 $\mu\text{A}$	0.1 $\mu\text{A}$	0.075 % + 2	1 % + 5	0.6 % + 5	0.6 % + 10	5 % + 40
DC mA <sup>[4]</sup>	50 mA	0.001 mA	0.05 % + 10 <sup>[6]</sup>	1 % + 20	0.6 % + 20	0.6 % + 20	5 % + 40
	400 mA	0.01 mA	0.15 % + 2	1 % + 5	0.6 % + 5	1.5 % + 10	5 % + 40
DC A <sup>[2]</sup>	5 A	0.0001 A	0.3 % + 10	1.5 % + 20	0.8 % + 20	3 % + 40 <sup>[5]</sup>	Not Spec'd
	10 A	0.001 A	0.3 % + 2	1.5 % + 10	0.8 % + 10	3 % + 10 <sup>[5]</sup>	Not Spec'd

[1] AC+DC ranges are specified from 2 % to 140 % of range.  
 [2] 20 A for 30 seconds on, 10 minutes off. >10 A not specified.  
 [3] Add 20 counts in dual display ac over dc, dc over ac or ac+dc.  
 [4] 400 mA continuous; 550 mA for 2 minutes on, 1 minute off.  
 [5] Verified by design and type tests.  
 [6] Temperature coefficient: 0.1 X (specified accuracy)/ °C (<18 °C or > 28 °C)



### Resistance Specifications

Function	Range	Resolution	Accuracy
Resistance	50 Ω <sup>[1][4]</sup>	0.001 Ω	0.15 % + 20
	500 Ω <sup>[1]</sup>	0.01 Ω	0.05 % + 10
	5 kΩ <sup>[1]</sup>	0.0001 kΩ	0.05 % + 2
	50 kΩ <sup>[1]</sup>	0.001 kΩ	0.05 % + 2
	500 kΩ	0.01 kΩ	0.05 % + 2
	5 MΩ	0.0001 MΩ	0.15 % + 4 <sup>[3]</sup>
	30 MΩ	0.001 MΩ	1.5 % + 4 <sup>[3]</sup>
	50 MΩ	0.01 MΩ	1.5 % + 4 <sup>[3]</sup>
	50 MΩ up to 100 MΩ	0.1 MΩ	3.0 % + 2 <sup>[3]</sup>
	100 MΩ up to 500 MΩ	0.1 MΩ	8 % + 2 <sup>[3]</sup>
Conductance	50 nS <sup>[2]</sup>	0.01 nS	1 % + 10 <sup>[3]</sup>

[1] When using the relative mode (REL  $\Delta$ ) to compensate for offsets.  
 [2] Add 20 counts above 33 nS in 50 nS range.  
 [3] For relative humidity >70 %, resistance accuracy is 0.5 % > 1 MΩ and 2.5 % > 10 MΩ.  
 [4] 289 only.

### Temperature Specifications

Temperature	Resolution	Accuracy <sup>[1,2]</sup>
-200 °C to +1350 °C	0.1 °C	1 % + 10
-328 °F to +2462 °F	0.1 °F	1 % + 18

[1] Does not include error of the thermocouple probe.  
 [2] Accuracy specification assumes ambient temperature stable to  $\pm 1$  °C. For ambient temperature changes of  $\pm 5$  °C, rated accuracy applies after 2 hours.

**Capacitance and Diode Test Specifications**

Function	Range	Resolution	Accuracy
Capacitance	1 nF <sup>[1]</sup>	0.001 nF	1 % + 5
	10 nF <sup>[1]</sup>	0.01 nF	1 % + 5
	100 nF <sup>[1]</sup>	0.1 nF	1 % + 5
	1 μF	0.001 μF	1 % + 5
	10 μF	0.01 μF	1 % + 5
	100 μF	0.1 μF	1 % + 5
	1000 μF	1 μF	1 % + 5
	10 mF	0.01 mF	1 % + 5
	100 mF	0.1 mF	2 % + 20
Diode Test	3.1 V	0.0001 V	1 % + 20

[1] With a film capacitor or better, using relative mode (REL Δ) to zero residual.

### Frequency Counter Specifications

Function	Range	Resolution	Accuracy
Frequency (0.5 Hz to 999.99 kHz, pulse width >0.5 μs)	99.999 Hz	0.001 Hz	0.02 % + 5
	999.99 Hz	0.01 Hz	0.005 % + 5
	9.9999 kHz	0.0001 Hz	0.005 % + 5
	99.999 kHz	0.001 Hz	0.005 % + 5 <sup>[1]</sup>
	999.99 kHz	0.01 Hz	0.005 % + 5
Duty Cycle <sup>[2][3]</sup>	1.00 % to 99.00 %	0.01 %	0.2 % per kHz + 0.1 %
Pulse Width <sup>[2][3]</sup>	0.1000 ms	0.0001 ms	0.002 ms + 3 counts
	1.000 ms	0.001 ms	0.002 ms + 3 counts
	10.00 ms	0.01 ms	0.002 ms + 3 counts
	1999.9 ms	0.1 ms	0.002 ms + 3 counts
<p>[1] For 64.000 kHz to 67.000 kHz, accuracy = ±5 Hz, at -20 to +55 °C with R.H. 0 % to 90 % (0 °C to 37 °C), 0 % to 65 % (37 °C to 45 °C), 0 % to 45 % (45 °C to 55 °C).</p> <p>[2] For rise times &lt;1 μs. Signals centered around trigger levels.</p> <p>[3] 0.5 to 200 kHz, pulse width &gt;2 μs. Pulse width range is determined by the frequency of the signal.</p>			

**Frequency Counter Sensitivity**

Input Range	Approximate Voltage Sensitivity (rms sine wave) <sup>[1]</sup>	AC Bandwidth <sup>[2]</sup>	Approximate DC Trigger Levels	DC Bandwidth <sup>[2]</sup>
	15 Hz to 100 kHz			
50 mV	5 mV	1 MHz	5 mV & 20 mV	600 kHz
500 mV	25 mV	1 MHz	20 mV & 60 mV	1 MHz
5 V	0.25 V	700 kHz	1.4 V & 2.0 V	80 kHz
50 V	2.5 V	1 MHz	0.5 V & 6.5 V	1 MHz
500 V	25 V	300 kHz	5 V & 40 V	300 kHz
1000 V	50 V	300 kHz	5 V & 100 V	300 kHz
Input Range	Approximate Current Sensitivity (rms sine wave)	AC Bandwidth	Approximate DC Trigger Levels	DC Bandwidth
	15 Hz to 10 kHz			
500 $\mu$ A	25 $\mu$ A	100 kHz	NA	NA
5000 $\mu$ A	250 $\mu$ A	100 kHz		
50 mA	2.5 mA	100 kHz		
400 mA	25 mA	100 kHz		
5 A	0.25 A	100 kHz		
10 A	0.5 A	100 kHz		
<p>[1] Maximum input = 10 x range (1000 V maximum, <math>2 \times 10^7</math> V-Hz product maximum). Noise at low frequencies and amplitudes may affect accuracy.</p> <p>[2] Typical frequency bandwidth with full scale (or maximum <math>2 \times 10^7</math> V-Hz product) rms sine wave.</p>				

**Input Characteristics**

Function	Overload Protection <sup>[1]</sup>	Input Impedance	Common Mode Rejection Ratio (1 kΩ unbalance)		Normal Mode Rejection					
$\overline{V}$	1000 V	10 MΩ <100 pF	>120 dB at dc, 50 Hz or 60 Hz		>60 dB at 50 Hz or 60 Hz					
$\overline{mV}$	1000 V <sup>[2]</sup>	10 MΩ <100 pF	>120 dB at dc, 50 Hz or 60 Hz		>60 dB at 50 Hz or 60 Hz					
$\tilde{V}$	1000 V	10 MΩ <100 pF (ac-coupled)	>60 dB, dc to 60 Hz							
$\overset{LoZ}{\tilde{V}}$	1000 V	3.2 kΩ <100 pF (ac-coupled)	Not specified		Not specified					
Function	Overload Protection <sup>[1]</sup>	Open Circuit Test Voltage	Full Scale Voltage		Typical Short Circuit Current					
			To 500 kΩ	>5 or 50 nS	500 Ω	5 kΩ	50 kΩ	500 kΩ	5 MΩ	50 MΩ
Ω	1000 V <sup>[2]</sup>	5 V dc	550 mV	<5 V	1 mA	100 μA	10 μA	1 μA	0.3 μA	0.3 μA
50Ω	1000 V <sup>[2]</sup>	20 V decreasing to 2.5 V	500 mV		10 mA					
$\rightarrow$	1000 V <sup>[2]</sup>	5 V dc	3.1 V dc		1 mA					
<p>[1] Input is limited to the product of a V rms sinewave times frequency of <math>2 \times 10^7</math> V-Hz.</p> <p>[2] For circuits &lt;0.5 A short circuit. 660V for high energy circuits.</p>										

**MIN MAX, Recording, and Peak Specifications**

Function	Nominal Response	Accuracy
MIN MAX, Recording	200 ms to 80% (dc function)	Specified accuracy $\pm 12$ counts for changes $> 425$ ms in duration in manual range.
	350 ms to 80 % (ac function)	Specified Accuracy $\pm 40$ counts for changes $> 1.5$ s in duration in manual range.
Peak	250 $\mu$ S (peak) <sup>[1]</sup>	Specified accuracy $\pm 100$ counts up to 5,000 count (full range) reading. For higher peak reading (to 12,000 counts), specified accuracy $\pm 2$ % of reading.
[1] For repetitive peaks; 2.5 ms for single events.		

**Burden Voltage (A, mA,  $\mu$ A)**

Function	Range	Burden Voltage
mA, $\mu$ A	500 $\mu$ A	102 $\mu$ V/ $\mu$ A
	5000 $\mu$ A	102 $\mu$ V/ $\mu$ A
	50.000 mA	1.8 mV/mA
	400.00 mA	1.8 mV/mA
A	5.0000 A	0.04 V/A
	10.000 A	0.04 V/A



**205 Westwood Ave**  
**Long Branch, NJ 07740**  
**1-877-742-TEST (8378)**  
**Fax: (732) 222-7088**  
**salesteam@Tequipment.NET**