

381

Remote Display True-rms Clamp Meter

Users Manual

Tequipment
|.NET



205 Westwood Ave
Long Branch, NJ 07740
1-877-742-TEST (8378)
Fax: (732) 222-7088
salesteam@Tequipment.NET

PN 3538357

July 2010

© 2010 Fluke Corporation. All rights reserved. Printed in China. Specifications are subject to change without notice. All product names are trademarks of their respective companies.

LIMITED WARRANTY AND LIMITATION OF LIABILITY

This Fluke product will be free from defects in material and workmanship for three years from the date of purchase. This warranty does not cover fuses, disposable batteries, or damage from accident, neglect, misuse, alteration, contamination, or abnormal conditions of operation or handling. Resellers are not authorized to extend any other warranty on Fluke's behalf. To obtain service during the warranty period, contact your nearest Fluke authorized service center to obtain return authorization information, then send the product to that Service Center with a description of the problem.

THIS WARRANTY IS YOUR ONLY REMEDY. NO OTHER WARRANTIES, SUCH AS FITNESS FOR A PARTICULAR PURPOSE, ARE EXPRESSED OR IMPLIED. FLUKE IS NOT LIABLE FOR ANY SPECIAL, INDIRECT, INCIDENTAL OR CONSEQUENTIAL DAMAGES OR LOSSES, ARISING FROM ANY CAUSE OR THEORY. Since some states or countries do not allow the exclusion or limitation of an implied warranty or of incidental or consequential damages, this limitation of liability may not apply to you.

Fluke Corporation
P.O. Box 9090
Everett, WA 98206-9090
U.S.A.

Fluke Europe B.V.
P.O. Box 1186
5602 BD Eindhoven
The Netherlands

Table of Contents

Title	Page
Introduction.....	1
How to Contact Fluke	1
Safety Information	2
Radio Frequency Data	7
Features	8
Remote Display	8
Hazardous Voltage Indicator	10
Flexible Current Probe	10
Auto Power Off	10
Backlight.....	11
Display Hold	11
MIN MAX AVG	11
DC Current Zero.....	11
Inrush	12
Low Battery Indicators.....	12

Display.....	17
Measurements.....	19
AC and DC Current (Jaw)	19
AC Current (Flexible Current Probe).....	22
AC and DC Voltage	23
Resistance/Continuity.....	26
Inrush Current Measurement (Jaw and Flexible Current Probe)	26
Frequency Measurement (Jaw and Flexible Current Probe)	28
Maintenance.....	28
Cleaning the Meter and Flexible Current Probe	28
Battery Replacement.....	29
User-Replaceable Parts	31
Specifications	32
Electrical Specifications.....	32
Mechanical Specifications	37
Environmental Specifications	38

Introduction

⚠⚠Warning

Read "Safety Information" before you use the Meter.

The Fluke 381 is a handheld, battery-operated Clamp Meter (the Meter) that has a remote-display module and detachable iFlex (Flexible Current Probe). The Remote Display can be removed from the Meter body and read away from the measurement source. This lets the display be easily read in difficult-measurement situations such as a hazardous environments, or very tight spaces. The Flexible Current Probe makes it possible to measure higher current (up to 2500 A ac) and larger cables that traditional jawed meters cannot measure.

How to Contact Fluke

To contact Fluke, call one of the following telephone numbers:

- Technical Support USA: 1-800-44-FLUKE (1-800-443-5853)
- Calibration/Repair USA: 1-888-99-FLUKE (1-888-993-5853)
- Canada: 1-800-36-FLUKE (1-800-363-5853)
- Europe: +31 402-675-200
- Japan: +81-3-3434-0181

- Singapore: +65-738-5655
- Anywhere in the world: +1-425-446-5500

Or, visit Fluke's website at www.fluke.com.

To register your product, visit <http://register.fluke.com>.

To see, print, or download the latest manual supplement, visit <http://us.fluke.com/usen/support/manuals>.

Safety Information



A **Warning** identifies conditions and actions that pose hazard(s) to the user; A **Caution** identifies conditions and procedures that could cause Meter damage, equipment under test damage, or permanent loss of data.

Symbols used on the Meter and in this manual are explained in Table 1.

⚠⚠ Warning

To prevent possible electrical shock or personal injury, follow these guidelines:

- **Use the Meter only as specified in this manual or the protection provided by the Meter can be compromised.**
- **Examine the case before you use the Meter. Look for cracks or missing plastic. Carefully look at the insulation around the connectors.**
- **Never measure ac current while the test leads are inserted into the input jacks.**
- **Make sure the battery door is closed and latched before operating the Meter.**
- **Remove the test leads from the Meter before the battery door is opened.**

- Examine the test leads for damaged insulation or exposed metal. Check test lead continuity. Replace damaged test leads before using the Meter.
- Do not use the Meter if it operates incorrectly. Protection can be compromised. When in doubt, have the Meter serviced.
- Do not use the Meter around explosive gas, vapor or in damp or wet environments.
- Use only type AAA batteries, properly installed in the Meter case, to power the Meter.
- To avoid false readings that can lead to electrical shock and injury, replace the batteries as soon as the low battery indicator (meter  or remote ) appears.
- When servicing the Meter, use only specified replacement parts. See Table 5.
- Have the Meter serviced only by qualified service personnel.
- Be careful around voltages > 30 V ac rms, 42 V ac peak, or 60 V dc. Such voltages pose a shock hazard.
- Do not apply more than the rated voltage, as marked on the Meter, between the terminals or between any terminal and earth ground.
- When using the probes, keep fingers behind the finger guards on the probes.
- Connect the common test lead before connecting the live test lead. When disconnecting test leads, disconnect the live test lead first.
- Do not work alone so assistance can be rendered in an emergency.











- **Use extreme caution when working around bare conductors or bus bars. Contact with the conductor could result in electric shock.**
- **Adhere to local and national safety codes. Individual protective equipment must be used to prevent shock and arc blast injury where hazardous live conductors are exposed.**
- **When measuring, keep fingers behind the Tactile Barrier. See Figure 2.**
- **Disconnect circuit power and discharge all high-voltage capacitors before you do diode tests or measure resistance, continuity, or capacitance.**
- **Do not measure ac/dc current in circuits carrying more than 1000 V or 1000 A with the Meter Jaw.**
- **Never operate the Meter with the back cover removed or the case open.**
- **Do not measure ac current in circuits carrying more than 1000 V or 2500 A with the Flexible Current Probe.**
- **Do not apply the Flexible Current Probe around or remove from HAZARDOUS LIVE conductors.**
- **Take special care during fitting and removal of the Flexible Current Probe. De-energize the installation under test or wear suitable protective clothing.**





⚠ Caution

To avoid possible damage to the Meter or to equipment under test:

- **Use the proper jacks, function, and range for the measurement application.**

Table 1. Symbols

Symbol	Meaning	Symbol	Meaning
	AC (Alternating Current)		Earth ground
	DC (Direct Current)		AC and dc current.
	Hazardous voltage		Conforms to European Union directives.
	Risk of Danger. Important information. See Manual.		Conforms to relevant North American Safety Standards.
	Battery. Low battery when shown.		Double insulated
	Do not dispose of this product as unsorted municipal waste. Go to Fluke's website for recycling information.		

Symbol	Meaning	Symbol	Meaning
CAT III	IEC Measurement Category III CAT III equipment has protection against transients in equipment in fixed-equipment installations, such as distribution panels, feeders and short branch circuits, and lighting systems in large buildings.	CAT IV	IEC Measurement Category IV CAT IV equipment has protection against transients from the primary supply level, such as an electricity Meter or an overhead or underground utility service.
	Examined and licensed by TÜV Product Services.		Conforms to relevant Australian standards.
	Do not apply to or remove from HAZARDOUS LIVE conductors.		Application around and removal from HAZARDOUS LIVE conductors is permitted.

Note

The Measurement Category (CAT) and voltage rating of any combination of test probe, test probe accessory, current clamp accessory, and the Meter is the LOWEST rating of any individual component.

Radio Frequency Data

Note

Changes or modifications to the wireless 2.4 GHz radio not expressly approved by Fluke Corporation could void the user's authority to operate the equipment.

This device complies with Part 15 of the FCC Rules. Operation is subject to the two conditions that follow:

1. This device can not cause interference.
2. This device must accept any interference, including interference that can cause undesired operation of the device.

Class B digital device: A digital device that is marketed for operation in a residential environment not withstanding use in commercial, business and industrial environments. Examples of such devices include, but are not limited to, personal computers, calculators, and equivalent electronic devices that are marketed for operation by the general public.

The Meter was tested and found to comply with the limits for a Class B digital device, pursuant to Part 15 of the FCC Rules. These limits are designed to provide reasonable protection against harmful interference in a residential installation. This equipment generates, uses, and can radiate radio frequency energy and, if not installed and used in accordance with the instructions, can cause harmful interference to radio communications. However, there is no guarantee that interference will not occur in a particular installation. If this equipment does cause harmful interference to radio or television reception, which can be determined by turning the equipment

off and on, the user is encouraged to try to correct the interference by one or more of the measures that follow:

- Reorient or relocate the receiving antenna.
- Increase the separation between the equipment and receiver.
- Consult the dealer or an experienced radio/TV technician for help.

The term "IC:" before the radio certification number only signifies the device meets Industry's Canada technical specifications.

Features

The following sections explain the Meter features in detail. See Figure 2 and Table 2.

Remote Display

The Meter uses low-power 802.15.4 wireless technology to let the display module operate in a different location than the Meter base. Although there is control of some Meter functions (Hold, MIN MAX AVG, and Backlight), complete remote control of the Meter is not available through the display module.

The wireless radio signal does not hinder Meter measurements. Usually, the radio signal is off when the display module is docked to the Meter base. It is possible for the radio signal to be on when the display module is docked and the Rotary Function Switch is set to OFF. To make sure that the radio signal is off, remove the batteries from the Meter base and display module.

The display module is synchronized with a Meter base when it is docked on the Meter base and turned on. Different display modules can be synchronized with a Meter base but, only one display module can be synchronized to a Meter base at the same time.

Remote Display True-rms Clamp Meter Features

The Meter base and display can be a maximum of 10 meters from each other before the radio signal connection is broken. This distance can change with the obstacles between the Meter base and display. There is a radio connection when (()) shows in the display. To detach the display from the Meter base, see Figure 1.

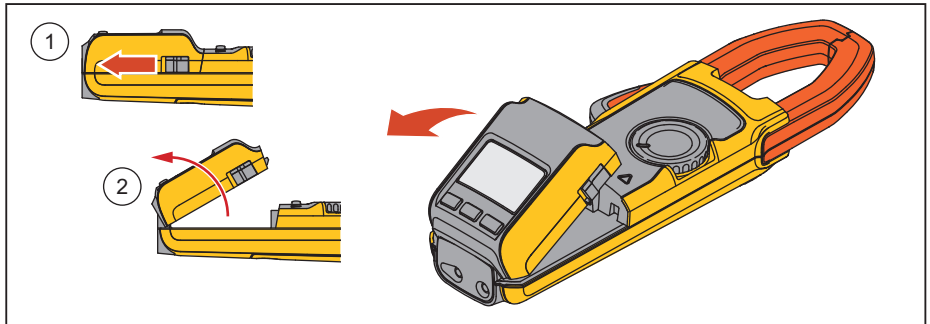

ghn10.eps

Figure 1. Remote Display

Hazardous Voltage Indicator

When the Meter senses a voltage ± 30 V or a voltage overload (OL), \overline{V} is shown on the display and the red high-voltage LED (\overline{V}) on the Meter base illuminates to tell you a hazardous voltage is at the Meter input.

Flexible Current Probe

$\overline{\Delta}$ $\overline{\Delta}$ Warning

To avoid electrical shock, do not apply or remove from live hazardous conductors.



The high-performance AC Flexible Current Probe utilizes the Rogowski principle and is used for accurate, non-intrusive measurement of sinusoidal, pulsed, and other complex waveforms. The flexible and lightweight measuring head allows quick and easy installation in hard-to-reach areas and works well with large conductors.

For more information about the Flexible Current Probe, see “Current Measurement (Flexible Current Probe)”.



Auto Power Off

The Meter powers off if there is no button push or Rotary Function Switch operation for 20 minutes. If the Meter powers off, turn the Rotary Function Switch OFF and then back on again. Auto Power Off is disabled during Min Max Avg function use. To disable the Auto Power Off, hold down $\overline{0}$ while turning on the Meter.

Backlight



Push  to toggle the Backlight on and off. The Backlight automatically goes off after 2 minutes. To disable the Backlight Auto Off feature, hold down  while turning on the Meter.

Display Hold

To capture and hold the present display reading, push  while taking a reading. Push  again to return to the live reading.

MIN MAX AVG

Min Max Avg mode can capture the minimum, maximum, and average readings of a given output signal over an extended time.

Push  to enter Min Max Avg mode, push again to toggle between min and max readings. Push a third time to display the average reading. To exit Min Max Avg mode, push and hold  for 2 seconds. When Min Max Avg mode is active, the Auto Power Off feature is disabled.





DC Current Zero

Push  to remove any dc offset that could affect the accuracy of dc readings.

Inrush

Inrush Current is surge current that occurs when an electrical device is first powered on. The Meter can capture this surge current reading. Current spikes from motor drives are one example of such an event. The Inrush function takes approximately 400 samples over a 100 ms period and calculates the starting current envelope.

Low Battery Indicators

The Meter uses two low battery symbols: meter  and remote . When meter  appears, the batteries in the Meter base should be changed. Low batteries on the Meter base will affect the readings. When remote  is displayed, the batteries for the removable display should be changed. Measurements are not affected by low batteries in the display.

Remote Display True-rms Clamp Meter Features

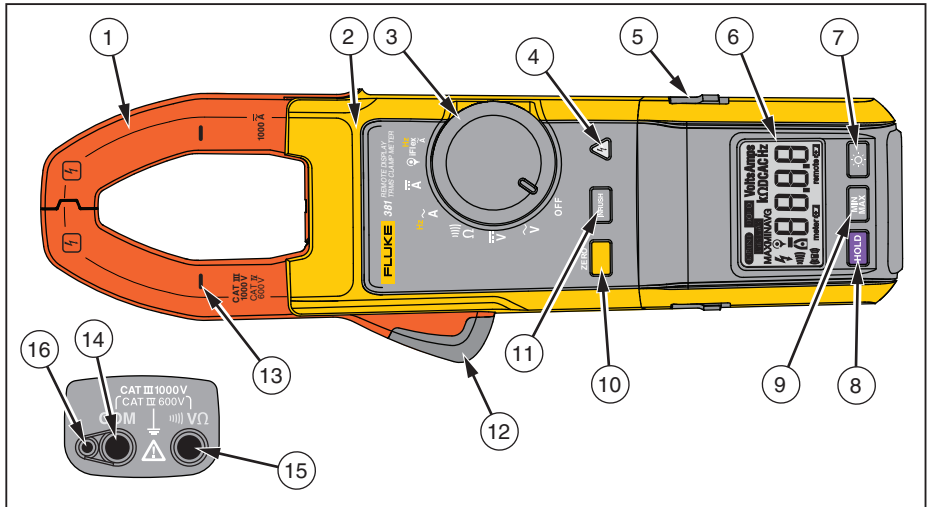

ghn02.eps

Figure 2. Meter Features

Table 2. Meter Features

Item	Description
①	Current sensing Jaw
②	Tactile Barrier
③	Rotary Function Switch, see Table 3.
④	Hazardous-voltage indicator
⑤	Display release button
⑥	Display
⑦	Backlight button: turns the Backlight on and off. The Backlight stays on for 2 minutes when there is no button or switch interaction and then shuts off.
⑧	Hold button: freezes the display reading and releases the reading when pushed a second time.
⑨	Min Max button: when first pushed, the Meter shows maximum input. With subsequent pushes, the minimum and the average inputs are shown. Hold  for 2 seconds to exit min max mode. This function works in current, voltage, and frequency modes.

Remote Display True-rms Clamp Meter Features

Item	Description
⑩	Zero/Shift button: removes dc offset from dc current measurements. Also used to shift and corresponds to the yellow items on the Rotary Function Switch.
⑪	Inrush button: push to enter inrush mode. Push a second time to exit inrush mode. Integration time is 100 ms.
⑫	Jaw release
⑬	Alignment marks: to meet accuracy specifications, the conductor must be aligned with these marks.
⑭	Common terminal
⑮	Volts/Ohm input terminal
⑯	Flexible Current Probe input terminal

Table 3. Rotary Function Switch

Switch Position	Function
OFF	Meter is powered down
\tilde{V}	AC voltage
\bar{V}	DC voltage
Ω	Resistance and continuity
Hz ~ A	AC current. Push <input type="checkbox"/> ZERO to shift to frequency.
\bar{A}	DC current
Hz iFlex A	AC current and frequency measurement using the Flexible Current Probe. Push <input type="checkbox"/> ZERO to shift to frequency.

Display

To view all segments on the display at once, push **[HOLD]** while turning the Meter on. See Figure 3 and Table 4.

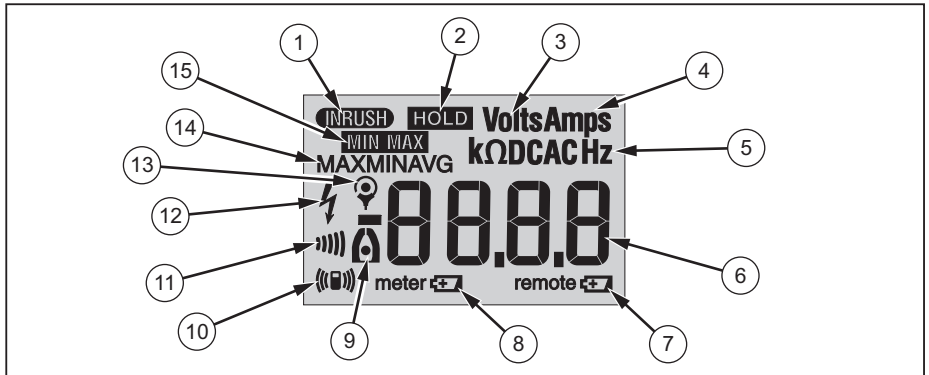

ghn01.eps

Figure 3. Display

Table 4. Display

Item	Description	Item	Description
①	Inrush is active	⑧	Meter base low-battery symbol
②	Hold is active	⑨	Measurement is taken at the Jaw.
③	Volts	⑩	RF signal is being sent to remote display.
④	Amps	⑪	Continuity
⑤	Ohms, DC, AC, Hz	⑫	Hazardous voltage is present.
⑥	Main display	⑬	Measurement is taken at the Flexible Current Probe.
⑦	Remote display low-battery symbol	⑭	Min, Max, or Avg reading is being shown.
		⑮	Min Max mode is active.

Measurements

Note

Prior to first use, remove the battery isolator (small piece of plastic between the batteries and battery contacts).

AC and DC Current (Jaw)

⚠ ⚠ Warning

To avoid electric shock or personal injury:

- **When making current measurements, disconnect the test leads from the Meter.**
- **Keep fingers behind Tactile Barrier. See Figure 2 and Table 2.**

Note

When measuring current, center the conductor in the Jaw using the alignment marks on the Jaw.

Before taking dc measurements, push  to ensure correct readings. Zeroing the Meter removes dc offset from the reading. The Zero function works only in the dc current measurement Rotary Function Switch position.

Note

Before zeroing the Meter, make sure the Jaws are closed and there is no conductor inside the Jaw.

To measure ac or dc current:

1. Turn the Rotary Function Switch to the proper function. You should see  on the display, indicating that the measurement is coming from the Jaw.

Note

When the measured current is < 0.5 A, the center dot in the display icon  will flash on and off. With current > 0.5 A, the center dot will be steady.

2. If measuring dc, wait for the display to stabilize and then push  to zero the Meter.
3. Open the Jaw by pressing the Jaw Release and insert the conductor into the Jaw.
4. Close the Jaw and center the conductor using the alignment marks.
5. View the reading on the display. See Figure 4.

Note

Current flowing in opposite directions cancels each other. If current is moving in opposite directions, place one conductor into the clamp at a time. See Figure 4.

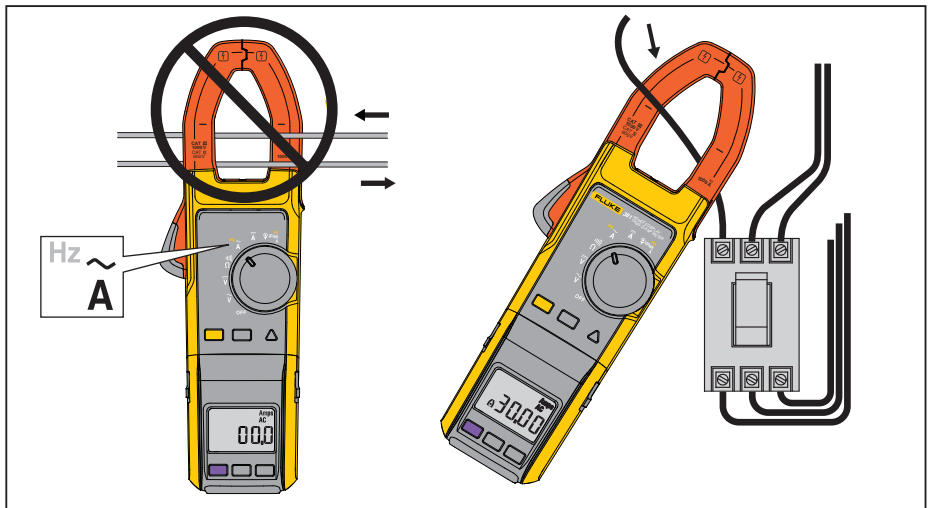

Figure 4. Current Measurement with Jaw

AC Current (Flexible Current Probe)**⚠⚠ Warning**

To prevent possible electrical shock or personal injury:



Do not apply the Flexible Current Probe around or remove from HAZARDOUS LIVE conductors. Take special care during fitting and removal of the Flexible Current Probe. De-energize the installation under test or wear suitable protective clothing.

To use the Flexible Current Probe, follow these instructions:

1. Connect the Flexible Current Probe to the Meter. See Figure 5.
2. Connect the flexible part of the Flexible Current Probe around the conductor. If opening the end of the Flexible Current Probe to make the connection, make sure that you close and latch it. See the detail in Figure 5. You should be able to hear and feel the Flexible Current Probe lock snap into place.

Note

When measuring current, center the conductor in the Flexible Current Probe. If possible, avoid taking measurements close to other current-carrying conductors.

3. Keep the probe coupling more than 2.5 cm (1 inch) away from the conductor.
4. Turn the Rotary Function Switch to  iFlex^{Hz} . When the Rotary Function Switch is in the correct position,  shows on the display, meaning that the readings are coming from the Flexible Current Probe.

Note

When the measured current is < 0.5 A, the center dot in the display icon (A) will flash on and off. With current > 0.5 A, the center dot will be steady.

5. Observe the current value on the Meter display.

If the Flexible Current Probe does not perform as expected:

1. Inspect the coupling system to make sure that it is connected and closed correctly or for any damage. If any foreign material is present, the coupling system will not close properly.
2. Inspect the cable between the Flexible Current Probe and the Meter for any damage.
3. Check that the Rotary Function Switch of the Meter is in the correct position (Ⓜ^{Hz}_{iFlex}_A).

AC and DC Voltage

To measure ac or dc voltage:

1. Turn the Rotary Function Switch to the proper voltage function (V~ or V-).
2. Connect the black test lead to the **COM** terminal and the red test lead to the **VΩ** terminal. See Figure 6.
3. Measure the voltage by touching the probes to the desired test points of the circuit. View the reading on the display.

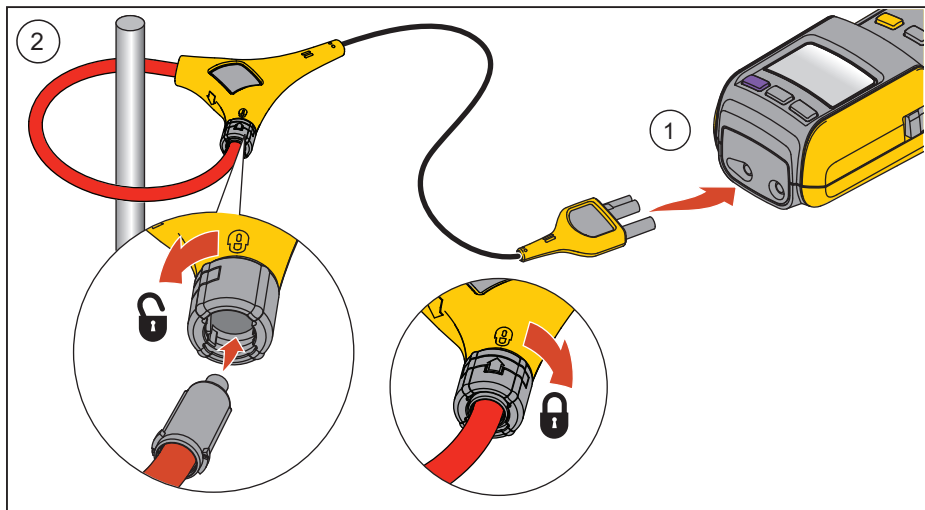

ghn09.eps

Figure 5. Flexible Current Probe Connection

Remote Display True-rms Clamp Meter Measurements

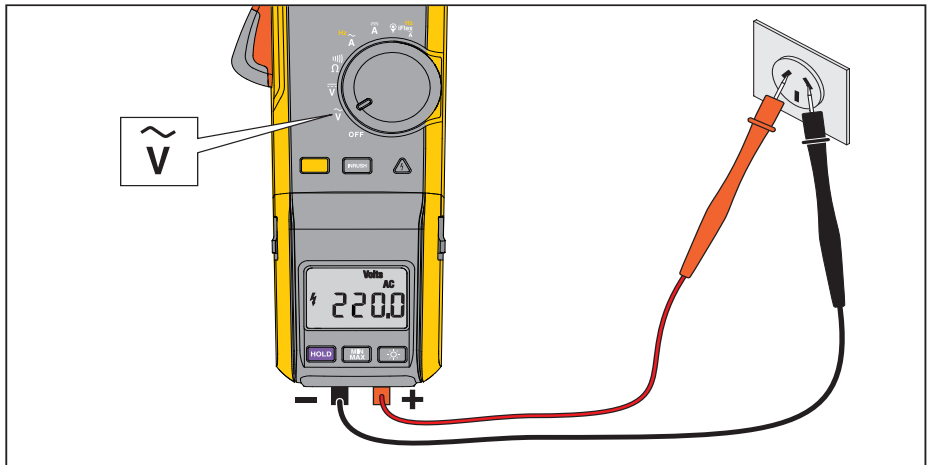

Figure 6. Measurement with Test Leads (AC Voltage Shown)

Resistance/Continuity

To measure resistance or continuity:

1. Turn the Rotary Function Switch to Ω .
2. Remove power from the circuit being tested.
3. Connect the black test lead to the **COM** terminal and the red test lead to the $V\Omega$ terminal.
4. Measure the resistance by touching the probes to the desired test points of the circuit.
5. View the reading on the display.

If the resistance is $< 30 \Omega$, continuity is indicated by a beeper continuously sounding. If the display reads **OL**, the circuit is open.

Inrush Current Measurement (Jaw and Flexible Current Probe)

The Meter can capture the initial inrush current when starting a device such as a motor or light ballast. To measure the inrush current:

1. With the device under test off, turn the Meter Rotary Function Switch to $\overset{Hz}{\sim} \bar{A}$, \bar{A} , or $\overset{Hz}{\Phi} \bar{A}$ if the Flexible Current Probe is being used for the measurement.
2. Center the Jaw or Flexible Current Probe around the device's live wire.
3. Push **INRUSH** on the Meter.
4. Turn on the device under test. The inrush current (spike) is displayed on the Meter display. See Figure 7.

Remote Display True-rms Clamp Meter Measurements

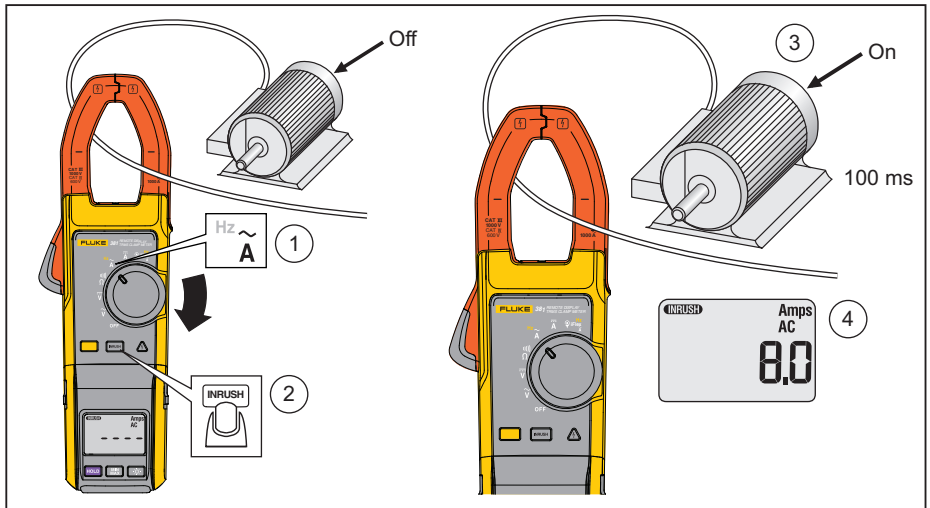

ghn11.eps

Figure 7. Inrush Current Measurement

Frequency Measurement (Jaw and Flexible Current Probe)

To measure frequency:

1. Turn the Meter Rotary Function Switch to $\text{Hz} \sim \text{A}$ or $\text{Hz} \text{IFlex} \text{A}$ if the Flexible Current Probe is being used for the measurement.
2. Center the Jaw or Flexible Current Probe around the measurement source.
3. Push  on the Meter to shift to **Hz**. The frequency is displayed on the Meter display.

Maintenance

Warning

To avoid possible electric shock or personal injury, repairs or servicing not covered in this manual should be performed only by qualified personnel.

Cleaning the Meter and Flexible Current Probe

Warning

To avoid electrical shock, remove any input signals before cleaning.

Caution

To avoid damaging the Meter, do not use aromatic hydrocarbons or chlorinated solvents for cleaning. These solutions will react with the plastics used in the Meter. Do not immerse the Meter in water.

Clean the instrument case with a damp cloth and mild detergent.

Battery Replacement

To replace the batteries in the Meter body, see Figure 8:

1. Turn the Meter OFF.
2. Use a flat head screwdriver to loosen the battery compartment door screw on the Meter base, and remove the door from the case bottom.
3. Remove the batteries.
4. Replace the batteries with three new AAA batteries.
5. Reattach the battery compartment door to the case bottom and tighten the screw.

To replace the batteries in the display module, see Figure 8:

1. Turn the Meter off.
2. Using the two latches on the side of the Meter, remove the display module.
3. On the bottom of the display module, there is a flat section in the center of the module. With your thumb, push down and slide the door towards you to open the battery compartment,
4. Remove the batteries.
5. Replace the batteries with two new AAA batteries.
6. Slide the battery door back into place.
7. Dock the Display Module with the Meter base and turn the Meter on.

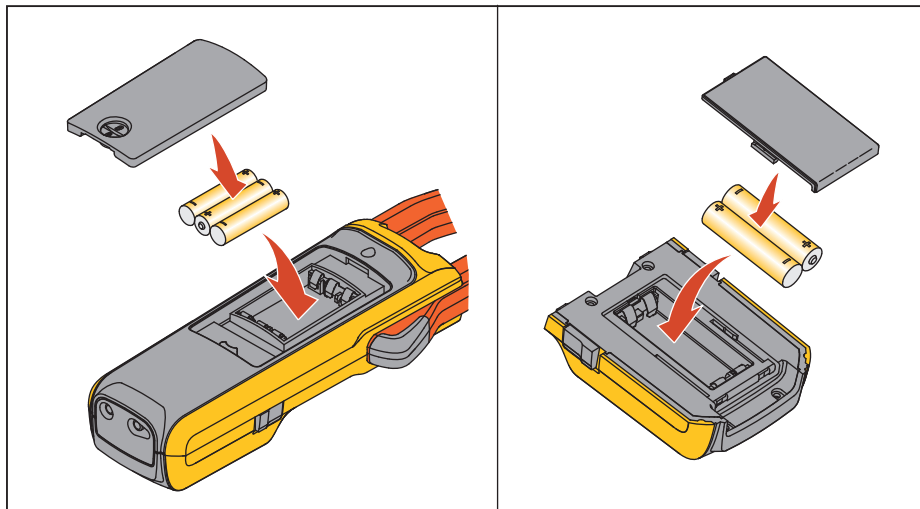

ghn03.eps

Figure 8. Battery Replacement

User-Replaceable Parts

Table 5. User-Replaceable Parts

Description	Qty.	Fluke Part Number
Battery, AAA 1.5 V	5	2838018
Battery Door - Display Module	1	3625529
Battery Door - Meter Base	1	3766406
Fluke 381 Remote Display	1	3766445
Soft Case	1	3752973
User Manual	1	3538357

Specifications

Electrical Specifications

AC Current Via Jaw

Range	999.9 A
Resolution	0.1 A
Accuracy	2 % \pm 5 digits (10-100 Hz)
	5 % \pm 5 digits (100-500 Hz)
Crest Factor (50/60 Hz)	3 @ 500 A
	2.5 @ 600 A
	1.42 @ 1000 A
	Add 2 % for C.F. > 2

AC Current via Flexible Current Probe

Range	999.9 A / 2500 A (45 Hz – 500 Hz)
Resolution	0.1 A / 1 A
Accuracy	3 % \pm 5 digits
Crest Factor (50/60Hz)	3.0 at 1100 A 2.5 at 1400 A 1.42 at 2500 A Add 2 % for C.F. > 2

Position Sensitivity

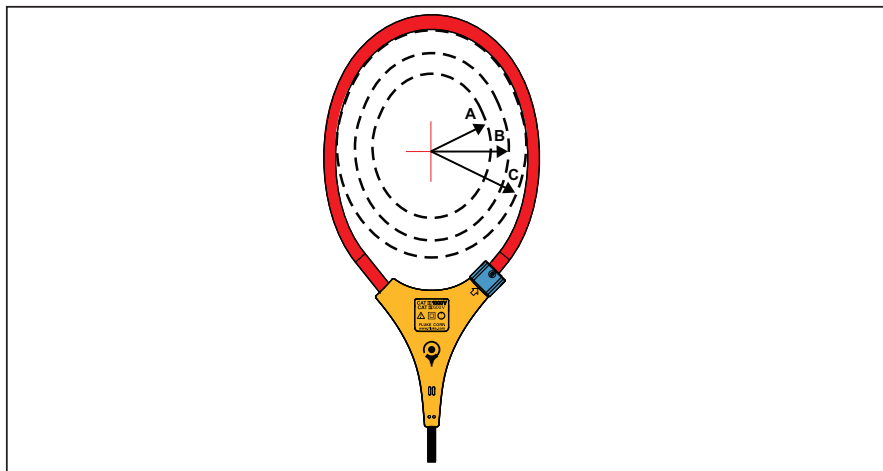

ghn12.eps

Figure 9. Position Sensitivity

Remote Display True-rms Clamp Meter Specifications

Distance from Optimum	i2500-10 Flex	i2500-18 Flex	Error
A	0.5 in (12.7 mm)	1.4 in (35.6 mm)	± 0.5 %
B	0.8 in (20.3 mm)	2.0 in (50.8 mm)	± 1.0 %
C	1.4 in (35.6 mm)	2.5 in (63.5 mm)	± 2.0 %

Measurement uncertainty assumes centralized primary conductor at optimum position, no external electrical or magnetic field, and within operating temperature range.

DC Current

Range	999.9 A
Resolution	0.1 A
Accuracy	2 % ± 5 digits

AC Voltage

Range	600 V /1000 V
Resolution	0.1 V / 1 V
Accuracy	1.5 % ± 5 digits (20 – 500 Hz)

DC Voltage

Range	600.0 V /1000 V
Resolution	0.1 V / 1 V
Accuracy	1 % \pm 5 digits

Frequency – Via Jaw

Range	5.0 – 500.0 Hz
Resolution	0.1 Hz
Accuracy	0.5 % \pm 5 digits
Trigger Level	5 – 10 Hz, \geq 10 A
	10 – 100 Hz, \geq 5 A
	100 – 500 Hz, \geq 10 A

Frequency via Flexible Current Probe

Range	5.0 to 500.0 Hz
Resolution	0.1 Hz
Accuracy	0.5 % \pm 5 digits
Trigger Level	5 to 20 Hz, \geq 25 A 20 to 100 Hz, \geq 20 A 100 to 500 Hz, \geq 25 A

Resistance

Range	600 Ω /6 k Ω /60 k Ω
Resolution	0.1 Ω /1 Ω /10 Ω
Accuracy	1 % \pm 5 digits

Mechanical Specifications

Size (L x W x H)	277 mm * 88 mm * 43 mm (55 mm for remote unit)
Weight.....	350 g
Jaw Opening	34 mm
Flexible Current Probe Diameter	7.5 mm

Flexible Current Probe Cable Length
(head to electronics connector) 1.8 m

Environmental Specifications

Operating Temperature.....-10 °C to +50 °C

Storage Temperature.....-40 °C to +60 °C

Operating Humidity Non condensing (< 10 °C)
≤ 90 % RH (at 10 °C to 30 °C)
≤ 75 % RH (at 30 °C to 40 °C)
≤ 45 % RH (at 40 °C to 50 °C)
(Without Condensation)

Operating Altitude 2000 meters

Storage Altitude 12,000 meters





EMI, RFI, EMC, RF EN 61326-1:2006, EN 61326-2-2:2006

ETSI EN 300 328 V1.7.1:2006

ETSI EN 300 489 V1.8.1:2008

FCC Part 15 Subpart C Sections 15.207, 15.209, 15.249
FCCID: T68-F381

Remote Display True-rms Clamp Meter Specifications

	RSS-210 IC: 6627A-F381
Temperature Coefficients	Add 0.1 x specified accuracy for each degree C above 28 °C or below 18 °C
Wireless Frequency	2.4 GHz ISM Band 10 meter range
Safety Compliance	ANSI/ISA S82.02.01:2004 CAN/CSA-C22.2 No. 61010-1-04 IEC/EN 61010-1:2001 to 1000V CAT III, 600V CAT IV.
Double Insulation Clearance	Per IEC 61010-2-032
Double Insulation Creepage	Per IEC 61010-1
Agency Approvals	 ,  ,  , 



Tequipment
_____.NET

USA

205 Westwood Ave
Long Branch, NJ 07740
1-877-742-TEST (8378)
Fax: (732) 222-7088
salesteam@Tequipment.NET