

Tequipment
NET



205 Westwood Ave
Long Branch, NJ 07740
1-877-742-TEST (8378)
Fax: (732) 222-7088
salesteam@Tequipment.NET

FLUKE®

421D

Distance Meter

Users Manual

September 2009

© 2009 Fluke Corporation. All rights reserved. Specifications are subject to change without notice.
All product names are trademarks of their respective companies.

LIMITED WARRANTY AND LIMITATION OF LIABILITY

Each Fluke product is warranted to be free from defects in material and workmanship under normal use and service. The warranty period is two years and begins on the date of shipment. Parts, product repairs, and services are warranted for 90 days. This warranty extends only to the original buyer or end-user customer of a Fluke authorized reseller, and does not apply to fuses, disposable batteries, or to any product which, in Fluke's opinion, has been misused, altered, neglected, contaminated, or damaged by accident or abnormal conditions of operation or handling. Fluke warrants that software will operate substantially in accordance with its functional specifications for 90 days and that it has been properly recorded on non-defective media. Fluke does not warrant that software will be error free or operate without interruption.

Fluke authorized resellers shall extend this warranty on new and unused products to end-user customers only but have no authority to extend a greater or different warranty on behalf of Fluke. Warranty support is available only if product is purchased through a Fluke authorized sales outlet or Buyer has paid the applicable international price. Fluke reserves the right to invoice Buyer for importation costs of repair/replacement parts when product purchased in one country is submitted for repair in another country.

Fluke's warranty obligation is limited, at Fluke's option, to refund of the purchase price, free of charge repair, or replacement of a defective product which is returned to a Fluke authorized service center within the warranty period.

To obtain warranty service, contact your nearest Fluke authorized service center to obtain return authorization information, then send the product to that service center, with a description of the difficulty, postage and insurance prepaid (FOB Destination). Fluke assumes no risk for damage in transit. Following warranty repair, the product will be returned to Buyer, transportation prepaid (FOB Destination). If Fluke determines that failure was caused by neglect, misuse, contamination, alteration, accident, or abnormal condition of operation or handling, including overvoltage failures caused by use outside the product's specified rating, or normal wear and tear of mechanical components, Fluke will provide an estimate of repair costs and obtain authorization before commencing the work. Following repair, the product will be returned to the Buyer transportation prepaid and the Buyer will be billed for the repair and return transportation charges (FOB Shipping Point).

THIS WARRANTY IS BUYER'S SOLE AND EXCLUSIVE REMEDY AND IS IN LIEU OF ALL OTHER WARRANTIES, EXPRESS OR IMPLIED, INCLUDING BUT NOT LIMITED TO ANY IMPLIED WARRANTY OF MERCHANTABILITY OR FITNESS FOR A PARTICULAR PURPOSE. FLUKE SHALL NOT BE LIABLE FOR ANY SPECIAL, INDIRECT, INCIDENTAL OR CONSEQUENTIAL DAMAGES OR LOSSES, INCLUDING LOSS OF DATA, ARISING FROM ANY CAUSE OR THEORY.

Since some countries or states do not allow limitation of the term of an implied warranty, or exclusion or limitation of incidental or consequential damages, the limitations and exclusions of this warranty may not apply to every buyer. If any provision of this Warranty is held invalid or unenforceable by a court or other decision-maker of competent jurisdiction, such holding will not affect the validity or enforceability of any other provision.

Fluke Corporation
P.O. Box 9090
Everett, WA 98206-9090
U.S.A.

Fluke Europe B.V.
P.O. Box 1186
5602 BD Eindhoven
The Netherlands

Table of Contents

Title	Page
Introduction	1
How to Contact Fluke	1
Use of the instrument	1
Permitted use	1
Prohibited use	1
Limits of use	2
Areas of responsibility	2
Responsibilities of the manufacturer (Fluke).....	2
Responsibilities of the manufacturer of non-Fluke accessories	2
Responsibilities of the person in charge of the instrument.....	2
Hazards in use.....	3
Precautions	3
Safety Instructions.....	3
Symbols.....	3
Electromagnetic Compatibility (EMC).....	4

FCC statement (U.S.A only)	4
Laser classification.....	5
Integrated distance meter	5
Laser Class 2 products:	5
Start-up	6
Inserting/replacing batteries	6
Changing the reference point (multifunctional endpiece).....	7
Keypad.....	8
Display	9
Menu functions	10
Settings.....	10
Navigation in the menu	10
General description	10
Setting the unit for distance measurements	12
Setting the unit for tilt measurements.....	12
Beep (BEEP).....	12
Continuous laser (→*).....	12
Measuring with the tripod (TRIPOD).....	12
Display - keypad illumination (☼).....	13
Reset - returning the instrument to the factory settings (RESET)	13
Operation.....	13
Switching on and off.....	13
CLEAR button	13
Display / keypad illumination.....	13
Reference setting.....	13
Measuring.....	14
Single distance measurement.....	14
Minimum/maximum measurement	14
Functions.....	15

Addition / subtraction	15
Distance measuring	15
Area	15
Volume	15
Tilt measurement	16
Tilt sensor calibration.....	16
Indirect horizontal distance.....	17
Stake out function.....	17
Room corner angle function	18
Indirect measurement.....	19
Indirect measurement - determining a distance using 2 auxilliary measurements	19
Indirect Measurement - determining a distance using 3 measurements.....	20
Indirect measurement - determining a chain value using 3 measurements	20
Storage of constants/historical storage.....	21
Storage of a constant.....	21
Recalling the constant	21
Historical storage	21
Timer (self-triggering)	21
Appendix	22
Message codes	22
Technical data	23
Measuring conditions.....	25
Measuring range.....	25
Target surfaces.....	25
Care and Cleaning.....	25

Distance Meter

Introduction

Carefully read the Safety Instructions and the User Manual before using this product.

How to Contact Fluke

To contact Fluke, call one of the following telephone numbers:

- Technical Support USA: 1-800-44-FLUKE (1-800-443-5853)
- Calibration/Repair USA: 1-888-99-FLUKE (1-888-993-5853)
- Canada: 1-800-36-FLUKE (1-800-363-5853)
- Europe: +31 402-675-200
- Japan: +81-3-3434-0181
- Singapore: +65-738-5655
- Anywhere in the world: +1-425-446-5500

Or, visit Fluke's website at www.fluke.com.

To register your product, visit <http://register.fluke.com>.

To view, print, or download the latest manual supplement, visit <http://us.fluke.com/usen/support/manuals>.

Use of the instrument

Permitted use

- Measuring distances
- Computing functions, e. g. areas and volumes
- Measuring tilts

Prohibited use

- Using the instrument without instruction
- Using outside the stated limits
- Deactivation of safety systems and removal of explanatory and hazard labels
- Opening of the equipment by using tools (screwdrivers, etc.), as far as not specifically permitted for certain cases
- Carrying out modification or conversion of the product

- Use of accessories from other manufacturers without the express approval of Fluke
- Deliberate or irresponsible behavior on scaffolding, when using ladders, when measuring near machines which are running, or near parts of machines or installations which are unprotected
- Aiming directly into the sun
- Pointing the laser directly at people or animals in light or dark conditions.
- Inadequate safeguards at the surveying site (for example, when measuring on roads, construction sites, etc.)

Limits of use

Note

See section "Technical Data".

The Fluke 421D is designed for use in areas permanently habitable by humans, do not use the product in explosion hazardous areas or in aggressive environments.

Areas of responsibility

Responsibilities of the manufacturer (Fluke)

Fluke is responsible for supplying the product, including the User Manual and original accessories, in a completely safe condition.

Responsibilities of the manufacturer of non-Fluke accessories

The manufacturers of non-Fluke accessories for the 421D are responsible for developing, implementing and communicating safety concepts for their products. They are also responsible for the effectiveness of these safety concepts in combination with Fluke equipment.

Responsibilities of the person in charge of the instrument

⚠ Warning

The person responsible for the instrument must ensure that the equipment is used in accordance with the instructions. This person is also accountable for the deployment of personnel and for their training and for the safety of the equipment when in use.

The person in charge of the instrument has the following duties:

- To understand the safety instructions on the product and the instructions in the User Manual.
- To be familiar with local safety regulations relating to accident prevention.
- To inform Fluke immediately if the equipment becomes unsafe.

Hazards in use

⚠ Caution

Watch out for erroneous distance measurements if the instrument is defective or if it has been dropped or has been misused or modified.

Precautions

Carry out periodic test measurements. Particularly after the instrument has been subject to abnormal use, and before, during and after important measurements.

Make sure the 421D optics is kept clean and that there is no mechanical damage to the bumpers.

⚠ Caution

In using the instrument for distance measurements or for positioning moving objects (for example, cranes, building equipment, platforms, etc.) unforeseen events may cause erroneous measurements.

Only use this product as a measuring sensor, not as a control device. Your system must be configured and operated in such a way, that in case of an erroneous measurement, malfunction of the device or power failure due to installed safety measures (for example, safety limit switch), it is assured that no damage will occur.

⚠ Warning

Flat batteries must not be disposed of with household waste. Care for the environment and take them to the collection points provided in accordance with national or local regulations.

The product must not be disposed of with household waste.

Dispose of the product appropriately in accordance with the national regulations in force in your country.

Always prevent access to the product by unauthorized personnel.

Product specific treatment and waste management information can be downloaded from the Fluke home page at <http://www.fluke.com> or received from your Fluke dealer.

Safety Instructions

Symbols





The symbols used in the Safety Instructions have the following meanings:

⚠ Warning

Indicates a potentially hazardous situation or an unintended use which, if not avoided, will result in death or serious injury.

⚠ Caution

Indicates a potentially hazardous situation or an unintended use which, if not avoided, may result in minor injury and/or in appreciable material, financial and environmental damage.

Symbol	Description
	Do not dispose of this product as unsorted municipal waste. Go to Fluke's website for recycling information.
	Warning. Laser
	Risk of Danger. Important information. See Manual.
	Conforms to European Union directives.

Note

Important paragraphs which must be adhered to in practice as they enabled the product to be used in a technically correct and efficient manner.

Electromagnetic Compatibility (EMC)

The term "electromagnetic compatibility" is taken to mean the capability of the product to function smoothly in an environment where electromagnetic radiation and

electrostatic discharges are present, and without causing electromagnetic interference to other equipment.

⚠ Warning

The 421D conforms to the most stringent requirements of the relevant standards and regulations. Yet, the possibility of it causing interference in other devices cannot be totally excluded.

⚠ Caution

Never attempt to repair the product yourself. In case of damage, contact Fluke (www.fluke.com).

FCC statement (U.S.A only)

This equipment has been tested and found to comply with the limits for a Class B digital device, pursuant to part 15 of the FCC Rules. These limits are designed to provide reasonable protection against harmful interference in a residential installation.

This equipment generates, uses and can radiate radio frequency energy and, if not installed and used in accordance with the instructions, may cause harmful interference to radio communications.

However, there is no guarantee that interference will not occur in a particular installation.

If this equipment does cause harmful interference to radio or television reception, which can be determined by turning the equipment off and on, the user is encouraged to try to correct the interference by one or more of the following measures:

- Reorient or relocate the receiving antenna.
- Increase the separation between the equipment and receiver.
- Connect the equipment into an outlet on a circuit different from that to which the receiver is connected.
- Consult the dealer or an experienced radio/TV technician for help.

⚠ Warning

Changes or modifications not expressly approved by Fluke for compliance could void the user's authority to operate the equipment.

Laser classification

Integrated distance meter

The 421D produces a visible laser beam which emerges from the front of the instrument.

It is a Class 2 laser product in accordance with:

- IEC60825-1 : 2007 "Radiation safety of laser products"

Laser Class 2 products:

Do not stare into the laser beam or direct it towards other people unnecessarily. Eye protection is normally afforded by aversion responses including the blink reflex.

⚠ Warning

Do not look directly into the beam with optical aids. Looking directly into the beam with optical aids (for example, binoculars, telescopes) can be hazardous.

⚠ Caution

Looking into the laser beam may be hazardous to the eyes.

Do not look into the laser beam. Make sure the laser is aimed above or below eye level. (particularly with fixed installations, in machines, etc.)

Start-up

Inserting/replacing batteries

See figure {A}

1. Remove battery compartment lid and attach handstrap.
2. Insert two AAA (LR3) batteries, observing correct polarity.
3. Close the battery compartment again. Replace the batteries when the symbol  flashes permanently in the display.

Note

Use alkaline batteries only.

Note

Remove the batteries before any long period of non-use to avoid the danger of corrosion.

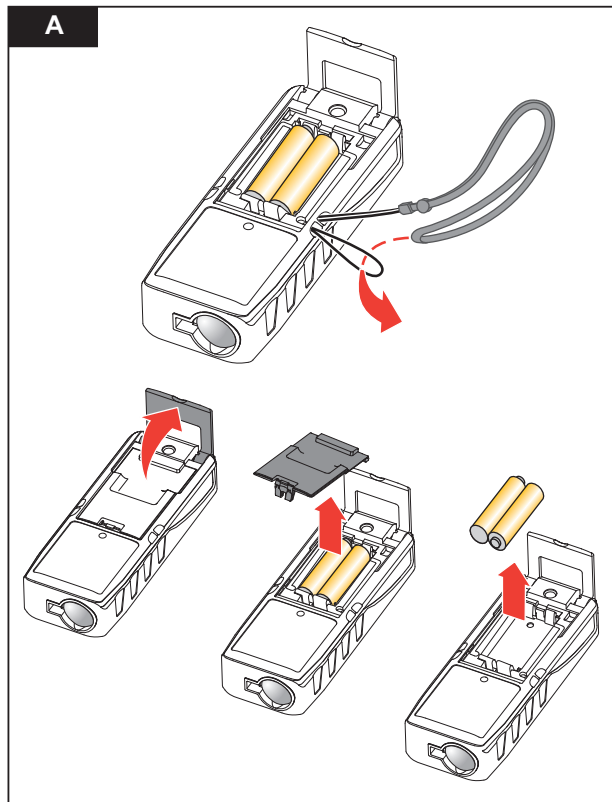

Changing the reference point (multifunctional endpiece)

See figure {B}.

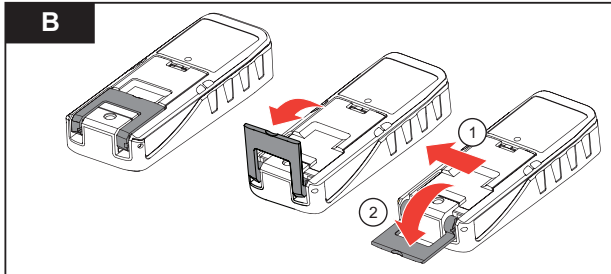

The instrument can be adapted for the following measuring situations:

- For measurements from an edge, fold out the positioning bracket until it first locks in place. See figure {C}.

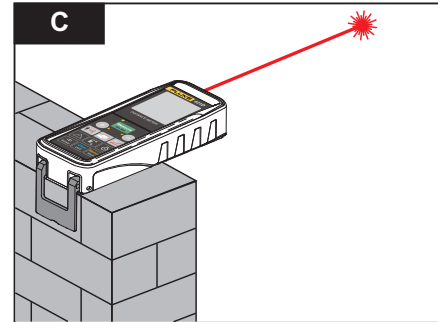

- For measurements from a corner, open the positioning bracket until it locks in place, then push the positioning bracket lightly to the right to fold it out fully. See figure {D}.

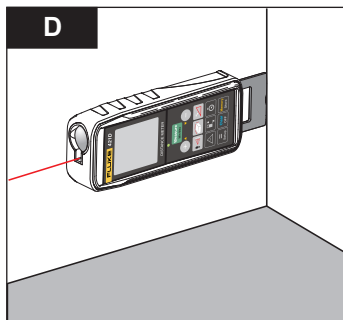

A built-in sensor automatically detects the orientation of the positioning bracket and adjusts the zero point of the instrument accordingly.

Keypad

See figure {E}:

1. Measure/Min Max/Power On
2. Plus (+)/Scroll up
3. Minus (-)/Scroll down
4. Area/volume
5. Tilt function/Stake out
6. Reference
7. Timer
8. Memory
9. Clear/off
10. Setup/mem/equal

11. Room corner/triangle angles
12. Indirect measurement (Pythagoras)

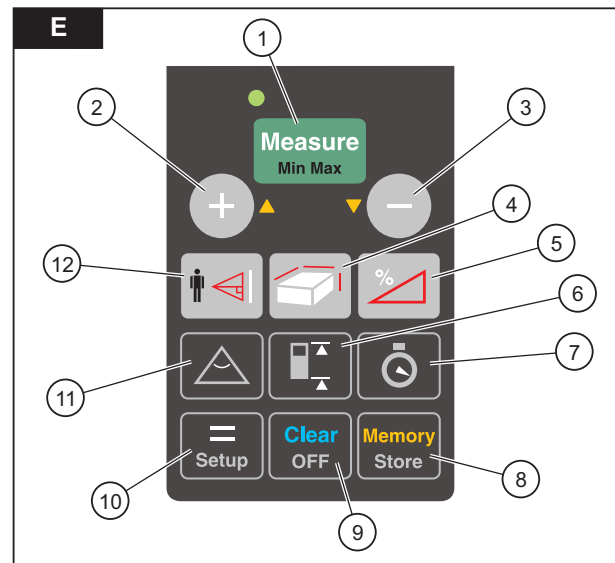

Display

See figure {F}

1. Laser active
2. Reference (front)
3. Reference (rear)
4. Reference (corner stop)
5. Measuring with the tripod
6. Stake out function
7. Single Pythagorean measurement
8. Double Pythagorean measurement
9. Double (partial height) measurement
10. Illumination
11. Save constant value, call up constant value
12. Historical memory, call up values
13. Battery status
14. Timer
15. Area/volume
16. Tilt
17. Horizontal distance measurement using tilt
18. Room corner angle function
19. Menu
20. Continuous laser
21. Reset
22. Reference (tripod)
23. Beep

24. Circumference
25. Wall area
26. Ceiling area
27. Intermediate line 1
28. Intermediate line 2
29. Intermediate line 3
30. Summary line
31. Message code indicator

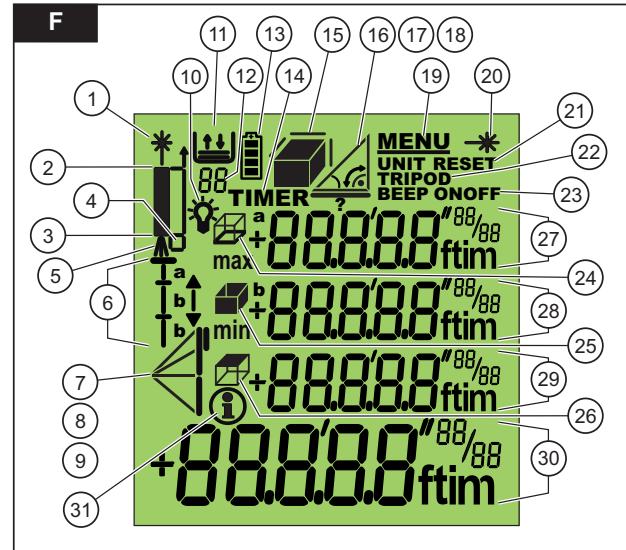

Menu functions

Settings

The menu allows settings to be altered and permanently stored. After switching off the device or replacing the batteries the settings are stored.

Navigation in the menu

The menu allows settings to be made at the user level. The instrument can be specifically configured to your personal requirements.

General description

Measure
Min Max button (**long** press) brings up the **MENU**, the set units and the symbol **UNIT** are displayed.

Measure
Min Max button (**short** press) pages through each menu item. See figure {G}.

⊕ or ⊖ button to make changes in menu items.

Measure
Min Max button (**short** press) brings up the next menu item.

A long press on the **Measure**
Min Max button in the menu confirms the new settings made in the submenu items.

Pressing the **Clear**
OFF button (**short** press) in the menu allows you to quit the settings function without saving.

G

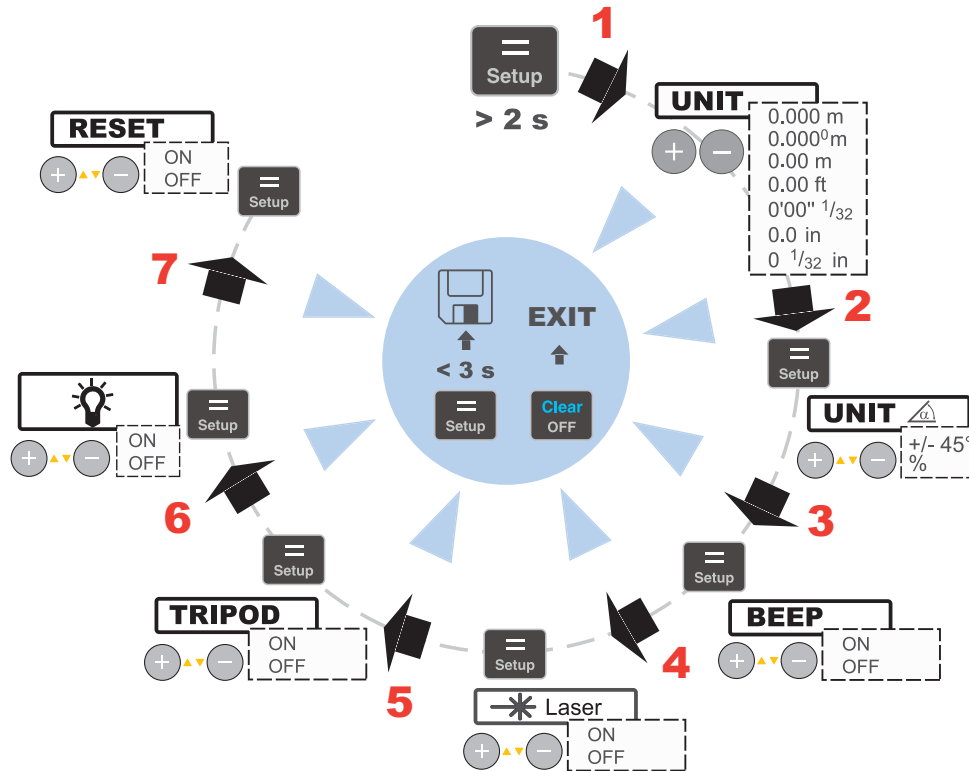

Setting the unit for distance measurements

The following units can be set:

Menu #	Distance	Area	Volume
1.1	0.000 m	0.000 m ²	0.000 m ³
1.2	0.000 ⁰ m	0.000 m ²	0.000 m ³
1.3	0.00 m	0.000 m ²	0.000 m ³
1.4	0.00 ft	0.00 ft ²	0.00 ft ³
1.5	0'00" 1/32	0.00 ft ²	0.00 ft ³
1.6	0.0 in	0.00 ft ²	0.00 ft ³
1.7	0 1/32 in	0.00 ft ²	0.00 ft ³

Setting the unit for tilt measurements

The following units can be set for tilt measurements:

Menu #	Units for tilt
2.1	+/- 0.0°
2.2	0.00%

Beep (BEEP)

You can switch the beep on or off.

Menu #	Beep function
3.1	On
3.2	Off

Continuous laser (—*)

You can switch the continuous laser function on or off.

Menu #	Continuous laser function
4.1	On
4.2	Off

With the continuous laser function set on, each press of the button  triggers a measurement. The laser automatically switches off after 15 minutes.

Measuring with the tripod (TRIPOD)

The reference must be appropriately adjusted in order to be able to take correct measurements with a tripod. To do this select the **TRIPOD** symbol in this menu item. You can switch the reference on the tripod on or off. The setting can be seen on the display .

Menu #	Measuring with tripod function
5.1	On
5.2	Off

Display - keypad illumination (☼)

Automatic illumination of the display and the keypad can be switched on or off.

Menu #	Illumination function
6.1	On
6.2	Off

Reset - returning the instrument to the factory settings (RESET)

The instrument has a **RESET** function. When you select the menu function **RESET** and confirm, the instrument defaults to the factory settings.

Menu #	Reset function
7.1	On
7.2	Off

A reset returns the following values to their factory settings:

- Reference (rear)
- Display illumination (ON)
- Beep (ON)
- Unit (m(mm))
- Stack and memory are erased

Note

All customized settings and stored values are also lost.

Operation

Switching on and off

 Switches on the instrument and laser. The display shows the battery symbol until the next button is pressed.

 Pressing this button for longer switches the instrument off.

The instrument switches off automatically after six minutes of inactivity.

CLEAR button



 The last action is cancelled. While making area or volume measurements, each single measurement can be deleted and remeasured in series.

Display / keypad illumination

The instrument has a sensor that automatically switches the display and keypad illumination on or off in response to lighting conditions.

Reference setting

The default reference setting is from the rear of the instrument. A special beep sounds whenever the reference setting is changed.

 Press this button (**short press**) to take the next measurement from the front edge .

After a measurement the reference returns automatically to the default setting (rear reference). See figure {H}.

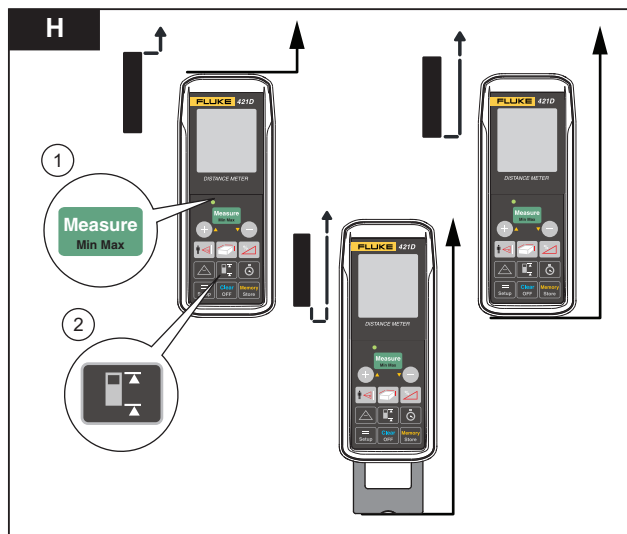

 Press this button (**long press**) to set the reference to the front. Does not return to default (rear) reference.

 Press this button, the rear reference is set again.

Measuring

Single distance measurement

 Press to activate the laser. Press again to trigger the distance measurement.

The result is displayed immediately.

Minimum/maximum measurement

This function allows the user to measure the minimum or maximum distance from a fixed measuring point. It can also be used as to determine spacings. See figure {I}.

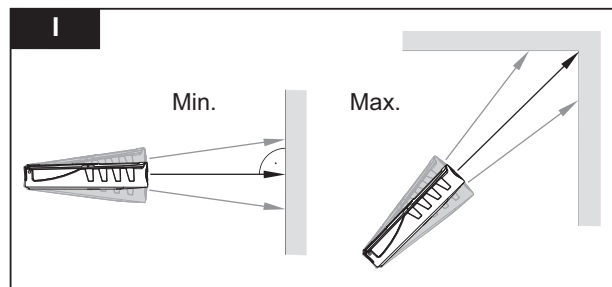

It is commonly used to measure room diagonals (maximum values) or horizontal distances (minimum values).

 Press and hold down this button until you hear a beep. Then slowly sweep the laser back and forth and up and down over the desired target point - (for example, into the corner of a room).

 Press to stop continuous measurement. The values for maximum and minimum distances are shown in the display as well as the last measured value in the summary line.

Functions

Addition / subtraction

Distance measuring



 The next measurement is added to the previous one.

 The next measurement is subtracted from the previous one.

This process can be repeated as required.  Press this key to display result. The result is always shown in the summary line with the previous value in the second line.

 The last step is cancelled.

Area

 Press **once**. The  symbol appears in the display.



 Press this button to take the first length measurement (for example, length).

 Press it again to take the second length measurement (for example, width).

The result is displayed in the summary line.

Press the  button (**long press**) to calculate the circumference.

Volume

 Press this button **twice**. The  symbol appears in the display.

 Press this button to take the first length measurement (for example, length).

 Press this button to take the second length measurement (for example, width).

 Press this button to take the third length measurement (for example, height). The value is shown in the second line.

The volume then appears in the summary line.

Press the  button (**long press**) to display additional room information such as ceiling/floor area, surface area of the walls, circumference.

 Ceiling/floor area

 Wall area

 Circumference

Tilt measurement

Note

The inclination sensor measures tilts between $\pm 45^\circ$.

Note

During tilt measurement the instrument should be held without a transverse tilt ($\pm 10^\circ$).

 Press this button **once** to activate the tilt sensor. The \sphericalangle symbol appears in the display. The tilt is continuously shown as $^\circ$ or % depending on the setting.

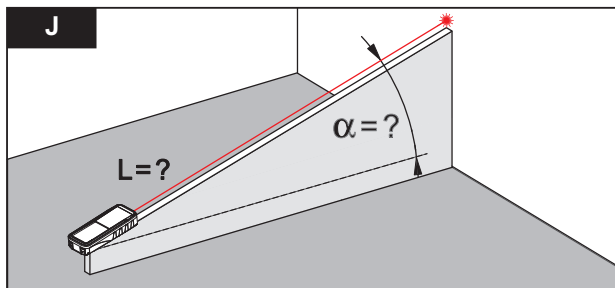

 Press to measure the inclination and the distance. See figure {J}.



Tilt sensor calibration

The user can calibrate the device's tilt sensor. The angle sensor is switched on by pressing the  once. Then two measurements are taken on a flat surface. The first measurement is taken and a note is made of the measured angle **a**. The device is then turned through exactly 180° , the second measurement is taken and a note is made of the measured angle **b**. The value **x** to which the device must be corrected is calculated as follows:

$$x = -(a+b)/2$$

The calibration mode is then entered by pressing keys  and the  both at the same time for 2 seconds. The correction value **x** can be entered here using the \oplus and \ominus keys. The entered value is stored and implemented by pressing the  key.

Indirect horizontal distance

This function allows the user to determine a horizontal distance even when the line-of-sight is blocked by an object or obstacle. See figure {K}.

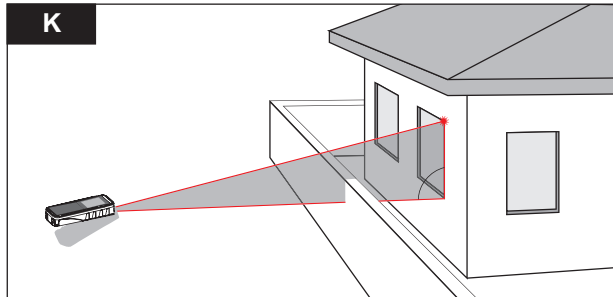

 Press this button **twice** and the following symbol  appears in the display \triangle .

 Press this button to measure tilt and diagonal distance. The summary line displays the result as the direct horizontal distance.



Stake out function

Two different distances (a and b) can be entered into the instrument and can then be used to mark off defined measured lengths, for example, in the construction of wooden frames.

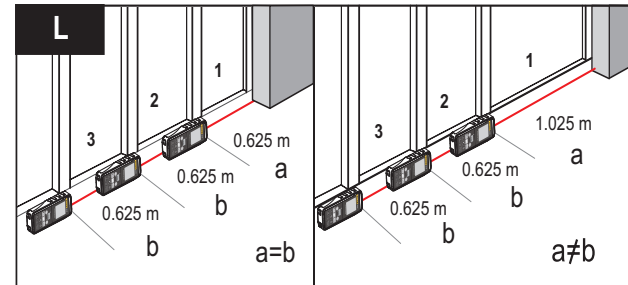
See figure {L}.



Entering stake out distances:

 Press this button **three times** and the stake out function symbol appears in the display .

The value (a) and the corresponding intermediate line flash.

By using \oplus and \ominus , you can adjust the values (first a and then b) to suit the desired stake out distances. Holding the buttons down increases the rate of change of the values.

Once the desired value (a) has been reached it can be confirmed with the  button.

The value (b) and the intermediate line flashes (the defined value (a) is automatically adopted). Value (b) can be entered using \oplus and \ominus .

The defined value (b) is confirmed with the  button and starts the stake out laser measurement.

The display shows required stake out distance in the summary line between the stake out point (first a and then b) and the instrument (rear reference).

If the 421D is then moved slowly along the stake out line the displayed distance decreases. The instrument starts to beep at a distance of 0.1 m from the next stake out point.



The arrows in the display  indicate in which direction the 421D needs to be moved in order to achieve the defined distance (either a or b). As soon as the stake out point is reached the beep changes and the arrows in the display disappear.

The function can be stopped at any time by pressing the  button.

Room corner angle function

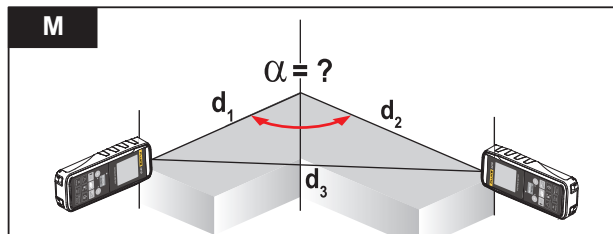
The angles in a triangle can be calculated by measuring the three sides. This function can be used e. g. to check a right-angled room corner. See figure {M}.



 Press this button and the room corner symbol appears in the display .

Mark the reference points to the right and left (d_1/d_2) of the angle to be measured.

 Press this button to measure the first (short) side of the triangle (d_1 or d_2).

 Press this button to measure the second (short) side of the triangle (d_1 or d_2).

 Press this button to measure the third (long) side of the triangle (d_3).

The result is displayed in the summary line as the room corner angle.

Indirect measurement

The instrument can calculate distances using Pythagoras' theorem.

Note

Make sure you adhere to the prescribed sequence of measurement:

- *All target points must be in a horizontal or vertical plane.*
- *The best results are achieved when the instrument is rotated about a fixed point (for example, with the positioning bracket fully folded out and the instrument placed on a wall).*
- *The minimum/maximum function can be used -see explanation in "Measuring -> Minimum/maximum measurement". The minimum value must be used for measurements at right angles to the target; the maximum distance for all other measurements.*

Note

Make sure that the first measurement and the distance to be measured are at right angles. Use the Minimum/maximum function, as explained in "Measuring -> Minimum/maximum measurement".

Indirect measurement - determining a distance using 2 auxilliary measurements

See figure {N}.

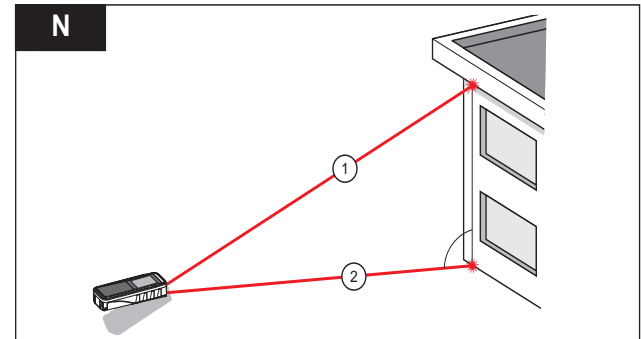

For example, for measuring building heights or widths. It is helpful to use a tripod when measuring heights that require the measurement of two or three measurements.

 Press this button **once**, the display shows .

The laser is switched on.

Measure Min Max Aim at the upper point (1) and trigger the measurement. After the first measurement the value is adopted. Keep the instrument as horizontal as possible.



Measure Min Max Press and hold down this button to trigger continuous measurement, sweep the laser back and forth and up and down over the ideal horizontal target point.

Measure
Min Max Press to stop continuous measurement (2). The result is displayed in the summary line, the partial results in the secondary line.

Indirect Measurement - determining a distance using 3 measurements

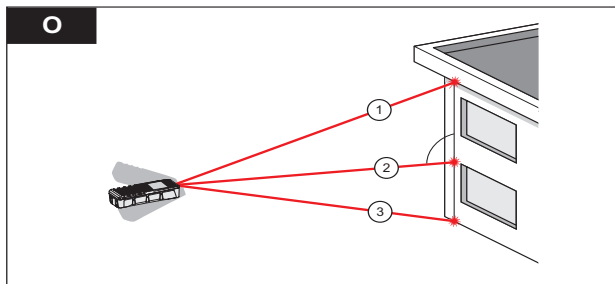
See figure {O}.



 Press this button **twice**; the display shows the following symbol . The laser is switched on.

Measure
Min Max Aim at the upper point (1) and trigger the measurement. After the first measurement the value is adopted. Keep the instrument as horizontal as possible.

Measure
Min Max Press and hold down this button to trigger continuous measurement, sweep the laser up and down over the ideal horizontal target point.

Measure
Min Max Press to stop continuous measurement (2). The value is adopted. Aim at the lower point and **Measure**
Min Max press

this button to trigger the measurement (3). The result is displayed in the summary line, the partial results in the secondary lines.

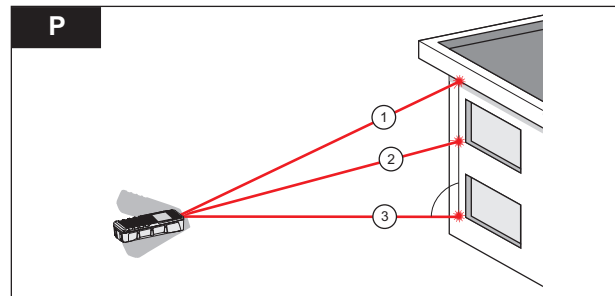

Indirect measurement - determining a chain value using 3 measurements

See figure {P}.



fig_p.eps

For example, determining the height between point 1 and point 2 using three target points.

 Press this button **three** times; the display shows the following symbol . The laser is switched on.

Aim at the upper point (1).

Measure
Min Max Press this button and trigger the measurement. After the first measurement the value is adopted. The display flashes (2).

Measure Min Max Triggers the measurement. After the second measurement the value is adopted. The display flashes (3). Keep the instrument as horizontal as possible.

Measure Min Max Press and hold down this button to trigger continuous measurement. Sweep the laser up and down over the ideal horizontal target point.

Measure Min Max Press this button to end continuous measurement. The result is displayed in the summary line, the partial results in the secondary lines.

Storage of constants/historical storage

Storage of a constant

You can store and recall a frequently used value for example, height of a room. Measure the desired distance, press and hold the **Memory Store** button until the device beeps to confirm storage.

Recalling the constant

Memory Store Press this button **once** to recall the constant and make it available for further calculations by pressing button **Setup**.

Historical storage

Memory Store Press this button **twice** and the previous 20 results (measurements or calculated results) are shown in reverse order.

The **+** and **-** buttons can be used for navigation.

Memory Store Press this button to use a result from the summary line for further calculations.

Pressing the **Memory Store** and **Clear OFF** buttons at the same time erases all the values in historical storage.

Timer (self-triggering)

5 Press this button to set a 5-second time delay.

or

5 Press and hold down this button until the desired time delay is reached (max. 60 seconds).

Press **Measure Min Max** to begin the timer. The remaining seconds until measurement (for example, 59, 58, 57...) are displayed in a countdown. The last 5 seconds are counted down with a beep. After the last beep the measurement is taken and the value is displayed.

Note

The timer can be used for all measurements.

Appendix

Message codes

All message codes are displayed with either ⓘ or "Error".

The following errors can be corrected:

ⓘ	Cause	Remedy
156	Transverse tilt greater than 10°	Hold the instrument without any transverse Tilt
160	Main tilt direction, angle too high (>45°)	Measure angle up to max. ±45°
204	Calculation error	Repeat procedure
252	Temperature too high	Cool down instrument
253	Temperature too low	Warm up instrument
255	Receiver signal too weak, measurement time too long, distance >100 m	Use target plate
256	Received signal too strong	Target too reflective (use target plate)

257	Wrong measurement, background brightness too high	Darken target (measure in different lighting conditions)
260	Laser beam interrupted	Repeat measurement

Error	Cause	Remedy
Error	Hardware error	Switch on/off the device several times. If the symbol still appears, then your instrument is defective. Please call your dealer for assistance.

Technical data

Distance measurements: Measuring accuracy up to 10 m (2 σ , standard deviation)	typically: ± 1.5 mm* ($\pm 1/16$ in*)
Power Range Technology™: Range (use target plate from about 80m)	0.05 m to 100 m
Smallest unit displayed	0.1 mm
Distance measurement	√
Minimum/maximum measurement, Continuous measurement	√
Area/volume calculation of room data	√
Addition / subtraction	√
Indirect measurement using Pythagoras	√
Tilt measurements: Tilt sensor: Accuracy (2 σ , standard deviation) - to laser beam - to the housing	$\pm 0.3^\circ$ $\pm 0.3^\circ$
Indirect measurement using tilt sensor (direct horizontal distance)	√
Angle measurement using tilt sensor ($\pm 45^\circ$)	√

General: Laser class	II
Laser type	635 nm, < 1 mW
Ø laser point (at distances)	6 / 30 / 60 mm (10 / 50 / 100 m)
Automatic laser switch-off	after 3 min
Automatic instrument switchoff	after 6 min
Display illumination	√
Keypad illumination	√
Multifunctional endpiece	√
Timer (self-triggering)	√
Save constant value	√
Historical storage (20 values)	√
Tripod thread	√
Battery life, Type AAA, 2 x 1.5 V NEDA 24A/IEC LR03	up to 5 000 measurements
Protection against splashes and dust	IP 54, dust-proof, splash-proof

Dimensions	125 x 45 x 25 mm
Weight (with batteries)	110 g
Temperature range: Storage	-25 °C to +70°C (13 °F to +158 °F)
Operation	-10 °C to +50 °C (14 °F to +122 °F)
Maximum altitude	3500 m (AMSL)
Maximum relative humidity	85% at 20 °F to 120 °F (-7 °C to 50 °C)
Pollution degree	2
Safety	CAN/CSA-C22.2 No. 61010-1-04, UL Std. No. 61010-1 (2nd Edition), ISA-82.02.01, IEC Standard No. 61010-1:2001, and EN60825-1:2007 (Class II)
EMC	61326-1:2006
*maximum deviation occurs under unfavorable conditions such as bright sunlight or when measuring to poorly reflecting or very rough surfaces. Measuring accuracy between 10 m and 30 m may deteriorate to approx. ± 0.025 mm/m, for distances above 30 m to ± 0.1 mm/m.	

Measuring conditions

Measuring range

The range is limited to 100 m.

At night or dusk and if the target is in shadow the measuring range without target plate is increased.

Use a target plate to increase the measurement range during daylight or if the target has poor reflection properties.

Target surfaces

Measuring errors can occur when measuring toward colorless liquids (for example, water) or dust free glass, Styrofoam or similar semi-permeable surfaces.

Aiming at high gloss surfaces may deflect the laser beam and lead to measurement errors.

Against non-reflective and dark surfaces the measuring time may increase.

Care and Cleaning

Do not immerse the instrument in water. Wipe off dirt with a damp, soft cloth. Do not use aggressive cleaning agents or solutions. Handle the instrument as you would a telescope or camera.



Tequipment
.NET

USA

**205 Westwood Ave
Long Branch, NJ 07740
1-877-742-TEST (8378)
Fax: (732) 222-7088
salesteam@Tequipment.NET**