

FLUKE®



Fluke 434^{II}/435^{II}/437^{II}

Three Phase Energy and Power Quality Analyzer

Users Manual

Table of Contents

Chapter	Title	Page
	General Aspects	1-1
	Introduction.....	1-1
	Limited Warranty & Limitation of Liability.....	1-2
	Shipment Note	1-3
	Contacting a Service Center.....	1-4
	Safety Information: Read First.....	1-4
	Safe Use of Li-ion Battery Pack	1-7
	About This Manual	2-1
	Introduction.....	2-1
	Users Manual Contents	2-1
	Features of Fluke 434-II/435-II/437-II	3-1
	Introduction.....	3-1
	General Measurements	3-1
	Measuring modes to investigate details	3-2
	Logging of Measuring Values in Meter Screens	3-2
	Basic Operations and Menu Navigation	4-1
	Introduction.....	4-1
	Tilt Stand and Hang Strap.....	4-1
	Powering the Analyzer.....	4-2
	Installation and Replacement of a Battery Pack	4-4
	SD Memory Card.....	4-5
	Display Brightness.....	4-6
	Locking the keyboard	4-6
	Menu Navigation	4-6
	Display Contrast	4-7
	Reset to Factory Defaults.....	4-7
	Display Information.....	5-1
	Introduction.....	5-1

Phase Colors	5-2
Screen Types.....	5-2
Screen information common for all screen types.....	5-3
Input Connections.....	6-1
Introduction.....	6-1
Input Connections	6-1
Scope Waveform and Phasor	7-1
Introduction.....	7-1
Scope Waveform.....	7-1
Scope Phasor.....	7-2
Tips and Hints.....	7-3
Volts/Amps/Hertz	8-1
Introduction.....	8-1
Meter screen.....	8-1
Trend	8-2
Events	8-3
Tips and Hints.....	8-4
Dips & Swells.....	9-1
Introduction.....	9-1
Trend	9-3
Events Tables.....	9-4
Tips and Hints.....	9-5
Harmonics.....	10-1
Introduction.....	10-1
Bar Graph Screen.....	10-1
Meter screen.....	10-3
Trend	10-3
Tips and Hints.....	10-4
Power & Energy.....	11-1
Introduction.....	11-1
Meter screen.....	11-1
Trend	11-3
Tips and Hints.....	11-5
Energy Loss Calculator	12-1
Introduction.....	12-1
Energy Loss Calculator Display	12-1
Meter	12-2
Tips and Hints.....	12-4
Power Inverter Efficiency	13-1
Introduction.....	13-1
Meter screen.....	13-1
Trend	13-2
Tips and Hints.....	13-3

Unbalance	14-1
Introduction.....	14-1
Phasor screen	14-1
Meter Screen.....	14-2
Trend	14-3
Tips and Hints.....	14-3
Inrush	15-1
Introduction.....	15-1
Inrush Trend Display	15-1
Tips and Hints.....	15-4
Monitor - Power Quality Monitoring	16-1
Introduction.....	16-1
Power Quality Main Screen	16-4
Trend Display	16-6
Events Table	16-6
Bar Graph Screen.....	16-8
Tips and Hints.....	16-9
Flicker	17-1
Introduction.....	17-1
Meter screen.....	17-1
Trend	17-2
Tips and Hints.....	17-3
Transients	18-1
Introduction.....	18-1
Waveform Display	18-1
Tips and Hints.....	18-4
Power Wave	19-1
Introduction.....	19-1
Waveform Display	19-1
Meter screen.....	19-2
Waveform screen	19-3
Tips and Hints.....	19-4
Mains Signaling.....	20-1
Introduction.....	20-1
Trend	20-1
Events Table	20-3
Tips and Hints.....	20-4
Logger	21-1
Introduction.....	21-1
Start Menu.....	21-1
Meter screen.....	21-2
Trend	21-3
Events	21-3

Cursor and Zoom	22-1
Introduction.....	22-1
Cursor on Waveform Displays.....	22-1
Cursor on Trend Displays	22-2
From Events Table to Trend Display with Cursor On.....	22-3
Cursor on Bar graph Displays.....	22-4
Setting up the Analyzer	23-1
Introduction.....	23-1
USER PReFerences.....	23-3
MANUAL SETUP.....	23-6
Manual Setup - How to change the wiring configuration	23-9
Manual Setup - How to change scale of Scope Display	23-11
Limits Adjustments.....	23-13
Using Memory and PC	24-1
Introduction.....	24-1
Using memory.....	24-1
Use of PC	24-4
Tips and Maintenance.....	25-1
Introduction.....	25-1
Cleaning the Analyzer and its Accessories	25-1
Storing the Analyzer	25-1
Keeping the Battery in Good Condition	25-1
Installation of Options	25-1
Parts and Accessories.....	25-2
Troubleshooting.....	25-3
Specifications.....	26-1
Introduction.....	26-1
Electrical Measurements.....	26-2

Chapter 1

General Aspects

Introduction

This chapter informs you about a number of general and important aspects concerning the Fluke 434-II/435-II/437-II Three Phase Energy and Power Quality Analyzer (hereafter referred to as 'Analyzer').

This concerns:

- Warranty and Liability Conditions.
- Shipment Note: Survey of items that should be included in your Analyzer Kit.
- Contacting a Fluke Service Center.
- Safety Information: **Read First!**
- Safe Use of Li-ion Battery Pack.

Limited Warranty & Limitation of Liability

Each Fluke product is warranted to be free from defects in material and workmanship under normal use and service. The warranty period is three years for the Analyzer and one year for its accessories. The warranty period begins on the date of shipment. Parts, product repairs and services are warranted for 90 days. This warranty extends only to the original buyer or end-user customer of a Fluke authorized reseller, and does not apply to fuses, disposable batteries or to any product which, in Fluke's opinion, has been misused, altered, neglected or damaged by accident or abnormal conditions of operation or handling. Fluke warrants that software will operate substantially in accordance with its functional specifications for 90 days and that it has been properly recorded on non-defective media. Fluke does not warrant that software will be error free or operate without interruption.

Fluke authorized resellers shall extend this warranty on new and unused products to end-user customers only but have no authority to extend a greater or different warranty on behalf of Fluke. Warranty support is available if product is purchased through a Fluke authorized sales outlet or Buyer has paid the applicable international price. Fluke reserves the right to invoice Buyer for importation costs of repair/replacement parts when product purchased in one country is submitted for repair in another country.

Fluke's warranty obligation is limited, at Fluke's option, to refund of the purchase price, free of charge repair, or replacement of a defective product which is returned to a Fluke authorized service center within the warranty period.

To obtain warranty service, contact your nearest Fluke authorized service center or send the product, with a description of the difficulty, postage and insurance prepaid (FOB Destination), to the nearest Fluke authorized service center. Fluke assumes no risk for damage in transit. Following warranty repair, the product will be returned to Buyer, transportation prepaid (FOB Destination). If Fluke determines that the failure was caused by misuse, alteration, accident or abnormal condition of operation or handling, Fluke will provide an estimate of repair costs and obtain authorization before commencing the work. Following repair, the product will be returned to the Buyer transportation prepaid and the Buyer will be billed for the repair and return transportation charges (FOB Shipping Point).

THIS WARRANTY IS BUYER'S SOLE AND EXCLUSIVE REMEDY AND IS IN LIEU OF ALL OTHER WARRANTIES, EXPRESS OR IMPLIED, INCLUDING BUT NOT LIMITED TO ANY IMPLIED WARRANTY OF MERCHANTABILITY OR FITNESS FOR A PARTICULAR PURPOSE. FLUKE SHALL NOT BE LIABLE FOR ANY SPECIAL, INDIRECT, INCIDENTAL OR CONSEQUENTIAL DAMAGES OR LOSSES, INCLUDING LOSS OF DATA, WHETHER ARISING FROM BREACH OF WARRANTY OR BASED ON CONTRACT, TORT, RELIANCE OR ANY OTHER THEORY.

Since some countries or states do not allow limitation of the term of an implied warranty, or exclusion or limitation of incidental or consequential damages, the limitations and exclusions of this warranty may not apply to every buyer. If any provision of this Warranty is held invalid or unenforceable by a court of competent jurisdiction, such holding will not affect the validity or enforceability of any other provision.

Fluke Corporation, P.O. Box 9090, Everett, WA 98206-9090 USA, or
Fluke Industrial B.V., P.O. Box 90, 7600 AB, Almelo, The Netherlands

Shipment Note

The following items are included in your Analyzer Kit:

Note:

This Shipment Note reflects the contents of the standard product. The contents of a special version may be different. The difference is indicated in a Manual Supplement that is part of the shipment.

Note:

When new, the Analyzer's rechargeable Li-ion battery is not charged. Refer to Chapter 4 – Powering the Analyzer.

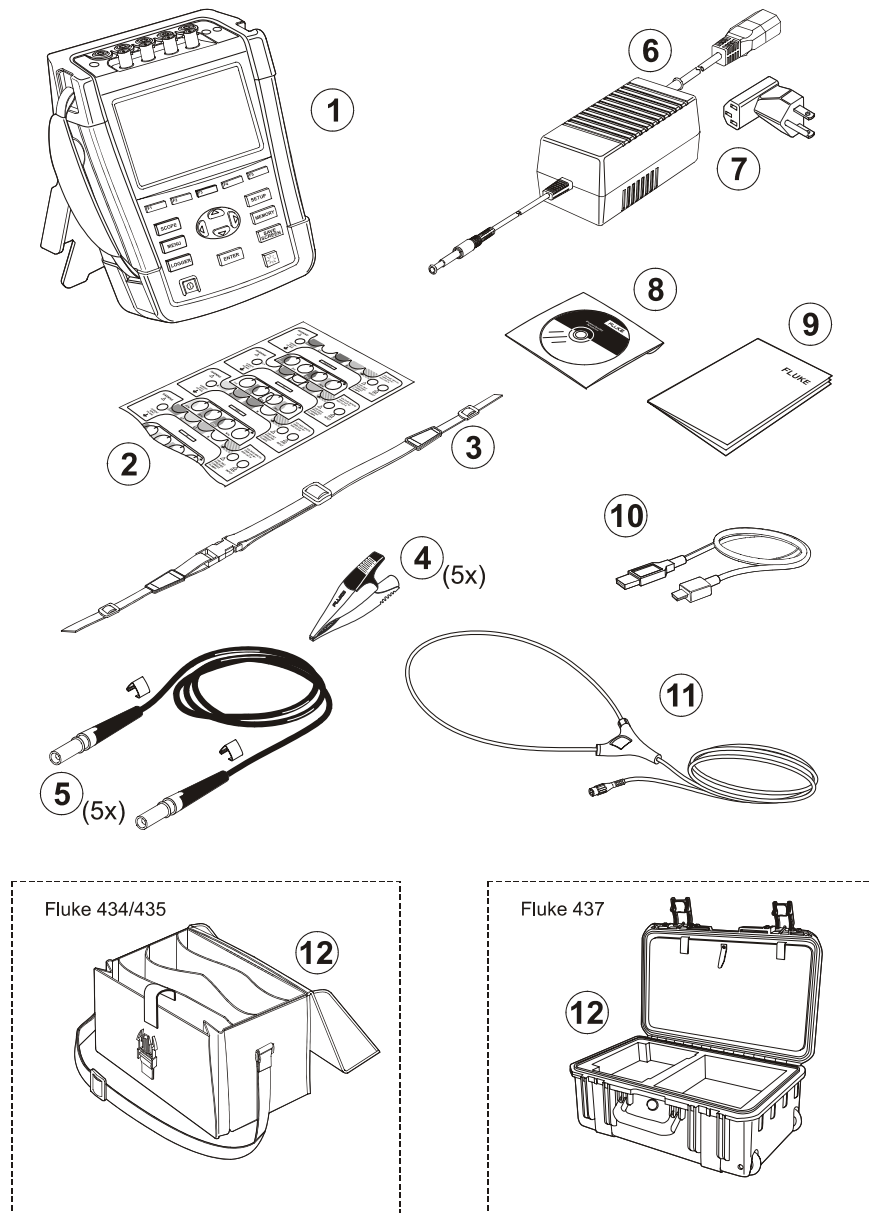

Figure 1-1. Contents of Analyzer Kit

#	Description	
1	Power Quality Analyzer Fluke 43x Series II + Side Strap, Battery Pack BP290 (28 Wh) and 8 GB SD Memory Card Installed	
2	Decal Set for Input Sockets (New EU & UK, EU, China, UK, US, Canada)	
3	Hang Strap	
4	Alligator Clips. Set of 5	
5	Test Leads, 2.5 m + Color Coding Clips. Set of 5	
6	Power Adapter	
7	Line Plug Adapter Set (EU, US, UK, Australia/China, Switzerland, Brazil, Italy) or Regional Power Cord.	
8	Safety Instructions Booklet (Multi-Language)	
9	CD-ROM with Manuals (Multi-Language), PowerLog Software, and USB drivers	
10	USB Interface Cable for PC Connection (USB-A to mini-USB-B)	
11	Flexible 6000 A AC Current Probe (not in Basic Version)	
	Fluke 434-II/435-II:	Fluke 437-II:
12	Soft Carrying Case C1740	Hard Case with Rollers C437-II

Contacting a Service Center

To locate a Fluke authorized service center, visit us on the World Wide Web at: www.fluke.com or call Fluke using any of the phone numbers listed below:

+1-888-993-5853 in the U.S. and Canada

+31-40-2675200 in Europe

+1-425-446-5500 from other countries

Safety Information: Read First

The Fluke 434-II/435-II/437-II Three Phase Energy and Power Quality Analyzer complies with:

IEC/EN61010-1-2001,

CAN/CSA C22.2 No 61010-1-04 (including _cCSA_{us} approval),

UL std No 61010-1,















Safety Requirements for Electrical Equipment for Measurement, Control and Laboratory Use, Part 1: General requirements, Rated: 600V CAT IV 1000V CAT III Pollution Degree 2.

Use the Analyzer and its accessories only as specified in the *Users Manual*. Otherwise, the protection provided by the Analyzer and its accessories might be impaired.

A **Warning** identifies conditions and actions that pose hazard(s) to the user.

A **Caution** identifies conditions and actions that may damage the Analyzer.

The following international symbols are used on the Analyzer and in this manual:

	See explanation in manual		Direct Current		Safety Approval
	Earth		Double Insulation (Protection Class)		Conformité Européenne
	Alternating Current	 Li-Ion	Recycling information		Disposal information
	Safety Approval		Conforms to relevant Australian standards		RoHS China
	Current Clamp		Do not apply around or remove from hazardous live conductors.		Do not dispose of this product as unsorted municipal waste. Go to Fluke's website for recycling information

 **Warning**

To avoid electrical shock or fire:

- **Review the entire manual before use of the Analyzer and its accessories.**
- **Carefully read all instructions.**
- **Do not work alone.**
- **Do not use the product around explosive gas, vapor, or in damp or wet environments.**
- **Use the product only as specified, or the protection supplied by the product can be compromised.**
- **Use only insulated current probes, test leads and adapters as supplied with the Analyzer, or indicated as suitable for the Fluke 434-II/435-II/437-II Analyzer.**
- **Keep fingers behind the finger guards on the probes.**
- **Before use, inspect the Analyzer, voltage probes, test leads and accessories for mechanical damage and replace when damaged. Look for cracks or missing plastic. Pay special attention to the insulation surrounding the connectors.**
- **Verify the Analyzer's operation by measuring a known voltage.**
- **Remove all probes, test leads and accessories that are not in use.**
- **Always connect the Power Adapter first to the AC outlet before connecting it to the Analyzer.**
- **Do not touch voltages >30 V ac rms, 42 V ac peak, or 60 V dc.**
- **Use the ground input only to ground the Analyzer and do not apply any voltage.**
- **Do not apply input voltages above the rating of the instrument.**

- Do not apply voltages in excess of the marked ratings of the voltage probes or current clamps.
- Use only correct measurement category (CAT), voltage, and amperage rated probes, test leads, and adapters for the measurement.
- Do not exceed the Measurement Category (CAT) rating of the lowest rated individual component of a product, probe, or accessory.
- Comply with local and national safety codes. Use personal protective equipment (approved rubber gloves, face protection, and flame resistant clothes) to prevent shock and arc blast injury where hazardous live conductors are exposed.
- The battery door must be closed and locked before you operate the product.
- Do not operate the product with covers removed or the case open. Hazardous voltage exposure is possible.
- Take special care during fitting and removal of the flexible current probe: de-energize the installation under test or wear suitable protective clothing.
- Do not use exposed metal BNC or banana plug connectors.
- Do not insert metal objects into connectors.
- Use only the power supply, Model BC430 (Power Adapter).
- Before use check that the selected/indicated voltage range on the BC430 matches the local line power voltage and frequency (refer to figure below). If necessary set the slider switch of the BC430 to the correct voltage.
- For the BC430 use only AC line plug adapters or AC line cords that comply with local safety regulations.
- Remove the input signals before you clean the product.
- Use only specified replacement parts.

Slider switch on Power Adapter to select line power voltage (Note: for Adapters without slider switch, refer to Instruction Sheet as supplied with device):

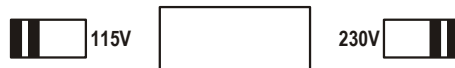

Max. Input Voltage at Voltage Banana Inputs to Ground:

Input A (L1), B (L2), C (L3), N to Ground: 1000 V CAT III, 600 V CAT IV.



Max. Voltage at Current BNC Inputs (See marking):

Input A (L1), B (L2), C (L3), N to Ground: 42 V peak.

Voltage ratings are given as “working voltage”. They should be read as V ac rms (50-60 Hz) for AC sinewave applications and as V dc for DC applications.

Measurement Category IV (CAT IV) refers to the overhead or underground utility service of an installation. CAT III refers to distribution level and fixed installation circuits inside a building.

If Safety Features are Impaired

If the Analyzer is used in a manner not specified by the manufacturer, the protection provided by the Analyzer may be impaired.

Before use, inspect the test leads for mechanical damage and replace damaged test leads!

If the Analyzer or its accessories appear to be impaired or not functioning properly, do not use it and send it in for repair.

Note

To accommodate connection to various line power sockets, the Power Adapter is equipped with a male plug that must be connected to a line plug adapter appropriate for local use. Since the PowerAdapter is isolated, you can use line plug adapters with or without a protective ground terminal. The 230 V rating of the Power Adapter is not for use in North America. A line plug adapter complying with the applicable National Requirements may be provided to alter the blade configurations for a specific country.

Safe Use of Li-ion Battery Pack

The Battery Pack Fluke model BP29x has been tested in accordance with the UN Manual of Tests and Criteria Part III Subsection 38.3 (ST/SG/AC.10/11/Rev.3) – more commonly known as the UN T1..T8 – tests, and have been found to comply with the stated criteria. The Battery Pack has been tested acc. to EN/IEC62133. As a result they can be shipped unrestricted internationally by any means.

Recommendations to safe storage of battery pack.

- **Do not store Battery Packs near heat or fire. Do not store in sunlight.**
- **Do not remove a Battery Pack from its original packaging until required for use.**
- **When possible, remove the Battery Pack from the equipment when not in use.**
- **Fully charge the Battery Pack before storing it for an extended period to avoid a defect.**
- **After extended periods of storage, it may be necessary to charge and discharge the Battery Packs several times to obtain maximum performance.**

- **Keep the Battery Pack out of the reach of children and animals.**
- **Seek medical advise if a battery or part of it has been swallowed.**

Recommendations to safe use of the Battery Pack.

- **The Battery Pack needs to be charged before use. Use only Fluke approved power adapters to charge the battery pack. Refer to Fluke's safety instructions and Users Manual for proper charging instructions.**
- **Do not leave a battery on prolonged charge when not in use.**
- **The Battery Pack gives the best performance when operated at normal room temperature $20\text{ }^{\circ}\text{C} \pm 5\text{ }^{\circ}\text{C}$ ($68\text{ }^{\circ}\text{F} \pm 9\text{ }^{\circ}\text{F}$).**
- **Do not put Battery Packs near heat or fire. Do not put in sunlight.**
- **Do not subject Battery Packs to severe impacts such as mechanical shock.**
- **Keep the Battery Pack clean and dry. Clean dirty connectors with a dry, clean cloth**
- **Do not use any charger other than that specifically provided for use with this equipment.**
- **Do not use any battery which is not designed or recommended by Fluke for use with the product.**
- **Take careful notice of correct placement of the battery in the product or the External Battery Charger.**
- **Do not short-circuit a Battery Pack. Do not keep Battery Packs in a place where the terminals can be shorted by metal objects (e.g. coins, paperclips, pens or other).**
- **Never use a Battery Pack or charger showing visible damage.**
- **Batteries contain hazardous chemicals that can cause burns or explode. If exposure to chemicals occurs, clean with water en get medical aid. Repair the product before use if the battery leaks.**
- **Alteration of Battery Pack: there shall be no attempt to open, modify, reform or repair a Battery Pack, which appears to be malfunctioning, or which has been physically damaged.**
- **Do not disassemble or crush Battery Packs**
- **Use the battery only in the application for which it is intended.**
- **Retain the original product information for future reference.**

Recommendations to safe transport of Battery Packs

- **The Battery Pack must adequately be protected against short-circuit or damage during transport.**

- **Always consult the IATA guidelines describing safe air transport of Li-ion batteries.**
- **Check-in luggage: Battery Packs are only allowed when installed in the product.**
- **Hand carried luggage: a number of Battery Packs as required for normal and individual use is allowed.**
- **Always consult national/local guidelines that are applicable for shipment by mail or other transporters.**
- **A maximum of 3 Battery Packs may be shipped by mail. The package must be marked as follows: PACKAGE CONTAINS LITHIUM-ION BATTERIES (NO LITHIUM METAL).**

Recommendations to safe disposal of a Battery Pack.

- **A failed Battery Pack shall be properly disposed of in accordance with local regulations.**
- **Dispose of properly: do not dispose of the battery as unsorted municipal waste. Go to Fluke's website for recycling information.**
- **Dispose in discharged condition and cover the battery terminals with isolation tape.**

Chapter 2

About This Manual

Introduction

This Users Manual gives full and comprehensive information on how to use the Fluke Fluke 434-II/435-II/437-II Three Phase Energy and Power Quality Analyzers effectively and in a safe manner. Read it carefully to learn about safe use of the Analyzer and its accessories and to take full advantage of all measuring modes.

Information in this manual may be subject to minor changes without notice.

On the last pages of this manual there is an index that lists the most important subjects in the manual with the manual pages where they can be found. Additionally you can use the Edit, Find function of Acrobat Reader to find certain subjects. Use for instance the word 'Transients' to find all information on Transients.

Users Manual Contents

- Introduction: Title, Table of Contents.
- Chapter 1. General Aspects: Warranty and Liability, Shipment Note, Contacting a Service Center, **Safety information (Read First!)**, Safe Use of Li-ion Battery Pack.
- Chapter 2. Overview of manual contents (this chapter).
- Chapter 3. Summary of measuring modes and how to use them in a logical order.
- Chapter 4. Basic operations: Tilt Stand and Hang Strap, Powering, Installation and Replacement of a Battery Pack, SD Memory Card, Display adjustment, Keyboard Locking, Reset, Menu Navigation.
- Chapter 5. Display information: Screen types, General Screen Information, Screen Symbols.
- Chapter 6. Input Connections: Use of voltage and current probes.
- Chapter 7 ... 21. Explanation of measuring functions with tips & hints:
 - Scope Waveform & Phasor (7),
 - Volts/Amps/Hertz (8),
 - Dips & Swells (9),
 - Harmonics (10),
 - Power & Energy (11),
 - Energy Loss Calculator (12),
 - Power Inverter Efficiency (13),

- Unbalance (14),
- Inrush Currents (15),
- Power Quality Monitoring (16).
- Flicker (17),
- Transients (18),
- Power Wave (19),
- Mains Signaling (20),
- Logger (21).
- Chapter 22. Cursor and Zoom: how to investigate measurement details.
- Chapter 23. Setting up the Analyzer: a comprehensive explanation of adjustments to customize measurements.
- Chapter 24. Using Memory and PC: how to save, recall and delete screenshots and data formats. How to make hard copies of measurement results and setup of communication with PC.
- Chapter 25. Tips and Maintenance: Cleaning, Storage, Batteries, Installation of options, Replaceable parts, Troubleshooting.
- Chapter 26. Specifications: Electrical, Mechanical, and Safety characteristics.
- Appendices: Measurement principles of Power Measurement and Energy Loss Calculation, Installing USB Drivers, Instrument Security Procedures (English only). Remark: for a Material Safety Data Sheet (MSDS) or Compliance Information on the supplied Li-ion Battery Pack refer to Fluke's website.
- Index.

Chapter 3

Features of Fluke 434-II/435-II/437-II

Introduction

The Analyzer offers an extensive and powerful set of measurements to check power distribution systems. Some give a general impression of power system performance. Others are used to investigate specific details. This chapter gives an overview on how to perform measurements in a logical order.

The measuring modes are described in detail in Chapter 7 to 21. Each measuring mode is explained in a separate chapter.

Refer to Chapter 26 Specifications for an overview of the parameters that are measured in each measuring mode and their accuracies.

Note

After you have switched on a certain measurement, a settling time of about 10 seconds will pass before the measurement is started. During this time the U (Unstable) symbol shows in the screen header. Moreover the timer counts down from –10 seconds. A measurement has no unstable period when used with a timed start.

Fluke 435-II and 437-II have additional features such as Flicker, Transients, Power Wave, Mains Signaling, Wave Event, Rms Event, and 0.1 % voltage input accuracy. Moreover Fluke 437-II has the possibility to measure in 400 Hz power systems and has a heavy duty Hard Case with rollers.

In Fluke 434-II the functions Flicker, Transients, Power Wave and Mains Signaling can be installed optionally. If not installed, they show up in the menu in grey color.

General Measurements

To check if voltage leads and current clamps are connected correctly, use Scope Waveform and Scope Phasor. The clamps are marked with an arrow to facilitate proper signal polarity. Chapter 6 Input Connections explains how to make connections.

To get a general impression of the quality of a power system use MONITOR. The MONITOR function displays a screen with Bar Graphs that show quality aspects of the phase voltages. A Bar Graph changes from green to red if the related aspect does not meet the active set of limits. An example of a set of limits is the set according to the

EN50160 norm. This set is present as a fixed set in the Analyzer's memory. Also user definable sets can be stored in memory.

Numerical data is shown by Volts/Amps/Hertz. For this press the MENU key. Then select Volts/Amps/Hertz and press F5 – OK to display a Meter screen with the present values of voltages (rms and peak), currents (rms and peak), frequency and Crest Factors per phase. Press F5 – TREND so display the course over time of these values.

Measuring modes to investigate details

Phase voltages. Should be close to the nominal value. Voltage waveforms must be a sine wave that is smooth and free from distortion. Use Scope Waveform to check the waveform shape. Use Dips & Swells to record sudden voltage changes. Use Transients mode to capture voltage anomalies.

Phase currents. Use Volts/Amps/Hertz and Dips & Swells to check current/voltage relations. Use Inrush Current to record sudden current increases like motor inrush.

Crest Factor. A CF of 1.8 or higher means high waveform distortion. Use Scope Waveform to see waveform distortion. Use Harmonics mode to identify harmonics and THD (Total Harmonic Distortion).

Harmonics. Use Harmonics mode to check for voltage and current harmonics and THD per phase. Use Trend to record harmonics over time.

Flicker. Use Flicker to check short and long term voltage flicker and related data per phase. Use Trend to record these values over time.

Dips & Swells. Use Dips & Swells to record sudden voltage changes as short as half a cycle.

Frequency. Should be close to nominal value. Frequency is normally very stable. Select Volts/Amps/Hertz to display frequency. The course of frequency over time is recorded in the Trend screen.

Unbalance. Each phase voltage should not differ more than 1 % from the average of the three. Current unbalance should not exceed 10 %. Use Scope Phasor or Unbalance mode to investigate unbalances.

Energy Loss Calculator. Helps to determine where energy losses occur and to visualize their impact on your energy bill.

Power Inverter Efficiency. Measures the efficiency and amount of energy being delivered by inverters that convert single phase DC into single or three phase AC.

Mains Signaling. Can be used to analyze the level of remote control signals that often are present on power distribution systems.

Logger. Allows you to store multiple readings with high resolution in a long memory. The readings to logged are selectable.

Power Wave. The Analyzer functions as a high resolution 8 channel scope recorder.

Hint: in general the most efficient way to troubleshoot electrical systems, is to begin at the load and work towards the building's service entrance. Measurements are taken along the way to isolate faulty components or loads.

Logging of Measuring Values in Meter Screens

All measuring values in a Meter screen are logged. The average, minimum and maximum values are logged with an adjustable average time (default value: 1 s) during the time that the measurement is running. The average time is adjustable via the key sequence SETUP,

F4 – MANUAL SETUP, F3 – FUNCTION PREF. Use the arrow keys to select the desired Average time. Also the total duration of the measurement and the start delay are adjustable.

When the measurement is stopped by operation of function key F5 – HOLD the logged data is saved on SD-card as Measurement xx. The measurement data is available via the MEMORY key and function key F1 – RECALL DELETE. Next use the up/down arrow keys to select the desired measurement and open it with function key F5 - RECALL. The logged values are visible under F3 – TREND. Cursor and Zoom can be used to zoom in on signal details.

If you resume the measurement via key sequence F5 – RUN, F3 – TIMED you enter a menu that allows you to adjust average time, duration and start moment for that particular measurement.

Note: under the LOGGER key you can log a maximum of 150 readings. The set or reading to be logged is user definable. Refer to Chapter 21 for more information.

Chapter 4

Basic Operations and Menu Navigation

Introduction

This chapter deals with a number of general aspects of the Analyzer's operation:

- Tilt Stand and Hang Strap
- Powering the Analyzer
- Installation and Replacement of a Battery Pack
- SD Memory Card
- Display Brightness
- Locking the keyboard
- Menu navigation
- Display Contrast
- Reset to Factory Defaults

Tilt Stand and Hang Strap

The Analyzer has a tilt stand that allows viewing the screen at an angle when placed on a flat surface. Figure 4-1 shows this. Also shown in this Figure is the location of the USB Interface connector. This interface also allows RS-232 communication with GPS430 option.



Figure 4-1. Tilt stand and location of USB interface connector

A hang strap is supplied with the Analyzer. The figure below shows how to attach the strap correctly to the Analyzer.

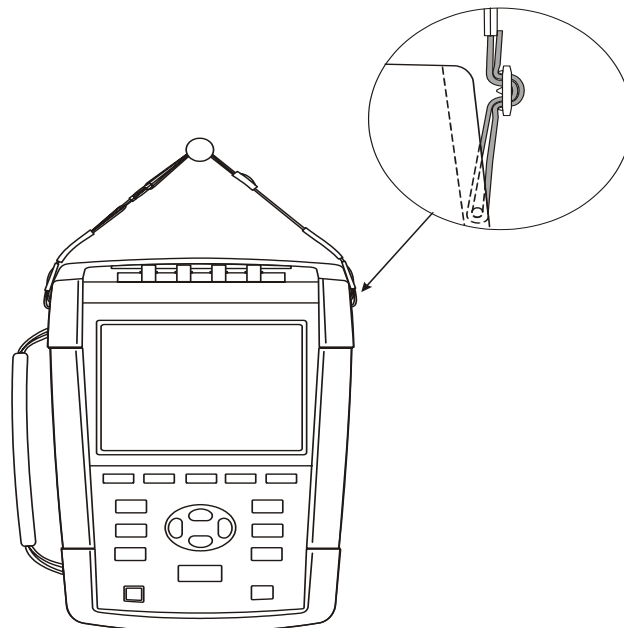

Figure 4-2. Fixing the hang strap

Powering the Analyzer

The Analyzer has a built-in rechargeable Li-ion battery that can power it for more than 7 hours when fully charged. When powered by battery, the battery condition symbol in the screen header indicates the charge condition. This symbol ranges from fully charged to empty: ■ ■ ■ ■ □ □. Detailed information on the battery condition can be found on the Analyzer's screen after the key operations: SETUP, F2 – VERSION & CAL, F2 – BATT. INFO. Additional to this, the battery itself is provided with a 5 segment fuel gauge. Each segment represents about 20 % of the battery's total capacity.

When empty, allow the battery to fully charge with the Power Adapter. A full charge takes at least 4 hours with the Analyzer turned off. When turned-on charging takes much longer.

No damage will occur if the charger is connected for long periods, e.g. over the weekend. The Analyzer automatically switches to trickle charging. At delivery the battery may be empty and it is recommended to charge it before use.

Concerning the use of the Power Adapter bear the following in mind:

- Use only the Power Adapter as supplied with the Analyzer.
- Before use check that the voltage and frequency as indicated on the Power Adapter and in the accompanying Instruction Sheet match with local line power. If required set the slider switch of the Power Adapter to the correct voltage.
- Connect the Power Adapter to the ac outlet.
- Connect the Power Adapter to the INPUT for the Power Adapter input on the right top side of the Analyzer.
- To avoid overheating of the battery during charging, do not exceed the allowable ambient temperature as given in the specifications.

Note

The Analyzer can not be powered up when the battery cover is not correctly closed.

Caution

To prevent decrease of battery capacity, charge it at least twice a year.

Power On/Off:



Press to power up or down with the last setup configuration. The welcome screen shows what Analyzer settings are currently in use. At power on a single beep can be heard.

To save battery power, the Analyzer display dims automatically when no keys are operated during a certain time. This time is adjustable.

When a key is operated, the display turns on again.

For the adjustment of Auto-off time see Chapter 20, USER PReferences.

Attention: the Analyzer switches off automatically when powered by battery only if no further knobs are operated after power-on (i.e. when the welcome screen is displayed).

Installation and Replacement of a Battery Pack

Warning

**Never Operate the Analyzer with the Battery Cover removed!
Hazardous voltage exposure may occur.**

To install or replace a Battery Pack, proceed as follows:

- Remove all probes and/or test leads.
- Fold the standup to the Analyzer.
- Unlock the battery cover at the rear of the Analyzer (turn the screws a quarter turn counter clockwise as shown in Figure 4-3).
- Lift the standup and battery cover and remove it (Figure 4-4).
- Lift one side of the battery and remove it (Figure 4-5)
- Install a battery and close the cover (turn the screws a quarter turn clockwise).

All measurement data that is stored on the SD Memory Card will stay available when the Analyzer is disconnected from its power sources.

As an option a double capacity battery and an external battery charger are available. Refer to chapter 22 paragraph Parts and Accessories for more information.

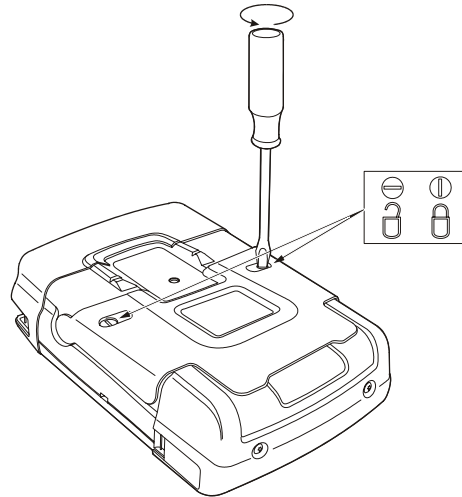

Figure 4-3. Unlocking the Battery Cover

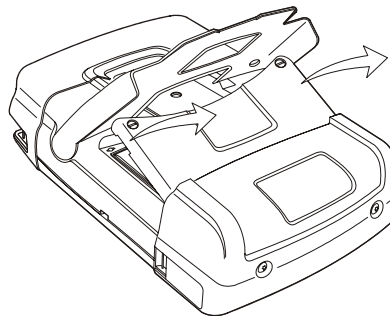

Figure 4-4. Removing the Battery Cover

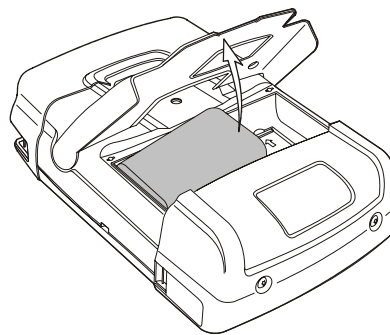

Figure 4-5. Removing the Battery

SD Memory Card

 **Warning**

**Never Operate the Analyzer with the Battery Cover removed!
Hazardous voltage exposure may occur.**

The Analyzer has a SD Memory Card for storage of measurement data. This data is retained also when the Analyzer is disconnected from its power sources. If the Memory card is not installed, only momentary measurement data is available.

The Memory Card is located in the Analyzer's battery compartment and can be reached in the same way as the battery. To lock or unlock the Card press it in the direction of the arrow shown in the compartment. Also the correct position of the Card is shown there.

Remark: the standard battery can stay in place during exchange of a Memory Card. A Double Capacity battery however must be removed to get access to the Memory Card.

Note

To avoid malfunctioning of the Memory Card, do not touch its contacts.

Initial Setup: when you power the Analyzer for the first time, after a Factory Default, or if it has been disconnected from all power sources, you will have to adjust a number of general settings that match your local situation.

This concerns: Information language, Nominal Frequency, Nominal Voltage, Phase Identification, Phase Colors, Date and Time. The setups are done step-by-step and explained in detail in Chapter 23.

Display Brightness



Press repeatedly to dim/brighten the backlight.
Keep pressed for more than 5 seconds for extra brightness for better visibility in strong sunlight (when powered by battery).
Low brightness saves battery power.

Locking the keyboard

The keyboard can be locked to prevent unwanted operation during unattended measurements:



Press for 5 seconds to lock or unlock the keyboard.

Menu Navigation

Most of the Analyzer functions are menu operated. Arrow keys are used to navigate through menus. The Function keys F1 ... F5 and the ENTER key are used to make selections. Active Function key selections are highlighted with a black background.

How to use the menus is illustrated in the example below on how to adjust the Analyzer for use with a certain printer type.





The SETUP menu pops up.



Submenu SETUP USER PREF appears.



Highlight RS-232: **RS-232**

ENTER	The PRINTER submenu appears. In this menu you can adjust PC communication baudrate.
	Adjust the required transmission speed: 
F5	Press to return to the next higher menu SETUP USER PREF. This menu is the starting point for many adjustments such as Display Contrast Adjustment and Reset to Factory Defaults.

Display Contrast

Use submenu SETUP, USER PREF. as a starting point. How to get there is explained above under Menu Navigation:

	Adjust the Display Contrast to your personal taste.
---	---

Reset to Factory Defaults

Proceed as follows to reset the Analyzer to factory default settings. Bear in mind that recorded data and adjustments will be lost.

Use submenu SETUP, USER PREF. as a starting point. How to get there is explained above under Menu Navigation:

F1	Press to start the reset to default settings. Because of the risk of unwanted erasure of data, a confirm menu pops up.
F5	Press to confirm the reset.

Proceed as follows to reset the Analyzer to factory default settings without loss of data: turn power off, then press and hold SAVE SCREEN and turn on again. You should hear a double beep.

Chapter 5 Display Information

Introduction

The Analyzer uses five different screen types to present measuring results in the most effective way. The features these screens have in common are explained in this chapter. Details that are specific for a certain measuring mode are presented in the chapter explaining that mode. The screen header is presented in the selected information language. The figure below gives an overview of the screen types 1 .. 5; common features are explained under A ... F.

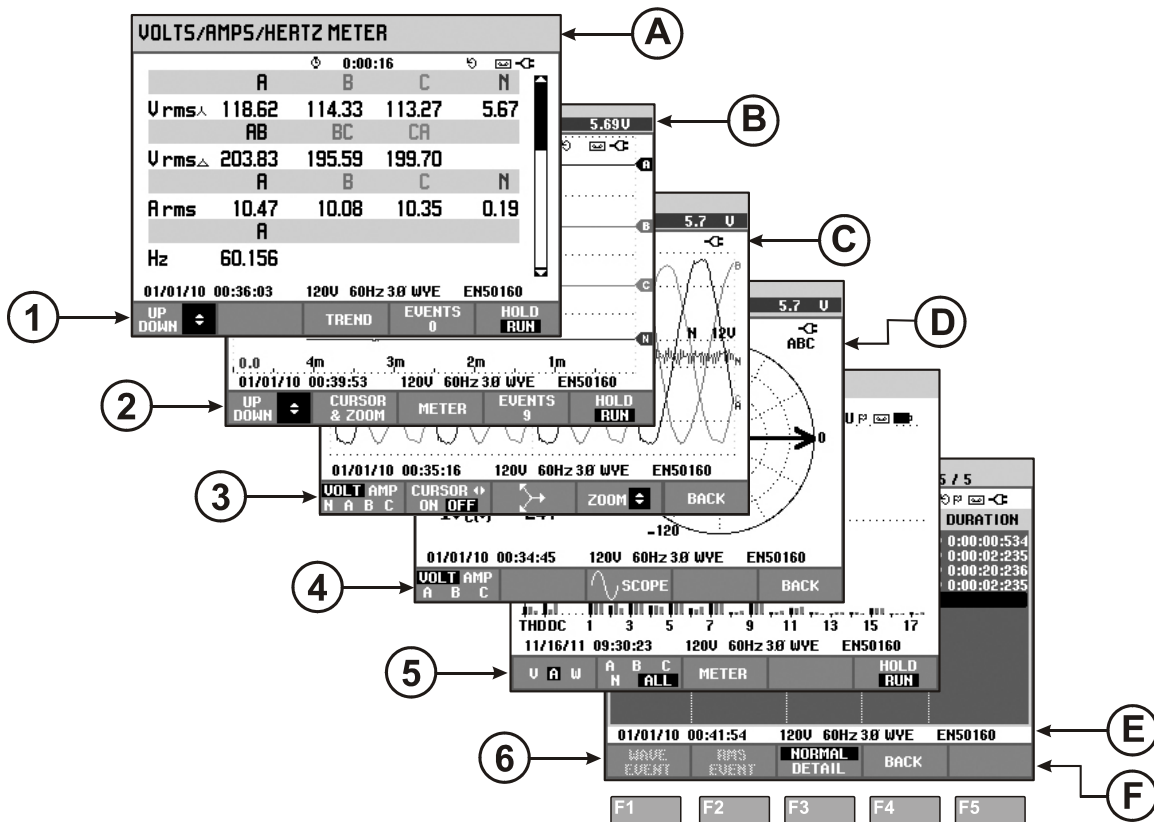

Figure 5-1. Survey of Display Types

Phase Colors

Measuring results belonging to different phases are presented with individual colors. If - for a certain phase - voltage and current are displayed simultaneously, the voltage color has a dark tone and the current has a light tone.

The set of phase colors can be chosen via the SETUP key and function key F1 – USER PREF. Then select Phase Colors with the up/down arrow keys. Next press ENTER to reach the menu. Within the menu use the up/down arrow keys to choose the desired colors and confirm with the ENTER. For detailed information see Chapter 23.

Screen Types









Below you will find a brief description of each screen type and its purpose. The measuring mode it is used for is given as well as the manual chapter (Ch.) with detailed information. Bear in mind that the amount of screen information depends on the number of phases and the wiring configuration. Refer to Figure 5-1, item 1 ... 5.

- ① Meter screen: gives an instantaneous overview of a big number of important numerical measuring values. All these values are logged as long as the measurement is on. They are stored in memory when the measurement is stopped. Used for all measurements except Monitor (Ch. 16) and Power Wave (Ch. 19).
- ② Trend screen: this type of screen is related to a Meter screen. Trend shows the course over time of measuring values from the Meter screen. After selection of a measuring mode, the Analyzer starts recording all readings in the Meter screen. Used for all measurements.
- ③ Waveform screen: shows voltage and current waveforms as displayed on an oscilloscope. Channel A (L1) is reference channel and 4 complete cycles are displayed. The nominal voltage and frequency determine the measuring grid size. Used for: Scope Waveform (Ch. 7), Transients (Ch. 18), Power Wave (Ch. 19), and Wave Event in Fluke 435-II/437-II.
- ④ Phasor screen: shows the phase relation between voltages and currents in a vector diagram. The vector of reference channel A (L1) points to the positive horizontal direction. The A (L1) amplitude is also reference for the measuring grid size. Used for: Scope Phasor (Ch. 7) and Unbalance (Ch. 14).
- ⑤ Bar Graph screen: shows the density of each measuring parameter as a percentage by means of a Bar Graph. Used for: Harmonics (Ch. 10), and Power Quality Monitor (Ch. 16).
- ⑥ Events list: lists the events that occurred during the measurement with data such as start date/time, phase and duration. Used for all measurements except Power Wave (Ch. 19).

Screen information common for all screen types

Refer to Figure 5-1, item A ... F

- Ⓐ Measuring mode: the active measuring mode is shown in the screen header.
- Ⓑ Measuring values: main numerical measuring values. Background colors differ per phase and for voltage or current. If Cursor is on, the values at the Cursor are shown.
- Ⓒ Status indicators. The following symbols may appear on the screen to show the state of Analyzer and measurements:

 - : Indication that the 150/180 cycle (3 s) aggregation interval (50/60 Hz) is active. With no indication, the aggregation interval is 10/12 cycles (50/60 Hz). The indication is of use for rms based readings.
 - -**9999:59:59** Time that a measurement has been going on. Format: hours, minutes, seconds. When waiting for a timed start, time counts down with prefix -.
 - U** Measurement may be unstable. E.g. applicable for frequency readout during absence of voltage at reference phase A (L1).
 - F** Indicates according to IEC61000-4-30 flagging convention that a dip, swell or interruption has occurred during the displayed aggregation interval. Indicates that an aggregated value may not be reliable.
 -  /  Recording of measurement data is on / off.
 -   Phasor rotation indicator.
 -   Battery/Line power indication. During battery operation the battery charge condition is displayed.
 -  Keyboard locked. Press ENTER 5 seconds to unlock/unlock.
- Ⓓ Main area with measuring data: features are explained under 1 ... 5.

Ⓔ Status line: following information appears on the screen. How to adjust these items is explained in Chapter 20 – General Settings. Following information is given:

01/21/06 Date of Analyzer's real time clock. Date format may be month-day-year or day-month-year.

16:45:22 Time of day or cursor time.

120V 60Hz Nominal line voltage and frequency: are a reference for the measurements.

📶 GPS signal strength indicator.

3Ø WYE Number of phases and wiring configuration for the measurement.

EN50160 Name of the limits used for the power quality MONITOR and Event Detection.

Ⓕ Softkey text area: softkey functions that can be selected with F1 ... F5 are indicated in white. Functions currently not available are indicated in gray. Active Function key selections are highlighted with a black background.

Chapter 6

Input Connections

Introduction

This chapter explains how to make connection to the power distribution system under test and how to adjust the Analyzer settings.

Check that the Analyzer setup meets the characteristics of the system under test and the accessories that are used. This concerns:

- wiring configuration
- nominal frequency
- nominal voltage
- limits used for power quality monitor and event detection
- properties of voltage leads and current clamps

For a quick verification of the key elements, use the setup wizard attainable via the SETUP key and function key F3 – SETUP WIZARD. Refer to Chapter 23 for more information.

The actual setup is shown in the welcome screen that appears after power up. To change the setup, refer to Chapter 23.

Input Connections

The Analyzer has 4 BNC inputs for current clamps and 5 banana-inputs for voltages.

Note: use only the current clamps as supplied or clamps that are recommended for safe use with the Analyzer. These clamps have a plastic BNC connector. The use of insulated BNC connectors is necessary for safe measurements.

Self-adhesive decals are supplied corresponding to wiring color codes used in the USA, Canada, Continental Europe, the UK, and China. Stick the decals that fit to your local wiring codes around the current and voltage inputs as shown in Figure 6-1.

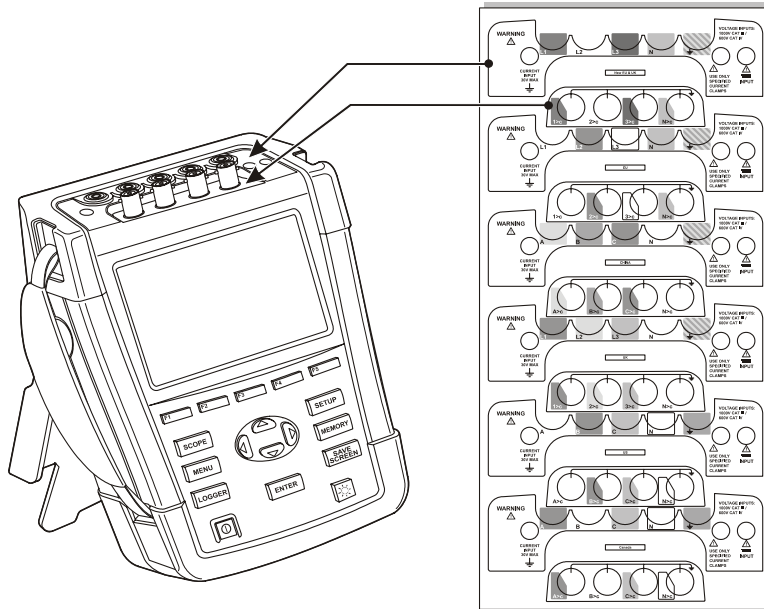

Figure 6-1. Mounting the decals for voltage and current inputs

De-energize power systems before making connections whenever possible. Always use appropriate equipment for personal protection. Avoid working alone and work according to the warnings listed in Chapter 1, Safety Information.

For a 3-phase system make the connections as shown in Figure 6-2.

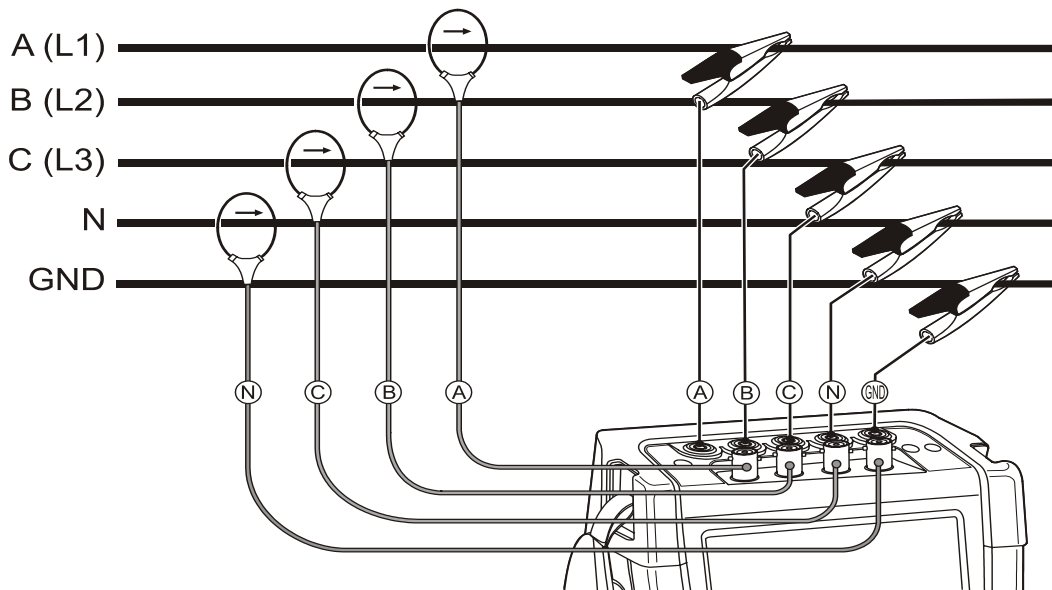

Figure 6-2. Connection of Analyzer to 3-phase distribution system

First put the current clamps around the conductors of phase A (L1), B (L2), C (L3), and N(utral). The clamps are marked with an arrow indicating the correct signal polarity.

Next make the voltage connections: start with Ground and then in succession N, A (L1), B (L2), and C (L3). For correct measuring results, always connect the Ground input. Always double-check the connections. Make sure that current clamps are secured and completely closed around the conductors.

For single phase measurements, use current input A (L1) and the voltage inputs Ground, N(eutral), and phase A (L1).

A (L1) is the reference phase for all measurements.

Before making any measurements, set the Analyzer up for the line voltage, frequency, and wiring configuration of the power system you want to measure. This is explained in Chapter 23, General Settings.

Scope Waveform and Phasor display are useful to check if voltage leads and current clamps are connected correctly. In the vector diagram the phase voltages and currents A (L1), B (L2), and C (L3) should appear in sequence when observing them in clockwise direction as shown in the example in Figure 6-3.

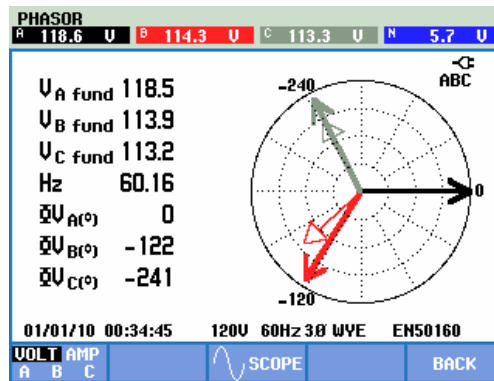

Figure 6-3. Vector diagram for correctly connected Analyzer

Chapter 7

Scope Waveform and Phasor

Introduction

Scope mode shows voltages and currents in the power system under test by means of waveforms or vector diagram. Also numerical values are shown such as phase voltages (rms, fundamental, and at cursor), phase currents (rms, fundamental and at cursor), frequency, and phase angles between voltages and currents.

Scope Waveform and Phasor can be used in combination with an other active measurement such as for instance Volts/Amps/Hertz and does not interrupt logging of readings.

Scope Waveform

To access the Scope Waveform screen:

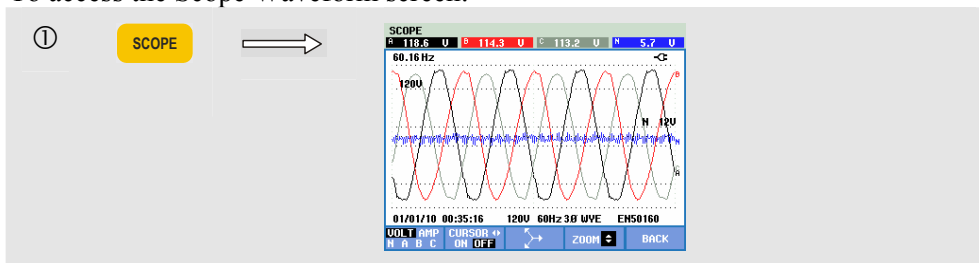

The Scope Waveform screen offers an oscilloscope style of display of voltage and/or current waveforms with a fast update rate. The screen header shows the related rms voltage/current values (10/12 cycle rms or 150/180 cycle rms). Four waveform periods are displayed. Channel A (L1) is the reference channel.

Available function keys:

F1

Selection of waveform set to be displayed: VOLT displays all voltages, AMP displays all currents. A (L1), B (L2), C (L3), N (neutral) give simultaneous display of phase voltage and current for the selected phase.

F2

Switch cursor on/off. Use the left/right arrow keys to move the cursor horizontally along the waveform.

F3	Access to the Phasor screen. For description see below.
F4	Up/down arrow keys are assigned to vertical zoom.
F5	Switch back to active measurement (e.g. Volts/Amps/Hertz). If Scope Waveform/Phasor is the only active measurement: switch to MENU.

Cursor. When the Cursor is on, the waveform values at the Cursor are displayed in the screen header.

Zoom. Allows you to expand or shrink the display vertically to view details or to see the complete graph within the screen area.

Zoom and Cursor are operated by the arrow keys and are explained in Chapter 22.

The Range of waveforms is preadjusted for a good display in almost all cases. This is based upon Nominal Voltage (Vnom) and Current range (A Range).

If desired, you can change the Volt and Amp range. Press in sequence: the SETUP key, F4 - MANUAL SETUP, F2 – SCOPE SCALE. There are separate adjustments for PHASE and NEUTRAL (to be selected with F3).

Also the PHASOR rotation indication can be set to your preference. Press in sequence: the SETUP key, F4 - MANUAL SETUP, F3 – FUNCTION PREFERENCE. Use the up/down arrow keys to select Phasor and the left/right arrow keys to select pos(itive) or neg(ative).

Scope Phasor

To access the Phasor screen:

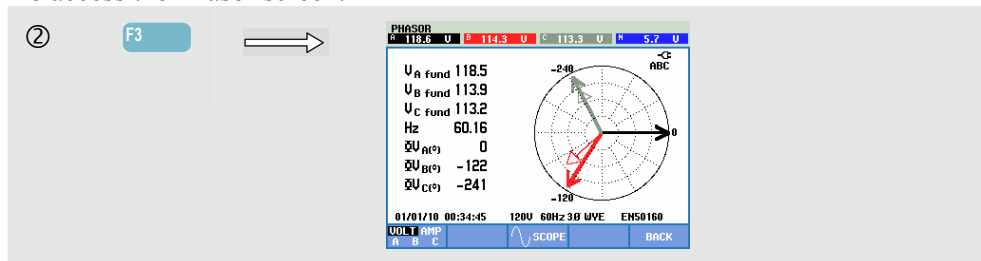

The Phasor screen displays the phase relation between voltages and currents in a vector diagram. The vector of reference channel A (L1) points in the positive horizontal direction. Additional numerical values are fundamental phase voltage and/or current, frequency, and phase angles. The screen header shows rms voltage and/or current values.

Available function keys:

F1	Selection of additional data to be displayed: all voltages, all currents, or voltage and current phase by phase.
F3	Return to the Scope Waveform.
F5	Switch back to active measurement (e.g. Volts/Amps/Hertz). If Scope Waveform/Phasor is the only active measurement: switch to MENU .

Tips and Hints

Scope Waveform gives a clear view of current and voltage waveform shapes. Voltage waveforms in particular should be smooth and sinusoidal. If you see voltage distortion, it is a good idea to check the harmonics display. The rms voltages and frequency should be close to their nominal values.

Waveform and Phasor display are also useful to check if voltage leads and current clamps are connected correctly. In the vector diagram the phase voltages A (L1), B (L2), and C (L3) should appear in sequence at equal distance (120 degrees). Current vectors should have the same direction as the voltage vector with usually less than 30 degree phase shift.

Chapter 8

Volts/Amps/Hertz

Introduction

Volts/Amps/Hertz displays a Meter screen with important numerical measuring values. The related Trend screen shows the changes over time of all values in the Meter screen. Events such as dips and swells are listed in a table.

Fluke 437-II is able to perform measurements in 400 Hz power systems (Marine, Aerospace, Rail, Military).

Meter screen

To access the VOLTS/AMPS/HERTZ Meter screen:

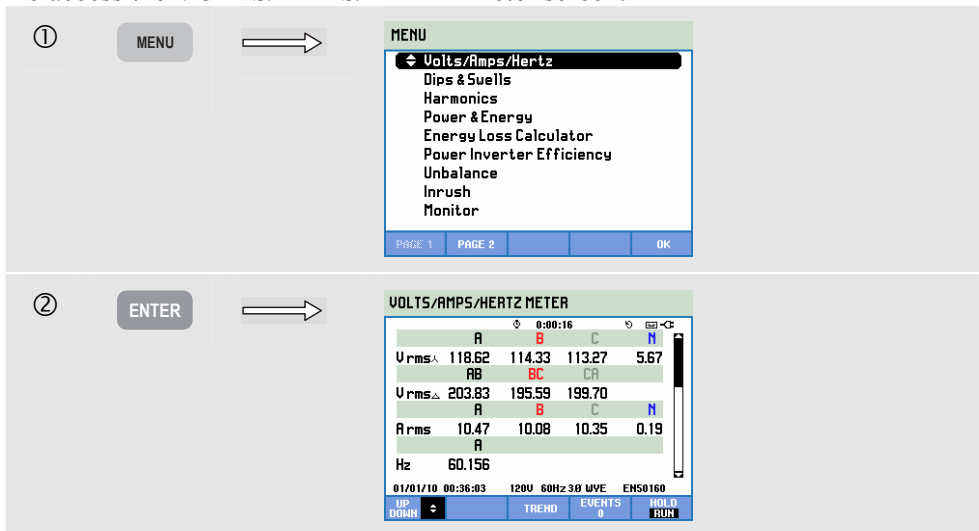

The Meter screen gives an overview of voltages and currents in all phases. The rms voltages are shown neutral-to-line and line-to-line. Also frequency and Crest Factors are shown. The Crest Factor CF indicates the amount of distortion: a CF of 1.41 means no distortion and higher than 1.8 means high distortion. Use this screen to get a first impression of power system performance before examining the system in detail with other measuring modes. The number of columns in the Meter screen depends on the power system configuration. Use the up/down arrow keys to scroll the Meter screen.

The figures in the Meter screen are present values that may update constantly. Changes in these values over time are recorded as soon as the measurement is turned on. The recording is visible in the Trend screen.

Logging. All measuring values in meter screen are logged. Refer to Chapter 3, paragraph Logging of Measuring Values for more information.

The Cycle Aggregation Interval for rms based measurements such as Vrms and Arms can be set to 10/12 cycles or 150/180 cycles. To adjust press in sequence: the SETUP key, F4 – MANUAL SETUP, F3 – FUNCTION PREF and the up/down arrow keys to select Cycle Aggrega(tion) and use the left/right arrow keys to adjust.

Available function keys:

F1	Up/down arrow keys are assigned to scroll Meter screen.
F3	Access to the Trend screen. For description see below.
F4	Access to the Events screen. The number of events that occurred is shown. For description see below.
F5	Switch between HOLD and RUN of screen update. Switching from HOLD to RUN invokes a menu to select immediate (NOW) or TIMED start time which allows you to define start and duration of the measurement.

Trend

To access the VOLTS/AMPS/HERTZ Trend screen:

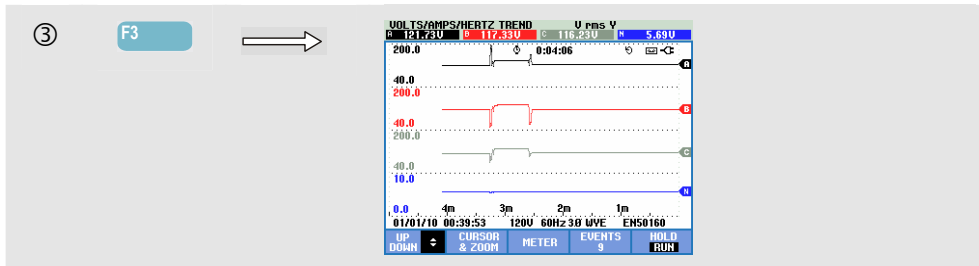

All values in the Meter screen are recorded, but the Trends from each row in the Meter screen are displayed one at a time. Press Function key F1 to assign the up/down arrow keys to row selection.

The traces build up from the right side. Readings in the header correspond to the most recent values plotted on the right.

Available function keys:

F1	Up/down arrow keys are assigned to scroll Trend screen.
F2	Access to cursor and zoom menu.
F3	Return to Meter screen.
F4	Access to Events menu. The number of events that occurred is shown. For description see below.

F5 Switch between HOLD and RUN of screen update. Switching from HOLD to RUN invokes a menu to select immediate (NOW) or TIMED start time which allows you to define start and duration of the measurement.

Cursor. When the Cursor is on, the Trend values at the Cursor are displayed in the screen header. Moving the Cursor off the left or right side of the screen brings the next screen into the viewing area.

Zoom. Allows you to expand or shrink the display vertically or horizontally to view details or to fit a complete graph within the screen area. Zoom and Cursor are operated by the arrow keys and explained in Chapter 22.

Cursor is active in Hold mode only.

Offset and Span of the Trends are auto ranging for a good display in almost all cases. If desired, you can change Offset and Span of active measurements. Press in sequence: the SETUP key, F4 – MANUAL SETUP, F1 – TREND SCALE. Use the up/down arrow keys to select the item to be adjusted and the left/right arrow keys to adjust. There are separate adjustments for PHASE and NEUTRAL (to be selected with Function key F3). See Chapter 23 for more information.

Events

To access the VOLTS/AMPS/HERTZ Events screen:

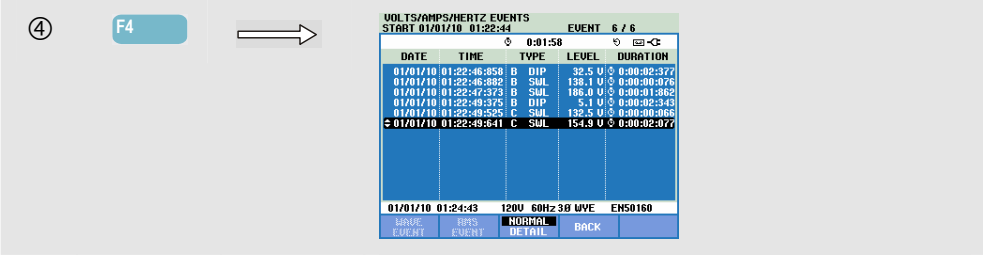

The Events table lists all threshold crossings of phase voltages. Thresholds according to international standards or user-definable thresholds can be used. Threshold adjustment is reached via the SETUP key and Limits. For detailed information see Chapter 23, Limits Adjustments.

In Normal mode major event characteristics are listed: start time, duration, and voltage magnitude. Detail shows details of threshold crossings per phase.

The following Abbreviations and Symbols are used in the tables:

Abbreviation	Description	Symbol	Description
CHG	Rapid Voltage Change		Rising voltage edge
DIP	Voltage Dip		Falling voltage edge
INT	Voltage Interruption		Change upwards
SWL	Voltage Swell		Change downwards
TRA	Transient		
AMP	Amp value exceeded		

Available function keys:

F1	Switch to wave event display: this will show a scope waveform around the selected event. Available in Fluke 435-II and 437-II.
F2	Switch to rms event display: this will show the ½ cycle rms trend around the selected event. Available in Fluke 435-II and 437-II.
F3	Switch between NORMAL and DETAILED event table.
F4	Return to Trend screen.

Tips and Hints

Voltage and frequency should be close to the nominal values of for example 120 V, 230 V, 480 V, 60 Hz, or 50 Hz.

The voltages and currents in the Meter screen can e.g. be used to check if power applied to a 3-phase induction motor is in balance. Voltage unbalance causes high unbalanced currents in stator windings resulting in overheating and reduced motor life. Each of the phase voltages should not differ more than 1 % from the average of the three. Current unbalance should not exceed 10 %. In case of too high unbalance, use other measuring modes to further analyze the power system.

A Crest Factor close to 2.0 indicates high distortion. CF = 2.0 can e.g. be found if you measure the current drawn by rectifiers that only conduct at the sine wave top.

Chapter 9

Dips & Swells

Introduction

Dips & Swells records Dips, Interruptions, Rapid Voltage Changes, and Swells.

Dips (Sags) and Swells are fast deviations from the normal voltage. Magnitude may be ten up to hundreds of volts. Duration may vary from a half cycle to a few seconds as defined in EN61000-4-30. The Analyzer allows you to choose nominal or sliding reference voltage. A sliding reference voltage uses measured values filtered with a 1-minute time constant.

During a dip the voltage drops; during a swell the voltage rises. In three phase systems a dip begins when the voltage on one or more phases drops below the dip threshold and ends when all phases are equal to or above the dip threshold plus hysteresis. The trigger conditions for dips and swells are threshold and hysteresis. Dips and swells are characterized by duration, magnitude, and time of occurrence. Figure 9-1 and 9-2 explain this.

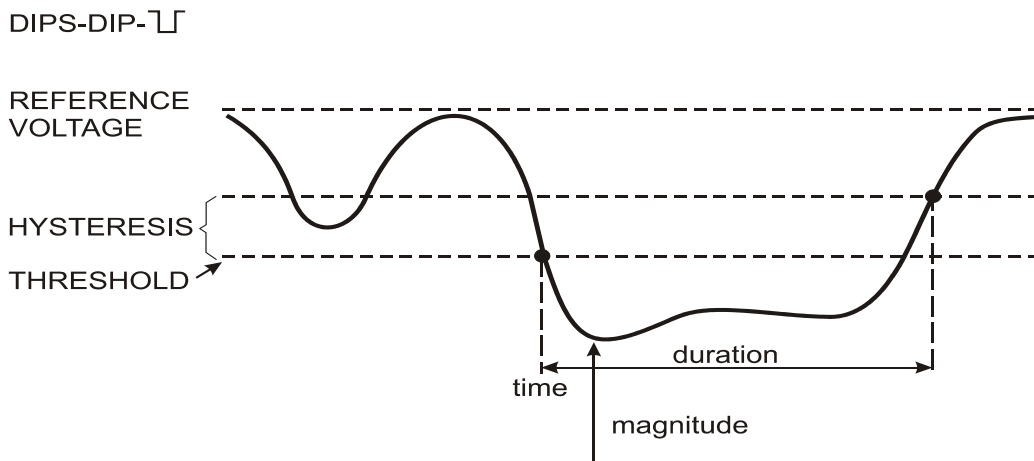

Figure 9-1. Characteristics of a voltage dip

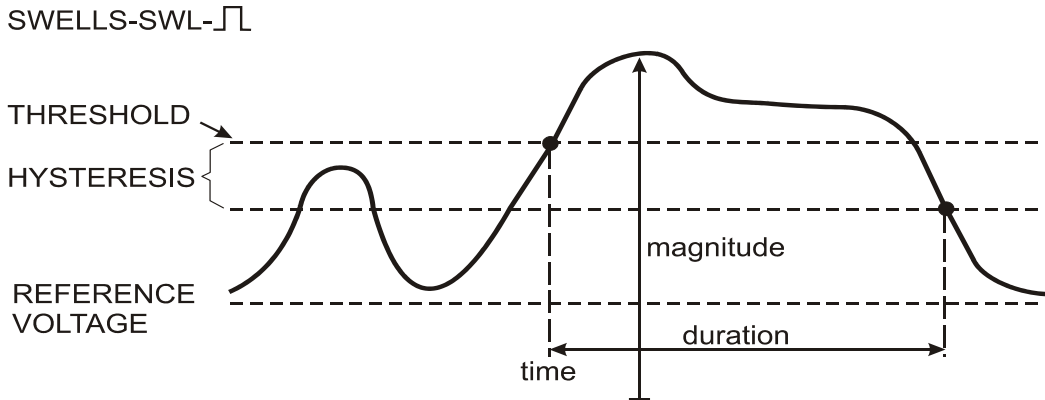

Figure 9-2. Characteristics of a voltage swell

During an Interruption the voltage sinks well below its nominal value. In three phase systems an interruption begins when the voltage on all phases are below threshold and ends when one phase is equal to or above the interruption threshold plus hysteresis. The trigger conditions for interruptions are threshold and hysteresis. Interruptions are characterized by duration, magnitude and time of occurrence. Figure 9-3 explains this.

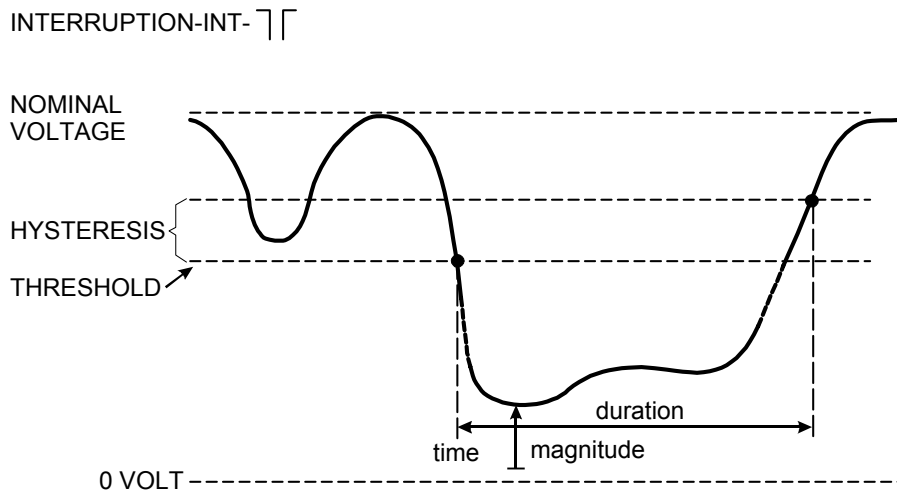

Figure 9-3. Characteristics of a voltage interruption

Rapid voltage changes are quick transitions of the rms voltage between two steady-states. Rapid voltage changes are captured based on steady voltage tolerance, steady time, minimum step detected, and minimum rate (%/s). When a voltage change crosses the dip or swell thresholds, it is considered a dip or swell and not a rapid voltage change. Additional to detection based upon voltage step (Vstep), detection based upon maximum voltage change (Vmax) can be selected when setting up the limits. Note that the Norwegian FoL requires detection on Vmax. The event list shows the voltage step and transition time. The detailed event list shows the Vmax relative to the nominal voltage. Figure 9-4 explains this.

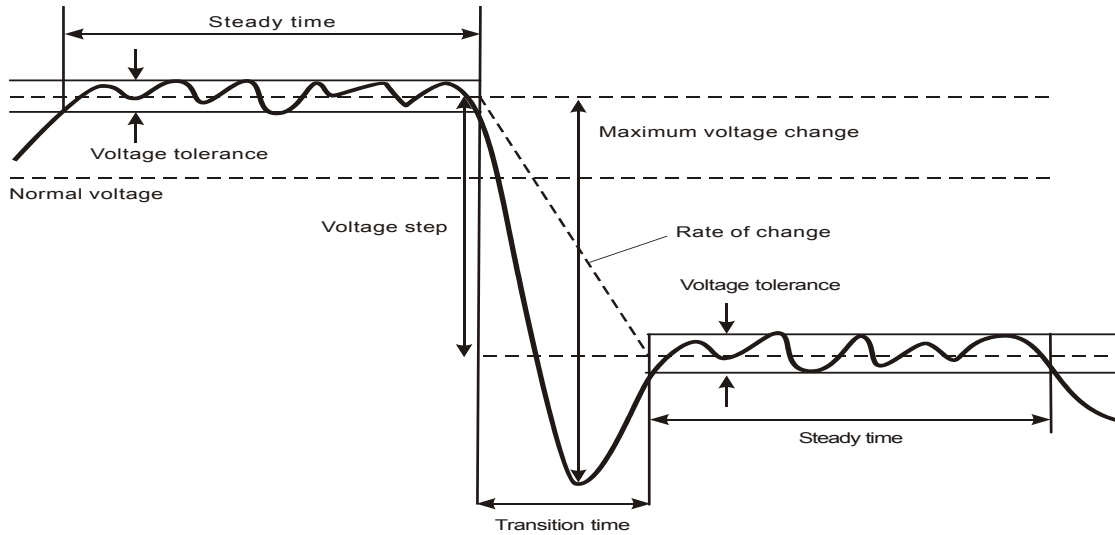

Figure 9-4. Characteristics of a rapid voltage change

In addition to the voltage also current is recorded. This allows you to see cause and effect of deviations.

Function key F4 – EVENTS accesses event tables where voltage events are listed in sequence.

Trend

To access to the Dips & Swells Trend screen:

For the main screen all configured voltage (Vrms half cycle) and current (Arms half cycle) channels are recorded to allow viewing of cause and effect of deviations. Not all channels are displayed simultaneously. The up/down arrow keys allow selection of the set of trends to be displayed.

The screen builds up from the right side of the screen and the corresponding values are displayed in the screen header.

Available function keys:

F1	Up/down arrow keys are assigned to scroll Trend screen.
F2	Access to cursor and zoom menu.
F3	Access to Meter screen.
F4	Access to Events tables. The number of events that occurred is shown. For description see below.
F5	Switch between HOLD and RUN of screen update. Switching from HOLD to RUN invokes a menu to select immediate (NOW) or TIMED start time which allows you to define start and duration of the measurement.

Logging. All measuring values in Meter screen are logged. Refer to Chapter 3, paragraph Logging of Measuring Values for more information.

Cursor. When the Cursor is on, the Trend values at the Cursor are displayed in the screen header. Moving the Cursor off the left or right side of the screen brings the next of six screens into the viewing area.

Zoom. Allows you to expand or shrink the display vertically or horizontally to view details or to fit a complete graph within the screen area. Zoom and Cursor are operated by the arrow keys and are explained in Chapter 22.

Offset and Span of the Trends are auto ranging for a good display in almost all cases. If desired, you can change Offset and Span of active trends. Press in sequence: the SETUP key, F4 – MANUAL SETUP, F1 – TREND SCALE. Use the up/down arrow keys to select the item to be adjusted and the left/right arrow keys to adjust. See Chapter 23 for more information. In this chapter is also explained how to adjust to Nominal or Sliding Reference.

Event criteria such as threshold, hysteresis and others are preset, but they may be adjusted. The adjustment menu is reached via the SETUP key, F4 – MANUAL SETUP and Limits setup. See Chapter 23, Limits Adjustments.

Events Tables

To access the Dips & Swells Events Tables:

The screenshot shows the 'DIPS & SWELLS EVENTS' table. The table has the following data:

DATE	TIME	TYPE	LEVEL	DURATION
01/01/10	00:40:206	A SWL	143.3 U	0:00:00:534
01/01/10	00:40:41:388	C DIP	44.2 U	0:00:02:235
01/01/10	00:40:41:437	A SWL	188.0 U	0:00:20:236
01/01/10	00:41:01:878	C DIP	40.6 U	0:00:02:235

At the bottom of the screen, there are navigation buttons: NORMAL, DETAIL, and BACK.

The Events table lists all threshold crossings of phase voltages. Thresholds according to international standards or user-definable thresholds can be used. Threshold adjustment is reached via the SETUP key, F4 – MANUAL SETUP and Limits. For detailed information see Chapter 23, Limits Adjustments.





With the Analyzer in HOLD mode you can see event details in the modes WAVE EVENT and RMS EVENT. With the up/down arrow keys you can select a certain event in the table.

WAVE EVENT (in Fluke 435-II and 437-II) gives oscilloscope style waveforms of the selected event. The event is in the horizontal mid of screen.





RMS EVENT (in Fluke 435-II and 437-II) gives a trend display with the event in the mid of screen (provided that there is sufficient data available after the event).

In Normal mode major event characteristics are listed: start time, duration, and voltage magnitude. Detail shows details of threshold crossings per phase.

The following Abbreviations and Symbols are used in the tables:

Abbreviation	Description	Symbol	Description
CHG	Rapid Voltage Change		Rising voltage edge
DIP	Voltage Dip		Falling voltage edge
INT	Voltage Interruption		Change upwards
SWL	Voltage Swell		Change downwards
TRA	Transient		
AMP	Amp value exceeded		

Available function keys:

	Access to WAVE EVENT display.
	Access to RMS EVENT display.
	Switch between NORMAL and DETAILED event table.
	Return to Trend screen.

Tips and Hints

The occurrence of Dips (Sags) and Swells may indicate a weak power distribution system. In such a system voltage will change considerably when a big motor or a welding machine is switched on or off. This may cause lights to flicker or even show visible dimming. It may cause reset and loss of data in computer systems and process controllers.

By monitoring the voltage and current trend at the power service entrance, you can find out if the cause of the voltage dip is inside or outside the building. The cause is inside the building (downstream) when voltage drops while current rises; it is outside (upstream) when both voltage and current drop.

Chapter 10

Harmonics

Introduction

Harmonics measures and records harmonics and interharmonics up to the 50th. Related data such as DC components, THD (Total Harmonic Distortion), and K-factor are measured. Harmonics are periodic distortions of voltage, current, or power sinewaves. A waveform can be considered as a combination of various sinewaves with different frequencies and magnitudes. The contribution of each of these components to the full signal is measured. Readings can be given as a percentage of the fundamental, as a percentage of all harmonics combined (rms value), or as rms value. Results may be viewed in a Bar Graph display, a Meter screen, or a Trend display. Harmonics are often caused by non-linear loads such as switched mode power supplies in computers, TV's and adjustable speed motor drives. Harmonics can cause transformers, conductors, and motors to overheat.

Note: the number of harmonics is limited to DC and harmonics 1 ... 11 for measurements in 400 Hz power systems such as offered in **Fluke 437-II**. The phase angle is not displayed. For further information refer to the Specifications in Chapter 26.

Bar Graph Screen

To access to the Harmonics Bar Graph screen:

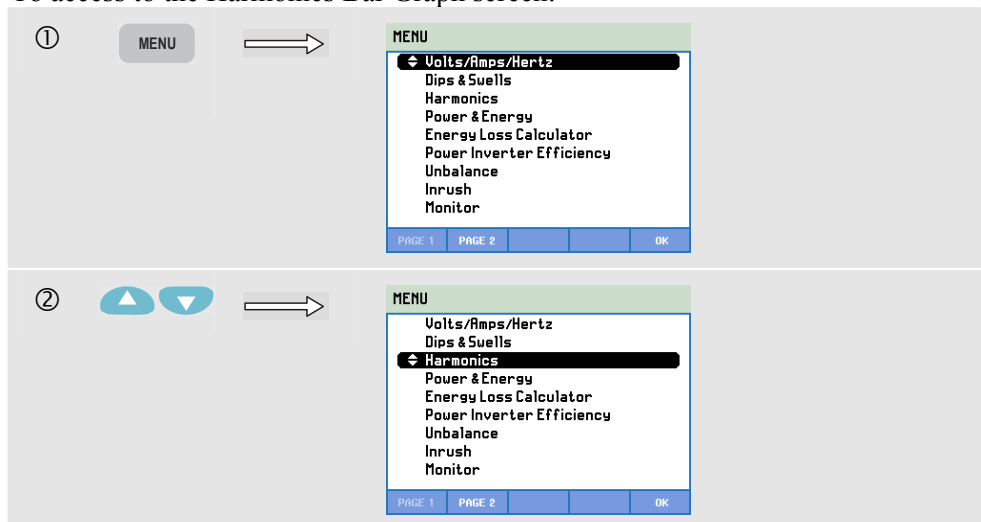

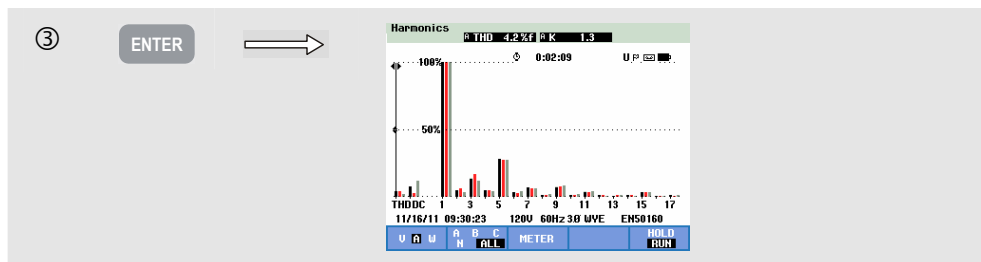

The Bar Graph display shows the percentage contribution of each of the components related to the full signal. A signal without distortion should show a 1st harmonic (= the fundamental) at 100 % while the others are at zero: in practice this will not occur because there always is a certain amount of distortion resulting in higher harmonics.

A pure sinewave becomes distorted when higher frequency components are added to it. Distortion is represented by the THD percentage. The display can also show the percentage of the DC component and the K-factor. The K-factor is measured for current and power and displayed in the screen header. It is a number that quantifies potential overload in transformers due to harmonic currents. Higher order harmonics influence the K-factor more than low order harmonics.

The table below shows the number of Bar Graphs displayed simultaneously in one screen:

	Harmonics	Harmonics & Interharmonics
All phase display	1 ... 12	1 ... 6
Single phase display	1 ... 50	1 ... 25

The left/right arrow keys are used to position the Cursor on a particular bar. The screen header will show for that bar phase identifier, harmonic number, frequency, and phase angle. If not all bars are shown on the screen, you can bring the next set within the viewing area by moving the Cursor off the left or right end of the screen. The up/down arrow keys are used for vertical zoom: 100 %, 50 %, 20 %, 10 %, or 5 % at full scale can be selected.

Press in sequence: the SETUP key, F4 – MANUAL SETUP, F3 – FUNCTION PREF and use the up/down arrow keys to select Harmonics measurement parameters and if required adjust them with the left/right arrow keys. For detailed information see Chapter 23, FUNCTION PREFERenCES.

Filtering. When measuring harmonics with interharmonics off, harmonics group is used and a 1.5 s smoothing filter is active. When measuring harmonics with interharmonics on, harmonics subgroup and interharmonics centered subgroup are used and no filter is active. Refer to IEC61000-4-7 for information on grouping.

Available function keys:

F1	Selection of harmonics type: Voltage, Current, or Real Power (Watt). Power harmonics can have positive and negative polarity.
F2	Selection of waveform set to be used: A (L1), B (L2), C (L3), N (neutral) or ALL

- F3 Access the Meter screen.
- F5 Switch between HOLD and RUN of screen update. Switching from HOLD to RUN invokes a menu to select immediate (NOW) or TIMED start time which allows you to define start and duration of the measurement.

Meter screen

To access the Harmonics Meter screen:

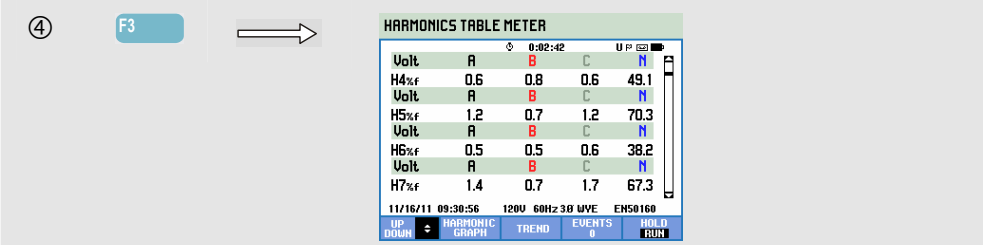

The Meter screen display shows many measurements that are grouped per phase. Use the up/down arrow keys to scroll all measurements within the viewing area.

The Events table attainable under Function key F4 lists all threshold crossings of phase voltages. Thresholds according to international standards or user-definable thresholds can be used. Threshold adjustment is reached via the SETUP key and Limits. For detailed information see Chapter 23, Limits Adjustments.

Available function keys:

- F1 Up/down arrow keys are assigned to scroll Meter screen.
- F2 Return to Bar Graph screen.
- F3 Access the Trend screen. For description see below.
- F4 Access to Events tables.
- F5 Switch between HOLD and RUN of screen update. Switching from HOLD to RUN invokes a menu to select immediate (NOW) or TIMED start time which allows you to define start and duration of the measurement.

Trend

To access the Harmonics Trend screen:

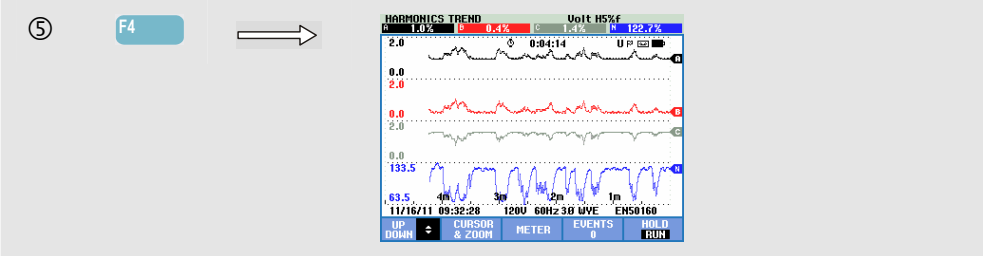

Trend shows how harmonics and related parameters vary over time: Cursor and Zoom can be used in HOLD mode to investigate trend details. All values in the Meter screen are recorded, but the Trends from each row in the Meter screen are displayed one at a time. Use the arrow keys to scroll the Trend screen.

Press in sequence: the SETUP key, F4 – MANUAL SETUP, F3 – FUNCTION PREF and use the up/down arrow keys to select Harmonics measurement parameters and if necessary adjust them with the left/right arrow keys. For detailed information see Chapter 23, FUNCTION PREFERenCES.

Available function keys:

F1	Up/down arrow keys are assigned to scroll the Trend screen.
F2	Access to cursor and zoom menu.
F3	Return to Meter screen.
F4	Access to events tables.
F5	Switch between HOLD and RUN of screen update. Switching from HOLD to RUN invokes a menu to select immediate (NOW) or TIMED start time which allows you to define start and duration of the measurement.

Tips and Hints

The harmonic number indicates the harmonic frequency: the first harmonic is the fundamental frequency (60 or 50 Hz), the second harmonic is the component with two times the fundamental frequency (120 or 100 Hz), and so on. The harmonics sequence can be positive (+), zero (0), or negative (-). The table below gives an overview.

Order	1st	2nd	3rd	4th	5th	6th
Frequency	60 Hz 50 Hz	120 Hz 100 Hz	180 Hz 150 Hz	240 Hz 200 Hz	300 Hz 250 Hz	360 Hz 300 Hz
Sequence	+	-	0	+	-	0

Order	7th	8th	9th	10th	11th	...
Frequency	420 Hz 350 Hz	480 Hz 400 Hz	540 Hz 450 Hz	600 Hz 500 Hz	660 Hz 550 Hz	...
Sequence	+	-	0	+	-	...

Positive sequence harmonics try to make a motor run faster than the fundamental; negative sequence harmonics try to make the motor run slower than the fundamental. In both cases the motor loses torque and heats up. Harmonics can also cause transformers to overheat. Even harmonics disappear if waveforms are symmetrical, i.e. as equally positive and negative.

Zero sequence current harmonics add in Neutral conductors. This can cause overheating of these conductors.

Distortion. Current distortion is to be expected in a system with non-linear loads like DC power supplies. When the current distortion starts to cause voltage distortion (THD) of more than 5 %, this signals a potential problem.

K-factor: this is an indication of the amount of harmonic currents and can help in selecting transformers. Use the K-factor along with kVA to select a replacement transformer to handle non-linear, harmonics-rich loads.

Chapter 11

Power & Energy

Introduction

Power & Energy displays a Meter screen showing all important power parameters. The related Trend screen shows the changes over time of all measuring values in the Meter screen. An Events table lists all crossings of threshold voltages.

The Analyzer also displays energy usage. Power calculations are done for Fundamental and Full. FUNDamental considers voltage and current only at the fundamental frequency (60, 50 Hz, or 400 Hz in Fluke 437-II) for power calculations; FULL uses the full frequency spectrum (True rms voltage and current).

Press in sequence: the SETUP key, F4 – MANUAL SETUP, F3 – FUNCTION PREF and the up/down arrow keys to select Power measurement parameters Method and Display and if required adjust them with the left/right arrow keys. Also the Cycle Aggregation Interval can be set to 10/12 or 150/180 cycles. This interval is of use for rms based measurements. Refer to chapter 23 for detailed information.

Power measurement can be done according to the methods Unified and Classic. Selection between both methods is done in the FUNCTION PREF menu.

Unified uses algorithms according to the unified method in accordance to IEEE 1149 as developed at the Polytechnical University of Valencia. The method allows to measure real power (kW), apparent power (kVA), reactive power (kvar), harmonic power components (kVA Harm), and unbalance power (kVA Unb).

Classic measures real power (kW) and apparent power (kVA) identical to the Unified method. Kvar is calculated using power triangle: $\text{var}^2 = \text{VA}^2 - \text{W}^2$.

Total powers are calculated using IEEE 1149 arithmetic sum method. Classic method does not take into account harmonics power and unbalance power. Refer to Appendix 'Measurement Methods' for additional information.

Meter screen

To access the Power & Energy Meter screen:



The following power measurements are made:

- Real power (W, kW): measurement as normally registered by energy usage meters. The full spectrum is used.
- Apparent power (VA, kVA): the full spectrum is used.
- Reactive power (var, kvar): the fundamental frequency is used.
- Harmonic power (VA or kVA Harm): non fundamental frequency powers.
- Unbalance reactive power (VA or kVA Unb): real power.
- Fundamental real power (W or kW fund): the fundamental frequency is used.
- Fundamental apparent power (VA, kVA fund): the fundamental frequency is used.
- Cos ϕ or DPF or: $\cos \phi$ is phase angle between fundamental voltage and current. DPF is (W fund)/(VA fund).

Energy measurements include:

- Active energy (Wh, kWh).
- Apparent energy (VAh, kVAh).
- Reactive energy (varh, kvarh).
- Forward energy (Wh, kWh forw): energy consumed.
- Reverse energy (Wh, kWh rev): energy delivered.

Also the the 12/10 or 180/150 cycle rms values of current and voltage are displayed.

Symbols indicate if a load is capacitive ($\frac{+}{-}$) or inductive ($\frac{-}{+}$).

The Analyzer displays power and energy usage by phase and in total.

By a using TIMED start of the measurement, the Analyzer can be used to measure energy usage during a predefined period of time. TIMED start can be adjusted when switching from HOLD to RUN with function key F5.

Available function keys:

F1	Up/down arrow keys are assigned to scroll Meter screen.
F3	Access to Trend screen. For description see below.
F4	Access to Events menu. The number of events that occurred is shown.
F5	Switch between HOLD and RUN of screen update. Switching from HOLD to RUN invokes a menu to select immediate (NOW) or TIMED start time which allows you to define start and duration of the measurement.

Trend

To access the Power & Energy Trend screen:

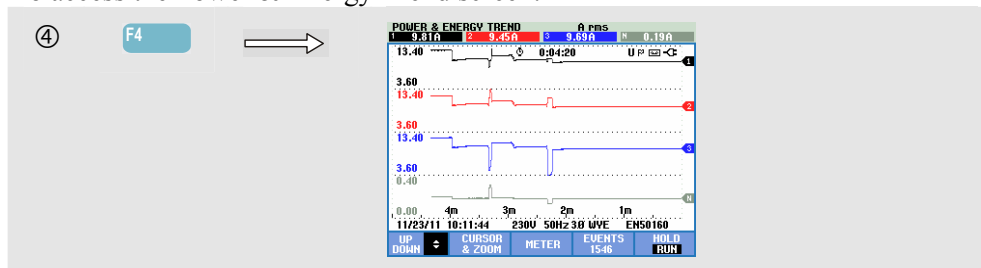

The figures in the Meter screen are instantaneous values that update constantly. Changes in these values over time are recorded whenever the measurement is active. All values in the Meter screen are recorded, but the Trends from each row in the Meter screen are displayed one at a time. The arrow keys are assigned to scroll the Trend screen.

The traces build up from the right side. The readings in the header correspond to the most recent measurements plotted on the right.

Available function keys:

F1	Up/down arrow keys are assigned to scroll Trend screen.
F2	Access to cursor and zoom menu.
F3	Return to Meter screen.
F4	Access to Events tables.
F5	Switch between HOLD and RUN of screen update. Switching from HOLD to RUN invokes a menu to select immediate (NOW) or TIMED start time which allows you to define start and duration of the measurement.

Cursor. When the Cursor is on, the Trend values at the Cursor are displayed in the screen header. Moving the Cursor off the left or right side of the screen brings the next of six screens into the viewing area.

Zoom. Allows you to expand or shrink the display vertically or horizontally to view details or to fit a complete graph within the screen area. Zoom and Cursor are operated by the arrow keys and explained in Chapter 22.

Offset and Span are auto ranging for a good display in most cases. This is based upon Nominal Voltage (Vnom) and Current range (A range). If desired, you can change Offset and Span. The adjustment menu is reached via the SETUP key, F4 – MANUAL SETUP, F1 - TREND SCALE, and F1 – TREND SCALE. There are separate adjustments for PHASE and NEUTRAL (to be selected with F3). See Chapter 23, MANUAL SETUP.

Tips and Hints

Power mode can be used to record apparent power (kVA) of a transformer over several hours. Look at the Trend and find out if there are times that the transformer is overloaded. You can transfer loads to other transformers, stagger the timing of loads, or if necessary replace the transformer with a larger one.

Interpretation of Power Factor when measured at a device:

- PF = 0 to 1: not all supplied power is consumed, a certain amount of reactive power is present. Current leads (capacitive load) or lags (inductive load).
- PF = 1: all supplied power is consumed by the device. Voltage and current are in phase.
- PF = -1: device generates power. Current and voltage are in phase.
- PF = -1 to 0: device is generating power. Current leads or lags.

If you see negative power readings and you are connected to a load, check to make sure the arrows on your current clamps are pointing towards the load.

Reactive power (var) is most often due to inductive loads such as motors, inductors, and transformers. Installation of correction capacitors can correct for inductive var's. Be sure to check with a qualified engineer before adding PF-correction capacitors, especially if you measure current harmonics in your system.

Chapter 12

Energy Loss Calculator

Introduction

The Analyzer provides advanced analysis of energy usage to help you to determine where energy losses occur and to visualize their impact on the energy bill. The Energy Loss function allows to determine losses due to several causes:

- Effective kW. Loss due to transport of the effective power. Caused by resistance of wires. This is the only component of the power that is transferable in useful mechanical energy.
- Reactive kvar. Loss due to reactive power that is being transported back and forth through the system, but does not deliver active work. The loss is caused due to the current flowing.
- Unbalance kVA. Loss due to unbalance in source and load. This unique measuring function helps to reveal losses occurring due to unbalance in the network. Unbalance power is Fundamental Power minus positive sequence Power.
- Distortion kVA. Loss due to distortion power (harmonics). Allows you to quickly determine on forehand the savings due to active filtering or other system improvements. Harmonics power is real power minus fundamental power.
- Neutral A. Loss due to currents in neutral conductor. Besides from being a possible source for unsafe situations such as overheating, large current that flows in the Neutral conductor of the system will cause losses too.

The Analyzer will measure these components simultaneously. Energy Loss Calculator uses patented algorithms to calculate losses and to monetize them. The costs due to Effective W, Reactive var, Unbalance VA, Distortion VA and Neutral A are displayed per Hour. The total costs are displayed per year which gives you an impression of possible savings on a yearly basis.

Four different rates can be set (price per kWh as a function of period of day). The length (meters or feet) and diameter (square millimeter or AWG/American Wire Gauge) of the cables between service entrance and the load can be set manually.

In AUTO mode a loss of 3% due to wire resistance is assumed which is normal for an average distribution system.

Energy Loss Calculator Display

To access the Energy Loss Calculator screen:

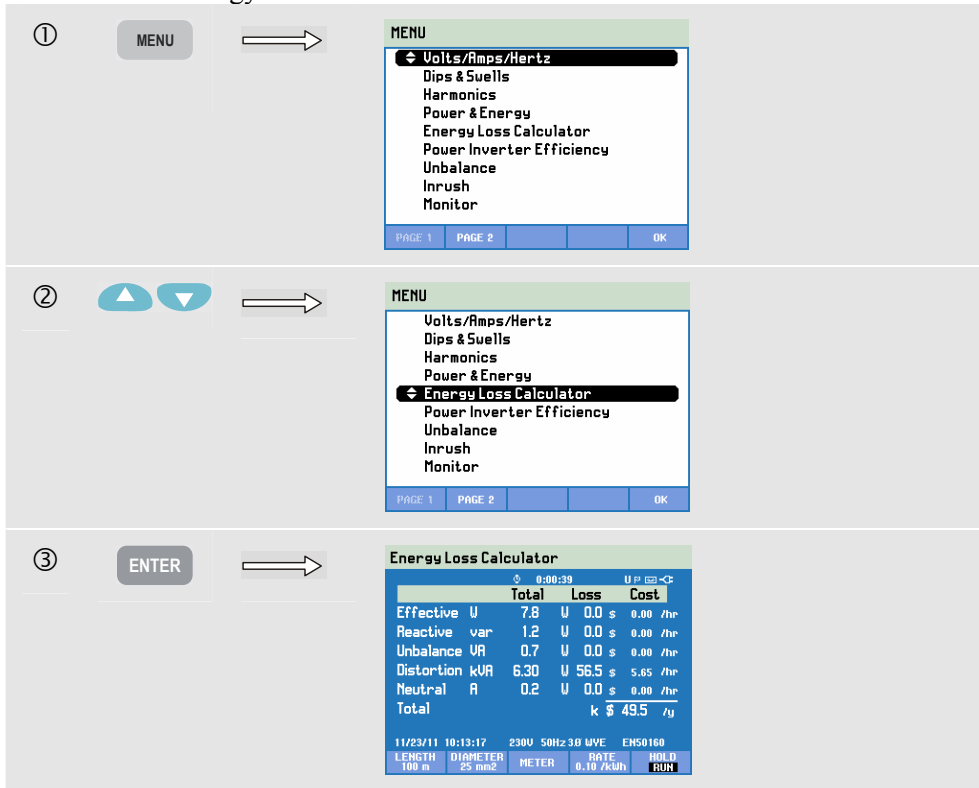

Cable properties, tariff and currency can be preset via the key sequence SETUP key, F4 – MANUAL SETUP, F3 – FUNCTION PReference, F4 – ENERGY LOSS. How to proceed is explained in Chapter 23 Setup.

Available function keys:

F1	Access to menu to adjust cable data, tariff, currency.
F2	Access to menu to adjust cable data, tariff, currency.
F3	Access to Meter screen. For description see below.
F4	Access to menu to adjust cable data, tariff, currency.
F5	Switch between HOLD and RUN of screen update. Switching from HOLD to RUN invokes a menu to select immediate (NOW) or TIMED start time which allows you to define start and duration of the measurement.

Meter

To access the Energy Loss Meter screen:

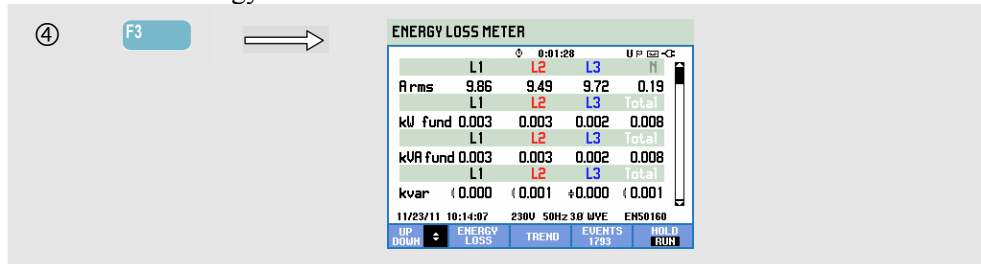

A large number of measurements are available:

- Arms, kW fund, kVA fund, kvar, kVA harm are shown per phase and in total.
- kVA unb, kW R loss, kW var loss, kW unb loss, kW harm loss, kW An loss, kW tot loss are shown in total.
- kWh R loss, kWh var loss, kWh harm loss, kWh unb loss, kWh An loss, kWh tot loss are shown in total.
- kcost R, kcost var, kcost unb, kcost harm, kcost An, kcost tot are shown in total.
- kWh forw and kWh rev are shown per phase and in total.

Abbreviations that are used:

- Fund indicates that fundamental frequency is used; in all other cases the full spectrum is used.
- kW or W is the power.
- Wh or kWh is the energy used.
- R indicates loss due to conductor resistance.
- var indicates loss due to reactive power.
- unb indicates loss due to system unbalance.
- harm indicates loss due to harmonics.
- An indicates loss due to current in the Neutral conductor.
- kWh forward is the energy taken from the distribution network; kWh reverse is the energy supplied to the distribution network.

The figures in the Meter screen are instantaneous values that update constantly. The trend of these values over time is visible in a Trend screen.

Also a Events table is available.

Available function keys:

F1	Up/down arrow keys are assigned to scroll Meter screen.
F2	Return to Energy Loss Calculator screen.
F3	Access to Trend screen.
F4	Access to Events table.
F5	Switch between HOLD and RUN of screen update. Switching from HOLD to RUN invokes a menu to select immediate (NOW) or TIMED start time which allows you to define start and duration of the measurement.

Tips and Hints

A power system is utilized in an optimal way if voltage and current are sinusoidal, in phase, and balanced. Any deviation from this will cause efficiency loss and thus waste of energy.

A poor power factor is usually caused by reactive devices such as transformers and motors. The power factor can be improved by adding capacitors in parallel with the inductive load. The ideal situation is a $\cos \phi$ or DPF equal or close to 1.

Reactive powers (var) do not contribute to efficient energy transfer. They are not included in the real power (W, kW) measurement, but cause energy losses due to wire resistance. Additionally utilities may charge additional cost when var readings are high because they need to provide apparent power (VA, kVA) that does not include both var and W.

Unbalanced powers and harmonic power are included in Watt measurement of energy usage meters so that the user has to pay for it. But these powers can not be converted effectively into mechanical energy and are therefore considered loss.

Increasing the diameter of conductors reduces copper loss (Effective kW).

If harmonics are present, consult a qualified engineer before installing capacitors. Non-linear loads such as adjustable frequency motor drives cause non-sinusoidal load currents with harmonics. Harmonic currents increase the kvar and thereby decrease total power factor. A poor total power factor caused by harmonics requires filtering for correction.

In general the most efficient way to troubleshoot electrical systems, is to begin at the load and work towards the building's service entrance. Measurements are taken along the way to isolate faulty components or loads.

Chapter 13

Power Inverter Efficiency

Introduction

Power Inverter Efficiency measures the efficiency and amount of energy being delivered by inverters that convert single phase dc into single or three phase ac. This concerns inverters such as used in solar panel systems, variable speed drives and Uninterruptable Power Supply (UPS) systems. The Power Inverter Efficiency measurement measures the dc voltage and current that feed the inverter input. The ac output current of the inverter unit is measured as well as the three voltages between the phases (A/L1, B/L2, C/L3).

Power Inverter Efficiency requires balanced voltages in a three wire (delta) configuration. To check voltage balance on the inverter output, you can use the Voltage Unbalance function (Chapter 14). Voltage Unbalance Vneg. should be less than 0.5 %. For Power Inverter Efficiency it is not required to have balanced currents. Unbalance Aneg. up to 100 % is allowed.

The measurement is started with a clear diagram how to connect current and voltage probes to the system. The measurement requires an (optional) dc current clamp (refer to chapter 25, paragraph Optional Accessories or visit www.fluke.com to find a clamp that fits your application).

Measurements: Wac, Wfund, Wdc, Efficiency, Vdc, Adc, Vrms, Arms, Hz. The measurements are displayed in a Meter screen and a Trend screen.

Note: the measurement requires an optional dc current clamp.

Meter screen

To access the Power Inverter Efficiency Meter screen:

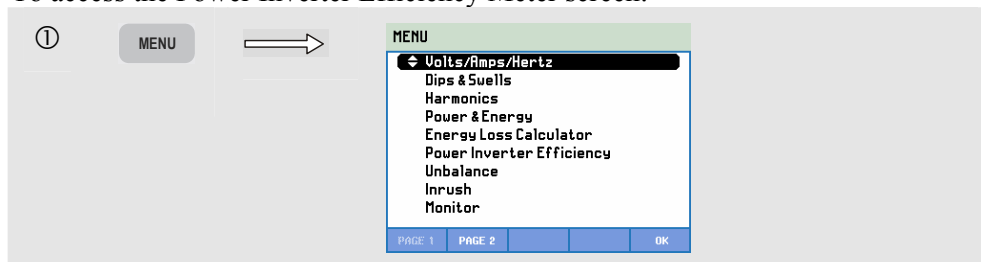

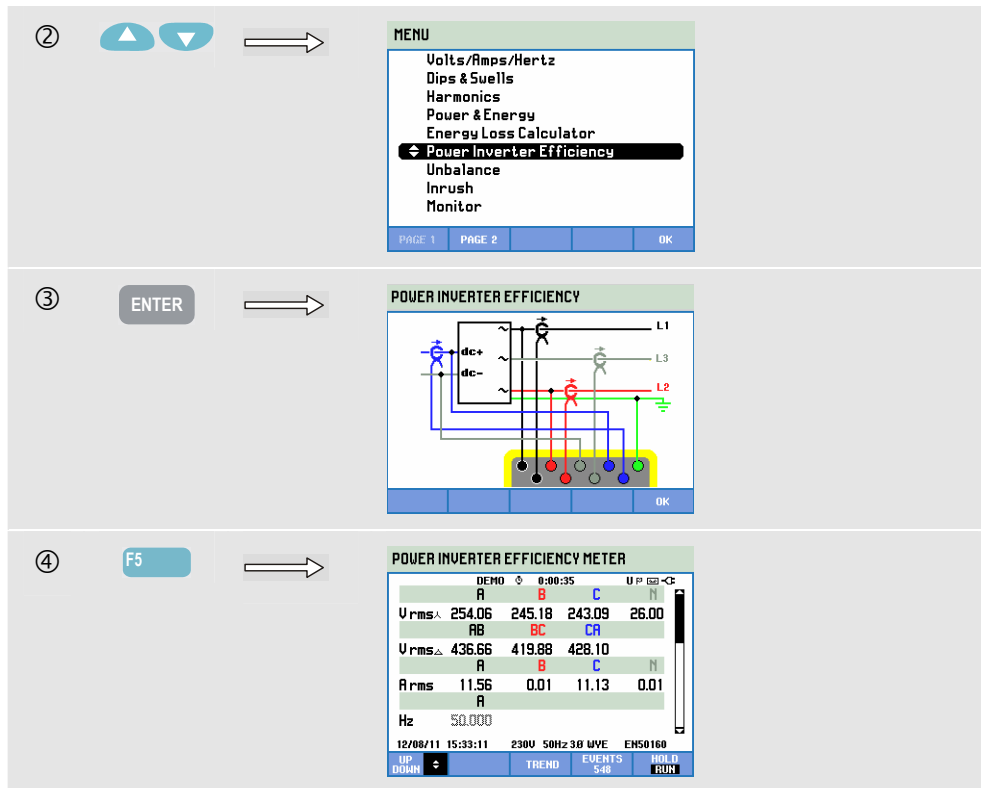

Available function keys:

F1	Up/down arrow keys are assigned to scroll Meter screen.
F3	Access to the Trend screen. For description see below.
F5	Switch between HOLD and RUN of screen update. Switching from HOLD to RUN invokes a menu to select immediate (NOW) or TIMED start time which allows you to define start and duration of the measurement.

Trend

To access the VOLTS/AMPS/HERTZ Trend screen:

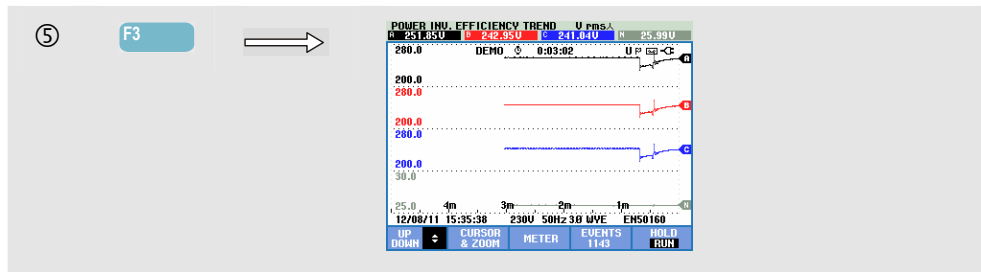

All values in the Meter screen are recorded, but the Trends from each row in the Meter screen are displayed one at a time. Press Function key F1 to assign the up/down arrow keys to row selection.

The traces build up from the right side. Readings in the header correspond to the most recent values plotted on the right.

Available function keys:

F1

Up/down arrow keys are assigned to scroll Trend screen.

F2

Access to cursor and zoom menu.

F3

Return to Meter screen.

Tips and Hints

Power Inverter Efficiency measurement is a useful tool to analyze how good an inverter is functioning. A good inverter should have an efficiency over 90 %. Bear in mind that an inverter usually has its highest efficiency when used between 40 to 70 % of its peak power. If an inverter is always used at 100 % of its maximum power you may consider installation of a device with a higher efficiency. Examples of other factors that determine overall system efficiency: the diameter of cabling is probably too small causing losses and inverter temperature that may be decreased by a better air flow.

Chapter 14

Unbalance

Introduction

Unbalance displays phase relations between voltages and currents. Measuring results are based upon the fundamental frequency component (60 Hz, 50 Hz, or 400 Hz in Fluke 437-II) using method of symmetrical components). In a 3-phase power system, the phase shift between voltages and between currents should be close to 120°. Unbalance mode offers a Meter screen, a related Trend display, Events tables, and a Phasor display.

Phasor screen

To access the Unbalance Phasor screen:

① MENU → MENU

- Volts/Amps/Hertz
- Dips & Swells
- Harmonics
- Power & Energy
- Energy Loss Calculator
- Power Inverter Efficiency
- Unbalance
- Inrush
- Monitor

PAGE 1 PAGE 2 OK

② ↑ ↓ → MENU

- Volts/Amps/Hertz
- Dips & Swells
- Harmonics
- Power & Energy
- Energy Loss Calculator
- Power Inverter Efficiency
- Unbalance
- Inrush
- Monitor

PAGE 1 PAGE 2 OK

③ ENTER → PHASOR UNBALANCE

U ₁ fund	8.2	U ₂ fund	8.0	U ₃ fund	7.5		
Hz	50.000	∅U _{1(°)}	0	∅U _{2(°)}	-130	∅U _{3(°)}	-250

0:00:49 U P EQ <C

11/23/11 10:16:50 230V 50Hz 3Ø WVE EN50160

U ₁	U ₂	U ₃	METER	HOLD
L1	L2	L3		RUN

The Phasor Screen shows the phase relation between voltages and currents in a vector diagram divided in 30 degree sections. The vector of the reference channel A (L1) points to the positive horizontal direction. A similar vector diagram is displayed under Scope Phasor. Additional numerical values are given: negative voltage or current unbalance (Relative %), zero sequence voltage or current unbalance (Relative %), fundamental phase voltage or current, frequency, phase angles. With function key F1 you can choose readings of all phase voltages, all phase currents, or voltage and current in one phase.

Available function keys:

F1	Selection of signals to be displayed: V displays all voltages, A displays all currents. A (L1), B (L2), C (L3), N (neutral) give simultaneous display of phase voltage and current.
F2	Access to Meter screen.
F5	Switch between HOLD and RUN of screen update. Switching from HOLD to RUN invokes a menu to select immediate (NOW) or TIMED start time which allows you to define start and duration of the measurement.

Meter Screen

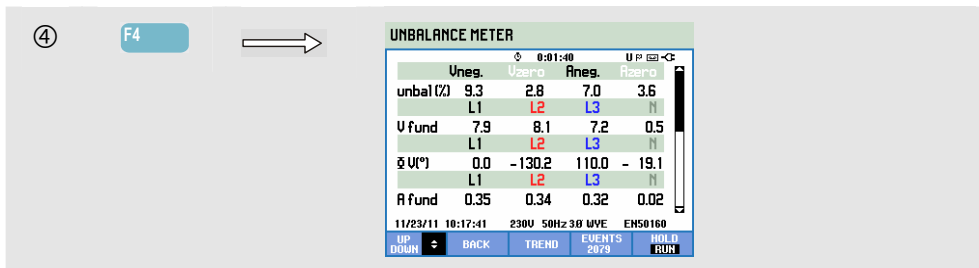

The Meter screen shows all relevant numerical values: negative voltage unbalance percentage, zero sequence voltage unbalance percentage (in 4-wire systems), negative current unbalance percentage, zero sequence current unbalance percentage (in 4-wire systems), fundamental phase voltage, frequency, fundamental phase current, angle between phase-neutral voltages relative to the reference phase A/L1 and angles between voltage and current for each phase.

Available function keys:

F1	Up/down arrow keys are assigned to scroll the Meter screen.
F2	Return to Phasor screen.
F3	Access to Trend screen. For description see below.
F4	Access Events menu. The number of events that occurred is shown.
F5	Switch between HOLD and RUN of screen update. Switching from HOLD to RUN invokes a menu to select immediate (NOW) or TIMED start time which allows you to define start and duration of the measurement.

Trend

To access the Unbalance trend screen:

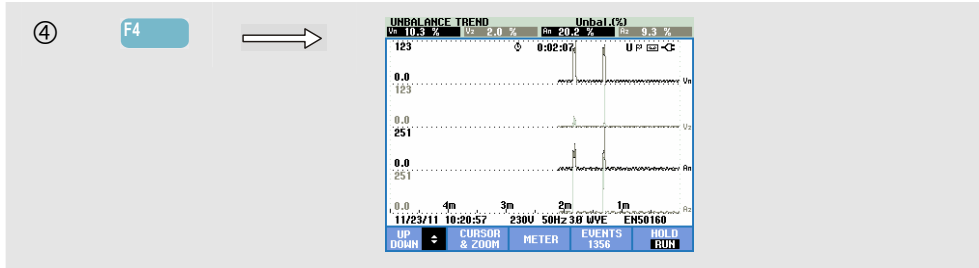

The figures in the Meter screen are instantaneous values that update constantly. Changes in these values over time are recorded whenever the measurement is active. All values in the Meter screen are recorded, but the Trends from each row in the Meter screen are displayed one at a time. Press function key F1 to assign the arrow keys to row selection. The Trend display may consist of 6 screens.

Available function keys:

F1	Up/down arrow keys are assigned to scroll the Meter screen.
F2	Access to cursor and zoom menu.
F3	Return to Meter screen.
F4	Access Events menu. The number of events that occurred is shown.
F5	Switch between HOLD and RUN of screen update. Switching from HOLD to RUN invokes a menu to select immediate (NOW) or TIMED start time which allows you to define start and duration of the measurement.

Cursor. When the Cursor is on, the Trend values at the Cursor are displayed in the screen header. Moving the Cursor off the left or right side of the screen brings the next data into the viewing area when available.

Zoom. Allows you to expand or shrink the display vertically or horizontally to view details or to fit a complete graph within the screen area. Zoom and Cursor are operated by the arrow keys and explained in Chapter 22.

Offset and Span are preset for a good display in most cases, but they are adjustable. The adjustment menu is reached via the SETUP key, F4 – MANUAL SETUP, and F1 – TREND SCALE. There are separate adjustments for PHASE and NEUTRAL (to be selected with F3). Also the Phasor display is adjustable. The adjustment menu is reached via the SETUP key, F4 – MANUAL SETUP, F3 - FUNCTION PREF. Use the up/down arrow keys to select Phasor Clockwise and the left/right arrow keys to select pos(itive) or neg(ative). See Chapter 23, FUNCTION PReferences.

Tips and Hints

The voltages and currents in the Meter screen can e.g. be used to check if power applied to a 3-phase induction motor is in balance. Voltage unbalance causes high unbalanced

currents in stator windings resulting in overheating and reduced motor life. The Negative Voltage component V_{neg} should not exceed 2 %. Current unbalance should not exceed 10 %. In case of too high unbalance, use other measuring modes to further analyze the power system.

Each three phase voltage or current can be split-up into three components: positive sequence, negative sequence, and zero sequence.

The positive sequence component is the normal component such as present in balanced 3-phase systems. The negative sequence component results from unbalanced phase-to-phase currents and voltages. This component for instance causes a 'braking' effect in 3-phase motors: this will result in overheating and life reduction.

Zero sequence components may appear in an unbalanced load in 4 wire power systems and represent the current in the N (Neutral) wire. Unbalance exceeding 2 % is considered as too high.

Chapter 15

Inrush

Introduction

Inrush Currents can be captured by the Analyzer. Inrush Currents are surge currents that occur when a large, or low-impedance load comes on line. Normally the current will stabilize after some time when the load has reached normal working condition. For example the start-up current in induction motors can be ten times the normal working current. Inrush is a 'single shot' mode that records current and voltage Trends after a current event (the trigger) has occurred. An event occurs when the current waveform exceeds adjustable limits. The display builds up from the right of the screen. Pretrigger information allows you to see what occurred in advance of the inrush.

Inrush Trend Display

To access the Inrush Trend screen:

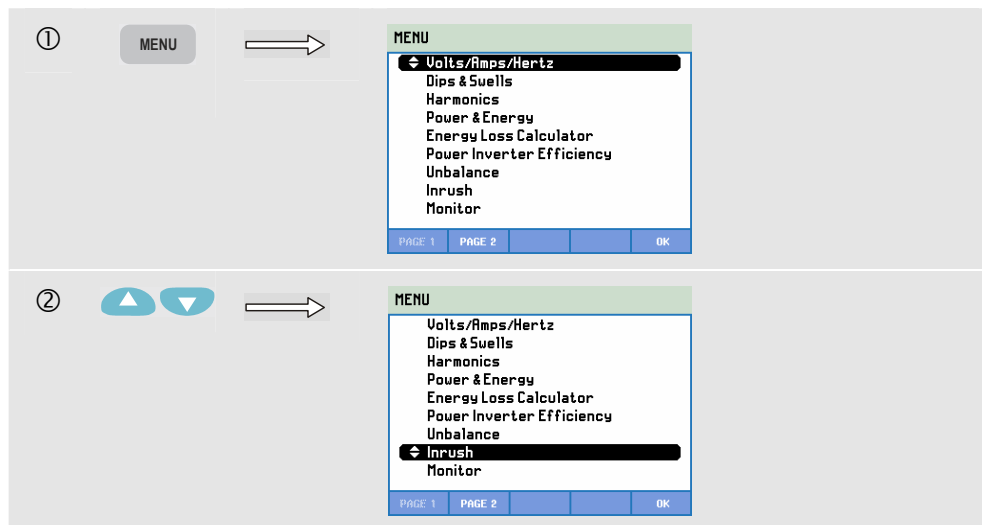

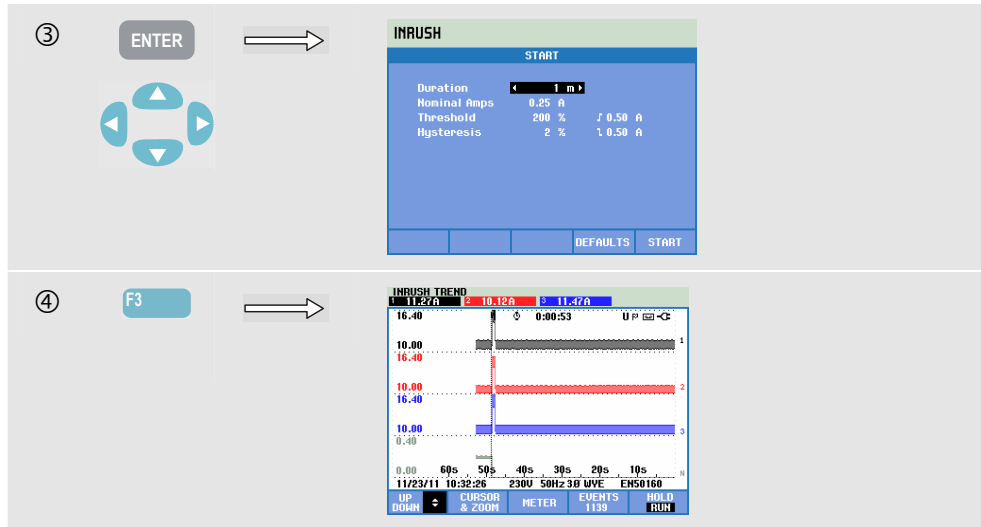

Use the arrow keys in the Start menu to adjust the trigger limits: expected inrush time, nominal current, threshold, and hysteresis. The maximum current determines the vertical height of the current display windows. Threshold is the current level that triggers the trend capture. The screen header displays the rms of all rms values during the inrush time. If the Cursor is on, the rms measuring values at the Cursor are displayed. A Meter screen shows half cycle rms for voltage ($V_{rms} \frac{1}{2}$) and current ($A_{rms} \frac{1}{2}$).

Set the duration to a value higher than the expected inrush duration to assure that the event is completely captured. Duration is selectable from 1 to 45 minutes.

The inrush starts when the $A_{rms} \frac{1}{2}$ of one of the phases is higher than the threshold. The inrush ends when the $A_{rms} \frac{1}{2}$ is lower than the threshold minus the hysteresis. The inrush duration is indicated with markers on screen and shown as a duration reading in the Trend screen. The inrush value is the rms value between the markers and is measured on each phase simultaneously.

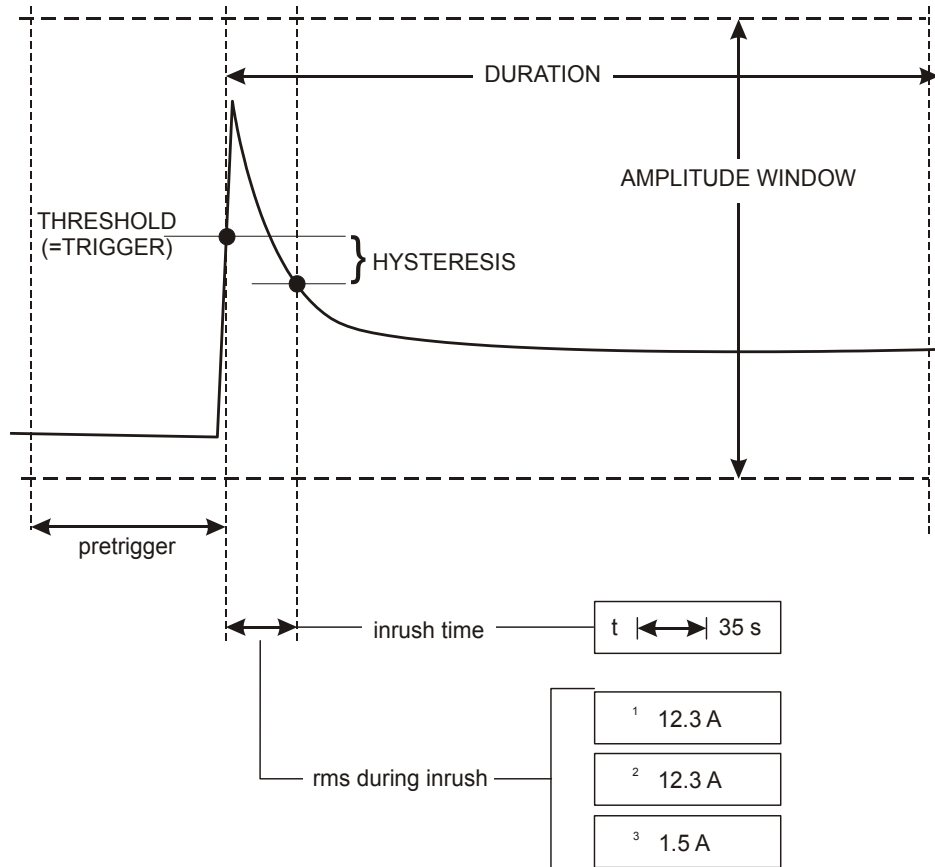

Figure 15-1. Inrush characteristics and relation with start menu

Use Cursor and Zoom to investigate details of the recorded Trends. Selection of channels to be displayed is done with the up/down arrow keys. Press function key F1 to assign the arrow keys to this.

The adjustment menu is reached via the SETUP key, F4 – MANUAL SETUP, F3 – FUNCTION PREF., and F2 – INRUSH. You can set up the default values of the trigger limits (expected inrush time, nominal current, threshold, hysteresis).

To set Offset and Span of the half cycle rms voltage and current Trend display press SETUP key, F4 – MANUAL SETUP, F1 – TREND SCALE. For detailed information see Chapter 23, FUNCTION PREFERENCES.

Available function keys:

F1	Up/down arrow keys are assigned to scroll Meter screen.
F2	Access to cursor and zoom menu.
F3	Access to Meter screen showing half cycle rms for voltage and current.
F4	Access to Events menu. The number of events that occurred is shown.
F5	Switch between HOLD and RUN of screen update. Switching from HOLD to RUN invokes a menu to select immediate (NOW) or TIMED start time which allows you to define start and duration of the measurement.

Tips and Hints

Check the peak currents and their duration. Use the Cursor for readout of momentary values. Check if fuses, circuit breakers, and conductors in the power distribution system can withstand the inrush current during this period. Check also if phase voltages stay stable enough.

High peak currents can cause circuit breakers to trip unexpectedly. Measuring Inrush Current can help in setting trip levels. Since the Analyzer simultaneously captures Inrush Current and Voltage Trends you can use this measurement to check voltage stability as large loads come on line.

Use event capture on Arms $\frac{1}{2}$ to capture high resolution voltage and current rms trends and to capture waveform signals. This feature is available in Fluke 435-II and 437-II and can display a 7.5 second trend and a 1 second waveform. To activate this press SETUP, F4 – MANUAL SETUP, F3 – FUNCTION PREF., F1- WAVE CAPTURE. Then select AMPS 0.50 A with the up/down arrow keys and press ENTER to activate.

Chapter 16

Monitor - Power Quality Monitoring

Introduction

Power Quality Monitoring or System Monitor displays a Bar graph screen. This screen shows whether important Power Quality parameters meet requirements. Parameters include:

1. RMS voltages
2. Harmonics
3. Flicker
4. Dips/Interruptions/Rapid Voltage Changes/Swells (DIRS)
5. Unbalance/Frequency/Mains Signaling.

Monitor is started via a menu to select immediate or timed start of the measurement. When selecting timed start, synchronisation with the 10 minute real time clock is used. Timed start in combination with the optional GPS Synchronisation Unit GPS430 will give Class A timing accuracy.

Figure 16-1 shows the bar graph screen and its properties.

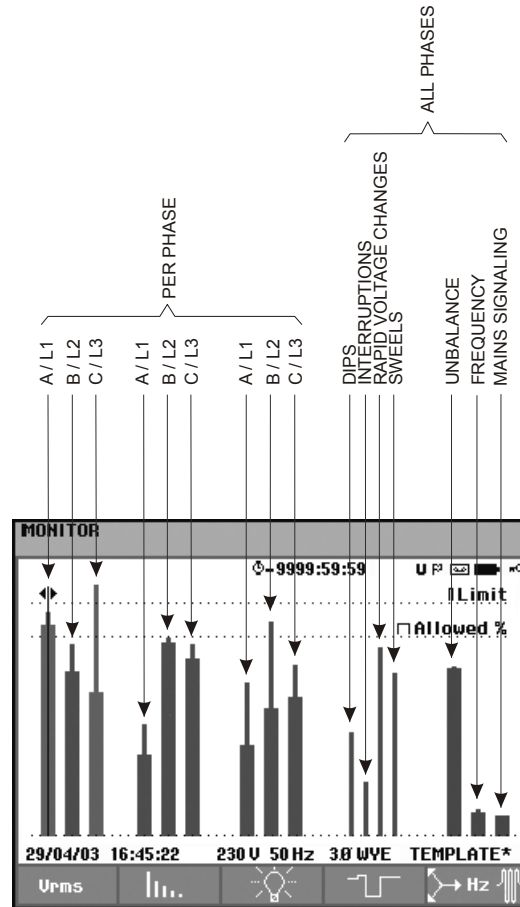

Figure 16-1. Power Quality Monitor Main Screen

The length of a bar increases if the related parameter is further away from its nominal value. The bar turns from green to red if an allowed tolerance requirement is violated.

Use the left/right arrow keys to position the cursor on a particular bar and measuring data belonging to that bar is displayed in the screen header.

Power Quality Monitoring is usually done during a long observation period. Minimum duration of the measurement is 2 hours. An usual measuring period is 1 week.

The Power Quality parameters rms voltages, Harmonics, and Flicker have a bar for each phase. From left to right these three bars are related to the phases A (L1), B (L2), and C (L3).

The parameters Dips/Interruptions/Rapid Voltage Changes/Swells and Unbalance/Frequency have a single bar for each parameter representing performance across three phases.

For Mains Signaling there is a single bar in the Main screen representing performance across three phases and for frequency 1 and 2. Separate bars per phase and for frequency 1 and 2 are available in the submenu under Function key F5.

Most of the Bar Graphs have a wide base indicating adjustable time related limits (for instance 95 % of time within limit) and a narrow top indicating a fixed 100 % limit. If one of both limits is violated, the related bar changes from green to red. Dotted horizontal lines on the display indicate the 100% limit and the adjustable limit.

The meaning of the bar graphs with a wide base and a narrow top is explained below. By way of example this is done for the rms voltage. This voltage for instance has a nominal value of 120 V with a tolerance of + and – 15% (tolerance range between 102 ... 138 V).

The momentary rms voltage is constantly monitored by the Analyzer. It calculates an average from these measuring values across 10-minute observation periods. The 10-minute averages are compared against the tolerance range (in this example 102 ... 138 V).

The 100 % limit means that the 10-minute averages must always (i.e. 100 % of time or with 100 % probability) be within range. The bar graph will turn to red if a 10-minute average crosses the tolerance range.

The adjustable limit of for instance 95 % (i.e. 95 % probability) means that 95 % of the 10-minute averages must be within tolerance. The 95 % limit is less stringent than the 100 % limit. Therefore the related tolerance range usually is tighter. For 120 V this for instance can be + or – 10 % (a tolerance range between 108 ... 132 V).

The bars for Dips/Interruptions/Rapid Voltage Changes/Swells are narrow and indicate the number of limits violations that occurred during the observation period. The allowed number is adjustable (for instance to 20 Dips/week). The bar turns to red if the adjusted limit is violated.

You can use a pre-defined set of limits or define your own. The pre-defined set is that according to the EN50160 standard. You can define your own set of limits and save it in memory under a user-definable file name. As a basis for this set you can use EN50160 or any other set. Refer to Chapter 23 Paragraph Limits Adjustments for a description.

The table below gives a survey of the aspects of Power Quality Monitoring:

Parameter	Available Bar Graphs	Limits	Averaging Interval
Vrms	3, one for each phase	Probability 100 %: upper & lower limit Probability x %: upper & lower limit	10 minutes
Harmonics	3, one for each phase	Probability 100 %: upper limit Probability x %: upper limit	10 minutes
Flicker	3, one for each phase	Probability 100 %: upper limit Probability x %: upper limit	2 Hrs.
Dips/Interruptions/Rapid Voltage Changes/Swells	4, one for each parameter covering all 3 phases	allowed number of events per week	½ cycle rms based
Unbalance	1, covering all 3 phases	Probability 100 %: upper limit Probability x %: upper limit	10 minutes
Frequency	1, covering all 3 phases Measured on Reference Voltage Input A/L1	* Probability 100 %: upper & lower limit Probability x %: upper & lower limit	10 sec.
Mains Signaling	6, one for each phase, for freq 1 and freq 2	* Probability 100 % upper limit: N/A Probability x %: upper limit: adjustable	3 sec. rms

Power Quality Main Screen

To access the Power Quality Main screen:



Power Quality Monitoring is reached via the MONITOR selection under the MENU key. A start menu allows for Immediate or Timed start. With the left/right arrow keys you can position the Cursor on a particular Bar Graph. Measuring data belonging to the bar is shown in the screen header.

Detailed measurement data is available under the Function keys:

F1	RMS voltage: trends, events table.
F2	Harmonics: bar graphs, events table, trends.
F3	Flicker: trends, events table.
F4	Dips, Interruptions, Rapid voltage changes, and Swells: trends, events table.
F5	Unbalance, Frequency, and Mains Signaling: bar graphs per Mains Signaling frequency/phase, trends, events table.

The measurement data available under the Function keys is explained in the following sections. Data is presented in the formats Events Table, Trend Display, and Bar Graph screen.

Trend Display

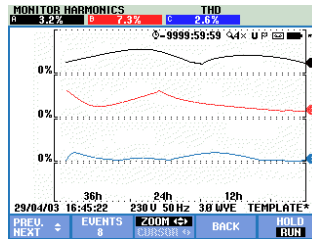

Figure 16-2. Trend Display

The Trend screen shows the changes over time of measuring values. Zoom and Cursor are available to examine Trend details. Zoom and Cursor are operated by the arrow keys and explained in Chapter 22.

Available function keys:

F1	Up/down arrow keys are assigned to scroll Trend screen.
F2	Access to Events menu. The number of events that occurred is shown.
F3	Access to cursor and zoom menu.
F4	Return to bar graph screen.
F5	Switch between HOLD and RUN of screen update. Switching from HOLD to RUN invokes a menu to select immediate (NOW) or TIMED start time which allows you to define start and duration of the measurement.

Events Table

DATE	TIME	TYPE	LEVEL	DURATION
11/28/11	11:01:55:800	A DIP	98.3 U	0:00:00:058
11/28/11	11:01:56:021	A DIP	98.3 U	0:00:00:058
11/28/11	11:01:56:187	A DIP	98.3 U	0:00:00:041
11/28/11	11:01:56:336	A DIP	98.3 U	0:00:00:041
11/28/11	11:01:56:503	A DIP	98.3 U	0:00:00:025
11/28/11	11:01:56:636	A DIP	98.3 U	0:00:00:057
11/28/11	11:01:56:747	A DIP	98.3 U	0:00:00:025
11/28/11	11:01:56:913	A DIP	98.3 U	0:00:00:041
11/28/11	11:01:58:079	A DIP	98.3 U	0:00:00:057
11/28/11	11:01:58:262	A DIP	98.3 U	0:00:00:042
11/28/11	11:01:59:413	A DIP	98.3 U	0:00:00:240

Figure 16-3. Events Table







The events table shows the events that occurred during the measurement with date/time of start, phase, and duration. The amount of information in the table can be selected with the Function key F3.

Normal lists the major event characteristics: start date/time, duration, event type, and magnitude.





Detail gives information on threshold crossings for each phase of an event.

Wave event shows a scope waveform around the selected event. RMS event shows the ½ cycle rms trend around the selected event. Wave event and rms event are available in Fluke 435-II and 437-II.

The following Abbreviations and Symbols are used in the tables:

Abbreviation	Meaning	Symbol	Meaning
CHG	Rapid Voltage Change		High value of 100 % limit has been violated
DIP	Voltage Dip		Low value of 100 % limit has been violated
INT	Voltage Interruption		High value of x % limit has been violated
SWL	Voltage Swell		Low value of x % limit has been violated
Hx	Number of the harmonic that violated its limits		Unbalance event
TRA	Transient		Change upwards
AMP	Amp value exceeded		Change downwards

Available function keys:

	Switch to wave event display: this will show a 4 cycle waveform around the selected event. Available in HOLD.
	Switch to rms event display: this will show the ½ cycle rms trend around the selected event. Available in HOLD.
	Switch between Normal and Detailed events table.
	Return to previous menu.

Two ways to access Trend:

1. Use the up/down arrow keys to highlight an event in the table. To access Trend press the ENTER key. The Cursor is on, in the mid of screen and located on the selected event. Zoom is set to 4.
2. Press Function key F4 to view the Trend part showing the most recent measuring values. Cursor and Zoom can be switched on afterwards when required.

Measurement specific features:

- Vrms events: an event is recorded each time that a 10 minute aggregated RMS value violates its limits.
- Harmonics events: an event is recorded each time a 10 minute aggregated harmonic or THD violates its limit.
- Flicker events: an event is recorded each time Plt (long term severity) violates its limit.
- Dips/Interruptions/Rapid Voltage Changes/Swells events: an event is recorded each time one of the items violates its limits.
- Unbalance, Frequency events: an event is recorded each time that a 10 minute aggregated rms value violates its limits.

Bar Graph Screen

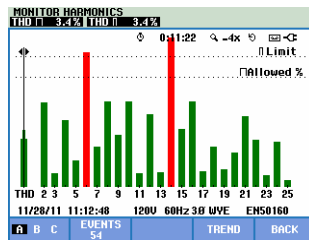

Figure 16-4. Bar Graph Screen

The main system monitor display shows the strongest harmonic for each of the three phases. Function key F2 brings up a screen with Bar Graphs showing the percentage of time each phase spent within limits for 25 harmonics and Total Harmonic Distortion (THD). Each Bar Graph has a wide base (representing an adjustable limit of e.g. 95 %) and a narrow top (representing the limit of 100 %). A Bar Graph changes from green to red if the limits for that harmonic are violated.

Cursor: with the left/right arrow keys you can position the Cursor on a particular Bar Graph and measuring data belonging to that bar is shown in the screen header.

Available function keys:

F1	Selection of Bar Graphs belonging to phase A (L1), B (L2), or C (L3).
F2	Access to events table. The number of events that occurred is shown.
F4	Access to Trend screen.
F5	Return to main menu.

Tips and Hints

Monitor is intended to perform a quality check over a long period up to one week. For compliance to international standards averaging time for Vrms and Harmonics are 10 minutes. This allows you to obtain a good impression of power quality, but is less suitable for troubleshooting. For troubleshooting the measuring functions like Dips and Swells or Logger are more suitable.

Chapter 17

Flicker

Introduction

Flicker is available in **Fluke 435-II and 437-II**. It quantifies the luminance fluctuation of lamps caused by supply voltage variations. The algorithm behind the measurement meets EN61000-4-15 and is based on a perceptual model of the human eye / brain sensory system. The Analyzer converts duration and magnitude of voltage variations into an ‘annoyance factor’ caused by the resulting flicker of a 60 W lamp. A high flicker reading means that most people would find the luminance changes irritating. The voltage variation can be relatively small. The measurement is optimized to lamps powered by 120 V / 60 Hz or 230 V / 50 Hz. Flicker is characterized per phase by the parameters shown in a Meter screen. The related Trend screen shows the changes in all measuring values in the Meter screen.

Note: Flicker is not available for measurements in 400 Hz power systems such as offered in Fluke 437-II.

Meter screen

To access the Flicker Meter screen:

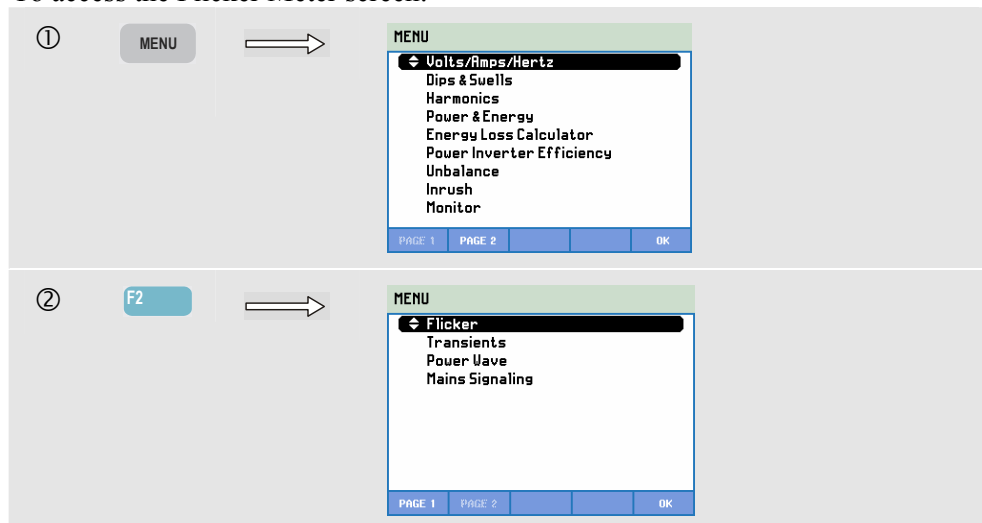

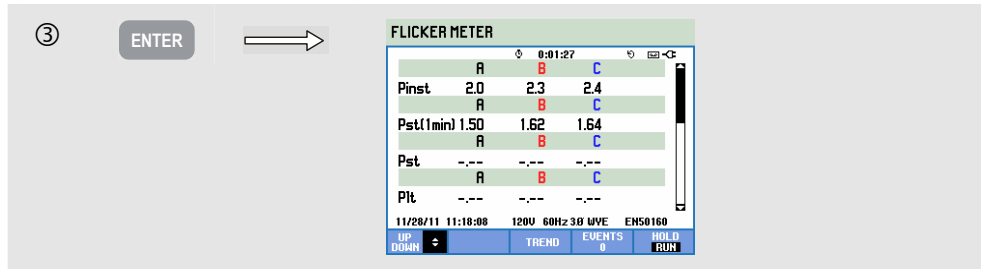

Flicker is characterized by: instantaneous flicker Pinst, short term severity Pst (measured over 1 min for fast feedback), short term severity Pst (measured over 10 min) and a long term severity Plt (measured over 2 hours). Also related data such as half cycle rms for voltage ($V_{rms} \frac{1}{2}$), current ($A_{rms} \frac{1}{2}$) and frequency are measured.

Available function keys (popup Meter screen must be off):

F1	Up/down arrow keys are assigned to scroll Meter screen.
F3	Access to Trend screen. For description see below.
F4	Access to Events menu. The number of events that occurred is shown.
F5	Switch between HOLD and RUN of screen update. Switching from HOLD to RUN invokes a menu to select immediate (NOW) or TIMED start time which allows you to define start and duration of the measurement.

Trend

To access Flicker Trend screen:

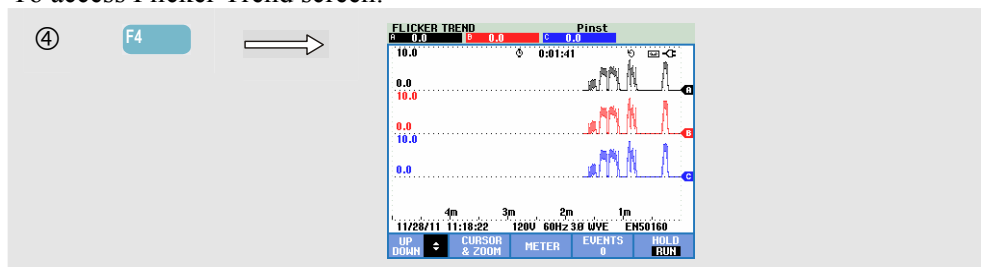

The parameters in the Meter screen update over time. They are recorded whenever the measurement is on. Trend displays the changes in these values over time. All values in the Meter screen are recorded, but the Trends from each row in the Meter screen are displayed one at a time. The arrow keys are assigned to scroll the trend screen. The Trend display may consist of 6 screens.

Available function keys:

F1	Up/down arrow keys are assigned to scroll the Trend screen..
----	--

F2	Access to cursor and zoom menu.
F3	Return to Meter screen.
F4	Access to Events menu. The number of events that occurred is shown.
F5	Switch between HOLD and RUN of screen update. Switching from HOLD to RUN invokes a menu to select immediate (NOW) or TIMED start time which allows you to define start and duration of the measurement.

Cursor. When the Cursor is on, the Trend values at the Cursor are displayed in the screen header. Moving the Cursor off the left or right side of the screen brings the next of six screens into the viewing area. This functions in HOLD mode only.

Zoom. Allows you to expand or shrink the display vertically or horizontally to view details or to fit a complete graph within the screen area. Zoom and Cursor are operated by the arrow keys and explained in Chapter 22.

Offset and Span are auto ranging for a good display in most cases, but they are adjustable. The adjustment menu is reached via the SETUP key, F4 – MANUAL SETUP, F1 – TREND SCALE. The lamp model can be adjusted via the SETP key, F4 – MANUAL SETUP, F3 - FUNCTION PEF. Use the up/down arrow keys to select Flicker Lamp model and the left/right arrow keys to select the desired model. See Chapter 23, FUNCTION PEFerences.

Tips and Hints

Use instantaneous flicker (Pinst) trend and half-cycle voltage or current trends to find the source of flicker. Use the arrow keys to select flicker, voltage, and current trends.

The 10 min (Pst) uses a longer measuring period to eliminate the influence of random voltage variations. It is also long enough to detect interference from a single source with a long working cycle such as electrical household appliances, and heat pumps.

A measuring period of 2 hours (Plt) is useful when there may be more than one interference source with irregular working cycles and for equipment such as welding machines, and rolling mills. $Plt \leq 1.0$ is the limit used in standards like EN15160.

Chapter 18 Transients

Introduction

Fluke 435-II and 437-II can capture waveforms at high-resolution during a variety of disturbances. The Analyzer will give a snapshot of the voltage and current waveforms at the precise time of the disturbance. This allows you to see the waveforms during dips, swells, interruptions, current swells and transients.

In Transients mode the Analyzer uses a special setting of its input circuit to allow capturing signals up to 6 kilovolt in amplitude.

Transients are fast spikes on the voltage waveform. Transients can have so much energy that sensitive electronic equipment can be affected or even damaged. The Transients screen looks similar to that of Scope Waveform, but its vertical span is enlarged to make voltage spikes visible that are superimposed on the 60 or 50 Hz sinewave. A waveform is captured each time that the voltage (or rms current) exceeds adjustable limits. A maximum of 9999 events can be captured. The sample rate for transient detection is 200 kS/s.

Transients also has a Meter mode showing half cycle rms for voltage ($V_{rms} \frac{1}{2}$), current ($A_{rms} \frac{1}{2}$), and frequency. Also an Events table is available.

Waveform Display

To access the Transients Waveform screen:

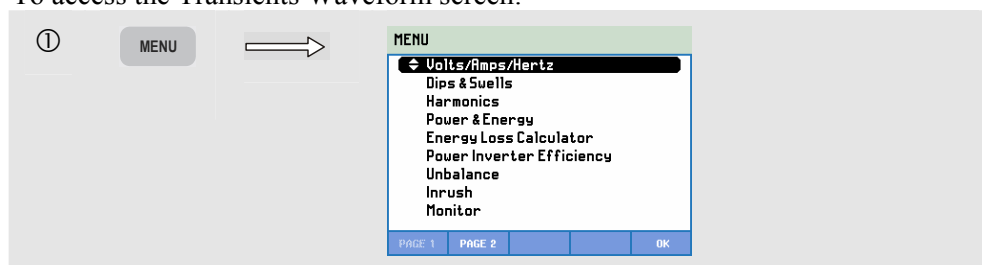



In the Start menu you can choose a trigger event or a combination of trigger events, transients (Volt) and current (AMP) trigger level, and Immediate or Timed start of the measurement.

The Analyzer can be set up to capture waveforms each time it sees: Voltage Transient, Voltage Swell, Voltage Dip, Voltage Interruption or Current swell. Dips (sags) and swells are fast deviations from the nominal voltage. The duration of a transient must be 5 microseconds or more. The display window showing the transient is 4 cycles. A total of 50 or 60 (50/60 Hz) cycles will be captured. The cursor can be used to scroll these. During a dip the voltage sinks, and during a swell the voltage rises. During an interruption the voltage falls to only a few percent of its nominal value. A current swell is a current increase from one cycle to several seconds in duration.

Trigger criteria such as threshold and hysteresis are adjustable. Criteria that are also used for Power Quality Monitor: this adjustment can be considered as default setup and is reached via the SETUP key, F4 – MANUAL SETUP, use the up/down arrow keys to select 'limits' and press ENTER. Adjustment for transient level dV/dt and Arms are available in the Start screen.

Cursor and Zoom can be used to investigate details of captured waveforms.

Available function keys:

F1	Up/down arrow keys are assigned to scroll Trend screen.
F2	Access to cursor and zoom menu.
F3	Access to Meter screen.
F4	Access to Events menu. The number of events that occurred is shown.
F5	Switch between HOLD and RUN of screen update. Switching from HOLD to RUN invokes a menu to select immediate (NOW) or TIMED start time which allows you to define start and duration of the measurement.

Tips and Hints

Disturbances such as transients in a power distribution system can cause malfunctions in many types of equipment. For example, computers may reset and equipment subjected to repeated transients can eventually fail. Events occur intermittently, making it necessary to monitor the system for a period of time to find them. Look for voltage transients when electronic power supplies are failing repeatedly or if computers reset spontaneously.

Chapter 19

Power Wave

Introduction

In this measuring mode that is available in **Fluke 435-II and 437-II** the Analyzer functions as an 8 channel scope recorder that records high resolution waveforms in a single shot acquisition. The function records half cycle rms values on 8 channels, frequency and instantaneous power ($V_{rms}^{1/2}$, $A_{rms}^{1/2}$, W, Hz and scope waveforms for Voltage, Amps, Watts).

Note: Power Wave records a long waveform while Scope Waveform displays 4 periods of the momentary waveform.

Waveform Display

To access the Power Waveform screen:

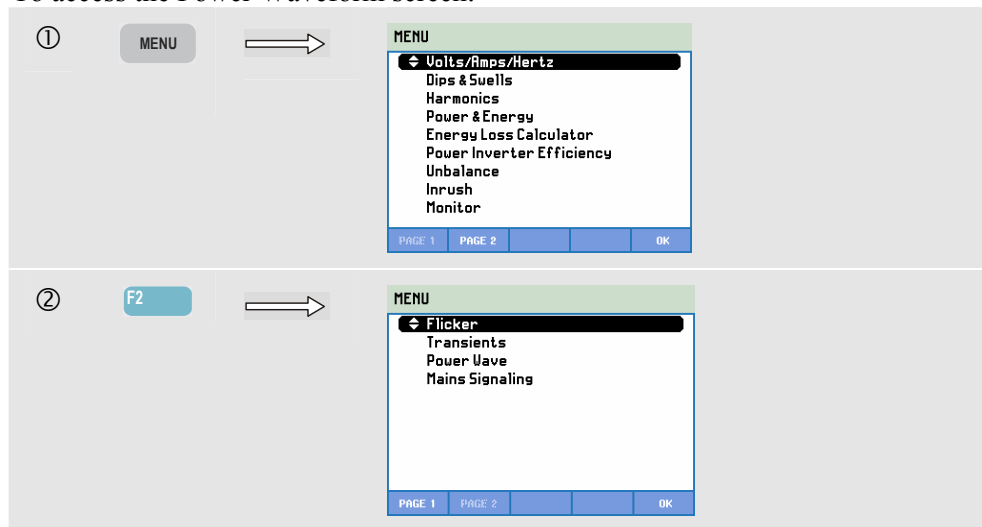

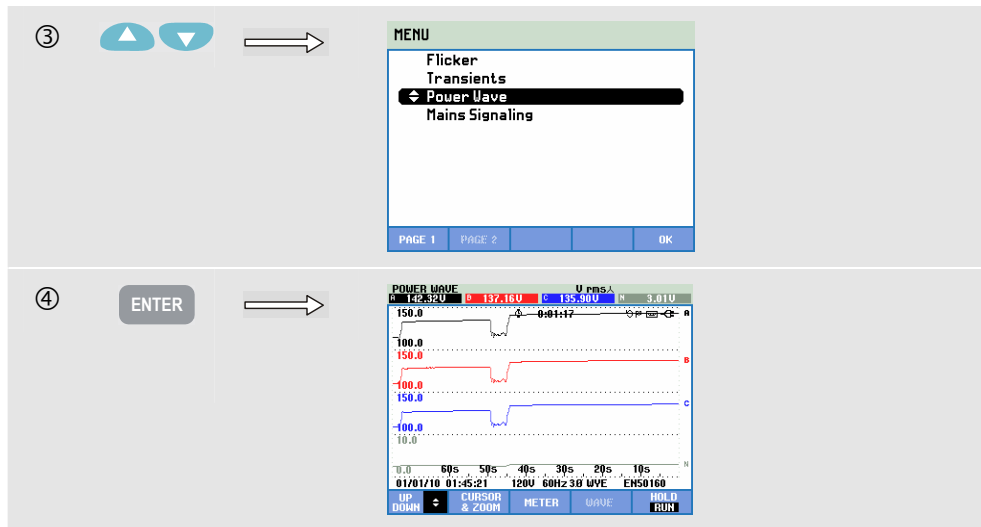

The traces build up from the right side. Readings in the header correspond to the most recent values plotted on the right. With the up/down arrow keys you can select all available trends.

Available function keys:

F1	Up/down arrow keys are assigned to select a set of trends and the belonging readout.
F2	Access to cursor and zoom menu.
F3	Access to meter screen. For description see below.
F4	Access to waveform screen. Analyzer must be in HOLD mode. For description see below.
F5	Switch between HOLD and RUN of screen update. Switching from HOLD to RUN invokes a menu to select Immediate or Timed Start and Duration of the measurement.

Cursor. When the Cursor is on, the Trend values at the Cursor are displayed in the screen header. Moving the Cursor off the left or right side of the screen allows scrolling of the trend on screen. Cursor is only active in Hold.

Zoom. Allows you to expand or shrink the display vertically to view details or to fit a complete graph within the screen area. Zoom and Cursor are operated by the arrow keys and explained in Chapter 22.

Offset and Span of the Trends are auto ranging for a good display in most cases, but they are adjustable. The adjustment menu is reached via the SETUP key and function key F3 – FUNCTION PREF. See Chapter 23, FUNCTION PREFERENCEs.

Meter screen

To access the Power Wave Meter screen:

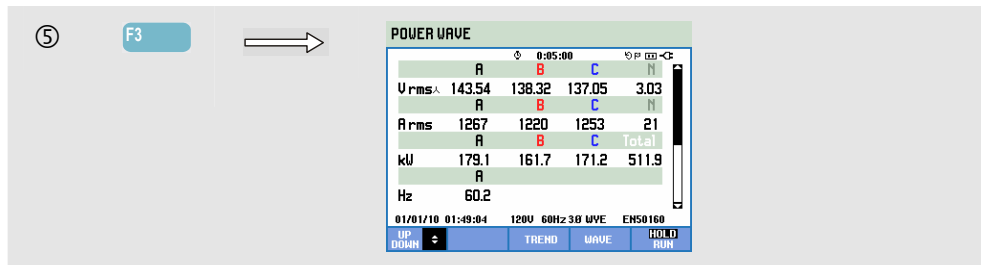

Available function keys:

F1	Up/down arrow keys are assigned to scroll meter screen.
F3	Access to Trend screen.
F4	Access to waveform screen. Analyzer must be in HOLD mode. For description see below.
F5	Switch between HOLD and RUN of screen update. Switching from HOLD to RUN invokes a menu to select Immediate or Timed Start and Duration of the measurement.

Waveform screen

To access the Power Wave Waveform screen:

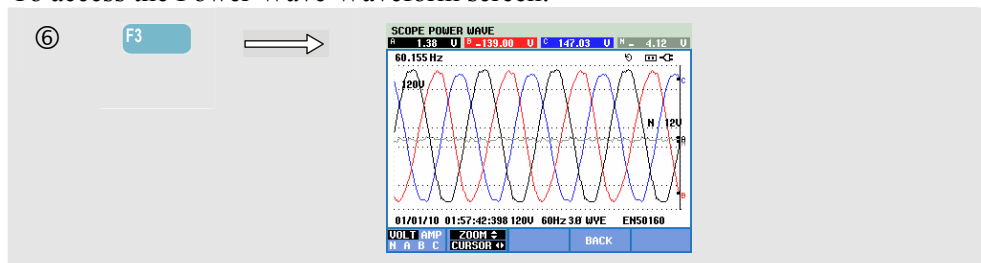

Use the left/right arrow keys to move the cursor and to scroll all recorded waveforms. The maximum recording time is about 5 minutes. The time of the displayed waveform is shown in the status line in the bottom of the screen.

Starting from the Trend screen, position the cursor on the area of interest. Then press F3 – WAVE to open waveform display at this area.

Available function keys:

F1	Selection of waveform set to be displayed: VOLT displays all voltages, AMP displays all currents. A (L1), B (L2), C (L3), N (neutral) give simultaneous display of phase voltage and current for the selected phase.
F2	Access to cursor and zoom menu.
F4	Return to previous screen.

Tips and Hints

Power Wave records high resolution waveforms during a time span of several minutes. This allows you to monitor the influence of sudden load changes on voltage and current waveforms. An example is switch on or off of big motors or welding machines. Big voltage changes may indicate a weak power distribution system.

Chapter 20

Mains Signaling

Introduction

Mains Signaling is a function available in **Fluke 435-II and 437-II**. Power distribution systems often carry control signals to switch appliances on and off remotely (also known as ripple control). These control signals have a frequency that is higher than the normal 50 or 60 Hz line frequency and range up to about 3 kHz. Amplitude is significantly lower than that of the nominal line voltage. The control signals are present only at the moments that a remote appliance has to be controlled.

In Mains Signaling mode the 435-II and 437-II can capture the occurrence (signal level) of control signals with 2 different frequencies. The frequency range is 70.0 – 3000.0 Hz for 60 Hz systems and 60.0 – 2500.0 Hz for 50 Hz systems.

Selection of Frequency 1 and frequency 2 is attainable via key sequence SETUP, F4 – MANUAL SETUP, select Limits with the up/down arrow keys, ENTER, F3 – EDIT, select Mains Signaling with the up/down arrow keys, and press ENTER. Next use the arrow keys to adjust Frequency 1 and 2.

The Duration of the measurement and Immediate or Timed start are selectable after a measurement is set from HOLD to RUN.

Measuring results are presented in a Trend screen and in an Events Table.

Note: Mains Signaling is not available for measurements in 400 Hz power systems such as offered in Fluke 437-II.

Trend

To access the Mains Signaling Trend screen:

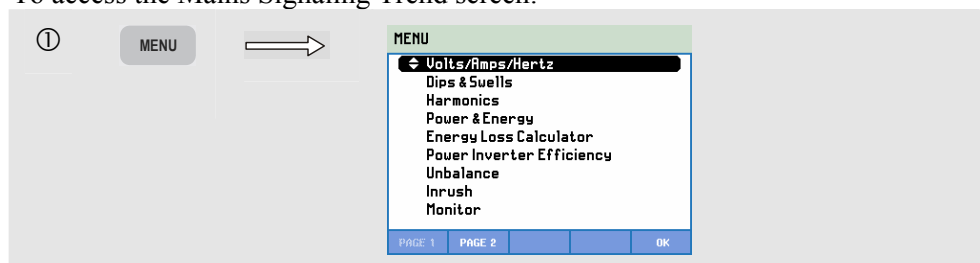

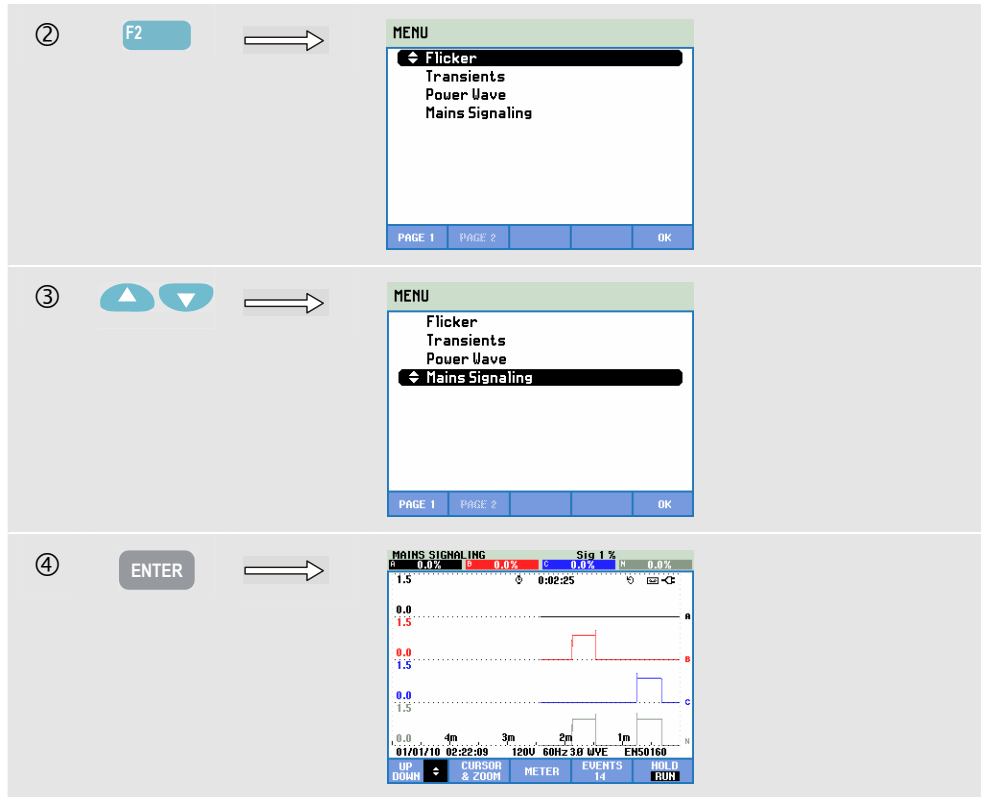

The traces build up from the right side. Readings in the header correspond to the most recent values plotted on the right. With the up/down arrow keys you can select readout as a percentage of nominal line voltage or as a 3 second average voltage (V3s). The Neutral conductor is not used for Mains Signaling, but is shown for troubleshoot purposes.

Available function keys:

F1	Up/down arrow keys are assigned to select a set of trends and the belonging readout.
F2	Cursor on/off.
F3	Assign the arrow keys to Cursor or Zoom operation.
F4	Access to Events tables.
F5	Switch between HOLD and RUN of screen update. Switching from HOLD to RUN invokes a menu to select Immediate or Timed Start and Duration of the measurement.

Cursor. When the Cursor is on, the Trend values at the Cursor are displayed in the screen header. Moving the Cursor off the left or right side of the screen allows scrolling of the trend on screen.

Zoom. Allows you to expand or shrink the display vertically or horizontally to view details or to fit a complete graph within the screen area. Zoom and Cursor are operated by the arrow keys and explained in Chapter 22.

Offset and Span of the Trends are auto ranging for a good display in most cases, but they are adjustable. The adjustment menu is reached via the SETUP key and function key F3 – FUNCTION PREF. See Chapter 23, FUNCTION PREFERENCES.

Events Table

To access the Mains Signaling events table:

DATE	TIME	TYPE	LEVEL	DURATION
04/10/06	10:24:44.834	B	SIG2	13.8 U 0:00:41.291
04/10/06	10:36:20.882	B	SIG2	13.8 U 0:00:40.892
04/10/06	10:38:16.578	B	SIG2	13.8 U 0:00:51.863
04/10/06	10:39:51.527	C	SIG2	13.8 U 0:00:45.681
04/10/06	10:41:42.236	C	SIG2	13.8 U 0:00:19.151

01/01/10 02:22:56 120V 60Hz 3Ø WVE EN50160

WAVE EVENT RMS EVENT NORMAL BACK

The events table shows in Normal mode the events (V3s above the limit) that occurred during the measurement. Date, time, type (phase, signal 1 or signal 2), level and duration of each event are listed. In Detail mode additional information is given on threshold crossings.

Available function keys:

F3	Switch between Normal and Detailed events table.
F4	Return to next higher menu.
F5	Access to Trend screen. Two ways to access Trend are explained below.

Two ways to access Trend:

1. Use the up/down arrow keys to highlight an event in the table. To access Trend press the ENTER key. The Cursor is on, in the mid of screen and located on the selected event.
2. Press Function key F5 to view the Trend part showing the most recent measuring values. Cursor and Zoom can be switched on afterwards when required.

Tips and Hints.

To capture control signals it is essential to know their frequencies in advance. Consult the Internet Website of your local energy supplier for information on what frequencies are used for Mains Signaling in your area.

EN 50160 shows the 'Meister_Kurve' for the allowed 3 second average voltage V3s as a function of frequency. Limits should be programmed accordingly.

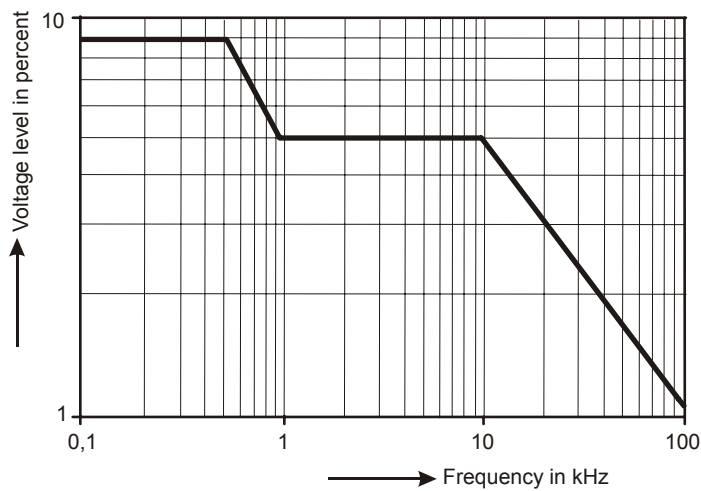

Figure 20-1. Meister Kurve acc. to EN50160

Chapter 21

Logger

Introduction

Logger is a function that gives you the possibility to log multiple readings with high resolution. The readings are observed during adjustable time intervals. At the end of the interval the min, max, and average values of all readings are stored and the next observation interval starts. This process continues for the Duration of the observation period.

The Analyzer has as a default a predefined set of readings that is used for logging. This set can be customized to your own set of readings. Via the Setup Readings from the logger start menu you can Add or Remove readings to be logged.

You start the Logging function from the Start menu that allows you to select the Interval time (0.25 s – 2 Hr.), the readings to be logged, the maximum duration of the logging (1 Hr. – Max) and Immediate or Timed start of logging.

Readings are displayed in a Meter screen, a Trend screen, and an Events Table.

Start Menu

To access the Logger Start Menu:

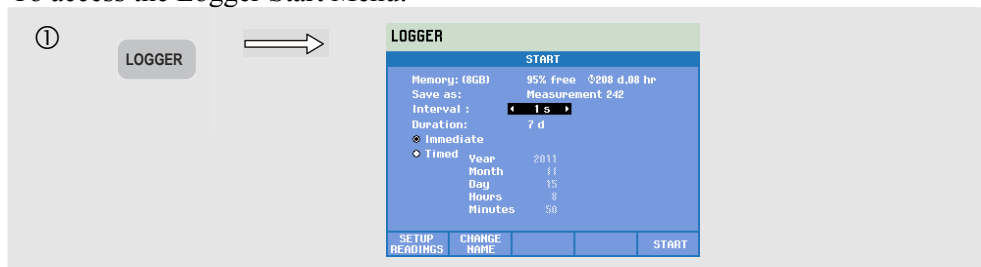

The set of readings to be logged is selectable in the menu under function key F1 – SETUP READINGS.

With the up/down arrow keys you can select the Category of readings to be logged. These Categories are listed in Column 1: Volt, Amp, Power, Energy, Volt Harmonic, Amp Harmonic, Watt Harmonic, Frequency, Flicker, Unbalance, and Mains Signaling.

With the arrow keys you can select Column 2 where the readings belonging to the selected Category are listed. The readings indicated with are active readings and they

also show up in Column 3.

The readings indicated with are not active. An inactive reading can be selected with the up/down arrow keys. Next if you press F3 – ADD the reading will be added to Column 3 of selected readings. Note that in column 2 the symbol now shows up in front of the reading just selected.

With the arrow keys you can select an active reading in Column 3. Next if you press F4 – REMOVE the reading is removed from the list of active readings.

With F3 – MOVE you can move a certain reading to a higher position in the list of selected readings.

When ready press F5 – OK.

Available function keys in Start menu:

F1	Access to Readings Select menu.
F2	Access to the menu to define the name of the file with logging data.
F5	Start of the logging and access to Logging Trend screen.

Meter screen

To access the Logger Meter screen:

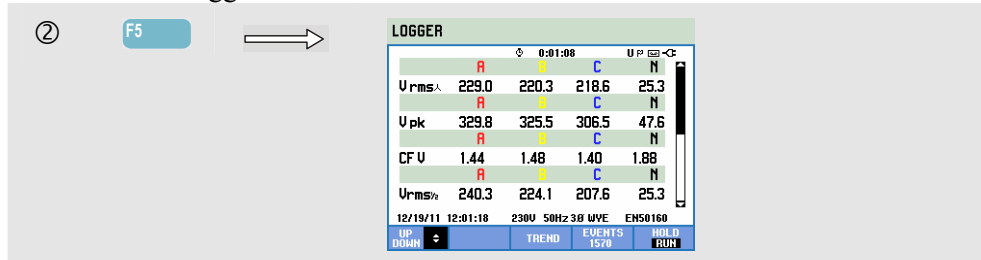

This screen displays all current readings of the logger function. Use up/down arrow keys to scroll across the Meter screen.

Available function keys:

F1	Up/down arrow keys are assigned to scroll Meter screen up/down.
F3	Access to Trend screen.
F4	Access to Events Table.
F5	Access to menu to stop the logging, or to check available memory space and to continue.

Trend

To access the Logger Trend screen:

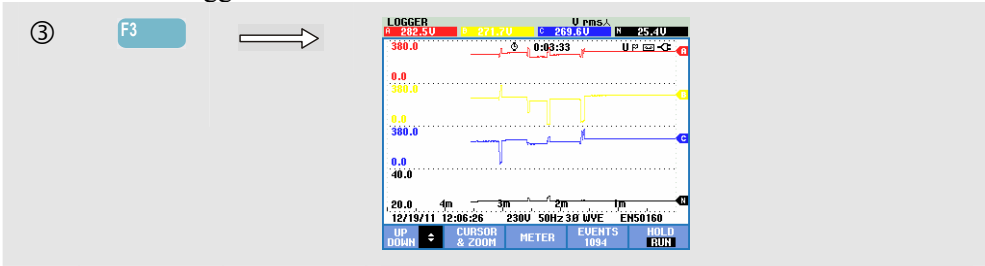

All readings are recorded during logging, but not all of them are visible at a time. Use the up/down arrow keys to make the desired set of trends visible within the viewing area.

The traces are build up from the right side. Readings in the header correspond to the most recent values plotted on the right.

Available function keys:

F1	The up/down arrow keys are assigned to select a set of loggings for Trend display. The selected set is displayed in the screen header.
F2	Access to submenu for Cursor and Zoom operation.
F3	Access to Meter screen showing momentary measuring results of all logged readings.
F4	Access to Events Table.
F5	Access to menu to stop the logging.

Cursor. When the Cursor is on, the Trend values at the Cursor are displayed in the screen header. Moving the Cursor off the left or right side of the screen brings the next screens into the viewing area. Cursor is only active in 'Hold' mode.

Zoom. Allows you to expand or shrink the display vertically or horizontally to view details or to fit a complete graph within the screen area. The min, max, and average values of the trend are displayed in the screen header if vertical zoom is expanded to one trace in the viewing area. Zoom and Cursor are operated by the arrow keys and explained in Chapter 22.

Offset and Span of the Trends are auto ranging for a good display in most cases, but they are adjustable when required. The adjustment menu is reached via the SETUP key and function key F3 - FUNCTION PREF. See Chapter 23, FUNCTION PREFERENCES

Events

To access the Logger Events Table screen:

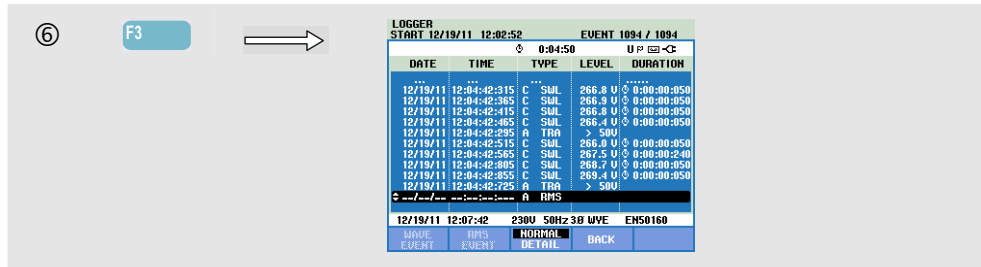





The Events table lists all threshold crossings of phase voltages. Thresholds according to international standards or user-definable thresholds can be used. Threshold adjustment is reached via the SETUP key and Limits. For detailed information see Chapter 23, Limits Adjustments.





In Normal mode major event characteristics are listed: start time, duration, and voltage magnitude. Detail shows details of threshold crossings per phase.

Wave Event shows a scope waveform around the selected event. Rms event shows the ½ cycle rms trend around the selected event. Wave event and rms event are available in Fluke 435-II and 437-II.

The following Abbreviations and Symbols are used in the tables:

Abbreviation	Description	Symbol	Description
CHG	Rapid Voltage Change		Rising voltage edge
DIP	Voltage Dip		Falling voltage edge
INT	Voltage Interruption		Change upwards
SWL	Voltage Swell		Change downwards
TRA	Transient		
AMP	Amp value exceeded		

Available function keys:

	Switch to wave event display: this will show a scope waveform around the selected event.
	Switch to rms event display: this will show the ½ cycle rms trend around the selected event.
	Switch between NORMAL and DETAILED event table.
	Return to Meter screen.

Chapter 22

Cursor and Zoom

Introduction

This chapter explains how to use Cursor and Zoom to display and investigate details of Waveform, Trend, and Bar Graph displays. Cursor and Zoom have a certain amount of interaction and are both operated by the arrow keys.

The Cursor is a vertical line that can be positioned on a point on a Waveform, Trend, or Bar Graph. The measured values at that point are displayed in the screen header.

Zoom allows you to stretch and shrink the graph to get a better view of details. Horizontal Zoom is available for Waveform and Trend.

Put the Analyzer in HOLD mode if Cursor cannot be switched on.

Cursor on Waveform Displays

As an example the Scope Waveform display is used. Cursor and Zoom for the Transients screen function in the same way.

Figure 22.1 shows the Scope Waveform display with Cursor and Zoom switched off. The screen header shows the rms values of the displayed waveforms.

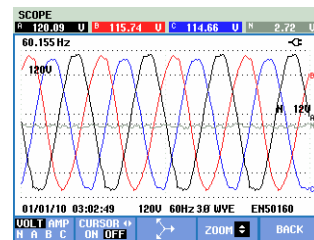

Figure 22-1. Waveform display, no cursor

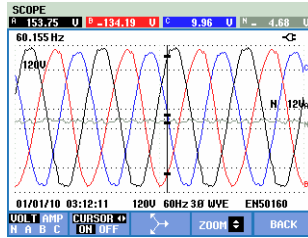

Figure 22-2. Waveform display, cursor on

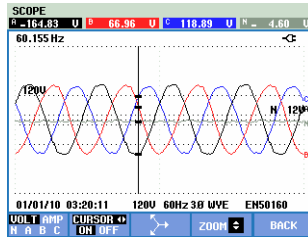

Figure 22-3. Waveform display with cursor and zoom on

To control Cursor and Zoom:

- Press F2 to switch the Cursor on. Use the left/right arrow keys to move the Cursor horizontally along the waveforms. The value of the waveforms at the Cursor is displayed in the screen header as shown in Figure 22.2.
- The up/down arrow keys zoom in vertical direction (Figure 22.3).

Cursor on Trend Displays

As an example the Volts/Amps/Hertz Trend display is used. Cursor and Zoom for other Trend displays function in the same way.

Figure 22.4 shows the Trend screen with Cursor and Zoom switched off. The screen header displays rms values of the Trends at the right screen side. This is the screen side with the most recent measuring values.

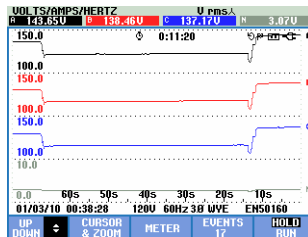

Figure 22-4. Trend display, no cursor

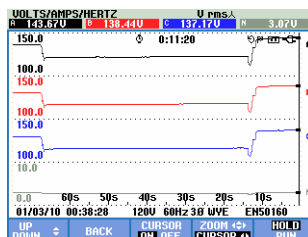

Figure 22-5. Trend display, cursor on

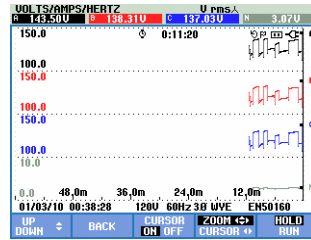

Figure 22-6. Trend display with cursor and zoom on

The Function keys F1, F2, F3 and F4 and the arrow keys are used to operate Cursor and Zoom:

- Operate F2 and F3 to switch the Cursor on (only in Hold mode). Use the left/right arrow keys to move the Cursor horizontally along the trends. The value of the trends at the Cursor is displayed in the screen header as shown in Figure 22.5. Positioning the Cursor across the left or right screen end moves the trend to the left or right.
- Press F4 to assign the arrow keys to Zoom operation. The left/right arrow keys can be used now to stretch and shrink the trends horizontally as shown in figure 22.6. The up/down arrow keys do this in vertical direction. If the Cursor is on, horizontal zoom operates symmetrically around the Cursor; when off horizontal zoom operates from the right screen side.
- Press F1 to assign the arrow keys to select the Trend line(s) to be displayed.
- Press F4 again to assign the arrow keys to Cursor operation.

From Events Table to Trend Display with Cursor On

Within an events table, you can highlight a certain event with the up/down arrow keys (only in Hold mode). Next press the ENTER key. As a result a Trend display is shown with the Cursor on and positioned on the highlighted event. The steps in this process are shown below.

The example below shows the transition from Dips & Swells events table to trend display with cursor on:

①

DIPS & SWELLS
START 01/03/10 01:22:46 EVENT 4 / 5

DATE	TIME	TYPE	LEVEL	DURATION
01/03/10	01:22:53:579	C DIP	18.4 U	0:00:01:916
01/03/10	01:22:53:613	C SWL	182.2 U	0:00:15:539
01/03/10	01:22:55:475	C TRA	> 50U	
01/03/10	01:23:19:338	C DIP	107.3 U	0:00:00:191
01/03/10	01:23:19:571	C DIP	106.1 U	0:00:00:323

01/03/10 01:23:19 120V 60Hz 3Ø WVE EMS0160

UP	DOWN	BACK	HOLD
EVENT	EVENT	EVENT	BACK

Use the arrow keys to highlight an event of interest.

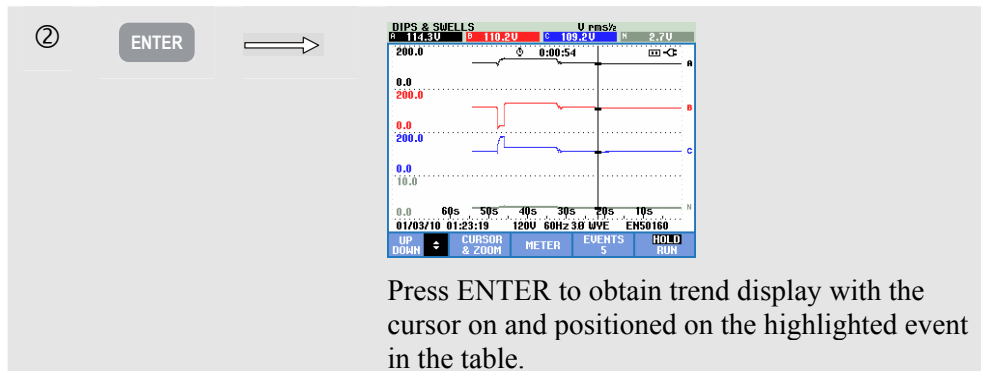

Cursor on Bar graph Displays

As an example the Three-phase Voltage Harmonics display as shown in Figure 22.7 is used. Cursor and Zoom for other Bar Graph displays function identically.

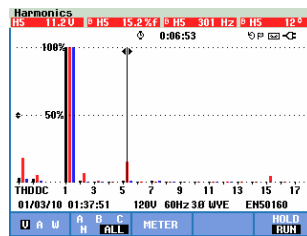

Figure 22-7. Cursor on bar graphs

On Bar Graph displays the Cursor is always on. Cursor and Zoom are operated with the arrow keys:

- Use the left/right arrow keys to position the Cursor on a certain bar. The header shows relevant measuring data belonging to the bar. In certain cases there are more bars available than can be displayed in one screen. In the figure for instance 17 harmonics out of a total of 51 are displayed. Positioning the Cursor across the left or right screen end brings the next screen within the viewing area.

Use the up/down arrow keys to stretch (or shrink) the Bar Graphs vertically.

Chapter 23

Setting up the Analyzer

Introduction

The Analyzer offers many measuring functions. These functions are preset in a way that the best possible representation of measuring results is obtained in almost all circumstances. However - if desired - the user can make personal setups that meet specific requirements. This chapter explains what setups can be made and where they can be found in the menus. Some setups will be explained step by step.

Initial setups.

When you power the Analyzer for the first time, after a Factory Default, or if it has been disconnected from all power sources, you will have to adjust a number of general settings that match your local situation. The table below gives an overview:

Setting	Preset Value
Information language	English
Nominal Frequency	60 Hz
Nominal Voltage	120 V
Phase Identification	A, B, C
Phase Colors A/L1-B/L2-C/L3-N-Ground	Black-Red-Blue-Gray-Green
Date + Date Format	Month/Day/Year
Date + Time	January 01, 2010 + 00:00:00

When ready with setup of the parameters in the table, the screen shown in Figure 23-1 is displayed. This screen gives you access to all adjustments of the Analyzer.

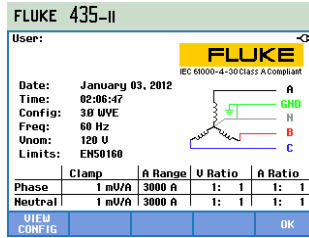

Figure 23-1. Entry screen to Analyzers setups

Power on.

At power on the welcome screen in Figure 23-2 will be displayed. This screen gives an overview of the most important settings such as: date, time, wiring configuration, nominal frequency, nominal voltage, the set of power quality limits used, and the type of voltage and current probes to be used.

Function key F1 gives access to a screen showing in detail how to connect voltage and current probes to the power system to be examined. Figure 23-3 gives an example. Press F1 again to return to the Welcome screen.

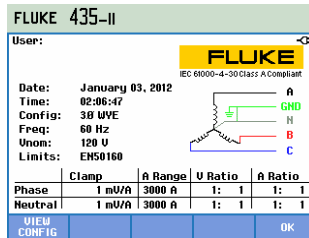

Figure 23-2. Welcome screen at power-on

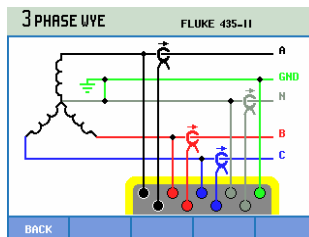
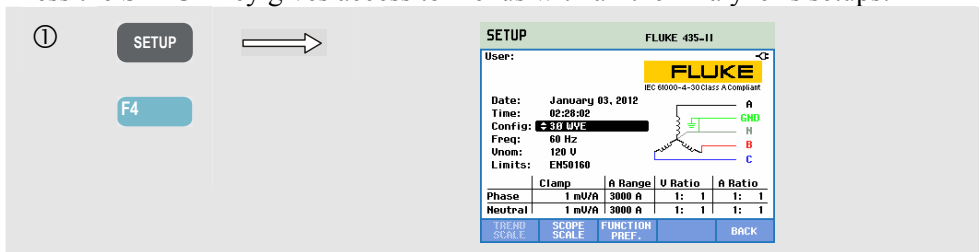







Figure 23-3. Screen showing actual wiring configuration

Press the SETUP key gives access to menus with all the Analyzer's setups:



The following keys are used for menu navigation and selections:

	Selection of the item to be adjusted.
	Press to access the selected settings menu.
	To select (up/down) and adjust (left/right) items in a settings menu. Press ENTER to confirm a selection.
	Selections or access to submenus.
	Return to previous menu.

The Settings are grouped in four functional sections and are explained accordingly in four sections of this manual chapter:

- *USER PReFerences*: adjustment of Language, Phase Identification, Phase Colors, RS-232 baudrate, Auto shut-off of display (to save battery power), definition of User name (as shown in entry screen), reset to factory default settings, demo mode on/off, display contrast, format SD Memory Card. Some menus have a function key for reset to factory default settings.
Attainable under Function key F1. Explanation is done further on in this chapter.
- *VERSION & CALibration*: access to a read-only menu showing Model Number, Serial Number, Calibration Number, Calibration Date. Under Function key F1 there is a submenu showing installed Options. Chapter 25 Tips and Maintenance explains how to activate functions not installed.
Under Function key F2 there is Battery Information available such as charging state and quality. Refer to Chapter 25 – Tips & Maintenance for more battery information.
- *SETUP WIZARD*: provides a guided tour along the general setups that are essential for a correct measurement. This concerns following parameters: wiring configuration, nominal frequency, nominal voltage, the set of power quality limits used, and the type of voltage and current probes to be used. The probe scaling is done separately for Phase and Neutral. Attainable under Function key F3.
- *MANUAL SETUP*: this extensive menu allows the user to customize many functions to specific user requirements. Many of these functions however are preset to such values that a clear display is obtained in almost all circumstances. Also Date, Time, Config(uration), Frequency, Nominal Voltage (Vnom), and Limits used can be adjusted here. Attainable under Function key F4.
Further on in this chapter is explained in detail what setups can be made.

The figure below shows the entry menu present under the SETUP key.

USER PReferences

To access the USER PReferences menus:

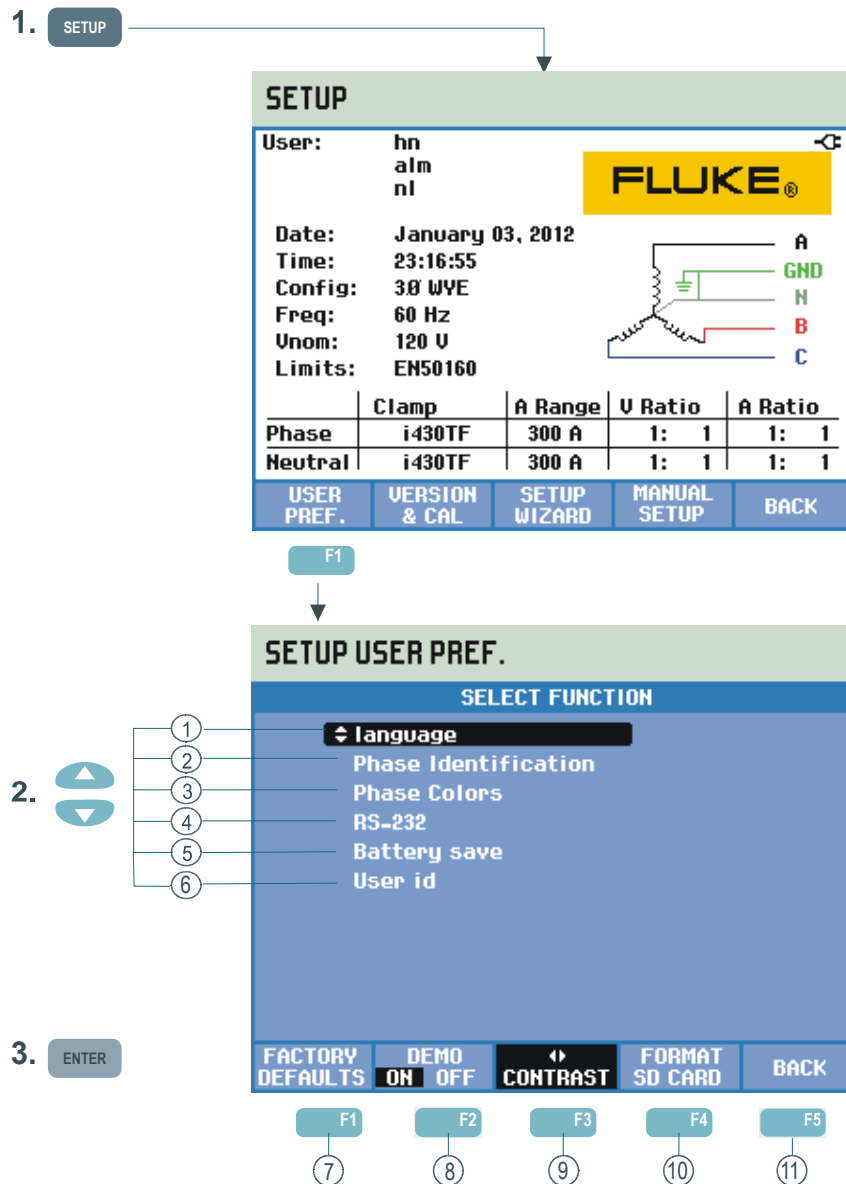

USER PReferences allows you to customize Information Language, Phase Identification, Phase Colors, RS-232 baudrate settings, Auto shut-off of display backlight, programming of User name/address (as shown in entry screen), Reset of Analyzer to Factory Defaults, Demo Mode on/off, display contrast, and clearing of memories.

Read below how to make adjustments:

- ① Language: use the up/down arrow keys to select the desired information language. Press ENTER and next Function key F5 – OK to confirm.
- ② Phase Identification: Use the up/down arrow keys to select A, B, C or L1, L2, L3. Press ENTER and next Function key F5 – BACK to leave the menu.
- ③ Phase Colors: Use the up/down arrow keys to choose colors as used in the USA, EU, UK, or according to HD 308 S2. Or define your own set of colors: press ENTER and use the up/down arrow keys to select a phase and use the left/right arrow keys to select a color. Press function key F5 – BACK to leave the menu.
- ④ RS-232: Use the left/right arrow keys to adjust the baudrate for communication with a PC. Press function key F5 – BACK to leave the menu.
- ⑤ Battery save: Use the up/down arrow keys to select the time after which the Display dims when no keys are operated. Press ENTER to confirm and next Function key F5 – BACK to leave the menu.
- ⑥ User id: access to a menu to define 3 lines with user programmable text (e.g. the owner's name, site and address). This text appears in the power-on and SETUP entry screens. Use the up/down arrow keys to choose a character. Use the left/right arrow keys to choose the character position. Use Function key F3 to insert spaces. Use ENTER to jump to the next line. Press function key F5 – OK to leave the menu.
- ⑦ F1 – FACTORY DEFAULTS: resets all settings in this menu to factory default. Memory contents will be erased.
- ⑧ F2 - DEMO mode: the voltage input sensitivities are increased to 2 V for use with a demo generator. The generator is capable to generate 3-phase voltages and currents with various interference types at safe voltage levels.
- ⑨ F3 – CONTRAST: Use left/right arrow keys to adjust the display contrast.
- ⑩ F4 – FORMAT SD CARD: All datasets, screens, and logging data is cleared in this action. Protection is achieved via a confirm menu.
- ⑪ F5 – BACK: return to SETUP entry menu.

MANUAL SETUP

To access the MANUAL SETUP menus:

1. **SETUP**

2. **UP/DN**

SETUP FLUKE 435-II

User: hn
alm
nl

Date: January 03, 2012
Time: 02:53:27
Config: 3Ø WYE
Freq: 60 Hz
Unom: 120 V
Limits: EN50160

	Clamp	A Range	U Ratio	A Ratio
Phase	1 mU/A	3000 A	1: 1	1: 1
Neutral	1 mU/A	3000 A	1: 1	1: 1

USER PREF. VERSION & CAL SETUP WIZARD **MANUAL SETUP** BACK

3. **ENTER**

4. **UP/DN**

5. **ENTER**

6. **UP/DN**

7. **ENTER**

SETUP FLUKE 435-II

User: hn
alm
nl

Date: January 03, 2012
Time: 02:55:01
Config: 3Ø WYE
Freq: 60 Hz
Unom: 120 V
Limits: EN50160

	Clamp	A Range	U Ratio	A Ratio
Phase	1 mU/A	3000 A	1: 1	1: 1
Neutral	1 mU/A	3000 A	1: 1	1: 1

TREND SCALE SCOPE SCALE FUNCTION PREF. BACK

SETUP TRENDS SCALE FLUKE 435-II

VOLTS/AMPS/HERTZ

TREND SCALING	PHASE	NEUTRAL
Urms offset	100.0 U	30.0 U
Urms span	88.8 U	60.0 U

PHASE AUTO BACK
NEUTRAL ON OFF

SETUP SCOPE SCALE FLUKE 435-II

SCOPE

SCOPE SCALING	PHASE	NEUTRAL
Volt range	120.0 U	12.0 U
Amp range	3000 A	3000 A

PHASE DEFAULTS BACK
NEUTRAL

8. **UP/DN**

9. **ENTER**

SETUP FUNC. PREF. FLUKE 435-II

Trend Default duration: 1 hr
Average time: 0.25 s
Start Delay: 10 s

Harmonics Scale: % f
Interharmonics: OFF
THD: 40
K-factor method: EU
K-factor par. e: 0.10
K-factor par. q: 1.70

Dips & Swells Reference: Nominal

WAVE CAPTURE THRUSH RAPID CHANGE ENERGY LOSS BACK

Flicker Lamp model: 60Hz 120V
Phasor Clockwise: neg
Power Method: Unified
Display: DPF
Cycle Aggrega. Interval: 10/12 cycles

10. 11. 12. 13. 14.

MANUAL SETUP allows you to customize Analyzer settings related to the measurements.

① Press the SETUP key and next Function key F4 – MANUAL SETUP to reach the MANUAL SETUP screen.

② Use the up/down arrow keys to select one of the parameters listed below and then press ENTER to access the setup menu:

③ - Date, Time: use the arrow keys to select date, time, and date format. Press ENTER to confirm the selected date format. With a GPS receiver connected and F2 set to GPS ON, date and time are synchronized automatically. Time zone and daylight saving ON/OFF can also be set. Press F1 to access the GPS test menu that informs you about reception quality. Press Function key F5 – BACK to return to the previous menu.

- Config: selection of 10 wiring (50/60 Hz power systems) configurations. Selection is done with F1, F2, F3 and the arrow keys. Then press ENTER to confirm and to enter a screen showing how to connect the Analyzer to the power system. When ready press Function key F5 twice to return to the SETUP entry screen.

A step-by-step example on how to change the wiring configuration is given further on in this chapter.

- Freq: adjustment of Nominal Frequency (50 Hz, 60 Hz or in Fluke 437-II also 400 Hz). Use the up/down arrow keys to select the Nominal Frequency. Press ENTER to confirm and Function key F5 – BACK to return to next higher menu.

- Vnom: adjustment of Nominal Voltage. Use the arrow keys to select 100 V, 120 V, 230 V, 400 V or any other voltage. Press ENTER to confirm and Function key F5 – BACK to return to next higher menu.

- Limits: see paragraph Limits Adjustments.

- Clamp, A range, V scale: adjustment of the Analyzer to the characteristics of current clamps and voltage leads. The default selection is valid for the accessories as supplied with the Analyzer. The supplied voltage leads are 1:1 types; when using attenuating leads or a voltage transformer you must adapt the voltage scale accordingly (e.g. 10:1 for 10 times attenuation). Identically the current scale can be adjusted when using current converters in combination with current clamps. With the arrow keys you can customize voltage and current readout to any desired transformation ratio. Selection of Amps and Volt scaling is done with Function key F3 There are separate selection tables for the Phase and Neutral: Function key F4 is used for selection.

Behind Amp clamp: you can select many Fluke clamp types. The Analyzer's sensitivity is adjusted automatically then. In case of clamps with more than one sensitivity the sensitivity of the Analyzer must be set to match with the clamp sensitivity (attainable under Sensitivity:). Behind Amp clamp: you can also select clamp sensitivity values such as 1 V/A, 100 mV/A and others.

Sensitivity x10 increases amps sensitivity by 10 times. In this position the signal is AC coupled which means that DC signal components are blocked. Resolution is 10 times more with limited range.

- ④ Trend Scale: adjustment of offset and span of the trend displays of actual measurement of voltage, Crest Factor (CF) and frequency is possible in this menu. Manual adjustment is possible when AUTO mode is set to OFF with Function key F4. When AUTO mode is ON offset and span are set to such a value that a clear display is obtained in almost all circumstances (auto scaling). Separate adjustments are provided for Phase and Neutral: selection is done with Function key F3.
- ⑤
- ⑥ Scope Scale: adjustment of the voltage and current range of the Scope display. Separate adjustments are provided for Phase and Neutral: selection is done with Function key F3. Function key F4 allows return to Default values.
A step-by-step example on how to change the scope scaling is given further on in this chapter.
- ⑦
- ⑧ Function Preferences: adjustment of functions related to Trend display, Harmonics, Dips & Swells, Flicker, Phasor, Power, and number of Aggregation Cycles for Vrms/Arms. The table below gives additional information. Use the up/down arrow keys to select an item and the left/right arrow keys to select values/ranges for that item.
- ⑨

Table 23-1. Function Preference, Measurement Items Overview

Measurement items	Measurement sub items	Default setting	Measurement sub item values and ranges
Trend	Default duration	7 d	1 hr, 2 hr, 4 hr, 8 hr, 16 hr, 24 hr, 2 d, 7 d, 30 d, 3 mon, 6 mon, 12 mon.
	Average time	1 s	0.25 s, 0.5 s, 1 s, 3 s, 5 s, 10 s, 30 s, 1 m, 5 m, 10 m, 15 m, 30 m, 1 hr, 2 hr.
	Start Delay	10 s	10 ... 999 s (step: 1s)
Harmonics	Scale	% f	% f, % r, rms
	Interharmonics	OFF	ON, OFF
	THD	40 harmonics	40, 50 harmonics
	K-factor method ¹	US	EU, US
	K-factor e ¹	0.1	0.00 ... 0.20 (step 0.01)
	K-factor q ¹	1.7	1.00 ... 2.00 (step 0.01)
Dips & Swells	Reference	Nominal	Nominal, sliding
Flicker	Lamp model	Fnom	50Hz/230V, 60Hz/120V
Phasor	Clockwise	neg	neg, pos
Power	Method	Unified	Classic, Unified
	Display	Fnom = 50Hz: Cos Φ Fnom = 60Hz: DPF	Cos Φ , DPF
Cycle aggregation	Interval	10/12 cycles	10/12 cycles, 150/160 cycles (3s)

¹ When K-factor method is set to US, then K-factor e parameter and the K-factor q parameter are disabled.

⑩ Wave Capture (available under Function key F1): parameters can be set here related with capture of voltage and current waveforms in modes such as Transients and Flicker. In this menu Function key F4 can be used to reset to Defaults and Function key F5 to leave the menu.

⑪ Inrush (available under Function key F2): menu to set the parameters for the Inrush measurement. In this menu Function key F4 can be used to reset to Defaults and Function key F5 to leave the menu.

⑫ Rapid Change (available under Function key F3): menu to set the parameters for the Rapid Voltage Change measurement (Voltage tolerance, Steady time, Minimum step, Detect on Vstep/Vmax). In this menu Function key F4 can be used to reset to Defaults and Function key F5 to leave the menu.

- ⑬ Energy Loss (available under Function key F4): menu to set the parameters for the Energy Loss measurement. Parameters to be set are: four different tariff rates, cable data (length in meters/feet, diameter in square millimeter or acc. to AWG / American Wire Gauge). In Automatic mode setup of cable data is not required: the Analyzer bases cost calculations on the assumption of three percent copper loss in the cable. Other losses are calculated in ratio to the copper loss.
- ⑭ Back (available under Function key F5):

Manual Setup - How to change the wiring configuration

Below you will find a step-by-step example on how to change wiring configuration to 3-phase WYE IT (IT = Interrupted Terra = Interrupted Ground).

① **SETUP** →

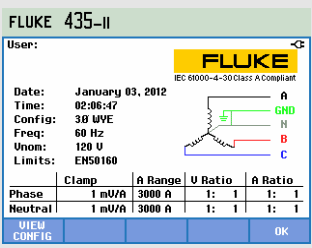

	Clamp	A Range	U Ratio	A Ratio
Phase	1 m/A	3000 A	1: 1	1: 1
Neutral	1 m/A	3000 A	1: 1	1: 1

The active configuration is indicated in text and in a diagram behind Config.

② **F4** →

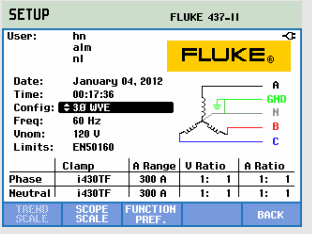

	Clamp	A Range	U Ratio	A Ratio
Phase	i430TF	300 A	1: 1	1: 1
Neutral	i430TF	300 A	1: 1	1: 1

Note that a setup parameter is highlighted. If required use the up and down arrow keys to select setup parameter Config.

③ **ENTER** →

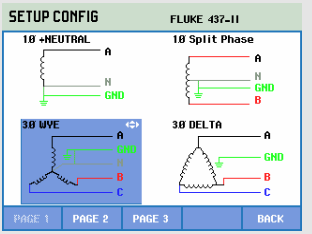

The screen shows 4 wiring configurations; 3-phase WYE IT configuration is not among them. Press F2 to access a second screen with 4 other configurations.

④  →

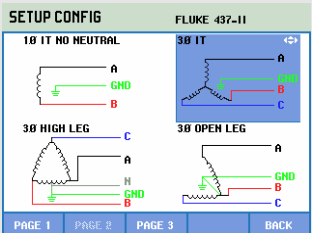

Use the arrow keys to highlight 3φ IT. Then press ENTER to confirm the selection.

⑤  →

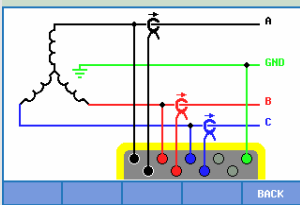

The diagram shows in detail how to connect voltage and current probes to the power system under test.

⑥  (3x) →

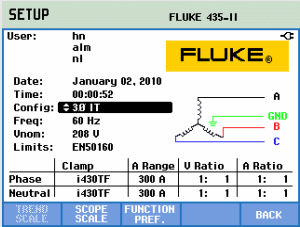

	Clamp	A Range	U Ratio	A Ratio
Phase	1430TF	300 A	1: 1	1: 1
Neutral	1430TF	300 A	1: 1	1: 1

Return to Setup entry screen. The new configuration is indicated behind Config. and the belonging configuration symbol is shown on the right side of the screen.

Manual Setup - How to change scale of Scope Display

Manual Setup - How to change the wiring configuration The example below shows stepwise how to adjust Scope display scaling of the phase voltages.

①

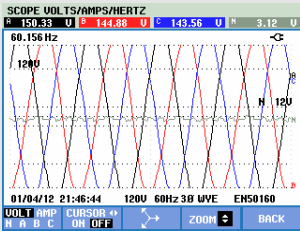

The voltage waveforms of the Phases are outside the viewing window.

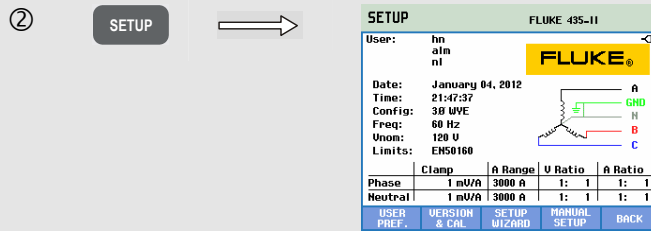

Press SETUP to access setup entry screen.

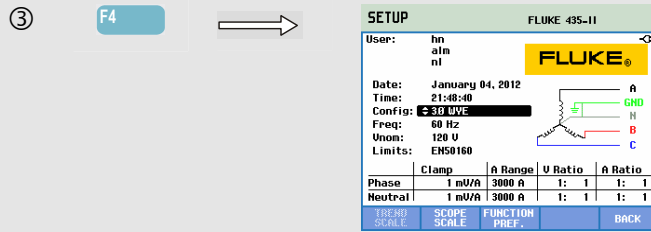

Press function key F4 to access the Manual Setup screen.

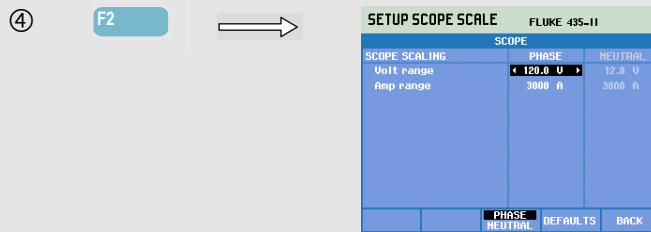

Press function key F2 to access Scope display scaling.

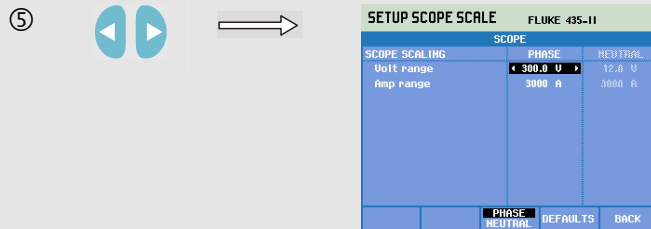

Use the left/right arrow keys to increase (e.g. to 300 V) the Voltage range of the Scope display.

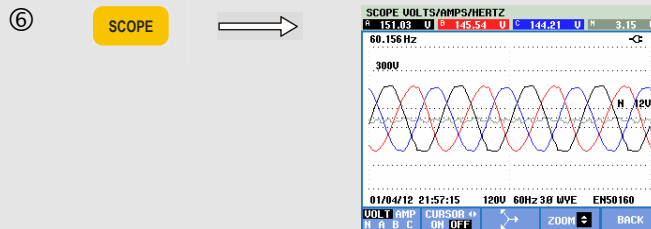

Return to the Scope display: the voltage waveforms of the Phases are inside the viewing window.

Limits Adjustments

To navigate the Limits Setup menus:

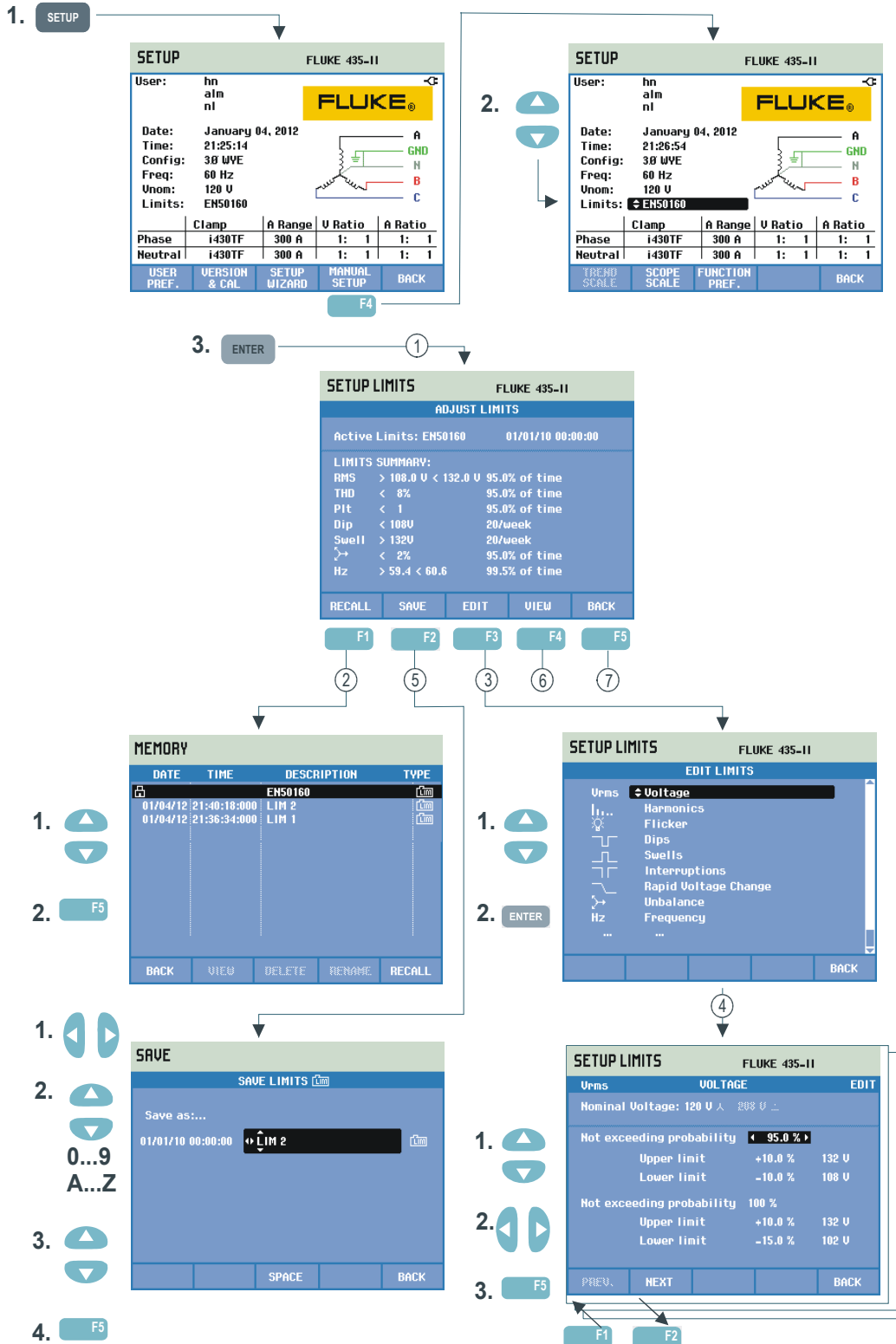

Limits Adjustments is used to save, recall, and define sets of limits for:

- Power Quality Monitoring (Monitor).
- Event capture levels for Dips/Interruptions/Rapid Voltage Changes/Swells.

The entry menu is available in the selected information language.

Read below how to do this:

- ① Adjust Limits is the entry menu. It shows the main settings of the active set of limits: name, creation date, and a summary of limits data.
- ② Recall Limits menu is used to recall a set of power quality limits:
 - EN50160 is a factory installed read-only set of limits.
 - User definable sets of limits can be stored. They can be recalled afterwards. As a basis you may use EN50160 and edit it to the desired set of limits. Use the up/down arrow keys to select a set of limits you want to recall. Then press Function key F5 to recall and to use them. Press Function key F1 to leave the menu without further actions.
- ③ Edit Limits menu is used to modify limits. Setups are grouped per power quality item in separate submenus for voltage, harmonics, flicker, etc.
Use the up/down arrow keys to select an item to be adjusted. Then press the ENTER key F5 to enter the adjustment submenu. All adjustment items are listed in the table below.
- ④ Use the arrow keys to select and edit limits.
Press Function key F5 to confirm selections and return to the Edit Limits menu. Use Function keys F1 – PREVIOUS or F2 – NEXT to move directly to an adjacent submenu. When ready with editing the limits, Press Function key F5 – OK twice to return to the Adjust Monitor Limits menu. Arrow keys can be used here to define a name for the new set of limits. Then press Function key F2 – SAVE to enter the Save Monitor Limits menu.
- ⑤ Save Limits menu is used to save sets of limits under a user definable file name. The file name is selected with the arrow keys: the up/down keys to select a character and the left/right keys to define the character position. When done press ENTER to save the limits. Press F5 – BACK to return to the Adjust Monitor Limits menu without saving limits.
- ⑥ View Limits menu. This menu has the same structure as the Edit Monitor Limits menu and can be used to view limits without the risk of changing them. Use F1 – PREVIOUS and F2 – NEXT to select all sets of limits.
- ⑦ Press Function key F5 – BACK to return to the MANUAL SETUP menu.

Setup of Monitor Limits, a survey of adjustments.

Limits	Adjustments
Voltage	2 Probability percentages (100 % and adjustable): each with adjustable upper and lower limit.
Harmonics	For each harmonic 2 Probability percentages (100 % and adjustable): each with adjustable upper limit.
Flicker	2 Probability percentages (100 % and adjustable): adjustable percentage with adjustable upper limit. Weighing curve (lamp type): adjustable under FUNCTION PREFERENCE, Flicker, Lamp Model.
Dips (*)	Reference voltage (Nominal or Sliding as selected under Function Preference/Dips & Swells). Threshold, hysteresis, allowed number of dips/week.
Swells (*)	Reference voltage (Nominal or Sliding as selected under Function Preference/Dips & Swells). Threshold, hysteresis, allowed number of swells/week.
Interruptions (*)	Threshold, hysteresis, allowed number of interruptions/week. Reference voltage is Nominal.
Rapid Voltage Changes (*)	Allowed number of events/week. Voltage tolerance: adjustable under FUNCTION PREFERENCE, F3 – RAPID CHANGE
Unbalance	For each harmonic 2 Probability percentages (100 % and adjustable): adjustable percentage with adjustable upper limit.
Frequency	2 Probability percentages (100 % and adjustable): each with adjustable upper and lower limit.
Mains Signaling	2 Adjustable frequencies. For each frequency 2 probability percentages (100 % and adjustable): adjustable upper limits (**).

(*): setups that are also valid for measuring mode Dips & Swells. Events per week is used for Monitor only.

(**): when changing frequency, limits automatically follow the EN50160 'Meisterkurve', but can also be set manually. The 'Meisterkurve' is shown in the figure below.

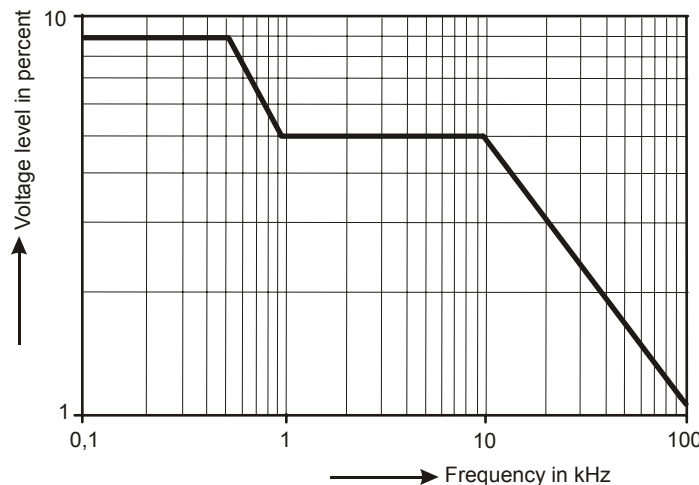

Figure 23-4. Meister Kurve acc. to EN50160

Chapter 24

Using Memory and PC

Introduction

This chapter explains how to save screens and data into the Analyzer's memory and how to view, rename and delete them.

The second part of the chapter explains how to setup the Analyzer for communication with a PC, and laptop.

Using memory

Four types of data can be stored:

1. **Save Limits:** these contain Power Quality limits and thresholds. Limits can be edited via SETUP, F4 – MANUAL SETUP and Adjust Limits menu.
2. **Save Task:** tasks include limits and analyzer setups. Setups include the reading selections made for the Logger measurement.
3. **Save Screen:** are stored when operating the SAVE SCREEN key.
4. **Measurements:** they are automatically saved on the SD Card during the measurement. Measurement data includes all trend data, the task and the limits of the measurement. Additionally the screen shown when the measurement was stopped is included.

Memory space depends on the size of the installed SD Card. The maximum supported size of the card is 32 GB.

The data files are numbered automatically.

Making a Screenshot



Press this key to make a screenshot.

Making a screenshot is a quick and easy way to store measuring results. However post processing is not possible. A screenshot is saved each time you press this button. A screenshot is saved as a file with date and time when saved. This occurs via a menu to define a name for the file to be saved.

Name definition is done with the arrow keys: the up/down keys for character selection and the left/right keys for character position. Spaces are inserted with Function key F3. How to recall, print, and delete screenshots and how to rename them is explained in the next section 'Memory Operations'.

Memory Operations

The MEMORY button accesses menus to save, recall, view, delete and print datasets and screenshots. When you press the MEMORY button, the current measurement screen is stopped and data is saved. This action occurs via a confirm menu.

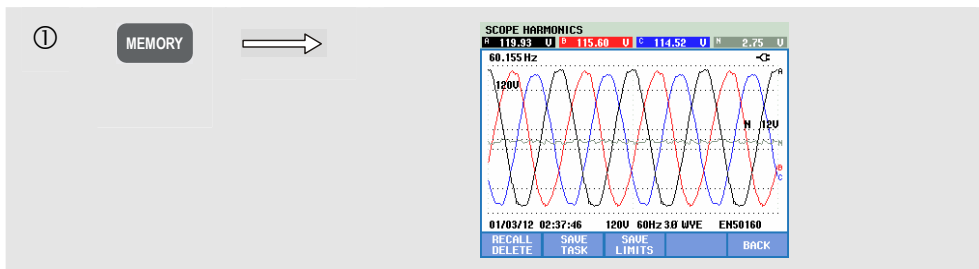

Available function keys:

F1	RECALL / DELETE. Accesses the submenu to view, delete, rename files and to use data files. The submenu is shown in the figure below: it lists all screenshots and data files in the sequence of date and time. The type column indicates all data files with a small icon. The table below lists all icons that are used. You can use the up/down arrow keys to highlight a particular data file to be viewed.
F2	SAVE TASK. Limits and analyzer setups are saved.
F3	SAVE LIMITS. Limits are saved..
F5	BACK. Press to resume the measurement.

Following icons are used to identify the data files:

Icon	Description	Icon	Description
	Limits		Power Inverter Efficiency Meas.
	Task		Unbalance Measurement
	Screen		Inrush Measurement
	Read only file		Monitor Measurement
	Volts/Amps/Hertz Measurement		Flicker Measurement
	Dip & Swells Measurement		Transients Measurement
	Harmonics Measurement		Power Wave Measurement
	Power & Energy Measurement		Mains Signaling Measurement
	Energy Loss Calculator		Logger Measurement

Recalling and deleting Screenshots and Datasets:



Available function keys for recall and delete:

	Return to main menu.
	Access to the menu where you can view the highlighted screenshots and data sets. Use the Function keys PREVIOUS or NEXT to view other files. Files are grouped in sequence of date and time. For datasets the entry screen is shown. Complete data within a dataset becomes available for investigation after you have pressed USE.
	To delete the file highlighted with the up/down arrow keys.
	To rename the file highlighted with the up/down arrow keys. Renaming occurs via a menu to define a new name. Name definition is done with the arrow keys: the up/down keys for character selection and the left/right keys for character position. Spaces are inserted with Function key F3. The selection is confirmed with Function key F5.
	Is only available for datasets to view their complete contents.

Use of PC

The Analyzer is equipped with an isolated USB interface for communication with a PC. To make the connection with the USB port of PC's, an USB-A to mini-USB interface cable is supplied. With the Power Log software you can upload trend and waveform data and screenshots in bitmap format to your PC or laptop. The information supplied with Power Log software informs you in detail about its features. The interface connection is located behind a dust cover at the lower left corner of the Analyzer.

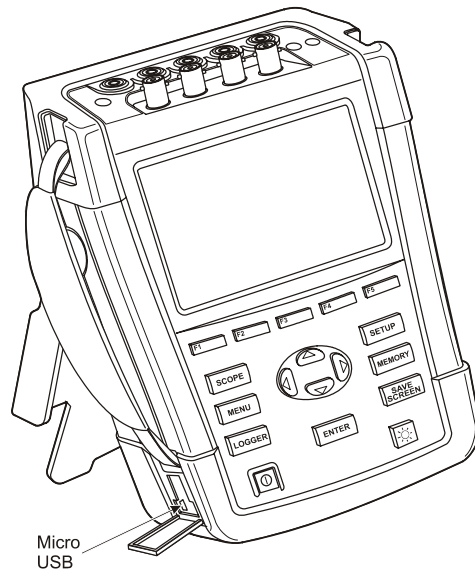

Figure 24-1. Location of USB interface connector

For other applications communication baudrate can be adjusted as follows: press the SETUP key, then Function key F1 – USER PReference, and then select RS-232 using the up/down arrow keys and ENTER. Then adjust the baudrate with the left/right arrow keys and leave the menu with F5 - BACK. Baudrate and COM port number must always be adjusted correctly.

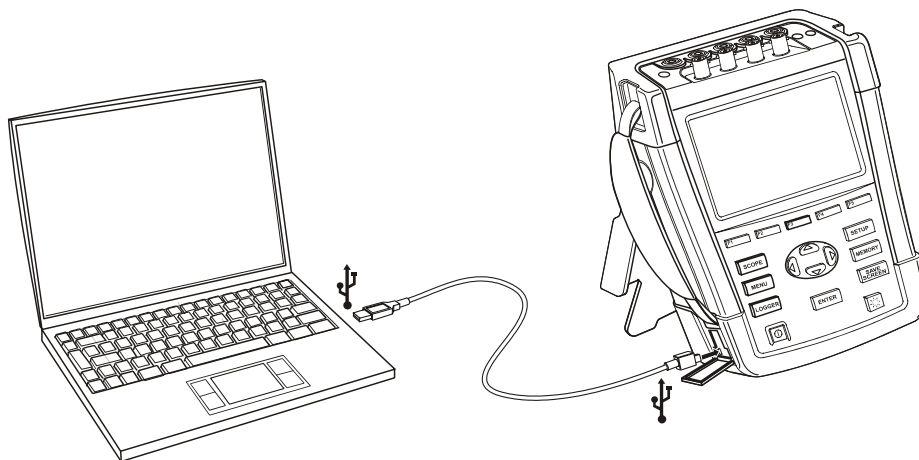

Figure 24-2. Analyzer and laptop PC

Chapter 25

Tips and Maintenance

Introduction

This chapter covers basic maintenance procedures that can be performed by the user. For extensive service data such as disassembly, repair, and calibration information, see the Service Manual. You will find the part number of the Service Manual in section 'Parts and Accessories' in this chapter.

Cleaning the Analyzer and its Accessories

Warning

Disconnect the Analyzer and its accessories from all voltage sources during cleaning!

Clean the Analyzer and accessories with a damp cloth and a mild soap. Do not use abrasives, solvents, or alcohol. These may damage the text.

Storing the Analyzer

Before storing the Analyzer for an extended period of time, it is recommended to charge the Li-ion battery to a level of about 50%. The charge level is attainable via key sequence: SETUP, F2 – VERSION & CAL, F2 – BATT. INFO.

Keeping the Battery in Good Condition

When the Analyzer is powered by the battery, the battery condition symbol in the screen header informs you about the charge condition. This symbol ranges from fully charged to empty: ■ ■ ■ ■ □ ☒

To keep the battery in optimal condition, you must let it discharge fully and then charge it. A full charge takes about 3 hours with the Analyzer turned off. Repeat this at least twice a year.

Installation of Options

The INSTALL OPTION menu is intended for future expansions. The menu is attainable via key sequence: SETUP, F2 – VERSION & CAL, F1 – INSTALL OPTION.

Note:

The VERSION & CALIBRATION menu indicates the last calibration date. For this Analyzer a calibration interval of 1 year is recommended. Contact your authorized Fluke Service Center if the calibration interval has been expired.

Parts and Accessories

Standard Accessories.

The following tables list the user-replaceable parts. For additional optional accessories, see the ScopeMeter Accessories brochure. To order replacement parts or additional accessories, contact your nearest Fluke Service Center.

Item	Ordering Code
Power Adapter	BC430
Rechargeable Li-ion battery 28 Wh	BP290
Test Lead Set 2.5 m incl. Alligator Clips (5 pieces) and + Color Coding Clips.	TLS430
Flexible 6000 A AC Current Clamp Set (4 pieces).	i430-FLEXI-TF
Set with Color Coding Clips for Test Leads	2411463
Decal Set for Input Sockets, Colored	4137197
Decal Set for Input Sockets, Black & White	4137201
USB Interface Cable for PC Connection (USB-A to mini-USB-B)	3945381
Soft Carrying Case (Supplied with Fluke 434-II/435-II)	C1740
Hard Case with Rollers (Supplied with Fluke 437-II).	C437-II
Side Strap	3945370
Hang Strap	946769
Users Manual	www.fluke.com

Optional Accessories.

Item	Ordering Code
Double Capacity Li-ion battery 56 Wh	BP291
External Battery Charger, charges BP291 externally using BC190	EBC290
Hanging Hook; allows the Analyzer to be hung on a cabinet door or separation wall.	HH290
GPS Time Synchronization Unit	GPS430
AC/DC Current Clamp 100 A (10 mV/A) and 10 A (100 mV/A) switchable.	80i-110s (*)
AC Current Clamp 1000 A (1 mV/A), 100 A (10 mV/A), and 10 A (100 mV/A) switchable.	i1000s (*)
AC Current Clamp 2000 A (1 mV/A) and 200 A (10 mV/A) switchable, flexible.	i2000flex (*)
AC Current Clamp 200 A (10 mV/A) and 20 A (100 mV/A) switchable.	i200s (*)
AC Current Clamp 3000 A (0.1 mV/A), 300 A (1 mV/A), and 30 A (10 mV/A) switchable.	i3000s (*)
AC/DC Current Clamp 30 A (100 mV/A).	i30s (*)
AC/DC Current Clamp 300 A (1 mV/A) and 30 A (10 mV/A) switchable.	i310s (*)
AC Current Clamp 400 A (1 mV/A)	i400s (*)
Flexible AC Current Clamp	i430Flex (*)
Service Manual	www.fluke.com

(*): Listed are the Current Clamps that can be selected in the Analyzer's Amps Scaling menu.

Refer to www.fluke.com for an actual overview of all clamps and accessories available for this product.

Troubleshooting

Analyzer does not start up.

The battery may be completely empty. In this case the Analyzer will not start up. However if it is powered by the Power Adapter it should start up immediately. Charge the battery first: power the Analyzer with the Power Adapter without turning it on.

Note

The Analyzer can not be powered up if the battery cover is not correctly closed.

Screen remains black.

Make shure that the Analyzer is on: at power-on you should hear a beep. If the screen remains black, you might have a problem with the screen contrast. Proceed as follows to change Contrast:

- Press the SETUP key.
- Press Function key F1.

- Press the left (more light) or right (less light) arrow key for about five seconds to return to normal display.

Operation time of fully charged battery is too short.

The battery may be in poor condition. This may improve after a full discharge and full charge cycle as explained in section 'Keeping the battery in good condition' in this Chapter. Detailed information on the battery condition can be found on the Analyzer's screen after the key operations: SETUP, F2 – VERSION & CAL, F2 – BATT. INFO. Replace a battery that is in poor condition.

PowerLog Software or other PC software does not recognize the Analyzer.

- Make sure that the Analyzer is turned on.
- Make shure that the USB interface cable is properly connected between Analyzer and PC.
- Make sure that the correct COM port has been selected for the PC. If not, change the COM port setting or connect the interface cable to another COM port.
- Make sure that baudrate of Analyzer and PC are the same.
- Make sure that all actions described in addendum 'Installing USB Drivers' have been carried out properly.

Chapter 26

Specifications

Introduction

Models Concerned

Fluke 434-II: Energy Analyzer

Fluke 435-II: Power Quality and Energy Analyzer

Fluke 437-II: Power Quality and Energy Analyzer 400 Hz.

Performance Characteristics

Fluke guarantees the properties expressed in numerical values within the tolerances stated. Numerical values without tolerances are typical and represent the characteristics of an average instrument excluding accessories. The Analyzer meets the specified accuracy 30 minutes and two complete acquisitions after power-on. All operational specifications are valid under the restrictions mentioned in section 'Environmental' unless otherwise specified.

Specifications are based on a one year calibration cycle.

Environmental Data

The environmental data mentioned in this manual are based on the results of the manufacturer's verification procedures.

Safety Characteristics



The Analyzer has been designed and tested in accordance with standard EN61010-1 2nd edition (2001), Safety Requirements for Electrical Equipment for Measurements Control and Laboratory Use for Class III Pollution Degree 2 instruments.

This manual contains information and warnings that must be followed by the user to ensure safe operation and to keep the Analyzer and its accessories in a safe condition. Use of this Analyzer and its accessories in a manner not specified by the manufacturer may impair the protection provided by the equipment.

Electrical Measurements

The following specifications of the instrument are verified using the “implementation verification” table 2 as specified in 61000-4-30 2nd edition chap-6-2.

INPUT CHARACTERISTICS

Voltage inputs	
Number of inputs	4 (3 phases + neutral) dc coupled
 Maximum input voltage	1000 Vrms
 Nominal Voltage range	Selectable 1 V to 1000 V according IEC61000-4-30
 Maximum peak measurement voltage	6 kV (Transients mode only)
Input impedance	4 MΩ // 5 pF
Bandwidth	> 10 kHz, up to 100kHz for Transients mode
Scaling	1:1, 10:1, 100:1, 1,000:1, 10,000:1 and variable

Current inputs	
Number of inputs	4 (3 phases + neutral) dc or ac coupled
Type	Clamp on current transformer with mV output or i430flex-TF
 Nominal input Range	0 - ± 3.0 Vpeak, 0 - 3.97 Vrms sinewave (selection x1, AC+DC coupled) 0 - ± 0.3 Vpeak, 0 - 0.397 Vrms sinewave (selection x10, AC coupled)
Range	0.5 Arms to 600 Arms with included i430flex-TF (with sensitivity 10x) 5 Arms to 6000 Arms with included i430flex-TF (with sensitivity 1x) 0.1 mV/A to 1 V/A and custom for use with optional ac or dc clamps Note: sensitive x10 position gives more resolution, but reduced range. Only AC signals are supported; DC components are blocked.
Input impedance	1 MΩ
Bandwidth	>10 kHz
Scaling	1:1, 10:1, 100:1, 1,000:1 10,000:1 and variable

Nominal frequency	434-II, 435-II: 50 Hz, 60 Hz 437-II: 50 Hz, 60 Hz, 400 Hz
Sampling system	
Resolution	16 bit analog to digital converter on 8 channels
Maximum sampling speed	200 kS/s on each channel simultaneously

RMS sampling	5000 samples on 10/12 ¹ cycles according IEC 61000-4-30
PLL synchronization	4096 samples on 10/12 ¹ cycles according IEC 61000-4-7

CROSS TALK

Between V inputs	-60 dB @ Fnominal
Voltage to current input	-95 dB @ Fnominal (Amps Scaling: x1 AC+DC)

COMMON MODE REJECTION RATIO (CMRR)

CMRR	>60 dB
------	--------

DISPLAY MODES

Waveform display	Available in all modes via SCOPE key. Default display mode for Transients function Update rate 5x per second Displays 4 cycles of waveform data on screen, up to 4 waveforms simultaneously
Phasor	Available in all modes via Scope waveform display Default view for Unbalance mode
Meter readings	Available in all modes except Monitor, provides tabulated view of all available readings Fully customizable up to 150 readings for Logger mode
Trend graph	Available in all modes except Transients Single vertical cursor with min max and average reading at cursor position
Bar graph	Available in Monitor and Harmonics mode
Event list	Available in all modes Provides 50/60 ¹ cycles of waveform information and associated ½ cycle rms values for Volts and Amps

MEASUREMENT MODES

Scope	4 voltage waveforms, 4 current waveforms, Vrms, Vfund. Arms, A fund, V @ cursor, A @ cursor, phase angles
Volts/Amps/Hertz	Vrms phase to phase, Vrms phase to neutral, Vpeak, V Crest Factor, Arms, Apeak, A Crest Factor, Hz
Dips and Swells	Vrms $\frac{1}{2}$, Arms $\frac{1}{2}$, Pinst with programmable threshold levels for event detection
Harmonics DC, 1 ... 50	Harmonics Volts, THD, Harmonic Amps, K factor Amps, Harmonic Watts, THd Watts, K factor Watts, Interharmonic Volts, Interharmonic Amps, Vrms, Arms (relative to fundamental or to total rms) Fluke 437-II @ 400 Hz: DC, 1 ... 11
Power and Energy	Vrms, Arms, Wfull, Wfund., Vfull, Vfund., VAharmonics, VAunbalance, var, PF, DPF, CosQ, Efficiency factor, Wforward, Wreverse
Energy Loss Calculator	Wfund, VAharmonics, VAunbalance, var, A, Loss Active, Loss Reactive, Loss Harmonics, Loss Unbalance, Loss Neutral, Loss Cost (based upon user defined cost / kWh)
Inverter Efficiency	Wfull, Wfund, Wdc, Efficiency, Vdc, Adc, Vrms, Arms, Hz Note: requires optional dc current clamp
Unbalance	Vneg%, Vzero%, Aneg%, Azero%, Vfund, Afund, V phase angles, A phase angles
Inrush	Inrush current, Inrush duration, Arms $\frac{1}{2}$, Vrms $\frac{1}{2}$
Monitor	Vrms, Arms, harmonic Volts, THD Volts, Plt, Vrms $\frac{1}{2}$, Arms $\frac{1}{2}$, Hz, dips, swells, interruptions, rapid voltage changes, unbalance and mains signalling. All parameters are measured simultaneously in accordance with EN50160. Flagging is applied according to IEC61000-4-30 to indicate unreliable readings due to dips or swells. Note: not supported for measurements at 400 Hz as offered in Fluke 437-II
Flicker	Pst (1min), Pst, Plt, Pinst, Vrms $\frac{1}{2}$, Arms $\frac{1}{2}$, Hz. Note: not available in Fluke 434-II Note: not supported for measurements at 400 Hz as offered in Fluke 437-II
Transients	Transient waveforms 4x Voltage, 4x Amps, triggers: Vrms $\frac{1}{2}$, Arms $\frac{1}{2}$, Pinst Note: not available in Fluke 434-II
Mains Signaling	Relative signaling voltage and absolute signaling voltage averaged over three seconds for up to two selectable signaling frequencies Note: not available in Fluke 434-II Note: not supported for measurements at 400 Hz as offered in Fluke 437-II
Power Wave	Vrms $\frac{1}{2}$, Arms $\frac{1}{2}$, W, Hz and scope waveforms for Voltage, Amps and Watts Note: not available in Fluke 434-II
Logger	Custom selection of up to 150 Power Quality parameters measured simultaneously on 4 phases

ACCURACY, RESOLUTION AND RANGE

Volt/Amps/Hertz	Measurement Range	Resolution	Accuracy
Vrms (ac+dc) Fluke 435-II/437-II	1...600 V	0.01 V	± 0.1% of nominal voltage
Fluke 434-II	600...1000 V 1...1000 V	0.01 V 0.1 V	± 0.1% of reading ± 0.5% of nominal voltage
Vpk	1...1400 Vpk	1 V	5% of nominal voltage
Vrms½ Fluke 435-II/437-II	1...1000 V phase to neutral	0.1 V	± 0.2% of nominal voltage
Fluke 434-II	1...1000 V phase to neutral	0.1 V	± 1% of nominal voltage
Vfund Fluke 435-II/437-II	1...1000 V phase to neutral	0.1 V	± 0.1% of nominal voltage
Fluke 434-II	1...1000 V phase to neutral	0.1 V	± 0.5% of nominal voltage
Voltage Crest Factor (CF)	1.0 ... > 2.8	0.01	± 5%
Arms (ac+dc) i430flex-TF 1x i430flex-TF 10x 1 mV/A 1x 1 mV/A 10x	5...6000 A 0.5...600 A 5...2000 A 0.5...200 A (ac only)	1 A 0,1 A 1 A 0.1 A	± 0.5% ± 5 counts ± 0.5% ± 5 counts ± 0.5% ± 5 counts ± 0.5% ± 5 counts
Apk i430flex-TF Apk 1 mV/A	8400 Apk 5500 Apk	1 Arms 1 Arms	± 5% ± 5%
A Crest Factor (CF)	1 ... 10	0.01	± 5%
Arms½ i430flex-TF 1x i430flex-TF 10x 1 mV/A 1x 1 mV/A 10x	5...6000 A 0.5...600 A 5...2000 A 0.5...200 A (ac only)	1 A 0,1 A 1 A 0.1 A	± 1% ± 10 counts ± 1% ± 10 counts ± 1% ± 10 counts ± 1% ± 10 counts
Afund i430flex-TF 1x i430flex-TF 10x 1 mV/A 1x 1 mV/A 10x	5...6000 A 0.5...600 A 5...2000 A 0.5...200 A (ac only)	1 A 0,1 A 1 A 0.1 A	± 0.5% ± 5 counts ± 0.5% ± 5 counts ± 0.5% ± 5 counts ± 0.5% ± 5 counts
Hz ² Fluke 435-II /437-II @ 50 Hz nominal Fluke 435-II /437-II @ 60 Hz nominal Fluke 437-II @ 400 Hz nominal Fluke 434-II @ 50Hz	42.5 ... 57.5 Hz 51 ... 69 Hz 340 ... 460 Hz	0.001 Hz 0.001 Hz 0.1 Hz	± 0.001Hz ± 0.001Hz ± 0.1Hz

nominal Fluke 434-II @ 60Hz nominal	42.5 ... 57.5 Hz 51 ... 69 Hz	0.001 Hz 0.001 Hz	± 0.01Hz ± 0.01Hz
---	--------------------------------------	--------------------------	--------------------------

Power	Measurement Range	Resolution	Accuracy
Watt (VA, var) i430flex-TF 1 mV/A	max 6000 MW max 2000 MW	0.1 W ... 1 MW 0.1 W ... 1 MW	± 1% ± 10 counts ± 1% ± 10 counts
Power Factor (Cos φ / DPF)	0...1	0.001	± 0.1% @ nominal load conditions

Energy	Measurement Range	Resolution	Accuracy
kWh (kVAh, kvarh) i430flex-TF 10x	Depends on clamp scaling and V nominal		± 1% ± 10 counts
Energy loss i430flex-TF 10x	Depends on clamp scaling and V nominal		± 1% ± 10 counts Excluding line resistance accuracy

Harmonics	Measurement Range	Resolution	Accuracy
Harmonic order (n)	DC, 1..50 Grouping: Harmonic groups according to IEC 61000-4-7		
Inter-Harmonic order	Off, 1..50 Grouping: Harmonic and Interharmonic subgroups according to IEC 61000-4-7		
Volts %f	0.0 ... 100.0%	0.1%	± 0.1% ± n x 0.1%
Volts %r	0.0 ... 100.0%	0.1%	± 0.1% ± n x 0.4%
Volts Absolute	0.0 ... 1000 V	0.1 V	± 5% (*)
Volts THD	0.0 ... 100.0%	0.1%	± 2.5%
Amps %f	0.0 ... 100.0%	0.1%	± 0.1% ± n x 0.1%
Amps %r	0.0 ... 100.0%	0.1%	± 0.1% ± n x 0.4%
Amps Absolute	0.0 ... 600 A	0.1 A	± 5% ± 5 counts
Amps THD	0.0 ... 100.0%	0.1%	± 2.5%
Watts %f or %r	0.0 ... 100.0%	0.1%	± n x 2%
Watts Absolute	Depends on clamp scaling and V nominal		± 5% ± n x 2% ± 10 counts
Watts THD	0.0 ... 100.0%	0.1%	± 5%
Phase angle	-360° ... +0°	1°	± n × 1° (8)

*) ± 5 % if ≥ 1 % of nominal voltage; ± 0.05 % of nominal voltage if < 1% of nominal voltage.

Flicker	Measurement Range	Resolution	Accuracy
Plt, Pst, Pst (1min) Pinst	0.00 ... 20.00	0.01	± 5%

Unbalance	Measurement Range	Resolution	Accuracy
Volts %	0.0 ... 20.0%	0.1%	± 0.1%
Amps %	0.0 ... 20.0%	0.1%	± 1%

Mains Signaling	Measurement Range	Resolution	Accuracy
Threshold levels	Threshold, limits and signaling duration is programable for two signaling frequencies		
Signaling frequency	60 ... 3000 Hz	0.1 Hz	
Relative V%	0% .. 100%	0.1%	± 0.4%
Absolute V3s (3 second average)	0.0 ... 1000 V	0.1 V	± 5% of nominal voltage

Trend Recording	
Method	Automatically records min, max and average values over time for all readings being displayed for the 3 phases and neutral simultaneously
Sampling	5 readings/s continuous sampling per channel, 100/120 ¹ readings/s for ½ cycle values and Pinst
Recording time	1 hr up to 1 year, user selectable (default setting 7 days)
Averaging time	0.25 s to 2 hrs, user selectable (default 1s) 10 minutes when using Monitor mode
Memory	Data is stored on SD-card (8 GB included. 32 GB max)
Events: Fluke 434-II Fluke 435-II/437-II	Tabulated in event list Tabulated in event list, including 50/60 ¹ waveform cycles and 7.5s ½ cycle rms Voltage and Amps trend

MEASUREMENT METHOD

Vrms, Arms	10/12 ¹ contiguous non overlapping intervals using 500/416 ¹ samples per cycle in accordance with IEC 61000-4-30.
Vpeak, Apeak	Absolute highest sample value within 10/12 ¹ cycle interval with 40 µs sample resolution.
V Crest Factor	Measures ratio between the Vpeak and Vrms.
A Crest Factor	Measures ratio between the Apeak and Arms.
Hz	Measured every 10 sec in accordance with IEC61000-4-30. Vrms ^{1/2} , Arms ^{1/2} value is measured over 1 cycle, commencing at a fundamental zero crossing, and refreshed each half-cycle. This technique is independent for each channel in accordance with IEC 61000-4-30.

Harmonics	Calculated from 10/12-cycle gapless harmonic group measurements on Voltage and Amps according to IEC 61000-4-7
Watt	Full and fundamental real power display. Calculates average value of instantaneous power over 10/12 cycle period for each phase. Total Active Power $P_T = P_1 + P_2 + P_3$.
VA	Full and fundamental apparent power display. Calculates apparent power using $V_{rms} \times I_{rms}$ value over 10/12 cycle period.
var	Fundamental reactive power display. Calculates reactive power on fundamental positive sequence components. Capacitive and inductive load is indicated with capacitor and inductor icons.
VA Harmonics	Total disturbance power due to harmonics. Calculated for each phase and for total system based upon total apparent power and fundamental real power.
VA Unbalance	Unbalance power for total system. Calculated using symmetrical components method for fundamental apparent power and total apparent power.
Power Factor	Calculated Watt / VA
Cos ϕ	Cosine of angle between fundamental voltage and current
DPF	Calculated fundamental Watt/VA
Energy / Energy Cost	Power values are accumulated over time for kWh values. Energy cost is calculated from user defined /kWh cost variable
Unbalance	The supply voltage unbalance is evaluated using the method of symmetrical components according to IEC61000-4-30
Flicker	According to IEC 61000-4-15 flickermeter—functional and design specification. Includes 230 V / 50 Hz lamp and 120 V / 60 Hz lamp models.
Transient capture	Captures waveform triggered on signal envelope. Additionally triggers on dips, swells, interruptions and Amps level as specified by IEC61000-4-30.
Inrush current	The inrush current begins when the Arms half cycle rises above the inrush threshold, and ends when the Arms half cycle rms is equal to or below the inrush threshold minus a user-selected hysteresis value. The measurement is the square root of the mean of the squared Arms half cycle values measured during the inrush duration. Each half-cycle interval is contiguous and non-overlapping as recommended by IEC 61000-4-30. Markers indicate inrush duration. Cursors allow measurement of peak Arms half cycle.

Mains Signaling	Measurements are based on: either the corresponding 10/12-cycle rms value interharmonic bin or the rms of the four nearest 10/12-cycle rms value interharmonic bins per IEC 61000-4-30. Limit setup for Monitor mode follows EN50160 standard limits.
Time Synchronisation	Optional GPS430-II timesync module provides time uncertainty ≤ 20 ms or ≤ 16.7 ms for time tagging of events and time aggregated measurements. When synchronization is not available, time tolerance is ≤ 1 s/24h.

Transient capture	Measurement Range	Resolution	Accuracy
Volts cursor reading rms reading	± 6000 Vpk 10 ... 1000 Vrms	0.1 V 0.1 V	$\pm 15\%$ of cursor reading $\pm 2.5\%$ of Vnominal
Minimum detect duration	5 μ s		
Sampling rate	200kS/s		

WIRING COMBINATIONS

1 \emptyset + NEUTRAL	Single phase with neutral
1 \emptyset SPLIT PHASE	Split phase
1 \emptyset IT NO NEUTRAL	Single phase system with two phase voltages without neutral
3 \emptyset WYE	Three phase four wire system WYE
3 \emptyset DELTA	Three phase three wire system Delta
3 \emptyset IT	Three phase system without neutral WYE
3 \emptyset HIGH LEG	Four wire three phase Delta system with center tapped high leg
3 \emptyset OPEN LEG	Open delta three wire system with 2 transformer windings
2-ELEMENT	Three phase three wire system without current sensor on phase L2 / B (2 watt meter method)
2½-ELEMENT	Three phase four wire system without voltage sensor on phase L2 / B
INVERTER EFFICIENCY	dc voltage and current input with ac output power (automatically displayed and selected in Inverter Efficiency mode)

GENERAL



Case, Display, Memory, Real-time clock	
Case	Design Rugged, shock proof with integrated protective holster. Drip and dust proof IP51 according to IEC60529 when used in tilt stand position. The IP rating refers to non-operation of the Product and does not indicate that the Product should be used around hazardous voltages in wet environments. Shock and vibration: Shock 30 g, vibration 3 g sinusoid, random 0.03 g ² /Hz according to MIL-PRF-28800F Class 2.
Display	Brightness: 200 cd/m ² typ. using power adapter, 90 cd/m ² typical using battery power. Size 127 mm x 88 mm (153 mm/6.0 inch diagonal) LCD. Resolution 320 x 240 pixels. Contrast and brightness User-adjustable, temperature compensated.
Memory	8 GB SD-Card standard, upto 32 GB optionally. Screen save and multiple data memories for storing data including recordings (dependent on memory size).
Real-time clock	Time and date stamp for Trend mode, Transient display, System Monitor and event capture.

Environmental	
Operating temperature	0 °C ... +40 °C; +40 °C ... +50 °C excl. battery
Storage temperature	-20 °C ... +60 °C
Humidity	+10 °C ... +30 °C: 95 % RH non-condensing; +30 °C ... +40 °C: 75 % RH non-condensing; +40 °C ... +50 °C: 45 % RH non-condensing.
Maximum operating altitude	Up to 2,000 m (6666 ft) for CAT IV 600 V, CAT III 1000 V; up to 3,000 m (10,000 ft) for CAT III 600 V, CAT II 1000 V; Maximum storage altitude 12 km (40,000 ft).
Electro-Magnetic-Compatibility (EMC)	EN 61326 (2005-12) for emission and immunity.
Interfaces	mini-USB-B , Isolated USB port for PC connectivity SD-card slot accessible behind instrument battery
Warranty	Three years (parts and labor) on main instrument, one year on accessories.

MECHANICAL

Size	265 x 190 x 70 mm
Weight	2kg including standard battery

POWER

 Line power	Switchable 115V, 230V adapter with country specific plug
 Power Adapter input voltage	15 ... 23 V dc; Use only Power Adapter BC430
Battery power	Rechargeable Li-ion battery BP290 (installed)
Battery operating time BP290 (standard battery)	6.5 hours @ normal backlight 8 hours @ dimmed backlight 10.5 hours with display off
Charging time BP290	2.5 hours to 95 % (Analyzer off)
Battery operating time BP291 (optional battery)	13 hours @ normal backlight 16 hours @ dimmed backlight 21 hours with display off
Charging time BP291	5 hours to 95 % (Analyzer off)
Battery save	Adjustable time for dimmed backlight



INTERFACES

USB	USB 2.0 slave port. Max speed 460 k. Mini-USB input connector.
RS-232 Interface	Use special adapter cable DB-9 to Micro USB to connect GPS430 Time Synchronization Unit.
Baud rate	1200 ... 430 kb/s (No split baudrate available, receive and transmit baudrates are equal. Default baudrate is 1200.)
Stop bits	1
Data bits	8
Parity	No
Transmission mode	Asynchronous, full duplex
Handshake	Xon Xoff (Software handshake only)

STANDARDS

Measurement methods used	IEC61000-4-30 2 nd edition class A
Measurement performance	Fluke 435-II/437-II IEC61000-4-30 Class A, Fluke 434-II IEC61000-4-30 Class S
Power Quality	EN50160
Flicker	IEC 61000-4-15
Harmonics	IEC 61000-4-7

SAFETY

 Compliance with	IEC/EN61010-1-2001, CAN/CSA C22.2 No 61010-1-04 (including cCSA _{US} approval), UL std No 61010-1, Safety Requirements for Electrical Equipment for Measurement, Control and Laboratory Use, Part 1: General requirements. Rated: 600V CAT IV 1000V CAT III Pollution Degree 2
 Max voltage on banana input	1000 V CAT III / 600 V CAT IV.
 Max voltage on current BNC input	30 V max.

ELECTRO MAGNETIC COMPATIBILITY (EMC)

Compliance with	Fluke 434-II/435-II/437-II, including standard accessories, conforms to the EEC directive 2004/108/EC for EMC immunity as defined by EN-61326 (2005-12): it meets Performance Criteria A.
-----------------	---

¹ 50Hz/60Hz nominal frequency according to IEC 61000-4-30

² Measured on reference voltage input A/L1

Appendices

Appendix	Title	Page
	Measuring Methods	A-1
	Installing USB Drivers.....	B-1
	Instrument Security Procedures.....	C-1

Appendix A

Measuring Methods

Introduction

This appendix describes the power measurement and energy loss calculation methods used in the Fluke 430 Series II instruments.

Power Measurement Methods

The power measurement algorithms used in Fluke 430 Series II instruments are based upon the Unified Method developed at the Polytechnical University of Valencia, and build upon the IEEE1459 standard. These algorithms provide correct results at all conditions, even with distorted unbalanced three phase systems. These methods make it possible to calculate the energy that is lost if power quality is not optimal.

Energy Loss Calculation

The Energy Loss Calculator uses Line Power Loss (caused by the various currents flowing through the line resistance) and Residual Power Loss (caused by Harmonics and Unbalance) to measure the following losses in Ws (Joule):

Effective Loss line power loss due to active system current (this current does the actual work in transferring energy in the most optimal way. Loss reduction can be done by lowering line resistance for example by using thicker wires)

Reactive Loss line power loss due to reactive system current. Reactive energy itself does not cause losses.

Unbalance Loss line power loss due to unbalance system current and due to unbalance residual power.

Distortion Loss line power loss due to harmonic system current and due to harmonic residual power.

Neutral Loss line power loss due to neutral current.

The line resistance is either calculated automatically using an estimated 3% loss for the active system power, or it uses the values entered in the Function Preference setting.

The calculator shows an estimated cost using the measured values and the cost per kWh. For more accurate results long term measurements (for example one week/month) can be made showing results over time in the trend screen.

The Undefined Method

The Unified Method allows to split power measurement into meaningful components which can be used to identify the source of the various power components.

The various components are:

- Full Power contains harmonic and unbalance components, also called active power
- Fundamental Power contains unbalance components, no harmonic components
- Symmetrical Power contains no harmonic and no unbalance components
- Harmonic Power harmonic components only
- Unbalance Power unbalance components only

Furthermore distinction is made between:

- Phase Power powers of the individual phases A, B, C (or L1, L2, L3)
- System (Total) Power powers of the total multi-phase system

Note that the System Power is not always the sum of the phase powers!

The basis for power measurements are the voltage and current sample values measured on all inputs simultaneously. Power is measure over a 10/12 cycle (50/60Hz) time window (T_w) as required by IEC 61000-4-30.

$$\text{Voltage: } U_{\text{rms}} = \sqrt{\frac{1}{T_w} \sum_{n=0}^{T_w} u_n^2} \quad \text{in which } u_n \text{ are the voltage signal samples}$$

$$\text{Current: } I_{\text{rms}} = \sqrt{\frac{1}{T_w} \sum_{n=0}^{T_w} i_n^2} \quad \text{in which } i_n \text{ are the current signal samples}$$

FFT algorithms

FFT algorithms in accordance with IEC 61000-4-7 are used to calculate the fundamental and harmonic components of each input signal over a 10/12 cycle (50/60 Hz) time window. This time window is approximately 200ms but depends on the fundamental frequency as phase locked loop algorithms are required to capture an exact number of cycles.

Symmetrical components in Three-Phase Systems

In 1918, C. L. Fortescue published a paper called ‘Method of Symmetrical Coordinates Applied to the Solution of Polyphase Networks’ in the Transactions of the American Institute of Electrical Engineers. This paper describes a method to resolve an unbalanced set of 3-phasors into 2 balanced 3-phase systems of different phase sequence and one zero-phase system in which all phasors are of equal magnitude and angle.

This method can be used for voltage, current and power phasors.

The figure below shows three unbalanced voltage phasors resolved in three sets of symmetrical components.

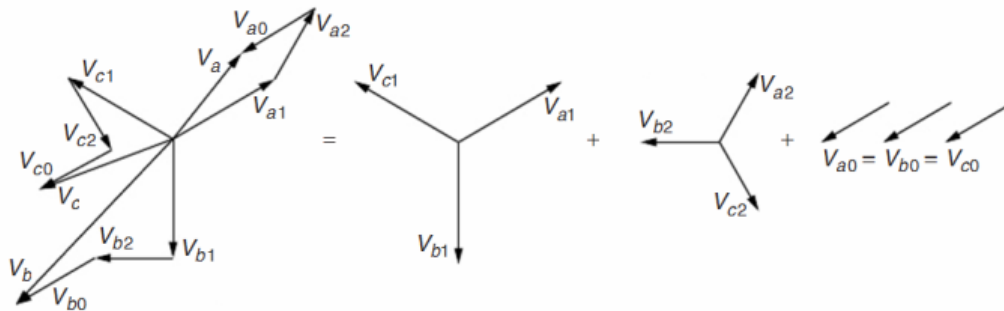

$$V_a = V_{a1} + V_{a2} + V_{a0}, \quad V_b = V_{b1} + V_{b2} + V_{b0}, \quad V_c = V_{c1} + V_{c2} + V_{c0}$$

V_a, V_b, V_c are three phasors that are not in balance and V_{a1}, V_{b1}, V_{c1} and V_{a2}, V_{b2}, V_{c2} are two sets of three balanced phasors with an angle of 120° between the components a, b, and c.

The components of the phasor set V_{a0}, V_{b0}, V_{c0} are identical in amplitude and angle.

V_{a1}, V_{b1}, V_{c1} is the positive sequence.

V_{a2}, V_{b2}, V_{c2} is the negative sequence

V_{a0}, V_{b0}, V_{c0} is the zero sequence.

The names zero, positive, and negative refer to the sequence of rotation of the phasors. The positive-sequence set of phasors (V_{a1}, V_{b1}, V_{c1}) is the same as the voltages produced by a synchronous generator in the power system that has phase sequence a-b-c. The negative sequence (V_{a2}, V_{b2}, V_{c2}) has phase sequence a-c-b, thus rotating the opposite direction compared to the positive system. The zero sequence phasors (V_{a0}, V_{b0}, V_{c0}) have zero-phase displacement and are identical.

The method of symmetrical components is used to calculate the power components not including harmonics and unbalance.

W - Active Power (P)

The active power (all frequency components) is directly calculated from the samples measured on the voltage and current inputs:

Active phase power:
$$P_X = \frac{1}{N} \sum_{n=K}^{K+N} u_X(n) \cdot i_X(n)$$

Active system power Y:
$$P_Y = P_A + P_B + P_C$$

System power is the sum of the phase powers!

Active system power Δ :
$$P_{\Delta} = \frac{1}{N} \sum_{n=K}^{K+N} u_{AB}(n) \cdot i_A(n) - u_{BC}(n) \cdot i_C(n)$$

W fund - Fundamental Active Power(P1)

The fundamental powers (50/60 Hz component only) are calculated using the FFT results which are calculated according to IEC 61000-4-7 grouping into the first harmonic subgroup. These RMS values are here called U_{1X} for voltage and I_{1X} for current. The phase-angle between voltage and current is $\varphi_{u_{1X}} - \varphi_{i_{1X}}$.

Fundamental active phase power:
$$P_{1X} = U_{1X} \cdot I_{1X} \cdot \cos(\varphi_{u_{1X}} - \varphi_{i_{1X}})$$

Fundamental active system power Y:
$$P_1^+ = 3 \cdot U_1^+ \cdot I_1^+ \cdot \cos(\varphi_{u_1^+} - \varphi_{i_1^+})$$

In this case the system power is NOT the sum of the phase powers! The system power is calculated from the positive sequence components of voltage and current, eliminating all unbalance components. This component is also called Effective power as it is the most effective way to transfer power (electrical into mechanical) if it would only consist of the positive sequence power component.

Fundamental active system power Δ :
$$P_{1\Delta} = U_{1AB} \cdot I_{1A} \cdot \cos(\varphi_{u_{1AB}} - \varphi_{i_{1A}}) - U_{1BC} \cdot I_{1C} \cdot \cos(\varphi_{u_{1BC}} - \varphi_{i_{1C}})$$

VA – Apparent Power (S)

The apparent power (all frequency components) is calculated from the RMS values of voltage U_X and current I_X .

Apparent phase power:
$$S_X = U_X \cdot I_X$$

Apparent system power Y:
$$S_Y = \sqrt{(U_A^2 + U_B^2 + U_C^2) \cdot (I_A^2 + I_B^2 + I_C^2)}$$

Apparent system power is NOT the sum of the phase powers!

Apparent system power Δ :
$$S_{\Delta} = \sqrt{(U_{AB}^2 + U_{BC}^2 + U_{CA}^2) \cdot (I_A^2 + I_B^2 + I_C^2)} / 3$$

VA fund - Fundamental Apparent Power (S)

Fundamental apparent phase power: $S_{IX} = U_{IX} \cdot I_{IX}$

Fundamental apparent system power Y: $S_{1Y} = \sqrt{(U_{1A}^2 + U_{1B}^2 + U_{1C}^2) \cdot (I_{1A}^2 + I_{1B}^2 + I_{1C}^2)}$

Apparent system power is NOT the sum of the phase powers!

Fundamental apparent system power Δ: $S_{1\Delta} = \sqrt{(U_{1AB}^2 + U_{1BC}^2 + U_{1CA}^2) \cdot (I_{1A}^2 + I_{1B}^2 + I_{1C}^2)} / 3$

var –Fundamental Reactive Power (Q)

For reactive power only the fundamental power is of interest.

Fundamental reactive phase power: $Q_{IX} = U_{IX} \cdot I_{IX} \cdot \sin(\varphi_{u_{IX}} - \varphi_{i_{IX}})$

Fundamental reactive system power Y and Δ: $Q_1^+ = 3 \cdot U_1^+ \cdot I_1^+ \sin(\varphi_{u_1^+} - \varphi_{i_1^+})$

Apparent reactive system power is NOT the sum of the phase powers!

VA Harmonics Power (Dh)

Harmonics powers are calculated using the full apparent power S_X and the fundamental apparent power S_{IX} .

Harmonic distortion power: $Dh_X = \sqrt{S_X^2 - S_{IX}^2}$

Harmonic distortion system power Y and Δ: $Dh = \sqrt{S^2 - S_1^2}$

Harmonic distortion system power is NOT the sum of the phase powers!

VA Unbalance Power (Du)

Unbalance powers cannot be measured per phase. Unbalance is only measured on system level.

Unbalance is calculated from the fundamental system apparent power and the positive sequence component of the system apparent power.

Unbalance system power Y and Δ: $Du = \sqrt{S_1^2 - S_1^{+2}}$

Power Factor (PF)

Power Factor indicates system effectiveness at full bandwidth and is calculated from full spectrum power (up to 50th harmonic) and apparent power.

Power factor: $PF_X = P_X / S_X$

System power factor Y and Δ: $PF = P / S$

Displacement Power Factor (DPF) and Cos ϕ

Displacement power factor is calculated from fundamental power and apparent power components. This identical to the Cos ϕ of the phase angle between fundamental voltage and current.

Displacement Power Factor: $PF_{IX} = P_{IX}/S_{IX}$

System Displacement Power Factor Y and Δ : $PF_1 = P_1^+/S_1^+$

Power & Energy Losses

Energy Loss has 2 main components:

- Line Power Loss, caused by the various currents flowing through the line resistance ($I^2.R$ losses)
- Residual Power Loss, caused by Harmonics and Unbalance

Using the method of symmetrical components the system current components are calculated.

Active system current: $I_{1a}^+ = I_1^+ \cdot \cos(\phi_{u_1^+} - \phi_{i_1^+})$

Reactive system current: $I_{1r}^+ = I_1^+ \cdot \sin(\phi_{u_1^+} - \phi_{i_1^+})$

Harmonic system current: $I_H = \sqrt{I_{HA}^2 + I_{HB}^2 + I_{HC}^2}$

Unbalance system current: $I_U = \sqrt{I_1^{-2} + I_1^{02}}$

Neutral current: Measured directly when using 4 wire (wye) systems

In combination with wiring resistance the line power losses due to this currents can be calculated ($P=I^2 \cdot R$)

Residual Power Loss is the loss caused by Harmonic power and Unbalance power. Reactive Power (var) in itself causes no losses other than $I^2.R$ losses in the wiring.

Residual harmonic power loss: $P_H = P - P_1$

Residual unbalance power loss: $P_U = P_1 - P_1^+$

Classic Method

The default setting for the Fluke 430 series II instruments is to use the Unified method to measure power. For compatibility reason with guidelines that may exist within companies, there is also a 'classic' method available that utilizes the arithmetic method for system power as described in IEEE 1459. The method can be changed via the Function Preference menu. To indicate that classic system with the arithmetic sum method is used to calculate system power a Σ (sigma) symbol is used behind the power parameters e.g. VA Σ .

Symbols used in formulas:

P	- is used for power Watt
S	- is used for apparent power VA
Q	- is used for reactive power var
Dh	- is used for harmonics power
Du	- is used for unbalance power
PF	- Power Factor
DPF	- Displacement Power Factor
P_1	- subscript 1 is used to indicate fundamental frequency components
P_1^+	- superscript + is used to indicate positive sequence components
Σ	- (sigma) indicates summing of components. Sigma is also used to indicate that classic method is used.
u	- is used for voltage sample
i	- is used for current samples
T_w	- Time window of 10/12 cycles at 50/60 Hz
N	- number of samples in 10/12 cycle periods
K	- first sample of T_w record
n	- sample number
U	- is used for rms voltage calculated from samples over a 10/12 cycle window
I	- is used for rms current calculated from samples over a 10/12 cycle window
X	- is used to indicate phase A, B, C (or L1, L2, L3)
Y	- is used to indicate 4 wire wye configuration
Δ	- is used to indicate 3 wire delta configuration

Appendix B

Installing USB Drivers

Introduction

The Fluke 430 Series II Power Quality and Energy Analyzer comes with a USB interface and cable (connector type: 'USB mini-B') for establishing a communications link with a personal computer. For the PC to be able to communicate with the instrument, drivers need to be installed on to the computer.

This document describes how to install such drivers on a Windows XP computer. Installation on other Windows platforms will be similar but screens may look different.

Drivers for Windows XP, Vista and Win-7 are available from the Windows Driver Distribution Center and can be downloaded automatically if your computer is connected to the internet. When no internet access is available, drivers may be installed from the user manual CD-Rom.

The drivers have passed Windows Logo Verification and are signed by Microsoft Windows Hardware Compatibility Publisher, as is required for installation on to Win-7 PCs.

Note:

The Fluke 430 Series II Power Quality and Energy Analyzers require two separate drivers to be installed:

- a Fluke 430 series II USB driver*
- a dedicated Fluke USB Serial port driver.*

Both these drivers need to be installed in order for the PC to be able to communicate with the Series II Power Quality Analyzer.

Installing the USB Drivers

To install the USB drivers, do the following:

- 1** Connect the Fluke 430 Series II instrument to the PC, using the USB-cable supplied with the instrument. The cable may be plugged in and out even when both the computer and the instrument are switched on ('hot-swap'), it is not required to power either one down.

When the appropriate drivers for the Fluke 430 series II instrument have not yet been installed, Windows will show that New Hardware is detected and the Wizard for the installation of new drivers will open.

Depending on your PC settings and operating system, Windows may ask for permission to search the Windows Update Web site on the internet for the latest revision. If you have internet access at such moment, it is recommended to select "Yes", then "Next", so as to get the latest revision of the drivers.

In case no internet access is available, install the drivers from the CD-ROM or from a location on the hard drive. For that, select "No, not this time".

- 2** In the following window, click "Next" to install the software automatically. In case drivers should be loaded from CD-ROM, select 'select from a list or specific location' instead.

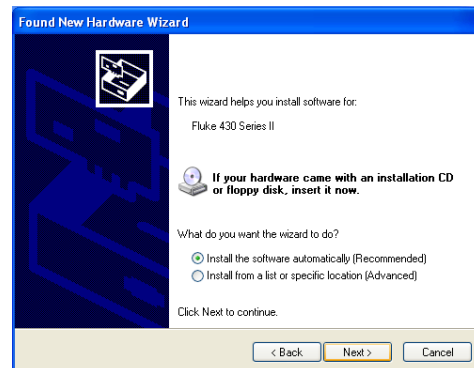

- 3 While downloading, this screen will show. Wait for the download to complete.
- 4 When the driver has downloaded completely and has been installed, click “Finish” to accept this installation of this first driver.
- 5 After completion of the first step, the New Hardware Wizard will start again so as to install the USB Serial Port Driver.

Like before, click “Yes” if downloading the driver from the internet is alright. Click “Next” to actually install the software automatically. When no internet access is available, load the driver from the CD-ROM, supplied with the instrument.
- 6 Follow the instructions on screen.

Once the installation of the second driver has been completed, click “Finish”.

You are now ready to use the Power Quality Analyzer with Fluke software. You may want to check the Fluke website to see what software is available to support the Fluke 430-series II of Power Quality Analyzers.

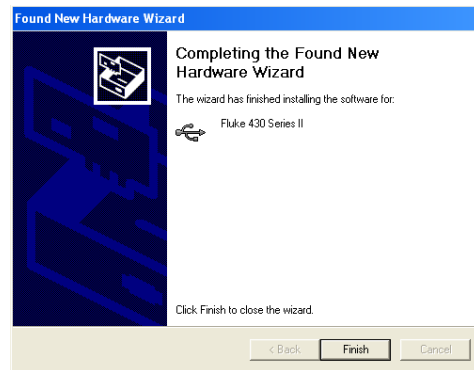
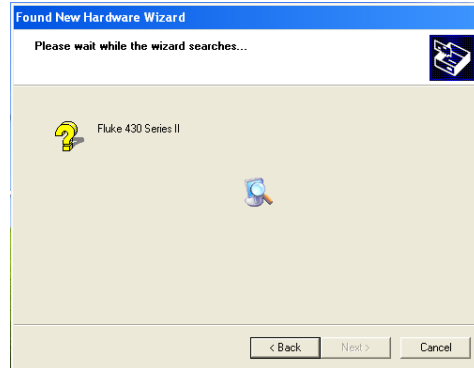

7 To check if the drivers have been installed properly, connect the Power Quality Analyzer 430 Series II to your computer and open the Device Manager (see below).

From the device manager click on the + sign or ► symbol to expand the ‘Universal Serial Bus controllers’ group. The ‘Fluke 430 Series II’ instrument should now be listed here.

From the device manager click on the + sign or ► symbol to expand the ‘Ports (COM & LPT)’ group. The ‘Fluke USB Serial Port (COMx)’ should now be listed here.

Note that the COM-port number may differ as this is automatically assigned by Windows.

Accessing the device manager from within Windows XP is like this:

Click START and select the ‘Control Panel’.

- When in Classic View mode, select ‘System’, then the tab ‘Hardware’.
- Or when in Category View mode, select ‘Performance and Maintenance’, then ‘System’. Here, you’ll find the tab ‘Hardware’, just like described above.

Once you open the Hardware tab, you should see a selection field ‘Device Manager’.

From within Win-7, the device manager becomes accessible as soon as you open the control panel.

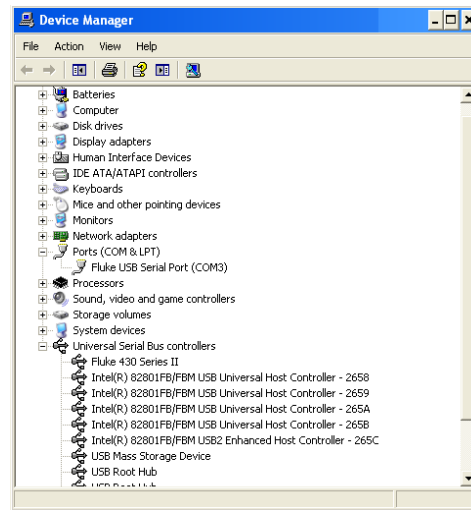

Notes

- 1) *Sometimes application software may require a different port number (for example in the range Com 1....4). In such case, the COM port number can be changed manually.
To manually assign a different COM port number right click on 'Fluke USB Serial Port COM(5)' and select 'properties'. From the Properties menu, select the Port Settings tab, and click 'Advanced...' to change the port number.*
- 2) *Some application programs automatically occupy specific COM-ports, including the newly created port. Usually, this can be overcome by disconnecting the Fluke 430 Series II Power Quality Analyzer's USB cable and then re-connecting the cable.*

Appendix C

Instrument Security Procedures

Introduction

Model Numbers:

Fluke 434-II, Fluke 435-II, Fluke 437-II

Short Description:

3-Phase Energy & Power Quality Analyzer

Memory.

Fluke 43x-II has the following memory devices:

1. RAM 8M x 16, U901, type: e.g. MT47H64M16HR-25IT:H, contains: temp storage of measuring data
2. Video RAM 256k x 16, D1001, type: e.g. CY62146EV30LL, contains: storage of data to be displayed on LCD-screen.
3. Flash-ROM 16M x 2, U1100, U1101, type: e.g. MW29W160EB, contains: the instrument's embedded software and calibration data. Also Analyzer settings such as Config, Freq, Vnom, Limits, and Current Clamp data that differ from Factory Default are stored here.
4. FIFO (First In First Out) RAM 2kB, U801, type: e.g. SN74V235-7PAG, contains: data to be exchanged between DSP and Microcontroller.
5. SRAM 16 Mb x 2, D1100, D1103, type: e.g. CY62167DV30LL, contains: temporary data storage for microcontroller.
6. SD Memory Card. Contains: all datasets, screens, and logging data.

Security Summary:

- Ad 1. Memory contents erased at power-off. No user access.
- Ad 2. Memory contents erased at power-off. No user access.
- Ad 3. Flash memory: contents stays available at power off and disconnection of the Li-ion accumulator (can be loaded/exchanged with dedicated PC software that is exclusively available in manufacturing and Fluke service). Note: the calibration data is generated when the analyzer is sent through its calibration process and are fundamental to the meter operation.
To erase Analyzer settings that differ from Factory Default, do the following key operations: SETUP, function key F1 – USER PREF, F1 – FACTORY DEFAULTS, F5 – YES (confirm menu).
- Ad 4. Memory contents erased at power-off. No user access.
- Ad 5. Memory contents erased at power-off. No user access.
- Ad 6. There are 2 ways of removing measurement data from the Analyzer:
 - 1 - The SD Card is located in the battery-compartment at the rear of the Analyzer. Open the compartment with a small screwdriver. Push the SD Card in the direction of the arrow and take it out of the Analyzer. All measurement data now has been removed from the Analyzer. Avoid touching the contacts of the Card with you hands. When reinstalling the Card take careful notice of the indication in the battery compartment.
 - 2 - All measurement data at the SD memory card is erased by formatting it. The format action occurs via a confirm menu. Do the following key operations with the SD Card installed in the Analyzer: SETUP, function key F1 – USER PREF, F4 – FORMAT SD CARD, F5 – YES.

Index

—1—

150/180 cycle, 5-3

—3—

3 s, 5-3

—A—

A range, 23-7

Accessories, 1-1

Aggregation interval, 5-3

—B—

Banana Inputs, 6-1

Bar Graph screen, 5-2

Battery Charger, 1-6

Battery Condition, 25-1

battery pack

safe disposal, 1-9

safe transport, 1-8

 safe use, 1-7, 1-8

storage, 1-7

Battery save, 23-5

BNC Inputs, 6-1

Brightness, 4-6

—C—

Calibration, 26-1

Capacitive load, 11-2

CF, 8-1

Change Offset and Span, 23-11

Change wiring config, 23-9

Characteristics, 26-1

Charge Batteries, 4-2

CHG, 8-3, 9-5, 16-7, 21-4

Clamp, 23-7

Cleaning, 25-1

Clear all, 23-5

Clock, 5-4

Colors, 5-2, 23-5

Configuration, 5-4

Configuration, wiring, 23-7

Contrast, 4-7

Contrast adjustment, 23-5

Count down, 5-3

Crest Factor, 8-1

Current clamps, 6-2

Cursor, 22-1

—D—

Date, 5-4

DC, 10-1

Decals, 6-1

Defaults, 4-7

Demo Mode, 23-5

DIP, 8-3, 9-5, 16-7, 21-4

Dips, 9-1

DIRS, 16-1

Display, 4-6

Duration, 9-1

—E—

Efficiency, 13-1

Energy Loss, 12-1

—F—

F1 ... F5, 5-4

Factory defaults, 23-5

Features, 3-1

Filtering Harmonics, 10-2

Flagged, 5-3

Flicker, 17-1

Fluke 435, 3-1

Freq, 23-7

Frequency nominal, 5-4

Full, 11-1
Fundamental, 11-1

—G—

GPS signal, 5-4

—H—

Hang Strap, 4-1
Harmonics, 10-1
Hx, 16-7
Hysteresis, 9-1

—I—

Inductive load, 11-2
Inputs, 6-1
Inrush currents, 15-1
Inrush time, 15-2
INT, 8-3, 9-5, 16-7, 21-4
Interharmonics, 10-1
Interruptions, 9-1

—K—

Keyboard Lock, 4-6
K-factor, 10-1

—L—

Language, 23-4
Limits, 5-4, 16-2
Limits Setup, 23-13
Lock, 4-6
Locked keyboard, 5-3
Logger, 21-1
Logging, 21-1
Long term severity, 17-2
Luminance fluctuation, 17-1

—M—

Magnitude, 9-1
Mains Signaling, 16-1, 20-1
Manual, 2-1
Measuring mode, 5-3
Measuring modes, 3-2
Measuring values, 5-3
Memory, 24-1
Memory Config, 23-4
Menu Navigation, 4-6
Meter screen, 5-2
Monitor, 3-1, 16-1

—N—

Negative sequence, 10-4, 14-4
Numerical values, 8-1

—O—

Optional parts, 25-2
Oscilloscope, 7-1

—P—

Parts, 25-2
PC, 24-4
Persistence, 12-2
Phase Colors, 5-2
Phase Identification, 23-4
Phasor Preference, 7-2, 14-3
Phasor screen, 5-2, 7-2
Positive sequence, 10-4, 14-4
Power, 4-2
Power Adapter, 1-6
Power and Energy, 11-1
Power Inverter, 13-1
Power Quality Monitor, 16-1
Power Wave, 19-1
Present values, 4-6, 23-1
Printer, 24-4
Probability, 16-3

—R—

Rapid Voltage Changes, 9-1
Readings Select, 21-1
Recording, 5-3
Reference phase, 6-3
Reset, 4-7
RS-232 Setup, 23-5

—S—

Safety, 1-1
Scope Recorder, 19-1
Screen Types, 5-1
Service Center, 1-1
Shipment Note, 1-1
Short term severity, 17-2
Shrink display, 22-1
Signal Polarity, 6-2
Signaling, 20-1
Single phase, 6-3
Sliding reference voltage, 9-1
Softkeys, 5-4
Standard parts, 25-2
Status indicators, 5-3
Status line, 5-4
Stickers, 6-1
Storage, 25-1
Stretch display, 22-1
Swells, 9-1
SWL, 8-3, 9-5, 16-7, 21-4
Symbols, 5-3, 16-7
System Monitor, 16-1
System Monitor, 3-1

—T—

Technical data, 26-1
THD, 10-1
Threshold, 9-1, 15-2
Tilt Stand, 4-1
Time, 5-3, 5-4
Transients, 18-1
Trend screen, 5-2
Troubleshooting, 25-3

—U—

U, Unstable, 5-3
Unbalance, 14-1
Usage, 11-1
User ID, 23-5
Users Manual, 2-1
Using Memory, 24-1

—V—

Vector diagram, 7-2
Version & Cal, 23-3
Vnom, 23-7
Voltage nominal, 5-4
Voltage range, 1-6
Volts/Amps/Hertz, 8-1

—W—

Warranty, 1-1
Waveform screen, 5-2
Wiring configuration, 5-4

—Z—

Zero sequence, 10-4, 14-4
Zoom, 22-1

This page is for holding the Reference Document (RD) fields. Do not remove from this master document.
All RD fields will be placed after this text.

