

FLUKE®

Tequipment
NET



205 Westwood Ave
Long Branch, NJ 07740
1-877-742-TEST (8378)
Fax: (732) 222-7088
salesteam@Tequipment.NET

43B

Power Quality Analyzer

Service Manual

4822 872 05385

December 2001

© 2001 Fluke Corporation, All rights reserved. Printed in the Netherlands
All product names are trademarks of their respective companies.

SERVICE CENTERS

To locate an authorized service center, visit us on the World Wide Web:

<http://www.fluke.com>

or call Fluke using any of the phone numbers listed below:

+1-888-993-5853 in U.S.A. and Canada

+31-402-678-200 in Europe

+1-425-446-5500 from other countries

Table of Contents

Chapter	Title	Page
1	Safety Instructions	1-1
	1.1 Introduction	1-3
	1.2 Safety Precautions	1-3
	1.3 Caution and Warning Statements	1-3
	1.4 Symbols	1-3
	1.5 Impaired Safety	1-4
	1.6 General Safety Information	1-4
2	Characteristics	2-1
	2.1 Introduction	2-3
	2.2 Safety Specifications	2-3
	2.3 Function Specifications	2-4
	2.3.1 Electrical functions	2-4
	2.3.2 Scope	2-5
	2.3.3 Meter	2-7
	2.3.4 Record	2-7
	2.4 Miscellaneous	2-8
	2.5 Current Probe	2-8
	2.6 Environmental Conditions	2-9
	2.7 Electromagnetic Immunity	2-10
3	Circuit Descriptions	3-1
	3.1 Introduction	3-3
	3.2 Block Diagram	3-3
	3.2.1 Input 1 - Input 2 Measurement Circuits	3-3
	3.2.2 Trigger Circuit	3-5
	3.2.3 Digital Circuit	3-5
	3.2.4 Power Circuit	3-6
	3.2.5 Start-up Sequence, Operating Modes	3-7
	3.3 Detailed Circuit Descriptions	3-9
	3.3.1 Power Circuit	3-9
	3.3.2 Input 1 - Input 2 Measurement Circuits	3-14
	3.3.3 Trigger Circuit	3-20

3.3.4 Digital Circuit.....	3-24
4 Performance Verification.....	4-1
4.1 Introduction.....	4-3
4.2 Equipment Required For Verification.....	4-3
4.3 How To Verify.....	4-3
4.4 Display and Backlight Test.....	4-4
4.5 Input 1 and Input 2 Tests in the SCOPE MODE.....	4-5
4.5.1 Input 1 Trigger Sensitivity Test.....	4-6
4.5.2 Input 1 Frequency Response Upper Transition Point Test.....	4-7
4.5.3 Input 1 Frequency Measurement Accuracy Test.....	4-7
4.5.4 Input 2 Frequency Measurement Accuracy Test.....	4-9
4.5.5 Input 2 Trigger Level and Trigger Slope Test.....	4-10
4.5.6 Input 2 Trigger sensitivity Test.....	4-12
4.5.7 Input 1 Trigger Level and Trigger Slope Test.....	4-13
4.5.8 Input 1 and 2 DC Voltage Accuracy Test.....	4-15
4.5.9 Input 1 and 2 AC Voltage Accuracy Test.....	4-17
4.5.10 Input 1 and 2 AC Input Coupling Test.....	4-19
4.5.11 Input 1 and 2 Volts Peak Measurements Test.....	4-20
4.5.12 Input 1 and 2 Phase Measurements Test.....	4-21
4.5.13 Input 1 and 2 High Voltage AC & DC Accuracy Test.....	4-22
4.6 Ohms/Continuity/Capacitance.....	4-25
4.6.1 Resistance Measurements Test.....	4-25
4.6.2 Diode Test Function Test.....	4-26
4.6.3 Continuity Function Test.....	4-26
4.6.4 Capacitance Measurements Test.....	4-27
4.7 Inrush Current.....	4-28
4.8 Sags & Swells.....	4-29
4.9 Harmonics.....	4-30
4.10 VOLT/AMPS/HERTZ.....	4-30
4.11 POWER.....	4-31
4.12 Transients.....	4-32
5 Calibration Adjustment.....	5-1
5.1 General.....	5-3
5.1.1 Introduction.....	5-3
5.1.2 Calibration number and date.....	5-3
5.1.3 General Instructions.....	5-4
5.2 Equipment Required For Calibration.....	5-4
5.3 Starting Calibration Adjustment.....	5-4
5.4 Contrast Calibration Adjustment.....	5-6
5.5 Warming Up & Pre-Calibration.....	5-7
5.6 Final Calibration.....	5-7
5.6.1 HF Gain Input 1.....	5-8
5.6.2 Delta T Gain, Trigger Delay Time & Pulse Adjust Input 1.....	5-9
5.6.3 Gain DMM (Gain Volt).....	5-10
5.6.4 Volt Zero.....	5-12
5.6.5 Gain Ohm.....	5-12
5.6.6 Capacitance Gain Low and High.....	5-13
5.6.7 Capacitance Clamp & Zero.....	5-14
5.6.8 Capacitance Gain.....	5-14
5.7 Save Calibration Data and Exit.....	5-15
6 Disassembling.....	6-1

6.1. Introduction.....	6-3
6.2. Disassembling Procedures	6-3
6.1.1 Required Tools	6-3
6.2.2 Removing the Battery Pack	6-3
6.2.3 Removing the Bail	6-3
6.2.4 Opening the Test Tool	6-3
6.2.5 Removing the Main PCA Unit.....	6-5
6.2.6 Removing the Display Assembly.....	6-6
6.2.7 Removing the Keypad and Keypad Foil.....	6-6
6.3 Disassembling the Main PCA Unit.....	6-6
6.4 Reassembling the Main PCA Unit.....	6-8
6.5 Reassembling the Test Tool.....	6-8
7 Corrective Maintenance	7-1
7.1 Introduction.....	7-3
7.2 Starting Fault Finding.....	7-4
7.3 Charger Circuit.....	7-4
7.4 Starting with a Dead Test Tool	7-6
7.4.1 Test Tool Completely Dead.....	7-6
7.4.2 Test Tool Software Does not Run.....	7-7
7.4.3 Software Runs, Test Tool not Operative	7-7
7.5 Miscellaneous Functions.....	7-7
7.5.1 Display and Back Light	7-7
7.5.2 Fly Back Converter.....	7-8
7.5.3 Slow ADC.....	7-9
7.5.4 Keyboard.....	7-10
7.5.5 Optical Port (Serial RS232 Interface).....	7-11
7.5.6 Input Channel 1 and 2 Voltage Measurements.....	7-11
7.5.7 Ohms and Capacitance Measurements	7-12
7.5.8 Trigger Functions.....	7-13
7.5.9 Reference Voltages.....	7-14
7.5.10 Buzzer Circuit.....	7-14
7.5.11 Reset ROM Line (ROMRST).....	7-14
7.5.12 RAM Test	7-14
7.5.13 Power ON/OFF	7-15
7.5.14 PWM Circuit.....	7-15
7.5.15 Randomize Circuit.....	7-15
8 List of Replaceable Parts.....	8-1
8.1 Introduction.....	8-3
8.2 How to Obtain Parts.....	8-3
8.3 Final Assembly Parts	8-4
8.4 Main PCA Unit Parts	8-6
8.5 Main PCA Parts	8-7
8.6 Accessory Replacement Parts	8-23
9 Circuit Diagrams.....	9-1
9.1 Introduction.....	9-3
9.2 Schematic Diagrams.....	9-3
10 Modifications	10-1
10.1 Software modifications	10-3
10.2 Hardware modifications.....	10-3

List of Tables

Table	Title	Page
1-1.	Symbols	1-3
2-1.	No Visible Disturbance	2-10
2-2.	Disturbance < 1 %	2-10
2-3.	Disturbance < 10 %	2-10
3-1.	Fluke 43B Main Blocks	3-3
3-2.	Fluke 43B Operating Modes	3-8
3-3.	Input 1 Voltage Ranges And Trace Sensitivity	3-17
3-4.	Ohms Ranges, Trace Sensitivity, and Current	3-18
3-5.	Capacitance Ranges, Current, and Pulse Width	3-19
3-6.	D-ASIC PWM Signals	3-27
4-1.	Input 1 Frequency Measurement Accuracy Test	4-8
4-2.	Volts DC Measurement Verification Points	4-17
4-3.	Volts AC Measurement Verification Points	4-19
4-4.	Input 1 and 2 AC Input Coupling Verification Points	4-20
4-5.	Volts Peak Measurement Verification Points	4-21
4-6.	Phase Measurement Verification Points	4-22
4-7.	V DC and V AC High Voltage Verification Tests	4-25
4-8.	Resistance Measurement Verification Points	4-26
4-9.	Capacitance Measurement Verification Points	4-27
4-10.	Volts/AMPS/HERZ verification points	4-31
4-11.	Power Measurement Verification points	4-31
5-1.	HF Gain Calibration Points Fast	5-9
5-2.	HF Gain Calibration Points Slow	5-9
5-3.	Volt Gain Calibration Points <300V	5-11
5-4.	Ohm Gain Calibration Points	5-13
7-1.	Starting Fault Finding	7-4
8-1.	Final Assembly Parts	8-4
8-2.	Main PCA Unit	8-6
8-3.	Main PCA	8-7
9-1.	Parts Location Main PCA Side 1	9-4
9-2.	Parts Location Main PCA Side 2	9-5

List of Figures

Figure	Title	Page
2-1.	Max. Input Voltage vs. Frequency	2-4
3-1.	Fluke 43 Block Diagram.....	3-2
3-2.	Fluke 43 Start-up Sequence, Operating Modes.....	3-8
3-3.	Power Supply Block Diagram.....	3-9
3-4.	CHAGATE Control Voltage.....	3-11
3-5.	Fly-Back Converter Current and Control Voltage	3-12
3-6.	Fly-Back Converter Block Diagram.....	3-13
3-7.	Back Light Converter Voltages	3-14
3-8.	C-ASIC Block Diagram.....	3-15
3-9.	Capacitance Measurement.....	3-19
3-10.	T-ASIC Trigger Section Block Diagram.....	3-20
3-11.	Random Repetitive Sampling Mode	3-22
3-12.	Reference Voltage Section	3-23
3-13.	LCD Control.....	3-26
4-1.	Display Pixel Test Pattern	4-4
4-2.	Test Tool Input 1 to 5500A Scope Output 50 Ω	4-6
4-3.	Test Tool Input 2 to 5500A NORMAL output.....	4-9
4-4.	Test Tool Input 1 to 5500A Normal Output.....	4-13
4-5.	Test Tool Input 1-2 to 5500A Normal Output.....	4-15
4-6.	Test Tool Input 1-2 to 5500A Normal Output for >300V.....	4-23
4-7.	Test Tool Input 1 to 5500A Normal Output 4-Wire	4-25
4-8.	Test Tool Input 2 to 5500A NORMAL output.....	4-28
4-9.	Test Tool Input 1 & 2 5500A Normal Output.....	4-29
4-10.	Bargraph Harmonics Volt	4-30
4-11.	Bargraph Harmonics Ampere.....	4-30
4-12.	Test Tool Input 1 to 5500A Normal Output.....	4-32
5-1.	Version & Calibration Screen	5-3
5-2.	Display Test Pattern	5-7
5-3.	HF Gain Calibration Input Connections.....	5-8
5-4.	5500A Scope Output to Input 1	5-10
5-5.	Volt Gain Calibration Input Connections <300V	5-11
5-6.	Volt Gain Calibration Input Connections 500V.....	5-12
5-7.	Four-wire Ohms calibration connections	5-13
5-8.	Capacitance Gain Calibration Input Connections	5-14
6-1.	Fluke 43 Main Assembly.....	6-4

6-2.	Flex Cable Connectors	6-5
6-3.	Main PCA Unit Assembly.....	6-7
6-4.	Mounting the display shielding bracket	6-9
6-5.	Battery pack installation.....	6-9
7-1.	Operative Test Tool without Case.....	7-3
8-1.	Fluke 43 Final Assembly.....	8-5
8-2.	Main PCA Unit.....	8-6
9-1.	Circuit Diagram 1, Channel 1 Circuit	9-7
9-2.	Circuit Diagram 2, Channel 2 Circuit	9-8
9-3.	Circuit Diagram 3, Trigger Circuit.....	9-9
9-4.	Circuit Diagram 4, Digital Circuit.....	9-10
9-5.	Circuit Diagram 4 (cont), Digital Circuit Keyboard	9-11
9-6.	Circuit Diagram 5, Power Circuit.....	9-12
9-7.	Main PCA side 1, PCB version 3	9-13
9-8.	Main PCA side 2, PCB version 3	9-14

Chapter 1

Safety Instructions

Title	Page
1.1 Introduction.....	1-3
1.2 Safety Precautions.....	1-3
1.3 Caution and Warning Statements.....	1-3
1.4 Symbols.....	1-3
1.5 Impaired Safety.....	1-4
1.6 General Safety Information.....	1-4

1.1 Introduction

Read these pages carefully before beginning to install and use the instrument.

The following paragraphs contain information, cautions and warnings which must be followed to ensure safe operation and to keep the instrument in a safe condition.

Warning

Servicing described in this manual is to be done only by qualified service personnel. To avoid electrical shock, do not service the instrument unless you are qualified to do so.

1.2 Safety Precautions

For the correct and safe use of this instrument it is essential that both operating and service personnel follow generally accepted safety procedures in addition to the safety precautions specified in this manual. Specific warning and caution statements, where they apply, will be found throughout the manual. Where necessary, the warning and caution statements and/or symbols are marked on the instrument.

1.3 Caution and Warning Statements

Caution

Used to indicate correct operating or maintenance procedures to prevent damage to or destruction of the equipment or other property.









Warning

Calls attention to a potential danger that requires correct procedures or practices to prevent personal injury.

1.4 Symbols

Table 1-1 shows the symbols used on the test tool or in this manual.

Table 1-1. Symbols

	Read the safety information in the Users Manual		DOUBLE INSULATION (Protection Class)
	Equal potential inputs, connected internally		Static sensitive components (black/yellow).
	Live voltage		Recycling information
	Earth		Disposal information
	Conformité Européenne		

1.5 Impaired Safety

Whenever it is likely that safety has been impaired, the instrument must be turned off and disconnected from line power. The matter should then be referred to qualified technicians. Safety is likely to be impaired if, for example, the instrument fails to perform the intended measurements or shows visible damage.

1.6 General Safety Information

Warning

Removing the instrument covers or removing parts, except those to which access can be gained by hand, is likely to expose live parts and accessible terminals which can be dangerous to life.

The instrument shall be disconnected from all voltage sources before it is opened.

Capacitors inside the instrument can hold their charge even if the instrument has been separated from all voltage sources.

Components which are important for the safety of the instrument may only be replaced by components obtained through your local FLUKE organization. These parts are indicated with an asterisk (*) in the List of Replaceable Parts, Chapter 8.

Chapter 2

Characteristics

Title	Page
2.1 Introduction	2-3
2.2 Safety Specifications	2-3
2.3 Function Specifications	2-4
2.3.1 Electrical functions	2-4
2.3.2 Scope	2-5
2.3.3 Meter	2-7
2.3.4 Record	2-7
2.4 Miscellaneous	2-8
2.5 Current Probe	2-8
2.6 Environmental Conditions	2-9
2.7 Electromagnetic Immunity	2-10

2.1 Introduction

Safety Characteristics

The Fluke 43B has been designed and tested in accordance with Standards ANSI/ISA S82.01-1994, EN 61010.1 (1993) (IEC 1010-1), CAN/CSA-C22.2 No.1010.1-92 (including approval), UL3111-1 (including approval) Safety Requirements for Electrical Equipment for Measurement, Control, and Laboratory Use.

This manual contains information and warnings that must be followed by the user to ensure safe operation and to keep the instrument in a safe condition. Use of this equipment in a manner not specified by the manufacturer may impair protection provided by the equipment.

Performance Characteristics

FLUKE guarantees the properties expressed in numerical values with the stated tolerance. Specified non-tolerance numerical values indicate those that could be nominally expected from the mean of a range of identical ScopeMeter test tools.

Environmental Data

The environmental data mentioned in this manual are based on the results of the manufacturer's verification procedures.

2.2 Safety Specifications

Safety Characteristics

Designed and tested for measurements on 600 Vrms Category III, Pollution Degree 2 in accordance with:

- EN 61010.1 (1993) (IEC 1010-1)
- ANSI/ISA S82.01-1994
- CAN/CSA-C22.2 No.1010.1-92 (including approval)
- UL3111-1 (including approval)

Installation Category III refers to distribution level and fixed installation circuits inside a building.

⚠ Maximum input voltage Input 1 and 2

Direct on inputs or with test leads TL24	(see Figure 2-1)
0 to 66 kHz	600 Vrms
> 66 kHz	derating to 5 Vrms
With Shielded Banana-to-BNC Adapter Plug BB120	(see Figure 2-1)
0 to 400 kHz	300 Vrms
> 400 kHz	derating to 5 Vrms

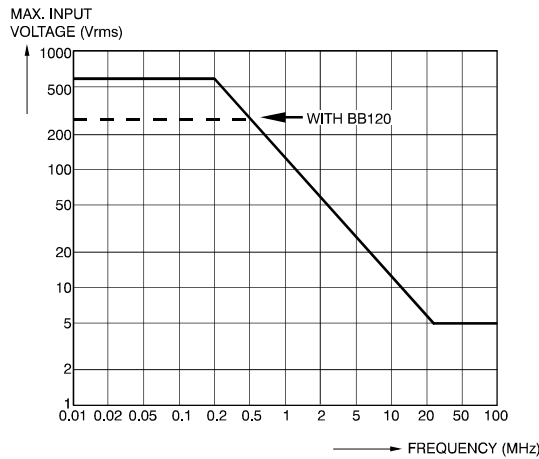

Figure 2-1. Max. Input Voltage vs. Frequency

ST8571

⚠ Maximum floating voltage
From any terminal to ground
0 to 400 Hz 600 Vrms

2.3 Function Specifications

The accuracy of all measurements is within \pm (% of reading + number of counts) from 18 °C to 28 °C. For all specifications, probe specifications must be added.

2.3.1 Electrical functions

Specifications are valid for signals with a fundamental between 40 and 70 Hz.

Minimum input voltage 4 V peak-peak
Minimum input current 10 A peak-peak (1 mV/A)
Input bandwidth DC to 15 kHz (unless specified otherwise)

Volts / Amps / Hertz

Readings Vrms (ac+dc), Arms (ac+dc), Hz
Voltage ranges (auto) 5 V; 50 V; 500 V; 1250 V
minimum step 1 mV; 10 mV; 100 mV; 1 V
 $\pm(1\% + 10 \text{ counts})$
Current ranges (auto) 50.00 A to 500.0 kA, 1250 kA
minimum step 10 mA; 0.1 A; 1 A; 100 A, 1 kA
 $\pm(1\% + 10 \text{ counts})$
Frequency range 10.0 Hz to 15.0 kHz
40.0 to 70.0 Hz $\pm(0.5\% + 2 \text{ counts})$
resolution 0.1 Hz; 1 Hz; 10 Hz; 100 Hz
CF Crest Factor range 1.0 to 10.0 $\pm(5\% + 1 \text{ count})$

Power (1 and 3 phase / 3 conductor / balanced loads)

Readings Watt, VA, VAR, PF, DPF, Hz
Watt, VA, VAR ranges (auto) 250 W to 250 MW, 625 MW, 1.56 GW
when selected: total (%r) $\pm(2\% + 6 \text{ counts})$
when selected: fundamental (%f) $\pm(4\% + 4 \text{ counts})$
DPF 0.00 to 1.00
0.00 to 0.25 not specified
0.25 to 0.90 ± 0.04
0.90 to 1.00 ± 0.03

PF.....	0.00 to 1.00 ± 0.04
Frequency range	10.0 Hz to 15.0 kHz
40.0 to 70.0 Hz	±(0.5 % + 2 counts)

Harmonics

Number of harmonics	DC..21, DC..33, DC..51
Readings / Cursor readings	
Vrms.....fund. ±(3 % + 2 counts)	31 st ±(5 % + 3 counts)..... 51 st ±(15 % + 5 counts)
Irms.....fund. ±(3 % + 2 counts)	31 st ±(5 % + 3 counts)..... 51 st ±(15 % + 5 counts)
Watt.....fund. ±(5 % + 10 counts) ...	31 st ±(10 % + 10 counts) 51 st ±(30 % + 5 counts)
Frequency of fundamental	± 0.25 Hz
Phase.....	fund. ±3° ... 51 st ± 15°
K-factor (in Amp and Watt)	± 10 %

Sags & Swells

Recording times (selectable)	4 minutes to 8 days, endless (16 days)
Readings / Cursor Readings	
Vrms actual, Arms actual (cycle by cycle calculation)	±(2 % + 10 counts)
Vrms max, Arms max (idem at cursor)	±(2 % + 12 counts)
Vrms average, Arms average (only at cursor).....	±(2 % + 10 counts)
Vrms min, Arms min (idem at cursor)	±(2 % + 12 counts)

Transients

Detection of voltage transients	> 40 ns
Useful input bandwidth input 1 (with test leads TL24).....	DC to 1 MHz
Reference signal	Vrms, Hz
After START, the Vrms and frequency of the signal are measured.	
From these data a pure sine wave is calculated.	
Detection when transients exceed specified voltage level (selectable)	
Voltage levels	20 %, 50 %, 100 %, 200 % of reference signal
Number of transient memories (temporary)	40
Cursor reading	
Vpeak min, Vpeak max at cursor	± 5 % of full scale

Inrush

Graphic display	
Current ranges (selectable).....	1 A, 5 A, 10 A, 50 A, 100 A, 500 A, 1000 A
Inrush times (selectable).....	1 s, 5 s, 10 s, 50 s, 100 s, 5 min
Cursor readings	
A peak max at cursor 1	± 5 % of full scale
A peak max at cursor 2	± 5 % of full scale
Time between cursors.....	±(0.2 % + 2 pixels)

2.3.2 Scope

Input Impedance

Input 1	1 MΩ // 12 pF (± 2 pF). With BB120: 20 pF ± 3 pF
Input 2	1 MΩ // 10 pF (± 2 pF). With BB120: 18 pF ± 3 pF

Horizontal

Time base modes (selectable).....	Normal, Single, Roll
Ranges (selectable within modes)	
In Normal.....	5 s to 20 ns/div
In Single shot.....	5 s to 1 μs/div
In Roll mode	60 s to 1 s/div
Time base error.....	< ±(0.4 % + 1 pixel)

Maximum sampling rate	
10 ms to 60 s	5 MS/s
20 ns to 10 ms	25 MS/s
Trigger source (auto, ½ auto, manual).....	Input 1 or Input 2

Trigger

Mode	auto triggering
Sources	Input 1, Input 2, Automatic (not manually selectable)
Error for frequencies < 1 MHz	
Voltage Level	± 0.5 div
at positive slope the top of the trigger symbol and at negative trigger the bottom of the trigger symbol is the trigger point.	
Time Delay Real Time sampling.....	± 1 sample
Time Delay Quasi Random sampling.....	± 10 ns
Sensitivity input 1	
@ 40 MHz	≥ 4 div
@ 25 MHz	≥ 1.5 div
@ DC - 5 MHz.....	≥ 0.5 div or 5 mV
Sensitivity input 2	
@ DC – 20 kHz	≥ 0.5 div
Slope Selection	Positive, negative
Level Control	
Range Manual control	> ± 4 div, within dynamic range
Delay (horizontal move)	-10 div - 0 div, used for horizontal move functionality

Vertical

Voltage ranges	5 mV/div to 500 V/div
Trace accuracy.....	±(1 % + 2 pixels)
Bandwidth input 1 (voltage)	
excluding test leads or probes	DC to 20 MHz (-3 dB)
with test leads TL24	DC to 1 MHz (-3 dB)
with 10:1 probe VPS100-R (optional).....	DC to 20 MHz (-3 dB)
with shielded test leads STL120 (optional).....	DC to 12.5 MHz (-3 dB)
Lower transition point (ac coupling).....	10 Hz (-3 dB)
Bandwidth input 2 (current)	
with Banana-to-BNC adapter	DC to 15 kHz
Lower transition point (ac coupling).....	10 Hz (-3 dB)

Scope readings

The accuracy of all scope readings is valid from 18 °C to 28 °C with relative humidity up to 90 % for a period of one year after calibration. Add 0.1 x (the specified accuracy) for each °C below 18 °C or above 28 °C. More than one waveform period must be visible on the screen.

V dc, A dc	±(0.5 % + 5 counts)
V ac and V ac+dc (True RMS) input 1	
DC to 60 Hz.....	±(1 % + 10 counts)
60 Hz to 20 kHz.....	±(2.5 % + 15 counts)
20 kHz to 1 MHz.....	±(5 % + 20 counts)
1 MHz to 5 MHz.....	±(10 % + 25 counts)
5 MHz to 20 MHz.....	±(30 % + 25 counts)
A ac and A ac+dc (True RMS) input 2	
DC to 60 Hz.....	±(1 % + 10 counts)
60 Hz to 15 kHz.....	±(30 % + 25 counts)
Frequency (Hz), Pulse width, Duty cycle (2.0 % to 98.0 %)	

1 Hz to 1 MHz	±(0.5 % + 2 counts)
1 MHz to 10 MHz.....	±(1 % + 2 counts)
10 MHz to 30 MHz.....	±(2.5 % + 2 counts)
Phase (Input 1 to Input 2)	
Up to 60 Hz.....	±2°
60 Hz to 400 Hz.....	±5°
Peak voltage	
Peak max, Peak min.....	± 5 % of full scale
Peak-peak.....	± 10 % of full scale
Crest	
Range.....	1.0 to 10.0 ±(5 % + 1 count)

2.3.3 Meter

Ohm

Ranges.....	500.0 Ω to 5.000 MΩ, 30.00 MΩ ±(0.6 % + 5 counts)
Max. Measurement Current.....	0.5 mA
Measurement Voltage at open circuit.....	< 4 V

Diode

Accuracy.....	±(2 % +5 counts)
Max. Measurement Current.....	0.5 mA
Measurement Voltage at open circuit.....	< 4 V

Continuity

Beep.....	< 30 Ω (± 5 Ω)
Measurement Current.....	0.5 mA
Detection of shorts.....	> 1 ms

Capacitance

Ranges.....	50.00 nF to 500.0 μF ±(2 % +10 counts)
Max. Measurement Current.....	0.5 mA

Temperature

Ranges (°C or °F)	-100.0 to +400.0 °C or -200.0 to +800.0 °F ±(0.5 % + 5 counts)
-------------------------	---

2.3.4 Record

Record times (selectable)	4 min to 8 days, endless (16 days)
Number of readings	1 or 2 simultaneously

Record is available for the functions:

- volts / amps / hertz
- power
- harmonics
- ohms / continuity / capacitance
- temperature
- scope

2.4 Miscellaneous

Display

Useful screen area.....	72 x 72 mm (2.83 x 2.83 in)
Resolution.....	240 x 240 pixels
Backlight.....	Cold Cathode Fluorescent (CCFL)

⚠ Power

External

Power Adapter.....	PM8907
Input Voltage.....	10 to 21 V dc
Power.....	5 W typical

Internal

Rechargeable Ni-Cd battery pack.....	BP120
Voltage range.....	4 to 6 V dc
Operating Time.....	4 hours
Charging Time.....	4 hours with Fluke 43B off 12 hours with Fluke 43B on
Refresh cycle.....	8 to 14 hours

Memory

Number of screen memories.....	20
Number of transient memories (temporary).....	40

Mechanical

Height x width x depth.....	232 x 115 x 50 mm (9.1 x 4.5 x 2 in)
Weight (including battery pack).....	1.1 kg (2.5 lb.)

Interface

.....	RS232, optically isolated
Supported Printers.....	HP Deskjet [®] , Laserjet [®] , PostScript and Epson FX80
Serial via PM9080 (optically isolated RS232 Adapter/Cable).	
Parallel via PAC91 (optically isolated Print Adapter Cable, optional).	
To PC.....	Dump and load settings and data
Serial via PM9080 (optically isolated RS232 adapter/cable), using SW43W (FlukeView [®] Power Quality Analyzer software).	

2.5 Current Probe

⚠ Safety Characteristics

Designed for measurements on 600 Vrms Category III. Protection class II, double or reinforced insulation requirements in accordance with:

- IEC 1010-1
- ANSI/ISA S82
- CSA-C22.2 No.1010.1-92
- UL1244

Electrical Specifications

Current range.....	1 A to 500 Arms
AC current over range limit.....	700 Arms
Maximum 10 minutes, followed by removal from current carrying conductor for 30 minutes.	
Output Signal.....	1 mV ac/A ac

Accuracy

5 to 10 Hz	
1 to 500 A	-3 dB typically
10 to 20 Hz	
1 to 300 A	± 5 %
300 to 400 A	± 15 %
400 to 500 A	± 25 %
20 to 45 Hz	
1 to 500 A	± 5 %
45 to 65 Hz	
1 to 20 A	±5 % of reading + 0.3 A
20 to 100 A	±5 % of reading
	± 3 ° phase shift
100 to 500 A	±2 % of reading
	± 5 ° phase shift
65 Hz to 3 kHz	
1 to 50 A	±(5 % + 0.4 A)
50 to 500 A	± 5 %
Influence of temperature on accuracy	<0.15 % per 10 °C (18 °F)

Altitude

During operation.....	2.0 km (6560 feet)
While stored.....	12 km (40 000 feet)

2.6 Environmental Conditions

Environmental MIL 28800E, Type 3, Class III, Style B

Temperature

During operation.....	0 to 50 °C (32 to 122 °F)
While stored.....	-20 to 60 °C (-4 to 140 °F)

Humidity

During operation:	
0 to 10 °C (32 to 50 °F)	non-condensing
10 to 30 °C (50 to 86 °F)	95 % ± 5 %
30 to 40 °C (86 to 104 °F)	75 % ± 5 %
40 to 50 °C (104 to 122 °F)	45 % ± 5 %
While stored:	
-20 to 60 °C (-4 to 140 °F).....	non-condensing

Altitude

During operation.....	4.5 km (15 000 feet)
The maximum input and floating voltage is 600 Vrms up to 2 km.	
Linearly derating from 600 down to 400 Vrms between 2 km to 4.5 km.	
While stored.....	12 km (40 000 feet)

Vibration.....max. 3 g

Shock.....max. 30 g

Electromagnetic Compatibility (EMC)

Emission	EN 50081-1 (1992): EN55022 and EN60555-2
Immunity.....	EN 50082-2 (1992): IEC1000-4-2, -3, -4, -5
	(See also Tables 2-1 to 2-3)

Enclosure Protection IP51, ref.: IEC529

2.7 Electromagnetic Immunity

The Fluke 43B, including standard accessories, conforms with the EEC directive 89/336 for EMC immunity, as defined by IEC1000-4-3, with the addition of the following tables.

Disturbance with test leads TL24 or Current Clamp 80i-500s

- Volts / amps / hertz
- Resistance, Capacitance
- Power
- Harmonics

Table 2-1. No Visible Disturbance

No visible disturbance	E = 3 V/m	E = 10 V/m
Frequency: 10 kHz - 27 MHz	(-)	(-)
Frequency: 27 MHz - 1 GHz	(-)	(-)

(-): no visible disturbance

Disturbance with test leads TL24 in scope mode

- V ac+dc (True RMS)

Table 2-2. Disturbance < 1 %

Disturbance less than 1 % of full scale	E = 3 V/m	E = 10 V/m
Frequency: 10 kHz - 27 MHz	2 V/div - 500 V/div	10 V/div - 500 V/div
Frequency: 27 MHz - 200 MHz	500 mV/div - 500V/div	2 V/div - 500 V/div
Frequency: 200 MHz - 1 GHz	(-)	5 mV/div - 500 V/div

(-): no visible disturbance

Table 2-3. Disturbance < 10 %

Disturbance less than 10 % of full scale	E = 3 V/m	E = 10 V/m
Frequency: 10 kHz - 27 MHz	1 V/div	5 V/div
Frequency: 27 MHz - 200 MHz	200 mV/div	1 V/div
Frequency: 200 MHz - 1 GHz	(-)	(-)

(-): no visible disturbance

Ranges not specified in Tables 2 and 3 may have a disturbance of more than 10 % of full scale.

Chapter 3

Circuit Descriptions

Title	Page
3.1 Introduction	3-3
3.2 Block Diagram	3-3
3.2.1 Input 1 - Input 2 Measurement Circuits	3-3
3.2.2 Trigger Circuit	3-5
3.2.3 Digital Circuit	3-5
3.2.4 Power Circuit	3-6
3.2.5 Start-up Sequence, Operating Modes	3-7
3.3 Detailed Circuit Descriptions	3-9
3.3.1 Power Circuit	3-9
3.3.2 Input 1 - Input 2 Measurement Circuits	3-15
3.3.3 Trigger Circuit	3-20
3.3.4 Digital Circuit	3-24

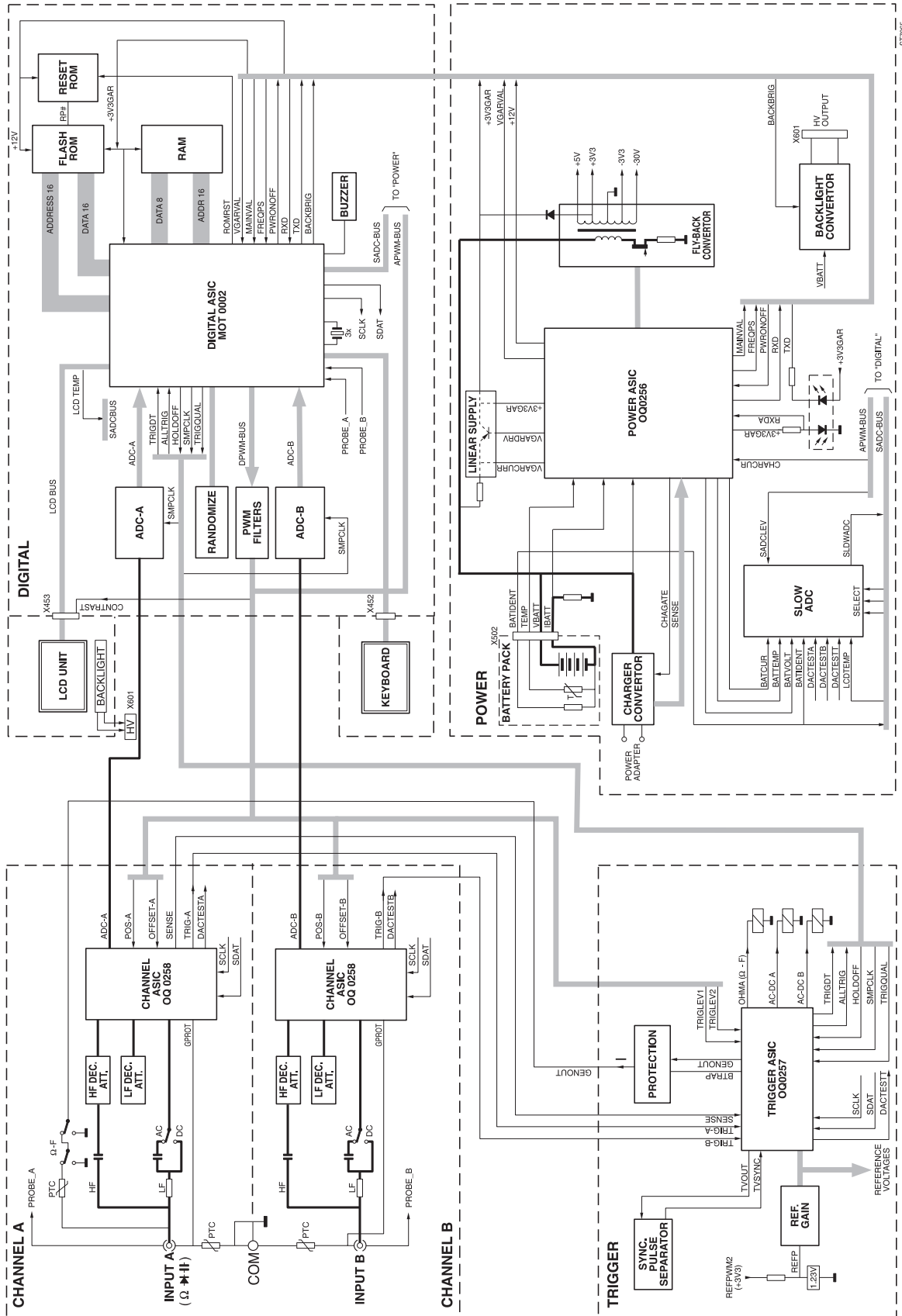

Figure 3-1. Fluke 43B Block Diagram

ST7965.EPS

3.1 Introduction

Section 3.2 describes the functional block diagram shown in Figure 3-1. It provides a quick way to get familiar with the test tool basic build-up.

Section 3.3 describes the principle of operation of the test tool functions in detail, on the basis of the circuit diagrams shown in Figures 9-1 to 9-5.

For all measurements, input signals are applied to the shielded input banana jackets.

Traces and readings are derived from the same input signal samples.

3.2 Block Diagram

In the block diagram Figure 3-1, the test tool is divided in five main blocks. Each block represents a functional part, build up around an Application Specific Integrated Circuit (ASIC). A detailed circuit diagram of each block is shown in Section 9.

Table 3-1 provides an overview of the blocks in which the test tool is broken down, the main block function, the ASIC name, and the applicable circuit diagram.

Table 3-1. Fluke 43B Main Blocks

Block	Main Functions	ASIC	Circuit Diagram
INPUT 1	Input 1 signal conditioning	C(hannel)-ASIC OQ0258	Figure 9-1
INPUT 2	Input 2 signal conditioning	C(hannel)-ASIC OQ0258	Figure 9-2
TRIGGER	Trigger selection and conditioning Current source for resistance, capacitance, continuity, and diode measurements AC/DC input coupling and Ω/F relay control Voltage reference source	T(rigger)-ASIC OQ0257	Figure 9-3
DIGITAL	Analog to Digital Conversion Acquisition of ADC samples Micro controller (μ P-ROM-RAM) Keyboard- and LCD control	D(igital)-ASIC MOT0002	Figure 9-4
POWER	Power supply, battery charger LCD back light voltage converter Optical interface input	P(ower)-ASIC OQ0256	Figure 9-5

All circuits, except the LCD unit and the KEYBOARD, are located on one Printed Circuit Board (PCB), called the MAIN PCB.

The ASIC's are referred to as C-ASIC (Channel ASIC), T-ASIC (Trigger ASIC), P-ASIC (Power ASIC), and D-ASIC (Digital ASIC).

3.2.1 Input 1 - Input 2 Measurement Circuits

The basic input signal for the Input 1 and Input 2 circuits (hardware) is voltage. The reading of Input 1 is in (milli)Volts. The reading of Input 2 is in Amperes. So the voltage on Input 2 is assumed to be supplied by a current clamp. From the measured voltage samples the readings are calculated by the instrument firmware. For example: power readings are calculated from the Input 1 and Input 2 voltage samples.

The Input 1 and Input 2 measurement circuits are partially identical. The differences are:

- Only Input 1 provides facilities for Ohms, Continuity, Diode, and Capacitance measurements.
- The bandwidth of the Input 1 circuit is 20 MHz, the bandwidth of Input 2 is 15 kHz.
- Input 2 has an additional hum rejection circuit.

The circuit description below applies to the Input 1 and Input 2 circuit.

Input 1 and Input 2 measurement principle

An input voltage applied to Input 1 or Input 2 is supplied to the C-ASIC via the HF path (Input 1 only) and the LF path. Depending on the actual measurement function the Input-1 HF path in the C-ASIC is enabled or disabled. The HF DECade ATTenuator and LF DECade ATTenuator are external components for the HF and LF path. The C-ASIC converts (attenuates, amplifies) the input signal to a normalized output voltage ADC-A/ADC-B, which is supplied to the Analog to Digital Converters (ADC-A and ADC-B) on the DIGITAL part. The D-ASIC acquires the digital samples to build the traces, and to calculate readings.

For the electrical functions the current Input 2 circuit is operating in low voltage ranges. For example a current of 10A measured with a 1 mV/A current clamp generates 10 mV (voltage range 10 mV/div). To minimize the influence of interference voltages, Input 2 has no HF path, and has an additional hum reject circuit.

The lowest Input 1 voltage range for electrical measurements is 4V/div, which is high in comparison with the Input 2 range.

Ohms, Continuity, and Diode measurement function (Input 1 only)

The T-ASIC supplies a current via the Ω /F relays to the unknown resistance Rx or diode connected to the Input 1 and the COM input jacket. The voltage drop across Rx or the diode is measured according to the Input 1 measurement principle.

Capacitance measurement function (Input 1 only)

The T-ASIC supplies a current via the Ω /F relays to the unknown capacitance Cx, connected to the Input 1 and the COM input jacket. Cx is charged and discharged by this current. The C-ASIC converts the charging time and the discharging time into a pulse width signal. This signal is supplied to the T-ASIC via the C-ASIC trigger output TRIG-A. The T-ASIC shapes and levels the signal, and supplies the resulting pulse width signal ALLTRIG to the D-ASIC. The D-ASIC counts the pulse width and calculates the capacitance reading.

Scope measurement function

In the Scope measurements function the test tool shows the traces and readings derived from the input signals. The Input 1 HF path is enabled, which results in a 20 MHz bandwidth. The Input 2 bandwidth is 15 kHz.

Other measurement functions

Volts/Amperes/Hertz (LF), Power (LF), Harmonics (LF), Sags & Swells (LF), Transients, Inrush Current (LF), and Temperature measurement results are calculated from acquired input voltage samples. For functions with (LF), the HF path of Input 1 is disabled, which results in a 15 kHz bandwidth for both Input channels.

Miscellaneous

Control of the C-ASIC, e.g. selecting the attenuation factor, is done by the D-ASIC via the SDAT and SCLK serial communication lines.

An offset compensation voltage and a trace position control voltage are provided by the D-ASIC via the APWM bus.

The C-ASIC's also provide conditioned input voltages on the TRIG-A/TRIG-B line. One of these voltages will automatically be selected as trigger source by the T-ASIC.

3.2.2 Trigger Circuit

The T ASIC selects one of the possible trigger sources TRIG-A (Input 1) or TRIG-B (Input 2). For triggering on transients the selected trigger source signal is processed via the high pass Trigger Filter (TVOUT-TVSYNC lines). Two adjustable trigger levels are supplied by the D-ASIC via the PWM FILTERS (TRIGLEV1 and TRIGLEV2 line). Depending on the selected trigger conditions (- source, - level, - edge, - mode), the T-ASIC generates the final trigger signal TRIGDT, which is supplied to the D-ASIC.

The TRIG-A input is also used for capacitance measurements (see Section 3.2.1).

The T-ASIC includes a constant current source for resistance and capacitance measurements. The current is supplied via the GENOUT output and the Ω/F relays to the unknown resistance R_x or capacitance C_x connected to Input 1. The SENSE signal senses the voltage across C_x and controls a CLAMP circuit in the T-ASIC. This circuit limits the voltage on Input 1 at capacitance measurements. The protection circuit prevents the T-ASIC from being damaged by voltages supplied to the input during resistance or capacitance measurements.

The T-ASIC contains opamps to derive reference voltages from a 1.23 V reference source. The gain factors for these opamps are determined by resistors in the REF GAIN circuit. The reference voltages are supplied to various circuits.

The T-ASIC also controls the Input 1/2 AC/DC input coupling relays, and the Ω/F relay.

Control data for the T-ASIC are provided by the D-ASIC via the SDAT and SCLK serial communication lines.

3.2.3 Digital Circuit

The D-ASIC includes a micro processor, ADC sample acquisition logic, trigger logic, display and keyboard control logic, I/O ports, and various other logic circuits.

The instrument software is stored in the 8M FlashROM; the 4M RAM is used for temporary data storage.

For Voltage and Resistance measurements, the conditioned Input 1/2 voltages are supplied to the ADC-A and ADC-B ADC. The voltages are sampled, and digitized by the ADC's. The output data of the ADC's are acquired and processed by the D-ASIC. For capacitance measurements the pulse width of the T-ASIC output signal ALLTRIG, which is proportional to the unknown capacitance, is counted by the D-ASIC.

The DPWM-BUS (Digital Pulse Width Modulation) supplies square wave signals with a variable duty cycle to the PWM FILTERS circuit (RC filters). The outgoing APWM-BUS (Analog PWM) provides analog signals of which the amplitude is controlled by the D-ASIC. These voltages are used to control e.g. the trace positions (C-ASIC), the trigger levels (T-ASIC), and the battery charge current (P-ASIC).

In random sampling mode (Scope mode time base faster than 1 $\mu\text{s/d}$), a trace is built-up from several acquisition cycles. During each acquisition, a number of trace samples are placed as pixels in the LCD. The RANDOMIZE circuit takes care that the starting moment of each acquisition cycle (trigger release signal HOLDOFF goes low) is random.

This prevents that at each next acquisition the trace is sampled at the same time positions, and that the displayed trace misses samples at some places on the LCD.

The D-ASIC supplies control data and display data to the LCD module. The LCD module is connected to the main board via connector X453. It consists of the LCD, LCD drivers, and a fluorescent back light lamp. As the module is not repairable, no detailed description and diagrams are provided. The back light supply voltage is generated by the back light converter on the POWER part.

The keys of the keyboard are arranged in a matrix. The D-ASIC drives the rows and scans the matrix. The contact pads on the keyboard foil are connected to the main board via connector X452. The ON-OFF key is not included in the matrix, but is sensed by a logic circuit in the D-ASIC, that is active even when the test tool is turned off.

Via the PROBE-A and PROBE-B lines, connected to the Input 1 and Input 2 banana shielding, the D-ASIC can detect if a probe is connected.

The D-ASIC sends commands to the C-ASICs and T-ASIC via the SCLK and SDAT serial control lines, e.g. to select the required trigger source.

Various I/O lines are provided, e.g. to control the BUZZER and the Slow-ADC (via the SADC bus).

3.2.4 Power Circuit

The test tool can be powered via the power adapter, or by the battery pack.

If the power adapter is connected, it powers the test tool and charges the battery via the CHARGER-CONVERTER circuit. The battery charge current is sensed by sense resistor R_s (signal IBAT). It is controlled by changing the output current of the CHARGER-CONVERTER (control signal CHAGATE).

If no power adapter is connected, the battery pack supplies the VBAT voltage. The VBAT voltage powers the P-ASIC, and is also supplied to the FLY BACK CONVERTER (switched mode power supply).

If the test tool is turned on, the FLY BACK CONVERTER generates supply voltages for various test tool circuits.

The +3V3GAR supply voltage powers the D-ASIC, RAM and ROM. If the test tool is turned off, the battery supplies the +3V3GAR voltage via transistor V569. This transistor is controlled by the P-ASIC. So when the test tool is turned off, the D-ASIC can still control the battery charging process (CHARCURR signal), the real time clock, the on/off key, and the serial RS232 interface (to turn the test tool on).

To monitor and control the battery charging process, the P-ASIC senses and buffers battery signals as temperature (TEMP), voltage (BATVOLT), current (IBAT).

Via the SLOW ADC various analog signals can be measured by the D-ASIC. Involved signals are: battery voltage (BATVOLT), battery type (IDENT), battery temperature (TEMP), battery current (BATCUR) LCD temperature (LCDTEMP, from LCD unit), and 3 test output pins of the C-ASIC's, and the T-ASIC (DACTEST). The signals are used for control and test purposes.

The BACK LIGHT CONVERTER generates the **400V !** supply voltage for the LCD fluorescent back light lamp. If the lamp is defective a 1.5 kV voltage can be present for 0.2 second maximum. The brightness is controlled by the BACKBRIG signal supplied by the D-ASIC.

Serial communication with a PC or printer is possible via the RS232 optically isolated interface. The P-ASIC buffers the received data line (RXDA) and supplies the buffered data (RXD) to the D-ASIC. The transmit data line TXD is directly connected to the D-ASIC.

3.2.5 Start-up Sequence, Operating Modes

The test tool sequences through the next steps when power is applied (see Figure 3-2):

1. The P-ASIC is directly powered by the battery or power adapter voltage VBAT. Initially the Fly Back Converter is off, and the D-ASIC is powered by VBAT via transistor V569 (+3V3GAR). If the voltage +3V3GAR is below 3.05 V, the P-ASIC keeps its output signal VGARVAL (supplied to the D-ASIC) low, and the D-ASIC will not start up. The test tool is not working, and is in the **Idle mode**.
2. If the voltage +3V3GAR is above 3.05 V, the P-ASIC makes the line VGARVAL high, and the D-ASIC will start up. The test tool is operative now. If it is powered by **batteries only**, and **not turned on**, it is in the **Off mode**. In this mode the D-ASIC is active: the real time clock runs, and the ON/OFF key is monitored to see if the test tool will be turned on.
3. If the **power adapter is connected** (P-ASIC output MAINVAL high), **and/or the test tool is turned on**, the embedded D-ASIC program, called mask software, starts up. The mask software checks if valid instrument software is present in the Flash ROM. If not, the test tool does not start up and the mask software continues running until the test tool is turned off, or the power is removed. This is called the **Mask active mode**. The mask active mode can also be entered by pressing the ^ and > key when turning on the test tool.

If valid instrument software is present, one of the following modes becomes active:

Charge mode

The Charge mode is entered when the test tool is **powered by the power adapter, and is turned off**. The FLY-BACK CONVERTER is off. The CHARGER-CONVERTER charges the batteries (if installed).

Operational & Charge mode





The Operational & Charge mode is entered when the test tool is **powered by the power adapter, and is turned on**. The FLY-BACK CONVERTER is on, the CHARGER-CONVERTER supplies the primary current. If batteries are installed, they will be charged. In this mode a battery refresh (see below) can be done.

Operational mode

The Operational mode is entered when the test tool is **powered by batteries only, and is turned on**. The FLY-BACK CONVERTER is on, the batteries supply the primary current. If the battery voltage (VBAT) drops below 4V when starting up the fly back converter, the Off mode is entered.

Battery Refresh

Each 3 months the batteries need a deep discharge-full charge cycle, called a “refresh”. This prevents battery capacity loss due to the memory effect. A refresh cycle takes 16 hours maximum, depending on the battery status.

A refresh can be started via the keyboard ( =>  =>  I=> INSTRUMENT SETUP  => START BATTERY REFRESH ) if the test tool is on, and the power adapter is connected. During a refresh, first the batteries are completely discharged, and then they are completely charged again.

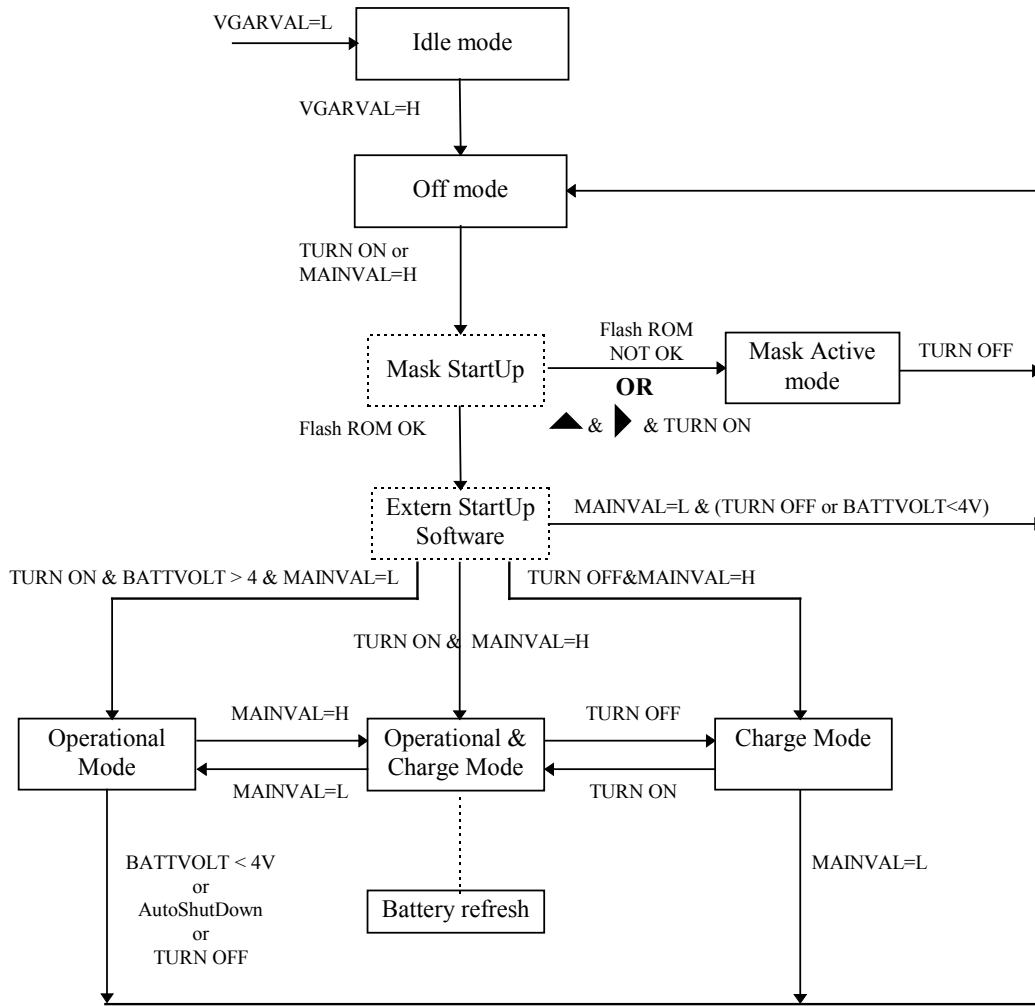

Figure 3-2. Fluke 43B Start-up Sequence, Operating Modes

Table 3-2 shows an overview of the test tool operating modes.

Table 3-2. Fluke 43B Operating Modes

Mode	Conditions	Remark
Idle mode	No power adapter and no battery	no activity
Off mode	No power adapter connected, battery installed, test tool off	P-ASIC & D-ASIC powered (VBAT & +3V3GAR).
Mask active mode	No valid instrument software, or ^ and > key pressed when turning on	Mask software runs
Charge mode	Power adapter connected and test tool off	Batteries will be charged
Operational & Charge mode	Power adapter connected and test tool on	Test tool operational, and batteries will be charged
Operational mode	No power adapter connected, battery installed, and test tool on	Test tool operational, powered by batteries

3.3 Detailed Circuit Descriptions

3.3.1 Power Circuit

The description below refers to circuit diagram Figure 9-5.

Power Sources , Operating Modes

Figure 3-3 shows a simplified diagram of the power supply and battery charger circuit.

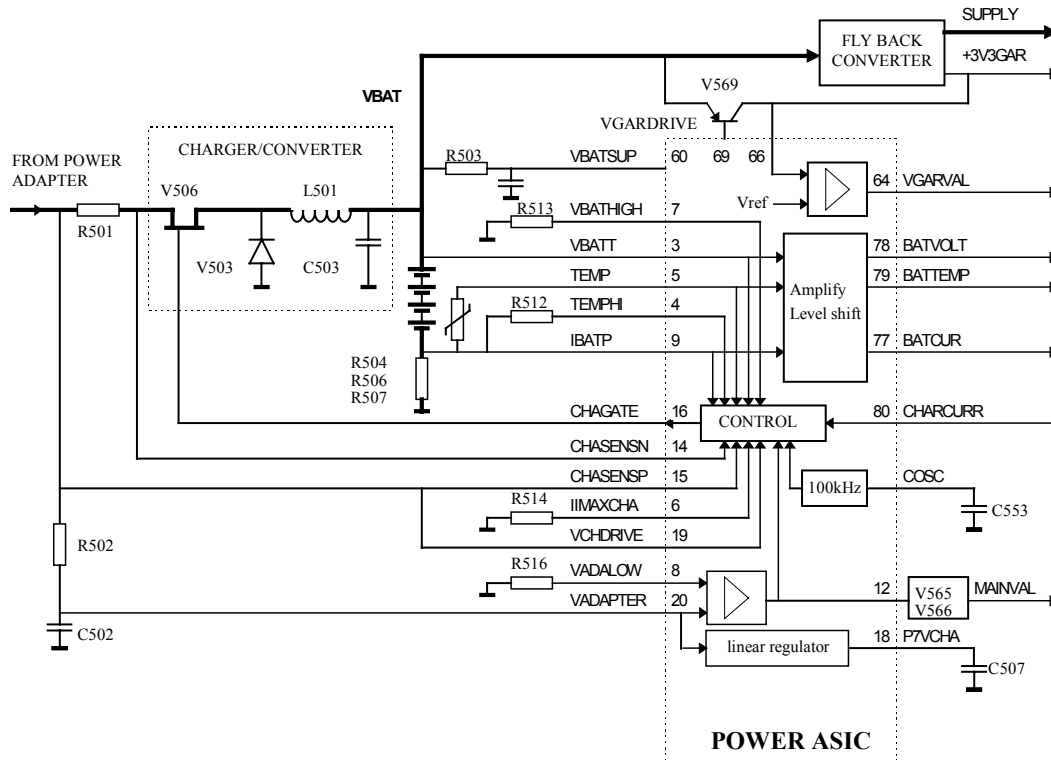

Figure 3-3. Power Supply Block Diagram

As described in Section 3.2.5, the test tool operating mode depends on the connected power source.

The voltage VBAT is supplied either by the power adapter via V506/L501, or by the battery pack. It powers a part of the P-ASIC via R503 to pin 60 (VBATSUP). If the test tool is off, the Fly Back Converter is off, and VBAT powers the D-ASIC via transistor V569 (+3V3GAR). This +3V3GAR voltage is controlled and sensed by the P-ASIC. If it is NOT OK (<3.05V), the output VGARVAL (pin 64) is low. The VGARVAL line is connected to the D-ASIC, and if the line is low, the D-ASIC is inactive: the test tool is in the **Idle mode**. A low VGARVAL line operates as a reset for the D-ASIC.

If VGARVAL is high (+3V3GAR > 3.05V), the D-ASIC becomes active, and the **Off mode** is entered. The D-ASIC monitors the P-ASIC output pin 12 MAINVAL, and the test tool ON/OFF status. By pressing the ON/OFF key, a bit in the D-ASIC indicating the test tool ON/OFF status is toggled. If no correct power adapter voltage is supplied (MAINVAL is low), and the test tool is not turned on, the **Off mode** will be maintained.

If a correct power adapter voltage is supplied (MAINVAL high), or if the test tool is turned on, the mask software starts up. The mask software checks if valid instrument software is present. If not, e.g. no instrument firmware is loaded, the mask software will

keep running, and the test tool is not operative: the test tool is in the **Mask active** state. For test purposes the mask active mode can also be entered by pressing the ^ and > key when the test tool is turned on.

If valid software is present, one of the three modes **Operational**, **Operational & Charge** or **Charge** will become active. The Charger/Converter circuit is active in the Operational & Charge and in the Charge mode. The Fly back converter is active in the Operational and in the Operational & Charge mode.

Charger/Converter (See also Figure 3-3.)

The power adapter powers the Charge Control circuit in the P-ASIC via an internal linear regulator. The power adapter voltage is applied to R501. The Charger/Converter circuit controls the battery charge current. If a charged battery pack is installed VBAT is approximately +4.8V. If no battery pack is installed VBAT is approximately +15V. The voltage VBAT is supplied to the battery pack, to the P-ASIC, to the Fly Back Converter, and to transistor V569. The FET control signal CHAGATE is a 100 kHz square wave voltage with a variable duty cycle, supplied by the P-ASIC Control circuit. The duty cycle determines the amount of energy loaded into L501/C503. By controlling the voltage VBAT, the battery charge current can be controlled. The various test tool circuits are supplied by the Fly Back Converter and/or V569.

Required power adapter voltage

The P-ASIC supplies a current to reference resistor R516 (VADALOW pin 8). It compares the voltage on R516 to the power adapter voltage VADAPTER on pin 20 (supplied via R502, and attenuated in the P-ASIC). If the power adapter voltage is below 10V, the P-ASIC output pin 12, and the line MAINVAL, are low. This signal on pin 12 is also supplied to the P-ASIC internal control circuit, which then makes the CHAGATE signal high. As a result FET V506 becomes non-conductive, and the Charger/Converter is off.

Battery charge current control

The actual charge current is sensed via resistors R504-R506-507, and filter R509-C509, on pin 9 of the P-ASIC (IBATP). The sense voltage is supplied to the control circuit. The required charge current information is supplied by the D-ASIC via the CHARCUR line and filter R534-C534 to pin 80. A control loop in the control circuit adjusts the actual charge current to the required value.

The filtered CHARCUR voltage range on pin 80 is 0... 2.7V for a charge current from 0.5A to zero. A voltage of 0V complies to 0.5A (fast charge), 1.5V to 0.2A (top off charge), 2.3V to 0.06A (trickle charge), and 2.7V to 0A (no charge). If the voltage is > 3 Volt, the charger converter is off (V506 permanently non-conductive).

The D-ASIC derives the required charge current value from the battery voltage VBAT. The P-ASIC converts this voltage to an appropriate level and supplies it to output pin 78 (BATVOLT). The D-ASIC measures this voltage via the Slow ADC. The momentary value, and the voltage change as a function of time (-dV/dt), are used as control parameters.

Charging process

If the battery voltage drops below 5.2V, and the battery temperature is between 10 and 45°C, the charge current is set to 0.5A (fast charge). From the battery voltage change - dV/dt the D-ASIC can see when the battery is fully charged, and stop fast charge. Additionally a timer in the D-ASIC limits the fast charge time to 6 hours. After fast charge, a 0.2A top off charge current is supplied for 2 hours. Then a 0.06A trickle

charge current is applied for 48 hours maximum. If the battery temperature becomes higher than 50°C, the charge current is set to zero.

Battery temperature monitoring

The P-ASIC supplies a current to a NTC resistor in the battery pack (TEMP pin 5). It conditions the voltage on pin 5 and supplies it to output pin 79 BATTEMP. The D-ASIC measures this voltage via the slow ADC. It uses the BATTEMP voltage to decide if fast charge is allowed (10-45°C), or no charge is allowed at all (<10°C, >50°C).

Additionally the temperature is monitored by the P-ASIC. The P-ASIC supplies a current to reference resistor R512 (TEMPHI pin 4), and compares the resulting TEMPHI voltage to the voltage on pin 5 (TEMP). If the battery temperature is too high, the P-ASIC Control circuit sets the charge current to zero, in case the D-ASIC fails to do this.

If the battery temperature monitoring system fails, a bimetal switch in the battery pack interrupts the battery current if the temperature becomes higher than 70 °C.

Maximum VBAT

The P-ASIC supplies a current to reference resistor R513 (VBATHIGH pin 7). It compares the voltage on R513 to the battery voltage VBAT on pin 3 (after being attenuated in the P-ASIC). The P-ASIC limits the voltage VBAT to 7.4V via its internal Control circuit. This happens if no battery or a defective battery (open) is present.

Charger/Converter input current

This input current is sensed by R501. The P-ASIC supplies a reference current to R514. The P-ASIC compares the voltage drop on R501 (P-ASIC pin 14 and 15) to the voltage on R514 (IMAXCHA pin 6). It limits the input current (e.g. when loading C503/C555 just after connecting the power adapter) via its internal Control circuit.

CHAGATE control signal

To make the FET conductive its Vgs (gate-source voltage) must be negative. For that purpose, the CHAGATE voltage must be negative with respect to VCHDRIVE. The P-ASIC voltage VCHDRIVE also limits the swing of the CHAGATE signal to 13V.

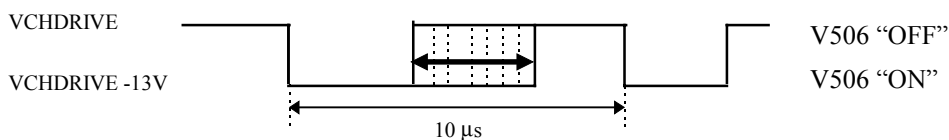

Figure 3-4. CHAGATE Control Voltage

+3V3GAR Voltage

When the test tool is not turned on, the Fly Back Converter does not run. In this situation, the +3V3GAR voltage for the D-ASIC, the FlashROM, and the RAM is supplied via transistor V569. The voltage is controlled by the VGARDRV signal supplied by the P-ASIC (pin 69). The current sense voltage across R580 is supplied to pin 70 (VGARCURR). The voltage +3V3GAR is sensed on pin 66 for regulation. The internal regulator in the P-ASIC regulates the +3V3GAR voltage, and limits the current.

Fly Back Converter

When the test tool is turned on, the D-ASIC makes the PWRONOFF line (P-ASIC pin 62) high. Then the self oscillating Fly Back Converter becomes active. It is started up by the internal 100 kHz oscillator that is also used for the Charger/Converter circuit. First the FLYGATE signal turns FET V554 on (see Figure 3-5), and an increasing current flows in the primary transformer winding to ground, via sense resistor R551. If the voltage FLYSENSP across this resistor exceeds a certain value, the P-ASIC turns FET V554 off. Then a decreasing current flows in the secondary windings to ground. If the windings are “empty” (all energy transferred), the voltage VCOIL sensed by the P-ASIC (pin 52) is zero, and the FLYGATE signal will turn FET V554 on again.

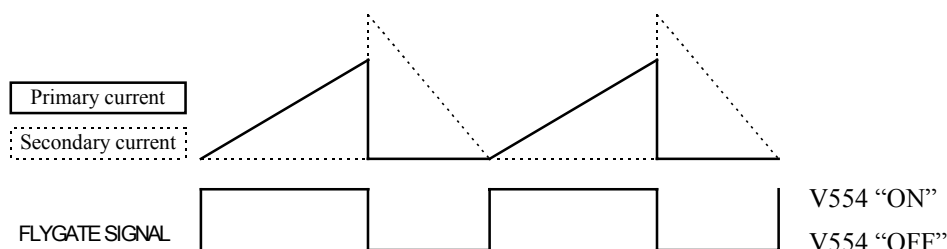

Figure 3-5. Fly-Back Converter Current and Control Voltage

The output voltage is regulated by feeding back a part of the +3V3A output voltage via R552-R553-R554 to pin 54 (VSENS). This voltage is referred to a 1.23 V reference voltage. Any deviation of the +3V3A voltage from the required 3.3V changes the current level at which current FET V554 will be switched off. If the output voltage increases, the current level at which V554 is switched off will become lower, and less energy is transferred to the secondary winding. As a result the output voltage will become lower.

An internal current source supplies a current to R559. The resulting voltage is a reference for the maximum allowable primary current (IMAXFLY). The voltage across the sense resistor (FLYSENSP) is compared to the IMAXFLY voltage. If the current exceeds the set limit, FET V554 will be turned off.

Another internal current source supplies a current to R558. This resulting voltage is a reference for the maximum allowable output voltage (VOUTH1). The -3V3A output voltage (M3V3A) is attenuated and level shifted in the P-ASIC, and then compared to the VOUTH1 voltage. If the -3V3A voltage exceeds the set limit, FET V554 will be turned off.

The FREQPS control signal is converted to appropriate voltage levels for the FET switch V554 by the BOOST circuit. The voltage VBAT supplies the BOOST circuit power via V553 and R561. The FREQPS signal is also supplied to the D-ASIC, in order to detect if the Fly Back converter is running well.

V551 and C552 limit the voltage on the primary winding of T552 when the FET V554 is turned off. The signal SNUB increases the FLYGATE high level to decrease ON-resistance of V554 (less power dissipation in V554).

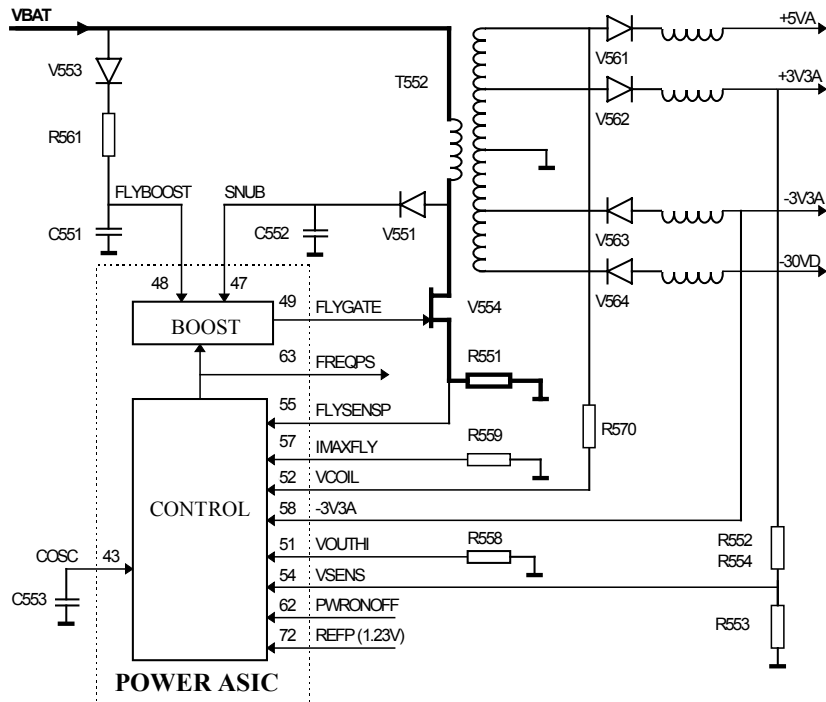

Figure 3-6. Fly-Back Converter Block Diagram

Slow ADC

The Slow ADC enables the D-ASIC to measure the following signals: BATCUR, BATVOLT, BATTEMP, BATIDENT (Battery current, - voltage, - temperature, - type), DACTEST-A, DACTEST-B, and DACTEST-T (test output of the C-ASIC's and the T-ASIC).

De-multiplexer D531 supplies one of these signals to its output, and to the input of comparator N531 TP536). The D-ASIC supplies the selection control signals SELMUX0-2. The Slow ADC works according to the successive approximation principle. The D-ASIC changes the SADCLEV signal level, and thus the voltage level on pin 3 of the comparator step wise, by changing the duty cycle of the PWM signal SADCLEVD. The comparator output SLOWADC is monitored by the D-ASIC, who knows now if the previous input voltage step caused the comparator output to switch. By increasing the voltage steps, the voltage level can be approximated within the smallest possible step of the SADCLEV voltage. From its set SADCLEVD duty cycle, the D-ASIC knows voltage level of the selected input.

RS232

The optical interface enables serial communication (RS232) between the test tool and a PC or printer.

The received data line RXDA (P-ASIC pin 75) is connected to ground via a 20 kΩ resistor in the P-ASIC.

If no light is received by the light sensitive diode H522, the RXDA line is +200 mV, which corresponds to a "1" (+3V) on the RXD (P-ASIC output pin 76) line.

If light is received, the light sensitive diode will conduct, and the RXDA line goes low (0...-0.6V), which corresponds to a "0" on the RXD line.

The level on the RXDA line is compared by a comparator in the P-ASIC to a 100 mV level. The comparator output is the RXD line, which is supplied to the D-ASIC for communication, and for external triggering.

The D-ASIC controls the transmit data line TXD. If the line is low, diode H521 will emit light.

The supply voltage for the optical interface receive circuit (RXDA), is the +3V3SADC voltage. The +3V3SADC voltage is present if the test tool is turned on, or if the Power Adapter is connected (or both). So if the Power Adapter is present, serial communication is always possible, even when the test tool is off.

Backlight Converter

The LCD back light is provided by a Ø2.4 mm fluorescent lamp in LCD unit. The back light converter generates the 300-400 Vpp ! supply voltage. The circuit consist of:

- A pulse width modulated (PWM) buck regulator to generate a variable, regulated voltage (V600, V602, L600, C602).
- A zero voltage switched (ZVS) resonant push-pull converter to transform the variable, regulated voltage into a high voltage AC output (V601, T600).

The PWM buck regulator consists of FET V600, V602, L600, C602, and a control circuit in N600. FET V600 is turned on and off by a square wave voltage on the COUT output of N600 pin 14). By changing the duty cycle of this signal, the output on C602 provides a variable, regulated voltage. The turn on edge of the COUT signal is synchronized with each zero detect.

Outputs AOUT and BOUT of N600 provide complementary drive signals for the push-pull FETs V601a/b (dual FET). If V601a conducts, the circuit consisting of the primary winding of transformer T600 and C608, will start oscillating at its resonance frequency. After half a cycle, a zero voltage is detected on pin 9 (ZD) of N600, V601a will be turned off, and V601b is turned on. This process goes on each time a zero is detected. The secondary current is sensed by R600/R604, and fed back to N600 pin 7 and pin 4 for regulation of the PWM buck regulator output voltage. The BACKBRIG signal supplied by the D-ASIC provides a pulse width modulated (variable duty cycle) square wave. By changing the duty cycle of this signal, the average on-resistance of V604 can be changed. This will change the secondary current, and thus the back light intensity. The voltage on the “cold” side of the lamp is limited by V605 and V603. This limits the emission of electrical interference.

R605 and R606 provide a more reliable start-up of the backlight (PCB version 3 up only).

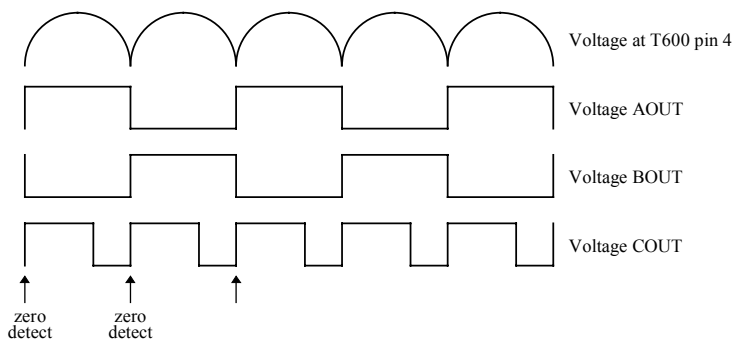

Figure 3-7. Back Light Converter Voltages

3.3.2 Input 1 - Input 2 Measurement Circuits

The description below refers to circuit diagrams Figure 9-1 and Figure 9-2.

The Input 1 and Input 2 circuits are partly identical. Both circuits condition input voltages. See section 3.2.1 for a description of the differences between Input 1 and 2.

The Input 1/2 circuitry is built-up around a C-ASIC OQ0258. The C-ASIC is placed directly behind the input connector and transforms the input signal to levels that are suitable for the ADC and trigger circuits.

The C-ASIC

Figure 3-8 shows the simplified C-ASIC block diagram. The C-ASIC consists of separate paths for HF and LF signals, an output stage that delivers signals to the trigger and ADC circuits and a control block that allows software control of all modes and adjustments. The transition frequency from the LF-path to the HF-path is approximately 20 kHz, but there is a large overlap.

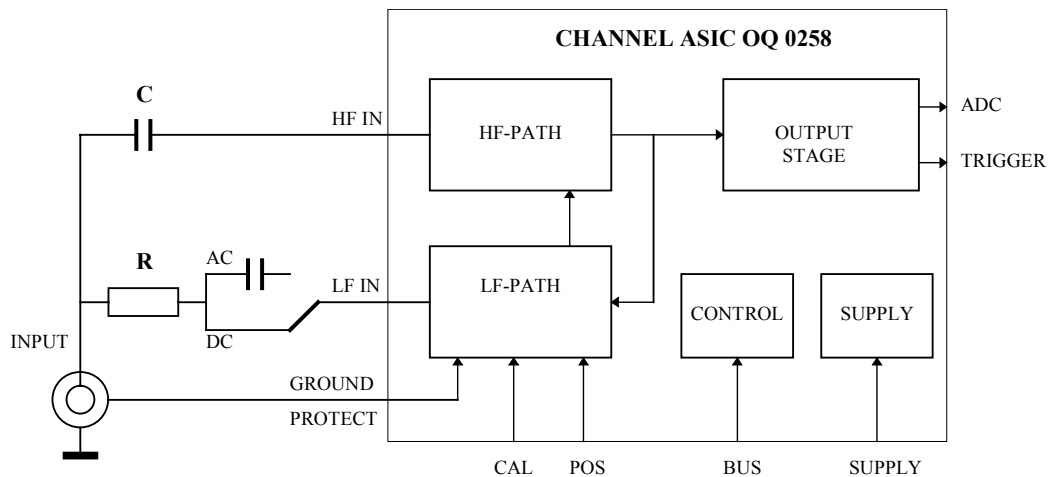

Figure 3-8. C-ASIC Block Diagram

LF input

The LF-input (pin 42) is connected to a LF decade attenuator in voltage mode, or to a high impedance buffer for resistance and capacitance measurements. The LF decade attenuator consists of an amplifier with switchable external feedback resistors R131 to R136. Depending on the selected range the LF attenuation factor which will be set to 1-10-100-1000-10,000. The C-ASIC includes a LF pre-amplifier with switchable gain factors for the 1-2-5 steps.

HF input (not used for Input 2)

The HF component of the input signal is supplied to four external HF capacitive attenuators via C104. Depending on the required range, the C-ASIC selects and buffers one of the attenuator outputs :1 (HF0), :10 (HF1), :100 (HF2), or :1000 (HF3). By attenuating the HF3 input internally by a factor 10, the C-ASIC can also create a :10000 attenuation factor. Inputs of not selected input buffers are internally shorted. To control the DC bias of the buffers inputs, their output voltage is fed back via an internal feed back resistor and external resistors R115, R111/R120, R112, R113, and-R114. The internal feed back resistor and filter R110/C105 will eliminate HF feed back, to obtain a

large HF gain. The C-ASIC includes a HF pre-amplifier with switchable gain factors for the 1-2-5 steps. The C-ASIC also includes circuitry to adjust the gain, and pulse response.

ADC output pin 27

The combined conditioned HF/LF signal is supplied to the ADC output (pin 27) via an internal ADC buffer. The output voltage is 150 mV/d. The MIDADC signal (pin 28), supplied by the ADC, matches the middle of the C-ASIC output voltage swing to the middle of the ADC input voltage swing.

TRIGGER output pin 29

The combined conditioned HF/LF signal is also supplied to the trigger output (pin 29) via an internal trigger buffer. The output voltage is 100 mV/d. This signal (TRIG-A) is supplied to the TRIGGER ASIC for triggering, and for capacitance measurements.

For capacitance measurements the ADC output is not used, but the TRIG-A output pulse length indicates the measured capacitance, see “Capacitance measurements” below.

GPROT input pin 2

PTC (Positive Temperature Coefficient) resistors (R106-R206) are provided between the Input 1 and Input 2 shield ground, and the COM input (instrument ground). This prevents damage to the test tool if the various ground inputs are connected to different voltage levels. The voltage across the PTC resistor is supplied via the GPROT input pin 2 to an input buffer. If this voltage exceeds ± 200 mV, the ground protect circuit in the C-ASIC makes the DACTEST output (pin 24) high. The DACTEST line output level is read by the D-ASIC via the slow ADC (See 3.3.2 “Power”). The test tool will give a ground error warning.

Because of ground loops, a LF interference voltage can arise across PTC resistor R106 (mainly mains interference when the power adapter is connected). To eliminate this LF interference voltage, it is buffered (also via input GPROT, pin 2), and subtracted from the input signal. Pin 43B (PROTGND) is the ground reference of the input buffer.

CALSIG input pin 36

The reference circuit on the TRIGGER part supplies an accurate +1.23 V DC voltage to the CALSIG input pin 36 via R141. This voltage is used for internal calibration of the gain, and the capacitance measurement threshold levels. A reference current I_{cal} is supplied by the T-ASIC via R144 for calibration of the resistance and capacitance measurement function. For ICAL see also Section 3.3.3.

POS input pin 1

The PWM circuit on the Digital part provides an adjustable voltage (0 to 3.3 V) to the POS input via R151. The voltage level is used to move the input signal trace on the LCD. The REFN line provides a negative bias voltage via R152, to create the correct voltage swing level on the C-ASIC POS input.

OFFSET input pin 44

The PWM circuit on the Digital part supplies an adjustable voltage (0 to +3.3 V) to the OFFSET input via R153. The voltage level is used to compensate the offset in the LF path of the C-ASIC. The REFN line provides a negative bias voltage via R152, to create the correct voltage swing level on the C-ASIC POS input.

DACTEST output pin 24

As described above, the DACTEST output is used for signaling a ground protect error. It can also be used for testing purposes. Furthermore the DACTEST output provides a C-ASIC reset output signal (+1.75V) after a power on.

ADDRESS output pin 23

The output provides a replica of the input voltage to the SENSE line via R165. In capacitance mode, the sense signal controls the CLAMP function in the T-ASIC (See Section 3.3.3).

TRACEROT input pin 31

The TRACEROT signal is supplied by the T-ASIC. It is a triangle sawtooth voltage.

SDAT, SCLK

Control information for the C-ASIC, e.g. selection of the attenuation factor, is sent by the D-ASIC via the SDA data line. The SCL line provides the synchronization clock signal.

Input 1 Voltage Measurements

The input voltage is applied to the HF attenuator inputs of the C-ASIC via C104, and to the LF input of the C-ASIC via R101/R102, AC/DC input coupling relay K171, and R104. The C-ASIC conditions the input voltage to an output voltage of 50 mV/d. This voltage is supplied to the ADC on the Digital part. The ADC output data is read and processed by the D-ASIC, and represented as a numerical reading, and as a graphical trace.

Table 3-3. shows the relation between the Input 1 reading range (V) and the trace sensitivity (V/d.) in the Scope mode. The selected trace sensitivity determines the C-ASIC attenuation/gain factor. The reading range is only a readout function, it does not change the hardware range or the wave form display.

Table 3-3. Input 1 Voltage Ranges And Trace Sensitivity

range	50 mV	50 mV	50 mV	500 mV	500 mV	500 mV	5V	5V
trace ../div	5 mV	10 mV	20 mV	50 mV	100 mV	200 mV	500 mV	1V
range	5V	50V	50V	50V	500V	500V	500V	1250V
trace ../div	2V	5V	10V	20V	50V	100V	200V	500V

During measuring, input voltage measurements, gain measurements, and zero measurements are done. As a result, the voltage supplied to the ADC is a multiplexed (zero, + reference, -reference, input voltage) signal. In ROLL mode however, no gain and zero measurements are done. Now the ADC input voltage includes only the conditioned input voltage.

The input voltage is connected to Input 1. The shield of the input is connected to system ground (⊥) via a PTC ground protection resistor. If a voltage is applied between the Input 1 and Input 2 ground shield, or between one of these ground shields and the black COM input, the PTC resistor will limit the resulting current. The voltage across the PTC resistor is supplied to the C-ASIC GPROT input, and causes a ground error warning (high voltage level) on output pin 24 (DACTEST).

Input 2 Voltage Measurements

The Input 2 circuit has no HF path. The principle of operation is the same as for the Input 1 LF path. The input ground is connected via PTC resistor R201 to the

measurement ground. Any voltage across the PTC resistor will be added to the input signal, and cause a mis-reading. This influences Input 2 in particular as this input operates mostly in the lowest voltage ranges (see section 3.2.1). For this reason a hum rejection circuit is added for Input 2. The voltage across the PTC is supplied to the inverting X1 amplifier N202. Then the AC part of the N202 output signal is subtracted from the input signal on the C-ASIC LF input (pin 42).

Resistance Measurements (Input 1 only)

The unknown resistance Rx is connected to Input 1, and the black COM input. The T-ASIC supplies a constant current to Rx via relay contacts K173, and the PTC resistor R172. The voltage across Rx is supplied to a high impedance input buffer in the C-ASIC via the LF input pin 42. The C-ASIC conditions the voltage across Rx to an output voltage of 50 mV/d. This voltage is supplied to the ADC on the Digital part. The ADC data is read and processed by the D-ASIC, and represented as a numerical reading, and a bar graph.

Table 3-4 shows the relation between the reading range (Ω), the trace sensitivity (Ω/d), and the current in Rx,

Table 3-4. Ohms Ranges, Trace Sensitivity, and Current

Range	50 Ω	500 Ω	5k Ω	50 k Ω	500 k Ω	5 M Ω	30 M Ω
Sensitivity ../div	20 Ω	200 Ω	2 k Ω	20 k Ω	200 k Ω	2 M Ω	10 M Ω
Current in Rx	500 μ A	500 μ A	50 μ A	5 μ A	500 nA	50 nA	50 nA

To protect the current source from being damaged by a voltage applied to the input, a PTC resistor R172 and a protection circuit are provided (See Section 3.3.3 “Current Source”).

During measuring, input voltage measurements, gain measurements, and zero measurements are done. As a result, the voltage supplied to the ADC is a multiplexed (zero, + reference, -reference, input voltage) signal.

Capacitance Measurements (Input 1 only)

The capacitance measurement is based on the equation: $C \times dV = I \times dt$. The unknown capacitor Cx is charged with a constant known current. The voltage across Cx increases, and the time lapse between two different known threshold crossings is measured. Thus dV, I and dt are known and the capacitance can be calculated.

The unknown capacitance Cx is connected to the red Input 1 safety banana socket, and the black COM input. The T-ASIC supplies a constant current to Cx via relay contacts K173, and protection PTC resistor R172. The voltage on Cx is supplied to two comparators in the C-ASIC via the LF input. The threshold levels th₁ and th₂ of the comparators are fixed (see Figure 3-9). The time lapse between the first and the second threshold crossing depends on the value of Cx. The resulting pulse is supplied to the TRIGGER output pin 29, which is connected to the analog trigger input of the T-ASIC (TRIG-A signal). The T-ASIC adjusts the pulse to an appropriate level, and supplies it to the D-ASIC via its ALLTRIG output. The pulse width is measured and processed by the D-ASIC, and represented on the LCD as numerical reading. There will be no trace displayed.

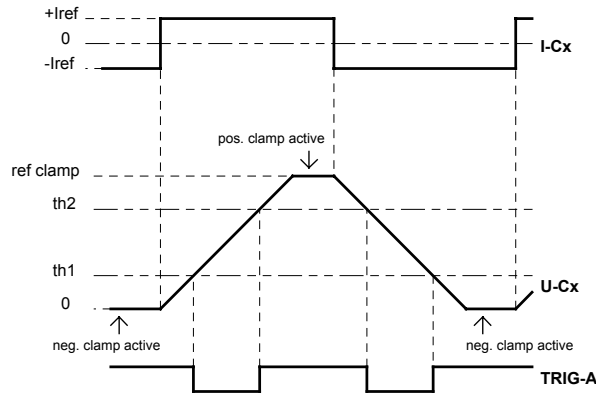

Figure 3-9. Capacitance Measurement

The T-ASIC supplies a positive (charge) and a negative (discharge) current. A measurement cycle starts from a discharged situation ($U_{CX}=0$) with a charge current. After reaching the first threshold level (th_1) the pulse width measurement is started. The dead zone between start of charge and start of pulse width measurement avoids measurement errors due to a series resistance of C_x .

The pulse width measurement is stopped after crossing the second threshold level (th_2), the completes the first part of the cycle.

Unlimited increase of the capacitor voltage is avoided by the positive clamp in the T-ASIC. The output of the high impedance buffer in the C-ASIC supplies a replica of the voltage across C_x to output pin 23 (ADDRESS). Via R165, this voltage is supplied to a clamp circuit in the T-ASIC (SENSE, pin 59). This clamp circuit limits the positive voltage on C_x to 0.45V.

Now the second part of the measurement is started by reversing the charge current. The capacitor will be discharged in the same way as the charge cycle. The time between passing both threshold levels is measured again. A clamp limits the minimum voltage on C_x to 0V.

Averaging the results of both measurements cancels the effect of a possible parallel resistance, and suppresses the influence of mains interference voltages.

Table 3-5 shows the relation between the capacitance ranges, the charge current and the pulse width at full scale.

Table 3-5. Capacitance Ranges, Current, and Pulse Width

Range	50 nF	500 nF	5000 nF	50 μ F	500 μ F
Current μ A	0.5 μ A	5 μ A	50 μ A	500 μ A	500 μ A
Pulse width at Full Scale	25 ms	25 ms	25 ms	25 ms	250 ms

To protect the current source if a voltage is applied to the input, a PTC resistor R172, and a protection circuit on the TRIGGER part, are provided (see Section 3.3.3).

Probe Detection

The Input 1 and Input 2 safety banana jacks are provided with a ground shield, consisting of two separated half round parts. One half is connected to ground via the protection PTC resistor R106/R206. Via a 220K resistor installed on the input block, the other half is connected to the probe input of the D-ASIC (pin 54, 55). If the shielded STL120 test

lead, or a BB120 shielded banana-to-BNC adapter, is inserted in Input 1 or Input 2, it will short the two ground shield halves. This can be detected by the D-ASIC.

Supply Voltages

The +5VA, +3V3A, and -3V3A supply voltages are supplied by the Fly Back Converter on the POWER part. The voltages are present only if the test tool is turned on.

3.3.3 Trigger Circuit

The description refers to circuit diagram Figure 9-3. The trigger section is built up around the T-ASIC OQ0257. It provides the following functions:

- Triggering: trigger source selection, trigger signal conditioning, and generation of trigger information to be supplied to the D-ASIC.
- Current source for resistance and capacitance measurements.
- Voltage reference source: buffering and generation of reference voltages.
- AC/DC relay and Resistance/Capacitance (Ω/F) relay control.

Triggering

Figure 3-10 shows the block diagram of the T-ASIC trigger section.

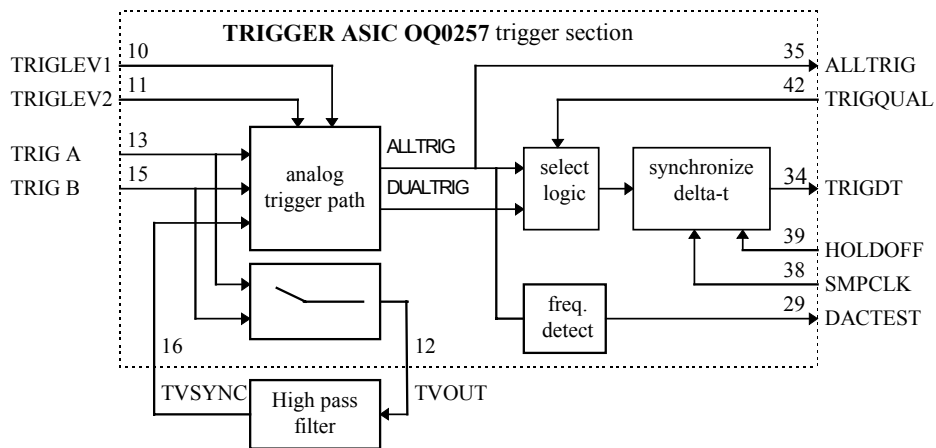

Figure 3-10. T-ASIC Trigger Section Block Diagram

The analog trigger path uses the Input 1 (TRIG A) or Input 2 (TRIG B) signal for triggering.

In the Transients mode the TRIG A or TRIG B signal is routed via a high pass filter (TVOUT - TVSYNC). The High Pass Filter consists of C395 and R399.

The TRIG-A, TRIG-B, or TVSYNC signal, and two trigger level voltages TRIGLEV1 and TRIGLEV2, are supplied to the analog trigger part. The trigger level voltages are, supplied by the PWM section on the Digital part (See Section 3.3.4). The TRIGLEV1 voltage is used for triggering on a negative slope of the Input 1/2 voltage. The TRIGLEV2 voltage is used for triggering on a positive slope of the Input 1/2 voltage. As the C-ASIC inverts the Input 1/2 voltage, the TRIGA, TRIGB slopes on the T-ASIC input are inverted! From the selected trigger source signal and the used trigger level voltages, the ALLTRIG and the DUALTRIG trigger signal are derived. The select logic selects which one will be used by the synchronization/delta-T circuit to generate the final trigger. There are three possibilities:

1. Single shot triggering.
The DUALTRIG signal is supplied to the synchronization/delta-T circuit. The trigger levels TRIGLEV1 and TRIGLEV2 are set just above and below the DC level of the input signal. A trigger is generated when the signal crosses the trigger levels. A trigger will occur on both a positive or a negative glitch. This mode ensures triggering, when the polarity of an expected glitch is not known.
2. Qualified triggering .
The ALLTRIG signal is supplied to T-ASIC output pin 35, which is connected to the D-ASIC input pin 21. The D-ASIC derives a qualified trigger signal TRIGQUAL from ALLTRIG, e.g. on each 10th ALLTRIG pulse a TRIGQUAL pulse is given. The TRIGQUAL is supplied to the synchronize/delta-T circuit via the select logic.
3. Normal triggering.
The ALLTRIG signal is supplied to the synchronization/delta-T circuit.

The ALLTRIG signal includes all triggers. It is used by the D-ASIC for signal analysis during AUTOSET.

Traditionally a small trigger gap is applied for each the trigger level. In noisy signals, this small-gap-triggering would lead to unstable displaying of the wave form, if the noise is larger than the gap. The result is that the system will trigger randomly. This problem is solved by increasing the trigger gap (TRIGLEV1 - TRIGLEV2) automatically to 80% (10 to 90%) of the input signal peak-to-peak value. This 80% gap is used in AUTOSET.

Note

The ALLTRIG signal is also used for capacitance measurements (S. 3.3.2).

The Synchronize/Delta-t part provides an output pulse TRIGDT. The front edge of this pulse is the real trigger moment. The pulse width is a measure for the time between the trigger moment, and the moment of the first sample after the trigger. This pulse width information is required in random repetitive sampling mode (see below). The HOLDOFF signal, supplied by the D-ASIC, releases the trigger system. The sample clock SMPCLK, also provided by the D-ASIC, is used for synchronization.

Real time sampling TRIGDT signal

For time base settings of 1 μ s/d and slower, the pixel distance on the LCD is ≥ 40 ns (1 division is 25 pixels). As the maximum sample rate is 25 MHz, a sample is taken each 40 ns. So the first sample after a trigger can be assigned to the first pixel, and successive samples to each next pixel. A trace can be built-up from a single period of the input signal.

Random repetitive (equivalent) sampling TRIGDT signal

For time base settings below 1 μ s/d, the time between two successive pixels on the screen is smaller than the time between two successive samples. For example at 20 ns/d, the time between two pixels is $20:25=0.8$ ns, and the sample distance is 40 ns (sample rate 25 MHz). A number of sweeps must be taken to reconstruct the original signal, see Figure 3-11. As the samples are taken randomly with respect to the trigger moment, the time dt must be known to position the samples on the correct LCD pixel. The TRIGDT signal is a measure for the time between the trigger and the sample moment dt. The pulse duration of the TRIGDT signal is approximately 4 μ s...20 μ s.

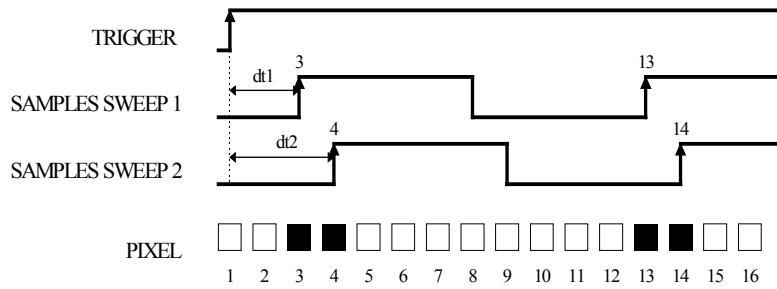

Figure 3-11. Random Repetitive Sampling Mode

DACTEST output

A frequency detector in the T-ASIC monitors the ALLTRIG signal frequency. If the frequency is too high to obtain a reliable transmission to the D-ASIC, the DACTEST output pin 29 will become high. The DACTEST signal is read by the D-ASIC via the slow ADC on the Power part. It indicates that the D-ASIC cannot use the ALLTRIG signal (e.g. for qualified triggering).

Current Source

A current source in the T-ASIC supplies a DC current to the GENOUT output pin 1. The current is used for resistance and capacitance measurements. It is adjustable in decades between 50 nA and 500 μA depending on the measurement range, and is derived from an external reference current. This reference current is supplied by the REFP reference voltage via R323 and R324 to input REFOHMIN (pin 6).

The SENSE input signal is the buffered voltage on Input 1. For capacitance measurements it is supplied to a clamp circuit in the T-ASIC (pin 59). The clamp circuit limits the positive voltage on the unknown capacitance to 0.45V.

The protection circuit prevents the T-ASIC from being damaged by a voltage applied to Input 1 during resistance or capacitance measurements. If a voltage is applied, a current will flow via PTC resistor R172 (on the Input 1 part), V358/V359, V353, V354 to ground. The resulting voltage across the diodes is approximately -2V or +15V. R354/R356, and V356/V357 limit the voltage on the T-ASIC GENOUT output (pin 1). The BOOTSTRAP output signal on pin 3 is the buffered GENOUT signal on pin 1, or the buffered SENSE signal on pin 59. It is supplied to the protection diodes via R352, R353, and to protection transistor V356, to minimize leakage currents.

On the ICAL-output of the T-ASIC (pin 5) a copy of the output current on GENOUT is available. The current is supplied to the Input 1 C-ASIC via R144. As ICAL shows the same time/temperature drift as the GENOUT measurement current, it can be used for internal calibration of the resistance and capacitance measurement function.

Capacitor C356 is used for hum/noise suppression.

Reference Voltage Circuit

This circuit derives several reference voltages from the 1.23 V main reference source.

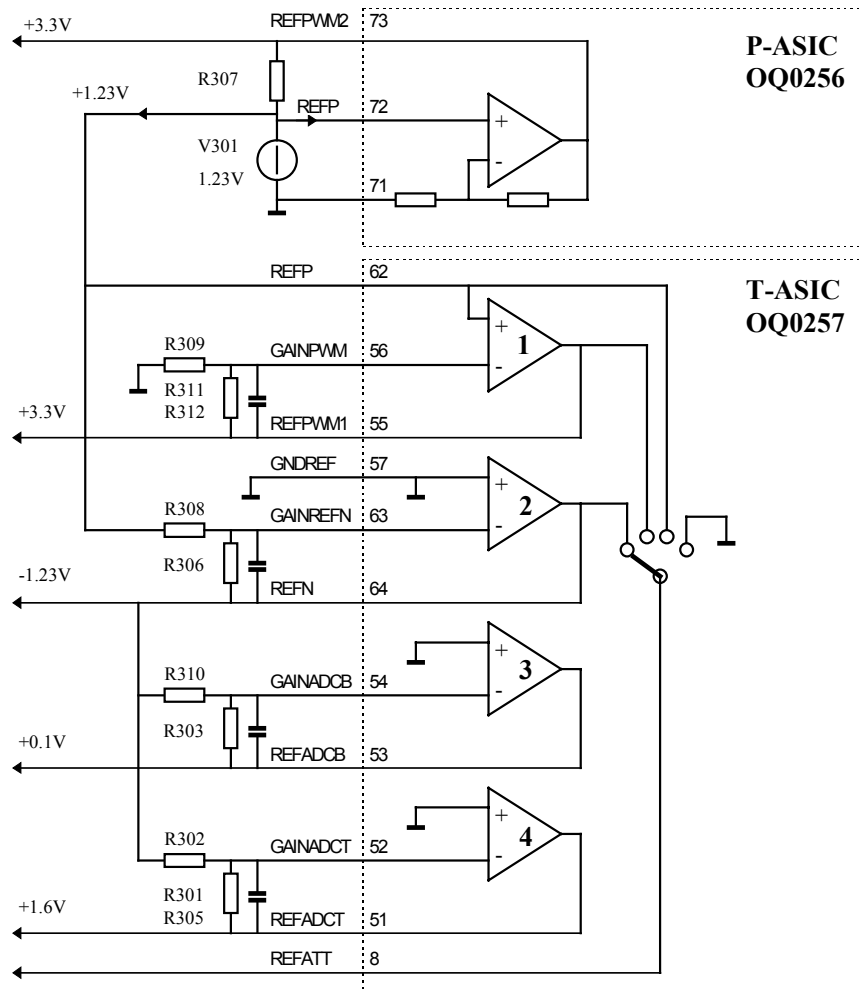

Figure 3-12. Reference Voltage Section

The output of an amplifier in the P-ASIC supplies a current to the +1.23 V reference source V301 via R307. The +3.3 V REFPWM2 voltage is used as reference for the PWM outputs of the D-ASIC on the Digital part.

The +1.23 V REFP voltage is used as main reference source for the reference circuit. This circuit consists of four amplifiers in the T-ASIC, external gain resistors, and filter capacitors.

Amplifier 1 and connected resistors supply the REFPWM1 reference voltage. This voltage is a reference for the PWMA outputs of the D-ASIC on the Digital section. It is also used as reference voltage for the LCD supply on the LCD unit.

Amplifier 2 and connected resistors supply the -1.23 V REFN reference voltage, used for the trigger level voltages TRIGLEV1&2, the C-ASIC POS-A and POS-B voltages, and the C-ASIC OFFSET-A and OFFSET-B voltages. REFN is also the input reference for amplifiers 3 and 4.

Amplifier 3 and 4 and connected resistors supply the REFADCT and REFADCB reference voltages for the ADC's. Both voltages directly influence the gain accuracy of the ADC's.

The T-ASIC can select some of the reference voltages to be output to pin 8 (REFATT). The REFATT voltage is used for internal calibration of the Input 1 and B overall gain.

Tracerot Signal

The T-ASIC generates the TRACEROT signal, used by the C-ASIC's. Control signals TROTRST and TROTCLK are provided by the D-ASIC.

AC/DC Relay and Ω /F Relay Control

The Input 1/2 AC/DC relays K171/K271, and the Input 1 Ω /F relay K173 are controlled by the T-ASIC output signals ACDCA (pin 22), ACDCB (pin 23) and OHMA (pin 24).

SCLK, SDAT Signals

T-ASIC control data, e.g. for trigger source/mode/edge selection and relay control, are provided by the D-ASIC via the SCLK and SDAT serial control lines..

3.3.4 Digital Circuit

See the Fluke 43B block diagram Figure 3-1, and circuit diagram Figure 9-4.

The Digital part is built up around the D-ASIC MOT0002. It provides the following functions:

- Analog to Digital Conversion of the conditioned Input 1 and Input 2 signals
- ADC data acquisition for traces and numerical readings
- Trigger processing
- Pulse width measurements, e.g. for capacitance measurement function
- Microprocessor, Flash EPROM and RAM control
- Display control
- Keyboard control, ON/OFF control
- Miscellaneous functions, as PWM signal generation, SDA-SCL serial data control, Slow ADC control, serial RS232 interface control, buzzer control, etcetera.

The D-ASIC is permanently powered by the +3V3GAR voltage. The P-ASIC indicates the status of the +3V3GAR voltage via the VGARVAL line connected to D-ASIC pin 89. If +3V3GAR is correct VGARVAL is high, the D-ASIC will start-up, and the D-ASIC functions are operative regardless of the test tool is ON/OFF status.

Analog to Digital Conversion

For voltage and resistance measurements, the Input 1/2 (2 for voltage only) signal is conditioned by the C-ASIC to 150 mV/d. Zero and gain measurements are done to eliminate offset and gain errors. The C-ASIC output voltage is supplied to the Input 1/2 ADC (D401/D451 pin 5). The ADC samples the analog voltage, and converts it into an 8-bit data byte (D0-D7). The data are read and processed by the D-ASIC, see below "ADC data Acquisition".

The sample rate depends on the sample clock supplied to pin 24. The sample rate is 5 MHz or 25 MHz, depending on the instrument mode. The ADC input signal is sampled

on the rising edge of the sample clock. The digital equivalent of this sample is available on the outputs D0-D7 with a delay of 6 sample clock cycles.

The reference voltages REFADCT and REFADCB determine the input voltage swing that corresponds to an output data swing of 00000000 to 11111111 (D0-D7). The reference voltages are supplied by the reference circuit on the Trigger part. The ADC output voltages MIDADC-A/B are supplied to the C-ASIC's (input pin 28), and are added to the conditioned input signal. The MIDADC voltage matches the middle of the C-ASIC output swing to the middle of the ADC input swing.

Current IREF is supplied to pin 7 of the ADC's via R403/R453 for biasing internal ADC circuits.

ADC data acquisition for traces and numerical readings

During an acquisition cycle, ADC samples are acquired for (Scope) traces and numerical readings.

The test tool software starts an acquisition cycle. The D-ASIC acquires data from the ADC, and stores them internally in a cyclic Fast Acquisition Memory (FAM). The D-ASIC also makes the HOLDOFF line low, to enable the T-ASIC to generate the trigger signal TRIGDT. The acquisition cycle is stopped if the required number of samples is acquired. From the FAM the ADC data are moved to the RAM D475. The ADC data stored in the RAM are processed and represented as traces and readings.

Triggering (HOLDOFF, TRIGDT, Randomize)

To start a new trace, the D-ASIC makes the HOLDOFF signal low. Now the T-ASIC can generate the trigger signal TRIGDT. For signal frequencies higher than the system clock frequency, and in the random repetitive sampling mode, no fixed time relation between the HOLDOFF signal and the system clock is allowed. The RANDOMIZE circuit desynchronizes the HOLDOFF from the clock, by phase modulation with a LF ramp signal.

Trigger qualifying (ALLTRIG, TRIGQUAL)

The ALLTRIG signal supplied by the T-ASIC contains all possible triggers. For normal triggering the T-ASIC uses ALLTRIG to generate the final trigger TRIGDT. For qualified triggering the D-ASIC returns a qualified, e.g. each n^{th} , trigger pulse to the T-ASIC (TRIGQUAL). Now the T-ASIC derives the final trigger TRIGDT from the qualified trigger signal TRIGQUAL.

Capacitance measurements (ALLTRIG)

As described in Section 3.3.2, capacitance measurements are based on measuring the capacitor charging time using a known current. The ALLTRIG pulse signal represents the charging time. The time is counted by the D-ASIC.

Microprocessor, ROM and RAM control, mask ROM

The D-ASIC includes a microprocessor with a 16 bit data bus. The instrument software is loaded in Flash ROM D472.

Measurement data and instrument settings are stored in RAM D475. All RAM data will be lost if all power sources (battery and power adapter) are removed.

The D-ASIC has on-chip mask ROM. If no valid Flash ROM software is present when the test tool is turned on, the mask ROM software will become activate. The test tool can be forced to stay in the mask ROM software by pressing the ^ and > key, and then turning the test tool on. When active, the mask ROM software generates a 100 kHz square wave on pin 59 of the D-ASIC.

The circuit D480 and related parts create a delay for the ROMWRITE enable signal. This prevents the ROM write process being disabled before all data have been written (PCB version 3 up only).

Display Control

The LCD unit includes the LCD, the LCD drivers, and the fluorescent back light lamp. It is connected to the main board via connector X453. The LCD is built up of 240 columns of 240 pixels each (240x240 matrix). The D-ASIC supplies the data and control signals for the LCD drivers on the LCD unit (Figure 3-13).

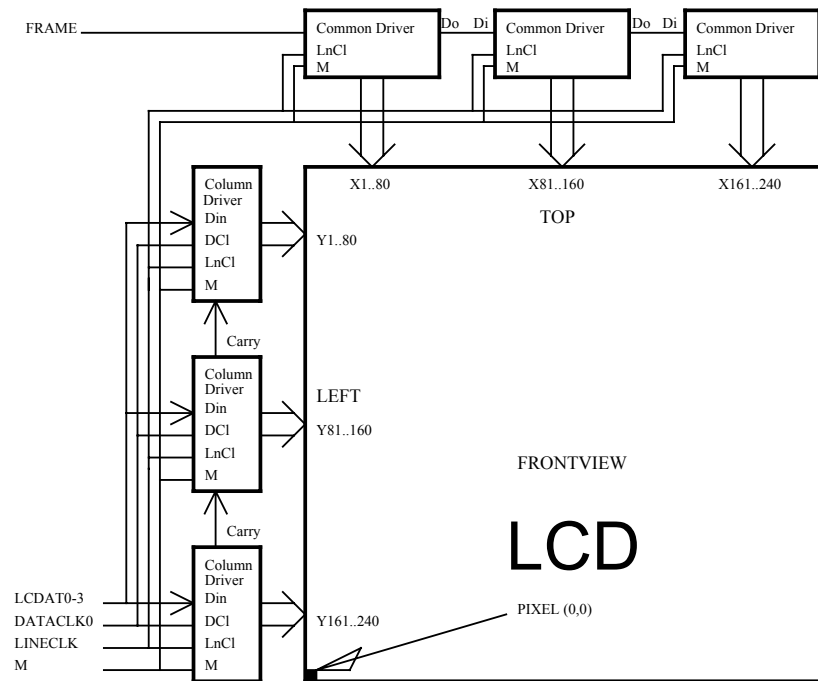

Figure 3-13. LCD Control

Each 14 ms the LCD picture is refreshed during a frame. The frame pulse (FRAME) indicates that the concurrent LINECLK pulse is for the first column. The column drivers must have been filled with data for the first column. Data nibbles (4 bit) are supplied via lines LCDAT0-LCDAT3. During 20 data clock pulses (DATACLK0) the driver for Y161..240 is filled. When it is full, it generates a carry to enable the driver above it, which is filled now. When a column is full, the LINECLK signal transfers the data to the column driver outputs. Via the common drivers the LINECLK also selects the next column to be filled. So after 240 column clocks a full screen image is built up.

The LCD unit generates various voltage levels for the LCD drivers outputs to drive the LCD. The various levels are supplied to the driver outputs, depending on the supplied data and the M(ultiplex) signal. The M signal (back plane modulation) is used by the LCD drivers to supply the various DC voltages in such an order, that the average voltage does not contain a DC component. A DC component in the LCD drive voltage may cause memory effects in the LCD.

The LCD contrast is controlled by the CONTRAST voltage. This voltage is controlled by the D-ASIC, which supplies a PWM signal (pin 37 CONTR-D) to PWM filter R436/C436. The voltage REFPWM1 is used as bias voltage for the contrast adjustment circuit on the LCD unit. To compensate for contrast variations due to temperature

variations, a temperature dependent resistor is mounted in the LCD unit. It is connected to the LCDTEMP1 line. The resistance change, which represents the LCD temperature, is measured by the D-ASIC via the S-ADC on the POWER part.

The back light lamp is located at the left side of the LCD, so this side becomes warmer than the right side. As a result the contrast changes from left to right. To eliminate this unwanted effect, the CONTRAST control voltage is increased during building up a screen image. A FRAME pulse starts the new screen image. The FRAME pulse is also used to discharge C404. After the FRAME pulse, the voltage on C404 increases during building up a screen image.

Keyboard Control, ON/OFF Control

The keys are arranged in a 6 rows x 6 columns matrix. If a key is pressed, the D-ASIC drives the rows, and senses the columns. The ON/OFF key is not included in the matrix. This key toggles a flip-flop in the D-ASIC via the ONKEY line (D-ASIC pin 72). As the D-ASIC is permanently powered, the flip-flop can signal the test tool on/off status.

PWM Signals

The D-ASIC generates various pulse signals, by switching a reference voltage (REFPWM1 or REFPWM2), with software controllable duty cycle (PWMA, PWMB pins 26-40). By filtering the pulses in low pass filters (RC), software controlled DC voltages are generated. The voltages are used for various control purposes, as shown in Table 3-6.

Table 3-6. D-ASIC PWM Signals

PWM signal	Function	Destination	Reference
HO-RNDM	HOLDOFF randomize control	R487 of RANDOMIZE circuit	REFPWM1
TRGLEV1D, TRIGLEV2D	Trigger level control	T-ASIC	REFPWM1
POS-AD, POS-BD	Input 1,B position control	C-ASIC	REFPWM1
OFFSETAD, OFFSETBD	Input 1,B offset control	C-ASIC	REFPWM1
BACKBRIG	Back light brightness control	Back light converter (POWER part)	REFPWM1
CONTR-D	Display contrast control	LCD unit	REFPWM1
SADCLEVD	S ADC comparator voltage	SLOW ADC (POWER part)	REFPWM2
CHARCURD	Battery charge current control	P-ASIC	REFPWM2

SDA-SCL Serial Bus

The unidirectional SDA-SCL serial bus (pin 56, 57) is used to send control data to the C-ASIC's (e.g. change attenuation factor), and the T-ASIC (e.g. select other trigger source). The SDA line transmits the data bursts, the SCL line transmits the synchronization clock (1.25 MHz).

Probe Detection

Via the probe detection inputs PROBE-A and PROBE-B (pin 54, 55), the D-ASIC detects if the Input 1 and 2 probes have been connected/disconnected. The SUPPRDET signal (pin 99) can suppress the probe detection. If this signal is low, The PROBE-A and PROBE-B lines are permanently low (via R471, R472), regardless of a probe is connected or not connected. This function is used in all appropriate modes except the SCOPE mode.

TXD, RXD Serial Interface (Optical Port)

The optical interface output is directly connected to the TXD line (pin 86). The optical input line is buffered by the P-ASIC on the power part. The buffered line is supplied to the RXD input (pin 87). The serial data communication (RS232) is controlled by the D-ASIC.

Slow ADC Control, SADC Bus

The SELMUX0-2 (pins 96-98) and SLOWADC (pin 100) lines are used for measurements of various analog signals, as described in Section 3.3.1. "SLOW ADC".

BATIDENT

The BATTIDENT line (pin 90) is connected to R508 on the Power part, and to a resistor in the battery pack. If the battery is removed, this is signaled to the D-ASIC (BATTIDENT line goes high).

MAINVAL, FREQPS

The MAINVAL signal (pin91) is supplied by the P-ASIC, and indicates the presence of the power adapter voltage (high = present).

The FREQPS signal (pin 93) is also supplied by the P-ASIC. It is the same signal that controls the Fly Back Converter control voltage FLYGATE. The D-ASIC measures the frequency in order to detect if the Fly Back Converter is running within specified frequency limits.

D-ASIC Clocks

A 25 MHz crystal (B403) controls the D-ASIC system clock. For the real time clock, counting the time and date, an additional 32.768 kHz crystal (B401) is provided. When the test tool is turned on, a 16MHz microprocessor clock (derived from B402) becomes active.

Buzzer

The Buzzer is directly driven by a 4 kHz square wave from the D-ASIC (pin 101) via FET V522. If the test tool is on, the -30VD supply from the Fly Back converter is present, and the buzzer sounds loudly. If the -30VD is not present, the buzzer sounds weak, e.g. when the Mask Active mode is entered.

Chapter 4

Performance Verification

Title	Page
4.1 Introduction.....	4-3
4.2 Equipment Required For Verification.....	4-3
4.3 How To Verify.....	4-3
4.4 Display and Backlight Test.....	4-4
4.5 Input 1 and Input 2 Tests in the SCOPE MODE.....	4-5
4.5.1 Input 1 Trigger Sensitivity Test.....	4-6
4.5.2 Input 1 Frequency Response Upper Transition Point Test.....	4-7
4.5.3 Input 1 Frequency Measurement Accuracy Test.....	4-7
4.5.4 Input 2 Frequency Measurement Accuracy Test.....	4-9
4.5.5 Input 2 Trigger Level and Trigger Slope Test.....	4-10
4.5.6 Input 2 Trigger sensitivity Test.....	4-12
4.5.7 Input 1 Trigger Level and Trigger Slope Test.....	4-13
4.5.8 Input 1 and 2 DC Voltage Accuracy Test.....	4-15
4.5.9 Input 1 and 2 AC Voltage Accuracy Test.....	4-17
4.5.10 Input 1 and 2 AC Input Coupling Test.....	4-19
4.5.11 Input 1 and 2 Volts Peak Measurements Test.....	4-20
4.5.12 Input 1 and 2 Phase Measurements Test.....	4-21
4.5.13 Input 1 and 2 High Voltage AC & DC Accuracy Test.....	4-22
4.6 Ohms/Continuity/Capacitance.....	4-25
4.6.1 Resistance Measurements Test.....	4-25
4.6.2 Diode Test Function Test.....	4-26
4.6.3 Continuity Function Test.....	4-27
4.6.4 Capacitance Measurements Test.....	4-27
4.7 Inrush Current.....	4-28
4.8 Sags & Swells.....	4-29
4.9 Harmonics.....	4-30
4.10 VOLT/AMPS/HERTZ.....	4-31
4.11 POWER.....	4-31
4.12 Transients.....	4-32

4.1 Introduction

Warning

Procedures in this chapter should be performed by qualified service personnel only. To avoid electrical shock, do not perform any servicing unless you are qualified to do so.

The test tool should be calibrated and in operating condition when you receive it.

The following performance tests are provided to ensure that the test tool is in a proper operating condition. If the test tool fails any of the performance tests, calibration adjustment (see Chapter 5) and/or repair (see Chapter 7) is necessary.

The Performance Verification Procedure is based on the specifications, listed in Chapter 2 of this Service Manual. The values given here are valid for ambient temperatures between 18 °C and 28 °C.

The Performance Verification Procedure is a quick way to check most of the test tool's specifications. Because of the highly integrated design of the test tool, it is not always necessary to check all features separately. For example: the duty cycle, pulse width, and frequency measurement are based on the same measurement principles; so only one of these functions needs to be verified.

4.2 Equipment Required For Verification

The primary source instrument used in the verification procedures is the Fluke 5500A. If a 5500A is not available, you can substitute another calibrator as long as it meets the minimum test requirements.

Power Quality Option **5520A-PQ** is not strictly necessary for the tests in this chapter, but it offers useful test signals to test modes such as Harmonics and Sags & Swells.

- Fluke 5500A Multi Product Calibrator, including 5500A-SC Oscilloscope Calibration Option.
- Stackable Test Leads (4x), supplied with the 5500A.
- 50Ω Coax Cables (2x), Fluke PM9091 (1.5m) or PM9092 (0.5m).
- 50Ω feed through termination's (2x), Fluke PM9585.
- Fluke BB120 Shielded Banana to Female BNC adapters (2x), supplied with the Fluke 43B.
- Dual Banana Plug to Female BNC Adapter (1x), Fluke PM9081/001.
- Dual Banana Jack to Male BNC Adapter (1x), Fluke PM9082/001.

4.3 How To Verify

Verification procedures for the display function and measure functions follow. For each procedure the test requirements are listed. If the result of the test does not meet the requirements, the test tool should be recalibrated or repaired if necessary.



Follow these general instructions for all tests:

- For all tests, power the test tool with the PM8907 power adapter. The battery pack must be installed.
- Allow the 5500A to satisfy its specified warm-up period.
- For each test point, wait for the 5500A to settle.
- Allow the test tool a minimum of 20 minutes to warm up.

4.4 Display and Backlight Test





Before doing the tests, you must reset the test tool to put it in a defined state.

Proceed as follows to reset the test tool:

- Press  to turn the test tool off.
- Press and hold .
- Press and release  to turn the test tool on.

Wait until the test tool has **beeped twice**, and then release . When the test tool has beeped twice, the RESET was successful.

Proceed as follows to test the display and the backlight:

1. Press  to turn the test tool on.
2. Remove the adapter power, and verify that the backlight is dimmed.
3. Apply the adapter power and verify that the backlight brightness is set to maximum.
4. Press  to leave the STARTUP screen.
5. Press and hold .
6. Press and release .
7. Release .

The test tool shows the calibration menu in the bottom of the display.

Do not press  now! If you did, press  twice to turn the test tool off and on, and start at 4.

8. Press  (PREV) three times.
The test tool shows **Contrast (CL 0100):MANUAL**

9. Press  (CAL).
The test tool shows a dark display; the test pattern as shown in Figure 4-1 may not be visible or hardly visible.
Observe the display closely, and verify that no light pixels are shown.

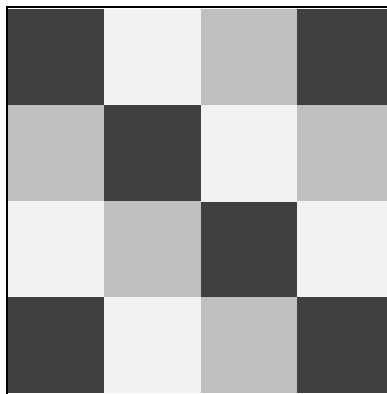









Figure 4-1. Display Pixel Test Pattern

11. Press  .
 The test pattern is removed; the test tool shows **Contrast (CL 0110):MANUAL**
12. Press  (CAL) .
 The test tool shows the display test pattern shown in Figure 4-1, at default contrast. Observe the test pattern closely, and verify that the no pixels with abnormal contrast are present in the display pattern squares. Also verify that the contrast of the upper left and upper right square of the test pattern are equal.
13. Press  .
 The test pattern is removed; the test tool shows **Contrast (CL 0120):MANUAL**
14. Press  (CAL) .
 The test tool shows a light display; the test pattern as shown in Figure 4-1 may not be visible or hardly visible. Observe the display closely, and verify that no dark pixels are shown.
15. Press  twice to turn the test tool OFF and ON to exit the calibration menu and to return to the normal operating mode.

4.5 Input 1 and Input 2 Tests in the SCOPE MODE.





Before performing the Input 1 and Input 2 tests, the test tool must be set in a defined state, by performing a RESET.

Proceed as follows to reset the test tool:

- Press  to turn the test tool off.
- Press and hold  .
- Press and release  to turn the test tool on.

Wait until the test tool has **beeped twice**, and then release  . When the test tool has beeped twice, the RESET was successful.

Now you must select the SCOPE MODE.

- Press  to leave the STARTUP screen.
- Press  .
- Press up-down  till SCOPE is highlighted.
- Press  to select SCOPE mode.

4.5.1 Input 1 Trigger Sensitivity Test

Proceed as follows to test the Input 1 trigger sensitivity:

1. Connect the test tool to the 5500A as shown in Figure 4-2.

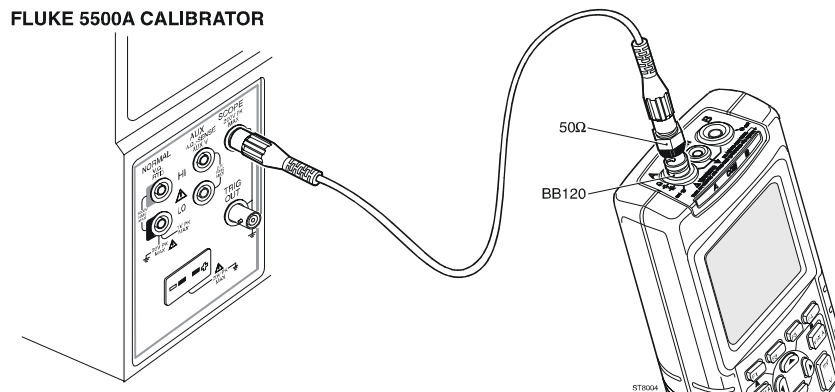















Figure 4-2. Test Tool Input 1 to 5500A Scope Output 50Ω

ST8004.WMF

2. Select the AUTO test tool setup:
 - Press **MENU** to select the MENU.
 - Press **↕** till SCOPE is highlighted.
 - Press **ENTER** to select SCOPE mode.
3. Select timebase of 100 ns/d.
 - Press **F2** to select RANGE.
 - Press **↔** to select 100 ns/d.
4. Select sensitivity of 200 mV/d.
 - Press **↕** to select 200 mV/d.
5. Set the 5500A to source a 5 MHz leveled sine wave of 100 mV peak-to-peak (SCOPE output, MODE levsine).
6. Verify that the signal is well triggered , if necessary adjust the trigger level (see 7).
7. Adjusting trigger level.
 - Press **ENTER** to highlight TRIGGER, then press **↕** to adjust the trigger level.
8. Set the 5500A to source a 25 MHz leveled sine wave of 400 mV peak-to-peak.
9. Select timebase of 20 ns/d.
 - Press **F2** to select RANGE.
 - Press **↔** to select 20 ns/d.
10. Verify that the signal is well triggered , if necessary adjust the trigger level (see 7).
11. Set the 5500A to source a 40 MHz leveled sine wave of 1.8V peak-to-peak.
12. Verify that the signal is well triggered, if necessary adjust the trigger level (see 7).
13. When you are finished, set the 5500A to Standby.

4.5.2 Input 1 Frequency Response Upper Transition Point Test

Proceed as follows to test the Input 1 frequency response upper transition point:



1. Connect the test tool to the 5500A as for the previous test (see Figure 4-2).
2. Select the AUTO test tool setup:
 - Press  to select the MENU.
 - Press  till SCOPE is highlighted.
 - Press  to select SCOPE mode
3. Select the following test tool setup:
 - Press  to select menu SCOPE SETUP.
 - Press  to highlight Input 1 Reading
 - Press  to go to Input 1 READING.
 - Press  to highlight AC + DCrms.
 - Press  to confirm; mark changes to
 - Press  to highlight Input 1 Coupling.
 - Press  to select the Input 1 Coupling menu.
 - Press  to highlight DC Coupling.
 - Press  to confirm; mark changes to .
 - Press  to return to SCOPE.
4. Set the 5500A to source a leveled sine wave of 1.2V peak-to-peak, 50 kHz (SCOPE output, MODE levsine).
5. Adjust the amplitude of the sine wave to a reading of $424 \text{ mV} \pm 8 \text{ mV}$.
6. Set the 5500A to 20 MHz, without changing the amplitude.
7. Observe the Input 1 trace and check the reading is $\geq 297 \text{ mV}$.
8. When you are finished, set the 5500A to Standby.

Note

The lower transition point is tested in Section 4.5.9.

4.5.3 Input 1 Frequency Measurement Accuracy Test

Proceed as follows to test the Input 1 frequency measurement accuracy:

1. Connect the test tool to the 5500A as for the previous test (see Figure 4-2).
2. Select the AUTO test tool setup:
 - Press  to select the MENU.
 - Press  till SCOPE is highlighted
 - Press  to select SCOPE mode.

3. Select the following test tool setup:
 - Press **F1** to select menu SCOPE SETUP.
 - Press **↓** to highlight Input 1 coupling.
 - Press **ENTER** to select the Input 1 coupling menu.
 - Press **↓** to highlight DC Coupling.
 - Press **ENTER** to confirm; mark changes to .
 - Press **↓** to highlight Input 1 Reading
 - Press **ENTER** to go to Input 1 READING.
 - Press **↓** to highlight Hz.
 - Press **ENTER** to confirm; mark changes to .
 - Press **F1** to return to SCOPE.
4. Set the 5500A to source a leveled sine wave of 600 mV peak-to-peak (SCOPE output, MODE levsine).
5. Set the 5500A frequency according to the first test point in Table 4-1.
6. Observe the Input 1 Reading on the test tool and check to see if it is within the range shown under the appropriate column.
7. Continue through the test points.
8. When you are finished, set the 5500A to Standby.

Table 4-1. Input 1 Frequency Measurement Accuracy Test

5500A output, 600 mVpp	Input 1 Reading
1 MHz	0.98 to 1.03 MHz
10 MHz	09.7 to 10.3 MHz
40 MHz	38.8 to 41.2 MHz

Note

Duty Cycle and Pulse Width measurements are based on the same principles as Frequency measurements. Therefore the Duty Cycle and Pulse Width measurement function will not be verified separately.

4.5.4 Input 2 Frequency Measurement Accuracy Test

Proceed as follows to test the Input 2 frequency measurement accuracy:

1. Connect the test tool to the 5500A as shown in Figure 4-3.

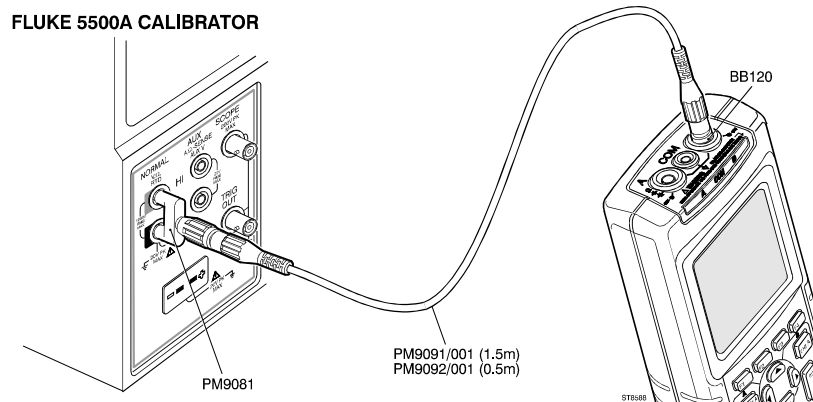























Figure 4-3. Test Tool Input 2 to 5500A NORMAL output























ST8588.wmf

2. Select the AUTO test tool setup:
 - Press **MENU** to select the MENU.
 - Press **↑** till SCOPE is highlighted.
 - Press **ENTER** to select SCOPE mode
3. Select the following test tool setup:
 - Press **F1** to select menu SCOPE SETUP.
 - Press **↑** to highlight Input 2 Reading
 - Press **ENTER** to go to Input 2 READING.
 - Press **↑** to highlight Hz.
 - Press **ENTER** to confirm; mark changes to .
 - Press **↑** to highlight Input 2 Coupling.
 - Press **ENTER** to select the Input 2 Coupling menu.
 - Press **↑** to highlight DC Coupling.
 - Press **ENTER** to confirm; mark changes to .
 - Press **F1** to return to SCOPE.
4. Set the 5500A to source a sine wave of 600 mV, 15 kHz (NORMAL output, MODE WAVE sine).
5. Observe the Input 2 main reading on the test tool and check the reading between 14.8 and 15.2 kHz.
6. When you are finished, set the 5500A to Standby.

4.5.5 Input 2 Trigger Level and Trigger Slope Test

Proceed as follows:



















1. Connect the test tool to the 5500A as for the previous test shown in Figure 4-3.
2. Select the AUTO test tool setup:
 - Press  to select the MENU.
 - Press  till SCOPE is highlighted.
 - Press  to select SCOPE mode
3. Make Input 2 active:
 - Press  to select menu SCOPE SETUP.
 - Press  to highlight the Input 2 READING.
 - Press  to select Input 2 READING.
 - Press  to highlight AC+DCrms.
 - Press  to confirm; mark changes to .
 - Press  to highlight Input 2 Coupling.
 - Press  to select the Input 2 Coupling menu.
 - Press  to highlight DC Coupling.
 - Press  to confirm; mark changes to .
 - Press  to return to SCOPE.
4. Select trigger on channel 2.
 - Short-circuit Input 1 with a BB120 and a 50Ω feed through terminator.
 - Set the 5500A to source 1V, 50 Hz sine wave (NORMAL output, MODE WAVE sine).
5. Select the following test tool setup:
 - Press  to select RANGE, then press  to select RANGE 2.
 - Press  to select 1 kA/d.
 - Press  to select a timebase of 10 ms/d.
 - Press .
 - Press  to select TRIGGER.
 - Using  set the trigger level to +2 divisions from the screen center. For **positive slope** triggering, the trigger level is the **top** of the trigger icon (↵).
6. Set the 5500A to source 0.4V DC.
 - Press  to select menu SCOPE SETUP.
 - Press  to highlight Time base.

- Press  to select the TIME BASE menu.
 - Press  to select SINGLE.
 - Press  to confirm; mark changes to .
 - Press  to highlight Trigger slope.
 - Press  to select the TRIGGER SLOPE menu.
 - Press  to highlight positive trigger (.
 - Press  to confirm; changes to .
 - Press  to return to SCOPE.
7. Verify that no trace is shown on the test tool display, and that at the upper right corner of the display HOLD is not shown. If the display shows HOLD then press . Hold should disappear and the test tool is re-armed for a trigger.
 8. Increase the 5500A voltage slowly in 0.1V steps, using the 5500A EDIT FIELD function, until the test tool is triggered, and the traces are shown.
 9. Verify that the 5500A voltage is between **+1.5V and +2.5V** when the test tool is triggered.
To repeat the test set the 5500A to 0.4V and start at step 5.
 10. Set the 5500A to Standby.
 11. Press  to clear the display.
 12. Select negative TRIGGER SLOPE.
 - Press  to select menu SCOPE SETUP.
 - Press  to highlight Trigger slope.
 - Press  to select the TRIGGER SLOPE menu.
 - Press  to highlight negative trigger (.
 - Press  to confirm; mark changes to .
 - Press  to return to SCOPE.
 13. Set the trigger level to +2 divisions from the screen center. For **negative slope** triggering, the trigger level is the **bottom** of the trigger icon ().
 - Press  to select TRIGGER.
 - Using  set the trigger level to +2 divisions from the screen center.
 14. Set the 5500A to source +3V DC.
 15. Verify that no trace is shown on the test tool display, and that at the upper right corner of the display HOLD is not shown. If the display shows HOLD then press . Hold should disappear and the test tool is re-armed for a trigger.
 16. Decrease the 5500A voltage slowly in 0.1V steps, using the 5500A EDIT FIELD function, until the test tool is triggered, and the traces are shown.

17. Verify that the 5500A voltage is between **+1.5V and +2.5V** when the test tool is triggered.
To repeat the test, start at step 12.
18. When you are finished, set the 5500A to Standby.

4.5.6 Input 2 Trigger sensitivity Test.

Proceed as follows to test the Input 2 trigger sensitivity:

1. Connect the test tool to the 5500A as for the previous test shown in Figure 4-3.
2. Select the AUTO test tool setup:
 - Press  to select the MENU.
 - Press  till SCOPE is highlighted.
 - Press  to select SCOPE mode.
3. Make Input 2 active:
 - Press  to select menu SCOPE SETUP.
 - Press  to select Input 2 READING.
 - Press  to highlight AC+DCrms.
 - Press  to confirm; mark changes to .
 - Press  to highlight Input 2 Coupling.
 - Press  to select the Input 2 Coupling menu.
 - Press  to highlight DC Coupling.
 - Press  to confirm; mark changes to .
 - Press  to return to SCOPE.
4. Select trigger on channel 2.
 - Short-circuit Input 1 with a BB120 and a 50Ω feed through piece.
 - Set the 5500A to source a 5 kHz leveled sine wave of 100 mVpp (NORMAL output, MODE wave sine). If necessary readjust signal amplitude to 0.5 div.
5. Select the following test tool setup:
 - Press  and select RANGE 2.
 - Press  to select 200A/d.
 - Press  to select a timebase of 50 μs/d.
6. Verify that the signal is well triggered , if necessary adjust the trigger level (see 7).
7. Adjusting trigger level.
 - Press  .
 - Press  to highlight TRIGGER.
 - Press  to adjust.

8. Select timebase of 10 μ s/d.
 - Press **F2** to select RANGE.
 - Press **↕** to select 10 μ s/d.
9. Set the 5500A to source a 20 kHz leveled sine wave of 100 mV peak-to-peak (if necessary adjust the 5500A to half a division peak-to-peak on the display).
10. Verify that the signal is well triggered , if necessary adjust the trigger level (see 7).
11. When you are finished, set the 5500A to Standby.

4.5.7 Input 1 Trigger Level and Trigger Slope Test

Proceed as follows:

1. Connect the test tool to the 5500A as shown in Figure 4-4.

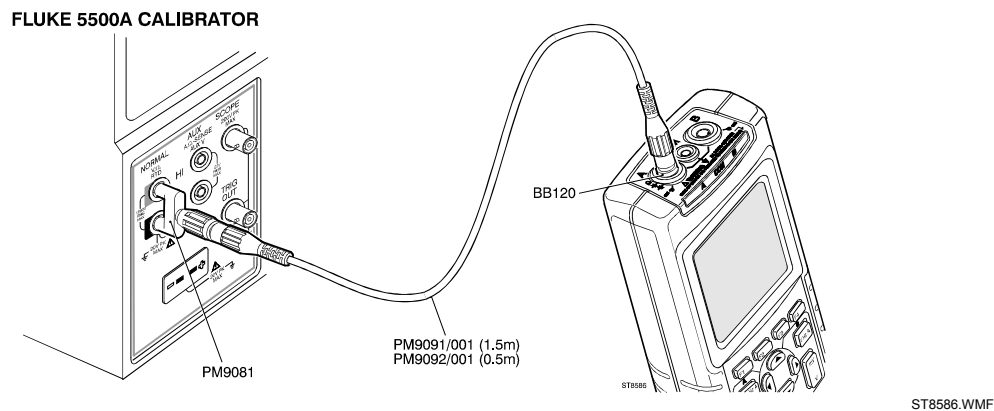





























Figure 4-4. Test Tool Input 1 to 5500A Normal Output

2. Select the AUTO test tool setup:
 - Press **MENU** to select the MENU.
 - Press **↕** till SCOPE is highlighted.
 - Press **ENTER** to select SCOPE mode
3. Select the following test tool setup:
 - Press **F1** to select menu SCOPE SETUP.
 - Press **ENTER** to select Input 1 READING.
 - Press **↕** to highlight AC+DCrms.
 - Press **ENTER** to confirm; mark changes to .
 - Press **↕** to highlight Input 1 Coupling.
 - Press **ENTER** to select the Input 1 Coupling menu.
 - Press **↕** to highlight DC Coupling.
 - Press **ENTER** to confirm; mark changes to .
 - Press **F1** to return to SCOPE.

- Press  to select Input 1 RANGE.
 - Press  to select 1V/d.
 - Press  to select a timebase of 10 ms/d.
 - Press  to leave RANGE 1.
 - Press  to select TRIGGER.
 - Using  set the trigger level to +2 divisions from the screen center. For **positive slope** triggering, the trigger level is the **top** of the trigger icon ().
4. Set the 5500A to source 0.4V DC.
 - Press  to select menu SCOPE SETUP.
 - Press  to highlight Time base.
 - Press  to select the TIME BASE menu.
 - Press  to select SINGLE.
 - Press  to confirm; mark changes to .
 - Press  to highlight Trigger slope.
 - Press  to select the TRIGGER SLOPE menu.
 - Press  to highlight positive trigger ().
 - Press  to confirm; changes to .
 - Press  to return to SCOPE.
 5. Verify that no trace is shown on the test tool display, and that at the upper right corner of the display HOLD is not shown. If the display shows HOLD then press . Hold should disappear and the test tool is re-armed for a trigger.
 6. Increase the 5500A voltage slowly in 0.1V steps, using the 5500A EDIT FIELD function, until the test tool is triggered, and the traces are shown.
 7. Verify that the 5500A voltage is between **+1.5V and +2.5V** when the test tool is triggered.
To repeat the test set the 5500A to .4V and start at step 5.
 8. Set the 5500A to Standby.
 9. Press  to clear the display.
 10. Select negative TRIGGER SLOPE.
 - Press  to select menu SCOPE SETUP.
 - Press  to highlight Trigger slope.
 - Press  to select the TRIGGER SLOPE menu.
 - Press  to highlight negative trigger ().
 - Press  to confirm; mark changes to .
 - Press  to return to SCOPE.

11. Set the 5500A to source +3V DC.
12. Set the trigger level to +2 divisions from the screen center. For **negative slope** triggering, the trigger level is the **bottom** of the trigger icon (⌋).
 - Press **ENTER** to select TRIGGER.
 - Using **↻** set the trigger level to +2 divisions from the screen center.
13. Verify that no trace is shown on the test tool display, and that at the upper right corner of the display HOLD is not shown. If the display shows HOLD then press **HOLD RUN**. Hold should disappear and the test tool is re-armed for a trigger.
14. Decrease the 5500A voltage slowly in 0.1V steps, using the 5500A EDIT FIELD function, until the test tool is triggered, and the traces are shown.
15. Verify that the 5500A voltage is between **+1.5V and +2.5V** when the test tool is triggered.
To repeat the test, start at step 12.
16. When you are finished, set the 5500A to Standby.

4.5.8 Input 1 and 2 DC Voltage Accuracy Test.

WARNING

Dangerous voltages will be present on the calibration source and connecting cables during the following steps. Ensure that the calibrator is in standby mode before making any connection between the calibrator and the test tool.

Proceed as follows:

1. Connect the test tool to the 5500A in Figure 4-5.

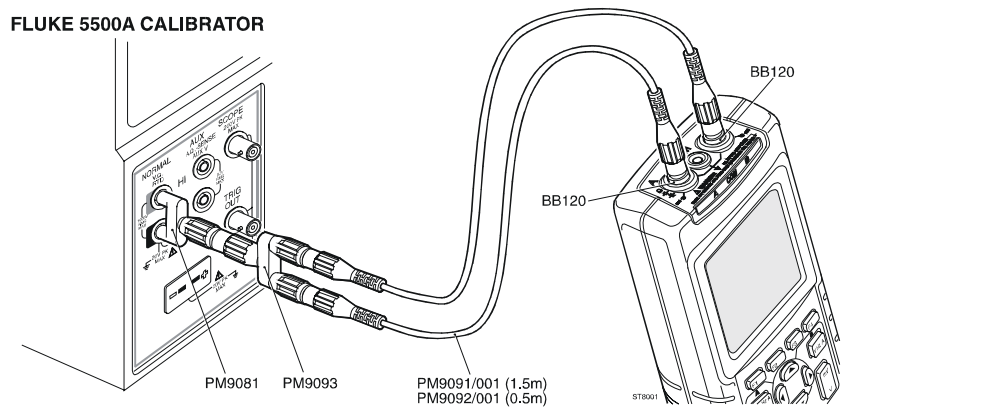

Figure 4-5. Test Tool Input 1-2 to 5500A Normal Output

2. Select the AUTO test tool setup:
 - Press **MENU** to select the MENU.
 - Press **↻** till SCOPE is highlighted.
 - Press **ENTER** to select SCOPE mode.





















3. Select DC coupling & reading for Input 1 and 2.
 - Press  to select menu SCOPE SETUP.
 - Press  to select Input 1 READING.
 - Press  to highlight DC.
 - Press  to confirm; mark changes to .
 - Press  to highlight Input 1 Coupling.
 - Press  to select the Input 1 Coupling menu.
 - Press  to highlight DC Coupling.
 - Press  to confirm; mark changes to .
 - Press  to select Input 2 READING.
 - Press  to select the Input 2 READING
 - Press  to highlight DC.
 - Press  to confirm; mark changes to .
 - Press  to highlight Input 2 Coupling.
 - Press  to select the Input 2 COUPLING.
 - Press  to highlight DC Coupling.
 - Press  to confirm; mark changes to .
 - Press  to return to SCOPE.
4. Set the 5500A to source the appropriate DC voltage from table 4-2.
5. Observe the main reading and check to see if it is within the range shown under the appropriate column.
6. Select the appropriate sensitivity for the test tool:
 - Press  to select RANGE 1 or RANGE 2.
 - Press  to select RANGE 1 or press  to select RANGE 2.
 - Press  to select the ranges mentioned in the table.
7. Continue through the test points.
8. When you are finished, set the 5500A to 0 (zero) Volt, and to Standby.

Table 4-2. Volts DC Measurement Verification Points

Sensitivity		5500A output, V DC	DC Reading	
Input 1	Input 2		Input 1 [mV or V/div]	Input 2 [A or kA/div]
5 mV/div	5 A/div	15 mV	14.4 to 15.6 ²⁾	14.88 to 15.13 ²⁾
10 mV/div	10 A/div	30 mV	29.3 to 30.7 ²⁾	29.80 to 30.20 ²⁾
20 mV/div	20 A/div	60 mV	59.2 to 60.8	59.65 to 60.35
50 mV/div	50 mV/div	150 mV	148.7 to 151.3	148.7 to 151.3
100 mV/div	100 A/div	300 mV	298.0 to 302.0	298.0 to 302.0
200 mV/div	200 A/div	500 mV	497.0 to 503.0	497.0 to 503.0
		-500 mV	-497.0 to -503.0	-497.0 to -503.0
		0 mV	-0.5 to + 0.5	-0.5 to + 0.5
500 mV/div	500 A/div	1.5V	1.487 to 1.513	1.487 to 1.513
1 V/div	1 kA/div	3V	2.980 to 3.020	2.980 to 3.020
2 V/div	2 kA/div	5V	4.970 to 5.030	4.970 to 5.030
		-5V	-4.970 to -5.030	-4.970 to -5.030
		0V	-0.005 to +0.005	-0.005 to +0.005
5 V/div	5 kA/div	15V	14.87 to 15.13	14.87 to 15.13
10 V/div	10 kA/div	30V	29.80 to 30.20	29.80 to 30.20
20 V/div	20 kA/div	50V	49.70 to 50.30	49.70 to 50.30
		-50V	-49.70 to -50.30	-49.70 to -50.30
		0V	-0.05 to + 0.05	-0.05 to +0.05
50 V/div	50 kA/div	150V	148.7 to 151.3	148.7 to 151.3
100 V/div	100 kA/div	300V	298.0 to 302.0	298.0 to 302.0

¹⁾ The 500V and 1250V range will be tested in Section 4.5.13

²⁾ Due to calibrator noise, occasionally OL (overload) can be shown.

4.5.9 Input 1 and 2 AC Voltage Accuracy Test

Warning

Dangerous voltages will be present on the calibration source and connecting cables during the following steps. Ensure that the calibrator is in standby mode before making any connection between the calibrator and the test tool.

Proceed as follows to test the Input 1 and 2 AC Voltage accuracy:

1. Connect the test tool to the 5500A as for the previous test (see Figure 4-5).



























2. Select the AUTO test tool setup:
 - Press  to select the MENU.
 - Press  till SCOPE is highlighted.
 - Press  to select SCOPE mode
3. Select DC coupling & reading for Input 1 and 2.
 - Press  to select menu SCOPE SETUP.
 - Press  to select Input 1 READING.
 - Press  to highlight ACrms.
 - Press  to confirm; mark changes to .
 - Press  to highlight Input 1 Coupling.
 - Press  to select the Input 1 Coupling menu.
 - Press  to highlight AC Coupling.
 - Press  to confirm; mark changes to .
 - Press  to select Input 2 READING.
 - Press  to select the Input 2 READING
 - Press  to highlight ACrms.
 - Press  to confirm; mark changes to .
 - Press  to highlight Input 2 Coupling.
 - Press  to select the Input 2 COUPLING.
 - Press  to highlight AC Coupling.
 - Press  to confirm; mark changes to .
 - Press  to return to SCOPE.
4. Select the appropriate sensitivity for the test tool:
 - Press  to select RANGE 1 or RANGE 2.
 - Press  to select RANGE 1 or press  to select RANGE 2.
 - Press  to select the ranges mentioned in the table.
5. Select the appropriate timebase setting for the test tool
 - Press  when RANGE, RANGE 1, or RANGE 2 is not highlighted.
 - Press  to select
6. Set the 5500A to source the appropriate AC voltage.
7. Observe the Input 1 and Input 2 main reading and check to see if it is within the range shown under the appropriate column.
8. Continue through the test points.
9. When you are finished, set the 5500A to Standby.

















Table 4-3. Volts AC Measurement Verification Points

Sensitivity		Time base	5500A output Volts rms	5500A Frequency	Reading 1 & 2	
Input 1	Input 2				Input 1	Input 2
200 mV/div	200A/div	10 ms/d	500 mV	60 Hz	494.0 to 506.0	494.0 to 506.0
		20 μ /d	500 mV	20 kHz	486.0 to 514.0	
2V/div	2kA/div	20 μ /d	5V	20 kHz	4.860 to 5.140	
		10 ms/d	5V	60 Hz	4.940 to 5.060	4.940 to 5.060
20V/div	20kA/div	10 ms/d	50V	60 Hz	49.40 to 50.60	49.40 to 50.60
		20 μ /d	50V	20 kHz	48.60 to 51.40	

¹⁾ The 500V and 1250V range will be tested in Section 4.5.14

4.5.10 Input 1 and 2 AC Input Coupling Test

Proceed as follows to test the Input 1 and 2 AC coupled input lower transition point:

1. Connect the test tool to the 5500A as for the previous test (see Figure 4-5).
2. Select the AUTO test tool setup:
 - Press  to select the MENU.
 - Press  till SCOPE is highlighted.
 - Press  to select SCOPE mode
3. Select AC coupling & reading for Input 1 and 2.
 - Press  to select menu SCOPE SETUP.
 - Press  to select Input 1 READING.
 - Press  to highlight ACrms.
 - Press  to confirm; mark changes to .
 - Press  to highlight Input 1 Coupling.
 - Press  to select the Input 1 Coupling menu.
 - Press  to highlight AC Coupling.
 - Press  to confirm; mark changes to .
 - Press  select Input 2 READING.
 - Press  to select the Input 2 READING
 - Press  to highlight ACrms.
 - Press  to confirm; mark changes to .
 - Press  to highlight Input 2 Coupling.





- Press  to select the Input 2 COUPLING.
 - Press  to highlight AC Coupling.
 - Press  to confirm; mark changes to .
 - Press  to return to SCOPE.
4. Set the 5500A to source an AC voltage, to the first test point in Table 4-4 (NORMAL output, WAVE sine).
 5. Observe the Input 1 and Input 2 main reading and check to see if it is within the range shown under the appropriate column.
 6. Continue through the test points.
 7. When you are finished, set the 5500A to Standby.

Table 4-4. Input 1 and 2 AC Input Coupling Verification Points









5500A output, V rms	5500A Frequency	Reading 1	Reading 2
500.0 mV	10 Hz	> 344.0	> 344.0
500.0 mV	33 Hz	> 469.0	> 469.0
500.0 mV	60 Hz	> 486.5	> 486.0

4.5.11 Input 1 and 2 Volts Peak Measurements Test

WARNING

Dangerous voltages will be present on the calibration source and connecting cables during the following steps. Ensure that the calibrator is in standby mode before making any connection between the calibrator and the test tool.

Proceed as follows to test the Volts Peak measurement function:

1. Connect the test tool to the 5500A as for the previous test (see Figure 4-5).
2. Select the AUTO test tool setup:
 - Press  to select the MENU.
 - Press  till SCOPE is highlighted.
 - Press  to select SCOPE mode
3. Select DC coupling & Peak m/m reading for Input 1 and 2.
 - Press  to select menu SCOPE SETUP.
 - Press  to select Input 1 READING.
 - Press  to highlight Peak m/m.
 - Press  to confirm; mark changes to .
 - Press  to highlight Input 1 Coupling.
 - Press  to select the Input 1 Coupling menu.



















- Press  to highlight DC Coupling.
 - Press  to confirm; mark changes to .
 - Press  select Input 2 READING.
 - Press  to select the Input 2 READING.
 - Press  to highlight Peak m/m.
 - Press  to confirm; mark changes to .
 - Press  to highlight Input 2 Coupling.
 - Press  to select the Input 2 COUPLING.
 - Press  to highlight DC Coupling.
 - Press  to confirm; mark changes to .
 - Press  to return to SCOPE.
4. Set the 5500A to source a sine wave, to the first test point in Table 4-5 (NORMAL output, WAVE sine).
 5. Observe the Input 1 and Input 2 main reading and check to see if it is within the range shown under the appropriate column.
 6. Continue through the test points of table 4-5.
 7. When you are finished, set the 5500A to Standby.

Table 4-5. Volts Peak Measurement Verification Points

5500A output, Vrms (sine)	5500A Frequency	Reading 1	Reading 2
1.768 (5V peak)	1 kHz	4.50 to 5.50	4.50 to 5.50

4.5.12 Input 1 and 2 Phase Measurements Test

Proceed as follows:

1. Connect the test tool to the 5500A as for the previous test (see Figure 4-5).
2. Select the AUTO test tool setup:
 - Press  to select the MENU.
 - Press  till SCOPE is highlighted.
 - Press  to select SCOPE mode
3. Select DC coupling for Input 1 and 2; Reading Phase for Input 2:
 - Press  to select menu SCOPE SETUP.
 - Press  to highlight Input 1 Coupling.
 - Press  to select the Input 1 Coupling menu.
 - Press  to highlight DC Coupling.
 - Press  to confirm; mark changes to .









- Press  to select Input 2 READING.
 - Press  to select the Input 2 READING.
 - Press  to highlight Phase.
 - Press  to confirm; mark changes to .
 - Press  to highlight Input 2 Coupling.
 - Press  to select the Input 2 COUPLING.
 - Press  to highlight DC Coupling.
 - Press  to confirm; mark changes to .
 - Press  to return to SCOPE.
4. Set the 5500A to source a sine wave, to the first test point in Table 4-6 (NORMAL output, WAVE sine).
 5. Observe the Input 1 and Input 2 main reading and check to see if it is within the range shown under the appropriate column.
 6. When you are finished, set the 5500A to Standby.

Table 4-6. Phase Measurement Verification Points

5500A output, Vrms (sine)	5500A Frequency	Reading 1 & 2
1.5V	400 Hz	-2 to +2 Deg

4.5.13 Input 1 and 2 High Voltage AC & DC Accuracy Test

Warning

Dangerous voltages will be present on the calibration source and connecting cables during the following steps. Ensure that the calibrator is in standby mode before making any connection between the calibrator and the test tool.

Proceed as follows to test the Input 1 & 2 High Voltage DC Accuracy:



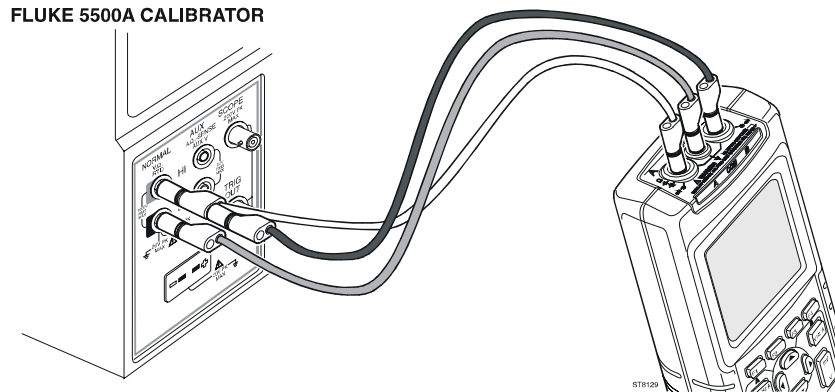





















1. Connect the test tool to the 5500A as shown in Figure 4-6.



ST8129.WMF

Figure 4-6. Test Tool Input 1-B to 5500A Normal Output for >300V

2. Select the AUTO test tool setup:
 - Press **MENU** to select the MENU.
 - Press **↕** till SCOPE is highlighted.
 - Press **ENTER** to select SCOPE mode
3. Select DC coupling & reading for Input 1 and 2.
 - Press **F1** to select menu SCOPE SETUP.
 - Press **ENTER** to select Input 1 READING.
 - Press **↕** to highlight DC.
 - Press **ENTER** to confirm; mark changes to .
 - Press **↕** to highlight Input 1 Coupling.
 - Press **ENTER** to select the Input 1 Coupling menu.
 - Press **↕** to highlight DC Coupling.
 - Press **ENTER** to confirm; mark changes to .
 - Press **↕** to select Input 2 READING.
 - Press **ENTER** to select the Input 2 READING
 - Press **↕** to highlight DC.
 - Press **ENTER** to confirm; mark changes to .
 - Press **↕** to highlight Input 2 Coupling.
 - Press **ENTER** to select the Input 2 COUPLING.
 - Press **↕** to highlight DC Coupling.
 - Press **ENTER** to confirm; mark changes to .
 - Press **F1** to return to SCOPE.
4. Select the appropriate sensitivity for the test tool:

- Press  to select RANGE 1 or RANGE 2.
 - Press  to select RANGE 1 or
 - Press  to select RANGE 2.
 - Press  to select the ranges mentioned in the table.
5. Set the 5500A to source the appropriate DC voltage (NORMAL output, WAVE sine).
 6. Observe the Input 1 and 2 main reading (V DC) and check to see if it is within the range shown under the appropriate column.
 7. Continue through the test points of table 4-7.
 8. Select DC coupling and ACrms reading for Input 1 and 2.
 - Press  to select menu SCOPE SETUP.
 - Press  to select Input 1 READING.
 - Press  to highlight ACrms.
 - Press  to confirm; mark changes to .
 - Press  to highlight Input 1 Coupling.
 - Press  to select the Input 1 Coupling menu.
 - Press  to highlight DC Coupling.
 - Press  to confirm; mark changes to .
 - Press  to select Input 2 READING.
 - Press  to select the Input 2 READING
 - Press  to highlight ACrms.
 - Press  to confirm; mark changes to .
 - Press  to highlight Input 2 Coupling.
 - Press  to select the Input 2 COUPLING.
 - Press  to highlight DC Coupling.
 - Press  to confirm; mark changes to .
 - Press  to return to SCOPE.
 9. Select the appropriate sensitivity for the test tool:
 - Press  to select RANGE 1 or RANGE 2.
 - Press  to select RANGE 1 or
 - Press  to select RANGE 2.
 - Press  to select the ranges mentioned in the second part of table 4-7.
 10. Set the 5500A to source the appropriate AC voltage (NORMAL output, WAVE sine).

11. Observe the Input 1 and 2 main reading (AC) and check to see if it is within the range shown under the appropriate column.
12. Continue through the test points of table 4-7.
13. When you are finished, set the 5500A to Standby

Table 4-7. V DC and V AC High Voltage Verification Tests

Sensitivity		Time/ div.	5500A output Vrms	5500A Frequency	Reading (DC)	Reading (AC)	
Input 1	Input 2					Input 1 & 2	Input 1
200V/d	200kA/d	10 ms/d	0V	DC	-0.5 to +0.5		
		10 ms/d	+500V	DC	+497.0 to +503.0		
		10 ms/d	-500V	DC	-497.0 to -503.0		
500V/d	500kA/d	10 ms/d	+600V	DC	+0.592 to +0.608		
		10 ms/d	-600V	DC	-0.592 to -0.608		
		10 ms/d	0V	DC	-0.005 to +0.005		
Continue at test point 8							
500V/d	500kA/d	50 μs/d	600V	10 kHz		0.570 to 0.630	
		10 ms/d	600V	60Hz		0.584 to 0.616	0.584 to 0.616
200V/d	200kA/d	10 ms/d	500V	60Hz		494.0 to 506.0	494.0 to 506.0
		50 μs/d	500V	10 kHz		486.0 to 514.0	

4.6 Ohms/Continuity/Capacitance.

4.6.1 Resistance Measurements Test.

Proceed as follows:

1. Connect the test tool to the 5500A as shown in Figure 4-7.

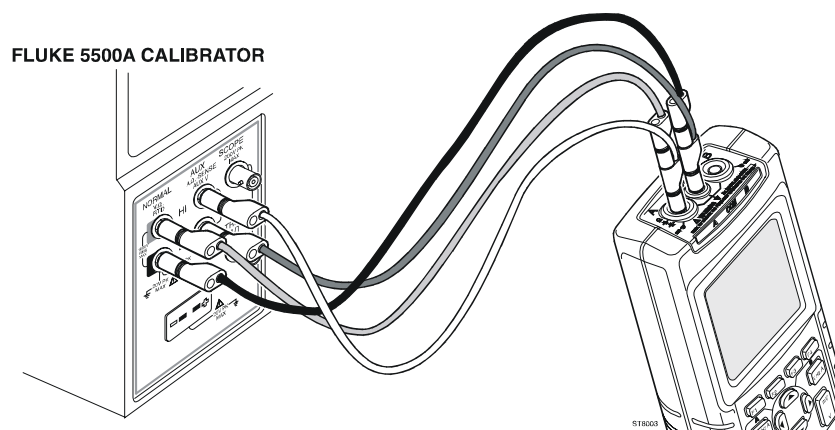

Figure 4-7. Test Tool Input 1 to 5500A Normal Output 4-Wire







2. Select OHMS/CONTINUITY/CAPACITANCE:
 - Press  to select the main MENU.
 - Press  to highlight OHMS/CONTINUITY/CAPACITANCE.
 - Press  to select the item.
3. Set the 5500A to the first test point in Table 4-8.
Use the 5500A “COMP 2 wire” mode for the verifications up to and including 50 k Ω .
For the higher values, the 5500A will turn off the “COMP 2 wire” mode.
4. Observe the Input 1 main reading and check to see if it is within the range shown under the appropriate column.
5. Continue through the test points.
6. When you are finished, set the 5500A to Standby.

Table 4-8. Resistance Measurement Verification Points

5500A output	Reading
0 Ω	000.0 to 000.5
400 Ω	397.1 to 402.9
4 k Ω	3.971 to 4.029
40 k Ω	39.71 to 40.29
400 k Ω	397.1 to 402.9
4 M Ω	3.971 to 4.029
30 M Ω	29.77 to 30.23





4.6.2 Diode Test Function Test

Proceed as follows to test the Diode Test function :

1. Connect the test tool to the 5500A as for the previous test (see Figure 4-7).
2. Select OHMS/CONTINUITY/CAPACITANCE:
 - Press  to select the main MENU.
 - Press  to highlight OHMS/CONTINUITY/CAPACITANCE.
 - Press  to select the item.
 - Press  to select DIODE.
3. Set the 5500A to **1 k Ω** . Use the 5500A “COMP 2 wire” mode.
4. Observe the main reading and check to see if it is within 0.425 and 0.575V.
5. Set the 5500A to **1V DC**.
6. Observe the main reading and check to see if it is within 0.975 and 1.025V.
7. When you are finished, set the 5500A to Standby.

4.6.3 Continuity Function Test

Proceed as follows:

1. Connect the test tool to the 5500A as for the previous test (see Figure 4-7).
2. Select OHMS/CONTINUITY/CAPACITANCE:
 - Press  to select the main MENU.
 - Press  to highlight OHMS/CONTINUITY/CAPACITANCE.
 - Press  to select the item.
 - Press  to select CONTINUITY.
3. Set the 5500A to 25Ω. Use the 5500A “COMP 2 wire” mode.
4. Listen to hear that the beeper sounds continuously.
5. Set the 5500A to 35Ω.
6. Listen to hear that the beeper does not sound.
7. When you are finished, set the 5500A to Standby.

4.6.4 Capacitance Measurements Test

Proceed as follows:





1. Connect the test tool to the 5500A as for the previous test (see Figure 4-7). Ensure that the 5500A is in Standby.
2. Select OHMS/CONTINUITY/CAPACITANCE:
 - Press  to select the main MENU.
 - Press  to highlight OHMS/CONTINUITY/CAPACITANCE.
 - Press  to select the item.
 - Press  to select CAPACITANCE
3. Set the 5500A to the first test point in Table 4-9. Use the 5500A “COMP OFF” mode.
4. Observe the Input 1 main reading and check to see if it is within the range shown under the appropriate column.
5. Continue through the test points.
6. When you are finished, set the 5500A to Standby.
7. Remove all test leads from the test tool to check the zero point.
8. Observe the Input 1 reading and check to see if it is between 00.00 and 00.10 nF.
9. When you are finished, set the 5500A to Standby.

Table 4-9. Capacitance Measurement Verification Points

5500A output	Reading
40 nF	39.10 to 40.90
300 nF	293.0 to 307.0
3 μF	2.930 to 3.070
30 μF	29.30 to 30.70
300 μF	293.0 to 307.0
0 (remove test tool input connections)	0.00 to 0.10 (see steps 7...10)

4.7 Inrush Current.

Proceed as follows to test the INRUSH CURRENT.

1. Connect the test tool to the 5500A as shown in Figure 4.8.

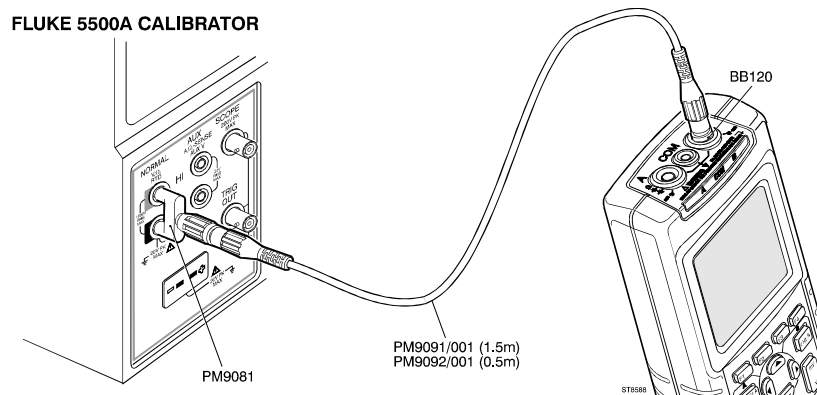

Figure 4-8. Test Tool Input 2 to 5500A NORMAL output

ST8588.wmf

2. Press .
3. Press to highlight INRUSH CURRENT.
4. Press to enter mode.

Now the MAXIMUM CURRENT is highlighted. If the CURRENT IS NOT 1000A then:

1. Press .
2. Press to highlight 1000A.
3. Press to confirm; mark changes to .
4. Set the 5500A to 0V (NORMAL output).
5. Press to highlight INRUSH TIME.
6. Press to select.
7. Press to highlight 10 seconds.

8. Press **ENTER** to confirm; mark changes to .
9. Press **↕** to highlight START.
10. Press **ENTER** to start the measurement.
11. Set the 5500A to 1.5V DC.

Now the measurement should start and continue for 10s. The trigger point is after 2 divisions. With **↔** you can move a cursor and with **F1** you can toggle between the cursors.

Checking the result:

1. Press **↔** to move the left cursor to the fourth division.
2. Press **F1** to toggle to the right cursor.
3. Press **↔** to move the right cursor to the fifth division.
4. Observe the readings and verify that they are between 1.38 and 1.62 kA.
5. When you are finished, set the 5500A to Standby

4.8 Sags & Swells

Proceed as follows to test the sags & swells mode.

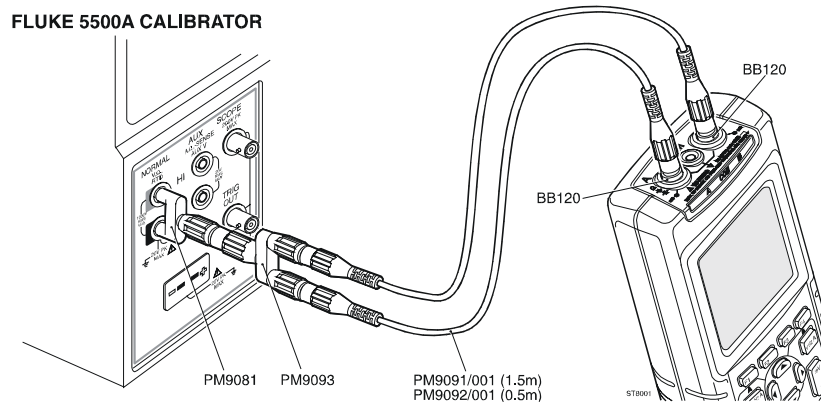





Figure 4-9. Test Tool Input 1 & 2 5500A Normal Output

1. Connect the test tool to the 5500A as shown in Figure 4.9.
2. Press **MENU**.
3. Press **↕** to highlight SAGS & SWELLS.
4. Press **ENTER** to enter mode.





Now the RECORD TIME is highlighted. If the time is not 4 minutes then:

1. Press **ENTER**
2. Press **↕** to highlight 4 minutes.
3. Press **ENTER** to confirm; mark changes to .

4. Set the 5500A to source a sine wave of 5V, 60Hz (NORMAL output, MODE wave sine).
5. Press  to highlight START.
6. Press .
7. After approximately 30 seconds press .
8. Press  and move the cursor into the measured region.
9. Check the readings MAX, V_{rms} , MIN. of Input 1 is between 4.80 and 5.20.
10. Check the readings MAX, A_{rms} , MIN. of Input 2 is 4.80 and 5.20.
11. When you are finished, set the 5500A to Standby

4.9 Harmonics.

Proceed as follows to test HARMONICS:

1. Connect the test tool to the 5500A as for the previous test shown in Figure 4-9.
2. Press .
3. Press  to highlight HARMONICS.
4. Press .
5. Set the 5500A to source a square wave 2.5V, 60Hz (NORMAL output, WAVE square).
6. Check the bargraphs of VOLTS look like the ones in Figure 4-10.
7. Press  to enter the AMPS mode.
8. Check the bar graph look like the one in Figure 4-11.
9. When you are finished, set the 5500A to Standby

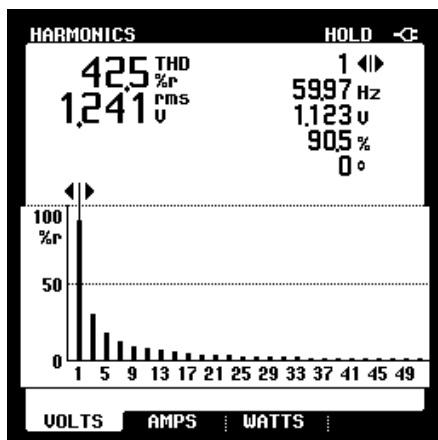

Figure 4-10. Bargraph Harmonics Volt

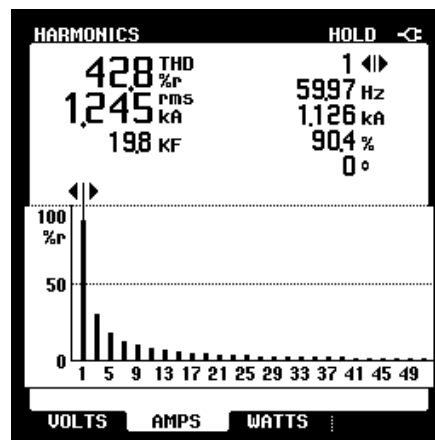

Figure 4-11. Bargraph Harmonics Ampere

4.10 VOLT/AMPS/HERTZ.

Proceed as follows to test VOLT/AMPS/HERTZ:



1. Connect the test tool to the 5500A as for the previous test shown in Figure 4-9.
2. Press 
3. Press  to highlight VOLT/AMPS/HERTZ.
4. Press  to select VOLT/AMPS/HERTZ.
5. Set the 5500A to source the AC voltages in the table (NORMAL output, Wave sine) and check the readings.
6. When you are finished, set the 5500A to Standby.

Table 4-10. Volts/AMPS/HERTZ verification points

5500A output	5500A Freq.	Reading1		Reading 2
		Volt	Hertz	Kilo-Amperes
0		± 10 counts		± 10 counts
5.5V	70Hz	5.34 - 5.66	69.4 - 70.6	5.34 - 5.66
4.5V	70Hz		69.4 - 70.6	4.445 - 4.555

4.11 POWER.

Proceed as follows to test POWER:



1. Connect the test tool to the 5500A as for the previous test shown in Figure 4-9.
2. Press 
3. Press  to highlight POWER.
4. Press  to select POWER.
5. Set the 5500A to source the AC voltages in the table (NORMAL output, Wave sine) and check the readings.
6. When you are finished set the 5500A to Standby.

Table 4-11. Power Measurement Verification points

5500A output		Reading					
Input 1	Input 2	kW	kVA	kVAR	PF	DPF	Hz
0	0	± 4 counts	± 4 counts	± 4 counts			
4.472V/60Hz	4.472/60Hz	19.4-20.6	19.4-20.6	± 4 counts	0.96-1.00	0.97-1.00	59.5-60.5
5.916V/60Hz	5.916V/60Hz	34.3-35.7	34.3-35.7	± 4 counts	0.96-1.00	0.97-1.00	59.5-60.5

4.12 Transients.

Proceed as follows to test the TRANSIENTS function:

1. Connect the test tool to the 5500A as show in Figure 4-12.

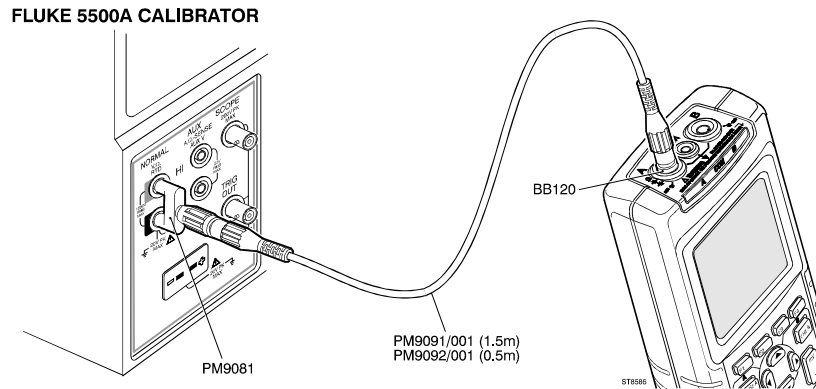

Figure 4-12. Test Tool Input 1 to 5500A Normal Output

2. Press **MENU**.
3. Press **↑** to highlight TRANSIENTS.
4. Press **ENTER** to select the TRANSIENTS mode.

VOLTAGE CHANGE will be highlighted, continue with:

1. Press **ENTER**.
2. Press **↓** to select 20%.
3. Press **ENTER** to confirm; mark changes to .
4. Press **↓** to select START.
5. Set the 5500A to 20V, 60Hz (NORMAL output, WAVE sine).
6. Press **ENTER** to start the test. **No** transients should be captured.
7. Set the 5500A to 22.5V.
8. Now transients should be captured. After 40 transients (maximum) the 40th transient will be visible.
9. When you are finished, set the 5500A to Standby.

Chapter 5

Calibration Adjustment

Title	Page
5.1 General	5-3
5.1.1 Introduction.....	5-3
5.1.2 Calibration number and date.....	5-3
5.1.3 General Instructions.....	5-4
5.2 Equipment Required For Calibration.....	5-4
5.3 Starting Calibration Adjustment	5-4
5.4 Contrast Calibration Adjustment	5-6
5.5 Warming Up & Pre-Calibration	5-7
5.6 Final Calibration	5-7
5.6.1 HF Gain Input 1	5-8
5.6.2 Delta T Gain, Trigger Delay Time & Pulse Adjust Input 1.....	5-9
5.6.3 Gain DMM (Gain Volt).....	5-10
5.6.4 Volt Zero.....	5-12
5.6.5 Gain Ohm.....	5-12
5.6.6 Capacitance Gain Low and High.....	5-13
5.6.7 Capacitance Clamp & Zero.....	5-14
5.6.8 Capacitance Gain	5-14
5.7 Save Calibration Data and Exit.....	5-15

5.1 General

5.1.1 Introduction

The following information, provides the complete Calibration Adjustment procedure for the Fluke 43B test tool. The test tool allows closed-case calibration using known reference sources. It measures the reference signals, calculates the correction factors, and stores the correction factors in RAM. After completing the calibration, the correction factors can be stored in FlashROM.

The test tool should be calibrated after repair, or if it fails the performance test. The test tool has a normal calibration cycle of one year.

5.1.2 Calibration number and date

When storing valid calibration data in FlashROM after performing the calibration adjustment procedure, the calibration date is set to the actual test tool date, and calibration number is raised by one. To display the calibration date and - number:









1. Press  to switch on the Fluke 43B.
2. Press  to leave the startup screen.
3. Press  to go to the MENU screen.
4. Press  to highlight INSTRUMENT SETUP item.
5. Press  to open the INSTRUMENT SETUP menu.
6. Press  to highlight VERSION & CALIBRATION
7. Press  to open the VERSION & CALIBRATION menu.
8. Press  to return to the INSTRUMENT SETUP menu.



Figure 5-1. Version & Calibration Screen

VERSION.BMP

5.1.3 General Instructions

Follow these general instructions for all-calibration steps:

- Allow the 5500A to satisfy its specified warm-up period. For each calibration point , wait for the 5500A to settle.
- The required warm up period for the test tool is included in the WarmingUp & PreCal calibration step.
- Ensure that the test tool battery is charged sufficiently.

5.2 Equipment Required For Calibration

The primary source instrument used in the calibration procedures is the Fluke 5500A. If a 5500A is not available, you can substitute another calibrator as long as it meets the minimum test requirements.

- Fluke 5500A Multi Product Calibrator, including 5500A-SC Oscilloscope Calibration Option.
- Stackable Test Leads (4x), supplied with the 5500A.
- 50Ω Coax Cables (2x), Fluke PM9091 or PM9092.
- 50Ω feed through termination (2x), Fluke PM9585.
- Fluke BB120 Shielded Banana to Female BNC adapters (2x), supplied with the Fluke 43B.
- Dual Banana Plug to Female BNC Adapter (1x), Fluke PM9081/001.
- Male BNC to Dual Female BNC Adapter (1x), Fluke PM9093/001.











5.3 Starting Calibration Adjustment

Follow the steps below to start calibration adjustments.

1. Power the test tool via the power adapter input, using the PM8907 power adapter.
2. Check the actual test tool date, and adjust the date if necessary:

- Press  to switch on the Fluke 43B.



If the date on the startup screen is correct then continue at step 3.

- Press  to leave the STARTUP screen.
- Press  to go to MENU.
- Press  to highlight INSTRUMENT SETUP item.
- Press  to open the INSTRUMENT SETUP menu.
- Press  to highlight DATE
- Press  to open the DATE menu.
- Adjust the date with  and  if necessary.
- When ready, press .
- Press  to exit the INSTRUMENT SETUP menu.

3. Select the Maintenance mode.

The Calibration Adjustment Procedure uses built-in calibration setups, that can be accessed in the Maintenance mode.

To enter the Maintenance mode proceed as follows:

- Press and hold .
- Press and release .
- Release .
- The display shows the Calibration Adjustment Screen.

The display shows the first calibration step **Warming Up (CL 0200)** , and the calibration status :**IDLE (valid)** or :**IDLE (invalid)**.

4. Continue with either a. or b. below:
 - a. To calibrate the display contrast adjustment range and the default contrast, go to Section 5.4 Contrast Calibration Adjustment.
This calibration step is only required if the display cannot made dark or light enough, or if the display after a test tool reset is too light or too dark
 - b. To calibrate the test tool without calibrating the contrast, go to Section 5.5 Warming Up & Pre-calibration

Explanation of screen messages and key functions.

When the test tool is in the Maintenance Mode, only the F1, F2, F3, and ENTER soft keys, the ON/OFF key, and the backlight key can be operated, unless otherwise stated.





The calibration adjustment screen shows the actual calibration step (name and number) and its status :

Cal Name (CL nnnn) :Status Calibration step nnnn

Status can be:

IDLE (valid)	After (re)entering this step, the calibration process is not started. The calibration data of this step are valid. This means that the last time this step was done, the calibration process was successful. It does not necessarily mean that the unit meets the specifications related to this step!
IDLE (invalid)	After (re)entering this step, the calibration process is not started. The calibration data are invalid. This means that the unit will not meet the specifications if the calibration data are saved.
BUSY aaa% bbb%	Calibration adjustment step in progress; progress % for Input 1 and Input 2.
READY	Calibration adjustment step finished.
Error :xxxx	Calibration adjustment failed, due to wrong input signal(s) or because the test tool is defective. The error codes xxxx are shown for production purposes only.

Functions of the keys F1-ENTER are:

-  **PREV** select the previous step
-  **NEXT** select the next step
-  **CAL** start the calibration adjustment of the actual step
-  **EXIT** leave the Maintenance mode

Readings and traces

After completing a calibration step, readings and traces are shown using the new calibration data.











5.4 Contrast Calibration Adjustment

After entering the Maintenance mode, the test tool display shows

Warming Up (CL 0200):IDLE (valid).

Do not press  now! If you did, turn the test tool off and on, and enter the Maintenance mode again.

Proceed as follows to adjust the maximum display darkness (CL0100), the default contrast (CL0110) , and the maximum display brightness (CL0120).

1. Press  a three times to select the first calibration step. The display shows:
Contrast (CL 0100) :MANUAL
 2. Press  CAL. The display will show a dark test pattern, see Figure 5-2
 3. Using  adjust the display to the maximum darkness, at which the test pattern is only just visible.
 4. Press  to select the default contrast calibration. The display shows:
Contrast (CL 0110) :MANUAL
 5. Press  CAL. The display shows the test pattern at default contrast.
 6. Using  set the display to optimal (becomes default) contrast.
 7. Press  to select maximum brightness calibration. The display shows:
Contrast (CL 0120) :MANUAL
 8. Press  CAL. The display shows a bright test pattern.
 9. Using  adjust the display to the maximum brightness, at which the test pattern is only just visible.
 10. You can now :
 - Exit, if only the Contrast had to be adjusted. Continue at Section 5.7.
- OR
- Do the complete calibration. Press  to select the next step (Warming Up), and continue at Section 5.5.

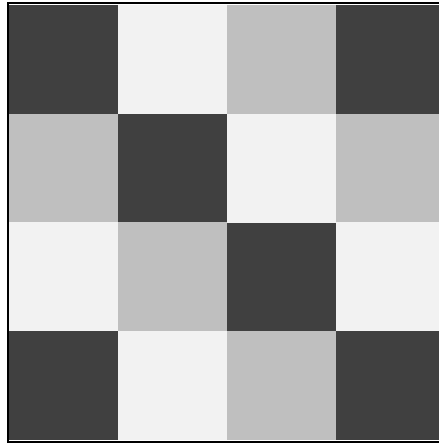

Figure 5-2. Display Test Pattern

5.5 Warming Up & Pre-Calibration

After entering the Warming-Up & Pre-Calibration state, the display shows:

WarmingUp (CL 0200):IDLE (valid) or (invalid).

You must always start the Warming Up & Pre Calibration at **Warming Up (CL0200)** . Starting at another step will make the calibration invalid!

Proceed as follows:

1. Remove all input connections from the test tool.
2. Press  to start the Warming-Up & Pre-Calibration.
The display shows the calibration step in progress, and its status.
The first step is **WarmingUp (CL0200) :BUSY 00:29:59** . The warming-up period is counted down from 00:29:59 to 00:00:00. Then the other pre-calibration steps are performed automatically. The procedure takes about 60 minutes.
3. Wait until the display shows **End Precal :READY**
4. Continue at Section 5.6.

5.6 Final Calibration

You must always start the Final Calibration at the first step of Section 5.6.1. Starting at another step will make the calibration invalid!

If you proceeded to step N (for example step CL 0615), then return to a previous step (for example step CL 0613), and then calibrate this step, the complete final calibration becomes invalid. You must do the final calibration from the beginning (step CL 0600) again.

You can repeat a step that shows the status **:READY** by pressing  again.

5.6.1 HF Gain Input 1.

Proceed as follows to do the HF Gain Input 1&2 calibration:

1. Press **F2** to select the first calibration step in Table 5-1 (**HFG & FI AB (CL 0600):**)
2. Connect the test tool to the 5500A as shown in Figure 5-3. Do NOT use a 50 Ω termination!

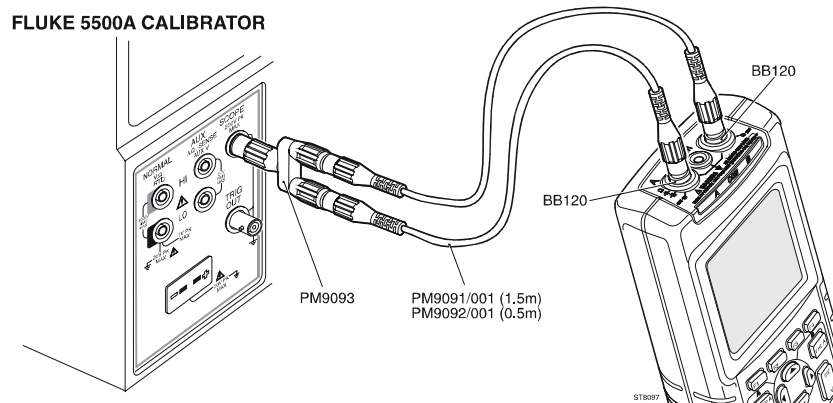

Figure 5-3. HF Gain Calibration Input Connections

ST8097.WMF

3. Set the 5500A to source a 1 kHz fast rising edge square wave (Output SCOPE, MODE edge) to the first calibration point in Table 5-1.
4. Set the 5500A in operate (OPR).
5. Press **F3** to start the calibration.
6. Wait until the display shows calibration status **READY** .
7. Press **F2** to select the next calibration step, set the 5500A to the next calibration point, and start the calibration. Continue through all calibration points in Table 5-1.
8. Set the 5500A to source a 1 kHz square wave (Output SCOPE, MODE wavegen, WAVE square), to the first calibration point in Table 5-2.
9. Press **F2** to select the first step in Table 5-2.
10. Press **F3** to start the calibration.
11. Wait until the display shows calibration status **READY**.
12. Press **F2** to select the next calibration step, set the 5500A to the next calibration point, and start the calibration. Continue through all calibration points Table 5-2.
13. When you are finished, set the 5500A to Standby.
14. Continue at Section 5.6.2.

Table 5-1. HF Gain Calibration Points Fast

Cal step	5500A Setting ¹⁾ (1 kHz, no 50 Ω!)	Test Tool Input Signal Requirements ¹⁾ (1 kHz, $t_{rise} < 100$ ns, flatness after rising edge: <0.5% after 200 ns)
HFG & FI A(B) (CL 0600)	10 mV	20 mV
HFG & FI A(B) (CL 0601)	25 mV	50 mV
HFG & FI A(B) (CL 0602)	50 mV	100 mV
HFG & FI A(B) (CL 0603)	100 mV	200 mV
HFG & FI A(B) (CL 0604)	250 mV	500 mV
HFG & FI A(B) (CL 0605)	500 mV	1 V
HFG & FI A(B) (CL 0606)	1 V	2 V
HFG & FI A(B) (CL 0607) [HFG & FI A (CL 0608)] ²⁾	2.5 V	5 V

¹⁾ As the 5500A output is not terminated with 50Ω, its output voltage is two times its set voltage

²⁾ After starting the first step in this table cell, these steps are done automatically.

Table 5-2. HF Gain Calibration Points Slow

Cal step	5500A Setting (1 kHz, MODE wavegen, WAVE square)	Test Tool Input Signal Requirements (1 kHz square, $t_{rise} < 2$ μs, flatness after rising edge: <0.5% after 4 μs)
HF-Gain A(B) (CL 0609)	25 V	25 V
HF-Gain A (CL 0612), [HF-Gain A (CL 0615)] ¹⁾	50 V	50 V

¹⁾ After starting the first step in this table cell, these steps are done automatically.

5.6.2 Delta T Gain, Trigger Delay Time & Pulse Adjust Input 1

Proceed as follows to do the calibrations:

1. Press  to select calibration step Delta T (CL 0700):IDLE
2. Connect the test tool to the 5500A as shown in Figure 5-4.

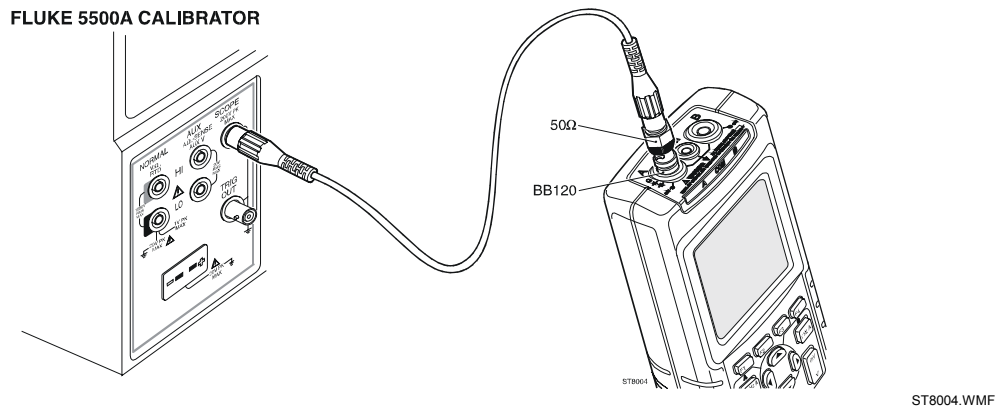

Figure 5-4. 5500A Scope Output to Input 1

3. Set the 5500A to source a 1V, 1 MHz fast rising (rise time ≤ 1 ns) square wave (SCOPE output, MODE edge).
4. Set the 5500A to operate (OPR).
5. Press **F3** to start the calibration.
The Delta T gain, Trigger Delay (CL0720), and Pulse Adjust Input 1 (CL0640) will be calibrated.
6. Wait until the display shows **Pulse Adj A (CL 0640):READY**.
7. When you are finished, set the 5500A to Standby.
8. Continue at Section 5.6.3.

5.6.3 Gain DMM (Gain Volt)

Warning

Dangerous voltages will be present on the calibration source and connection cables during the following steps. Ensure that the calibrator is in standby mode before making any connection between the calibrator and the test tool.

Proceed as follows to do the Gain DMM calibration.

1. Press **F2** to select the first calibration step in Table 5-3.
2. Connect the test tool to the 5500A as shown in Figure 5-5.

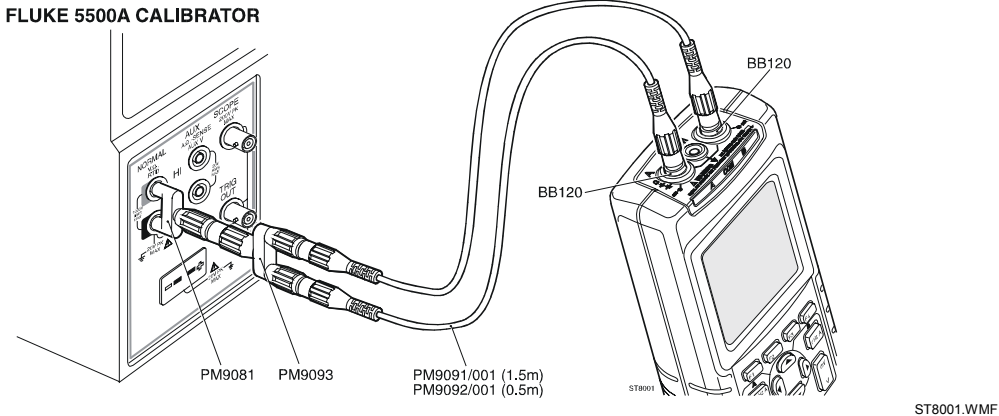

Figure 5-5. Volt Gain Calibration Input Connections <300V

3. Set the 5500A to supply a DC voltage, to the first calibration point in Table 5-3.
4. Set the 5500A to operate (OPR).
5. Press **F3** to start the calibration.
6. Wait until the display shows calibration status **:READY**.
7. Press **F2** to select the next calibration step, set the 5500A to the next calibration point, and start the calibration. Continue through all calibration points of Table 5-3
8. Set the 5500A to Standby, and continue with step 9.

Table 5-3. Volt Gain Calibration Points <300V

Cal step	Input value
Gain DMM (CL0800)	12.5 mV
Gain DMM (CL0801)	25 mV
Gain DMM (CL0802)	50 mV
Gain DMM (CL0803)	125 mV
Gain DMM (CL0804)	250 mV
Gain DMM (CL0805)	500 mV
Gain DMM (CL0806)	1.25V
Gain DMM (CL0807)	2.5V
Gain DMM (CL0808)	5V
Gain DMM (CL0809)	12.5V
Gain DMM (CL0810)	25V
Gain DMM (CL0811)	50V (set 5500A to OPR!)
Gain DMM (CL0812)	125V
Gain DMM (CL0813)	250V

9. Press **F2** to select calibration step **Gain DMM (CL0814) :IDLE**

10. Connect the test tool to the 5500A as shown in Figure 5-6.

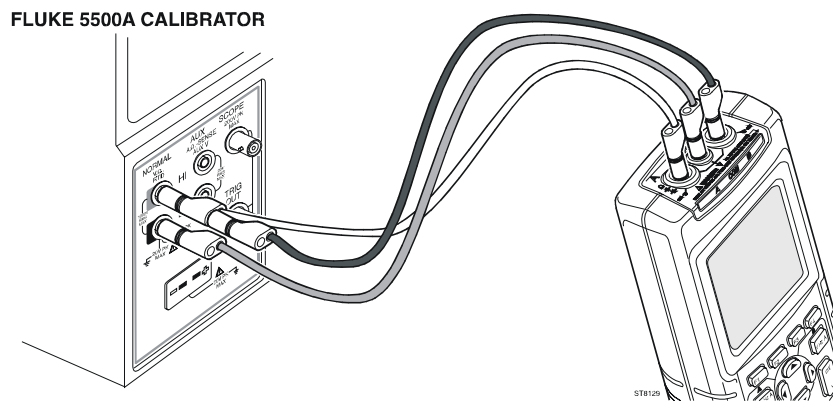

Figure 5-6. Volt Gain Calibration Input Connections 500V

11. Set the 5500A to supply a DC voltage of 500V.
12. Set the 5500A to operate (OPR).
13. Press **F3** to start the calibration.
Gain DMM (CL0814) and Gain DMM (CL0815) will be calibrated now.
14. Wait until the display shows calibration status **Gain DMM (CL0815):READY**.
15. Set the 5500A to 0V (zero) and to Standby.
16. Continue at Section 5.6.4.

5.6.4 Volt Zero

Proceed as follows to do the Volt Zero calibration:

1. Press **F2** to select calibration adjustment step **Volt Zero (CL 0820):IDLE**.
2. Terminate Input 1 and Input 2 with the BB120 and a 50Ω or lower termination.
3. Press **F3** to start the zero calibration of all mV/d settings (CL0820...CL0835)
4. Wait until the display shows **Volt Zero (CL 0835):READY**.
5. Remove the 50Ω termination from the inputs.
6. Continue at Section 5.6.5.

5.6.5 Gain Ohm

Proceed as follows to do the Gain Ohm calibration:

1. Press **F2** to select calibration adjustment step **Gain Ohm (CL 0860):IDLE**
2. Connect the UUT to the 5500A as shown in Figure 5-7.
Notice that the sense leads must be connected directly to the test tool.

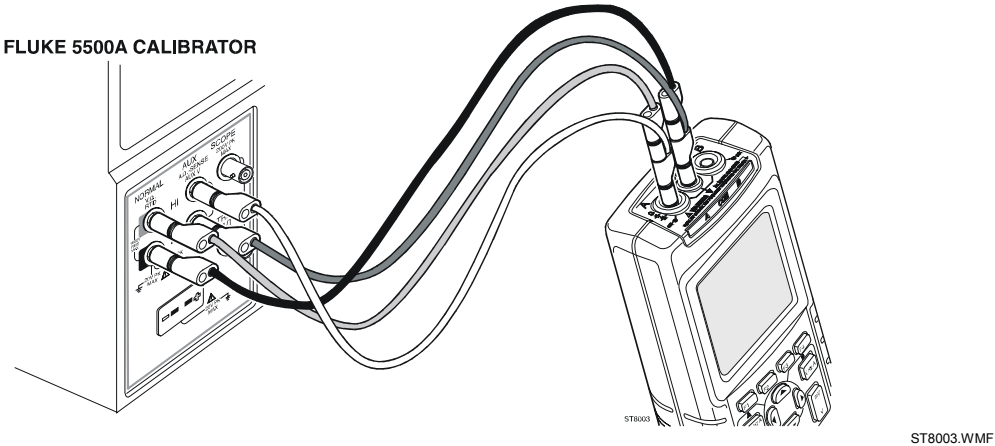

Figure 5-7. Four-wire Ohms calibration connections

3. Set the 5500A to the first test point in Table 5-4. Use the 5500A “COMP 2 wire” mode for the calibration adjustments up to and including 100 kΩ. For the higher values, the 5500A will turn off the “COMP 2 wire” mode.
4. Set the 5500A to operate (OPR).
5. Press **F3** to start the calibration.
6. Wait until the display shows the calibration status :READY.
7. Press **F2** to select the next calibration step, set the 5500A to the next calibration point, and start the calibration. Continue through all calibration points.
8. When you are finished, set the 5500A to Standby.
9. Continue at Section 5.6.6.

Table 5-4. Ohm Gain Calibration Points

Cal Step	Input Value
Gain Ohm (CL 0860) [Cap. Pos. (CL 0920), Cap.Neg. (CL 0921)] ¹⁾	100 Ω
Gain Ohm (CL 0861) [Cap. Pos. (CL 0922), Cap.Neg. (CL 0923)] ¹⁾	1 kΩ
Gain Ohm (CL 0862) [Cap. Pos. (CL 0924), Cap.Neg. (CL 0925)] ¹⁾	10 kΩ
Gain Ohm (CL 0863) [Cap. Pos. (CL 0926), Cap.Neg. (CL 0927)] ¹⁾	100 kΩ
Gain Ohm (CL 0864)	1 MΩ
Gain Ohm (CL 0865) [Gain Ohm (CL 0866)] ²⁾	10 MΩ

¹⁾ The capacitance measurement current calibrations (Cap.Pos. and Cap.Neg) are done automatically after the Gain Ohm calibration.

²⁾ The Gain Ohm (CL0866) calibration step is done automatically after the Gain Ohm (CL0865) calibration.

5.6.6 Capacitance Gain Low and High

Proceed as follows to do the Capacitance Gain calibration:

1. Press **F2** to select calibration adjustment step **Cap. Low (CL 0900):IDLE**
2. Connect the test tool to the 5500A as shown in Figure 5-8.

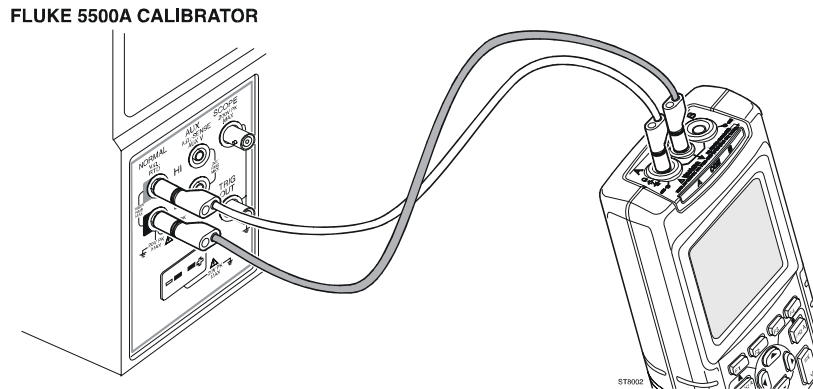

Figure 5-8. Capacitance Gain Calibration Input Connections

ST8002.WMF

3. Set the 5500A to supply 250 mV DC.
4. Set the 5500A to operate (OPR).
5. Press **F3** to start the calibration.
6. Wait until the display shows **Cap. Low (CL 0900):READY**.
7. Press **F2** to select calibration adjustment step **Cap. High (CL 0910):IDLE**.
8. Set the 5500A to supply 50 mV DC.
9. Press **F3** to start the calibration.
10. Wait until the display shows **Cap High (CL 910):READY**.
11. Set the 5500A to Standby.
12. Continue at Section 5.6.7.

5.6.7 Capacitance Clamp & Zero

Proceed as follows to do the Capacitance Clamp Voltage & Zero calibration:

1. Press **F2** to select calibration adjustment step **Cap. Clamp (CL 0940):IDLE**.
2. Remove any input connection from the test tool (open inputs).
3. Press **F3** to start the calibration.
The capacitance measurement clamp voltage **Cap. Clamp (CL 0940)**, and the zero of the capacitance ranges **Cap. Zero (CL 0950)...** **Cap. Zero (CL 0953)** will be calibrated now.
4. Wait until the display shows **Cap. Zero (CL 0953): READY**.
5. Continue at Section 5.6.8.

5.6.8 Capacitance Gain

Proceed as follows to do the Capacitance Gain calibration:

1. Press **F2** to select calibration adjustment step **Cap. Gain (CL 0960):IDLE**.
2. Connect the test tool to the 5500A as shown in Figure 5-8.
3. Set the 5500A to 500 nF.

4. Set the 5500A to operate (OPR).
5. Press **F3** to start the calibration.
6. Wait until the display shows **Cap. Gain (CL 0960):READY**.
7. Continue at Section 5.7 to save the calibration data.

5.7 Save Calibration Data and Exit

Proceed as follows to save the calibration data, and to exit the Maintenance mode:

1. Remove all test leads from the test tool inputs.
2. Press **ENTER** (EXIT). The test tool will display:

**Calibration data are valid
Save data and EXIT maintenance?**

Note

Calibration data valid indicates that the calibration adjustment procedure is performed correctly. It does not indicate that the test tool meets the characteristics listed in Chapter 2.

3. Press **ENTER** (YES) to save and exit.

Notes

The calibration number and date will be updated only if the calibration data have been changed and the data are valid.

The calibration data will change when a calibration adjustment has been done. The data will not change when just entering and then leaving the maintenance mode without doing a calibration adjustment.

The calibration number and date will NOT be updated if only the display contrast has been adjusted.

Possible error messages.

Invalid calibration data:

**WARNING.Calibration data NOT valid.
Save data and EXIT?**

Proceed as follows:

- To return to the Maintenance mode:

Press **F3** NO.

Now press **F1** until the display shows **WarmingUp (CL 0200):IDLE**, and calibrate the test tool, starting at Section 5.5.

- To exit and save the INVALID calibration data:

Press  YES.

The test tool will show the message **The test tool needs calibration. Please contact your service center** at power on. The calibration date and number will not be updated. A complete recalibration must be done.

- To exit and maintain the old calibration data:

Turn the test tool off.

No power adapter voltage

**WARNING.No adapter present.
Calibration data will not be saved.
Exit maintenance mode?**

- To save the calibration data:

Press  NO

The test tool returns to the maintenance mode. Connect a correct power adapter, and press  to exit and save.

- To exit without saving the calibration data:

Press  YES

Chapter 6

Disassembling

Title	Page
6.1. Introduction.....	6-3
6.2. Disassembling Procedures	6-3
6.1.1 Required Tools	6-3
6.2.2 Removing the Battery Pack	6-3
6.2.3 Removing the Bail	6-3
6.2.4 Opening the Test Tool	6-3
6.2.5 Removing the Main PCA Unit.....	6-5
6.2.6 Removing the Display Assembly.....	6-6
6.2.7 Removing the Keypad and Keypad Foil.....	6-6
6.3 Disassembling the Main PCA Unit.....	6-6
6.4 Reassembling the Main PCA Unit	6-8
6.5 Reassembling the Test Tool.....	6-8

6.1. Introduction

This section provides the required disassembling procedures. The printed circuit board removed from the test tool must be adequately protected against damage.

Warning

To avoid electric shock, disconnect test leads, probes and power supply from any live source and from the test tool itself. Always remove the battery pack before completely disassembling the test tool. If repair of the disassembled test tool under voltage is required, it shall be carried out only by qualified personnel using customary precautions against electric shock.

6.2. Disassembling Procedures

6.1.1 Required Tools

To access all the assemblies, you need the following:

- Static-free work surface, and anti-static wrist wrap.
- #8, and #10 Torx screwdrivers.
- Cotton gloves (to avoid contaminating the lens, and the PCA).

6.2.2 Removing the Battery Pack

Referring to Figure 6-1, use the following procedure to remove the battery pack.

1. Loosen the M3 Torx screw (item 15) (do not remove it) from the battery door.
2. Lift the battery door at the screw edge to remove it.
3. Lift out the battery pack, and unplug the cable leading to the Main PCA (pull the cable gently backwards).

6.2.3 Removing the Bail

Referring to Figure 6-1, use the following procedure to remove the bail (item 16).

1. Set the bail to a 45 degree position respective to the test tool bottom.
2. Holding the test tool tight, rotate the bail firmly sideways.

6.2.4 Opening the Test Tool

Referring to Figure 6-1, use the following procedure to open the test tool.

1. Remove the battery pack (see Section 6.2.2)
2. Unscrew the four M3 Torx screws (item 12) that secure the bottom case to the top case.
3. Hold the test tool upside down, and lift off the bottom case.

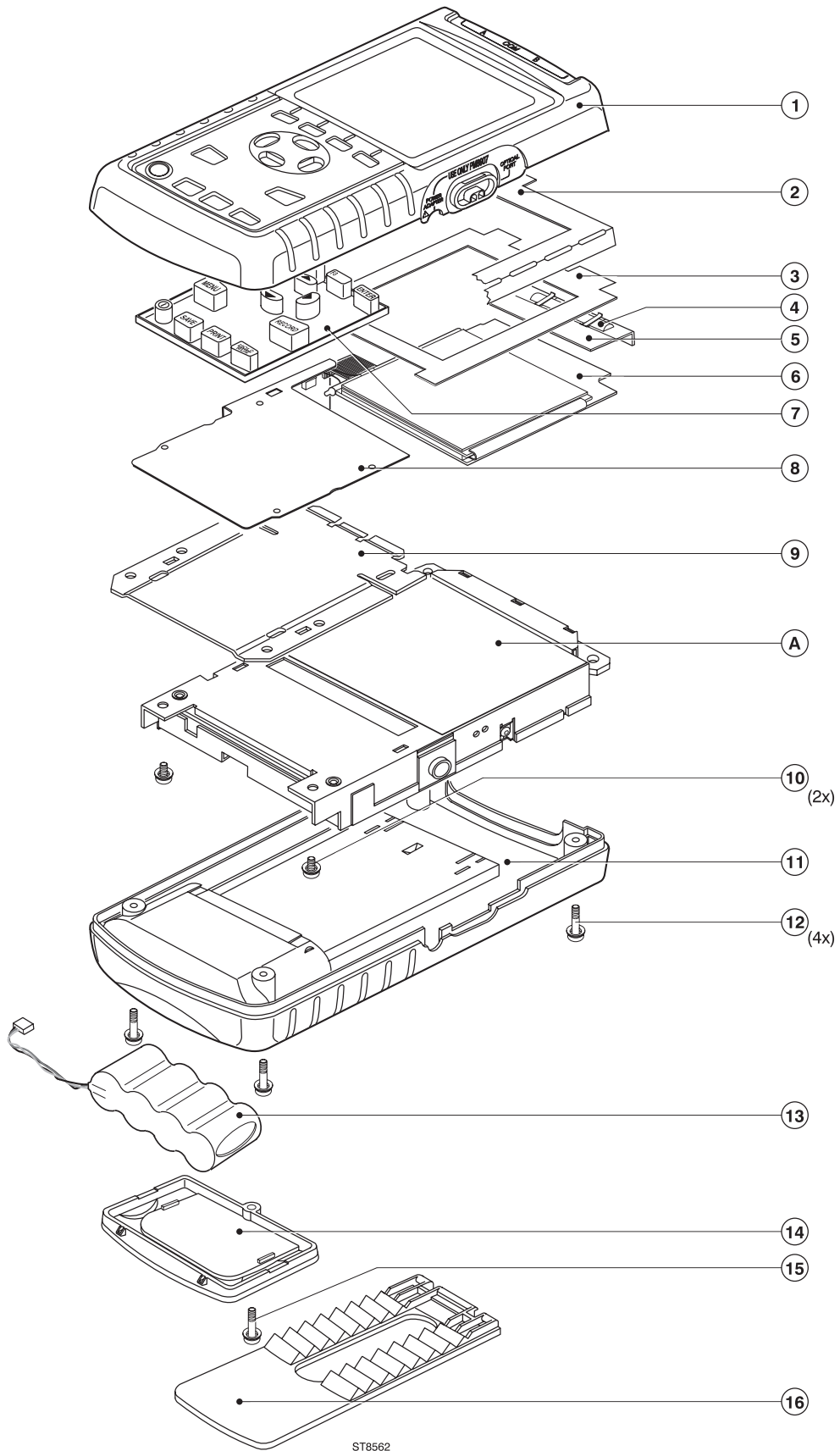

Figure 6-1. Fluke 43B Main Assembly

ST8562.EPS

6.2.5 Removing the Main PCA Unit

Referring to Figure 6-1, use the following procedure to remove the main PCA unit.

1. Open the test tool (see Section 6.2.4).
2. Disconnect the LCD flex cable, and the keypad foil flat cable, see Figure 6-2.
Unlock the cables by lifting the connector latch. The latch remains attached to the connector body.
The keypad foil is provided with a shielding flap that covers the LCD flat cable. The end of the flap is put under the main PCA unit shielding plate, and can be easily pulled out.

Caution

To avoid contaminating the flex cable contacts with oil from your fingers, do not touch the contacts (or wear gloves). Contaminated contacts may not cause immediate instrument failure in controlled environments. Failures typically show up when contaminated units are operated in humid areas.

3. Unplug the backlight cable.

Warning

If the battery pack or the power adapter is connected, the LCD backlight voltage on the wire cable is 400V ! (when the test tool is on).

4. Remove the two screws (item 10) that secure the Main PCA unit to the top case.
5. Lift the screw end of the Main PCA unit and remove the unit by gently wiggling the assembly from side to side as you pull backwards.

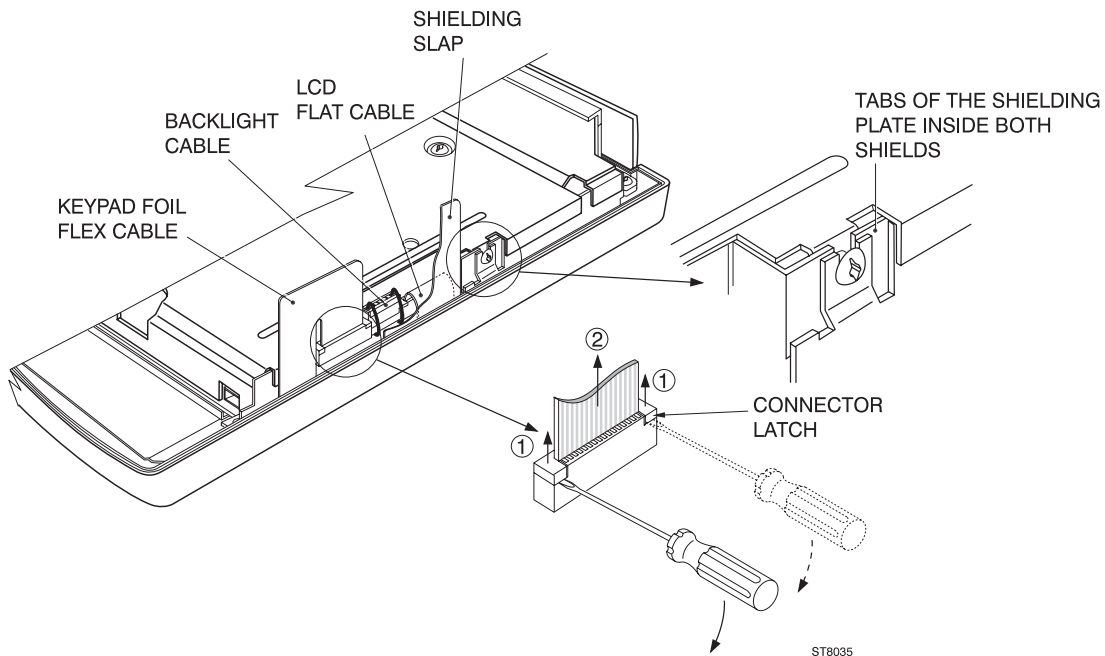

Figure 6-2. Flex Cable Connectors

ST8035.EPS

6.2.6 Removing the Display Assembly

There are no serviceable parts in the display assembly. Referring to Figure 6-1, use the following procedure to remove the display assembly.

1. Remove the main PCA unit (see Section 6.2.5).
2. The keypad pressure plate (item 9) is captivated by four plastic keeper tabs in the top case. Press the plate down, carefully slide the plate to release it from the tabs, and then remove it.
3. Remove the display assembly (item 6). To prevent finger contamination, wear cotton gloves, or handle the display assembly by its edge.

After removing the display assembly, the shielding bracket (item 5) with the conductive foam strip (item 4), the dust seal (item 3), and the shielding foil (item 2) can be removed.

6.2.7 Removing the Keypad and Keypad Foil

Referring to Figure 6-1, use the following procedure to remove the keypad and the keypad foil.

1. Remove the display assembly (see Section 6.2.6).
2. Remove the keypad foil. Notice the four keypad foil positioning pins in the top case.
3. Remove the keypad.

Caution

To avoid contaminating the keypad contacts, and the keypad foil contacts with oil from your fingers, do not touch the contacts (or wear gloves). Contaminated contacts may not cause immediate instrument failure in controlled environments. Failures typically show up when contaminated units are operated in humid areas.

6.3 Disassembling the Main PCA Unit

Referring to Figure 6-3, use the following procedure disassemble the main PCA unit.

1. Remove the M2.5 Torx screws (items 1 and 8) that secure the main shielding plate (item 7) to the main PCA shielding box (item 5).
2. Pull the shielding plate away from the input banana jacks as you rotate the far end upwards, and then remove it.
3. Remove the power input insulator (item 3), and the LED guide piece (item 6).
4. Remove the M2.5 Torx screws (item 2) that secure the PCA to the shielding box.
5. Lift the PCA at the screw end approximately 2 cm, and pull it away from the input banana jack holes to remove it.

Note

Each input banana jacket is provided with a rubber sealing ring (Input 1,2 item 9, COM input item 10). Ensure that the rings are present when reassembling the main PCA unit!

Caution

To avoid contaminating the main PCA with oil from your fingers, do not touch the contacts (or wear gloves). A contaminated PCA may not cause immediate instrument failure in controlled environments. Failures typically show up when contaminated units are operated in humid areas.

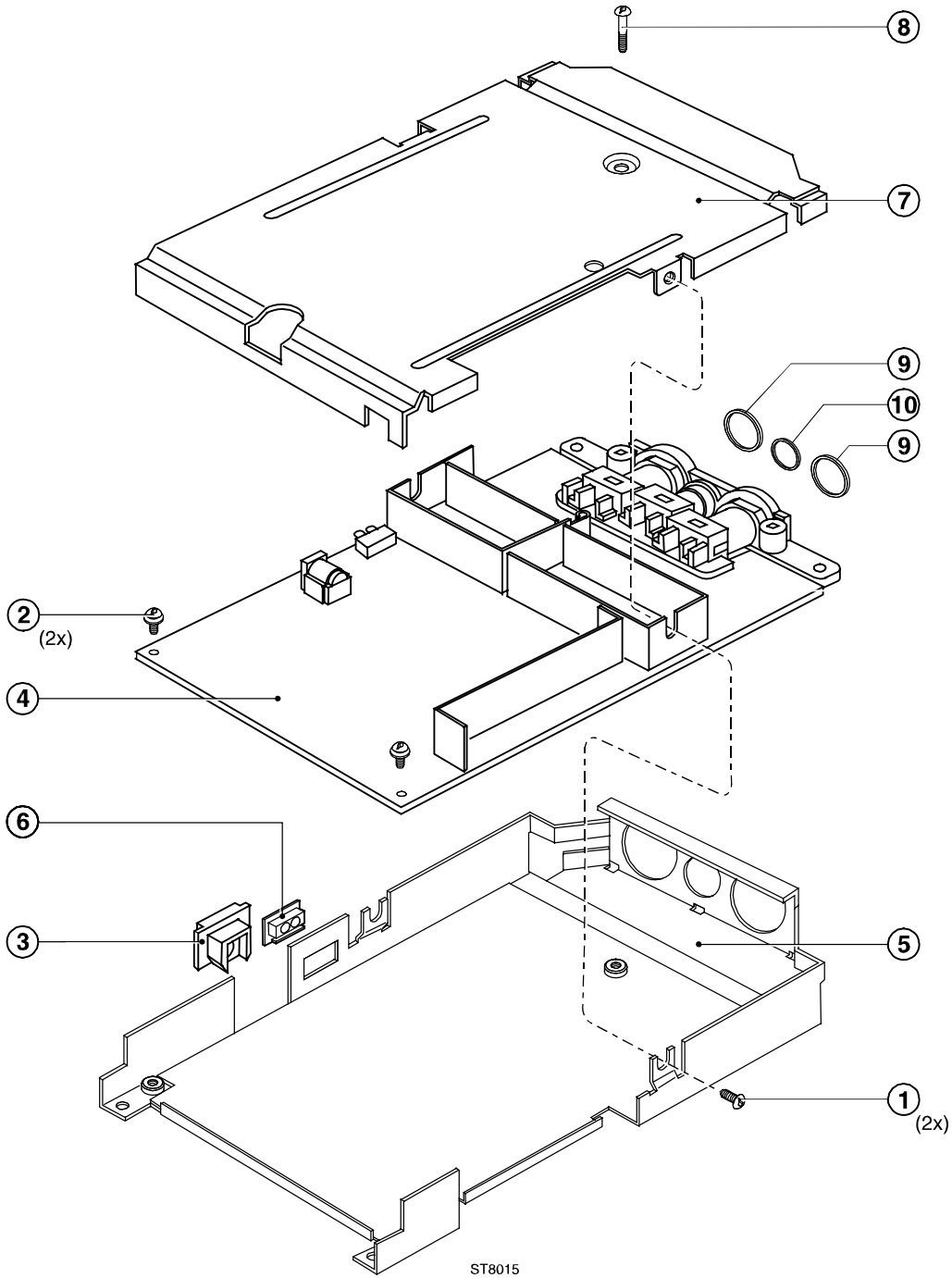

6-3. Main PCA Unit Assembly

6.4 Reassembling the Main PCA Unit

Reassembling the main PCA is the reverse of disassembly. However you must follow special precautions when reassembling the main PCA unit.

1. Ensure the input banana jacks have the rubber sealing ring in place (Input 1, 2 item 9, COM input item 10, see Figure 4-6).
2. Do not forget to install the power connector insulator (item 3) and the LED holder (item 6).
3. Notice the correct position of the shielding box, main PCA (notice the shielding plates on the PCA), and shielding plate, as shown in Figure 6-2. The tabs of the shielding plate must be inside both shields.

6.5 Reassembling the Test Tool

Reassembling the test tool is the reverse of disassembly. However you must follow special precautions when reassembling the test tool. Refer also to figure 6-1.

Reassembling procedure for a completely disassembled unit:

1. Clean the inside of the lens with a moist soft cloth if necessary. Keep the lens free of dust and grease.
2. Install the keypad. Press the edge of the keypad into the sealing groove of the top case. Ensure that the keypad lays flat in the top case, and that all keys are correctly seated.
3. Install the shielding foil (item 2). Remove the protection foil from the shielding foil, by pulling it off in one rapid movement! If you pull it off slowly, the protection foil may crack. Keep the shielding foil free of dust and grease.
4. Install the dust seal (item 3).
5. Install the display shielding bracket (item 5) provided with the conductive foam strip (item 4).

Note

Figure 6-4 shows how the shielding bracket (with conductive foam strip), the shielding foil, the dust seal, and the display assembly (see step 7) are clamped in the top cover edge.

6. Install the keypad foil. Align the positioning holes in the keypad foil to the positioning pins in the top case.
7. Clean the display glass with a moist soft cloth if necessary. Install the display assembly. Ensure that the display is secured correctly by the four alignment tabs in the top case. It is secured correctly when it cannot be moved horizontally.
8. Install the keypad pressure plate. Press the plate firmly, and slide it under the four plastic keeper tabs in the top case.
9. Install the main PCA unit, and re-attach the cables. Secure the flat cables in the connectors with the connector latches. **Twist the backlight wires to minimize interference voltages!** Insert the shielding flap below the main PCA shielding plate.
10. Put the bottom case and the top case together at the flat cable side, and hinge the cases to each other. This ensures the keypad foil flat cable is folded correctly.
11. Install the battery pack, and the battery door, see figure 6-5.

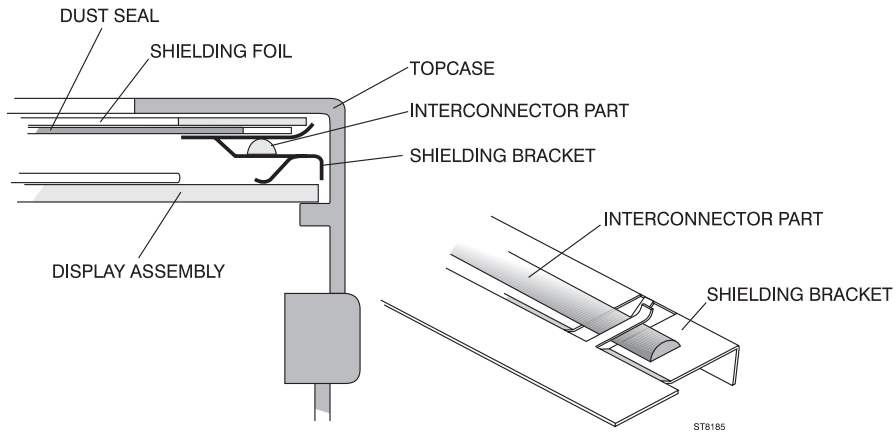

Figure 6-4. Mounting the display shielding bracket

ST8185.EPS

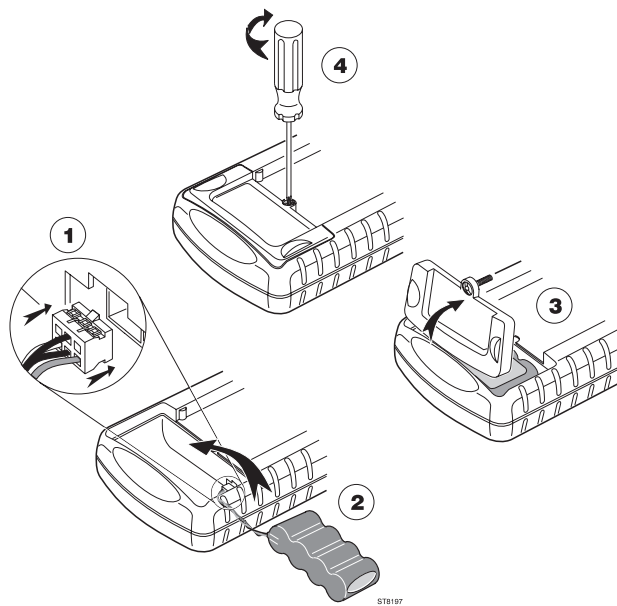

Figure 6-5. Battery pack installation

ST78197.EPS

Chapter 7

Corrective Maintenance

Title	Page
7.1 Introduction.....	7-3
7.2 Starting Fault Finding.....	7-4
7.3 Charger Circuit.....	7-4
7.4 Starting with a Dead Test Tool.....	7-6
7.4.1 Test Tool Completely Dead.....	7-6
7.4.2 Test Tool Software Does not Run.....	7-7
7.4.3 Software Runs, Test Tool not Operative.....	7-7
7.5 Miscellaneous Functions.....	7-7
7.5.1 Display and Back Light.....	7-7
7.5.2 Fly Back Converter.....	7-8
7.5.3 Slow ADC.....	7-9
7.5.4 Keyboard.....	7-10
7.5.5 Optical Port (Serial RS232 Interface).....	7-11
7.5.6 Input Channel 1 and 2 Voltage Measurements.....	7-11
7.5.7 Ohms and Capacitance Measurements.....	7-12
7.5.8 Trigger Functions.....	7-13
7.5.9 Reference Voltages.....	7-14
7.5.10 Buzzer Circuit.....	7-14
7.5.11 Reset ROM Line (ROMRST).....	7-14
7.5.12 RAM Test.....	7-14
7.5.13 Power ON/OFF.....	7-15
7.5.14 PWM Circuit.....	7-15
7.5.15 Randomize Circuit.....	7-15

Tequipment
_____.NET



205 Westwood Ave
Long Branch, NJ 07740
1-877-742-TEST (8378)
Fax: (732) 222-7088
salesteam@Tequipment.NET

7.1 Introduction

This chapter describes troubleshooting procedures that can be used to isolate problems with the test tool.

Warning

Opening the case may expose hazardous voltages. For example, the voltage for the LCD back light fluorescent lamp is >400V! Always disconnect the test tool from all voltage sources and remove the batteries before opening the case. If repair of the disassembled test tool under voltage is required, it shall be carried out only by qualified personnel using customary precautions against electric shock.

- If the test tool fails, first verify that you are operating it correctly by reviewing the operating instructions in the Users Manual.
- When making measurements for fault finding, you can use the black COM input banana jack, or the metal shielding on the Main PCA unit, as measurement ground.
- To access the Main PCA for measurements, proceed as follows:
 1. Remove the Main PCA unit, see 6.2.5.
 2. Disassemble the Main PCA unit, see 6.3.
 3. Connect the Display Assembly flat cable, the Backlight cable, and the Keypad Foil flex cable to the Main PCA unit. Position the Keypad on the Keypad foil. See Figure 7.1. The Test tool without the case is operative now.
 4. Power the PCA via the Power Adapter and/or battery pack. Watch out for short circuiting due to metal parts on your desk!!



Figure 7-1. Operative Test Tool without Case

REPAIR3.BMP

7.2 Starting Fault Finding.

After each step, continue with the next step, unless stated otherwise.

Power the test tool by the battery pack only, then by the power adapter only.

1. The test tool operates with the power adapter, but not with the battery only: install a charged battery (VBAT >4V), and check the connections between the battery and the test tool (X503, R504, R506, R507).
2. The test tool operates with the battery pack, but not with the power adapter only, and the battery pack is not charged by the test tool: continue at 7.3 Charger Circuit.
3. The test tool operates neither with the battery pack, nor with the power adapter: continue at 7.4 Starting with a Dead Test Tool.
4. Particular functions are not correct: continue at 7.5 Miscellaneous Functions.

Table 7-1. Starting Fault Finding

	Power adapter	Battery Pack	Check
1	OK	NOT OK	Battery pack, connector, sense resistors
2	NOT OK	OK	See 7.3 Charger Circuit
3	NOT OK	NOT OK	See 7.4 Starting with a Dead Test Tool
4	Partly OK	Partly OK	See 7.5 Miscellaneous Functions

7.3 Charger Circuit

1. Power the test tool by the power adapter only.
2. Check TP501 for $\cong 15...20V$.
If not correct, check the power adapter input circuit (X501, Z501, V501, C501).
3. Check TP504 (VBAT) for about 7.5V.
If not correct, check R501, V504, V503, L501, C503.
Check TP502 for a 100 kHz, 13Vpp pulse signal; if not correct or low, check if TP504 is shorted to ground, and check V506.
4. Install a charged battery. The voltage at TP504 will be now about 5V.
5. Check N501 pin 18 (P7VCHA) for $\cong 7V$.
If not correct, check N501 pin 20 for $\cong 15V$ (supplied via R502). If 15V on pin 20 is correct, check C507, replace N501.

P7VCHA is the supply voltage for the charger control circuit in N501. It is derived from VADAPTER (pin20), by an internal linear supply in N501.

6. Check N501 pin 12 (NETVALID) for +2.7V, and TP529 (MAINVAL) for +3.3V.

The NETVALID and MAINVAL signals indicate to the P-ASIC and the D-ASIC that a correct power adapter voltage is connected. The signals enable control of the P-ASIC CHARGE circuit (controls V506 by 100 kHz, 13Vpp square wave).

If correct continue at step 7.

If not correct, then:

- a. Check TP571 (+3V3GAR) for +3V3V.
If not correct, possibly caused by V569, R580, TP571 short to ground, loose pins of N501, N501 defective.
 - b. Check N501 pin 8 (VADALOW) for $\cong 1.1V$
If not correct:
 1. Check R516 and connections.
The P-ASIC supplies a current to R516. The current source uses REFPWM2 and IREF, see 2 and 3 below.
 2. Check N501 pin 73 (REFPWM2) for +3V3. REFPWM2 is supplied by the P-ASIC. Check TP307 (N501 pin 72, REFP) for 1.22V, check V301 and R307.
 3. Check N501 pin 74 (IREF) for 1.61V.
If not correct, possibly caused by R528, loose pin 74, or N501 defective.
 - c. Check +3V3SADC on N501 pin 65 for +3.3V.
7. Check TP531 (CHARCURR):
The CHARCURR signal controls the battery charge current.
If TP531 < 2.7V continue at step 7a.
If TP531 > 2.7V continue at step 7b.
- a. Check if charger FET V506 is controlled by a $\cong 100$ kHz, 13 Vpp square wave on TP502 (FET gate). If correct check/replace V506.
If not correct, check:
 1. N501 pin 4 TEMPHI relative to X503 pin 3 (=N501 pin 9) for $\cong 200$ mV. If not correct, check R512 and connections.
 2. N501 pin 5 TEMP relative to X503 pin 3 (=N501 pin 9) for $\cong 400...500$ mV at about 20 °C. If not correct check the NTC in the battery pack for $\cong 12$ k Ω at 20°C (X503 pins 3 and 5); check connections to N501.
 3. N501 pin 6 (IMAXCHA) for $\cong 150$ mV. If not correct check R514, and connections to N501.
 4. N501 pin 7 (VBATHHIGH) for $\cong 1.2V$. If not correct check R513, and connections to N501.

Steps 1 to 4 verify that N501 supplies a 47 μA current to each of the resistors R512, battery NTC, R514, and R513
 5. Check N501 pin 9 for the same voltage as on X503 pin 3 (sense resistors R504, R506, and R507).
 6. If 1 to 5 above correct, then N501 is defective.
 - b. Connect TP531 for a short time (max. 1 minute) to ground, and see if the FET gate TP502 now shows a 100 kHz pulse signal.
If it does not, continue at step 7d.
If it does, the CHARCURR control signal is not correct, continue at step 7c.
 - c. Check the CHARCURR control signal:
The CHARCURR voltage on TP531 is controlled by a pulse width modulated voltage (CHARCUR) from the D-ASIC D471 (pin 40). The D-ASIC measures the required signals needed for control, via the Slow ADC.

1. Check the SLOW ADC, see 7.5.3.
2. Check VGARVAL (N501 pin 64), for +3.3V. If not correct, check if the line is shorted to ground. If it is not, then replace N501.
3. Trace the CHARCURR signal path to R534, R 442 and D471 (D-ASIC) output pin 40.
- d. Check the following:
 1. C506 and connections to N501.
 2. Connections between V506 and N501 pin 16 (CHAGATE).
 3. The voltage at TP501 (N501 pin 19, VCHDRIVE) for $\cong 15...20V$.
 4. The voltage at N501 pin 43 for a triangle waveform, 80...100 kHz, +1.6V to +3.2V.
 5. If 1 to 4 correct, then replace N501.

7.4 Starting with a Dead Test Tool

If the test tool cannot be turned on, when powered by a charged battery pack, or by the power adapter, follow the stwmf below to locate the fault.

1. Connect a power adapter and a charged battery pack.
2. Turn the test tool on and listen if you hear a beep.
 - a. If you hear no beep, continue at 7.4.1 Test Tool Completely Dead.
 - b. If you hear a weak beep, continue at 7.4.2 Test Tool Software Does not Run.
 - c. If you hear a “normal” beep, the software runs, but obviously the test tool is not operative. Continue at 7.4.3 Software Runs, Test Tool not Operative.

7.4.1 Test Tool Completely Dead

1. Turn the test tool off. Keep the  arrow keys pressed, and turn the test tool on again. This will start up the mask software.
If you still hear no beep, continue at step 2.
If you hear a weak beep now, continue at 7.4.2.
2. Check the Keyboard ROW1 line (MS433 next to X452) for a 100 kHz square wave.
If not correct, continue at step 3.
If correct, the mask software runs, but the buzzer circuit does not function. Check the buzzer function (7.5.10), and then continue at 7.4.2.
3. Check N501 pin 60 (VBATSUP) for >4.8V. If not correct check R503, and connections to battery pack.
4. Check TP571 (+3V3GAR) for +3V3V.
If not correct, this is possibly caused by V569, R580, TP571 short to ground, loose pins of N501, or N501 defective. Check the +VD supply voltage on D-ASIC D471. Temporarily remove R470 to check for short circuit.
5. Check N501 pin 64 (VGARVAL) for +3.3V. If not correct:
 - a. Check if the line is shorted to ground.
 - b. Check N501 pin 73 (REFPWM2) for +3V3. REFPWM2 is supplied by N501, and derived from REFP on the reference circuit on the Trigger part. Check

TP307 (N501 pin 72, REFP) for 1.22V, check V301/R307. If no 1.22V, and V301/R307 and connections are correct, then replace N501.

- c. Check N501 pin 12 (NETVALID) for +2.6V. If not correct, proceed as indicated in 7.3, step 6.
 - d. Check the Power ON/OFF function, see 7.5.13.
6. Check X-tal signals on TP473 (32 kHz), and TP476 (25 MHz); if not correct check connections, replace X-tals, replace D471. The 16 MHz clock on TP474 runs only if the test tool software runs. If the 16 MHz clock is present, then continue at 7.4.3.

7.4.2 Test Tool Software Does not Run.

1. Turn the test tool OFF and ON again.
2. Check D471 pin 59 (row1) for a 100 kHz square wave.
If no 100 kHz is not present, but you heard a weak beep, the test tool software runs, but the buzzer circuit does not function correctly. Go to 7.5.10 to check the buzzer circuit, then continue at 7.4.3 to see why the test tool cannot be operated.
If a 100 kHz square wave is present, the MASK software is running. Continue at 3.
3. Check TP487 (ROMRST) for >3V.
4. Load new software to see if the loaded software is corrupted. See 7.6.
5. Do the RAM test, see 7.5.12.
6. Check for bad soldered address/data lines and IC pins.
7. Replace FLASH-ROM D474 and RAM D475.

7.4.3 Software Runs, Test Tool not Operative

1. Check the Display and Backlight function, see 7.5.1
2. Check the Fly Back Converter, see 7.5.2
3. Check the Keyboard function, see 7.5.3

7.5 Miscellaneous Functions

7.5.1 Display and Back Light

Warning

The voltage for the LCD back light fluorescent lamp is >400V!

1. Connect another LCD unit to see if the problem is caused by the LCD unit. The unit is not repairable.
2. Defective display
Check the LCD control signals on measure spots MS401...MS422 (near to X453).
Use a 10:1 probe with ground lead on the probe connected to the metal screening of the UUT. Notice that MS407 is missing !
 - a. MS422: LCDONOFF for +3.3V.
 - b. MS420: DATACLK0 for 120 ns pulses
MS414-415: LCDAT0,1 for 250 ns pulses

MS417-418: LCDAT2,3 for 250 ns pulses
MS412 LINECLK, for 120 ns pulses, $\cong 16$ kHz
MS411 FRAME, for 250 ns pulses, $\cong 66$ Hz
MS409 M, for a $\cong 625$ Hz square wave.

- c. MS406 +5VA for +5V
MS405 +3V3D for +3.3V
MS401 -30VD for -30V (from Fly Back Converter).
 - d. MS404 REFPWM1 for +3.3V.
3. Bad contrast.
- a. Check MS403 (CONTRAST), see Figure below:

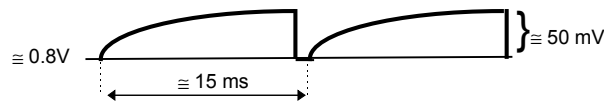

If not correct check FRAME signal on V401 for 0...3V, 250 ns pulses, 66Hz;
check PWM circuit (7.5.14); check V401-V403.

- b. Check MS408 (LCDTEMP1) for +1.6V at room temperature (to SLOW ADC).
If not correct, check R591 in SLOW ADC part.
4. Defective backlight:
- a. Turn the test tool on, and monitor the voltage on T600 pin 3 or pin 5 for a 8 Vpp, 66 kHz, half rectified sine wave. If a half rectified sine wave, with an increasing amplitude, is only seen for about 0.2 second directly after power on, then the secondary circuit is defective. Install a new LCD unit. If this does not cure the problem, check the resistance between T600 pin 10 and 11 for $\cong 300\Omega$, replace V603, V605.
 - b. Check T600 pin 3 and pin 5 for a 8 Vpp, 66 kHz, half rectified sine wave. If it is present on only pin 3 or pin 5, then replace V601.
 - c. Check TP601 and TP602 for a 7Vpp, 66 kHz, square wave. If not correct then check TP604 (TLON) for +3V3. If TLON is correct, then replace N600.
 - d. Check (replace) V600, V602.
5. Backlight brightness control not correct (brightness increases if a power adapter is connected):
Check the TP605 (BACKBRIG, supplied by D-ASIC D471) for a 25 kHz, 3.3 V pulse signal. The duty cycle of the pulses controls the back light brightness. The backlight brightness increases with an increasing length of the high pulse. Check V604, R604.

7.5.2 Fly Back Converter

1. Check the voltages on TP572 (+5V), TP573 (+3.3V), TP574 (+3.3V), TP576 (-3.3V), TP577 (-30V) on the POWER part.
 - a. If one or more voltages are correct, then check the rectifier diodes (V561...V564), and coils (L562...L567) of the incorrect voltage.
 - b. If none of the voltages is correct, then the fly back converter does not run correctly, continue at step 2.
2. Check TP504 (VBATT) for >4.8 V.

3. Check TP552 (FLYGATE) for a square wave voltage of at least some volts (for a correct Fly Back Converter 50...100 kHz, $\cong 10$ Vpp).
 - a. If a square wave is present on TP552 (may be not the correct value), then:
 1. Check the voltage on N501 pin 55 (FLYSENSP). For a correct converter this is a saw tooth voltage of 50...100 kHz, 50...150 mVpp).



- a. If **no** sawtooth voltage is present on R501, no current, or a DC current flows in FET V554. The primary coil or V554 may be defective (or interrupted connections). Check R504, R506, R507 (battery current sense resistors); these resistors may be fused due to a short in FET V554.
 - b. If an **incorrect** sawtooth is present on R501 this can be caused by:
 - overloaded outputs (Frequency low, e.g. $\ll 50$ kHz; 250 mVpp)
 - underloaded outputs (Frequency high, e.g. $\gg 100$ kHz; $\ll 100$ mVpp)
 - bad FET V554 (Sawtooth voltage is not linear).
2. Check V552 and V553, check R570 and VCOIL connections.
- b. No FLYGATE square wave is present.
Check TP526 (FREQPS) for a 50...100 kHz, 3.3 Vpp square wave. If correct, then check V552, and V553. If no square wave on TP526, then go to step 4.
4. Check TP528 (PWRONOFF) for +3V. If not correct, see 7.5.13 Power ON/OFF.
5. Check N501 pin 43 (COSC) for a triangle waveform, 50...100 kHz, +1.6V to +3.2V. If not correct check C553 and connections; check IREF, see step 6. If all correct, replace N501.
6. Check N501 pin 74 (IREF) for 1.6V. If not correct:
 - a. Check N501 pin 73 (REFPWM2) for +3V3. REFPWM2 is supplied by N501, and derived from REFP on the reference circuit on the Trigger part. Check TP307 (N501 pin 72, REFP) for 1.22V. If not correct, check V301/R307.
 - b. Check R528, loose pin 74, or N501 defective.
7. Check N501 pin 51 (VOUTH1) for < 2.5 V (nominal value 1.65V). If not correct check R558 and connections to N501; check IREF, see step 6.
8. Check N501 pin 57 (IMAXFLY) for $\cong 250$ mV. If not correct check R559 and connections to N501; check IREF, see step 6.

7.5.3 Slow ADC

Check the following signals:

1. BATCUR (N501 pin 77), must be $\{1.63 + (6.7 \times \text{IBATP})\}$ Volt.
If not correct, replace N501.
Measure IBATP on X503 pin 3 (= N501 pin 9); IBATP senses the battery current.
2. BATVOLT (N501 pin 78), must be $\{0.67 \times (\text{VBAT} - 3.27)\}$ Volt.
If not correct, replace N501.
Measure VBAT on TP504 (= N501 pin 3); VBAT senses battery the voltage.
3. BATTEMP (N501 pin 79), must be $\{\text{TEMP} - \text{IBATP}\}$ Volt.
If not correct, replace N501.

Measure TEMP on N501 pin 5 (=X503 pin 6); TEMP senses the battery temperature. Measure IBATP on X503 pin 3 (= N501 pin 9); IBATP senses the battery current.

4. +3V3SADC must be +3.3V (supplied by N501 pin 65). If not correct, check if the +3V3SADC line is shorted to ground. If it is not, then replace N501.
5. SELMUXn (TP591, TP592, TP593) supplied by the D-ASIC must show LF pulses (0V to +3.3V, 0.5...3 seconds period).
6. Check TP536, TP537, and TP534 for signals shown below (typical examples, measured signals may have different pulse amplitude and repetition rate).
 TP536: if at a fixed level, replace D531.
 TP537: if not correct, trace signal to PWM circuit on the Digital part.
 TP534: if at a fixed level, replace N531.

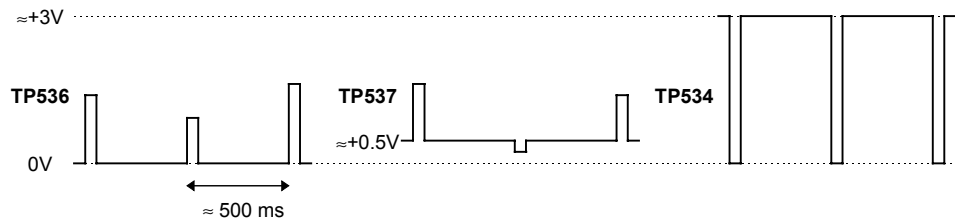

7.5.4 Keyboard

Proceed as follows if one or more keys cannot be operated.

1. Replace the key pad, and the key pad foil to see if this cures the problem.
2. Press a key, and check ROW0...5 (measure spots MS432..MS437) for the signal shown below :

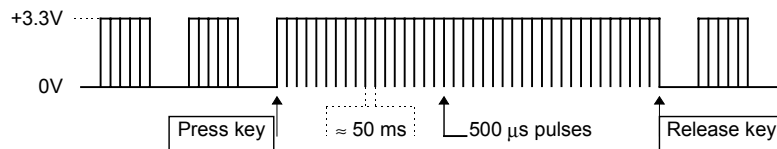

If no key is pressed the ROW lines are low if a battery is installed; if the 43 is powered by the the mains adapter only, the lines are alternating pulsing and low.

3. Check COL0...3 (measure spots MS438...MS441) for a +3.3V level. Then press and hold a key, and check the matching COL line for the signal shown below:

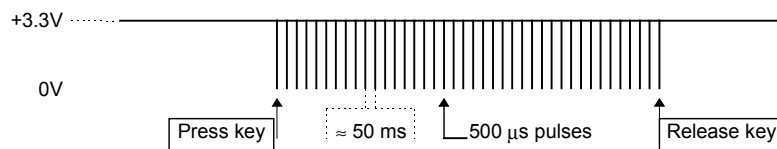

If not correct, check the connections from X452 to D471; replace D471.

For the ON/OFF key see 7.5.13.

7.5.5 Optical Port (Serial RS232 Interface)











Receive (RXD)

1. Check the voltage RXDA on TP522 for +200 mV, and the voltage RXD on TP527 (buffered and amplified RXDA voltage) for +3.3V.
2. Shine with a lamp in the optical port (H522).
Check the voltage RXDA on TP522 for 0...-0.6V, and RXD on TP527 for 0V.

Send (TXD).

1. Check the voltage TXD on TP521 for +3.3V.
2. Press  to start the test tool data output.
Check the voltage TXD on TP521 for a burst of pulses (pulses from +2V to +3.3V).
The length of the burst and the pulses depends on the selected baud rate.

7.5.6 Input Channel 1 and 2 Voltage Measurements

1. Reset the test tool (press  and )
2. Select the Scope Roll mode for both input channels:
Press , , highlight **SCOPE** and press 
Press  (SETUP), highlight **INPUT 2 Coupling: OFF**, press , highlight DC, press , highlight **Time Base: NORMAL**, press , highlight ROLL, press , press  BACK.
3. Apply a 1 kHz square wave to Input 1 and Input 2, and change the test tool sensitivity (V/div) to make the complete square wave visible.
4. Check TP154 (ADC-A) and TP254 (ADC-B) for the signal shown below:

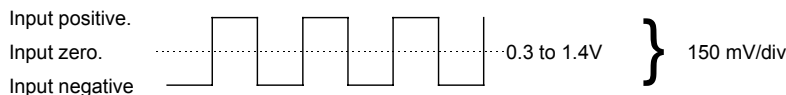

A trace amplitude of 1 division results in an 150 mV voltage on TP154/255
Moving the trace position, with a zero input signal, results in a TP154/254 voltage of about +0.3V (bottom) to +1.4V (top).

If the voltages are not correct, do stwmf 6 to 16; if these stwmf are correct, then replace the C-ASIC.

If the voltages are correct, the error is most probably caused by the ADC, or ADC control: continue at step 16.

5. Check TP156 (TRIGA) and TP256 (TRIGB). The TRIGA and TRIGB signals must be the inverted input signals, with an amplitude of 50 mV per division trace amplitude.
Moving the trace position, with a zero input signal, results in a TP156/256 voltage of about +0.4V (bottom) to -0.4V (top).
If the voltages are not correct, do stwmf 6 to 16; if these stwmf are correct, then replace the C-ASIC.
6. Check the supply voltages +3V3A (+3.3V), -3V3A (-3.3V), and +5VA (+5V).
If not correct trace to the Fly Back converter on the Power part.

7. Check TP151 (POS-A) and TP251 (POS-B) for about +1.1V (trace at mid-screen), +0.4V (trace at top of screen), +1.8V (trace at bottom of screen).
If not correct check the PWM circuit (in the Digital Circuit).
8. Check TP152 (OFFSET-A) and TP252 (OFFSET-B) for about +1.1V.
9. Check TP303 (REFN) for -1.2V.
10. Check TP153 (DACTESTA) and TP253 (DACTESTB) for 0V. If TP153 is +1.7V, the C-ASIC is in the reset state (200 mV/div fixed sensitivity); check SDAT and SCLK, see step 15.
11. Check TP155 (MIDADCA) and TP255 (MIDADCB) for about +0.9V.
12. Select the Scope Normal mode for both input channels:
Press **MENU**, highlight **SCOPE** and press **ENTER**, press **F1** (SETUP), highlight **INPUT 2 Coupling: XXX**, press **ENTER**, highlight **DC**, press **ENTER**, highlight **Time Base: XXX**, press **ENTER**, highlight **NORMAL**, press **ENTER**, press **F1** BACK.
Select a time base setting of 20 ms/d.
13. Check TP258 (TRACEROT supplied by T-ASIC N301) for the signals shown below (typical example at 20 ms/div.).

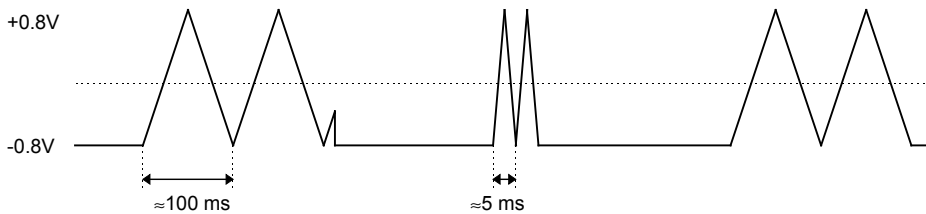

If not correct check:

TP432 (RAMPCLK) for 3V, 200 ns pulses.

TP332 (RAMPCLK) for 0.6V, 200 ns pulses.

TP331 (RSTRAMP) for +3V pulses, with varying pulse width and repetition rate.

All pulses are supplied by D-ASIC-D471.

14. Check TP310 (REFATT) for alternating +1.2V and -1.2V pulses. The repetition time depends on the time base, and is for example 9 s at 20 ms/div.
15. Check the SCLK and SDAT lines for +3.3V pulse bursts (C-ASIC pin 25 and 26).
16. Check TP437 (Sample clock) for a 5 MHz (time base ≥ 1 ms/div) or 25 MHz clock signal (3.3V).
17. Check TP301 (REFADCT) for +1.62V, and TP302 (REFADCB) for +0.12V
18. Check the ADC supply voltages VDDAA, VDDDA, VDDBB, VDDDB, and VDDO for +3.3V
19. Check TP401 and TP451 for 0V.

7.5.7 Ohms and Capacitance Measurements

1. Press **MENU** and select **OHMS/CONTINUITY/CAPACITANCE**.
Press **F1** (Ohms).
Connect a current meter between Input 1 and the COM input. Select the various Ohms ranges, and verify that the current approximately matches the values listed in

the table below.



If not correct, the protection circuit or the current source in the T-ASIC (N301) may be defective.

If the current is correct, and the Volt function is correct (so ADC is correct), then the Ohms part in the C-ASIC is defective: replace N101.









Range	50Ω ¹⁾	500Ω	5 kΩ	50 kΩ	500 kΩ	5 MΩ	30 MΩ
Current	500 μA	500 μA	50 μA	5 μA	0.5 μA	50 nA	50 nA

¹⁾ The 50Ω range is only available in the Continuity measurement function.

The current in the Diode measurement function must be 500 μA.

2. Press  and select **OHMS/CONTINUITY/CAPACITANCE**.
Press  (Capacitance).
Verify TP156 for +3.3 ... 0V pulses (repetition rate 100...200 ms):
Zero scale (open input): pulse width approximately 30 μs.
Full scale (for example 500 nF): pulse width approximately 25 ms.
If not correct, most probably the C-ASIC N101 is defective.
If correct continue at 7.5.8 Trigger functions (pulse width is measured via the T-ASIC).

7.5.8 Trigger Functions

1. Select the Scope Normal mode for both input channels:
Press , highlight **SCOPE** and press , press  (SETUP), highlight **INPUT 2 Coupling: XXX**, press , highlight **DC**, press , highlight **Time Base: XXX**, press , highlight **NORMAL**, press , press  BACK.
2. Supply a 1 kHz sine wave of +/- 3 divisions to Input 1, and Input 2.
3. Check:
 - a. TP156, TP256 for a 600 mV (6 div. x 100 mV/div), 1 kHz, sine wave; the DC level depends on the trace position. The sine wave is interrupted now and then to do a reference measurement.
If not correct, C-ASIC N101/N102 is probably defective.
 - b. TP321, TP322 for 1.1...1.9V DC (move the trigger level from top to bottom).
If not correct check the PWM circuit, see 7.5.8.
 - c. TP311 for a 0...+3.3V, 1 kHz square wave when the trigger level is at the middle of the trace). Change the trigger level, and verify that the duty cycle of the square wave changes. If not correct T-ASIC N301 may be defective.
 - d. TP433 for 0...+3.3V pulses. Pulse width:
4...10 μs for time base 2 μs/div and faster;
>40 μs for time base 5 μs/div and slower; pulse width increases with time base.
 - e. TP336 for +0.6...0V pulses, TP436 for +3.3...0V pulses; the pulse width is about 40 μs...10 ms.
If not correct, check the RANDOMIZE circuit, see 7.5.15.
 - f. TP437 (SMPCLK) for a 5 MHz (time base ≥ 10 ms/div) or 25 MHz (time base < 1 ms/div) clock signal (3.3V). Check SMPCLK on both sides of R339.

7.5.9 Reference Voltages

1. Check:
 - a. TP306 for +3.3V, TP307 for +1.23V
If not correct check/replace V301, R307, C3112, P-ASIC N501.
 - b. TP301 for +1.6V ; TP302 for +0.1V ; TP304 for +3.3V ;
TP310, see figure below (in ROLL mode TP310 is zero).
If not correct, check/replace REFERENCE GAIN circuit and T-ASIC N301.

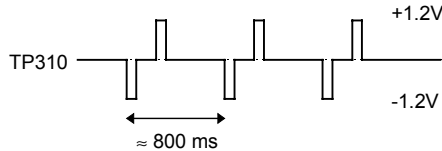

7.5.10 Buzzer Circuit

1. Press **MENU** and select **OHMS/CONTINUITY/CAPACITANCE**.
Press **F3** (Continuity).
2. Short circuit Input 1 to COM. The buzzer is activated now.
3. Check TP496 for a 4 kHz, 0...3V square wave during beeping (+3 V if not activated).
4. Check TP495 for a 4 kHz +3...-30V square wave during beeping (TP495 is +3V if the beeper is not activated).

7.5.11 Reset ROM Line (ROMRST)

1. Check TP487 for +3V (supplied by D471).

7.5.12 RAM Test

You can use the Microsoft Windows Terminal program to test the RAM. Proceed as follows:

1. Connect the Test Tool to a PC via the Optical Interface Cable PM9080.
2. Start the Terminal program, and select the following Settings:

Terminal Emulation	TTY (Generic)				
Terminal Preferences	Terminal Modes	CR -> CR/LF	<input checked="" type="checkbox"/>	Line Wrap	
		Inbound	<input checked="" type="checkbox"/>	Local	
Echo	<input type="checkbox"/>	Outbound	<input checked="" type="checkbox"/>	Sound	
Communications		Baud Rate		9600	
		Data Bits		8	
		Stop Bits		1	
		Parity		None	
		Flow Control		Xon/Xoff	
		Connector		COMn	
3. Turn the test tool off. Keep the keys **Alt+Enter** pressed, and turn the test tool on again. This will start up the mask software. You will hear a very weak beep now.

4. In the terminal program type capital characters X (no ENTER!). After a number of characters the test tool mask software will respond with an acknowledge 0 (zero). This indicates that the communication between the Terminal program and the test tool is accomplished.
5. Type ID
and press [Enter]
The test tool will return an acknowledge 0 (zero), and the string
Universal Host Mask software; UHM V2.1
If it does not, check the Terminal program settings, the interface connection, and the test tool Optical Port (7.5.5).
6. Type EX10, #H400000, #H20000
and press [Enter]
The test tool will return one of the following acknowledges:
0 the RAM is OK.
1 syntax error in the typed command
6 the RAM does not properly function.

Notice that the acknowledge overwrites the first character of the message sent to the test tool.

7.5.13 Power ON/OFF

1. Check TP528 for +3V at power on, and 0V at power off (supplied by D471).
If not correct, do the 7.4.1. tests first!
2. Check MS444 (ONKEY, D471) for +3V; when pressing the ON key the signal must below for 100...150 ms.

7.5.14 PWM Circuit

1. Check the PWM control signals generated by D471. The signals must show 0...3V pulses, with variable duty cycle, and a frequency of 100, 25, or 6 kHz:
 - a. CHARCURD, CONTR-D ≅ 100 kHz
 - b. SADCLEV, POS A-D, BACKBRIG, POS B-D,
TRIGLEV2D, TRIGLEV1D, HO-RNDM ≅ 25 kHz
 - c. OFFSETA-D, OFFSETB-D ≅ 6 kHz
2. If not correct, check:
 - a. TP306 (REFPWM2) for +3.3V (used for CHARCURD SADCLEV)
 - b. TP304 (REFPWM1) for +3.3V (used for other PWM signals).

If TP306 and TP304 are correct, D471 may be defective.

7.5.15 Randomize Circuit

1. Check TP483 for 0...+3V pulses, 25 kHz, variable duty cycle
2. Check TP482, for +3...0V pulses, variable frequency and duty cycle.

Chapter 8

List of Replaceable Parts

Title	Page
8.1 Introduction	8-3
8.2 How to Obtain Parts	8-3
8.3 Final Assembly Parts	8-4
8.4 Main PCA Unit Parts	8-6
8.5 Main PCA Parts	8-7
8.6 Accessory Replacement Parts	8-23

8.1 Introduction

This chapter contains an illustrated list of replaceable parts for the model 43B ScopeMeter test tool. Parts are listed by assembly; alphabetized by item number or reference designator. Each assembly is accompanied by an illustration showing the location of each part and its item number or reference designator. The parts list gives the following information:

- Item number or reference designator (for example, “R122”)
- An indication if the part is subject to static discharge: the * symbol
- Description
- Ordering code

Caution

A * symbol indicates a device that may be damaged by static discharge.

8.2 How to Obtain Parts

Contact an authorized Fluke service center.

To locate an authorized service center refer to the second page of this manual (back of the title page).

In the event that the part ordered has been replaced by a new or improved part, the replacement will be accompanied by an explanatory note and installation instructions, if necessary.

To ensure prompt delivery of the correct part, include the following information when you place an order:

- Instrument model (Fluke 43B), 12 digit instrument code (9444), and serial number (DM.....). The items are printed on the type plate on the bottom cover.
- Ordering code
- Item number - Reference designator
- Description
- Quantity

8.3 Final Assembly Parts

See Table 8-1 and Figure 8-1 for the Final Assembly parts.

Table 8-1. Final Assembly Parts

Item	Description	Ordering Code
1	top case assembly Fluke 43B	4022 244 98361
1	Window/decal Fluke 43B	4022 243 09841
2	shielding foil	5322 466 11434
3	dust seal	5322 466 11435
4	conductive foam strip	5322 466 11436
5	display shielding bracket	5322 402 10204
6	display assembly	5322 135 00029
7	keypad	5322 410 11952
8	keypad foil	5322 276 14006
9	keyboard pressure plate	5322 466 10963
10	combiscrew M3x10	5322 502 21507
11	bottom case	5322 442 00273
12	combiscrew M3x10	5322 502 21507
13	battery pack	BP120
14	battery door	5322 443 10237
15	combiscrew M3x10	5322 502 21507
16	bail	5322 466 10975
A	main PCA unit assembly. No firmware loaded! Not calibrated!	5322 216 04605



Note

The test tool contains a Nickel Cadmium battery (item 13). Do not mix with the solid wastestream. Spent batteries should be disposed of by a qualified recycler or hazardous materials handler.

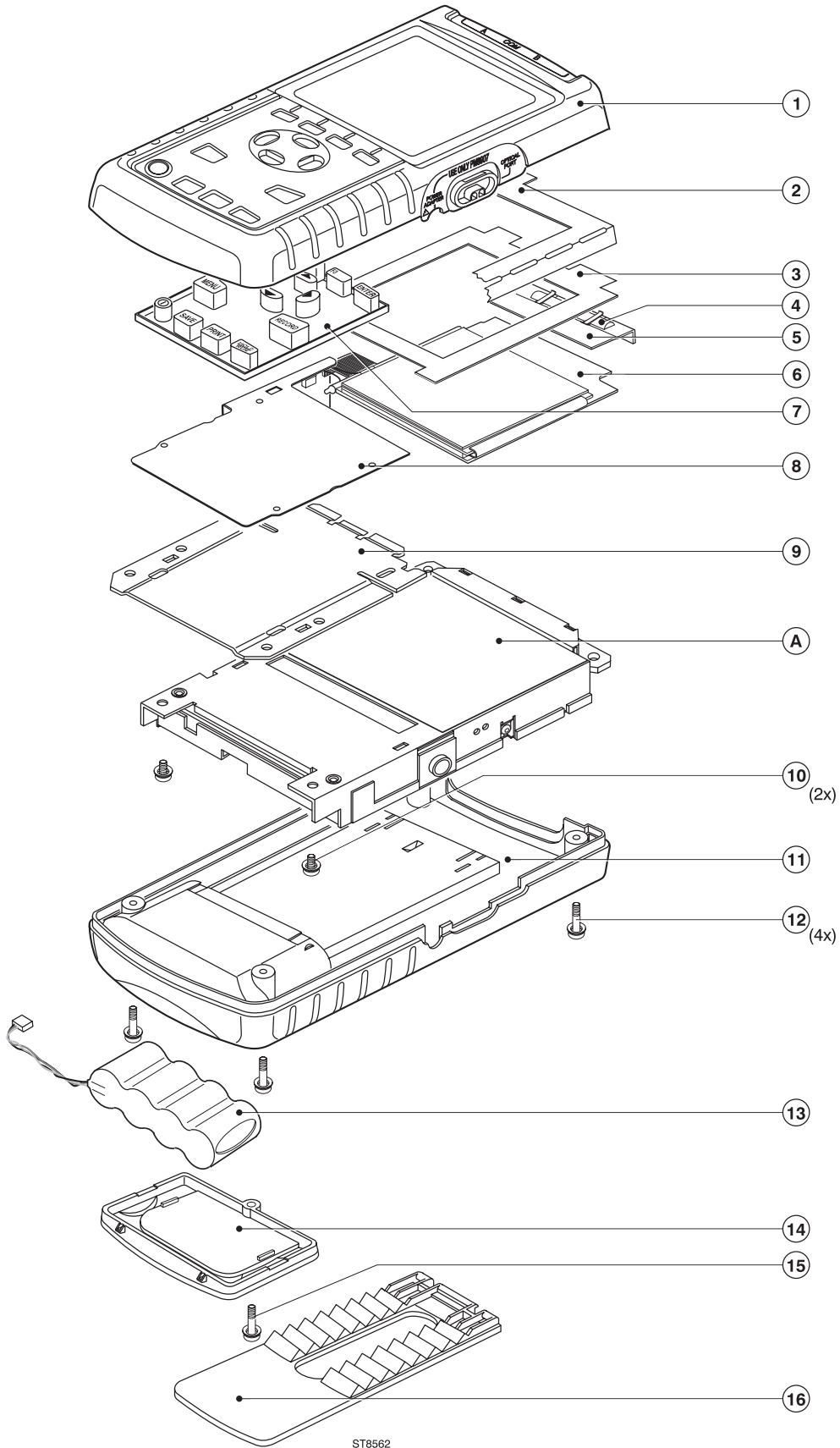

ST8562

ST8562.WMF

Figure 8-1. Fluke 43B Final Assembly

8.4 Main PCA Unit Parts

See Table 8-2 and Figure 8-2 for the Main PCA Unit parts.

Table 8-2. Main PCA Unit

Item	Description	Ordering Code
1	screw M2.5x5	5322 502 21206
2	combiscrew M3x10	5322 502 21507
3	insulator for power input	5322 325 10163
5	main PCA shielding box	5322 466 10976
6	guide piece for optical gate LEDs	5322 256 10201
7	main PCA shielding plate	5322 466 10964
8	screw M2.5x16	5322 502 14132
9	O-ring \varnothing 17 mm Input A,B	5322 530 10272
10	O-ring \varnothing 12 mm COM input	5322 530 10273

Note

If the main PCA must be replaced, you must order the complete Main PCA Unit.

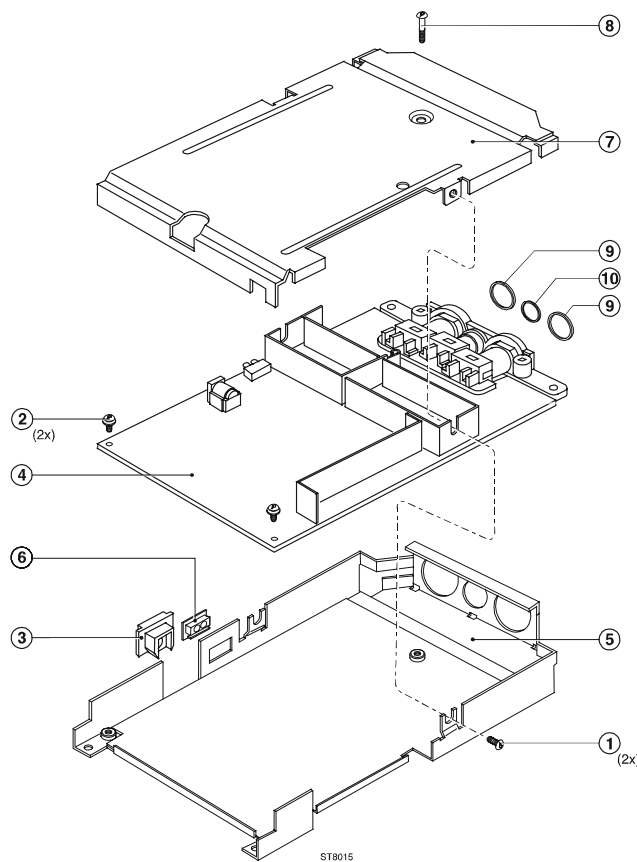

Figure 8-2. Main PCA Unit

ST8015.WMF

8.5 Main PCA Parts

See Figures 9-7 ... 9-10 at the end of Chapter 9 for the Main PCA drawings.

Table 8-3. Main PCA

Reference Designator	Description	Ordering Code
1	Led Holder for H521 and H522	5322 255 41213
2	Screw for Input Banana Jack Assembly	5322 502 14362
3 (X100)	Input Banana Jack Assembly - without Input A,B and COM O-rings, see Figure 8-2.	5322 264 10311
B401	QUARTZ CRYSTAL 32.768KHZ SEK	5322 242 10302
B402	QUARTZ CRYSTAL 16.0MHZ KDK	5322 242 10573
B403	QUARTZ CRYSTAL 25.0MHZ KDK	5322 242 10574
C101	MKC FILM CAP 630V 10% 22NF	5322 121 10616
C102	SUPPR CAPACITOR 0.1 UF	5322 121 10527
C104	CER.CAP. 3.15KV +-5% 120PF	5322 126 14046
C105	ALCAP NICHICON 16V 10UF	5322 124 41979
C106	CER.CAP. 1KV -20+80% 4.7NF	5322 126 13825
C107	CER CHIP CAP 63V 5% 470PF	5322 122 32268
C111	CER CAP 1 500V 0.25PF 4.7PF	5322 122 33082
C112	CER CAP 1 500V 0.25PF 4.7PF	5322 122 33082
C113	CER CAP 1 500V 0.25PF 4.7PF	5322 122 33082
C114	CER CAP 1 500V 0.25PF 4.7PF	5322 122 33082
C116	CER CAP 1 500V 0.25PF 4.7PF	5322 122 33082
C117	CER CAP 1 500V 2% 10PF	4822 122 31195
C118	CER CAP 1 500V 0.25PF 4.7PF	5322 122 33082
C119	CER CAP 1 500V 0.25PF 4.7PF	5322 122 33082
C121	CER CAP 1 500V 2% 33PF	4822 122 31202
C122	CER CAP 1 500V 0.25PF 4.7PF	5322 122 33082
C123	CER CAP 1 500V 0.25PF 4.7PF	5322 122 33082
C124	CER CAP 1 500V 2% 33PF	4822 122 31202
C131	CER CHIP CAP 63V 0.25PF 0.82PF	5322 126 10786
C132	CER CHIP CAP 63V 0.25PF 4.7PF	5322 122 32287

Reference Designator	Description	Ordering Code
C133	CER CHIP CAP 63V 5% 47PF	5322 122 32452
C134	CER CHIP CAP 63V 5% 470PF	5322 122 32268
C136	CER CHIP CAP 63V 10% 4.7NF	5322 126 10223
C142	CHIPCAP NP0 0805 5% 1NF	5322 126 10511
C145	CHIPCAP NP0 0805 5% 1NF	5322 126 10511
C146	CHIPCAP NP0 0805 5% 1NF	5322 126 10511
C148	CHIPCAP X7R 0805 10% 10NF	5322 122 34098
C152	CERCAP X7R 0805 10% 15NF	4822 122 33128
C153	CHIPCAP X7B 0805 10% 22NF	5322 122 32654
C156	CHIPCAP NP0 0805 5% 1NF	5322 126 10511
C158	CER CHIP CAP 63V 5% 150PF	5322 122 33538
C159	CHIPCAP NPO 0805 5% 100PF	5322 122 32531
C161	CER CHIPCAP 25V 20% 100NF	5322 126 13638
C162	CER CHIP CAP 63V 0.25PF 4.7PF	5322 122 32287
C181	ALCAP SANYO 10V 20% 22UF	5322 124 11837
C182	CER CHIPCAP 25V 20% 100NF	5322 126 13638
C183	ALCAP SANYO 10V 20% 22UF	5322 124 11837
C184	CER CHIPCAP 25V 20% 100NF	5322 126 13638
C186	CER CHIPCAP 25V 20% 100NF	5322 126 13638
C187	ALCAP SANYO 10V 20% 22UF	5322 124 11837
C188	CER CHIPCAP 25V 20% 100NF	5322 126 13638
C189	CER CHIPCAP 25V 20% 100NF	5322 126 13638
C190	CER CHIPCAP 25V 20% 100NF	5322 126 13638
C191	CER CHIPCAP 25V 20% 100NF	5322 126 13638
C199	CER CHIP CAP 63V 5% 470PF	5322 122 32268
C201	MKC FILM CAP 630V 10% 22NF	5322 121 10616
C202	SUPPR CAPACITOR 0.1 UF	5322 121 10527
C204	CER.CAP. 3.15KV +-5% 120PF	5322 126 14046
C206	CER.CAP. 1KV -20+80% 4.7NF	5322 126 13825
C207	CER CHIP CAP 63V 5% 470PF	5322 122 32268
C211	CER CAP 1 500V 0.25PF 4.7PF	5322 122 33082
C231	CER CHIP CAP 63V 0.25PF 0.68PF	4822 126 12342
C232	CER CHIP CAP 63V 0.25PF 4.7PF	5322 122 32287

Reference Designator	Description	Ordering Code
C233	CER CHIP CAP 63V 5% 47PF	5322 122 32452
C234	CER CHIP CAP 63V 5% 470PF	5322 122 32268
C236	CER CHIP CAP 63V 10% 4.7NF	5322 126 10223
C242	CHIPCAP NP0 0805 5% 1NF	5322 126 10511
C246	CC 33NF 10% 0805 X7R 50V	5322 126 14486
C248	CHIPCAP X7R 0805 10% 10NF	5322 122 34098
C252	CERCAP X7R 0805 10% 15NF	4822 122 33128
C253	CHIPCAP X7B 0805 10% 22NF	5322 122 32654
C256	CHIPCAP NP0 0805 5% 1NF	5322 126 10511
C258	CER CHIP CAP 63V 5% 150PF	5322 122 33538
C259	CHIPCAP NPO 0805 5% 100PF	5322 122 32531
C261	CER CHIPCAP 25V 20% 100NF	5322 126 13638
C262	CER CHIP CAP 63V 0.25PF 4.7PF	5322 122 32287
C281	ALCAP SANYO 10V 20% 22UF	5322 124 11837
C282	CER CHIPCAP 25V 20% 100NF	5322 126 13638
C283	ALCAP SANYO 10V 20% 22UF	5322 124 11837
C284	CER CHIPCAP 25V 20% 100NF	5322 126 13638
C286	CER CHIPCAP 25V 20% 100NF	5322 126 13638
C287	ALCAP SANYO 10V 20% 22UF	5322 124 11837
C288	CER CHIPCAP 25V 20% 100NF	5322 126 13638
C289	CER CHIPCAP 25V 20% 100NF	5322 126 13638
C290	CER CHIPCAP 25V 20% 100NF	5322 126 13638
C291	CER CHIPCAP 25V 20% 100NF	5322 126 13638
C292	CC 10NF 2% 1210 NP0 50V	5322 126 14483
C293	CC 10NF 2% 1210 NP0 50V	5322 126 14483
C294	CC 100 NF 20% 0805 X7R 25V	5322 126 14484
C295	CC 0.56 PF 45% 0805 NP0 50V	5322 126 14485
C296	CC 100 NF 20% 0805 X7R 25V	5322 126 14484
C297	CC 100 NF 20% 0805 X7R 25V	5322 126 14484
C298	CC 10NF 2% 1210 NP0 50V	5322 126 14483
C301	CER CHIPCAP 25V 20% 100NF	5322 126 13638
C303	CER CHIPCAP 25V 20% 100NF	5322 126 13638
C306	CER CHIPCAP 25V 20% 100NF	5322 126 13638

Reference Designator	Description	Ordering Code
C311	CER CHIPCAP 25V 20% 100NF	5322 126 13638
C312	CER CHIPCAP 25V 20% 100NF	5322 126 13638
C313	ALCAP SANYO 25V 20% 10UF	5322 124 11838
C314	ALCAP SANYO 25V 20% 10UF	5322 124 11838
C317	ALCAP NICHICON 6.3V 20% 22UF	4822 124 80675
C321	CER CHIP CAP 63V 10% 1.5NF	5322 122 31865
C322	CER CHIP CAP 63V 10% 1.5NF	5322 122 31865
C331	CER CHIP CAP 63V 0.25PF 4.7PF	5322 122 32287
C332	CER CHIP CAP 63V 5% 22PF	5322 122 32658
C333	CER CHIP CAP 63V 0.25PF 1PF	5322 122 32447
C337	CER CHIP CAP 63V 0.25PF 4.7PF	5322 122 32287
C339	CER CHIP CAP 63V 0.25PF 1PF	5322 122 32447
C342	CER CHIP CAP 63V 0.25PF 1PF	5322 122 32447
C344	CER CHIP CAP 63V 5% 22PF	5322 122 32658
C356	MKPS FILM CAP 25V 10% 15NF	5322 121 10834
C357	CHIPCAP X7B 0805 10% 22NF	5322 122 32654
C376	CER CHIPCAP 25V 20% 100NF	5322 126 13638
C377	CER CHIPCAP 25V 20% 100NF	5322 126 13638
C378	CER CHIPCAP 25V 20% 100NF	5322 126 13638
C379	CER CHIPCAP 25V 20% 100NF	5322 126 13638
C381	CER CHIPCAP 25V 20% 100NF	5322 126 13638
C382	CER CHIPCAP 25V 20% 100NF	5322 126 13638
C391	CER CHIPCAP 25V 20% 100NF	5322 126 13638
C392	ALCAP NICHICON 16V 10UF	5322 124 41979
C393	CER CHIPCAP 25V 20% 100NF	5322 126 13638
C394	CER CHIPCAP 25V 20% 100NF	5322 126 13638
C395	CHIPCAP NP0 0805 5% 1NF	5322 126 10511
C396	CER CHIPCAP 25V 20% 100NF	5322 126 13638
C397	CER CHIPCAP 25V 20% 100NF	5322 126 13638
C398	CER CHIPCAP 25V 20% 100NF	5322 126 13638
C399	CER CHIPCAP 25V 20% 100NF	5322 126 13638
C400	CHIPCAP X7B 0805 10% 22NF	5322 122 32654
C401	CER CHIP CAP 63V 0.25PF 4.7PF	5322 122 32287

Reference Designator	Description	Ordering Code
C402	CER CHIPCAP 25V 20% 100NF	5322 126 13638
C403	CER CHIPCAP 25V 20% 100NF	5322 126 13638
C404	CER CHIP CAP 63V 5% 470PF	5322 122 32268
C407	CER CHIPCAP 25V 20% 100NF	5322 126 13638
C408	CER CHIPCAP 25V 20% 100NF	5322 126 13638
C409	CHIPCAP X7B 0805 10% 22NF	5322 122 32654
C416	CER CHIPCAP 25V 20% 100NF	5322 126 13638
C431	CER CHIPCAP 25V 20% 100NF	5322 126 13638
C432	CER CHIPCAP 25V 20% 100NF	5322 126 13638
C433	CHIPCAP X7B 0805 10% 22NF	5322 122 32654
C434	CHIPCAP X7B 0805 10% 22NF	5322 122 32654
C436	CER CAP X5R 1206 10% 1UF	5322 126 14089
C438	CER CHIP CAP 63V 10% 4.7NF	5322 126 10223
C439	CER CHIP CAP 63V 10% 4.7NF	5322 126 10223
C441	CHIPCAP X7B 0805 10% 22NF	5322 122 32654
C442	CHIPCAP X7B 0805 10% 22NF	5322 122 32654
C451	CER CHIP CAP 63V 0.25PF 4.7PF	5322 122 32287
C452	CER CHIPCAP 25V 20% 100NF	5322 126 13638
C453	CER CHIPCAP 25V 20% 100NF	5322 126 13638
C457	CER CHIPCAP 25V 20% 100NF	5322 126 13638
C458	CER CHIPCAP 25V 20% 100NF	5322 126 13638
C463	CER CHIPCAP 25V 20% 100NF	5322 126 13638
C464	CER CHIPCAP 25V 20% 100NF	5322 126 13638
C465	ALCAP NICHICON 16V 10UF	5322 124 41979
C466	CER CHIPCAP 25V 20% 100NF	5322 126 13638
C470	CER CHIP CAP 470 PF 5% 0805 NP0 50V	4022 301 60371
C471	CER CHIPCAP 25V 20% 100NF	5322 126 13638
C472	CER CHIPCAP 25V 20% 100NF	5322 126 13638
C473	CER CHIPCAP 25V 20% 100NF	5322 126 13638
C474	CER CHIPCAP 25V 20% 100NF	5322 126 13638
C475	CER CHIPCAP 25V 20% 100NF	5322 126 13638
C476	CER CHIPCAP 100NF 10% 0805 NP0 50V	4022 301 61331
C479	CER CHIP CAP 63V 5% 22PF	5322 122 32658
C480	CER CHIPCAP 25V 20% 100NF	5322 126 13638

Reference Designator	Description	Ordering Code
C481	CER CHIP CAP 63V 5% 22PF	5322 122 32658
C482	CER CHIP CAP 63V 5% 22PF	5322 122 32658
C483	CER CHIP CAP 63V 5% 22PF	5322 122 32658
C484	CER CHIP CAP 63V 5% 22PF	5322 122 32658
C485	CER CHIP CAP 63V 5% 27PF	5322 122 31946
C486	CER CHIP CAP 63V 5% 27PF	5322 122 31946
C487	CHIPCAP NPO 0805 5% 100PF	5322 122 32531
C488	CHIPCAP NPO 0805 5% 100PF	5322 122 32531
C489	CHIPCAP X7B 0805 10% 22NF	5322 122 32654
C500	1UF CERCAP Y5V 1206 10%	5322 126 14086
C501	ELCAP 25V 20% 180UF	5322 124 11843
C502	ALCAP NICHICON 25V 20% 10UF	5322 124 11839
C503	ELCAP 10V 20% 390UF	5322 124 11844
C504	ALCAP NICHICON 16V 10UF	5322 124 41979
C505	CER CHIPCAP 25V 20% 100NF	5322 126 13638
C506	CER CHIP CAP 25V 20% 47NF	5322 126 14045
C507	CER CHIPCAP 25V 20% 100NF	5322 126 13638
C509	CER CAP X5R 1206 10% 1UF	5322 126 14089
C511	CER CHIPCAP 25V 20% 100NF	5322 126 13638
C512	CER CHIPCAP 25V 20% 100NF	5322 126 13638
C528	ALCAP NICHICON 6.3V 20% 22UF	4822 124 80675
C529	CER CHIPCAP 25V 20% 100NF	5322 126 13638
C531	CHIPCAP X7B 0805 10% 22NF	5322 122 32654
C532	CHIPCAP X7B 0805 10% 22NF	5322 122 32654
C534	CER CHIPCAP 25V 20% 100NF	5322 126 13638
C547	CHIPCAP X7B 0805 10% 22NF	5322 122 32654
C548	CHIPCAP X7B 0805 10% 22NF	5322 122 32654
C549	CHIPCAP X7B 0805 10% 22NF	5322 122 32654
C550	CER CHIP CAP 63V 10% 4.7NF	5322 126 10223
C551	CER CHIPCAP 25V 20% 100NF	5322 126 13638
C552	CER CHIPCAP 25V 20% 100NF	5322 126 13638
C553	CER CHIP CAP 63V 5% 150PF	5322 122 33538
C554	CER CAP X5R 1206 10% 1UF	5322 126 14089

Reference Designator	Description	Ordering Code
C555	ELCAP 10V 20% 390UF	5322 124 11844
C561	ALCAP SANYO 6,3V 20% 150UF	5322 124 11841
C562	ALCAP SANYO 6,3V 20% 150UF	5322 124 11841
C563	ALCAP SANYO 6,3V 20% 150UF	5322 124 11841
C564	ALCAP SANYO 35V 20% 47UF	5322 124 11842
C565	ALCAP SANYO 6,3V 20% 150UF	5322 124 11841
C567	ALCAP SANYO 6,3V 20% 150UF	5322 124 11841
C568	ALCAP SANYO 6,3V 20% 150UF	5322 124 11841
C572	ALCAP SANYO 6,3V 20% 150UF	5322 124 11841
C573	ALCAP SANYO 6,3V 20% 150UF	5322 124 11841
C574	ALCAP SANYO 6,3V 20% 150UF	5322 124 11841
C576	ALCAP SANYO 6,3V 20% 150UF	5322 124 11841
C583	CER CHIPCAP 25V 20% 100NF	5322 126 13638
C591	CER CHIPCAP 25V 20% 100NF	5322 126 13638
C592	CER CHIPCAP 25V 20% 100NF	5322 126 13638
C593	CER CHIPCAP 25V 20% 100NF	5322 126 13638
C594	CER CHIPCAP 25V 20% 100NF	5322 126 13638
C602	CER CHIP CAP 25V 20% 47NF	5322 126 14045
C603	CER CHIPCAP 25V 20% 100NF	5322 126 13638
C604	CER CAP X5R 1206 10% 1UF	5322 126 14089
C605	CHIPCAP NP0 0805 5% 1NF	5322 126 10511
C606	CER CHIPCAP 25V 20% 100NF	5322 126 13638
C607	CHIPCAP X7R 0805 10% 10NF	5322 122 34098
C608	MKT FILM CAP 63V 10% 100NF	5322 121 42386
C609	CER.CAP. 2KV +-5% 33PF	5322 126 14047
C610	CER CAP X5R 1206 10% 1UF	5322 126 14089
D401 *	LOW VOLT ADC TDA8792M/C2/R1	5322 209 14837
D451 *	LOW VOLT ADC TDA8792M/C2/R1	5322 209 14837
D471 *	D-ASIC MOT0002	5322 209 13139
D474 *	8M FEPRAM AM29LV800B-120EC	5322 209 15199
D475 *	K6T4008V16 (RAM 512 x 8)	4022 304 11601

Reference Designator	Description	Ordering Code
D480	4X2-INP OR 74LVC32APW	4022 304 10771
D531 *	8-INP MUX 74HC4051D PEL	9337 148 20653
H495	PE BUZZER PKM13EPP-4002 MUR	5322 280 10311
H521	IR LED SFH409-2 SIE	5322 130 61296
H522	PHOTODIODE OP906 OPT	5322 130 10777
K171	DPDT RELAY ASL-1.5W-K-B05	5322 280 10309
K173	DPDT RELAY DSP1-L-1,5V MAT	5322 280 10312
K271	DPDT RELAY ASL-1.5W-K-B05	5322 280 10309
L181	CHIP INDUCT. 47UH 10% TDK	4822 157 70794
L182	CHIP INDUCT. 47UH 10% TDK	4822 157 70794
L183	CHIP INDUCT. 47UH 10% TDK	4822 157 70794
L281	CHIP INDUCT. 47UH 10% TDK	4822 157 70794
L282	CHIP INDUCT. 47UH 10% TDK	4822 157 70794
L283	CHIP INDUCT. 47UH 10% TDK	4822 157 70794
L481	CHIP INDUCT. 47UH 10% TDK	4822 157 70794
L501	CHOKE 33UH TDK	5322 157 10994
L562	CHIP INDUCT. 47UH 10% TDK	4822 157 70794
L563	CHIP INDUCT. 47UH 10% TDK	4822 157 70794
L564	FIXED INDUCOR 68UH 10% TDK	5322 157 10995
L566	FIXED INDUCOR 68UH 10% TDK	5322 157 10995
L567	CHIP INDUCT. 47UH 10% TDK	4822 157 70794
L569	FIXED INDUCOR 68UH 10% TDK	5322 157 10995
L600	SHIELDED CHOKE 150UH TDK	5322 157 10996
N101 *	C-ASIC OQ0258	5322 209 13141
N201 *	C-ASIC OQ0258	5322 209 13141
N202 *	LOW POW OPAMP LM7301IMX	5322 209 16799

Reference Designator	Description	Ordering Code
N301 *	T-ASIC OQ0257	5322 209 13142
N501 *	P-ASIC OQ0256	5322 209 13143
N531 *	LOW POW OPAMP LMC7101BIM5X NSC	5322 209 15144
N600 *	LAMP CONTROLLER UC3872DW UNI	5322 209 14851
R1	MTL FILM RST MRS25 1% 220K 0.25W	4822 053 20224
R2	MTL FILM RST MRS25 1% 220K 0.25W	4822 053 20224
R101	MTL FILM RST MRS25 1% 487K	4822 050 24874
R102	MTL FILM RST MRS25 1% 487K	4822 050 24874
R103	RESISTOR CHIP RC12H 1% 1M	4822 117 11948
R104	RESISTOR CHIP RC12H 1% 26K1	5322 117 12448
R105	RESISTOR CHIP RC12H 1% 511E	5322 117 12451
R106	PTC THERM DISC 600V 300-500E	5322 116 40274
R108	RESISTOR CHIP RC12H 1% 511E	5322 117 12451
R109	RESISTOR CHIP RC12H 1% 2K15	5322 117 12452
R110	RESISTOR CHIP RC12H 1% 2K15	5322 117 12452
R111	RESISTOR CHIP RC11 2% 10M	4822 051 20106
R112	RESISTOR CHIP RC11 2% 10M	4822 051 20106
R113	RESISTOR CHIP RC11 2% 10M	4822 051 20106
R114	RESISTOR CHIP RC11 2% 10M	4822 051 20106
R116	RESISTOR CHIP RC12H 1% 215E	5322 117 12453
R117	RESISTOR CHIP RC12H 1% 215E	5322 117 12453
R118	RESISTOR CHIP RC12H 1% 68E1	5322 117 12454
R119	RESISTOR CHIP RC12H 1% 464E	5322 117 12455
R120	RESISTOR CHIP RC11 2% 10M	4822 051 20106
R121	RESISTOR CHIP RC12H 1% 68E1	5322 117 12454
R125	RESISTOR CHIP RC12H 1% 68E1	5322 117 12454
R131	RESISTOR CHIP RC12G 1% 1M	5322 117 12484
R132	RESISTOR CHIP RC12G 1% 100K	5322 117 12485
R133	RESISTOR CHIP RC12G 1% 10K	5322 117 12486
R134	RESISTOR CHIP RC12G 1% 1K	5322 117 12487
R136	RESISTOR CHIP RC-02G 1% 100E	4822 051 51001

Reference Designator	Description	Ordering Code
R137	RESISTOR CHIP RC-02H 1% 56K2	5322 117 10574
R138	RESISTOR CHIP RC-02H 1% 56K2	5322 117 10574
R139	RESISTOR CHIP RC-02H 1% 56K2	5322 117 10574
R140	RESISTOR CHIP RC-02H 1% 56K2	5322 117 10574
R141	RESISTOR CHIP RC12G 1% 215K	5322 117 12488
R142	RESISTOR CHIP RC12G 1% 147K	5322 117 12489
R143	RESISTOR CHIP RC12G 1% 909K	5322 117 12491
R144	RESISTOR CHIP RC12H 1% 348E	5322 117 12456
R146	RESISTOR CHIP RC12H 1% 215K	5322 117 12457
R151	RESISTOR CHIP RC12H 1% 100K	5322 117 12458
R152	RESISTOR CHIP RC12H 1% 100K	5322 117 12485
R153	RESISTOR CHIP RC12H 1% 681K	5322 117 12485
R154	RESISTOR CHIP RC12H 1% 681K	5322 117 12458
R155	RESISTOR CHIP RC12H 1% 178K	5322 117 12459
R156	RESISTOR CHIP RC12G 1% 100K	5322 117 12485
R157	RESISTOR CHIP RC12H 1% 348E	5322 117 12456
R158	RESISTOR CHIP RC12H 1% 287E	5322 117 12461
R159	RESISTOR CHIP RC12H 1% 100E	4822 117 11373
R160	RESISTOR CHIP RC12H 1% 51K1	5322 117 12462
R161	RESISTOR CHIP RC12G 1% 100K	5322 117 12485
R165	RESISTOR CHIP RC12H 1% 100E	4822 117 11373
R171	RESISTOR CHIP RC12H 1% 348E	5322 117 12456
R172	PTC THERM DISC 600V 300-500E	5322 116 40274
R173	RESISTOR CHIP RC12H 1% 348E	5322 117 12456
R182	RESISTOR CHIP RC12H 1% 10E	5322 117 12464
R184	RESISTOR CHIP RC12H 1% 10E	5322 117 12464
R186	RESISTOR CHIP RC12H 1% 10E	5322 117 12464
R188	RESISTOR CHIP RC12H 1% 10E	5322 117 12464
R189	RESISTOR CHIP RC12H 1% 10E	5322 117 12464
R201	MTL FILM RST MRS25 1% 487K	4822 050 24874
R202	MTL FILM RST MRS25 1% 487K	4822 050 24874
R203	RESISTOR CHIP RC12H 1% 1M	4822 117 11948
R204	RESISTOR CHIP RC12H 1% 26K1	5322 117 12448

Reference Designator	Description	Ordering Code
R206	PTC THERM DISC 600V 300-500E	5322 116 40274
R209	RESISTOR CHIP RC12H 1% 2K15	5322 117 12452
R211	RESISTOR CHIP RC11 2% 10M	4822 051 20106
R212	RESISTOR CHIP RC11 2% 10M	4822 051 20106
R213	RESISTOR CHIP RC11 2% 10M	4822 051 20106
R214	RESISTOR CHIP RC11 2% 10M	4822 051 20106
R231	RESISTOR CHIP RC12G 1% 1M	5322 117 12484
R232	RESISTOR CHIP RC12G 1% 100K	5322 117 12485
R233	RESISTOR CHIP RC12G 1% 10K	5322 117 12486
R234	RESISTOR CHIP RC12G 1% 1K	5322 117 12487
R236	RESISTOR CHIP RC-02G 1% 100E	4822 051 51001
R237	SMDRES 261K 1% TC100 1206	5322 117 13485
R238	SMDRES 261K 1% TC100 1206	5322 117 13485
R239	SMDRES 261K 1% TC100 1206	5322 117 13485
R240	SMDRES 215K 1% TC100 1206	5322 117 13486
R241	RESISTOR CHIP RC12G 1% 215K	5322 117 12488
R242	RESISTOR CHIP RC12G 1% 147K	5322 117 12489
R243	RESISTOR CHIP RC12G 1% 909K	5322 117 12491
R246	SMDRES 1M 1% TC50 0805	5322 117 13487
R251	RESISTOR CHIP RC12H 1% 100K	5322 117 12485
R252	RESISTOR CHIP RC12H 1% 100K	5322 117 12485
R253	RESISTOR CHIP RC12H 1% 681K	5322 117 12458
R254	RESISTOR CHIP RC12H 1% 681K	5322 117 12458
R255	RESISTOR CHIP RC12H 1% 178K	5322 117 12459
R256	RESISTOR CHIP RC12G 1% 100K	5322 117 12485
R257	RESISTOR CHIP RC12H 1% 287E	5322 117 12461
R258	RESISTOR CHIP RC12H 1% 287E	5322 117 12461
R259	RESISTOR CHIP RC12H 1% 100E	4822 117 11373
R260	RESISTOR CHIP RC12H 1% 51K1	5322 117 12462
R261	RESISTOR CHIP RC12G 1% 100K	5322 117 12485
R271	RESISTOR CHIP RC12H 1% 348E	5322 117 12456
R282	RESISTOR CHIP RC12H 1% 10E	5322 117 12464
R284	RESISTOR CHIP RC12H 1% 10E	5322 117 12464
R286	RESISTOR CHIP RC12H 1% 10E	5322 117 12464

Reference Designator	Description	Ordering Code
R288	RESISTOR CHIP RC12H 1% 10E	5322 117 12464
R289	RESISTOR CHIP RC12H 1% 10E	5322 117 12464
R290	SMD RES 56K2 1% TC100 1206	5322 117 13488
R291	SMD RES 56K2 1% TC100 1206	5322 117 13488
R292	SMD RES 56K2 1% TC100 1206	5322 117 13488
R293	SMD RES 46K4 1% TC100 1206	5322 117 13489
R294	SMD RES 100K 1% TC50 0805	5322 117 13491
R295	SMD RES 215K 1% TC50 0805	5322 117 13492
R296	SMD RES 1M 1% TC50 0805	5322 117 13487
R297	SMD RES 10E 1% TC100 0805	5322 117 13493
R298	SMD RES 10E 1% TC100 0805	5322 117 13493
R301	RESISTOR CHIP RC12H 1% 3K16	5322 117 12465
R302	RESISTOR CHIP RC12H 1% 10K	4822 117 10833
R303	RESISTOR CHIP RC12H 1% 10K	4822 117 10833
R305	RESISTOR CHIP RC12H 1% 10K	4822 117 10833
R306	RESISTOR CHIP RC12G 1% 21K5	5322 117 12492
R307	RESISTOR CHIP RC12H 1% 10K	4822 117 10833
R308	RESISTOR CHIP RC12G 1% 21K5	5322 117 12492
R309	RESISTOR CHIP RC12H 1% 10K	4822 117 10833
R310	RESISTOR CHIP RC12H 1% 100K	4822 117 10837
R311	RESISTOR CHIP RC12H 1% 31K6	5322 117 12466
R312	RESISTOR CHIP RC12H 1% 34K8	5322 117 12467
R321	RESISTOR CHIP RC12H 1% 681K	5322 117 12458
R322	RESISTOR CHIP RC12H 1% 681K	5322 117 12458
R323	RESISTOR CHIP RC12H 1% 34K8	5322 117 12467
R324	RESISTOR CHIP RC12H 1% 215K	5322 117 12457
R326	RESISTOR CHIP RC12H 1% 562K	5322 117 12468
R327	RESISTOR CHIP RC12H 1% 562K	5322 117 12468
R331	RESISTOR CHIP RC12H 1% 10K	4822 117 10833
R333	RESISTOR CHIP RC12H 1% 10K	4822 117 10833
R337	RESISTOR CHIP RC12H 1% 10K	4822 117 10833
R339	RESISTOR CHIP RC12H 1% 10K	4822 117 10833
R342	RESISTOR CHIP RC12H 1% 10K	4822 117 10833

Reference Designator	Description	Ordering Code
R352	RESISTOR CHIP RC12H 1% 5K11	5322 117 12469
R353	RESISTOR CHIP RC12H 1% 1K	4822 117 11154
R354	RESISTOR CHIP RC-02H 1% 261E	4822 051 52611
R356	RESISTOR CHIP RC-02H 1% 261E	4822 051 52611
R369	RESISTOR CHIP RC12H 1% 26K1	5322 117 12448
R371	RESISTOR CHIP RC12H 1% 0E	5322 117 12471
R375	RESISTOR CHIP RC12H 1% 0E	5322 117 12471
R376	RESISTOR CHIP RC12H 1% 10E	5322 117 12464
R377	RESISTOR CHIP RC12H 1% 1E	5322 117 12472
R378	RESISTOR CHIP RC12H 1% 10E	5322 117 12464
R381	RESISTOR CHIP RC12H 1% 10E	5322 117 12464
R385	RESISTOR CHIP RC12H 1% 0E	5322 117 12471
R393	RESISTOR CHIP RC12H 1% 10E	5322 117 12464
R394	RESISTOR CHIP RC12H 1% 1E	5322 117 12472
R395	RESISTOR CHIP RC12H 1% 0E	5322 117 12471
R396	RESISTOR CHIP RC12H 1% 10E	5322 117 12464
R397	RESISTOR CHIP RC12H 1% 1E	5322 117 12472
R398	RESISTOR CHIP RC12H 1% 1E	5322 117 12472
R399	RESISTOR CHIP RC12H 1% 10K	4822 117 10833
R403	RESISTOR CHIP RC12H 1% 21K5	5322 117 12477
R404	RESISTOR CHIP RC12H 1% 1E	5322 117 12472
R405	RESISTOR CHIP RC12H 1% 1K	4822 117 11154
R406	RESISTOR CHIP RC12H 1% 511E	5322 117 12451
R407	RESISTOR CHIP RC12H 1% 3K16	5322 117 12465
R408	RESISTOR CHIP RC11 2% 10M	4822 051 20106
R409	RESISTOR CHIP RC12H 1% 26K1	5322 117 12448
R410	RESISTOR CHIP RC12H 1% 68E1	5322 117 12454
R416	RESISTOR CHIP RC12H 1% 1E	5322 117 12472
R417	RESISTOR CHIP RC12H 1% 1E	5322 117 12472
R431	RESISTOR CHIP RC12H 1% 21K5	5322 117 12477
R432	RESISTOR CHIP RC12H 1% 147K	5322 117 12478
R433	RESISTOR CHIP RC12H 1% 147K	5322 117 12478
R434	RESISTOR CHIP RC12H 1% 147K	5322 117 12478

Reference Designator	Description	Ordering Code
R436	RESISTOR CHIP RC12H 1% 26K1	5322 117 12448
R438	RESISTOR CHIP RC12H 1% 147K	5322 117 12478
R439	RESISTOR CHIP RC12H 1% 21K5	5322 117 12477
R441	RESISTOR CHIP RC12H 1% 3K16	5322 117 12465
R442	RESISTOR CHIP RC12H 1% 1K47	5322 117 12479
R453	RESISTOR CHIP RC12H 1% 21K5	5322 117 12477
R454	RESISTOR CHIP RC12H 1% 1E	5322 117 12472
R466	RESISTOR CHIP RC12H 1% 1E	5322 117 12472
R467	RESISTOR CHIP RC12H 1% 1E	5322 117 12472
R469	RESISTOR CHIP RC12H 1% 100K	4822 117 10837
R470	RESISTOR CHIP RC12H 1% 0E	5322 117 12471
R471	RESISTOR CHIP RC12H 1% 1M	4822 117 11948
R472	RESISTOR CHIP RC12H 1% 1M	4822 117 11948
R473	RESISTOR CHIP RC12H 1% 100E	4822 117 11373
R474	RESISTOR CHIP RC12H 1% 100E	4822 117 11373
R478	RESISTOR CHIP RC12H 1% 10K	4822 117 10833
R479	RESISTOR CHIP RC12H 1% 51K1	5322 117 12462
R480	RESISTOR CHIP RC12H 1% 10K	4822 117 10833
R482	SMD RES 511E 1% TC100 0805	4022 301 21761
R483	SMD RES 51K1 1% TC100 0805	4022 301 22241
R485	RESISTOR CHIP RC12H 1% 10K	4822 117 10833
R486	RESISTOR CHIP RC12H 1% 10K	4822 117 10833
R489	RESISTOR CHIP RC12H 1% 0E	5322 117 12471
R491	RESISTOR CHIP RC12H 1% 51K1	5322 117 12462
R495	RESISTOR CHIP RC12H 1% 3K16	5322 117 12465
R496	RESISTOR CHIP RC12H 1% 3K16	5322 117 12465
R497	RESISTOR CHIP RC12H 1% 0E	5322 117 12471
R499	SMDRES 56K2 1% TC100 0805	5322 117 13494
R501	RESISTOR CHIP LRC01 5% 0E1	5322 117 11759
R502	RESISTOR CHIP RC12H 1% 10E	5322 117 12464
R503	RESISTOR CHIP RC12H 1% 10E	5322 117 12464
R504	RES FRC01 1206 5% 1E	4822 117 11151
R506	RES FRC01 1206 5% 1E	4822 117 11151

Reference Designator	Description	Ordering Code
R507	RES FRC01 1206 5% 1E	4822 117 11151
R508	RESISTOR CHIP RC12H 1% 10K	4822 117 10833
R509	RESISTOR CHIP RC12H 1% 46E4	5322 117 12463
R512	RESISTOR CHIP RC12H 1% 2K87	5322 117 12608
R513	RESISTOR CHIP RC12H 1% 26K1	5322 117 12448
R514	RESISTOR CHIP RC12H 1% 3K16	5322 117 12465
R516	RESISTOR CHIP RC12H 1% 23K7	5322 117 12481
R524	RESISTOR CHIP RC12H 1% 100E	4822 117 11373
R527	RESISTOR CHIP RC12H 1% 147E	5322 117 12482
R528	RESISTOR CHIP RC12H 1% 34K8	5322 117 12467
R529	RESISTOR CHIP RC12H 1% 261K	5322 117 12617
R531	RESISTOR CHIP RC12H 1% 21K5	5322 117 12477
R532	RESISTOR CHIP RC12H 1% 100E	4822 117 11373
R534	RESISTOR CHIP RC12H 1% 1K47	5322 117 12479
R535	RESISTOR CHIP RC12H 1% 51K1	5322 117 12462
R550	RESISTOR CHIP RC12H 1% 348E	5322 117 12456
R551	RESISTOR CHIP LRC01 5% 0E1	5322 117 11759
R552	RESISTOR CHIP RC12H 1% 10K	4822 117 10833
R553	RESISTOR CHIP RC12H 1% 4K22	5322 117 12476
R554	RESISTOR CHIP RC12H 1% 26K1	5322 117 12448
R555	RESISTOR CHIP RC12H 1% 10K	4822 117 10833
R558	RESISTOR CHIP RC12H 1% 31K6	5322 117 12466
R559	RESISTOR CHIP RC12H 1% 5K11	5322 117 12469
R561	RESISTOR CHIP RC12H 1% 100E	4822 117 11373
R562	RESISTOR CHIP RC12H 1% 100E	4822 117 11373
R563	RESISTOR CHIP RC12H 1% 100K	4822 117 10837
R564	RESISTOR CHIP RC12H 1% 100K	4822 117 10837
R565	RESISTOR CHIP RC12H 1% 100K	4822 117 10837
R570	RESISTOR CHIP RC12H 1% 100K	4822 117 10837
R580	RESISTOR CHIP LRC01 5% 0E33	5322 117 11725
R591	RESISTOR CHIP RC12H 1% 2K15	5322 117 12452
R600	RESISTOR CHIP RC12H 1% 5K11	5322 117 12469
R602	RESISTOR CHIP RC12H 1% 10K	4822 117 10833

Reference Designator	Description	Ordering Code
R603	RESISTOR CHIP RC12H 1% 100K	4822 117 10837
R604	RESISTOR CHIP RC12H 1% 1K	4822 117 11154
R605	SMD RES 10K 1% TC50 0805	4022 301 22071
R606	SMD RES 6K19 1% TC50 0805	4022 301 22021
T552	BACKLIGHT TRANSFORMER PT73458	5322 146 10447
T600	SMD TRANSFORMER 678XN-1081 TOK	5322 146 10634
V171 *	PNP/NPN TR.PAIR BCV65	5322 130 10762
V172 *	PNP/NPN TR.PAIR BCV65	5322 130 10762
V174 *	PNP/NPN TR.PAIR BCV65	5322 130 10762
V200	LF TRANSISTOR BC848C PEL	5322 130 42136
V201	LF TRANSISTOR BC848C PEL	5322 130 42136
V301 *	PREC.VOLT.REF. LM4041CIM-1.2 (2X4 PIN DIL PACK.)	5322 209 14852
V302*	PREC.VOLT.REF. LM4041CIM3X-1.2	4022 304 10571
V353 *	VOLT REG DIODE BZD27-C7V5 PEL	4822 130 82522
V354 *	VOLT REG DIODE BZD27-C7V5 PEL	4822 130 82522
V356 *	LF TRANSISTOR BC858C PEL	4822 130 42513
V358 *	LF TRANSISTOR BC868 PEL	5322 130 61569
V359 *	LF TRANSISTOR BC868 PEL	5322 130 61569
V395 *	LF TRANSISTOR BC848C PEL	5322 130 42136
V401 *	N-CHAN FET BSN20 PEL	5322 130 63289
V402 *	P-CHAN. MOSFET BSS84 PEL	5322 130 10669
V403 *	N-CHAN FET BSN20 PEL	5322 130 63289
V471*	SIL DIODE BAS85	4822 130 82334
V495 *	P-CHAN. MOSFET BSS84 PEL	5322 130 10669
V501 *	SCHOTTKY DIODE MBRS340T3 MOT	5322 130 10674
V503 *	SCHOTTKY DIODE MBRS340T3 MOT	5322 130 10674
V504 *	SCHOTTKY DIODE MBRS340T3 MOT	5322 130 10674
V506 *	POWER TMOS FET MTD5P06ET4 MOT	5322 130 10671
V550 *	RECT DIODE BYD77A	5322 130 10763

Reference Designator	Description	Ordering Code
V551 *	RECT DIODE BYD77A	5322 130 10763
V554 *	N-CHAN MOSFET 2SK974STR HIT	5322 130 62921
V555 *	RECT DIODE BYD77A	5322 130 10763
V561 *	SCHOTTKY DIODE MBRS340T3 MOT	5322 130 10674
V562 *	SCHOTTKY DIODE MBRS340T3 MOT	5322 130 10674
V563 *	SCHOTTKY DIODE MBRS340T3 MOT	5322 130 10674
V564 *	SCHOTTKY DIODE MBRS1100T3 MOT	5322 130 10675
V565 *	LF TRANSISTOR BC848C PEL	5322 130 42136
V566 *	LF TRANSISTOR BC848C PEL	5322 130 42136
V567 *	SCHOTTKY DIODE MBRS340T3 MOT	5322 130 10674
V569 *	LF TRANSISTOR BC869 PEL	4822 130 60142
V600 *	TMOS P-CH FET MMSF3P03HD MOT	5322 130 10672
V601 *	TMOS N-CH FET MMDF3N02HD MOT	5322 130 10673
V602 *	SCHOTTKY DIODE MBRS340T3 MOT	5322 130 10674
V603 *	SIL DIODE BAS16 PEL	5322 130 31928
V604 *	N-CHAN FET BSN20 PEL	5322 130 63289
V605 *	LF TRANSISTOR BC858C PEL	4822 130 42513
X452	FLEX-PRINT CONNECTOR 15-P FCN	5322 265 10725
X453	FLEX-PRINT CONNECTOR 21-P FCN	5322 265 10726
X501	DC POWER JACK HEC0739-01-010	4822 267 30431
X503	MALE HEADER 2MM 6-P DBL RT.ANG	5322 267 10501
X601	MALE HEADER 7-P SNG RT.ANG	5322 267 10502
Z501	EMI-FILTER 50V 10A MUR	5322 156 11139

8.6 Accessory Replacement Parts

Black ground lead for STL120

5322 320 11354

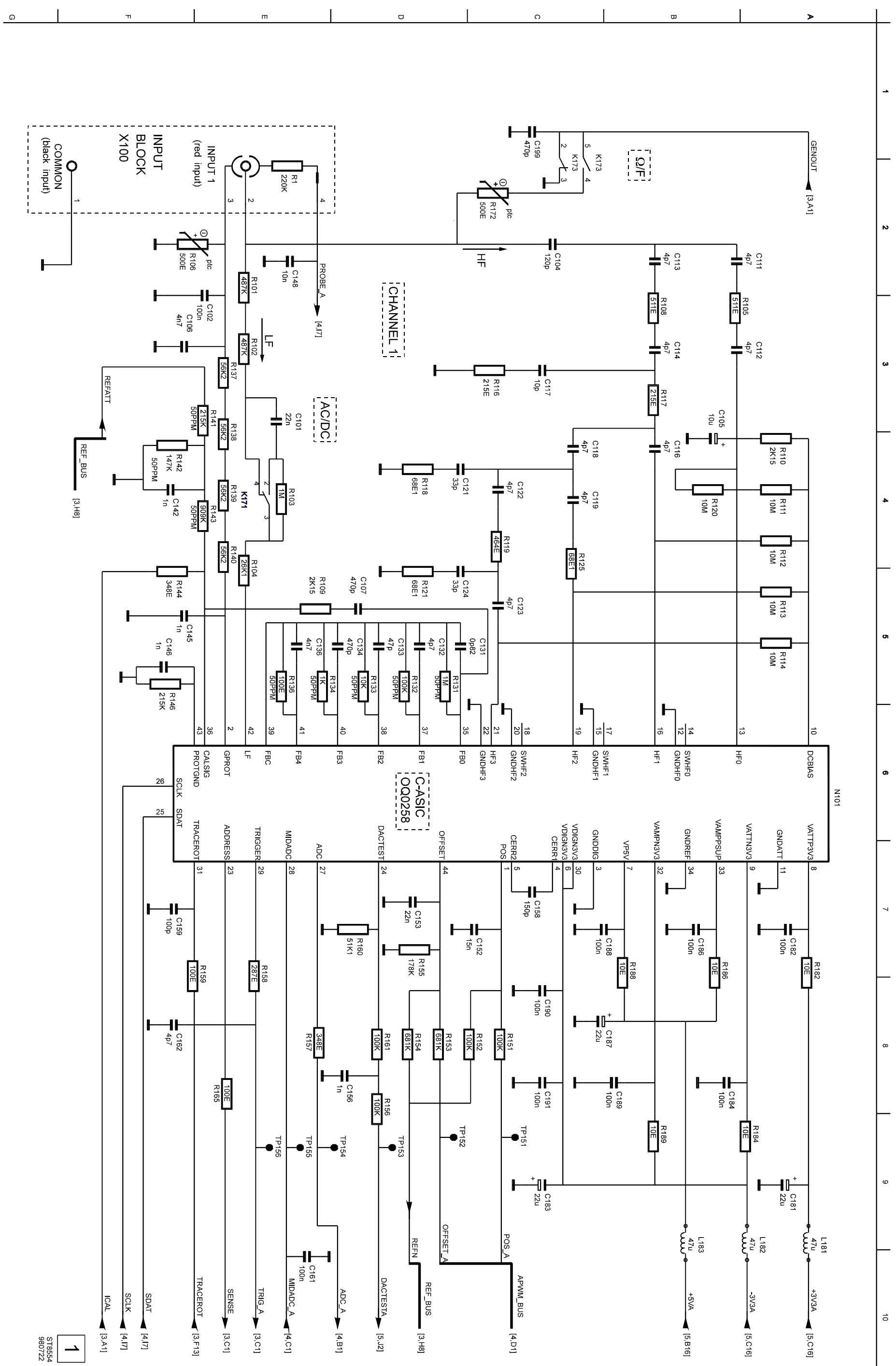

Figure 9-1. Circuit Diagram 1, Channel 1 Circuit

1
ST8554
980722

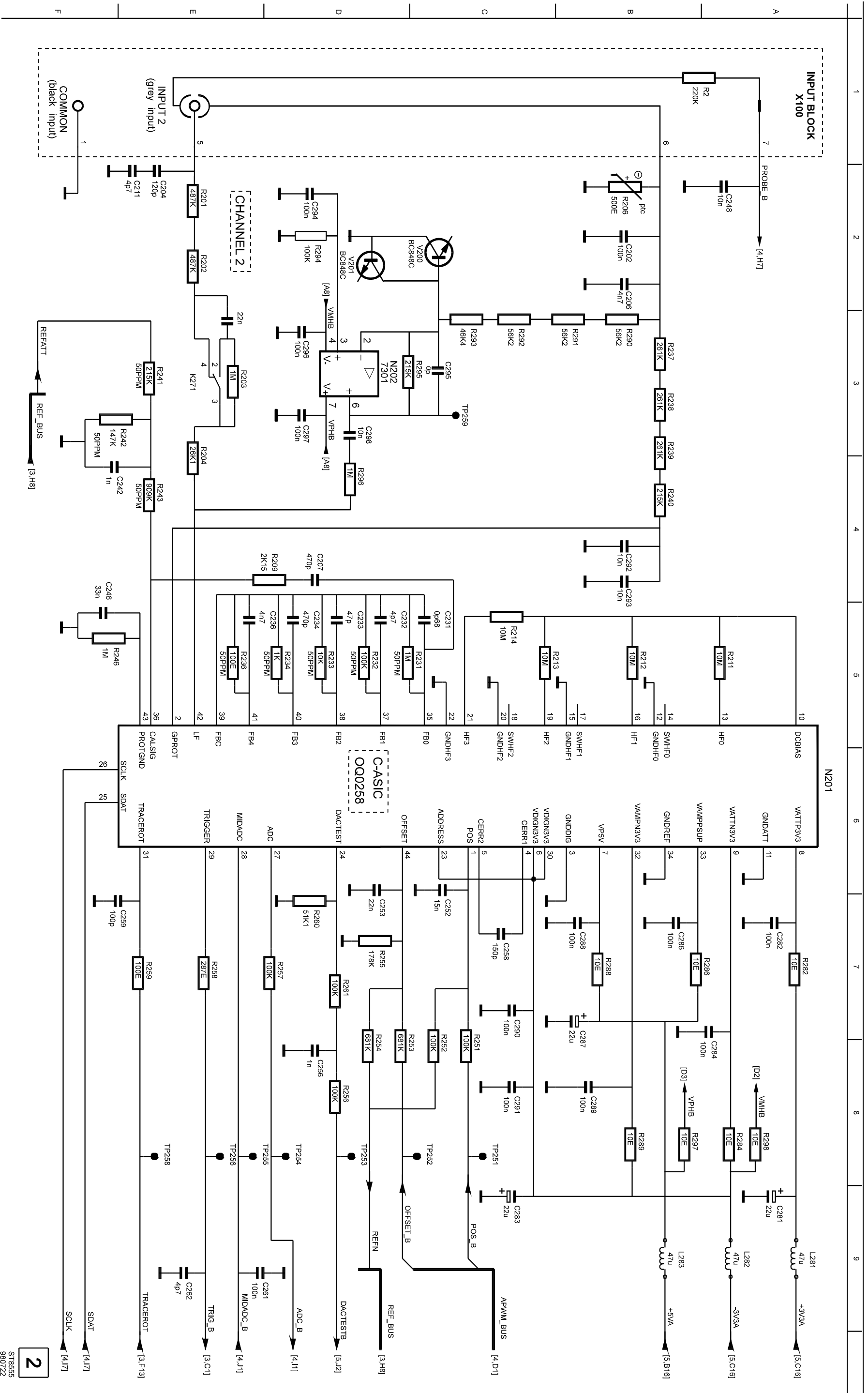

Figure 9-2. Circuit Diagram 2, Channel 2 Circuit

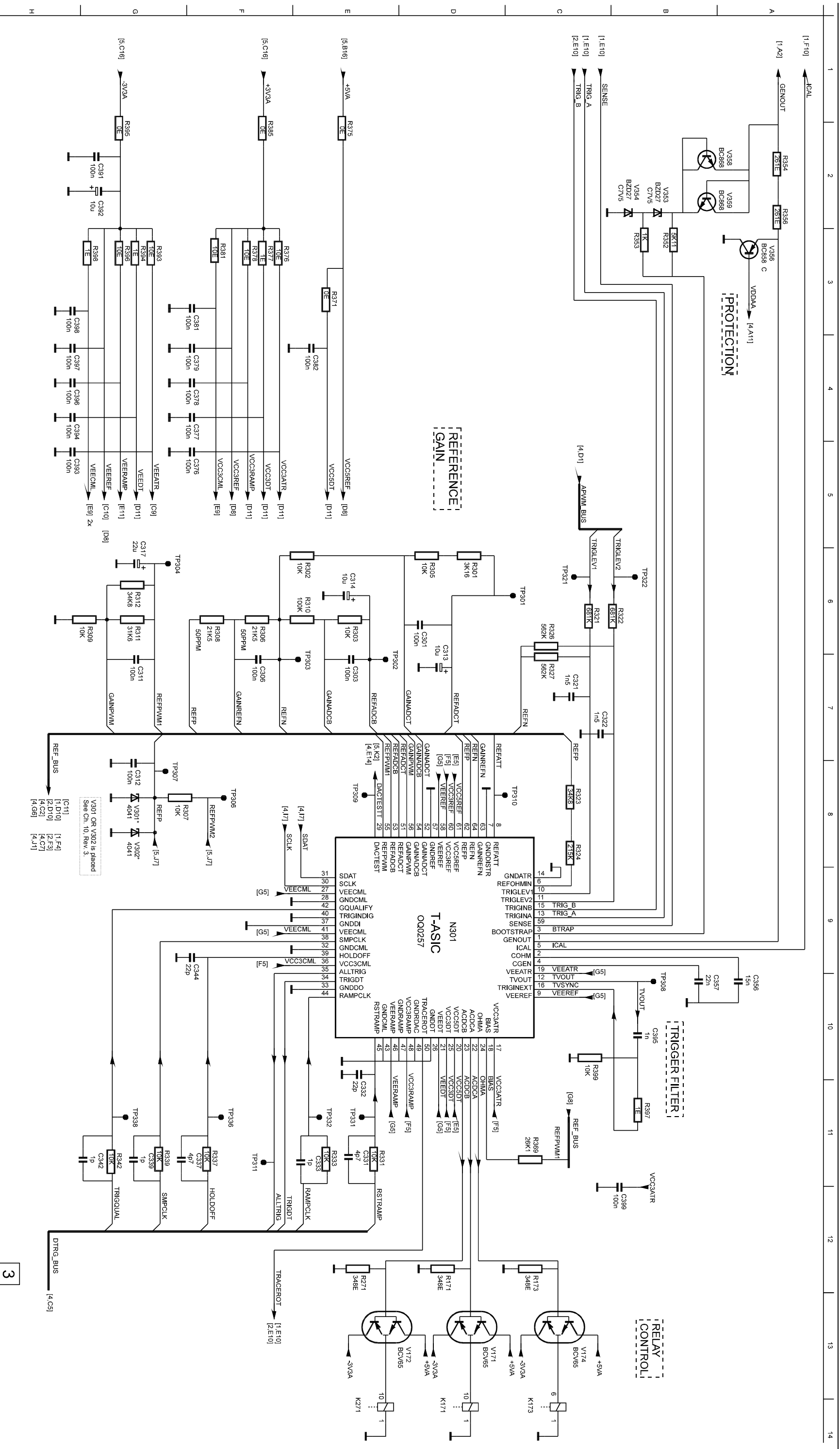

Figure 9-3. Circuit Diagram 3, Trigger Circuit

3

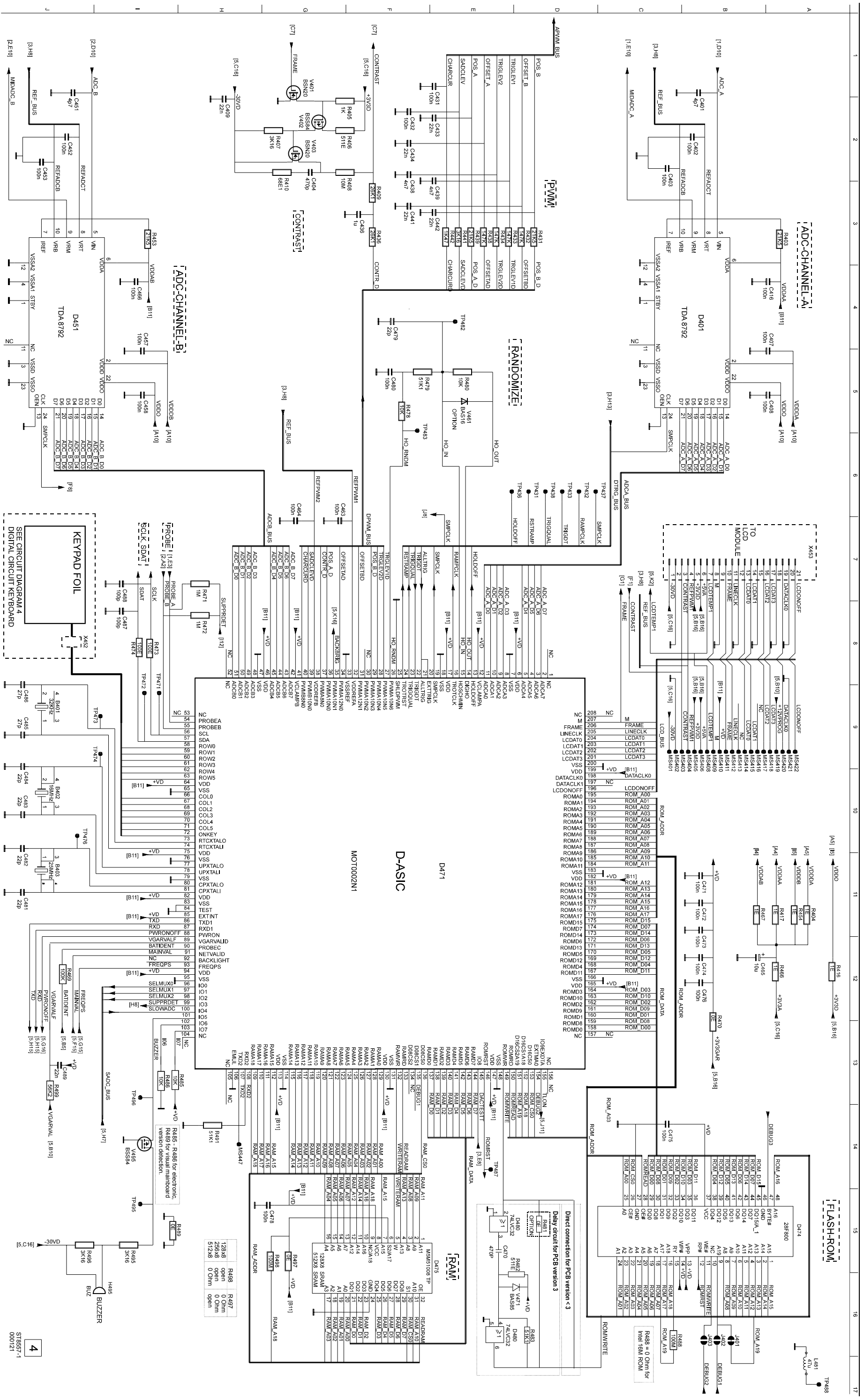
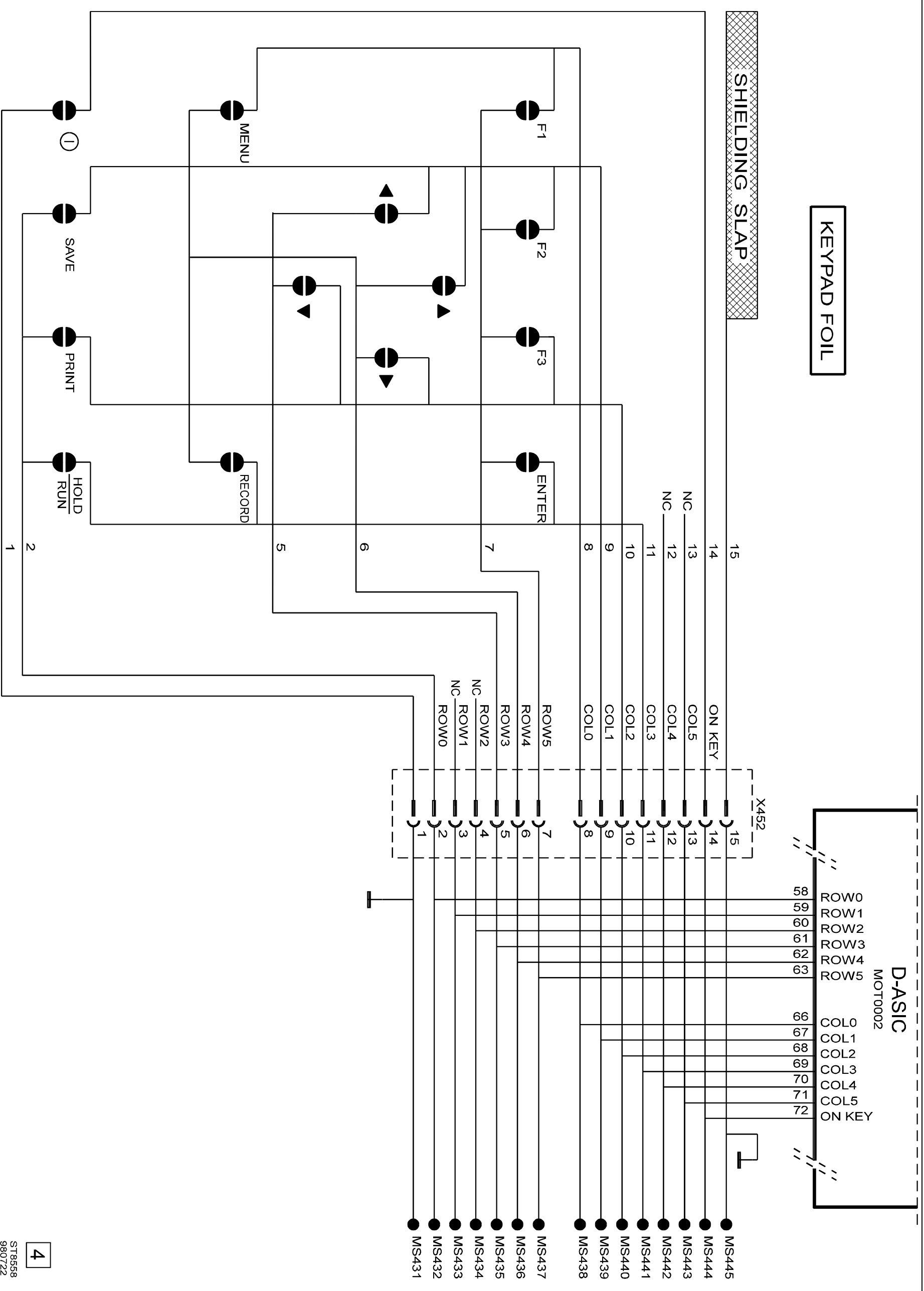

Figure 9-4. Circuit Diagram 4, Digital Circuit



4

ST8558
980722

Figure 9-5. Circuit Diagram 4 (cont), Digital Circuit Keyboard

ST8558 V.M.F.

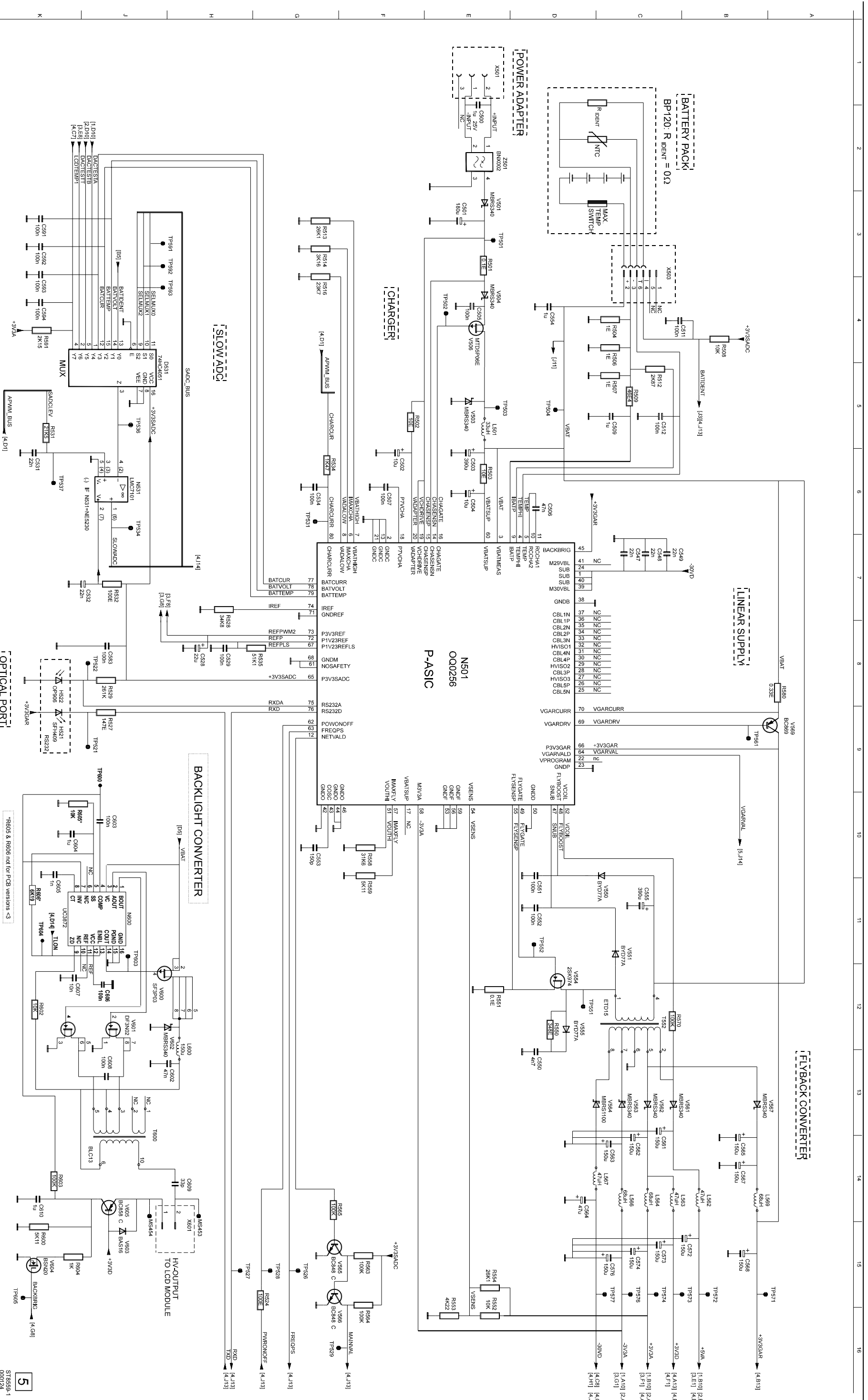

Figure 9-6. Circuit Diagram 5, Power Circuit

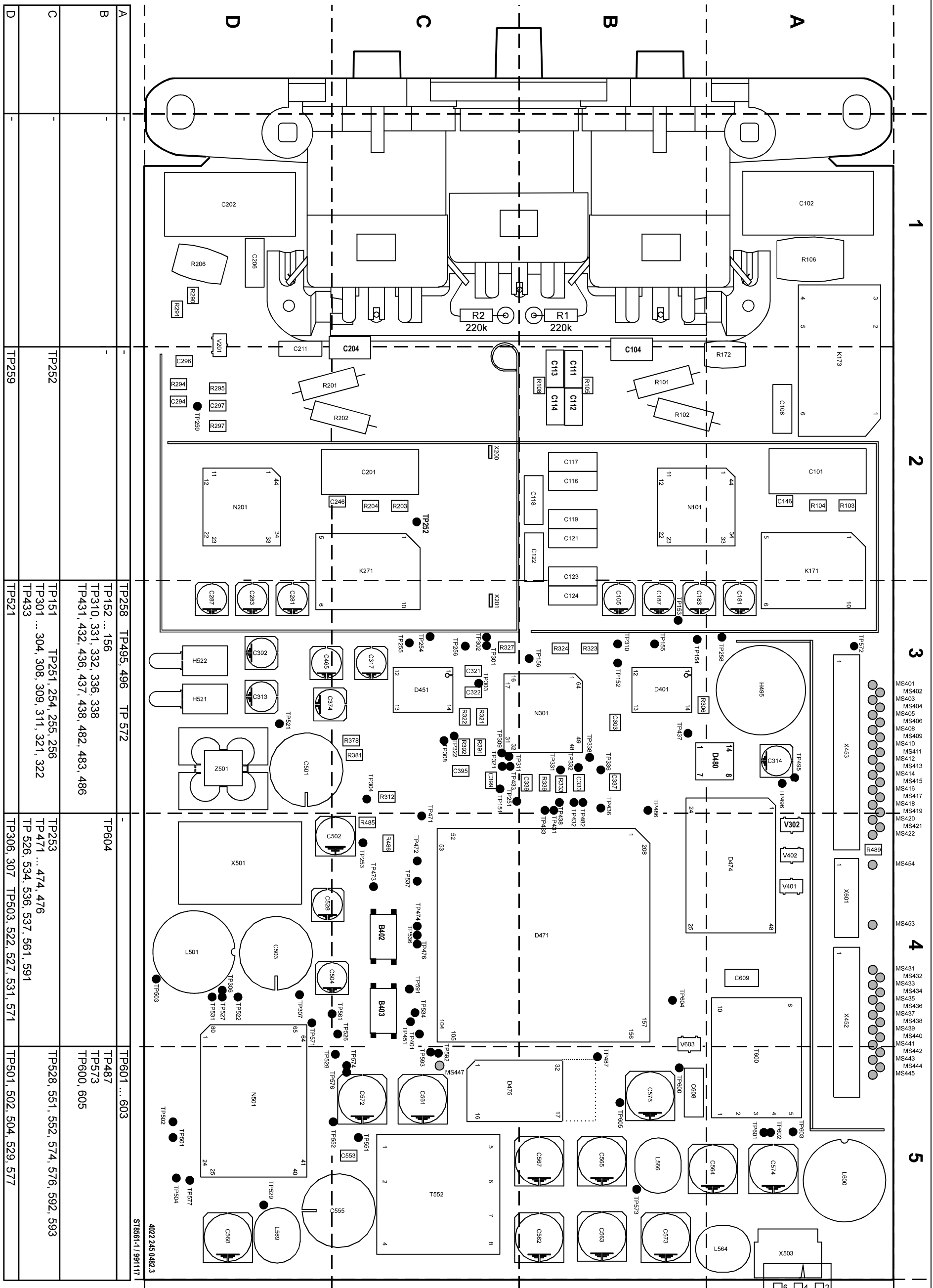

Figure 9-7. Main PCA side 1, PCB version 3

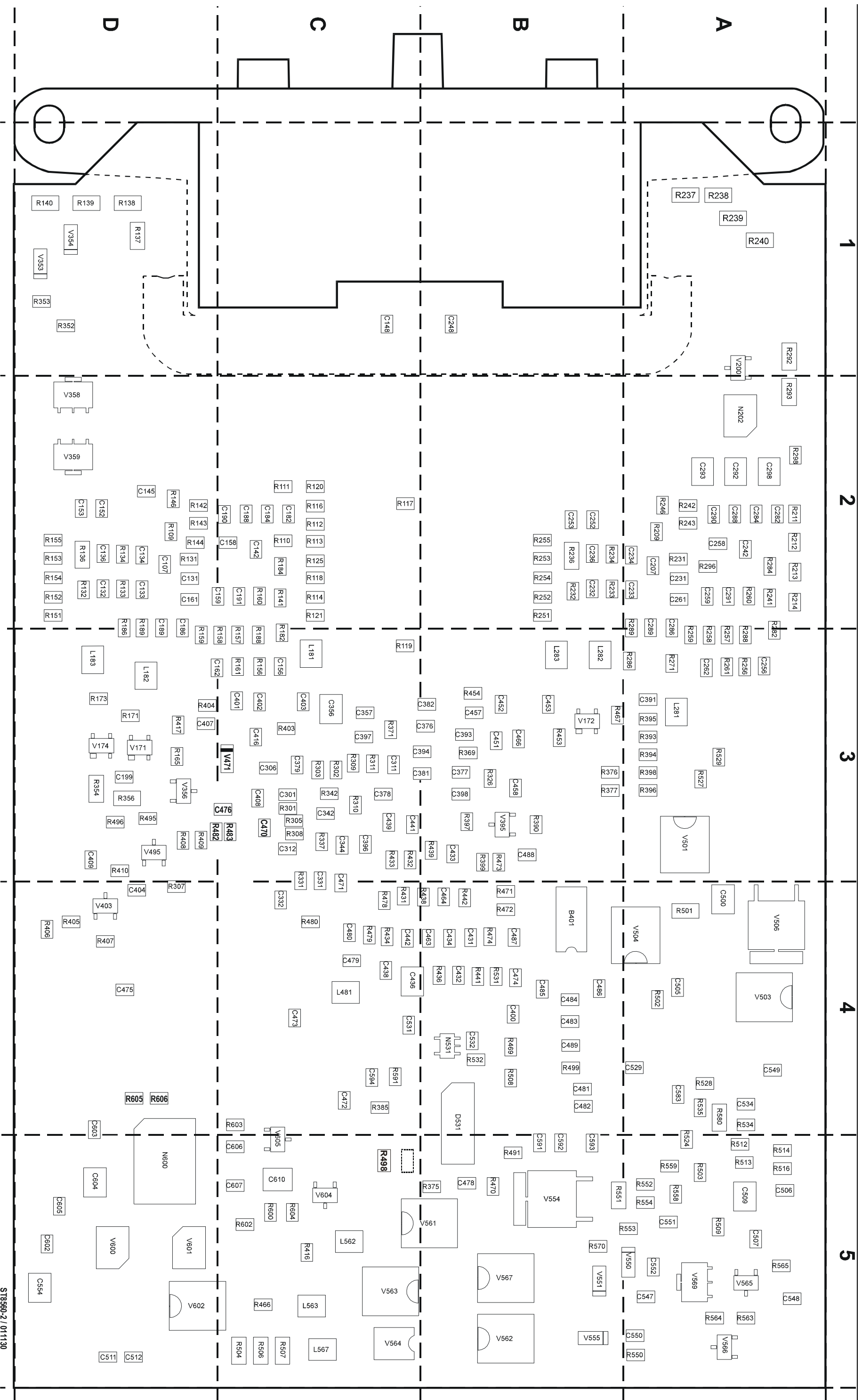

Figure 9-8. Main PCA side 2, PCB version 3

Chapter 9

Circuit Diagrams

Title	Page
9.1 Introduction.....	9-3
9.2 Schematic Diagrams.....	9-3

9.1 Introduction

This chapter contains all circuit diagrams and PCA drawings of the test tool. There are no serviceable parts on the LCD unit. Therefore no circuit diagrams and drawings of the LCD unit are provided.

Referring signals from one place to another in the circuit diagrams is done in the following way:

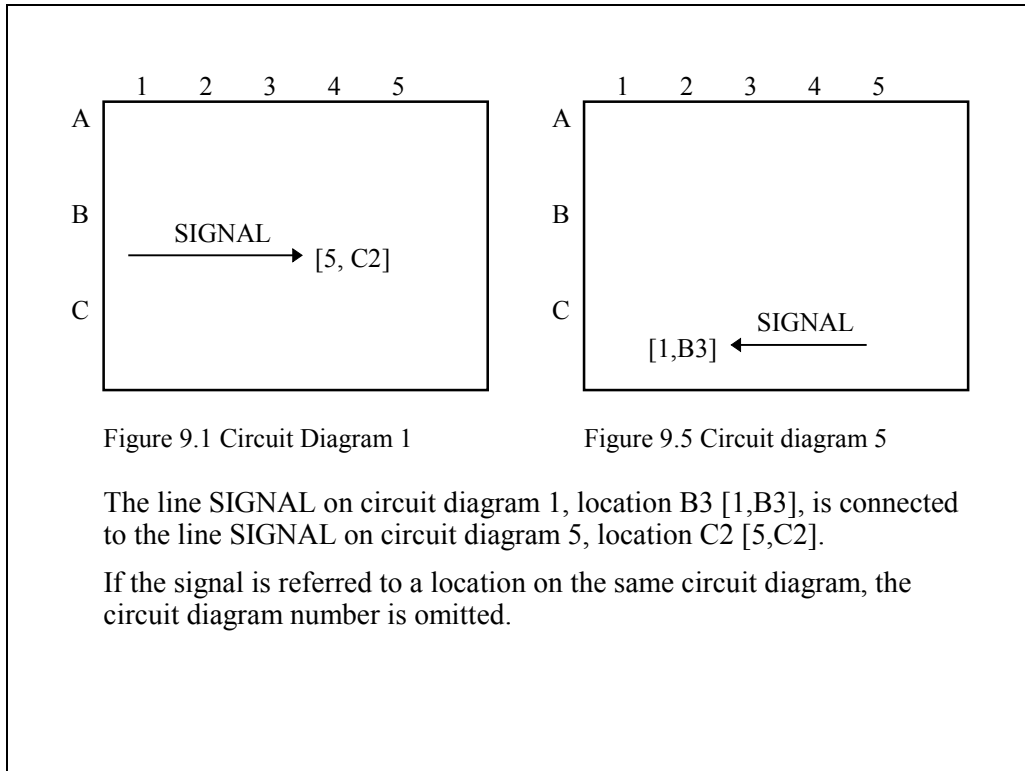

9.2 Schematic Diagrams

The tables below show where to find the parts on the Main PCA circuit diagrams and assembly drawings. Separate tables are created for the Main PCA side 1 and side 2 assembly drawing.

B402	C4	4, J10
------	----	--------

indicates that part B402 can be found in:

- location C4 on the Main PCA side 1 drawing
- circuit diagram part 4, location J10.

Table 9-1. Parts Location Main PCA Side 1

B402	C4	4, J10
B403	C4	4, J11
C101	A2	1, E3
C102	A1	1, E2
C104	B2	1, C2
C105	B3	1, B4
C106	A2	1, F3
C111	B2	1, B2
C112	B2	1, B3
C113	B2	1, B2
C114	B2	1, B3
C116	B2	1, B4
C117	B2	1, C3
C118	B2	1, C4
C119	B2	1, C4
C121	B2	1, D4
C122	B2	1, C4
C123	B2	1, C5
C124	B3	1, D5
C146	A2	1, F5
C181	A3	1, A9
C183	B3	1, C9
C187	B3	1, C8
C201	C2	2, E3
C202	D1	2, E2
C204	C2	2, C2
C205	D3	2, B3
C206	D1	2, E2
C211	D2	2, A2
C212	D2	2, A2
C213	D2	2, B2
C214	D2	2, B2
C216	D2	2, B3
C217	D2	2, C3
C218	D2	2, C3
C219	D2	2, C4
C221	D2	2, C3
C222	D2	2, C3
C223	D2	2, C4
C224	D3	2, C4
C246	C2	2, F5
C281	C3	2, A9
C283	C3	2, C9
C287	D3	2, B2
C303	B3	3, E6
C313	D3	3, D7
C314	A3	3, E6
C317	C3	3, G6
C321	C3	3, C7
C322	C3	3, C7
C333	B3	3, E11
C337	B3	3, G11
C339	B3	3, G11
C392	D3	3, G2
C395	C3	3, B10
C399	C3	3, A11
C465	D3	4, B12
C501	D3	5, E3
C502	C4	5, F6
C503	D4	5, E6
C504	D4	5, E6
C528	D4	5, H8
C553	C5	5, G10
C555	C5	5, C11
C561	C5	5, C13
C562	B5	5, C14
C563	B5	5, C14
C564	A5	5, D14
C565	B5	5, B14
C567	B5	5, B14
C568	D5	5, B15
C572	C5	5, B15
C573	B5	5, C15
C574	A5	5, C15
C576	B5	5, C15
C581	A3	5, B10
C608	B5	5, J15
C609	A4	5, J15
D401	B3	4, B4
D451	C3	4, J4
D471	B4	4, F11
D474	A4	4, B15
D475	B5	4, F15
H495	A3	4, I16
H521	D3	5, K9
H522	D3	5, K8
K171	A2	1, E4 3, D14
K173	A2	1, C2 3, C14
K271	C2	2, E4 3, E14
L501	D4	5, E5
L564	A5	5, C14
L566	B5	5, C14
L569	D5	5, B14
L600	A5	5, J13
N101	B2	1, D6
N201	C2	2, D6
N301	B3	3, D9
N501	D5	5, E5
R1	B1	1, E2
R2	C1	2, E1
R101	B2	1, E2
R102	B2	1, E3
R103	A2	1, E4
R104	A2	1, E4
R105	B2	1, B3
R106	A1	1, F2
R108	B2	1, B3
R172	A2	1, C2
R201	C2	2, E2
R202	C2	2, E2
R203	C2	2, E4
R204	C2	2, E4
R205	D2	2, A2
R206	D1	2, E2
R208	D2	2, B2
R306	B3	3, F6
R312	C3	3, G6
R321	C3	3, C6
R322	C3	3, B6
R323	B3	3, C8
R324	B3	3, C8
R327	C3	3, C7
R333	B3	3, E11
R339	B3	3, G11
R378	C3	3, F3
R381	C3	3, F3
R391	C3	3, A11
R392	C3	3, B11
T552	C5	5, C12
T600	A5	5, J14
V401	A4	4, G1
V402	A4	4, G2
V603	B4	5, J15
X452	A4	4, J8
X453	A3	4, B7
X501	D4	5, E1
X503	A5	5, C3
X601	A4	5, J15
Z501	D3	5, E2

Table 9-2. Parts Location Main PCA Side 2

B401	B4	4, J9	C331	C3	3, E11	C481	B4	4, J11	R109	D2	1, E5
C107	D2	1, D5	C332	C4	3, E10	C482	B4	4, J11	R110	C2	1, A4
C131	D2	1, D5	C342	C3	3, G11	C483	B4	4, J10	R111	C2	1, A4
C132	D2	1, D5	C344	C3	3, F9	C484	B4	4, J10	R112	C2	1, A4
C133	D2	1, D5	C356	C3	3, A10	C485	B4	4, J9	R113	C2	1, A5
C134	D2	1, D5	C357	C3	3, B10	C486	B4	4, J9	R114	C2	1, A5
C136	D2	1, E5	C376	B3	3, F5	C487	B4	4, I8	R116	C2	1, C3
C142	C2	1, F4	C377	B3	3, F4	C488	B3	4, I7	R117	C2	1, B3
C145	D2	1, F5	C378	C3	3, F4	C500	A4	5, E2	R118	C2	1, D4
C148	C1	1, E2	C379	C3	3, F4	C505	A4	5, E4	R119	C3	1, C4
C152	D2	1, C7	C381	B3	3, F3	C506	A5	5, D6	R120	C2	1, B4
C153	D2	1, D7	C382	B3	3, F4	C507	A5	5, F6	R121	C2	1, D5
C156	C3	1, D8	C391	A3	3, G2	C509	A5	5, C5	R125	C2	1, C4
C158	C2	1, C7	C393	B3	3, H5	C511	D5	5, B4	R131	D2	1, D5
C159	C2	1, F7	C394	B3	3, H4	C512	D5	5, C5	R132	D2	1, D5
C161	D2	1, E10	C396	C3	3, H4	C529	A4	5, H8	R133	D2	1, D5
C162	D3	1, F8	C397	C3	3, H4	C531	C4	5, K5	R134	D2	1, E5
C182	C2	1, A7	C398	B3	3, H3	C534	A4	5, G6	R136	D2	1, E5
C184	C2	1, B8	C400	B4	4, ??	C547	A5	5, C7	R137	D1	1, E3
C186	D2	1, B7	C401	C3	4, B2	C548	A5	5, C7	R138	D1	1, E3
C188	C2	1, B7	C402	C3	4, B2	C549	A4	5, C7	R139	D1	1, E4
C189	D2	1, C8	C403	C3	4, C2	C550	A5	5, D13	R140	D1	1, E4
C190	C2	1, C8	C404	D4	4, G2	C551	A5	5, D11	R141	C2	1, E3
C191	C2	1, C8	C407	D3	4, A4	C552	A5	5, D11	R142	D2	1, F4
C199	D3	1, C1	C408	C3	4, A5	C554	D5	5, D4	R143	D2	1, E4
C207	B2	2, D4	C409	D3	4, H2	C583	A4	5, J8	R144	D2	1, F5
C231	B2	2, C5	C416	C3	4, A4	C591	B5	5, K3	R146	D2	1, F5
C232	B2	2, D5	C431	B4	4, E1	C592	B5	5, K3	R151	D2	1, C8
C233	B2	2, D5	C432	B4	4, F2	C593	B5	5, K3	R152	D2	1, C8
C234	B2	2, D5	C433	B3	4, E2	C594	C4	5, K4	R153	D2	1, D8
C236	B2	2, E5	C434	B4	4, F2	C602	D5	5, H13	R154	D2	1, D8
C242	A2	2, F4	C436	C4	4, F3	C603	D4	5, K10	R155	D2	1, D7
C245	B2	2, E4	C438	C4	4, F3	C604	D5	5, K11	R156	C3	1, D8
C248	B1	2, E2	C439	C3	4, E3	C605	D5	5, K11	R157	C3	1, D8
C252	B2	2, C6	C441	C3	4, F3	C606	C5	5, K10	R158	C3	1, E7
C253	B2	2, D6	C442	C4	4, E3	C607	C5	5, K12	R159	D3	1, F7
C256	A3	2, D8	C451	B3	4, J1	C610	C5	5, K15	R160	C2	1, D7
C258	B2	2, C7	C452	B3	4, J2	D531	B4	5, J5	R161	C3	1, D8
C259	B2	2, E7	C453	B3	4, J2	L181	C3	1, A9	R165	D3	1, E8
C261	B2	2, D9	C457	B3	4, I5	L182	D3	1, A9	R171	D3	3, D12
C262	B3	2, E9	C458	B3	4, I5	L183	D3	1, B9	R173	D3	3, C12
C282	A2	2, A7	C463	B4	4, F6	L281	A3	2, A9	R182	C3	1, A7
C284	A2	2, A6	C464	B4	4, G6	L282	B3	2, A9	R184	C2	1, A9
C286	B2	2, B7	C466	B3	4, I4	L283	B3	2, B9	R186	D2	1, B7
C288	A2	2, B7	C471	C4	4, B11	L481	C4	4, A16	R188	C3	1, B7
C289	B2	2, B8	C472	C4	4, B11	L562	C5	5, B14	R189	D2	1, B9
C290	B2	2, C7	C473	C4	4, B11	L563	C5	5, B14	R209	B2	2, D4
C291	A2	2, C8	C474	B4	4, B12	L567	C5	5, C14	R210	A2	2, A3
C301	C3	3, D6	C475	D4	4, C14	N531	B4	5, J6	R211	A2	2, A3
C306	D3	3, F7	C476	D4	4, E16	N600	D5	5, J11	R212	A2	2, A4
C311	C3	3, G7	C478	B5	4, G16				R213	A2	2, A4
C312	C3	3, G8	C479	C4	4, F4				R214	A2	2, A5
			C480	C4	4, F5				R216	A2	2, C3

R217	A2	2,	B3
R218	A2	2,	D3
R219	A3	2,	C4
R220	A2	2,	B4
R221	A2	2,	D4
R225	A2	2,	C4
R231	B2	2,	C5
R232	B2	2,	D5
R233	B2	2,	D5
R234	B2	2,	D5
R236	B2	2,	E5
R237	A1	2,	E3
R238	A1	2,	E3
R239	A1	2,	E3
R240	A1	2,	E4
R241	A2	2,	E3
R242	B2	2,	E3
R243	B2	2,	E4
R246	B2	2,	E5
R251	B2	2,	C8
R252	B2	2,	C8
R253	B2	2,	D8
R254	B2	2,	D8
R255	B2	2,	D7
R256	A3	2,	D8
R257	A3	2,	D7
R258	B3	2,	E7
R259	B3	2,	E7
R260	A2	2,	D7
R261	A3	2,	D7
R271	B3	3,	E12
R282	A3	2,	A7
R284	A2	2,	A8
R286	B3	2,	B7
R288	A3	2,	B7
R289	B2	2,	B8
R301	C3	3,	D6
R302	C3	3,	E6
R303	C3	3,	E6
R305	C3	3,	D6
R307	D4	3,	F8
R308	D3	3,	F6
R309	C3	3,	G6
R310	C3	3,	E6
R311	C3	3,	G6
R326	B3	3,	C6
R331	C3	3,	C7
R337	C3	3,	F11
R342	C3	3,	G11
R352	D1	3,	B3
R353	D1	3,	B3
R354	D3	3,	A2
R356	D3	3,	A2
R369	B3	3,	C11
R371	C3	3,	E3
R375	B5	3,	E2
R376	B3	3,	F3
R377	B3	3,	F3
R385	C4	3,	F2
R390	B3	3,	B10
R393	A3	3,	G3
R394	A3	3,	G3
R395	A3	3,	G2
R396	A3	3,	G3
R398	A3	3,	G3
R403	C3	4,	A3
R404	D3	4,	A11
R405	D4	4,	G2
R406	D4	4,	G2
R407	D4	4,	G2
R408	D3	4,	G2
R409	C3	4,	F3
R410	D3	4,	G3
R416	C5	4,	A12
R417	D3	4,	A11
R431	C4	4,	D3
R432	C3	4,	D3
R433	C3	4,	E3
R434	C4	4,	E3
R436	B4	4,	F3
R438	B4	4,	E3
R439	B3	4,	E3
R441	B4	4,	E3
R442	B4	4,	E3
R453	B3	4,	I3
R454	B3	4,	A11
R466	C5	4,	A12
R467	B3	4,	B11
R469	B4	4,	J12
R470	B5	4,	B12
R471	B4	4,	H7
R472	B4	4,	H8
R473	B3	4,	I8
R474	B4	4,	I8
R478	C4	4,	F5
R479	C4	4,	F5
R480	C4	4,	E5
R481	C4	4,	E15
R482	C4	4,	D16
R483	C4	4,	E16
R491	B4	4,	H14
R495	D3	4,	I15
R496	D3	4,	J15
R497	C5	4,	G15
R501	A4	5,	E3
R502	A4	5,	F5
R503	A5	5,	E6
R504	C5	5,	C4
R506	C5	5,	C4
R507	C5	5,	C5
R508	B4	5,	B4
R509	A5	5,	C5
R512	A5	5,	C5
R513	A5	5,	G3
R514	A5	5,	G3
R516	A5	5,	G4
R524	A5	5,	G15
R527	A3	5,	J9
R528	A4	5,	H7
R529	A3	5,	J8
R531	B4	5,	K6
R534	A4	5,	G6
R535	A4	5,	G8
R550	A5	5,	D12
R551	B5	5,	E12
R552	A5	5,	E16
R553	A5	5,	E16
R554	A5	5,	E15
R558	A5	5,	F10
R559	A5	5,	F10
R563	A5	5,	F15
R564	A5	5,	F15
R565	A5	5,	F14
R570	B5	5,	C12
R580	A4	5,	A8
R591	C4	5,	K4
R600	C5	5,	K15
R602	C5	5,	K13
R603	C4	5,	K15
R604	C5	5,	K15
V171	D3	3,	D13
V172	B3	3,	E13
V174	D3	3,	C13
V301	C4	3,	G8
V353	D1	3,	B2
V354	D1	3,	B2
V356	D3	3,	A3
V358	D2	3,	B2
V359	D2	3,	B2
V395	B3	3,	B11
V403	D4	4,	G2
V482	C4	4,	D15
V495	D3	4,	H15
V501	A3	5,	E3
V503	A4	5,	E5
V504	A4	5,	E4
V506	A4	5,	E4
V550	A5	5,	C10
V551	B5	5,	C11
V554	B5	5,	D12
V555	B5	5,	D12
V561	B5	5,	C13
V562	B5	5,	C13
V563	C5	5,	C13
V564	C5	5,	C13
V565	A5	5,	F15
V566	A5	5,	F15
V567	B5	5,	A13
V569	A5	5,	A9
V600	D5	5,	J12
V601	D5	5,	J13
V602	D5	5,	J13
V604	C5	5,	K15
V605	C5	5,	J15

Chapter 10







Modifications

	Title	Page
10.1	Software modifications	10-3
10.2	Hardware modifications	10-3

10.1 Software modifications

Changes and improvements made to the test tool software (firmware) are identified by incrementing the software version number. These changes are documented on a supplemental change/errata sheet which, when applicable, is included with the manual.

To display the software version, proceed as follows:

1. Press  to open the MENU.
2. Press  to highlight INSTRUMENT SETUP.
3. Press  to select INSTRUMENT SETUP.
4. Press  to highlight VERSION & CALIBRATION.
5. Press  to select VERSION & CALIBRATION.
6. Press  twice to return to your measuring mode or  to go to MENU.

The first software release of the Fluke 43B is V2.00.

10.2 Hardware modifications

Changes and improvements made to the test tool hardware are identified by incrementing the revision number of the Main PCA. The revision number is printed on a sticker, see the example below. The sticker is placed on D-ASIC D471, on the Main PCA.

This example of the Main PCA revision number sticker indicates revision 3.

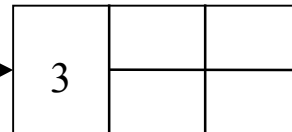

Revision 03

In the Fluke 43B Test Tool, version 3 of the Printed Circuit Board (PCB) is used for the Main PCA. The version of the PCB is indicated by the last digit of the 12 digit number on the PCB edge near N501. The new version 12 digit code is 4022 245 0482.3 (version 3).

See Chapter 9 for the drawings of both sides of the PCB.





**205 Westwood Ave
Long Branch, NJ 07740
1-877-742-TEST (8378)
Fax: (732) 222-7088
salesteam@Tequipment.NET**