

705

Loop Calibrator

Instruction Sheet

Introduction

The Fluke 705 Loop Calibrator is a source and measurement tool for 0 to 20 mA or 4 to 20 mA current loop testing and a measurement tool for dc voltage from 0 to 28 V. The calibrator does not source and measure simultaneously.

Your calibrator is supplied with a set of TL75 test leads, AC72 alligator clips, 9 V installed alkaline battery, and this instruction sheet.

Summary of Calibrator Capabilities

| Function | Range | Resolution |
|-------------------|----------------|------------|
| dc V input | +28 V | 0.001 V |
| dc mA input | 0 to 24 mA | 0.001 mA |
| dc mA output | | |
| Loop power output | 24 V dc output | N/A |

Safety Information

Use the calibrator only as specified in this sheet, otherwise the protection provided by the calibrator may be impaired.

A **Warning** identifies conditions and actions that pose hazard(s) to the user; a **Caution** identifies conditions and actions that may damage the calibrator or the equipment under test.

August 1998 Rev.2, 6/03

© 1998-2003 Fluke Corporation, All rights reserved.

All product names are trademarks of their respective companies

Warning

To avoid possible electric shock or personal injury:







- Never apply more than 30 V between any two terminals, or between any terminal and earth ground.
- Inspect the test leads for damaged insulation or exposed metal. Check lead continuity. Replace damaged test leads before you use the meter.
- Make sure the battery door is closed and latched before you operate the calibrator.
- Remove test leads from the calibrator before you open the battery door.
- Do not operate calibrator if it is damaged.
- Do not operate the calibrator around explosive gas, vapor, or dust.

Caution





Use the proper terminals, function, and range for your measurement or output application.

Explanation of International Symbols

International Symbols

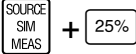
| Symbol | Meaning |
|---|---|
|  | Earth ground |
|  | Battery |
|  | Refer to this instruction sheet for information about this feature. |
|  | Double insulated |
|  | Conforms to relevant Canadian Standards Association directives. |
|  | Conforms to European Union directives |
|  | Direct current |

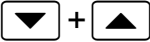
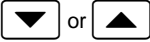
Pushbutton Functions

| Button | Function |
|---|--|
|  | Press to select source, simulate, or measure modes. Press while turning on the calibrator to select loop power. The Loop symbol appears in the display. |
|  | Press simultaneously to start the SpanCheck™ function. The SpanCheck symbol appears in the display. Output toggles between 0 % and 100 %. |
|  | Press to manually step the output up or down 25 %. |
|  | Press both buttons simultaneously to select auto ramp output. The \wedge \wedge \lrcorner symbols appear in the display. |
|  | Press to scroll the display up or down. |
|  | Press while turning on the calibrator to change and save scroll steps to 0.001 mA. |
|  | Press while turning on the calibrator to toggle between 0 to 20 mA and 4 to 20 mA and save the current output span in a nonvolatile memory. |

Using the Current Output Modes

The calibrator provides current output for calibrating and testing 0 to 20 mA and 4 to 20 mA current loops and instruments.

In source mode, the calibrator supplies the current. In simulate mode, the calibrator simulates a two-wire transmitter in an externally-powered current loop.

Sourcing mA

Use source mode whenever you need to supply current into a passive circuit. Insert the test leads into the terminals as shown below.

Note

A path must exist for current to flow between the output + and -mA terminals, otherwise the display will indicate an overload (OL) when you set an output value.

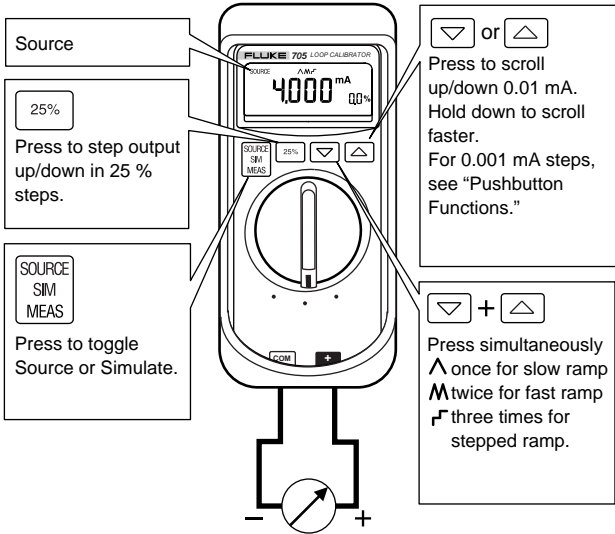

How to Contact Fluke

To order accessories, receive operating assistance, or get the location of the nearest Fluke distributor or Service Center, call:

1-888-99-FLUKE (1-888-993-5853) in U.S.A.

1-800-36-FLUKE (1-800-363-5853) in Canada

+31-402-675-200 in Europe

+81-3-3434-0181 Japan

+65-738-5655 Singapore

+1-425-446-5500 from other countries

Address correspondence to:

Fluke Corporation
P.O. Box 9090,
Everett, WA 98206-9090
U.S.A.

Fluke Europe B.V.
P.O. Box 1186,
5602 BD Eindhoven
The Netherlands

Visit us on the World Wide Web at: www.fluke.com

Register your Calibrator at: register.fluke.com

LIMITED WARRANTY & LIMITATION OF LIABILITY

This Fluke product will be free from defects in material and workmanship for three years from the date of purchase. This warranty does not cover fuses, disposable batteries or damage from accident, neglect, misuse or abnormal conditions of operation or handling. Resellers are not authorized to extend any other warranty on Fluke's behalf. To obtain service during the warranty period, send your defective calibrator to the nearest Fluke Authorized Service Center with a description of the problem.

THIS WARRANTY IS YOUR ONLY REMEDY. NO OTHER WARRANTIES, SUCH AS FITNESS FOR A PARTICULAR PURPOSE, ARE EXPRESSED OR IMPLIED. FLUKE IS NOT LIABLE FOR ANY SPECIAL, INDIRECT, INCIDENTAL OR CONSEQUENTIAL DAMAGES OR LOSSES, ARISING FROM ANY CAUSE OR THEORY. Since some states or countries do not allow the exclusion or limitation of an implied warranty or of incidental or consequential damages, this limitation of liability may not apply to you.

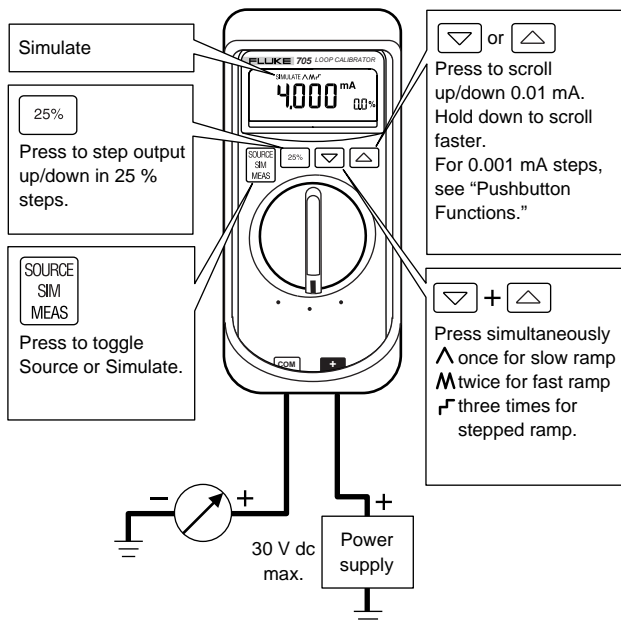

Simulating a Transmitter

When simulating the operation of a transmitter, the calibrator regulates the loop current to a known value that the user selects. A 12 to 28 V loop supply must be available. Insert the test leads as shown below.



Auto Ramping the mA Output

Auto ramping allows you to continuously apply a varying current stimulus from the calibrator to a passive (sourcing) or active (simulate) loop while your hands remain free to test the transmitter's response. The calibrator produces a continuously repeating ramp in your choice of three waveforms:

-  0 % - 100 % - 0 % 40-second smooth ramp
-  0 % - 100 % - 0 % 15-second smooth ramp
-  0 % - 100 % - 0 % Stair-step ramp in 25 % steps, pausing 5 seconds at each step.

To exit ramping, press any button or turn the calibrator off.

Using the SpanCheck™ Function

The SpanCheck™ function checks the zero and span points of a transmitter in either Source or Simulate mode. To exit the SpanCheck function, press the SOURCE SIM MEAS key or the 25% key.

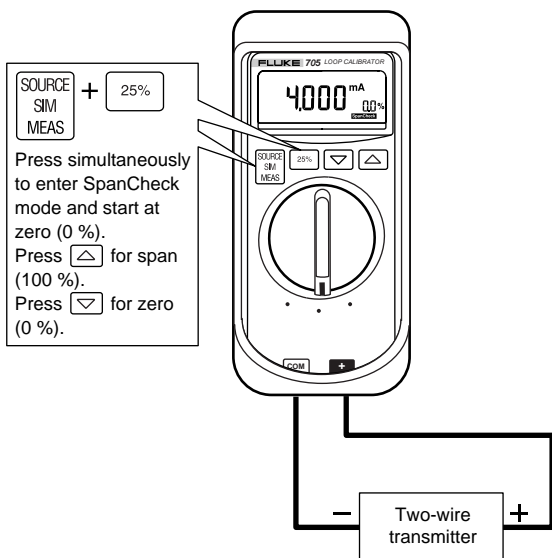

Changing the Current Span

The calibrator's current output span has two settings:

- 4 mA = 0 %, 20 mA = 100 % (default)
- 0 mA = 0 %, 20 mA = 100 % (optional)

To change and save the current output span in a nonvolatile memory (retained when the power is turned off), press  while turning on the calibrator to mA.

Measuring dc mA

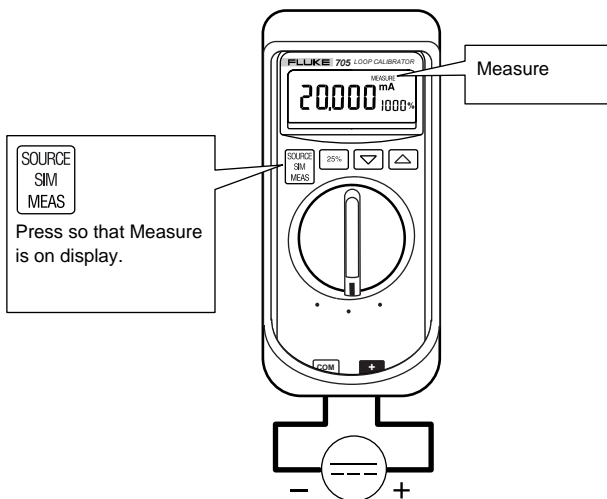

Measuring dc mA with Loop Power

Loop power provides +24 V to power a transmitter and to read loop current simultaneously. To exit, turn the calibrator off or to V.

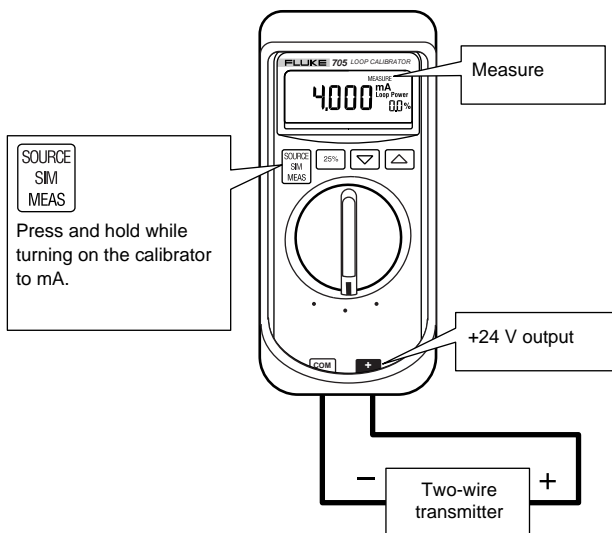

Measuring dc Volts

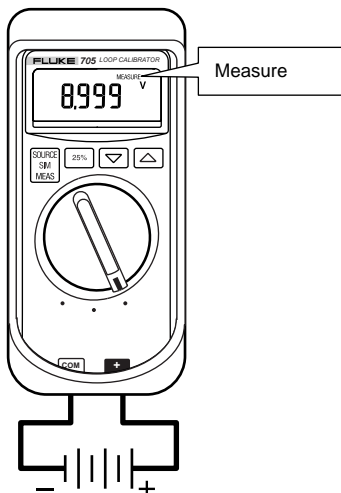

rt01f.eps

Maintenance

Warning

To avoid electric shock or personal injury:

- Do not allow water into the case.
- Remove any input signals prior to removing test leads and opening case.
- When servicing the calibrator, use only specified replacement parts.

For maintenance procedures not described in this sheet, contact a Fluke Service Center.

In Case of Difficulty

Check the battery and test leads. Replace as needed.

If the calibrator needs repair, contact a Fluke Service Center. If the calibrator is under warranty, see the warranty statement for terms. If the warranty has lapsed, the calibrator will be repaired and returned for a fixed fee.

Cleaning

Periodically wipe the case with a damp cloth and detergent; do not use abrasives or solvents.

Calibration

Calibrate your calibrator once a year to ensure that it performs according to its specifications. Call 1-800-526-4731 from the USA and Canada. In other countries, contact a Fluke Service Center.

Replacing the Battery

Warning

To avoid false readings, which could lead to possible electric shock or personal injury, replace the battery as soon as the battery indicator () appears in the display.

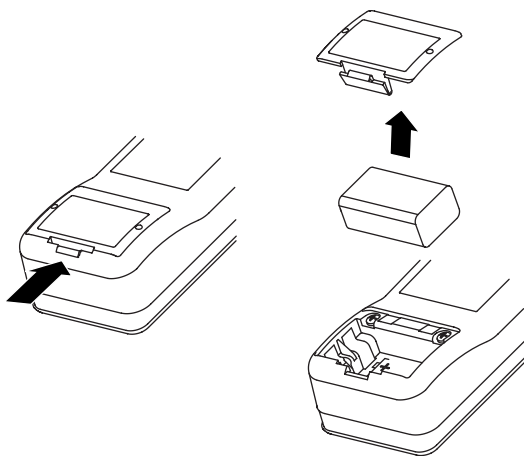

Replacement Parts and Accessories

Replacement Parts

| Item | Description | PN or Model No. | Qty. |
|-------------|---|------------------------|-------------|
| BT1 | 9 V battery, ANSI/NEDA 1604A or IEC 6LR61 | 614487 | 1 |
| C10 | Holster, Yellow | C10 | 1 |
| MP85 | Case top | 665098 | 1 |
| MP86 | Case bottom | 665109 | 1 |
| H2 | Case screw | 832246 | 4 |
| MP89 | Non-skid foot | 885884 | 1 |
| MP92 | Battery door | 665106 | 1 |
| S1 | Keypad | 665117 | 1 |
| TL75 | Test lead set | TL75 | 1 |
| - | CD ROM | 2088974 | 1 |
| AC72 | Alligator clips | AC72 | 1 |
| TL20 | Industrial test lead\ set | TL20 | Option |

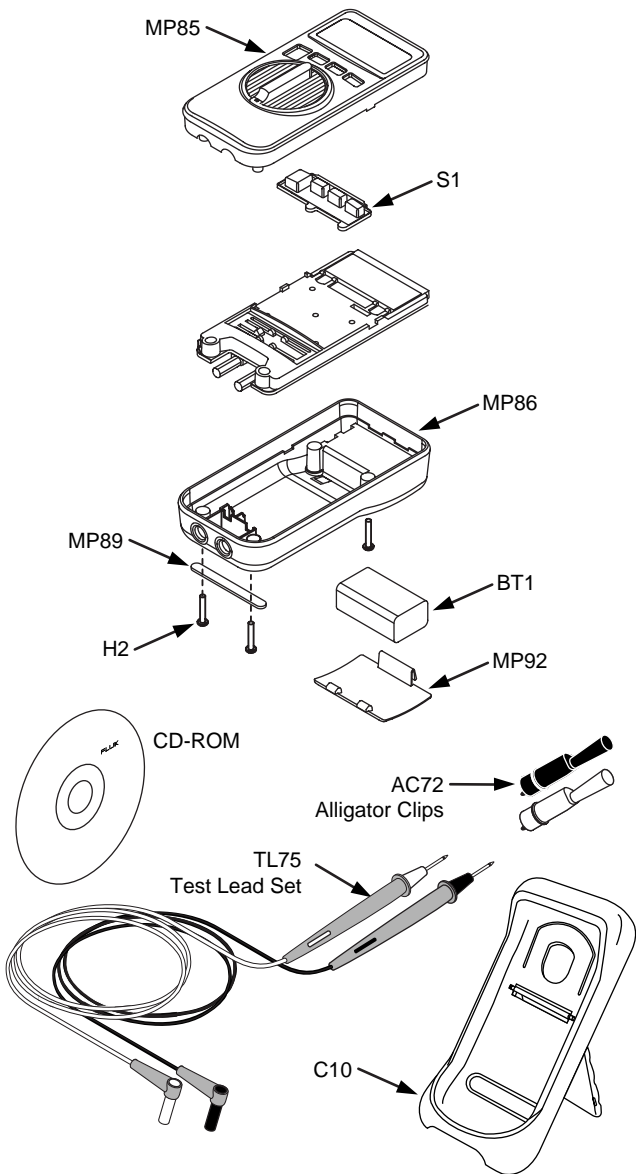

Specifications

Specifications are based on a one year calibration cycle and apply from +18 °C to +28 °C unless stated otherwise. "Counts" means number of increments or decrements of the least significant digit.

DC Volts Input

Range: + 28 V (+ 30 V max)

Input Impedance: 1 M Ω

Accuracy: \pm (0.025 % of reading + 2 counts)

DC mA Input

Range: 24 mA

Resolution: 0.001 mA

Accuracy: \pm (0.02 % of reading + 2 counts)

DC mA Output

Range: 0 mA to 24 mA

Accuracy: \pm (0.02 % of reading + 2 counts)

Source mode:

Compliance: \geq 1000 Ω at 20 mA

Simulate mode:

External loop voltage requirement: 24 V nominal, 30 V maximum, 12 V minimum

Loop Power

\geq 24 V

Percent display

-25 % to 125 %

Input/Output Protection

Input/output protection on mA range: resettable, nonreplaceable 0.1 A fuse.

General Specifications

Maximum voltage applied between any terminal and earth ground or between any two terminals: 30 V

Storage temperature: -40 °C to 60 °C

Operating temperature: -10 °C to 55 °C

Operating altitude: 3000 meters maximum

Temperature coefficient: ± 0.005 % of range per °C for the temperature ranges -10 to 18 °C and 28 to 55 °C

Relative humidity: 95 % up to 30 °C, 75 % up to 40 °C, 45 % up to 50 °C, and 35 % up to 55 °C

Vibration: Random 2 g, 5 to 500 Hz

Shock: 1 meter drop test

Safety: Certified as compliant to CAN/CSA C22.2 No. 1010.1:1992. Complies with ANSI/ISA S82.01-1994.

Power requirements: Single 9 V battery (ANSI/NEDA 1604A or IEC 6LR61)

Battery life (typical): Source mode: 18 hours; 12 mA into 500 Ω ; measure/simulate Mode: 50 hours

Size: 32 mm H x 87 mm W x 187 mm L (1.25 in H x 3.41 in W x 7.35 in L);

With holster and Flex-Stand: 52 mm H x 98 mm W x 201 mm L (2.06 in H x 3.86 in W x 7.93 in L)

Weight: 224 g (8 oz);

With holster and Flex-Stand: 349 g (12.3 oz)

T
Equipment
.NET



205 Westwood Ave
Long Branch, NJ 07740
1-877-742-TEST (8378)
Fax: (732) 222-7088
salesteam@Equipment.NET