

RTD Calibrator

Instruction Sheet

Introduction

Fluke Model 712 RTD Calibrator is a handheld tool for calibrating RTD (Resistance Temperature Detector) transmitters, including most pulsed transmitters. It simulates and measures seven different types of RTDs, in units of °C or °F. It also simulates and measures resistance in units of ohms. It does not source and measure simultaneously.

Your calibrator is supplied with a Flex-Stand™ holster, an installed 9 V alkaline battery, two sets of test leads, and this instruction sheet.

If the calibrator is damaged or something is missing, contact the place of purchase immediately. Contact your Fluke distributor for information about accessories. To order replacement parts or spares, see “Replacement Parts.”

The next table lists the RTD types supported by the calibrator, with their ranges, resolution, and the allowable excitation current from an RTD measurement device under test. All RTD types use ITS-90 curves. Full calibrator specifications are listed at the end of this instruction sheet.

Safety Information







Warning

To avoid possible electric shock or personal injury:

- **Never apply more than 30 V between any two terminals, or between any terminal and earth ground.**
- **Make sure the battery door is closed and latched before you operate the calibrator.**
- **Remove test leads from the calibrator before you open the battery door.**
- **Do not operate the calibrator if it is damaged.**
- **Do not operate the calibrator around explosive gas, vapor, or dust.**

When servicing the calibrator, use only specified replacement parts.

International Symbols

Symbol	Meaning
	Earth ground
	Fuse
	Battery
	Refer to this instruction sheet for information about this feature.
	Double insulated
	Conforms to relevant Canadian Standards Association directives
	Conforms to European Union directives

Getting Acquainted with the Calibrator

Press the green  pushbutton to turn the calibrator on and off. Press the INPUT/OUTPUT pushbutton to select either INPUT (measuring) or OUTPUT (simulating).

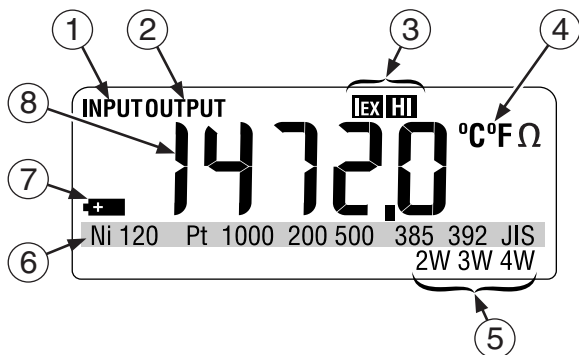

kg03f.eps









Display Elements

Element	Meaning
① INPUT	Lit when measuring an RTD or resistance
② OUTPUT	Lit when simulating an RTD or resistance
③ [EX HI]	When simulating an RTD or ohms, the excitation current from the measuring device under test is too high. The calibrator output is unspecified.
④ °C, °F, Ω	When an RTD type is selected, one of these is lit to show the selected scale.

Display Elements (cont.)

Element	Meaning
⑤ 2W, 3W, 4W	When measuring an RTD, one of these is lit to indicate a two-wire, three-wire, or four-wire configuration. These annunciators are not used when simulating an RTD or resistance (output).
⑥ RTD TYPES	The RTD type annunciators (example, Ni 120) show the selected RTD type.
⑦ 	Lit when the battery is low.
⑧ Numerals	Show the measured or simulated value in degrees or ohms. When OL appears, the value is out of range.

Pushbutton Functions

Pushbutton	Function
	Press to select a different RTD type. When you select the Ω type (ohms), displayed units are ohms, not degrees.
	Press to toggle temperature scales between Celsius and Fahrenheit.
	Press to select input (measure) or output (simulate) mode.
2W 3W 4W  	In simulate mode, press to step up or down 50° or 50 Ω . In measurement mode, press  or  to select a two-wire, three-wire, or four-wire RTD input configuration. You will see the corresponding 2W, 3W, or 4W on the display.
 	Press to scroll up or down display. Hold down to scroll faster.

Simulating an RTD

To simulate an RTD, proceed as follows:

1. Press \odot to turn on the power.
2. If the calibrator is in input mode (INPUT on the display), press INPUT OUTPUT once. Make sure the display shows OUTPUT.
3. Press $\boxed{\text{RTD TYPE}}$ to select the desired RTD type.
4. Connect test leads to the terminals of the RTD measuring device as shown. Use only the two center outputs (labeled 2W 3W 4W OUTPUT).

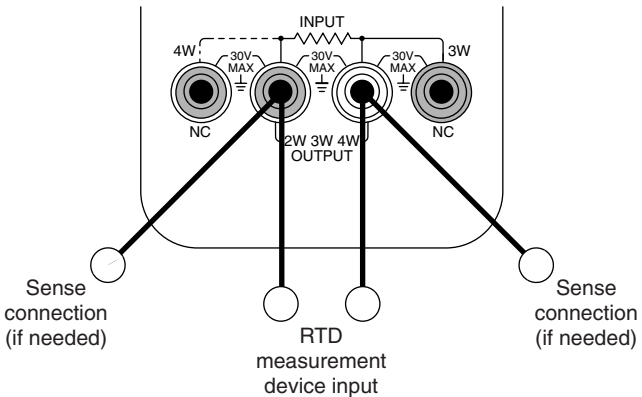

Measuring an RTD

To measure an RTD, proceed as follows:

1. Press \odot to turn on the power.
2. If the calibrator is in simulate mode (OUTPUT on the display), press INPUT OUTPUT once. Make sure the display shows INPUT.
3. Press $\boxed{\text{RTD TYPE}}$ to select the desired RTD type.
4. Press \blacktriangle or \blacktriangledown to select a two-wire, three-wire, or four-wire RTD input configuration. Look for the 2W, 3W, or 4W annunciator on the display to verify that the configuration is set correctly.
5. Connect test leads to the RTD as shown below. Use two, three, or four inputs, depending on the setting of 2W, 3W, or 4W on the display.

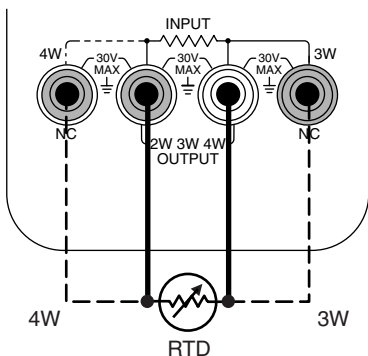

Maintenance

For maintenance procedures not described in this sheet, contact a Fluke Service Center.

In Case of Difficulty

- Check the battery and test leads. Replace as necessary.
- Review this sheet to make sure you are using the calibrator correctly.

If the calibrator needs repair, contact a Fluke Service Center. If the calibrator is under warranty, see the warranty statement for terms. If the warranty has lapsed, the calibrator will be repaired and returned for a fixed fee. Contact a Fluke Service Center for information and price.

Cleaning

Periodically wipe the case with a damp cloth and detergent; do not use abrasives or solvents.

Calibration

Calibrate your calibrator once a year to ensure that it performs according to its specifications. A calibration manual is available (PN 686540). Call 1-800-526-4731 from the USA and Canada. In other countries, contact a Fluke Service Center.

Replacing the Battery

When the  symbol appears on the display, replace the battery with a 9 V alkaline battery.

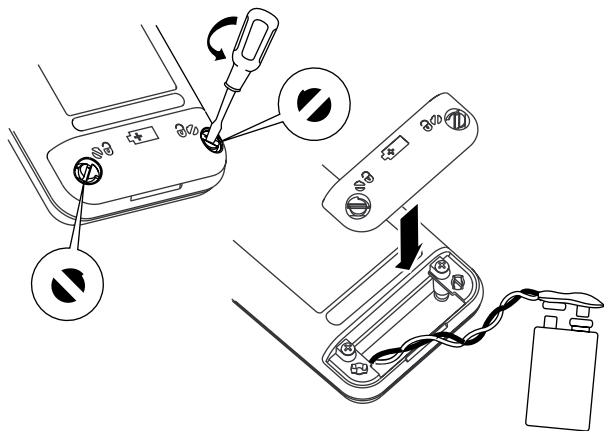

it07f.eps

Testing and Replacing the Fuses

⚠ Warning

To avoid personal injury or damage to the calibrator, use only a 0.125A 250V fast fuse, Littelfuse® 2AG.

Fuse F1 protects the input circuit. Fuse F2 protects the output circuit. Test and replace the fuses using the following procedure:

1. Remove the test leads from the calibrator terminals and turn the calibrator off.
2. Remove the battery door.
3. Remove the three Phillips-head screws from the case bottom and turn the case over.
4. Gently lift the top cover from the end nearest the input/output terminals until it unsnaps from the bottom cover.
5. Gently remove the fuse from its mounting bracket.
6. Measure the resistance of the fuse. An open or high resistance suggests that the fuse is blown.
7. Replace the blown fuse with a 0.125 A 250 V fast fuse, Littelfuse® 2AG.
8. Fit the top and bottom covers together, engaging the two snaps. Make sure that the keypad and the input/output terminal gasket are properly seated.
9. Reinstall the three screws.
10. Replace the battery door.

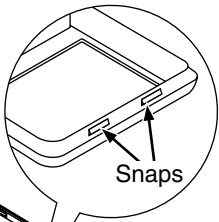
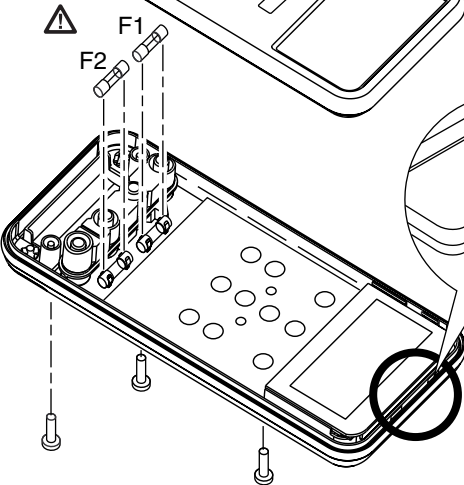
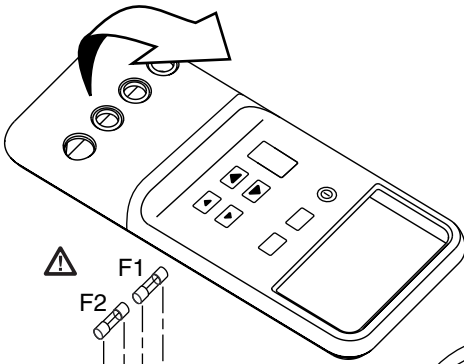

Replacement Parts and Accessories

Replacement Parts

Item	Description	PN or Model no.	Qty.
BT1	9V battery, ANSI/NEDA 1604A or IEC 6LR61	614487	1
CG81Y	Holster, Yellow	CG81Y	1
△ F1,F2	Fuse, 125 mA, 250V fast	686527	2
MP85	Case top	620192	1
MP86	Case bottom	620168	1
H2, 3, 4	Case screw	832246	3
MP89, 90	Non-skid foot	824466	2
MP8	O-ring for input/output receptacle	831933	1
MP92	Battery door	609930	1
H5, 6	Battery door fasteners	948609	2
S1	Keypad	687084	1
-	712 Instruction Sheet	650280	1
-	Test lead, red	688051	2
-	Test lead, black	688066	2
-	71X Series Calibration Manual	686540	Option

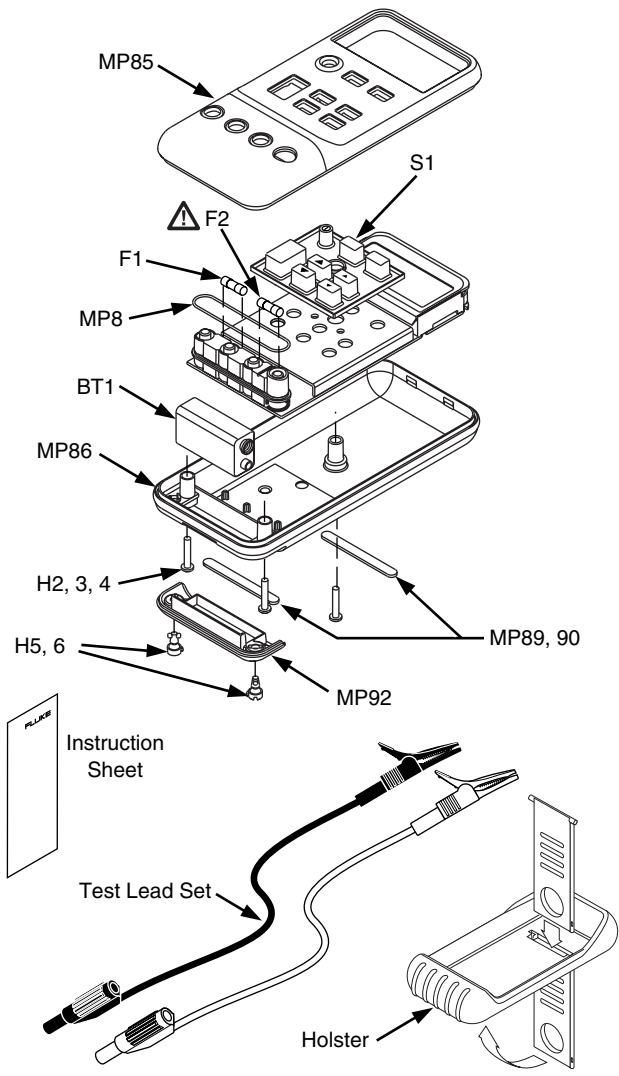

Specifications

Specifications are based on a one year calibration cycle and apply for ambient temperature from +18°C to +28°C unless stated otherwise.

Note

Specifications on this Instruction Sheet apply to the 712 RTD Calibrators with serial number 7676001 or above.

Ohms Specifications

Ohms Range	Input Accuracy 4-Wire $\pm\Omega$	Output Accuracy $\pm\Omega$	Allowable Excitation (mA)
0.00 Ω to 400.00 Ω	0.1	0.15	0.1 to 0.5
		0.1	0.5 to 3.0
400.0 Ω to 1500.0 Ω	0.5	0.5	0.05 to 0.8
1500.0 Ω to 3200.0 Ω	1	1	0.05 to 0.4

Allowable Excitation is for Output mode only. It shows the allowable excitation current from an ohmmeter or RTD measurement device connected to the calibrator.

Excitation current from 712: 0.2 mA.

Maximum input voltage: 30 V

RTD Specifications

Note

Since ohms input and output units are available, you can use the calibrator for any unsupported RTD type by selecting the ohms range and making manual calculations or referring to tables.

RTD Type	Range °C (°F)	Accuracy (°C)			Allowable Excitation (mA)
		Input		Output	
		4-Wire	2-Wire & 3-Wire		
Ni 120	-80.0 to 260.0 (-112.0 to 500.0)	0.2	0.3	0.2	0.1 to 3.0
Pt 100 385	-200.0 to 800.0 (-328.0 to 1472.0)	0.33	0.5	0.33	0.1 to 3.0
Pt 200 385	-200.0 to 250.0 (-328.0 to 482.0) 250.0 to 630.0 (482.0 to 1166.0)	0.2	0.3	0.2	0.1 to 3.0
		0.8	1.6	0.8	
Pt 500 385	-200.0 to 500.0 (-328.0 to 932.0) 500.0 to 630.0 (932.0 to 1166.0)	0.3	0.6	0.3	0.05 to 0.8
		0.4	0.9	0.4	
Pt 1000 385	-200.0 to 100.0 (-328.0 to 212.0) 100.0 to 630.0 (212.0 to 1166.0)	0.2	0.4	0.2	0.05 to 0.4
		0.2	0.5	0.2	
Pt 100 392 (3926)	-200.0 to 630.0 (-328.0 to 1166.0)	0.3	0.5	0.3	0.1 to 3.0
Pt 100 JIS (3916)	-200.0 to 630.0 (-328.0 to 1166.0)	0.3	0.5	0.3	0.1 to 3.0

Addresses pulsed transmitters and PLCs with pulses as short as 5 ms.

Allowable Excitation is for Output mode only. It shows the allowable excitation current from an ohmmeter or RTD measurement device connected to the calibrator.

Excitation current from 712: 0.2 mA.

Maximum input voltage: 30 V

General Specifications

Resolution: RTD: 0.1°C, 0.1°F. Ohms: 0.1Ω

Maximum voltage applied between any terminal and earth ground or between any two terminals: 30 V

Storage temperature: -20°C to 60°C

Operating temperature: -10°C to 55°C

Operating altitude: 3000 meters maximum

Temperature coefficient: 0.005% of ohms range per °C for temperature ranges -10°C to 18°C and 28°C to 55°C. Ohms ranges are 400 Ω, 1.5 kΩ, and 3.2 kΩ.

Relative humidity: 95% up to 30°C, 75% up to 40°C, 45% up to 50°C, and 35% up to 55°C

Vibration: Random 2 g, 5 Hz to 500 Hz

Shock: 1 meter drop test

Safety: Certified as compliant to CAN/CSA C22.2 No. 1010.1:1992. Complies with ANSI/ISA S82.01-1994.

Power requirements: Single 9 V battery (ANSI/NEDA 1604A or IEC 6LR61)

Size: 32 mm H x 87 mm W x 187 mm L (1.25 in H x 3.41 in W x 7.35 in L);

With holster and Flex-Stand: 52 mm H x 98 mm W x 201 mm L (2.06 in H x 3.86 in W x 7.93 in L)

Weight: 337 g (11.9 oz);

With holster and Flex-Stand: 587 g (20.7 oz)

How to Contact Fluke

To order accessories, receive operating assistance, or get the location of the nearest Fluke distributor or Service Center, call:

To contact Fluke, call one of the following telephone numbers:

USA: 1-888-99-FLUKE (1-888-993-5853)

Canada: 1-800-36-FLUKE (1-800-363-5853)

Europe: +31 402-675-200

Japan: +81-3-3434-0181

Singapore: +65-738-5655

Anywhere in the world: +1-425-446-5500

Or, visit Fluke's Web site at www.fluke.com.

To register your product, visit register.fluke.com

Address correspondence to:

Fluke Corporation
P.O. Box 9090,
Everett, WA 98206-9090
U.S.A.

Fluke Europe B.V.
P.O. Box 1186,
5602 BD Eindhoven
The Netherlands

LIMITED WARRANTY & LIMITATION OF LIABILITY

This Fluke product will be free from defects in material and workmanship for three years from the date of purchase. This warranty does not cover fuses, disposable batteries or damage from accident, neglect, misuse or abnormal conditions of operation or handling. Resellers are not authorized to extend any other warranty on Fluke's behalf. To obtain service during the warranty period, send your defective calibrator to the nearest Fluke Authorized Service Center with a description of the problem.

THIS WARRANTY IS YOUR ONLY REMEDY. NO OTHER WARRANTIES, SUCH AS FITNESS FOR A PARTICULAR PURPOSE, ARE EXPRESSED OR IMPLIED. FLUKE IS NOT LIABLE FOR ANY SPECIAL, INDIRECT, INCIDENTAL OR CONSEQUENTIAL DAMAGES OR LOSSES, ARISING FROM ANY CAUSE OR THEORY. Since some states or countries do not allow the exclusion or limitation of an implied warranty or of incidental or consequential damages, this limitation of liability may not apply to you.



**205 Westwood Ave
Long Branch, NJ 07740
1-877-742-TEST (8378)
Fax: (732) 222-7088
salesteam@Tequipment.NET**