

FLUKE®

718Ex 30G/100G/300G

Pressure Calibrator

Tequipment
_____.NET



205 Westwood Ave
Long Branch, NJ 07740
1-877-742-TEST (8378)
Fax: (732) 222-7088
salesteam@Tequipment.NET

Users Manual

May 2004 Rev. 2, 5/09

© 2004-2009 Fluke Corporation. All rights reserved. Specifications are subject to change without notice.

All product names are trademarks of their respective companies.

LIMITED WARRANTY AND LIMITATION OF LIABILITY

Each Fluke product is warranted to be free from defects in material and workmanship under normal use and service. The warranty period is three years (one year for pump assembly) and begins on the date of shipment. Parts, product repairs, and services are warranted for 90 days. This warranty extends only to the original buyer or end-user customer of a Fluke authorized reseller, and does not apply to fuses, disposable batteries, or to any product which, in Fluke's opinion, has been misused, altered, neglected, contaminated, or damaged by accident or abnormal conditions of operation or handling. Fluke warrants that software will operate substantially in accordance with its functional specifications for 90 days and that it has been properly recorded on non-defective media. Fluke does not warrant that software will be error free or operate without interruption.

Fluke authorized resellers shall extend this warranty on new and unused products to end-user customers only but have no authority to extend a greater or different warranty on behalf of Fluke. Warranty support is available only if product is purchased through a Fluke authorized sales outlet or Buyer has paid the applicable international price. Fluke reserves the right to invoice Buyer for importation costs of repair/replacement parts when product purchased in one country is submitted for repair in another country.

Fluke's warranty obligation is limited, at Fluke's option, to refund of the purchase price, free of charge repair, or replacement of a defective product which is returned to a Fluke authorized service center within the warranty period.

To obtain warranty service, contact your nearest Fluke authorized service center to obtain return authorization information, then send the product to that service center, with a description of the difficulty, postage and insurance prepaid (FOB Destination). Fluke assumes no risk for damage in transit. Following warranty repair, the product will be returned to Buyer, transportation prepaid (FOB Destination). If Fluke determines that failure was caused by neglect, misuse, contamination, alteration, accident, or abnormal condition of operation or handling, including overvoltage failures caused by use outside the product's specified rating, or normal wear and tear of mechanical components, Fluke will provide an estimate of repair costs and obtain authorization before commencing the work. Following repair, the product will be returned to the Buyer transportation prepaid and the Buyer will be billed for the repair and return transportation charges (FOB Shipping Point).

THIS WARRANTY IS BUYER'S SOLE AND EXCLUSIVE REMEDY AND IS IN LIEU OF ALL OTHER WARRANTIES, EXPRESS OR IMPLIED, INCLUDING BUT NOT LIMITED TO ANY IMPLIED WARRANTY OF MERCHANTABILITY OR FITNESS FOR A PARTICULAR PURPOSE. FLUKE SHALL NOT BE LIABLE FOR ANY SPECIAL, INDIRECT, INCIDENTAL, OR CONSEQUENTIAL DAMAGES OR LOSSES, INCLUDING LOSS OF DATA, ARISING FROM ANY CAUSE OR THEORY.

Since some countries or states do not allow limitation of the term of an implied warranty, or exclusion or limitation of incidental or consequential damages, the limitations and exclusions of this warranty may not apply to every buyer. If any provision of this Warranty is held invalid or unenforceable by a court or other decision-maker of competent jurisdiction, such holding will not affect the validity or enforceability of any other provision.

Fluke Corporation
P.O. Box 9090
Everett, WA 98206-9090
U.S.A.

Fluke Europe B.V.
P.O. Box 1186
5602 BD Eindhoven
The Netherlands

To register your product online, visit register.fluke.com

Table of Contents

Title	Page
Introduction.....	1
How to Contact Fluke	2
Safety Information	2
Faults and Damage	7
Safety Regulations.....	8
Certification Information.....	9
Getting Acquainted with the Calibrator	9
Power Saver	11
Zeroing with Absolute Pressure Modules	11
Calibrating a P/I Transmitter.....	13
Using the Internal Pump	13
Using an External Pump	17
External Fluke Pressure Module Compatibility	19
Cleaning the Pump Valve Assembly.....	20
Switch Test.....	20
Maintenance.....	21
In Case of Difficulty.....	21
Cleaning	22

Calibration.....	22
Replacing the Battery.....	22
Approved Batteries.....	23
Parts and Accessories.....	24
Specifications.....	25
Pressure Sensor Input.....	25
Pressure Sensor Range and Resolution.....	25
Pressure Module Input.....	26
DC mA Input.....	26
General Specifications.....	26
Product Compliance Markings.....	27

List of Tables

Table	Title	Page
1.	International Electrical Symbols	3
2.	Pushbutton Functions	10
3.	Pump Features	12
4.	Recommended Pressure Modules	17
5.	Fluke Pressure Module Compatibility	19
6.	Replacement Parts and Accessories	24

List of Figures

Figure	Title	Page
1.	Connection Technique.....	7
2.	Front Panel Features.....	9
3.	Pump Features.....	12
4.	Internal Pressure Sensor with Internal Pump.....	15
5.	Pressure Module with Internal Pump.....	16
6.	Pressure Module with External Pump.....	18
7.	Battery Replacement.....	22

718Ex 30G/100G/300G Pressure Calibrator

Introduction

Warning

Read Safety Information before using the Calibrator.

The Fluke Model 718Ex 30G, 718Ex 100G, and 718Ex 300G Pressure Calibrators (hereafter called Calibrator) can do the following:

Calibrate P/I (pressure to current) transmitters.

- Measure pressure via a 1/8-inch NPT pressure fitting and an internal pressure sensor or via Fluke 700PEX Series Pressure Modules.
- Measure current up to 24 mA.
- Simultaneously display pressure and current measurements.
- Perform switch testing.

The Calibrator is for use ONLY in Ex-hazardous areas.

The Calibrator makes 5-digit pressure readings in the following units: psi, inH₂O at 4 °C, inH₂O at 20 °C, kPa, cmH₂O at 4 °C, cmH₂O at 20 °C, bar, mbar, kg/cm², inHg, and mmHg. Full-scale pressure sensor input is as follows:

- Model 718Ex 30G: 30 psi (206.85 kPa, 2.0685 bar).
OL appears at 33 psi.
- Model 718Ex 100G: 100 psi (689.5 kPa, 6.895 bar).
OL appears at 120 psi.
- Model 718EX 300G: 300 psi (2068 kPa, 20.68 bar).
OL appears at 360 psi.

The Calibrator measures pressure sensor inputs in the units shown under Pressure Sensor Range and Resolution.

For Pressure Modules, full-scale readings for all pressure ranges can be made in psi, kPa, and inHg units. To avoid display overflow, full-scale readings are limited to

1000 psi in cmH₂O, mbar, and mmHg units, and 3000 psi in inH₂O units. Pressures of at least 15 psi must be measured for meaningful readings in bar and kg/cm² units.

The Calibrator is supplied with:

- a holster
- one installed 9 V alkaline battery
- one set of TL75 test leads
- one set of AC72A alligator clips
- a Control Drawing
- a CD-Rom

If the Calibrator is damaged or something is missing, contact the place of purchase immediately. Contact a Fluke distributor for information about accessories. See Contacting Fluke. To order replacement parts or spares, see Parts and Accessories.

How to Contact Fluke

To contact Fluke, call one of the following telephone numbers:

Technical Support USA: 1-800-44-FLUKE
(1-800-443-5853)

Calibration/Repair USA: 1-888-99-FLUKE
(1-888-993-5853)

Canada: 1-800-36-FLUKE (1-800-363-5853)

Europe: +31 402-675-200

Japan: +81-3-3434-0181

Singapore: +65-738-5655

Anywhere in the world: +1-425-446-5500

Or, visit Fluke's website at www.fluke.com.

To register your product, visit <http://register.fluke.com>.













To view, print, or download the latest manual supplement, visit <http://us.fluke.com/usen/support/manuals>.

Safety Information

A **Warning** identifies conditions and actions that pose hazard(s) to the user; a **Caution** identifies conditions and actions that may damage the Calibrator or the equipment under test.

Safety and electrical symbols used in this manual and on the Calibrator are displayed in Table 1.

Table 1. International Electrical Symbols

Symbol	Meaning
	Power ON/OFF
	Earth ground
	Conforms to ATEX requirements.
	Battery
	Hazardous Voltage
	Risk of Danger. Important information. Refer to manual.
	Double insulated
	Conforms to relevant Canadian and US Standards.
	Conforms to relevant European Union directives.
	Pressure
	Do not dispose of this product as unsorted municipal waste. Go to Fluke's website for recycling information.
	Conforms to relevant Australian standards.

⚠ ⚠ Warning

To avoid electric shock, injury, or damage to the Calibrator:

- Use the Calibrator only as described in this User Manual and the Fluke 718Ex CCD (Concept Control Drawing) or the protection provided by the Calibrator may be impaired.
- Inspect the Calibrator before use. Do not use it if it appears damaged.
- Check the test leads for continuity, damaged insulation, or exposed metal. Replace damaged test leads.
- When using probes, keep fingers behind the finger guards on the probes
- Never apply more than 30.0 V between the input terminals, or between any terminal and earth ground.
- Applying more than 30.0 V to the input terminals invalidates the Calibrator's Ex Approval and may result in permanent damage to the unit so it can no longer be used.
- Use the proper terminals, mode, and range for the measuring or sourcing application.
- To prevent damage to the unit under test, be sure the Calibrator is in the correct mode before connecting the test leads.
- When making connections, connect the COM test probe before the live test probe. When disconnecting, disconnect the live probe before the COM probe.
- Never use the Calibrator with the red holster removed.
- Never open the Calibrator case. Opening the case invalidates the Calibrator's Ex Approval.
- Make sure the battery door is closed before using the Calibrator.
- Replace the battery as soon as the **+■** (low battery) symbol appears to avoid false readings that can lead to electric shock. Remove the Calibrator from the Ex-hazardous area before opening the battery door.

- Remove test leads from the Calibrator before opening the battery door.
- This equipment is specified for use in measurement category I (CAT I) pollution degree 2 environments and should not be used in CAT II, CAT III, or CAT IV environments. Voltage transients should not exceed 300 volts for the CAT I applications where this product is used. Measurement transients are defined in IEC1010-1 as 2 μ s rise time with a 50 μ s duration at 50 % of the maximum amplitude height.
- Measurement Category I (CAT I) is defined for measurements performed on circuits not directly connected to the mains.
- Turn off circuit power before connecting the Calibrator mA and COM terminals in the circuit. Place Calibrator in series with the circuit.
- When servicing the Calibrator, use only specified replacement parts. Do not open the Calibrator case. Opening the case invalidates the Calibrator's Ex Approval.
- Do not allow water inside the case.
- Do not use in a damp or wet environment.
- When using the Calibrator's internal pressure sensor, do not connect a pressure module at the Calibrator to avoid misleading readings. If both a pressure module and the internal pressure sensor are connected, the Calibrator displays ONLY the pressure module measurement. To avoid misleading readings, disconnect the pressure module connector at the Calibrator.
- To avoid a violent release of pressure in a pressurized system, shut off the valve and slowly bleed off the pressure before attaching or detaching the internal pressure sensor or pressure module fitting to the pressure line.
- To avoid overpressure damage, do not apply pressure to the internal pressure sensor input that exceeds the following:

- **Model 718Ex 30G: 30.000 psi, 206.85 kPa, or 2.0685 bar. OL appears at 33 psi.**
- **Model 718Ex 100G: 100.00 psi, 689.5 kPa, or 6.895 bar. OL appears at 120 psi.**
- **Model 718EX 300G: 300.00 psi, 2068 kPa, or 20.68 bar. OL appears at 360 psi.**
- **When measuring the pressure of potentially hazardous gases, care must be taken to minimize the possibility of leakage:**
 - **Confirm that all pressure connections are properly sealed.**
 - **Confirm that the Pressure/Vacuum Release Control is in the closed position (fully clockwise) and the Pressure/Vacuum switch is in the + position (fully clockwise).**
 - **If the Calibrator has been dropped or subjected to rough handling, remove the Calibrator to a safe area and check for leaks to confirm the integrity of the internal pneumatic components.**
- **Do not use a Model 718Ex (including 718Ex 300G) to measure potentially hazardous gases at pressure greater than 100 psi (6.9 bar).**

 Caution

To avoid mechanically damaging the Calibrator:

- **Do not apply torque between the pressure fitting and the Calibrator case. See Figure 1 for the proper use of tools.**
- **To avoid damage to the pump, use with dry air and non-corrosive gases only.**

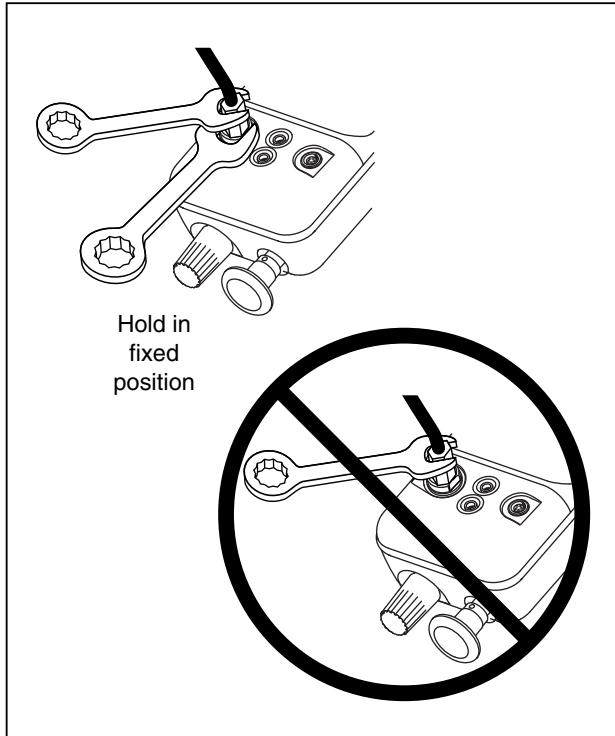

Figure 1. Connection Technique

Faults and Damage

Applying a voltage greater than 30 V to the input of the Calibrator invalidates its Ex Approval and may impair its safe operation in an Ex-hazardous area.

If there is any reason to suspect that the safe operation of the Calibrator has been affected, it must be immediately withdrawn from use, and precautionary measures must be taken to prevent any further use of the Calibrator in an Ex-hazardous area.

Fully observe all instructions, warnings, and cautions contained in this manual. In case of doubt due to translation and/or printing errors, refer to the original English users manual.

The safety features and integrity of the unit may be compromised by any of the following:

- External damage to the housing
- Internal damage to the Calibrator
- Exposure to excessive loads
- Incorrect storage of the unit
- Damage sustained in transit
- Correct certification is illegible
- Using the product with the red holster removed
- Functioning errors occur
- Permitted limitations are exceeded
- Functioning errors or obvious measurement inaccuracies occur which prevent further measurement by the Calibrator
- Opening the case

Safety Regulations

The use of the Calibrator meets the requirements of the regulations providing that the user observes and applies the requirements as stated in the regulations and that improper and incorrect use of the unit is avoided.

- Use must be restricted to the specified application parameters.
- Do not open the Calibrator.
- Do not remove or install the battery within the Ex-hazardous area.
- Do not carry additional batteries within the Ex-hazardous area.
- Use only type-tested batteries. The use of any other batteries will invalidate the Ex-certification and present a safety risk.
- Do not use the Calibrator in an Ex-hazardous area unless it is completely and securely fitted in its accompanying red holster.
- Only use the Calibrator in circuits with compatible entity parameters.

Certification Information



II 1 G EEx ia IIC T4

Permitted for Zone 0 Equipment Group II, gas group IIC hazardous atmospheres, temperature class T4



Class I Div. 1 Groups A-D T4 Intrinsically Safe AEx ia IIC T4

Permitted for Division 1 hazardous atmospheres, Gas Groups A-D, temperature class T4

Getting Acquainted with the Calibrator

Press **Ⓢ** to turn the Calibrator on and off. The Calibrator displays pressure and current measurements simultaneously. See Figure 2.

The upper part of the display shows the applied pressure or vacuum. Vacuum is shown as a negative value. Press **UNITS** to select a different unit. When cycling the power off and on, the Calibrator retains the unit last used.

The lower part of the display shows the current (up to 24 mA) applied to the current (mA) inputs.

Pushbutton operation is described in Table 2. Pump features are shown in Figure 3 and described in Table 3.

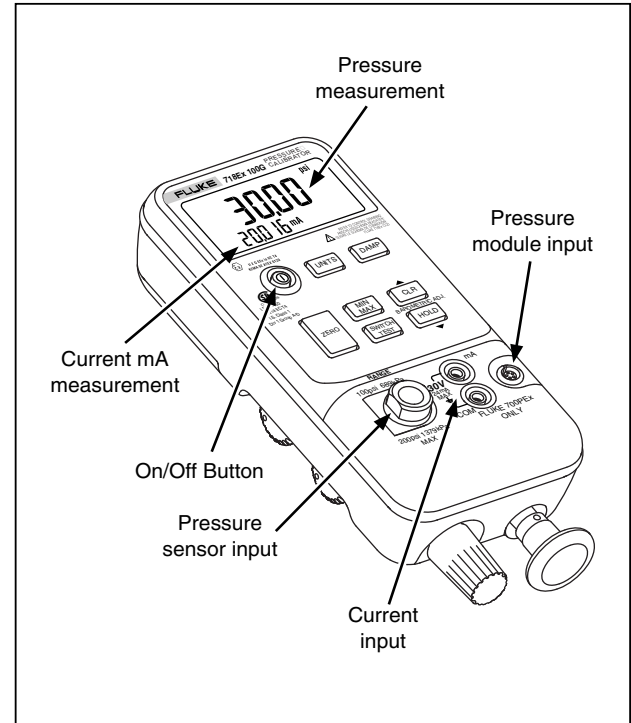













Figure 2. Front Panel Features

alz005f.eps

Table 2. Pushbutton Functions

Pushbutton	Description
	Press to select a different pressure unit. All units are available when the pressure sensor input is used. For higher pressure module inputs, inappropriate (out-of-range) units are not available.
	Turns pressure reading damping on and off. With damping on, the Calibrator averages several measurements before displaying a reading.
	Press to zero the pressure display. Vent pressure to atmosphere before pressing this pushbutton. For an Absolute Pressure Module, see Zeroing with Absolute Pressure Modules.
	Press to read the minimum pressure and current readings since power was turned on or  was pressed. Press again to read the maximum pressure and current readings since power was turned on or  was pressed.
	Use for pressure switch test. See Switch Test.
	Press to clear the MIN, MAX, and switch test memories
	Press  to freeze the display. The HOLD symbol appears on the display. Press  again to resume normal operation.



205 Westwood Ave
 Long Branch, NJ 07740
 1-877-742-TEST (8378)
 Fax: (732) 222-7088
 salesteam@Tequipment.NET

Power Saver

The Calibrator automatically turns off after 30 minutes of inactivity. To reduce this time or disable this feature:

1. With the Calibrator OFF, press **Ⓞ**.

P.S. xx is displayed, where **xx** is the turn-off time in minutes. **OFF** means the power saver is disabled.

2. Press **[HOLD]** to decrease or **[CLR]** to increase the turn-off time.
3. To disable, press **[HOLD]** until the display shows **OFF**.

The Calibrator resumes normal operation after 2 seconds.

Zeroing with Absolute Pressure Modules

For zeroing, adjust the Calibrator to read a known pressure. This can be barometric pressure, if it is accurately known. An accurate pressure standard can also apply a pressure within range for any Absolute Pressure Module. Adjust the Calibrator reading as follows:

1. Press and hold **[ZERO]**.
2. Press **[HOLD]** to increase or **[HOLD]** to decrease the Calibrator reading to equal the applied pressure.
3. Release **[ZERO]** to exit the zeroing procedure.

Press the **[UNITS]** button to convert to any convenient measurement display unit.

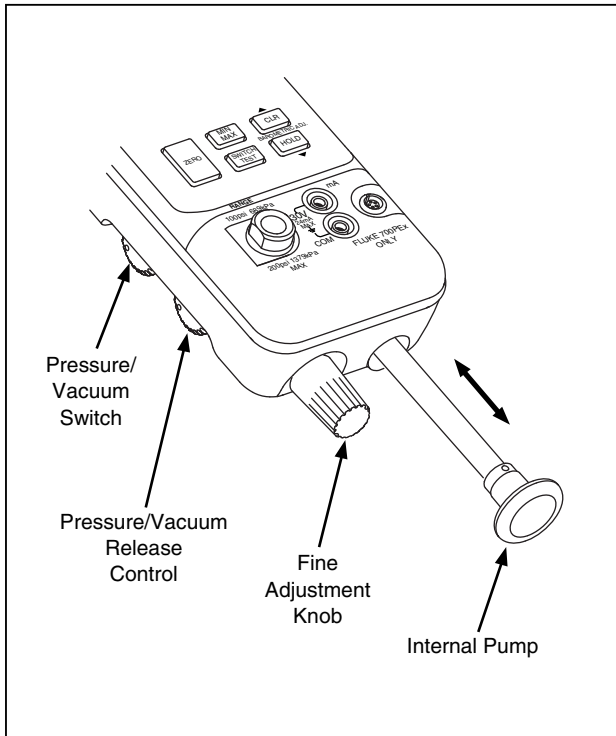

Figure 3. Pump Features

alz009f.eps

Table 3. Pump Features

Item	Description
Pressure Vacuum Switch	Rotate forward (clockwise) for pressure, backward (counter-clockwise) for vacuum.
Pressure Vacuum Release Control	Rotate fully backward (counter-clockwise) to release all pressure or vacuum. (Rotate slightly for partial release.) Rotate fully forward (clockwise) to close valve.
Fine Adjustment Knob	Rotate either direction for precise adjustment of applied pressure or vacuum. Full rotation is about 30 turns.
Internal Pump	Increase pressure on the inward stroke. In vacuum mode, decrease pressure on the outward stroke.

Calibrating a P/I Transmitter

To calibrate a P/I (pressure to current) transmitter, apply a pressure to the transmitter and measure the transmitter's current loop output. Pressure can be applied with the Calibrator's internal pump or with an external pump.

⚠ ⚠ Warning

To avoid a violent release of pressure or vacuum, always depressurize the system slowly using the pressure/vacuum release control before detaching any pressure line.

When measuring the pressure of potentially hazardous gases, care must be taken to minimize the possibility of leakage:

- **Confirm that all pressure connections are properly sealed.**
- **Confirm that the Pressure/Vacuum Release Control is in the closed position (fully clockwise) and the Pressure/Vacuum switch is in the + position (fully clockwise).**

- **If the Calibrator has been dropped or subjected to rough handling, remove the Calibrator to a safe area and check for leaks to confirm the integrity of the internal pneumatic components.**

Using the Internal Pump

The internal pump can provide 30 psi (2.0685 bar) for Model 718Ex 30G, 100 psi (6.895 bar) for Model 718Ex 100G, or 300 psi (20.68 bar) for Model 718Ex 300G.

The preferred use for the internal pump is shown in Figure 4, where the Calibrator displays pressure measured with the internal sensor and provided by the internal pump.

The internal pump can also be used with certain Fluke 700PEX Series Pressure Modules. In this case, pressure measured by the pressure module is displayed by the Calibrator. Appropriate pressure modules for each Calibrator model are identified in Table 4. Figure 5 shows the internal pump being used with a pressure module.

⚠ ⚠ Warning

If both a pressure module and the internal sensor are connected, the Calibrator displays ONLY the pressure module measurement.

To use the Calibrator's internal pump, refer to Figure 3 and perform the following steps:

1. Depressurize the line before connecting the Calibrator.
2. Connect the pressure transmitter under test to the Calibrator internal sensor as shown in Figure 4 (for internal pressure sensor measurements) or Figure 5 (for pressure module measurements.)

Note

To avoid leaks, use Teflon tape or similar sealant on all pressure connections.

3. Make sure the pressure/vacuum switch on the Calibrator is in the desired position. Forward (clockwise) is for pressure; backward (counter-clockwise) is for vacuum.
4. Turn the pressure/vacuum release control backward (counter-clockwise) to vent pressure/vacuum from the pump.

5. Press **ZERO** to zero the pressure display.
6. Turn the fine adjustment knob to mid-range.
7. Turn the pressure/vacuum release control forward (clockwise) to close the release valve.
8. Work the pump handle in and out to apply incrementally larger pressure/vacuum changes. Shorten the stroke to apply smaller increments of pressure/vacuum change.
9. To make very small pressure/vacuum changes, use the fine adjustment knob.

Note

This knob adjusts a small internal reservoir to vary the total volume. With larger external pressure/vacuum volumes, this control will adjust pressure or vacuum within a smaller range.

10. Depressurize the system before disconnecting the pressure line.

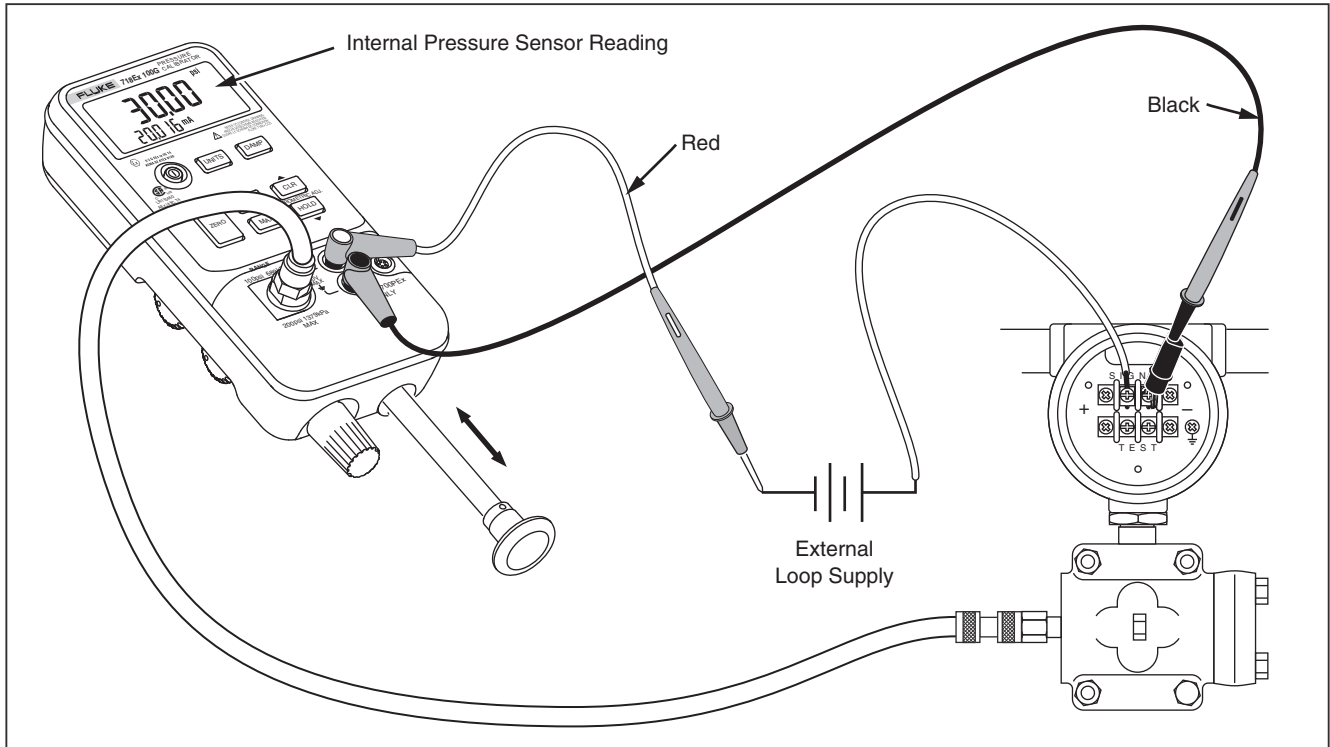

Figure 4. Internal Pressure Sensor with Internal Pump

alz002f.eps

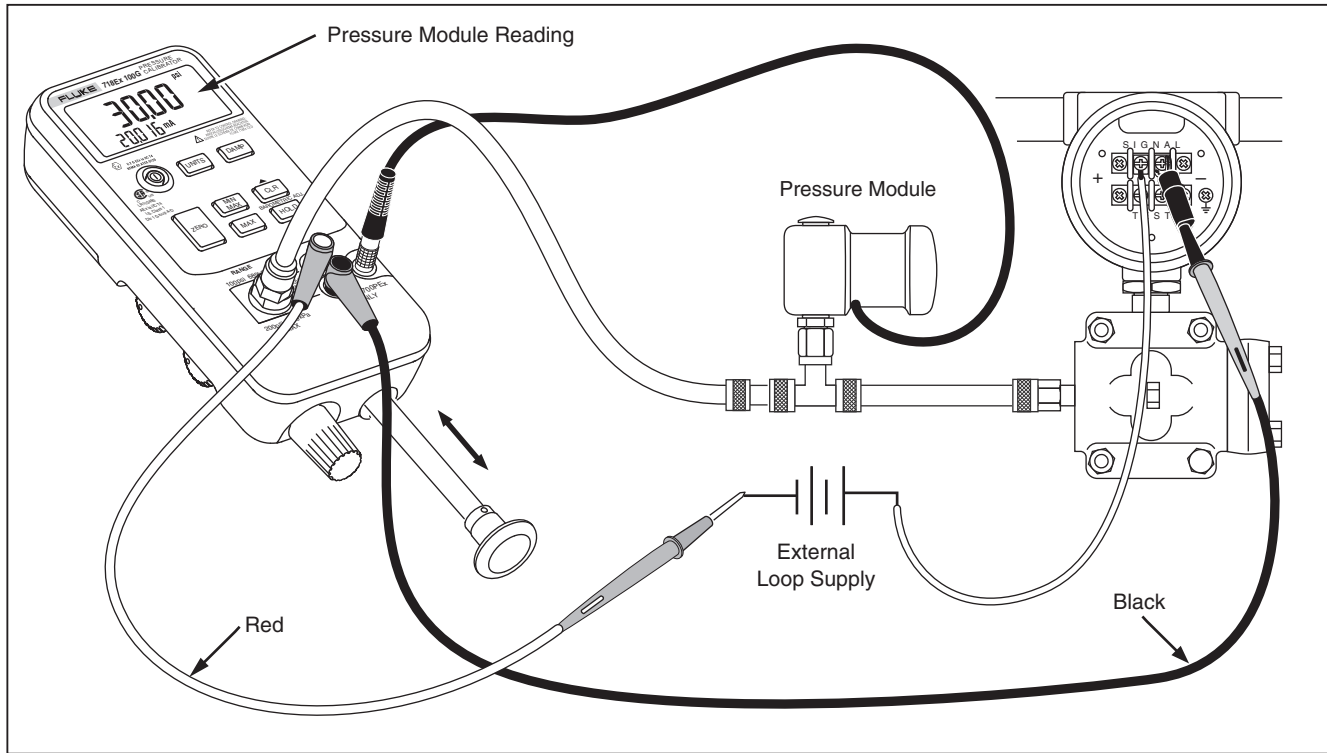

Figure 5. Pressure Module with Internal Pump

Table 4. Recommended Pressure Modules

Pressure Module	External Pump	Internal Pump		
	718Ex 30G/100G/ 300G	718Ex 30G	718Ex 100G	718Ex 300G
700P01Ex	X	X	X	X
700P24Ex	X	X	X	X
700P05Ex	X	X	X	X
700P06Ex	X		X	X
700P27Ex	X			X
700P09Ex	X			
700PA4Ex	X	X	X	X
700P29Ex	X			

Using an External Pump

⚠ ⚠ Warning

To avoid damage to the Calibrator and possible release of pressure, do not connect the internal sensor to an external pressure source that exceeds 30 psi for Model 718Ex 30G, 100 psi for Model 718Ex 100G, or 300 psi for Model 718Ex 300G.

To develop higher pressure or vacuum, use an external pump. Use a Fluke 700PEX Pressure Module connected to the pressure module input on the Calibrator. Pressure modules are listed in Table 4. Make overall connections as shown in Figure 6.

Refer to setup and operating instructions included with the pressure module and pump.

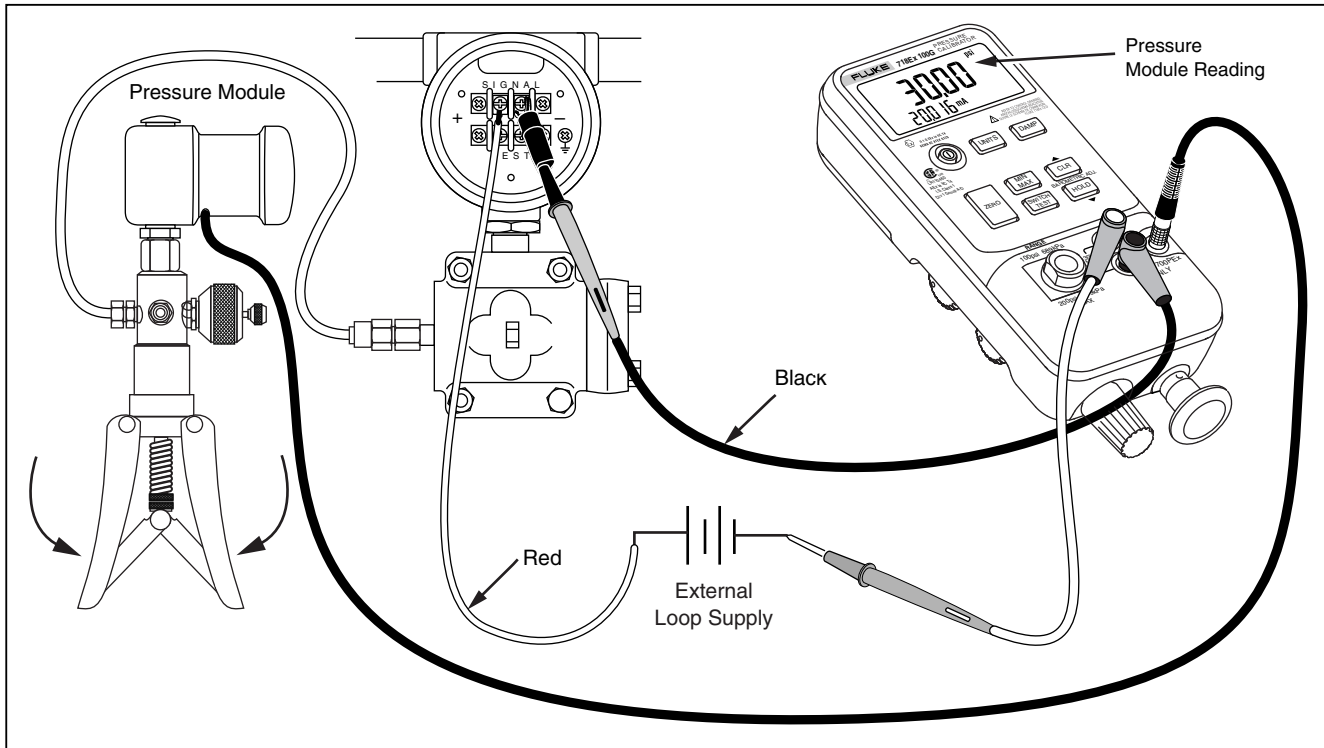

Figure 6. Pressure Module with External Pump

alz006f.eps

External Fluke Pressure Module Compatibility

If inappropriate units are selected, the output of Fluke 700PEx pressure modules can cause the Calibrator display to overflow (OL), or display values that are too low to be read. Refer to Table 5 for appropriate unit and range compatibility.

Table 5. Fluke Pressure Module Compatibility

Pressure Unit	Module Compatibility
psi	Available on all pressure ranges
inH ₂ O	All ranges through 3000 psi
cmH ₂ O	All ranges through 1000 psi
bar	15 psi and above
mbar	All ranges through 1000 psi
kPa	Available on all pressure ranges
inHg	Available on all pressure ranges
mmHg	All ranges through 1000 psi
kg/cm ²	15 psi and above

Cleaning the Pump Valve Assembly

1. Using a small screwdriver, remove the two valve retention caps located in the oval-shaped opening on the back side of the Calibrator.
2. Gently remove the spring and o-ring assembly.
3. Set aside the valve assemblies in a safe area and clean out the valve body using a cotton swab soaked in IPA (isopropyl alcohol).
4. Repeat this process several times using a new cotton swab each time until there is no remaining residue.
5. Pump the unit several times and check again for residue.
6. Clean the o-ring assembly and the o-ring on the retention caps with IPA and inspect the o-rings closely for any cuts, nicks, or wear. Replace if needed.
7. Inspect the springs for wear or loss of tension. They should be approximately 8.6 mm long in the relaxed state. If they are shorter than that, they may not allow the o-ring to seat properly. Replace if needed.
8. Once all parts have been cleaned and inspected, reinstall the o-ring and spring assemblies into the valve body.

9. Reinstall the retention caps and gently tighten the cap.
10. Seal the output of the Calibrator and pump up the unit to at least 50 % its rated pressure.
11. Release the pressure and repeat several times to ensure that the o-rings seat properly.

The Calibrator is now ready to use.

Switch Test

To perform a switch test, follow these steps:

Note



This example used a normally closed switch. The procedure is the same for an open switch but the display reads OPEN instead of CLOSE.

1. Connect the Calibrator mA and COM terminals to the switch using the pressure switch terminals and connect the pump from the Calibrator to the pressure switch. The polarity of the terminals does not matter.
2. Make sure the vent on the pump is open and zero the Calibrator if necessary. Close the vent after zeroing the Calibrator.

3. Press  to enter pressure switch test mode. The Calibrator will display CLOSE instead of a mA measurement.
4. Apply pressure with the pump slowly until the switch opens.

Note

In the switch test mode, the display update rate is increased to help capture changing pressure inputs. Even with this enhanced sample rate, pressuring the device under test should be done slowly to ensure accurate readings.

5. OPEN is displayed once the switch is open. Bleed the pump slowly until the pressure switch closes. RCL appears on the display.
6. Press  to read the pressure values for when the switch opened, for when it closed, and for the deadband.
7. Hold  for three seconds to exit the switch test or press  to reset the switch test.

Maintenance

Warning

To avoid possible electric shock, personal injury, or sudden release of pressure, review Safety Information before proceeding.

For maintenance procedures not described in this manual, or if the Calibrator needs repair, contact a Fluke Service Center. See Contacting Fluke.

In Case of Difficulty

- After removing the Calibrator from the Ex-hazardous area, check the battery, test leads, pressure module, and pressure tubing. Follow replacement and connection instructions properly.
- Review this manual and control drawing to make sure the Calibrator is used correctly.

If the Calibrator needs repair, and the Calibrator is under warranty, see the warranty statement for terms. If the warranty has lapsed, the Calibrator can be repaired and returned for a fixed fee.

Cleaning

Periodically wipe the case with a damp cloth; do not use abrasives or solvents.

Calibration

Fluke recommends that the Calibrator be calibrated once yearly to ensure that it performs according to its specifications. A calibration manual is available. Call 1-800-526-4731 from the U.S.A. and Canada. In other countries, contact a Fluke Service Center.

Replacing the Battery

Warning

- To avoid false readings, which could lead to possible electric shock or personal injury, replace the battery as soon as the battery indicator  appears.
- Remove the Calibrator from the Ex-hazardous area before opening the battery door.
- Use only the battery types listed in the Approved Battery Table.

When  appears on the display, replace the 9 V alkaline battery. Refer to Figure 7.

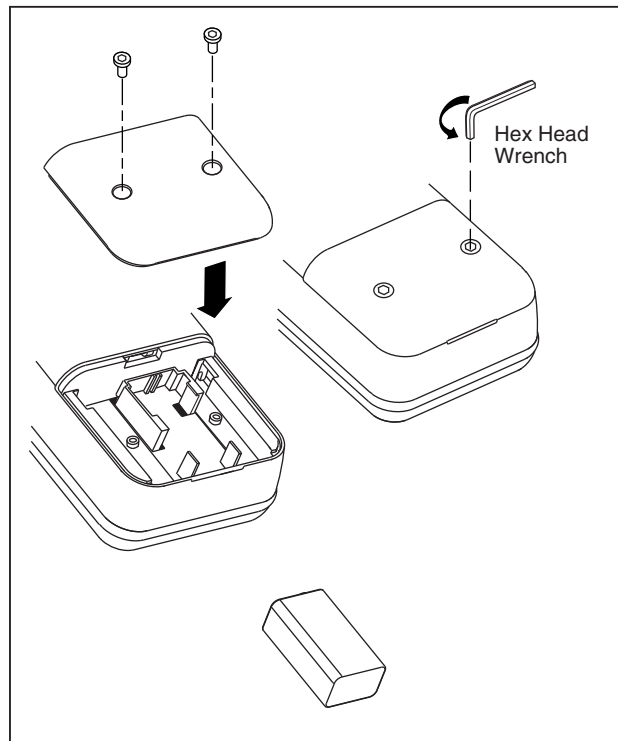

alz008f.eps

Figure 7. Battery Replacement

Approved Batteries

Battery	Manufacturer	Type
Alkaline, 9 volt	Duracell	6LR61/MN1604
Alkaline Ultra, 9 volt	Duracell	6LR61/MX1604
Alkaline Energizer, 9 volt	Eveready	6LR61/522
Alkaline Power Line Industrial Battery, 9 volt	Panasonic	6LR61.9V

Parts and Accessories

Refer to Table 6 for a list of replacement parts and accessories.

Table 6. Replacement Parts and Accessories

Model No.	Description	Part	Qty
AC72	Alligator clips (Black)	1670652	1
AC72	Alligator clips (Red)	1670641	1
BT1	9 V battery, ANSI/NEDA 1604A or IEC 6LR61	822270 or see Battery Table	1
Holster	Holster, Red	2096118	1
-	Battery Door Assembly	2117013	1
-	Test lead set	855742	1
-	718Ex CD-ROM (contains Users Manual)	2097427	1
-	71X Series Calibration Manual	686540	Opt
-	718Ex Control Drawing	2117024	1

Specifications

Specifications are based on a one year calibration cycle and apply for ambient temperature from +18 °C to +28 °C unless stated otherwise. Counts are the number of increments or decrements of the least significant digit.

Pressure Sensor Input

Model	Range	Accuracy	Max Non-destructive Pressure
30G	-12 to 30 psi (-83 to 207 kPa)	±0.05 % of range	60 psi (413 kPa)
100G	-12 to 100 psi (-83 to 690 kPa)		200 psi (1.4 mPa)
300G	-12 to 300 psi (-83 to 2068 kPa)		375 psi (2.6 mPa)
<i>Temperature coefficient: 0.01 % of range per °C for temperature ranges -10 °C to 18 °C and 28 °C to 55 °C</i>			

Pressure Sensor Range and Resolution

Displayed Pressure Units	Model 718Ex 30G Range and Resolution	Model 718Ex 100G Range and Resolution	Model 718Ex 300G Range and Resolution
psi	-12.000 to 30.000 psi	-12.00 to 100.00 psi	-12.00 to 300.00 psi
inH ₂ O at 4 °C	-332.16 to 830.40 inH ₂ O	-332.2 to 2768.0 inH ₂ O	-332.2 to 8304 inH ₂ O
inH ₂ O at 20 °C	-332.75 to 831.87 inH ₂ O	-332.8 to 2772.9 inH ₂ O	-332.8 to 8318.7 inH ₂ O
cmH ₂ O at 4 °C	-843.6 to 2109.0 cmH ₂ O	-843.6 to 7030.0 cmH ₂ O	-843.6 to 21090 cmH ₂ O
cmH ₂ O at 20 °C	-845.2 to 2113.0 cmH ₂ O	-845.2 to 7043.0 cmH ₂ O	-845.2 to 21129 cmH ₂ O
bar	-0.8274 to 2.0685 bar	-0.8274 to 6.8950 bar	-0.8274 to 20.685 bar
mbar	-827.4 to 2068.5 mbar	-827.4 to 6895.0 mbar	-827.4 to 20685 mbar
kPa	-82.74 to 206.85 kPa	-82.74 to 689.50 kPa	-82.74 to 2068.5 kPa
inHg	-24.432 to 61.080 inHg	-24.43 to 203.60 inHg	-24.43 to 610.8 inHg
mmHg	-620.6 to 1551.4 mmHg	-620.6 to 5171.5 mmHg	-620.6 to 15514.5 mmHg
kg/cm ²	-0.8437 to 2.1090 kg/cm ²	-0.8437 to 7.0306 kg/cm ²	-0.8437 to 21.0918 kg/cm ²

Pressure Module Input

Range	Resolution	Accuracy
(determined by Pressure Module)		

DC mA Input

Range	Resolution	Accuracy, \pm (% of Reading + Counts)
24 mA	0.001 mA	0.02 + 2
<i>Temperature coefficient: 0.005 % of range per °C for temperature ranges -10 °C to 18 °C and 28 °C to 55 °C</i>		

General Specifications

Maximum voltage applied between either mA terminal and earth ground or between the mA terminals: 30 V

Pressure sensor media: Non-corrosive gasses only

Storage temperature: -40 °C to 71 °C

Operating temperature: -10 °C to 55 °C

Relative humidity: 95 % up to 30 °C, 75 % up to 40 °C, 45 % up to 50 °C, and 35 % up to 55 °C

EMC: Complies with EN61326, Criteria C

Pollution Degree 2

Product Compliance Markings



II 1 G EEx ia IIC T4
Kema 04ATEX1061 X



Class I Div. 1 Groups A-D T4
AEx ia IIC T4

Ta = -10 °C +55 °C



Conforms to relevant Australian standards.

Manufactured by Martel Electronics Inc., 1F Commons Drive, Londonderry, NH USA

Additional Safety Information: Complies with CAN/CSA C22.2 No. 1010.2:1995. Complies with ANSI/ISA S82.01-1995. Complies with IEC 61010-1-95 CAT I, 30 V

Entity Parameters:

Vi, Ui	Ii	Pi	Ci	Li
30 V	250 mA	1.88 W	0 μF	0 mH

Vo, Uo	Io	Po	Co			Lo		
			IIC	IIB	IIA	IIC	IIB	IIA
7.14 V	1.09 mA	1.9 mW	13.5 μF	240 μF	1000 μF	1.0 H	3.0 H	8.0 H

Power requirements: See Approved Batteries.

Size: 66 mm H x 94 mm W x 216 mm L (2.60 in H x 3.70 in W x 8.5 in L)

Weight: 992 g (35 oz)

Tequipment
_____.NET



205 Westwood Ave
Long Branch, NJ 07740
1-877-742-TEST (8378)
Fax: (732) 222-7088
salesteam@Tequipment.NET