

80 Series V Multimeter Quick Reference Guide

⚠ See Users Manual for "Safety Information" and complete operating information.

Fuse Test

Test Lead Alert

🎵 + LEAD = 🔌 OK

🎵 + LEAD = ⚠

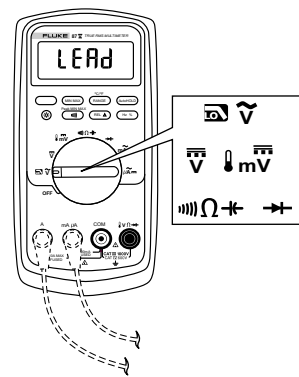
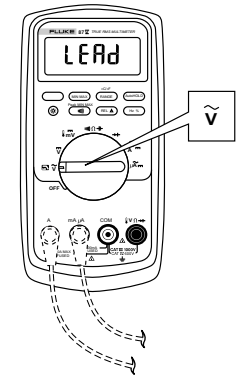

Voltage \tilde{V} \bar{V} mV

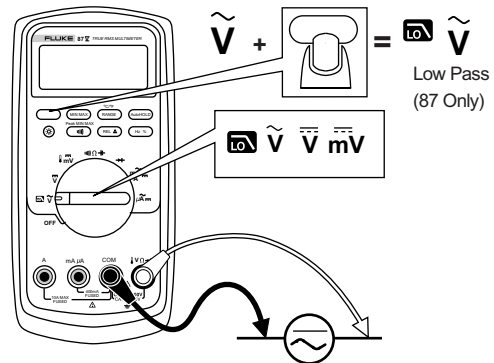

Temperature (87 Only) \downarrow

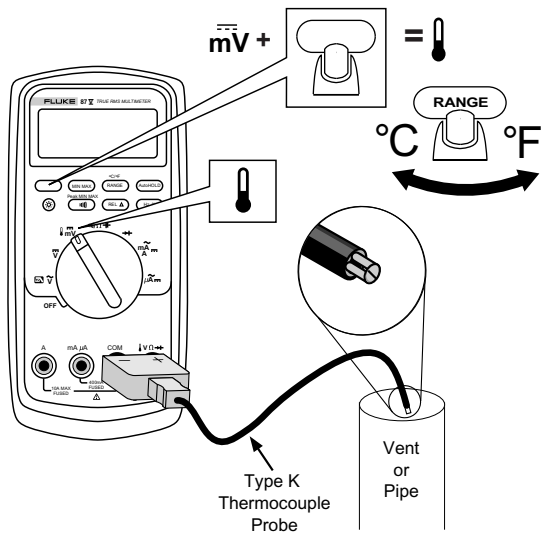

Resistance Ω

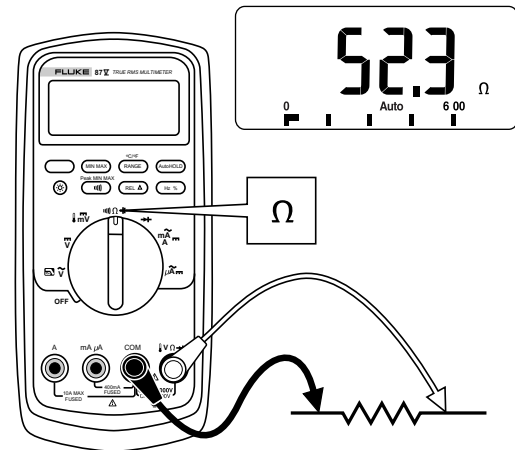

Conductance nS

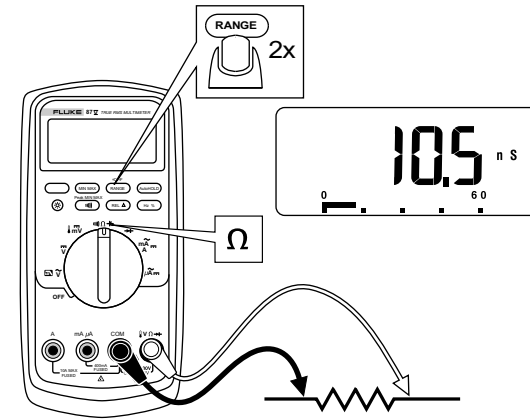

Continuity ||||

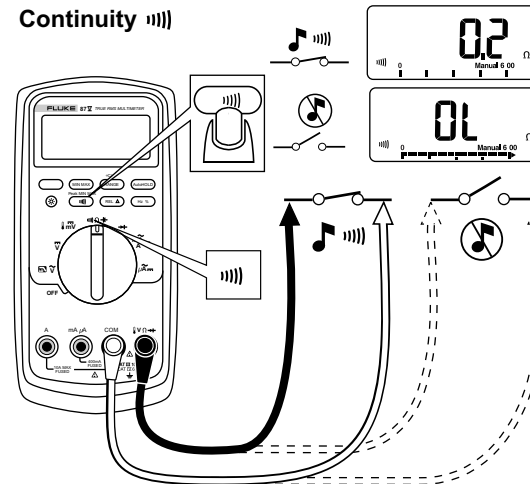

Capacitance --|<|>--

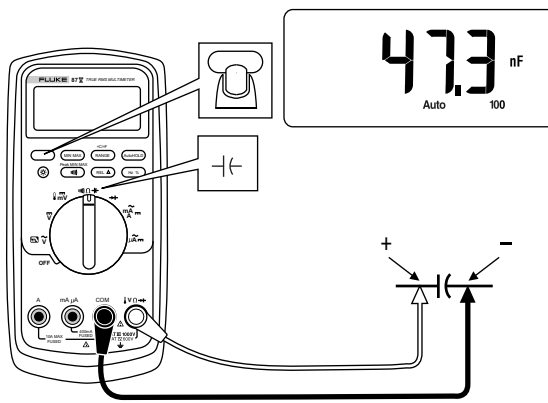

Current \tilde{A} , \bar{A} , $\mu\tilde{A}$, mA, A, μA

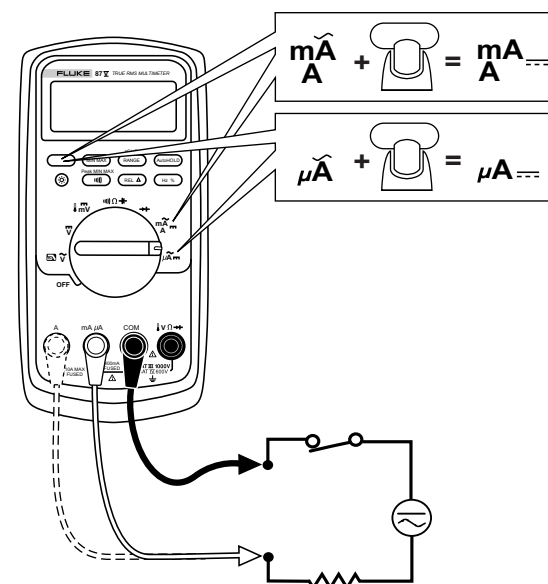

Diode Test →

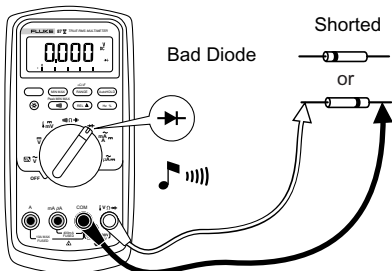
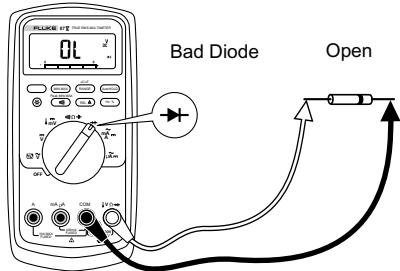
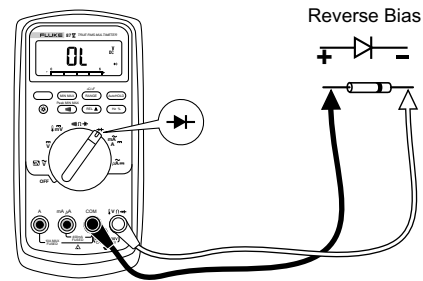
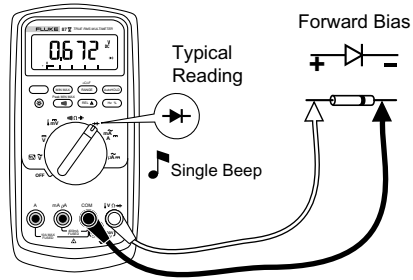

Frequency Hz

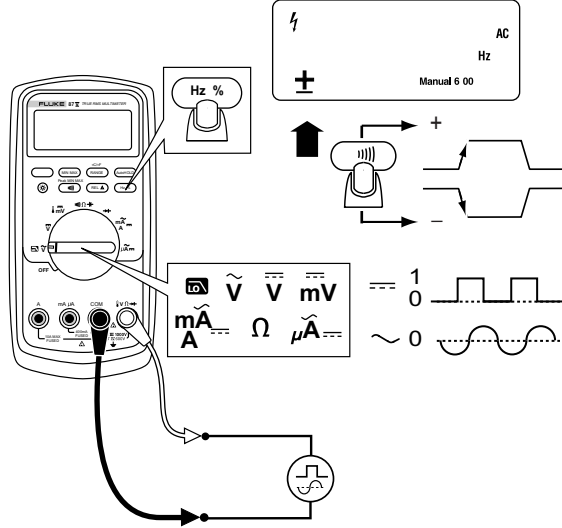

Duty Cycle %

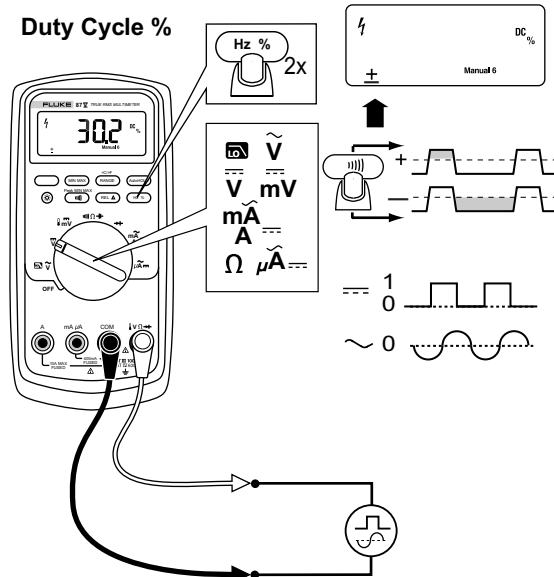

Min, Max, Average MIN MAX

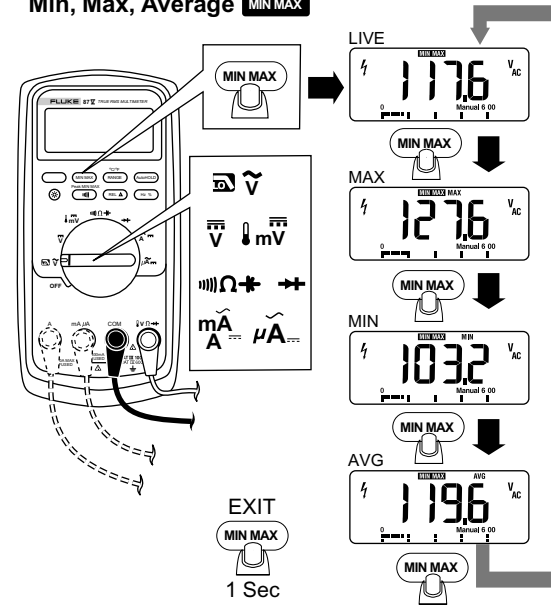

AutoHOLD HOLD

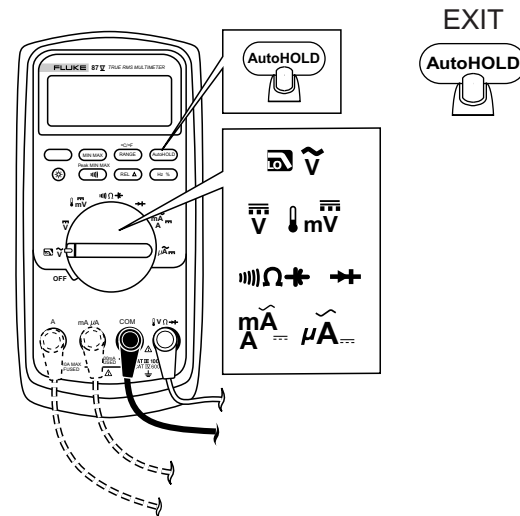

Relative Δ

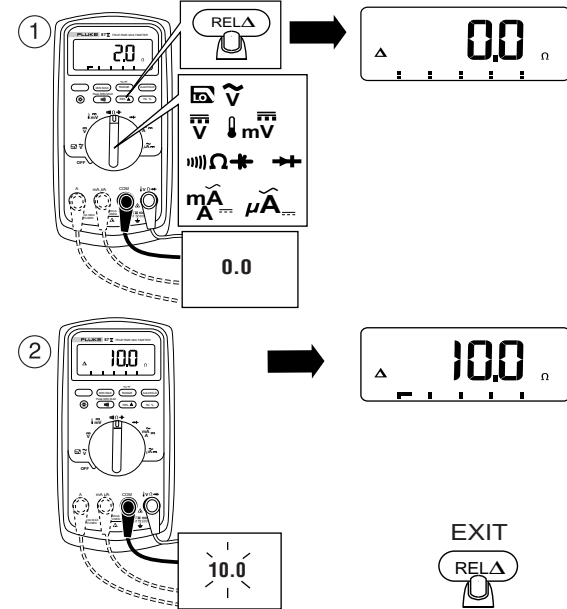

Hi Res Mode (87 Only)

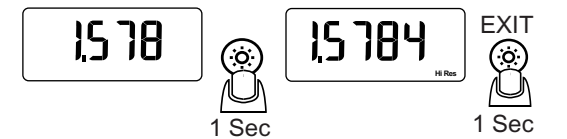

ToolPak

