

Tequipment
NET



205 Westwood Ave
Long Branch, NJ 07740
1-877-742-TEST (8378)
Fax: (732) 222-7088
salesteam@Tequipment.NET

FLUKE®

87V EX

True-rms Multimeter

Calibration Manual

LIMITED WARRANTY AND LIMITATION OF LIABILITY

Each Fluke product is warranted to be free from defects in material and workmanship under normal use and service. The warranty period is one year and begins on the date of shipment. Parts, product repairs, and services are warranted for 90 days. This warranty extends only to the original buyer or end-user customer of a Fluke authorized reseller, and does not apply to fuses, disposable batteries, or to any product which, in Fluke's opinion, has been misused, altered, neglected, contaminated, or damaged by accident or abnormal conditions of operation or handling. Fluke warrants that software will operate substantially in accordance with its functional specifications for 90 days and that it has been properly recorded on non-defective media. Fluke does not warrant that software will be error free or operate without interruption.

Fluke authorized resellers shall extend this warranty on new and unused products to end-user customers only but have no authority to extend a greater or different warranty on behalf of Fluke. Warranty support is available only if product is purchased through a Fluke authorized sales outlet or Buyer has paid the applicable international price. Fluke reserves the right to invoice Buyer for importation costs of repair/replacement parts when product purchased in one country is submitted for repair in another country.

Fluke's warranty obligation is limited, at Fluke's option, to refund of the purchase price, free of charge repair, or replacement of a defective product which is returned to a Fluke authorized service center within the warranty period.

To obtain warranty service, contact your nearest Fluke authorized service center to obtain return authorization information, then send the product to that service center, with a description of the difficulty, postage and insurance prepaid (FOB Destination). Fluke assumes no risk for damage in transit. Following warranty repair, the product will be returned to Buyer, transportation prepaid (FOB Destination). If Fluke determines that failure was caused by neglect, misuse, contamination, alteration, accident, or abnormal condition of operation or handling, including overvoltage failures caused by use outside the product's specified rating, or normal wear and tear of mechanical components, Fluke will provide an estimate of repair costs and obtain authorization before commencing the work. Following repair, the product will be returned to the Buyer transportation prepaid and the Buyer will be billed for the repair and return transportation charges (FOB Shipping Point).

THIS WARRANTY IS BUYER'S SOLE AND EXCLUSIVE REMEDY AND IS IN LIEU OF ALL OTHER WARRANTIES, EXPRESS OR IMPLIED, INCLUDING BUT NOT LIMITED TO ANY IMPLIED WARRANTY OF MERCHANTABILITY OR FITNESS FOR A PARTICULAR PURPOSE. FLUKE SHALL NOT BE LIABLE FOR ANY SPECIAL, INDIRECT, INCIDENTAL, OR CONSEQUENTIAL DAMAGES OR LOSSES, INCLUDING LOSS OF DATA, ARISING FROM ANY CAUSE OR THEORY.

Since some countries or states do not allow limitation of the term of an implied warranty, or exclusion or limitation of incidental or consequential damages, the limitations and exclusions of this warranty may not apply to every buyer. If any provision of this Warranty is held invalid or unenforceable by a court or other decision-maker of competent jurisdiction, such holding will not affect the validity or enforceability of any other provision.

Fluke Corporation	Fluke Europe B.V.
P.O. Box 9090	P.O. Box 1186
Everett, WA 98206-9090	5602 BD Eindhoven
U.S.A.	The Netherlands

Table of Contents

Title	Page
Introduction.....	1
Contacting Fluke.....	1
Precautions and Safety Information.....	2
General Safety Information.....	2
ATEX Safety Information.....	2
Ex-Certification Data.....	4
General Specifications.....	5
Detailed Specifications.....	6
AC Voltage Function.....	6
DC Voltage, Resistance, and Conductance Function.....	6
Temperature.....	6
Current Function.....	7
Capacitance and Diode Function.....	7
Frequency Counter.....	7
Frequency Counter Sensitivity and Trigger Levels.....	7
Electrical Characteristics of the Terminals.....	8
MIN MAX Recording.....	8
Basic Maintenance.....	8
Cleaning the Meter.....	8
Opening the Meter Case.....	9
Reassembling the Meter Case.....	10
Replacing the Battery.....	11
Testing Fuses and Current Circuitry.....	11
Replacing the Fuses.....	13
Required Equipment.....	13
Performance Tests.....	14
Basic Operability Tests.....	14
Testing the Fuses.....	14
Testing the Display.....	14
Testing the Pushbuttons.....	17
Testing Meter Accuracy.....	17
Calibration Adjustment.....	19
Calibration Adjustment Counter.....	19
Calibration Adjustment Password.....	20
Meter Buttons Used in the Calibration Steps.....	20

Calibration Adjustment Procedure	20
Service and Parts.....	22

List of Tables

Table	Title	Page
1.	Electrical Symbols	5
2.	Approved Batteries.....	11
3.	Required Equipment.....	13
4.	Display Features.....	14
5.	Accuracy Tests	17
6.	Meter Button to Calibration Function	20
7.	Calibration Adjustment Steps.....	21
8.	87V EX Final Assembly	22

List of Figures

Figure	Title	Page
1.	Opening the Meter, Battery and Fuse Replacement.....	10
2.	Testing the Current Input Fuses	12
3.	Display Features.....	14
4.	87V EX Final Assembly	23

Introduction

Warning

To avoid shock or injury:

- Read “Precautions and Safety Information” before performing the verification tests or calibration adjustment procedures documented in this manual.
- Do not perform the verification tests or calibration adjustment procedures described in this manual unless you are qualified to do so.
- The information provided in this manual is for the use of qualified personnel only.

Caution

- The 87V EX True-rms Multimeter contains parts that can be damaged by static discharge.
- Follow the standard practices for handling static sensitive devices.

The *87V EX Calibration Manual* provides the following information:

- Safety information
- Specifications
- Basic maintenance (cleaning, replacing the battery and fuses)
- Performance test procedures
- Calibration adjustment procedures
- Replaceable parts

For complete operating instructions, refer to the *87V EX True-rms Multimeter Users Manual*.

Contacting Fluke

To contact Fluke or locate the nearest Service Center, call one of the following telephone numbers:

Europe: +31 402-675-200

Or, visit Fluke's Web site at www.fluke.com.

To register your product, visit register.fluke.com

Warning

To avoid possible electric shock or personal injury, inspect the test leads for damaged insulation or exposed metal. Check the test leads for continuity. Replace damaged test leads before using the Meter.

Precautions and Safety Information

In this manual, a **Warning** identifies conditions and actions that pose hazard(s) to the user; a **Caution** identifies conditions and actions that may damage the Meter or the test instruments.

General Safety Information

The Meter complies with:

- EN61010-1:2001
 - ANSI/ISA S82.01-2004
 - CAN/CSA C22.2 No. 1010.1:2004
 - Measurement Category III, 1000V, Pollution Degree 2
 - Measurement Category IV, 600V, Pollution Degree 2
 - Industrial use in potentially explosive areas of zone 1 or 2, according to ATEX requirements (ATEX 137)(see the ATEX safety instructions & regulations section)
- In this manual, a **Warning** identifies conditions and actions that pose hazards to the user. A **Caution** identifies conditions and actions that may damage the Meter or the equipment under test.

Electrical symbols used on the Meter and in this manual are explained in Table 1.

To ensure safe operation of the Meter, fully observe all instructions and warnings contained in this manual.

ATEX Safety Information

This manual contains information and safety regulations that must be followed to ensure safe, reliable operation of the Meter in hazardous areas under the described conditions. Failure to follow the information and instructions can have dangerous consequences, or may contravene applicable legislation.

Please take the time to read through the Users Manual before you start using the Meter.

To ensure safe operation of this Meter, fully observe all instructions and warnings contained in this manual.

Warning

To avoid possible electric shock or personal injury while working in EX-HAZARDOUS areas, follow these guidelines:

- **Do not open the Meter while in an Ex-hazardous area.**
- **Change the Meter's battery only outside Ex-hazardous areas.**
- **Do not carry additional or spare batteries in Ex-hazardous areas.**
- **Use only type-approved batteries in the Meter. Refer to the "Replacing the Battery" section for a list of approved batteries.**
- **Do not replace fuses while in an Ex-hazardous area.**
- **Use only fuses approved for Ex-hazardous areas in this Meter. See the "Replacing the Fuses" section for a list of approved fuses.**
- **After using the Meter on a non-i.s. protected circuit, observe a 3-minute rest period before taking the Meter into an Ex-hazardous area.**
- **The Meter must be completely and securely fitted in the red holster while it is in an Ex-hazardous area.**

- Do not open function buttons inside the Meter. Interference or damage to any of these elements removes the Ex-protection.
- Observe the tolerances or threshold values found in the “Specifications” section of this manual.
- Use only allowed accessories with this Meter in Ex-hazardous areas. See a listing of allowed Fluke accessories at www.Fluke.com.
- Avoid using the Meter in aggressive acidic or alkaline solutions.
- Do not use the Meter in zone 0.
- Never measure voltages greater than 65 volts in an Ex-hazardous area.
- Never measure currents greater than 5 amps while using the Meter in an Ex-hazardous area.
- Servicing not covered in this manual should be performed only by the manufacturer. Repair or service by others may void the ATEX certification of this Meter.

⚠ ⚠ Warning

To avoid possible electric shock or personal injury in ALL areas of operation, follow these guidelines:

- Use this Meter only as specified in this manual or the protection provided by the Meter might be impaired.
- See the “ATEX Safety Information” section for additional warnings on meter use in hazardous areas.
- Do not use the Meter if it is damaged. Before you use the Meter, inspect the case. Look for cracks or missing plastic. Pay particular attention to the insulation surrounding the connectors.
- Ensure the battery door is closed and latched whenever operating the Meter.
- Replace the battery as soon as the battery indicator (🔋) appears. See “Replacing the Battery” section for instructions and a list of approved batteries.
- Remove test leads from the Meter before opening the battery door.
- Inspect the test leads for damaged insulation or exposed metal. Check the test leads for continuity. Replace damaged leads before using the Meter.
- Do not apply more than the rated voltage, as marked on the Meter, between the terminals or between any terminal and earth ground.
- Use caution when working with voltages above 30 V ac rms, 42 V ac peak, or 60 V dc. These voltages pose a shock hazard.
- Use only the replacement fuses specified in this Users Manual. See “Replacing the Fuses” section for instructions and a list of approved fuses.
- Use the proper terminals, function, and range for measurements.
- Avoid working alone.
- When measuring current, turn off circuit power before connecting the Meter to the circuit. Remember to place the Meter in series with the circuit.
- When making electrical connections, connect the common test lead before connecting the live test lead; when disconnecting, disconnect the live test lead before disconnecting the common test lead.

- Do not use the Meter if it operates abnormally. Protection may be impaired. When in doubt, have the Meter serviced.
- Use only a single 9 volt battery, properly installed in the Meter case, to power the Meter. See “Replacing the Battery” section for instructions and a list of approved batteries.
- Only use replacement parts listed in the “Parts” section of this manual. Return the Meter to the manufacturer for all other service needs.
- When using probes, keep your fingers behind the probe’s finger guards.
- Do not use the Low Pass Filter option to verify the presence of hazardous voltages. Voltages greater than what is indicated may be present. First, make a voltage measurement without the filter to detect the possible presence of hazardous voltage. Then select the filter function.
- Do not use in wet environments.

⚠ Caution

















To avoid possible damage to the Meter or to the equipment under test, follow these guidelines:

- Disconnect circuit power and discharge all high-voltage capacitors before testing resistance, continuity, diodes, or capacitance.
- Use the proper terminals, function, and range for all measurements.
- Before measuring current, check the Meter's fuses. (See "Fuse Test".)
- Observe all safety regulations and read the certificate.

Ex-Certification Data

- EC-type certificate no.: ZELM 05 ATEX 0274
- Ex-designation: Ex II 2 G EEx ia IIC T4
Measuring range: 65 V Max in Ex-hazardous areas.
5 A Max. in Ex-hazardous areas
- Power supply: 9 Volt block type, IEC 6LR61
- Measuring protected electric circuits:
Voltage-Mass (V/ - COM):
 $U_i = 65 \text{ V}$ $U_o = 10.35 \text{ V}$ $C_o = 2.52 \mu\text{F}$
 $I_o = 4.0 \text{ mA}$ $L_o = 100 \text{ mH}$
Current-Mass ($\mu\text{A}/\text{mA}$ & A - COM):
 $I_i = 5 \text{ A}$ $U_o = 2.8 \text{ V}$ $C_o = 1000 \mu\text{F}$
 $I_o = 68 \text{ mA}$ $L_o = 8 \text{ mH}$.
- Approved for Zones 2 and 1, device group II, gas group C potentially explosive gases, vapours and mist, temperature class T4.

Table 1. Electrical Symbols

	AC (Alternating Current)		Earth ground
	DC (Direct Current)		Fuse
	Capacitance		Diode
	Battery. Low battery when displayed.		Continuity test or continuity beeper tone.
	Hazardous voltage		Double insulated
	Risk of Danger. Important information. See Users Manual.		Do not mix with solid waste stream. Dispose using a qualified recycler or hazardous material handler.
CAT III	IEC Measurement Category III CAT III equipment is designed to protect against transients in equipment in fixed-equipment installations, such as distribution panels, feeders and short branch circuits, and lighting systems in large buildings.	CAT IV	IEC Measurement Category IV CAT IV equipment is designed to protect against transients from the primary supply level, such as an electricity meter or an overhead or underground utility service.
	Conforms to European Union directives.		Conforms to relevant Canadian and U.S. Standards.
	Inspected and licensed by TÜV Product Services.		Conforms to ATEX directive.

General Specifications

Maximum Voltage between any Terminal and Earth Ground: 1000 V rms

⚠ Fuse Protection for mA or μ A inputs: 0.44 A, 1000 V FAST Fuse

⚠ Fuse Protection for A input: 11 A, 1000 V FAST Fuse

Display: Digital: 6000 counts updates 4/sec; (Model 87 also has 19,999 counts in high-resolution mode).

Analog Bargraph: 33 segments, updates 40/sec. Frequency: 19,999 counts, updates 3/sec at > 10 Hz

Temperature: Operating: -20 °C to +50 °C; Storage: -40 °C to +60 °C

Altitude: Operating: 2000 m; Storage: 10,000 m

Temperature Coefficient: 0.05 x (specified accuracy)/ °C (< 18 °C or > 28 °C)

Electromagnetic Compatibility: In an RF field of 3 V/m total accuracy = specified accuracy + 20 counts

Except: 600 μ A dc range total accuracy=specified accuracy + 60 counts.

Temperature not specified.

Relative Humidity: 0 % to 80 % (0 °C to 35 °C); 0 % to 70 % (35 °C to 50 °C)

Battery Type: 9 V, 6LR61 according to IEC

Battery Life: 400 hrs typical with alkaline (with backlight off)

Vibration: Per MIL-PRF-28800 for a Class 2 instrument

Shock: 1 Meter drop per IEC 61010-1:2001

Size (HxWxL): 1.25 in x 3.41 in x 7.35 in (3.1 cm x 8.6 cm x 18.6 cm)

Size with Holster and Flex-Stand: 2.06 in x 3.86 in x 7.93 in (5.2 cm x 9.8 cm x 20.1 cm)

Weight with Holster and Flex-Stand: 23.3 oz (660 g)

Safety: Complies with ANSI/ISA S82.01-2004, CSA 22.2 No. 1010.1:2004 to 1000 V Overvoltage Category III, IEC 664 to 600 V Overvoltage Category IV. Licensed by TÜV to EN61010-1.  Directive 1992/92/EC (ATEX 137)

Detailed Specifications

For all detailed specifications:

Accuracy is given as \pm ([% of reading] + [number of least significant digits]) at 18 °C to 28 °C, with relative humidity up to 90 %, for a period of one year after calibration.

In the 4 ½-digit mode, multiply the number of least significant digits (counts) by 10. AC conversions are ac-coupled and valid from 3 % to 100 % of range. The Meter is true rms responding. AC crest factor can be up to 3 at full scale, 6 at half scale. For non-sinusoidal wave forms add $-$ (2 % Rdg + 2 % full scale) typical, for a crest factor up to 3.

AC Voltage Function

Function	Range	Resolution	Accuracy					
			45 - 65 Hz	30 - 200 Hz	200 - 440 Hz	440 Hz - 1 kHz	1 - 5 kHz	5 - 20 kHz ^[1]
\tilde{V} ^[2,4]	600.0 mV 6.000 V 60.00 V 600.0 V	0.1 mV	\pm (0.7 % + 4)	\pm (1.0 % + 4)	\pm (1.0 % + 4)	\pm (1.0 % + 4)	\pm (2.0 % + 4)	\pm (2.0 % + 20)
		0.001 V						
		0.01 V	\pm (0.7 % + 2)					
	0.1 V				\pm (2.0 % + 4) ^[3]	unspecified		
	1000 V	1 V					unspecified	unspecified
	Low pass filter		\pm (0.7 % + 2)	\pm (1.0 % + 4)	+1 % + 4 -6 % - 4 ^[5]	unspecified	unspecified	unspecified

[1] Below 10 % of range, add 12 counts.
 [2] The Meter is a true rms responding meter. When the input leads are shorted together in the ac functions, the Meter may display a residual reading between 1 and 30 counts. A 30 count residual reading will cause only a 2-digit change for readings over 3 % of range. Using REL to offset this reading may produce a much larger constant error in later measurements.
 [3] Frequency range: 1 kHz to 2.5 kHz.
 [4] A residual reading of up to 13 digits with leads shorted, will not affect stated accuracy above 3 % of range.
 [5] Specification increases from -1% at 200 Hz to -6% at 440 Hz when filter is in use.

DC Voltage, Resistance, and Conductance Function

Function	Range	Resolution	Accuracy
\bar{V}	6.000 V	0.001 V	\pm (0.05 % + 1)
	60.00 V	0.01 V	\pm (0.05 % + 1)
	600.0 V	0.1 V	\pm (0.05 % + 1)
	1000 V	1 V	\pm (0.05 % + 1)
\bar{mV}	600.0 mV	0.1 mV	\pm (0.1 % + 1)
Ω	600.0 Ω	0.1 Ω	\pm (0.2 % + 2) ^[1]
	6.000 k Ω	0.001 k Ω	\pm (0.2 % + 1)
	60.00 k Ω	0.01 k Ω	\pm (0.2 % + 1)
	600.0 k Ω	0.1 k Ω	\pm (0.6 % + 1)
	6.000 M Ω	0.001 M Ω	\pm (0.6 % + 1)
	50.00 M Ω	0.01 M Ω	\pm (1.0 % + 3) ^[2]
nS	60.00 nS	0.01 nS	\pm (1.0 % + 10) ^[1,2]

[1] When using the REL Δ function to compensate for offsets.
 [2] Add 0.5 % of reading when measuring above 30 M Ω in the 50 M Ω range, and 20 counts below 33 nS in the 60 nS range.

Temperature

Temperature	Resolution	Accuracy ^[1,2]
-200 °C to +1090 °C	0.1 °C	1 % + 10
-328 °F to +1994 °F	0.1 °F	1 % + 18

[1] Does not include error of the thermocouple probe.
 [2] Accuracy specification assumes ambient temperature stable to \pm 1 °C. For ambient temperature changes of \pm 5 °C, rated accuracy applies after 1 hour.

Current Function

Function	Range	Resolution	Accuracy ^[1, 2]	Load Voltage (typical)
mA A~ (45 Hz to 2 kHz)	60.00 mA	0.01 mA	±(1.0 % + 2)	1.8 mV/mA
	400.0 mA ^[4]	0.1 mA	± (1.0 % + 2)	1.8 mV/mA
	6.000 A	0.001 A	± (1.0 % + 2)	0.03 V/A
	10.00 A ^[3]	0.01 A	± (1.0 % + 2)	0.03 V/A
mA A=	60.00 mA	0.01 mA	± (0.2 % + 4)	1.8 mV/mA
	400.0 mA ^[4]	0.1 mA	± (0.2 % + 2)	1.8 mV/mA
	6.000 A	0.001 A	± (0.2 % + 4)	0.03 V/A
	10.00 A ^[3]	0.01 A	± (0.2 % + 2)	0.03 V/A
µA ~ (45 Hz to 2 kHz)	600.0 µA	0.1 µA	± (1.0 % + 2)	100 µV/µA
	6000 µA	1 µA	± (1.0 % + 2)	100 µV/µA
µA =	600.0 µA	0.1 µA	± (0.2 % + 4)	100 µV/µA
	6000 µA	1 µA	± (0.2 % + 2)	100 µV/µA

[1] AC conversions are ac coupled, true rms responding, and valid from 3 % to 100 % of range, except 400 mA range (5 % to 100 % of range) and 10 A range (15 % to 100 % of range).

[2] The Meter is a true rms responding meter. When the input leads are shorted together in the ac functions, the Meter may display a residual reading between 1 and 30 counts. A 30 count residual reading will cause only a 2 digit change for readings over 3 % of range. Using REL to offset this reading may produce a much larger constant error in later measurements

[3] ⚠ 10 A continuous up to 35 °C; < 20 minutes on, 5 minutes off at 35 °C to 55 °C. 20 A for 30 seconds maximum; > 10 A unspecified.

[4] 400 mA continuous; 600 mA for 18 hrs maximum.

Capacitance and Diode Function

Function	Range	Resolution	Accuracy
⚡	10.00 nF	0.01 nF	± (1 % + 2) ^[1]
	100.0 nF	0.1 nF	± (1 % + 2) ^[1]
	1.000 µF	0.001 µF	± (1 % + 2)
	10.00 µF	0.01 µF	± (1 % + 2)
	100.0 µF	0.1 µF	± (1 % + 2)
	9999 µF	1 µF	± (1 % + 2)
⚡	3.000 V	0.001 V	± (2 % + 1)

[1] With a film capacitor or better, using Relative mode to zero residual.

Frequency Counter

Function	Range	Resolution	Accuracy
Frequency (0.5 Hz to 200 kHz, pulse width > 2 µs)	199.99	0.01 Hz	± (0.005 % + 1)
	1999.9	0.1 Hz	± (0.005 % + 1)
	19.999 kHz	0.001 kHz	± (0.005 % + 1)
	199.99 kHz	0.01 kHz	± (0.005 % + 1)
	> 200 kHz	0.1 kHz	unspecified

Frequency Counter Sensitivity and Trigger Levels

Input Range ^[1]	Minimum Sensitivity (RMS Sine wave)		Approximate Trigger Level (DC Voltage Function)
	5 Hz - 20 kHz	0.5 Hz - 200 kHz	
600 mV dc	70 mV (to 400 Hz)	70 mV (to 400 Hz)	40 mV
600 mV ac	150 mV	150 mV	—
6 V	0.3 V	0.7 V	1.7 V
60 V	3 V	7 V (≤140 kHz)	4 V
600 V	30 V	70 V (≤14.0 kHz)	40 V
1000 V	100 V	200 V (≤1.4 kHz)	100 V
Duty Cycle Range	Accuracy		
0.0 to 99.9 %	Within ± (0.2% per kHz + 0.1 %) for rise times < 1 µs.		

[1] Maximum input for specified accuracy = 10X Range or 1000 V.

Electrical Characteristics of the Terminals

Function	Overload Protection ^[1]	Input Impedance (nominal)	Common Mode Rejection Ratio (1 kΩ unbalance)	Normal Mode Rejection						
	1000 V rms	10 MΩ < 100 pF	> 120 dB at dc, 50 Hz or 60 Hz	> 60 dB at 50 Hz or 60 Hz						
	1000 V rms	10 MΩ < 100 pF	> 120 dB at dc, 50 Hz or 60 Hz	> 60 dB at 50 Hz or 60 Hz						
	1000 V rms	10 MΩ < 100 pF (ac-coupled)	> 60 dB, dc to 60 Hz							
		Open Circuit Test Voltage	Full Scale Voltage	Typical Short Circuit Current						
			To 6.0 MΩ	50 MΩ or 60 nS	600 Ω	6 k	60 k	600 k	6 M	50 M
Ω	1000 V rms	< 7.9 V dc	< 4.1 V dc	< 4.5 V dc	1 mA	100 μA	10 μA	1 μA	1 μA	0.5 μA
	1000 V rms	< 3.9 V dc	3.000 V dc		0.6 mA typical					

[1] 10⁶ V Hz max

MIN MAX Recording

Nominal Response	Accuracy
100 ms to 80 %	Specified accuracy ± 12 counts for changes > 200 ms in duration (± 40 counts in ac with beeper on)
100 ms to 80 % (dc functions) 120 ms to 80 % (ac functions) 250 μs (peak) ^[1]	Specified accuracy ± 12 counts for changes > 200 ms in duration Specified accuracy ± 40 counts for changes > 350 ms and inputs > 25 % of range Specified accuracy ± 100 counts for changes > 250 μs in duration (add ± 100 counts for readings over 6000 counts) (add ± 100 counts for readings in Low Pass mode)

[1] For repetitive peaks: 1 ms for single events.

Basic Maintenance

Warning

To avoid possible electric shock or personal injury:

- Remove the test leads and any input signals before opening the case or replacing the battery or fuses.
- Repairs or servicing covered in this manual should be performed only by qualified personnel.

Cleaning the Meter

Warning

To avoid possible electric shock, personal injury, or damage to the meter, never allow water inside the case.

Caution

To avoid damaging the Meter, never apply abrasives, solvents, aromatic hydrocarbons, chlorinated solvents, or methanol-based fluids to the Meter.

Periodically wipe the Meter case with Fluke “MeterCleaner™” or a damp cloth and mild detergent.

Dirt or moisture in the **A** or **mA** μ **A** input terminals can affect readings and can falsely activate the Input Alert feature without the test leads being inserted. Such contamination may be dislodged by turning the Meter over and, with all test leads removed, gently tapping on the case.

Thoroughly clean the terminals as follows:

1. Turn the Meter off and remove all test leads.
2. Soak a clean swab with isopropyl alcohol and work the swab around in each input terminal to remove contaminants.
3. Use a dry clean swab to remove any left over alcohol from the terminal.

Opening the Meter Case

⚠ Caution

To avoid unintended circuit shorting, always place the uncovered Meter assembly on a protective surface. When the case of the Meter is open, circuit connections are exposed.

To open the Meter case, refer to Figure 1 and do the following:

1. Disconnect test leads from any live source, turn the rotary knob to **OFF**, and remove the test leads from the front terminals.
2. Remove the battery door by using a flat-blade screwdriver to turn the battery door screws 1/4-turn counterclockwise.
3. The case bottom is secured to the case top by three screws and two internal snaps (at the LCD end). Using a Phillips-head screwdriver, remove the three screws.

⚠ Caution

To avoid damaging the Meter, the gasket that is sealed to the bottom case, and is between the two case halves, must remain with the case bottom. The case top lifts away from the gasket easily. Do not damage the gasket or attempt to separate the case bottom from the gasket.

4. Hold the Meter display side up.
5. Pushing up from the inside of the battery compartment, disengage the case top from the gasket.
6. Gently unsnap the case top at the display end, see Figure 1.

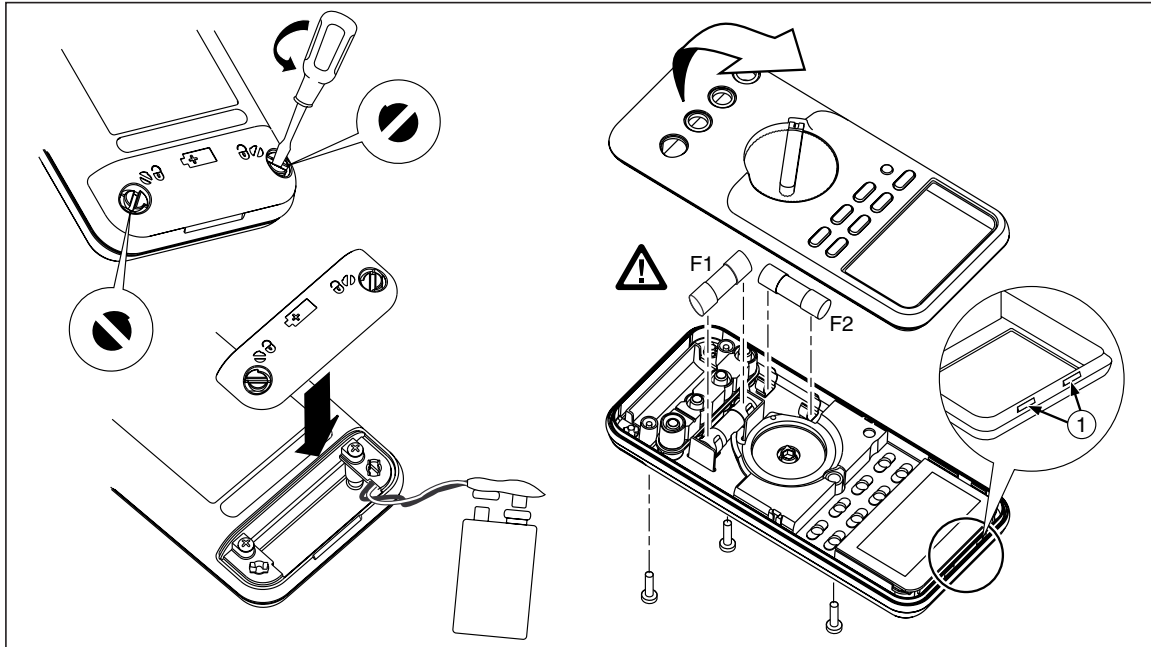

Figure 1. Opening the Meter, Battery and Fuse Replacement

Reassembling the Meter Case

To reassemble the Meter case:

1. Verify that the rotary knob and circuit board switch are in the **OFF** position, and that the gasket remains secured to the bottom case.
2. Place the PCA into the bottom case.
3. Place the case top on the case bottom.
4. To avoid damaging the battery wire, ensure the wire exits the middle of the battery compartment.
5. Properly seat the case gasket and snap the case halves together above the LCD end. See Figure 1.
6. Reinstall the three case screws and the battery door.
7. Secure the battery door by turning the screw 1/4-turn clockwise.
8. Go to “Performance Tests” later in this document, and perform the procedures described.

Replacing the Battery

Replace the Meter's 9-volt battery with only approved batteries found in Table 2.

Warning

To avoid false readings, which could lead to possible electric shock or personal injury, replace the battery as soon as the battery indicator (🔋) appears. If the display shows “bAt t” the Meter will not function until the battery is replaced.

Replace the battery as follows, refer to Figure 1:

1. Turn the rotary knob to **OFF** and remove the test leads from the terminals.
2. Remove the battery door by using a standard-blade screwdriver to turn the battery door screws one-quarter turn counterclockwise.
3. Remove the old battery and replace it with a new one.
4. Align the battery leads so that they not pinched between the battery door and the case bottom.
5. Secure the door by turning the screws one-quarter turn clockwise.

Table 2. Approved Batteries

Battery Description	Manufacturer	Type
Alkaline Energizer Energizer No. 522	Eveready	6LR61
Alkaline	Daimon	6LR61
Alkaline Alkaline Ultra Professional Alkaline Battery Procell Plus MN1604 6LR61 Procell MN1604 6LR61 Ultra M3 MN1604 6LR61	Duracell	6LR61
Ucar Gold 6LR61	Energizer	6LR61
Alkaline 4822 Alkaline Universal No. 4022 Alkaline Electric Power No. 8022 Electric Power No.8022 High Energy No.4922 Industrial Alkaline No.4022	Varta	6LR61
Alkaline Power Line Industrial Battery Industrial Alkaline 6LR61 Powermax 6LR61	Panasonic	6LR61
Super Alkaline 1604A	GP	6LR61

Testing Fuses and Current Circuitry

If a test lead is plugged into the **mA/μA** or **A** terminal and the rotary knob is turned to a non-current function, the Meter chirps and flashes “**LEAd**” if the fuse associated with that current terminal is good. If the Meter does not chirp or flash “**LEAd**”, the fuse is bad and must be replaced. Refer to Table 9 for the appropriate replacement fuse.

After replacing the fuse, use the following procedure to verify the integrity of the new fuse and the current circuitry. Refer to Figure 2.

1. Turn the rotary knob to Ω .
2. To test F2, insert a test lead into the $V\Omega$ input terminal and touch the probe to the **A** input terminal.

Note

The input receptacles contain split contacts. Be sure to touch the probe to the half of the receptacle nearest the LCD.

3. The display should indicate between $00.0\ \Omega$ and $00.5\ \Omega$. If the display reads OL, replace the fuse and test again. If the display reads another value, further servicing is required.
4. To test F1, move the probe from the **A** input terminal to the **mA/ μ A** input terminal.
5. The display should read between $0.995\ k\Omega$ and $1.005\ k\Omega$. If the display reads OL, replace the fuse and test again. If the display reads another value, further servicing is required.

⚠⚠ Warning

To avoid electrical shock or personal injury:

- Remove the test leads and any input signals before replacing the battery or fuses.
- Install **ONLY** specified replacement fuses with the amperage, voltage, and speed ratings shown in Table 9.

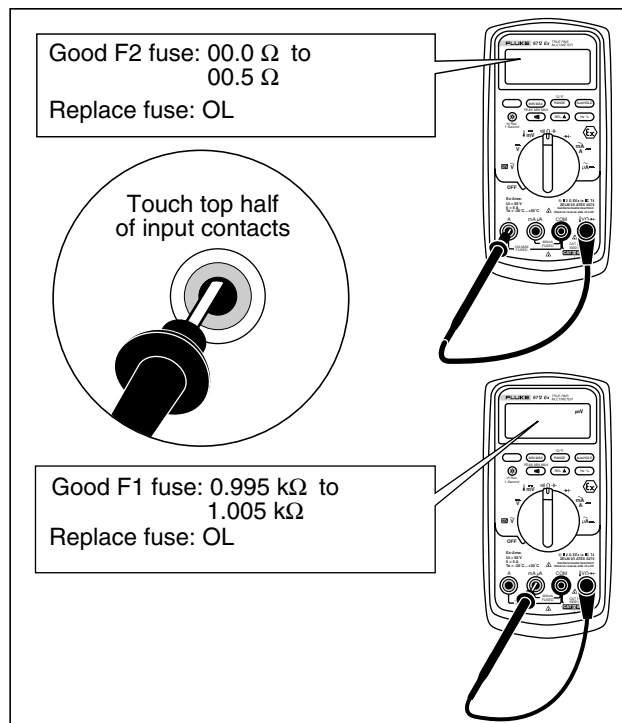

Figure 2. Testing the Current Input Fuses

ecg5f.eps

Replacing the Fuses

To replace the fuse(s), perform the following procedure.

1. To open the Meter, refer to “Opening the Meter Case”. See Figure 1.
2. Grasp the fuse in the center with needle nose pliers. Pull straight up on the fuse to remove it from the fuse clips.
3. Install ONLY specified replacement fuses with the amperage, voltage, and speed ratings shown in Table 9.
4. To close the Meter, refer to “Reassembling the Meter Case”.

Required Equipment

Required equipment for the performance tests are listed in Table 3. If the recommended models are not available, equipment with equivalent specifications may be used.

Warning

- **To avoid shock or injury, do not perform the verification tests or calibration adjustment procedures described in this manual unless you are qualified to do so.**
- **Repairs or servicing should be performed only by qualified personnel.**

Table 3. Required Equipment

Equipment	Required Characteristics	Recommended Model
Calibrator	AC Voltage Range: 0 - 1000 V ac Accuracy: $\pm 0.12\%$ Frequency Range: 60 - 20000 Hz Accuracy: $\pm 3\%$ DC Voltage Range: 0 - 1000 V dc Accuracy: $\pm 0.012\%$ Current Range: 350 μ A - 2 A Accuracy: AC (60 Hz to 1 kHz): $\pm 0.25\%$ DC: $\pm 0.05\%$ Frequency Source: 19.999 kHz - 199.99 kHz Accuracy: $\pm 0.0025\%$ Amplitude: 150 mV to 6V rms Accuracy: $\pm 5\%$ Range: 1 Ω - 100 M Ω Accuracy: 0.065 %	Fluke 5520A Multi-Product Calibrator or equivalent
Fluke 80 AK TC Adapter Accessory	K-type	Fluke 80 AK
K-type Thermocouple	K-type, mini-plug on both ends	

Performance Tests

The following performance tests verify the complete operability of the Meter and check the accuracy of each Meter function against the Meter’s specifications. Performance tests should be performed annually to ensure that the Meter is within accuracy specifications.

Accuracy specifications are valid for a period of one year after calibration adjustment, when measured at an operating temperature of 18 °C to 28 °C and at a maximum of 90 % relative humidity.

To perform the following tests, it is not necessary to open the case. No adjustments are necessary. Make the required connections, apply the designated inputs, and determine if the reading on the Meter display falls within the acceptable range indicated.

Note

If the Meter fails any of these tests, it needs calibration adjustment or repair.

Basic Operability Tests

Refer to the following sections to test the basic operability of the Meter.

Testing the Fuses

Refer to “Testing the Fuses”.

Testing the Display

Turn the Meter on while holding down (AutoHOLD) to view all segments of the display. Compare the display with the appropriate examples in Figure 3 and Table 4.

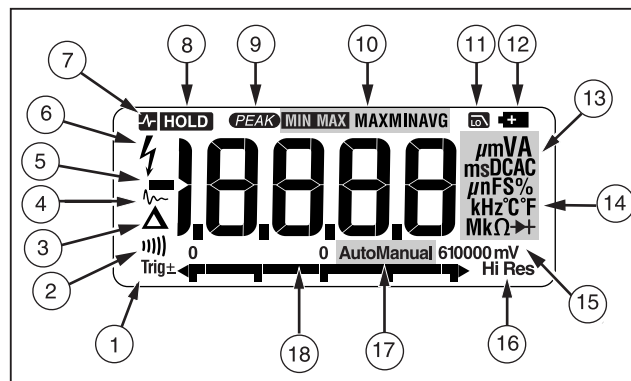

Figure 3. Display Features

aom1_af.eps

Table 4. Display Features

Number	Feature	Indication
①	±	Polarity indicator for the analog bar graph.
	Trig±	Positive or negative slope indicator for Hz/duty cycle triggering.
②		The continuity beeper is on.
③	△	Relative (REL) mode is active.
④	~	Smoothing is active.

Table 4. Display Features (cont)









Number	Feature	Indication
⑤	-	Indicates negative readings. In relative mode, this sign indicates that the present input is less than the stored reference.
⑥		Indicates the presence of a high voltage input. Appears if the input voltage is 30 V or greater (ac or dc). Also appears in low pass filter mode. Also appears in cal, Hz, and duty cycle modes.
⑦	 HOLD	AutoHOLD is active.
⑧	HOLD	Display Hold is active.
⑨	 PEAK	Indicates the Meter is in Peak Min Max mode and the response time is 250 μ s.
⑩	MIN MAX MAX MIN AVG	Indicators for minimum-maximum recording mode.
⑪		Low pass filter mode. See "Low Pass Filter."
⑫		The battery is low. $\Delta \Delta$ Warning: To avoid false readings, which could lead to possible electric shock or personal injury, replace the battery as soon as the battery indicator appears.
⑬	A, μA, mA V, mV μF, nF nS % Ω, MΩ, kΩ Hz, kHz AC DC	Amperes (amps), Microamp, Milliamp Volts, Millivolts Microfarad, Nanofarad Nanosiemens Percent. Used for duty cycle measurements. Ohm, Megohm, Kilohm Hertz, Kilohertz Alternating current, direct current
⑭	$^{\circ}$C, $^{\circ}$F	Degrees Celsius, Degrees Fahrenheit
⑮	610000 mV	Displays selected range
⑯	HiRes	The Meter is in high resolution (Hi Res) mode. HiRes=19,999
⑰	Auto	The Meter is in autorange mode and automatically selects the range with the best resolution.
	Manual	The Meter is in manual range mode.
⑱		The number of segments is relative to the full-scale value of the selected range. In normal operation 0 (zero) is on the left. The polarity indicator at the left of the graph indicates the polarity of the input. The graph does not operate with the capacitance, frequency counter functions, temperature, or peak min max. For more information, see "Bar Graph". The bar graph also has a zoom function, as described under "Zoom Mode".
--	OL	Overload condition is detected.

Table 5. Error Messages

Error Messages	
bAtt	Replace the battery immediately.
diSC	In the capacitance function, too much electrical charge is present on the capacitor being tested.
EEPr Err	Invalid EEPROM data. Have Meter serviced.
CAL Err	Invalid calibration data. Calibrate Meter.
LEAd	 Test lead alert. Displayed when the test leads are in the A or mA/μA terminal and the selected rotary switch position does not correspond to the terminal being used.

Testing the Pushbuttons

To test the pushbuttons

1. Turn the Meter rotary knob to  \tilde{V} .
2. Press each button and note that the meter responds with a beep for each button press.
3. Press and hold  a second time to exit MIN MAX mode.

Testing Meter Accuracy

Perform the accuracy test steps in Table 6.

Table 6. Accuracy Tests

Step	Test Function	Range	5500A Output	Display Reading
1	\tilde{V} AC Volts	600 mV	330 mV, 60 Hz	327.3 to 332.7
2		600 mV	600 mV, 13 kHz	586.0 to 614.0
3		6 V	3.3 V, 60 Hz	3.275 to 3.325
4		6 V	3.3 V, 20 kHz	3.214 to 3.386
5		60 V	33 V, 60 Hz	32.75 to 33.25
6		60 V	33 V, 20 kHz	32.14 to 33.86
7		600 V	330 V, 60 Hz	327.5 to 332.5
8		600 V	330 V, 2.5 kHz	323.0 to 337.0
9		1000 V	500 V, 60 Hz	494 to 506
10		1000 V	1000 V, 1 kHz	986 to 1014
11	\tilde{V} Hz AC Volts Frequency	600 mV	150 mV, 99.95 kHz	99.93 to 99.97
12		600 mV	150 mV, 199.50 kHz	199.48 to 199.52
13	Sensitivity	6 V	0.7 V, 99.95 kHz	99.93 to 99.97
14		60 V	7 V, 99.95 kHz	99.93 to 99.97
15	$\overline{\tilde{V}}$ Hz Trigger level	6 V	3.4 V, 1 kHz Sq. Wave	999.8 to 1000.2
16	$\overline{\tilde{V}}$ Hz Duty Cycle	6 V	5 V, 1 kHz, DC offset 2.5 V Sq. Wave	49.7 % to 50.3 %
17	\overline{V} DC Volts	6V	3.3 V dc	3.297 to 3.303
18		60 V	33 V dc	32.97 to 33.03
19		600 V	330 V dc	329.7 to 330.3
20		1000 V	1000 V dc	998 to 1002
21	\overline{mV} DC Volts	600 mV	33 mV dc	32.9 to 33.1
22		600 mV	330 mV dc	329.6 to 330.4

Table 5. Accuracy Tests (cont.)











Step	Test Function	Range	5500A Output	Display Reading
23	Ω Ohms	600 Ω	330 Ω (Use 2 wire Comp) ¹	329.1 to 330.9
24		6 k Ω	3.3 k Ω (Use 2 wire Comp) ¹	3.292 to 3.308
25		60 k Ω	33 k Ω	32.92 to 33.08
26		600 k Ω	330 k Ω	327.9 to 332.1
27		6 M Ω	3.3 M Ω	3.279 to 3.321
28		50 M Ω	30 M Ω	29.67 to 30.33
29	nS	60 nS	Open input	- 0.30 to 0.30
30	Conductance	60 nS	100 M Ω	9.60 to 10.40
31	 Diode	6 V	3.0 V dc	2.939 to 3.061
32	 AC Amps	6 A	3.0 A, 60 Hz	2.968 to 3.032
33	 DC Amps	6 A	3.0 A	2.990 to 3.010
33B	 DC Amps	10A ⁶	10A	9.96 to 10.04
34	 AC Milliamps	60 mA	33 mA, 60 Hz	32.65 to 33.35
35		400 mA	330 mA, 60 Hz	326.5 to 333.5
36	 DC Milliamp	60 mA	33 mA	32.89 to 33.11
37		400 mA	330 mA	329.1 to 330.9
38	 AC Microamps	600 μ A	330 μ A, 60 Hz	326.5 to 333.5
39		6000 μ A	3300 μ A, 60 Hz	3265 to 3335
40	 DC Microamps	600 μ A	330 μ A	328.9 to 331.1
41		6000 μ A	3300 μ A	3291 to 3309
42	 Capacitance	10 nf	Open input ²	0.21 to 0.31
43		100 nf	5 nf ⁵	04.7 to 05.3
44		100 μ f	9.5 μ f	09.2 to 09.8
45	 Low Pass Filter	1000 V	400 V, 400 Hz	372 to 408
46		1000 V	400 V, 800 Hz ⁴	226 to 340 ⁴

Table 5. Accuracy Tests (cont.)

Step	Test Function	Range	5500A Output	Display Reading
47	\bar{V} (87 and 88 only) Peak Min/Max	6 V dc	8 Vpp, 2 kHz Sq. Wave, DC offset 2 V	Max = 5.896 to 6.104
48				Min = -1.898 to -2.102
49	$m\bar{V}$ (87 and 88 only) Temperature ³		0 °C	-1.0 to 1.0
50			100 °C	98.0 to 102.0
51	Backlight		Press backlight button	Backlight comes on
52			Press backlight button	Backlight Intensifies
53			Press backlight button	Backlight off
<ol style="list-style-type: none"> 1. Or short test leads and use REL to offset test lead resistance. 2. Remove test leads from unit. 3. To ensure accurate measurement, the Meter and thermocouple adapter must be at the same temperature. After connecting the thermocouple adapter to the Meter allow for reading to stabilize before recording display reading. 4. The Meter accuracy is not specified at this input signal frequency with Low-pass filter selected. The display reading shown, check that the Low-pass filter is active and follows an expected roll-off curve. 5. Use REL to compensate for internal Meter and lead capacitance. Test leads must be disconnected from the calibrator before using REL. 6. Δ 10 A continuous up to 35 °C; < 20 minutes on, 5 minutes off at 35 °C to 55 °C. 20 A for 30 seconds maximum; >10A unspecified. 				

Calibration Adjustment

The Meter features closed-case calibration adjustment using known reference sources. The Meter measures the applied reference source, calculates correction factors and stores the correction factors in nonvolatile memory.

The following sections present the features and Meter pushbutton functions that can be used during the Calibration Adjustment Procedure. Perform the Calibration Adjustment Procedure should the Meter fail any performance test listed in Table 6.

Calibration Adjustment Counter

The Meter contains a calibration adjustment counter. The counter is incremented each time a Calibration Adjustment Procedure is completed. The value in the counter can be recorded and used to show that no adjustments have been made during a calibration cycle.

Use the following steps to view the Meter's calibration counter.

1. While holding down MIN MAX , turn the rotary knob from **OFF** to **VAC**. The Meter should display “**⚡ CAL**”.
2. Press AutoHOLD once to see the calibration counter. For example "n001".
3. Turn the rotary knob to **OFF**.

Calibration Adjustment Password

⚠ Caution





To avoid having to replace the Meter, do not change the calibration password.

To start the Calibration Adjustment Procedure, the correct 4-button password must be entered. The password is "1234".

Meter Buttons Used in the Calibration Steps









The Meter buttons behave as described in Table 6 when performing the Calibration Adjustment Procedure. This may be of help determining why a calibration step is not accepted and for determining the input value without referring to Table 8.

Table 7. Meter Button to Calibration Function

Button	Calibration function
	Press and hold to show the measured value. The measurement value is not calibrated so it may not match the input value. This is normal.
	Press and hold to display the required input amplitude.
	Press and hold to display the frequency of the required input.
	Press to store the calibration value and advance to the next step. This button is also used to exit calibration mode after the calibration adjustment sequence is complete.

Calibration Adjustment Procedure

Use the following steps to adjust the Meter's calibration. If the Meter is turned off before completion of the adjustment procedure, the calibration constants are not changed.

1. While holding down , turn the rotary knob from **OFF** to **VAC**. The Meter displays "⚡ CAL".
2. Press  once to see the calibration counter.
3. Press  again to start the password entry. The Meter displays "????".
4. Press 4 buttons to enter the password ( = 1,  = 2,  = 3, and  = 4).
5. Press  to go to the first calibration step. The Meter displays "C-01" if the password is correct. If the password is not correct, the Meter emits a double beep, displays "????", and the password must be entered again. Repeat step 4.
6. Using Table 8, apply the input value listed for each calibration adjustment step. For each step, position the rotary switch and apply the input to the terminals as indicated in the table.
7. After each input value is applied, press  to accept the value and proceed to the next step (C-02 and so forth).

Notes

After pressing , wait until the step number advances before changing the calibrator source or turning the Meter rotary knob.

If the Meter rotary knob is not in the correct position, or if the measured value is not within the anticipated range of the input value, the Meter emits a double beep and will not continue to the next step.

Some adjustment steps take longer to execute than others (10 to 15 seconds). For these steps, the Meter will beep when the step is complete. Not all steps have this feature.

8. After the final step, the display shows "End" to indicate that the calibration adjustment is complete. Press (AutoHOLD) to go to meter mode.

Notes

Set the calibrator to Standby prior to changing the function switch position and or after completing adjustment of each function.

If the calibration adjustment procedure is not completed correctly, the Meter will not operate correctly.

Table 8. Calibration Adjustment Steps

Function (Switch Position)	Input Terminal	Adjustment Step	Input Value	
\tilde{V} (AC Volts)	$V \Omega \rightarrow \rightarrow$	C-01	600.0 mV, 60 Hz	
		C-02	600.0 mV, 20 kHz	
		C-03	6.000 V, 60 Hz	
		C-04	6.000 V, 20 kHz	
		C-05	60.00 V, 60 Hz	
		C-06	60.00 V, 20 kHz	
		C-07	600.0 V, 60 Hz	
		C-08	600.0 V, 10 kHz	
\bar{V} (DC Volts)		C-09	6.000 V	
		C-10	60.00 V	
		C-11	600.0 V	
$m\bar{V}$ (DC Millivolts)		C-12	600.0 mV	
		C-13	60.00 mV	
Ω (Ohms)		C-14	600.0	
		C-15	6.000 k	
		C-16	60.00 k	
		C-17	600.0 k	
		C-18	6.000 M	
		C-19	0.000	
		C-20	50.0 M	
$\rightarrow \rightarrow$ (Diode Test)		C-21	3.000 V	
A (Amps)		A	C-22	6.000 A, 60 Hz
			C-23	6.000 A dc

Table 7. Calibration Adjustment Steps (Cont.)

Function (Switch Position)	Input Terminal	Adjustment Step	Input Value
mA (Milliamps)	mA /μA	C-24	60.00 mA, 60 Hz
		C-25	400.0 mA, 60 Hz
		C-26	60.00 mA dc
		C-27	400.0 mA dc
μA (Microamps)		C-28	600.0 μ A ac, 60 Hz
		C-29	6000 μ A, 60 Hz
		C-30	600.0 μ A dc
		C-31	6000 μ A dc

Service and Parts

Replacement parts are shown in Table 7 and Figure 4. To order parts and accessories, refer to “Contacting Fluke”.

Table 9. 87V EX Final Assembly

Item	Description	Qty.	Fluke Part or Model Number
BT1 Δ	Battery, 9 V (see Table 2)	1	822270
F1 Δ	Fuse, 0.44 A, 1000 V, FAST	1	943121
F2 Δ	Fuse, 11 A, 1000 V, FAST	1	803293
H1-3	Screw, Case	3	832246
MP1	Shock absorber	1	828541
MP2-3	Foot, Non-Skid	2	824466
MP4	Ex-Holster (Red)	1	2520563
MP5	Battery Door	1	2520595
AC72	Alligator Clip, Black	1	1670652
AC72	Alligator Clip, Red	1	1670641
TL75	Test Lead Set	1	855742
MP6-7	Access Door Fastener	2	948609
80BK	Thermocouple Assembly, K-Type, Beaded, Molded Dual Banana Plug, Coiled	1	1273113
NA	Tiltstand of the Ex holster	1	2520056
TM1	87V Ex Users Manual (English, French, & German)	1	2518115
TM2	CD ROM, 87V Ex Users Manual	1	2520777

Δ To ensure safety, use exact replacement only.

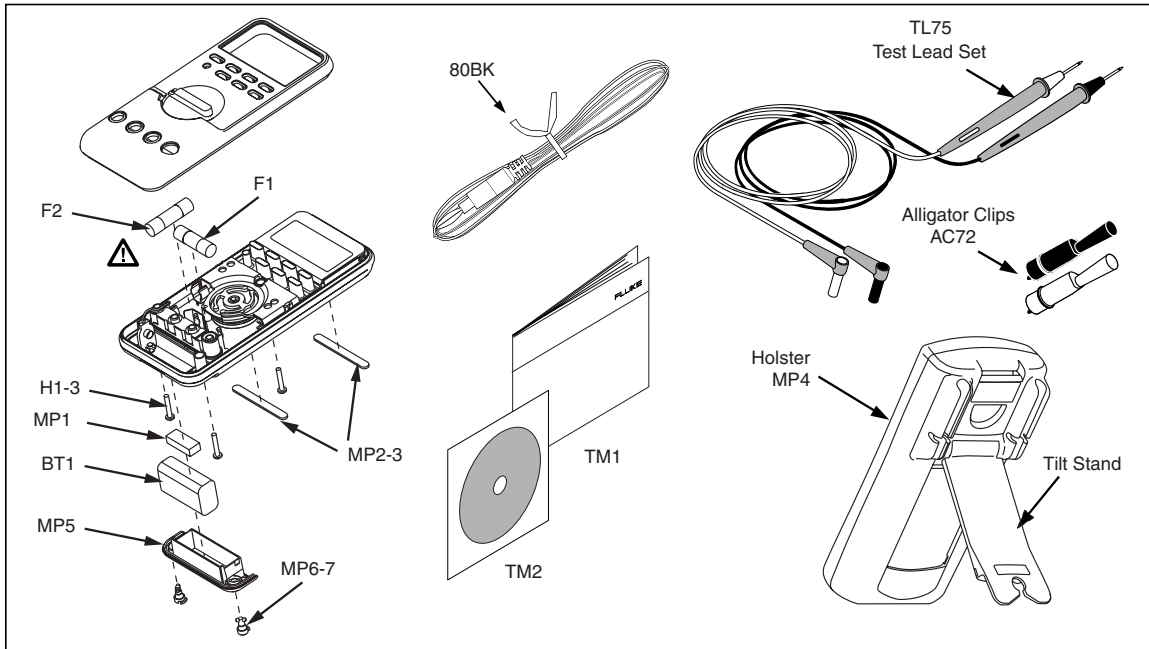

ecg015c.eps

Figure 4. 87V EX Final Assembly

205 Westwood Ave
Long Branch, NJ 07740
1-877-742-TEST (8378)
Fax: (732) 222-7088
salesteam@Tequipment.NET

