

Tequipment
_____.NET



205 Westwood Ave
Long Branch, NJ 07740
1-877-742-TEST (8378)
Fax: (732) 222-7088
salesteam@Tequipment.NET

FLUKE®

80 Series V

Multimeters

Users Manual

May 2004 Rev.2, 11/08

©2004, 2008 Fluke Corporation. All rights reserved.

Specifications are subject to change without notice.

All product names are trademarks of their respective companies.

Lifetime Limited Warranty

Each Fluke 20, 70, 80, 170 and 180 Series DMM will be free from defects in material and workmanship for its lifetime. As used herein, "lifetime" is defined as seven years after Fluke discontinues manufacturing the product, but the warranty period shall be at least ten years from the date of purchase. This warranty does not cover fuses, disposable batteries, damage from neglect, misuse, contamination, alteration, accident or abnormal conditions of operation or handling, including failures caused by use outside of the product's specifications, or normal wear and tear of mechanical components. This warranty covers the original purchaser only and is not transferable.

For ten years from the date of purchase, this warranty also covers the LCD. Thereafter, for the lifetime of the DMM, Fluke will replace the LCD for a fee based on then current component acquisition costs.

To establish original ownership and prove date of purchase, please complete and return the registration card accompanying the product, or register your product on <http://www.fluke.com>. Fluke will, at its option, repair at no charge, replace or refund the purchase price of a defective product purchased through a Fluke authorized sales outlet and at the applicable international price. Fluke reserves the right to charge for importation costs of repair/replacement parts if the product purchased in one country is sent for repair elsewhere.

If the product is defective, contact your nearest Fluke authorized service center to obtain return authorization information, then send the product to that service center, with a description of the difficulty, postage and insurance prepaid (FOB Destination). Fluke assumes no risk for damage in transit. Fluke will pay return transportation for product repaired or replaced in-warranty. Before making any non-warranty repair, Fluke will estimate cost and obtain authorization, then invoice you for repair and return transportation.

THIS WARRANTY IS YOUR ONLY REMEDY. NO OTHER WARRANTIES, SUCH AS FITNESS FOR A PARTICULAR PURPOSE, ARE EXPRESSED OR IMPLIED. FLUKE SHALL NOT BE LIABLE FOR ANY SPECIAL, INDIRECT, INCIDENTAL OR CONSEQUENTIAL DAMAGES OR LOSSES, INCLUDING LOSS OF DATA, ARISING FROM ANY CAUSE OR THEORY. AUTHORIZED RESELLERS ARE NOT AUTHORIZED TO EXTEND ANY DIFFERENT WARRANTY ON FLUKE'S BEHALF. Since some states do not allow the exclusion or limitation of an implied warranty or of incidental or consequential damages, this limitation of liability may not apply to you. If any provision of this warranty is held invalid or unenforceable by a court or other decision-maker of competent jurisdiction, such holding will not affect the validity or enforceability of any other provision.

Fluke Corporation
P.O. Box 9090
Everett WA
98206-9090

Fluke Europe B.V.
P.O. Box 1186
5602 B.D. Eindhoven
The Netherlands

Table of Contents

| Title | Page |
|---|------|
| Introduction..... | 1 |
| Contacting Fluke | 1 |
| Safety Information | 2 |
| The Meter's Features | 6 |
| Power-Up Options | 13 |
| Automatic Power-Off..... | 13 |
| Input Alert™ Feature | 13 |
| Making Measurements | 13 |
| Measuring AC and DC Voltage..... | 13 |
| Zero Input Behavior of True RMS Meters (87)..... | 15 |
| Low Pass Filter (87)..... | 15 |
| Measuring Temperature (87)..... | 16 |
| Testing for Continuity..... | 16 |
| Measuring Resistance | 18 |
| Using Conductance for High Resistance or Leakage Tests..... | 20 |
| Measuring Capacitance | 21 |
| Testing Diodes..... | 22 |

| | |
|---|----|
| Measuring AC or DC Current | 24 |
| Measuring Frequency | 27 |
| Measuring Duty Cycle | 29 |
| Determining Pulse Width..... | 30 |
| Bar Graph | 30 |
| Zoom Mode (Power Up Option Only) | 31 |
| Uses for the Zoom Mode..... | 31 |
| HiRes Mode (Model 87)..... | 31 |
| MIN MAX Recording Mode | 32 |
| Smooth Feature (Power Up Option Only) | 32 |
| AutoHOLD Mode..... | 34 |
| Relative Mode | 34 |
| Maintenance | 35 |
| General Maintenance..... | 35 |
| Fuse Test..... | 35 |
| Replacing the Battery..... | 36 |
| Replacing the Fuses | 37 |
| Service and Parts..... | 37 |
| Specifications..... | 43 |
| Detailed Specifications..... | 44 |

List of Tables

| Table | Title | Page |
|-------|---|------|
| 1. | Electrical Symbols | 5 |
| 2. | Inputs..... | 6 |
| 3. | Rotary Switch Positions | 7 |
| 4. | Pushbuttons | 8 |
| 5. | Display Features..... | 11 |
| 6. | Functions and Trigger Levels for Frequency Measurements..... | 28 |
| 7. | MIN MAX Functions..... | 33 |
| 8. | Replacement Parts | 39 |
| 9. | Accessories | 42 |
| 10. | Model 87 AC Voltage Function Specifications | 44 |
| 11. | Model 83 AC Voltage Function Specifications | 45 |
| 12. | DC Voltage, Resistance, and Conductance Function Specifications | 46 |
| 13. | Temperature Specifications (87 Only) | 47 |
| 14. | Current Function Specifications | 48 |
| 15. | Capacitance and Diode Function Specifications..... | 49 |
| 16. | Frequency Counter Specifications..... | 49 |
| 17. | Frequency Counter Sensitivity and Trigger Levels | 50 |
| 18. | Electrical Characteristics of the Terminals..... | 51 |
| 19. | MIN MAX Recording Specifications | 52 |

List of Figures

| Figure | Title | Page |
|---------------|---|-------------|
| 1. | Display Features (Model 87)..... | 11 |
| 2. | Measuring AC and DC Voltage..... | 14 |
| 3. | Low Pass Filter | 15 |
| 4. | Testing for Continuity..... | 17 |
| 5. | Measuring Resistance | 19 |
| 6. | Measuring Capacitance..... | 21 |
| 7. | Testing a Diode | 23 |
| 8. | Measuring Current..... | 25 |
| 9. | Components of Duty Cycle Measurements | 29 |
| 10. | Testing the Current Fuses | 36 |
| 11. | Battery and Fuse Replacement | 38 |
| 12. | Replaceable Parts | 41 |

Introduction

Warning

Read "Safety Information" before you use the Meter.

Except where noted, the descriptions and instructions in this manual apply to Series V Models 83 and 87 multimeters (hereafter referred to as "the Meter"). Model 87 appears in all illustrations.

Contacting Fluke

To contact Fluke, call one of the following telephone numbers:

USA: 1-888-44-FLUKE (1-888-443-5853)

Canada: 1-800-36-FLUKE (1-800-363-5853)

Europe: +31 402-675-200

Japan: +81-3-3434-0181

Singapore: +65-738-5655

Anywhere in the world: +1-425-446-5500

For USA Service: 1-888-99-FLUKE
(1-888-993-5853)

Or, visit Fluke's Web site at www.fluke.com.

To register your product, visit <http://register.fluke.com>.

Safety Information

The Meter complies with:

- EN61010-1:2001
- ANSI/ISA S82.01-2004
- CAN/CSA C22.2 No. 1010.1:2004
- UL610101-1
- Measurement Category III, 1000V, Pollution Degree 2
- Measurement Category IV, 600V, Pollution Degree 2

In this manual, a **Warning** identifies conditions and actions that pose hazards to the user. A **Caution** identifies conditions and actions that may damage the Meter or the equipment under test.

Electrical symbols used on the Meter and in this manual are explained in Table 1.

Warning

To avoid possible electric shock or personal injury, follow these guidelines:

- **Use this Meter only as specified in this manual or the protection provided by the Meter might be impaired.**
- **Do not use the Meter if it is damaged. Before you use the Meter, inspect the case. Look for cracks or missing plastic. Pay particular attention to the insulation surrounding the connectors.**
- **Make sure the battery door is closed and latched before operating the Meter.**
- **Replace the battery as soon as the battery indicator () appears.**
- **Remove test leads from the Meter before opening the battery door.**















- **Inspect the test leads for damaged insulation or exposed metal. Check the test leads for continuity. Replace damaged test leads before you use the Meter.**
- **Do not apply more than the rated voltage, as marked on the Meter, between the terminals or between any terminal and earth ground.**
- **Never operate the Meter with the cover removed or the case open.**
- **Use caution when working with voltages above 30 V ac rms, 42 V ac peak, or 60 V dc. These voltages pose a shock hazard.**
- **Use only the replacement fuses specified by the manual.**
- **Use the proper terminals, function, and range for measurements.**
- **Avoid working alone.**
- **When measuring current, turn off circuit power before connecting the Meter in the circuit. Remember to place the Meter in series with the circuit.**
- **When making electrical connections, connect the common test lead before connecting the live test lead; when disconnecting, disconnect the live test lead before disconnecting the common test lead.**
- **Do not use the Meter if it operates abnormally. Protection may be impaired. When in doubt, have the Meter serviced.**
- **Do not operate the Meter around explosive gas, vapor, or dust.**
- **Use only a single 9 V battery, properly installed in the Meter case, to power the Meter.**
- **When servicing the Meter, use only specified replacement parts.**
- **When using probes, keep fingers behind the finger guards on the probes.**
- **Do not use the Low Pass Filter option to verify the presence of hazardous voltages. Voltages greater than what is indicated may be present. First, make a voltage measurement without the filter to detect the possible presence of hazardous voltage. Then select the filter function.**

⚠ Caution

To avoid possible damage to the Meter or to the equipment under test, follow these guidelines:

- **Disconnect circuit power and discharge all high-voltage capacitors before testing resistance, continuity, diodes, or capacitance.**
- **Use the proper terminals, function, and range for all measurements.**
- **Before measuring current, check the Meter's fuses. (See "Fuse Test".)**

Table 1. Electrical Symbols

| | | | |
|---|---|---|--|
|  | AC (Alternating Current) |  | Earth ground |
|  | DC (Direct Current) |  | Fuse |
|  | Hazardous voltage |  | Conforms to European Union directives. |
|  | Risk of Danger. Important information. See Manual. |  | Conforms to relevant Canadian Standards Association directives. |
|  | Battery. Low battery when displayed. |  | Double insulated |
|  | Continuity test or continuity beeper tone. |  | Capacitance |
| CAT III | IEC Overvoltage Category III CAT III equipment is designed to protect against transients in equipment in fixed-equipment installations, such as distribution panels, feeders and short branch circuits, and lighting systems in large buildings. | CAT IV | IEC Overvoltage Category IV CAT IV equipment is designed to protect against transients from the primary supply level, such as an electricity meter or an overhead or underground utility service. |
|  | Underwriters Laboratories |  | Diode |
|  | Inspected and licensed by TÜV Product Services. | | |

The Meter's Features

Tables 2 through 5 briefly describe the Meter's features.

Table 2. Inputs



| Terminal | Description |
|--|--|
| A | Input for 0 A to 10.00 A current (20 A overload for 30 seconds maximum), current frequency, and duty cycle measurements. |
| mA μA | Input for 0 μ A to 400 mA current measurements (600 mA for 18 hrs.) and current frequency and duty cycle. |
| COM | Return terminal for all measurements. |
|  V Ω  | Input for voltage, continuity, resistance, diode, capacitance, frequency, temperature (87), and duty cycle measurements. |

Table 3. Rotary Switch Positions





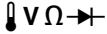



| Switch Position | Function |
|---|---|
| Any Position | When the Meter is turned on, the Meter model number briefly appears on the display. |
|  | AC voltage measurement Press <input type="button" value="□"/> for low pass filter () (87 only). |
|  | DC voltage measurement |
|  | 600 mV dc voltage range Press <input type="button" value="□"/> for temperature () (87 only). |
|  | Press <input type="button" value="□"/> for continuity test. Ω Resistance measurement Press <input type="button" value="□"/> for capacitance measurement. |
|  | Diode test |
|  | AC current measurements from 0 mA to 10.00 A Press <input type="button" value="□"/> for dc current measurements, from 0 mA to 10.00 A. |
|  | AC current measurements from 0 μA to 6000 μA Press <input type="button" value="□"/> for dc current measurements from 0 μA to 6000 μA. |

Table 4. Pushbuttons











| Button | Switch Position | Function |
|---|--|--|
|  (Yellow) |      Power-up | <p>Selects capacitance</p> <p>Selects temperature (87 only)</p> <p>Selects ac low pass filter function (87 only)</p> <p>Switches between dc and ac current</p> <p>Switches between dc and ac current</p> <p>Disables automatic power-off feature (Meter normally powers off in 30 minutes). The Meter reads “P o F F” until  is released.</p> |
|  | Any switch position Power-up | <p>Starts recording of minimum and maximum values. Steps the display through MAX, MIN, AVG (average), and present readings. Cancels MIN MAX (hold for 1 second)</p> <p>Enables the Meter’s calibration mode and prompts for a password. The Meter reads “[RL ” and enters calibration mode. See <i>80 Series V Service Information</i>.</p> |
|  | Any switch position  Power-up | <p>Switches between the ranges available for the selected function. To return to autoranging, hold the button down for 1 second.</p> <p>Switches between °C and °F.</p> <p>Enables the Meter’s smoothing feature. The Meter reads “S ---” until  is released.</p> |

Table 4. Pushbuttons (cont.)













| Button | Switch Positon | Function |
|---|--|---|
|  | Any switch position Frequency counter MIN MAX recording Power-up | AutoHOLD (formerly TouchHold) captures the present reading on the display. When a new, stable reading is detected, the Meter beeps and displays the new reading. Stops and starts recording without erasing recorded values. Stops and starts the frequency counter. Turns on all LCD segments. |
|  | Any switch position | Turns the backlight on, makes it brighter, and turns it off. For Model 87, hold  down for one second to enter the HiRes digit mode. The “HiRes” icon appears on the display. To return to the 3-1/2 digit mode, hold  down for one second. HiRes=19,999 |
|  | Continuity  MIN MAX recording Hz, Duty Cycle Power-up | Turns the continuity beeper on and off Switches between Peak (250 μs) and Normal (100 ms) response times. Toggles the meter to trigger on positive or negative slope. Disables the beeper for all functions. The Meter reads “bEEP” until  is released. |

Table 4. Pushbuttons (cont.)

| Button | Switch Position | Function |
|--|--|--|
|  (Relative mode) | Any switch position Power-up | Stores the present reading as a reference for subsequent readings. The display is zeroed, and the stored reading is subtracted from all subsequent readings. Enables zoom mode for the bar graph. The Meter reads “Zr E L” until  is released. |
|  | Any switch position except diode test Power-up | Press  for frequency measurements. Starts the frequency counter. Press again to enter duty cycle mode. Enables the Meter’s high impedance mode when the mV dc function is used. The Meter reads “H, Z” until  is released. |

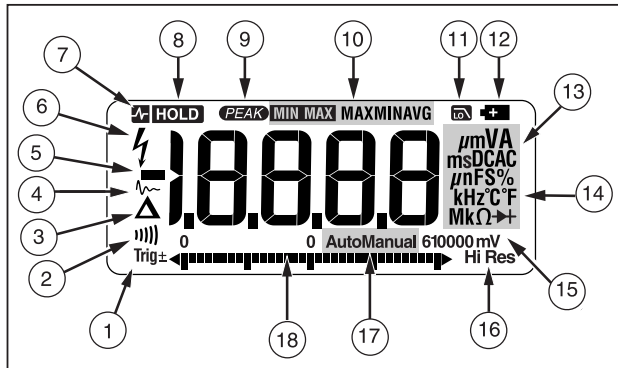

aom1_af.eps

Figure 1. Display Features (Model 87)

Table 5. Display Features

| Number | Feature | Indication |
|--------|---------|--|
| ① | ± | Polarity indicator for the analog bar graph. |
| | Trig ± | Positive or negative slope indicator for Hz/duty cycle triggering. |
| ② | | The continuity beeper is on. |
| ③ | Δ | Relative (REL) mode is active. |
| ④ | ~~~~ | Smoothing is active. |

| Number | Feature | Indication |
|--------|------------------------------|--|
| ⑤ | - | Indicates negative readings. In relative mode, this sign indicates that the present input is less than the stored reference. |
| ⑥ | ⚡ | Indicates the presence of a high voltage input. Appears if the input voltage is 30 V or greater (ac or dc). Also appears in low pass filter mode. Also appears in cal, Hz, and duty cycle modes. |
| ⑦ | AutoHOLD | AutoHOLD is active. |
| ⑧ | HOLD | Display Hold is active. |
| ⑨ | PEAK | Indicates the Meter is in Peak Min Max mode and the response time is 250 μs (87 only). |
| ⑩ | MIN MAX MAX MIN AVG | Indicators for minimum-maximum recording mode. |
| ⑪ | Lo | Low pass filter mode (87 only). See “Low Pass Filter (87).” |
| ⑫ | + (with battery icon) | The battery is low. Warning: To avoid false readings, which could lead to possible electric shock or personal injury, replace the battery as soon as the battery indicator appears. |

Table 5. Display Features (cont.)

| Number | Feature | Indication |
|--------|--|--|
| ⑬ | A, μA, mA | Amperes (amps), Microamp, Milliamp |
| | V, mV | Volts, Millivolts |
| | μF, nF | Microfarad, Nanofarad |
| | nS | Nanosiemens |
| | % | Percent. Used for duty cycle measurements. |
| | Ω, MΩ, kΩ | Ohm, Megohm, Kilohm |
| | Hz, kHz | Hertz, Kilohertz |
| | AC DC | Alternating current, direct current |
| ⑭ | $^{\circ}$C, $^{\circ}$F | Degrees Celsius, Degrees Fahrenheit |
| ⑮ | 610000 mV | Displays selected range |
| ⑯ | HiRes | The Meter is in high resolution (Hi Res) mode. HiRes=19,999 |
| ⑰ | Auto | The Meter is in autorange mode and automatically selects the range with the best resolution. |
| | Manual | The Meter is in manual range mode. |

| Number | Feature | Indication |
|-------------------------|--|--|
| ⑱ |  | The number of segments is relative to the full-scale value of the selected range. In normal operation 0 (zero) is on the left. The polarity indicator at the left of the graph indicates the polarity of the input. The graph does not operate with the capacitance, frequency counter functions, temperature, or peak min max. For more information, see "Bar Graph". The bar graph also has a zoom function, as described under "Zoom Mode". |
| -- | OL | Overload condition is detected. |
| Display Messages | | |
| bAtt | | Replace the battery immediately. |
| dISC | | In the capacitance function, too much electrical charge is present on the capacitor being tested. |
| EEPROM Err | | Invalid EEPROM data. Have Meter serviced. |
| CAL Err | | Invalid calibration data. Calibrate Meter. |
| LEAD | | ⚠ Test lead alert. Displayed when the test leads are in the A or mA/μA terminal and the selected rotary switch position does not correspond to the terminal being used. |
| FB-Err | | Invalid model. Have Meter serviced. |
| OPEN | | Open thermocouple is detected. |

Power-Up Options

Holding a button down while turning the Meter on activates a power-up option. Table 4 includes the power-up options.

Automatic Power-Off

The Meter automatically turns off if you do not turn the rotary switch or press a button for 30 minutes. If MIN MAX Recording is enabled, the Meter will not power off. To disable automatic power-off, refer to Table 4.

Input Alert™ Feature

If a test lead is plugged into the mA/μA or A terminal, but the rotary switch is not set to the correct current position, the beeper warns you by making a chirping sound and the display flashes “L EAd”. This warning is intended to stop you from attempting to measure voltage, continuity, resistance, capacitance, or diode values when the leads are plugged into a current terminal.

⚠ Caution

Placing the probes across (in parallel with) a powered circuit when a lead is plugged into a current terminal can damage the circuit you are testing and blow the Meter's fuse. This can happen because the resistance through the Meter's current terminals is very low, so the Meter acts like a short circuit.

Making Measurements

The following sections describe how to take measurements with the Meter.

Measuring AC and DC Voltage

Model 87 features true rms readings, which are accurate for distorted sine waves and other waveforms (with no dc offset) such as square waves, triangle waves, and staircase waves.

The Meter's voltage ranges are 600.0 mV, 6.000 V, 60.00 V, 600.0 V, and 1000 V. To select the 600.0 mV dc range, turn the rotary switch to mV.

To measure ac or dc voltage, refer to Figure 2.

When measuring voltage, the Meter acts approximately like a 10 M Ω (10,000,000 Ω) impedance in parallel with the circuit. This loading effect can cause measurement errors in high-impedance circuits. In most cases, the error is negligible (0.1% or less) if the circuit impedance is 10 k Ω (10,000 Ω) or less.

For better accuracy when measuring the dc offset of an ac voltage, measure the ac voltage first. Note the ac voltage range, then manually select a dc voltage range equal to or higher than the ac range. This procedure improves the accuracy of the dc measurement by ensuring that the input protection circuits are not activated.

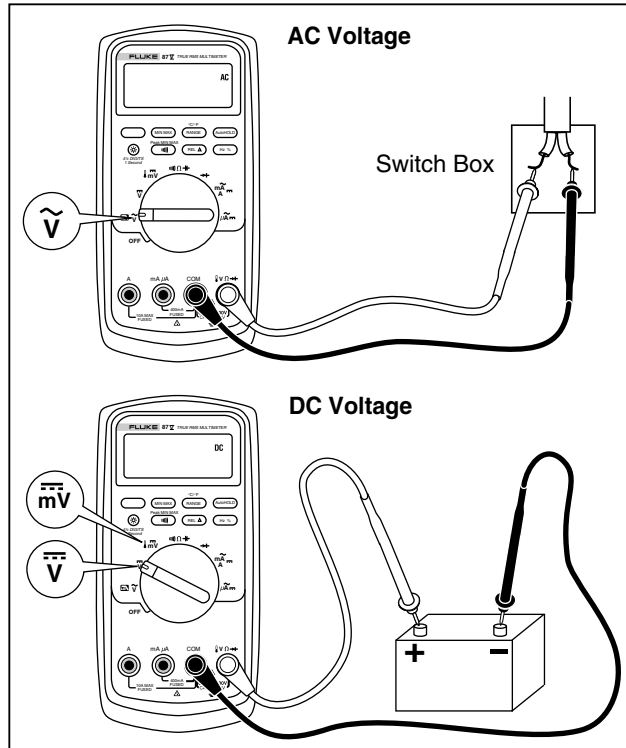

Figure 2. Measuring AC and DC Voltage

aom2f.eps



Zero Input Behavior of True RMS Meters (87)

True Rms Meters accurately measure distorted waveforms, but when the input leads are shorted together in the AC functions, the meter displays a residual reading between 1 and 30 counts. When the test leads are open, the display readings may fluctuate due to interference. These offset readings are normal. They do not affect the Meter's AC measurement accuracy over the specified measurement ranges.

Unspecified input levels are:

- AC voltage: below 3 % of 600 mV AC, or 18 mV AC
- AC current: below 3 % of 60 mA AC, or 1.8 mA AC
- AC current: below 3 % of 600 μ A AC, or 18 μ A AC

Low Pass Filter (87)

The 87 is equipped with an ac low pass filter. When measuring ac voltage or ac frequency, press  to activate the low pass filter mode (). The Meter continues measuring in the chosen ac mode, but now the signal diverts through a filter that blocks unwanted voltages above 1 kHz, refer to Figure 3. The lower frequency voltages pass with reduced accuracy to the measurement below 1 kHz. The low pass filter can improve measurement performance on composite sine waves that are typically generated by inverters and variable frequency motor drives.

Warning

To avoid possible electric shock or personal injury, do not use the Low Pass Filter option to verify the presence of hazardous voltages. Voltages greater than what is indicated may be present. First, make a voltage measurement without the filter to detect the possible presence of hazardous voltage. Then, select the filter function.

Note

In Low Pass Mode, the Meter goes to manual mode. Select ranges by pressing the RANGE button. Autoranging is not available in Low Pass Mode.

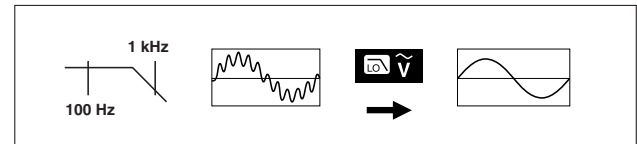

aom11f.eps

Figure 3. Low Pass Filter

Measuring Temperature (87)

The Meter measures the temperature of a type-K thermocouple (included). Choose between degrees Celsius ($^{\circ}\text{C}$) or degrees Fahrenheit ($^{\circ}\text{F}$) by pushing .

Caution



To avoid possible damage to the Meter or other equipment, remember that while the Meter is rated for $-200.0\text{ }^{\circ}\text{C}$ to $+1090.0\text{ }^{\circ}\text{C}$ and $-328.0\text{ }^{\circ}\text{F}$ to $1994.0\text{ }^{\circ}\text{F}$, the included K-Type Thermocouple is rated to $260\text{ }^{\circ}\text{C}$. For temperatures out of that range, use a higher rated thermocouple.

Display ranges are $-200.0\text{ }^{\circ}\text{C}$ to $+1090.0\text{ }^{\circ}\text{C}$ and $-328.0\text{ }^{\circ}\text{F}$ to $1994.0\text{ }^{\circ}\text{F}$. Readings outside of these ranges show **OL** on the Meter display. When there is no thermocouple connected, the display also reads **OPEn** for meters above serial number 90710501 and **OL** for meters below serial number 90710501.

Note

To locate the serial number, remove the Meter from the holster. The serial number is on the back of the Meter.

To measure temperature, do the following:

1. Connect a type-K thermocouple to the Meter's **COM** and $\downarrow\text{V } \Omega \rightarrow$ terminals.
2. Turn the rotary switch to .
3. Press  to enter temperature mode.
4. Push  to choose Celsius or Fahrenheit.

Testing for Continuity

Caution

To avoid possible damage to the Meter or to the equipment under test, disconnect circuit power and discharge all high-voltage capacitors before testing for continuity.

The continuity test features a beeper that sounds as long as a circuit is complete. The beeper allows you to perform quick continuity tests without having to watch the display.

To test for continuity, set up the Meter as shown in Figure 4.

Press  to turn the continuity beeper on or off.

The continuity function detects intermittent opens and shorts lasting as little as 1ms. A brief short causes the Meter to emit a short beep.

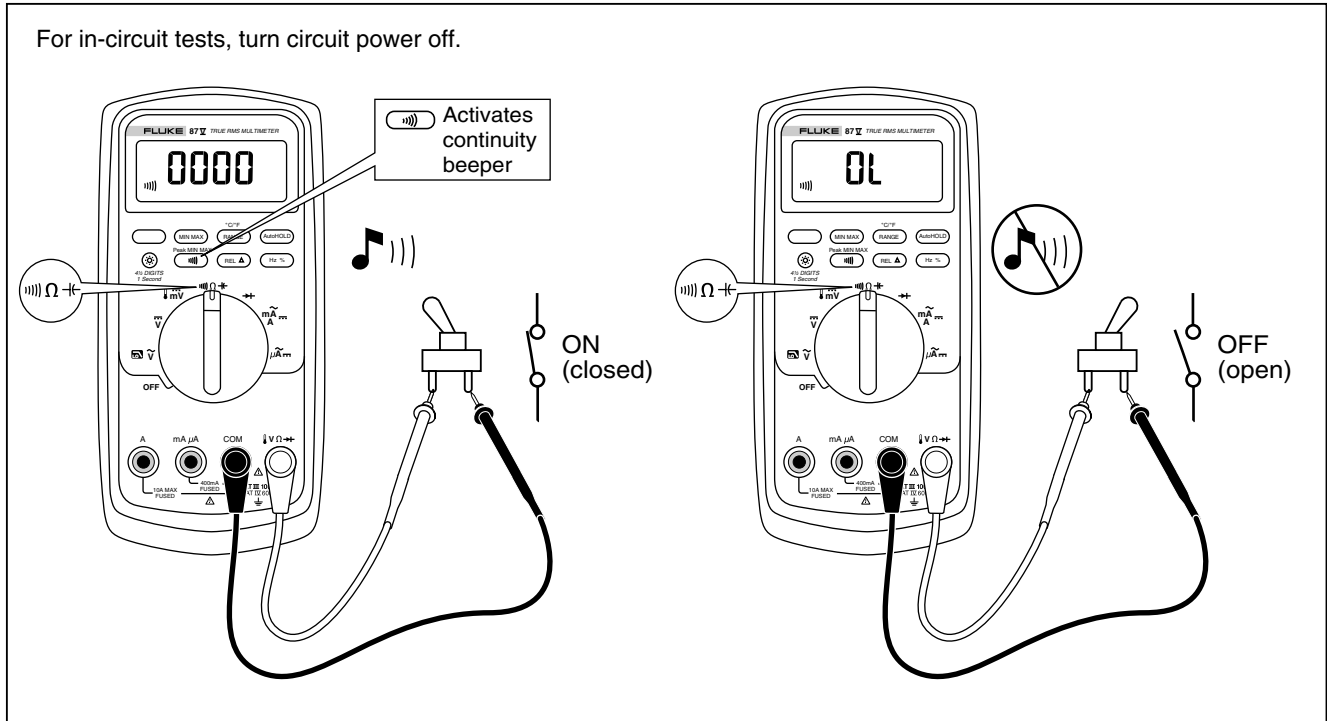

Figure 4. Testing for Continuity

aom4f.eps

Measuring Resistance

Caution

To avoid possible damage to the Meter or to the equipment under test, disconnect circuit power and discharge all high-voltage capacitors before measuring resistance.

The Meter measures resistance by sending a small current through the circuit. Because this current flows through all possible paths between the probes, the resistance reading represents the total resistance of all paths between the probes.

The Meter's resistance ranges are 600.0 Ω , 6.000 k Ω , 60.00 k Ω , 600.0 k Ω , 6.000 M Ω , and 50.00M Ω .

To measure resistance, set up the Meter as shown in Figure 5.

The following are some tips for measuring resistance:

- The measured value of a resistor in a circuit is often different from the resistor's rated value.
- The test leads can add 0.1 Ω to 0.2 Ω of error to resistance measurements. To test the leads, touch the probe tips together and read the resistance of the leads. If necessary, you can use the relative (REL) mode to automatically subtract this value.
- The resistance function can produce enough voltage to forward-bias silicon diode or transistor junctions, causing them to conduct. If this is suspected, press  to apply a lower current in the next higher range. If the value is higher, use the higher value. Refer to Table 18.

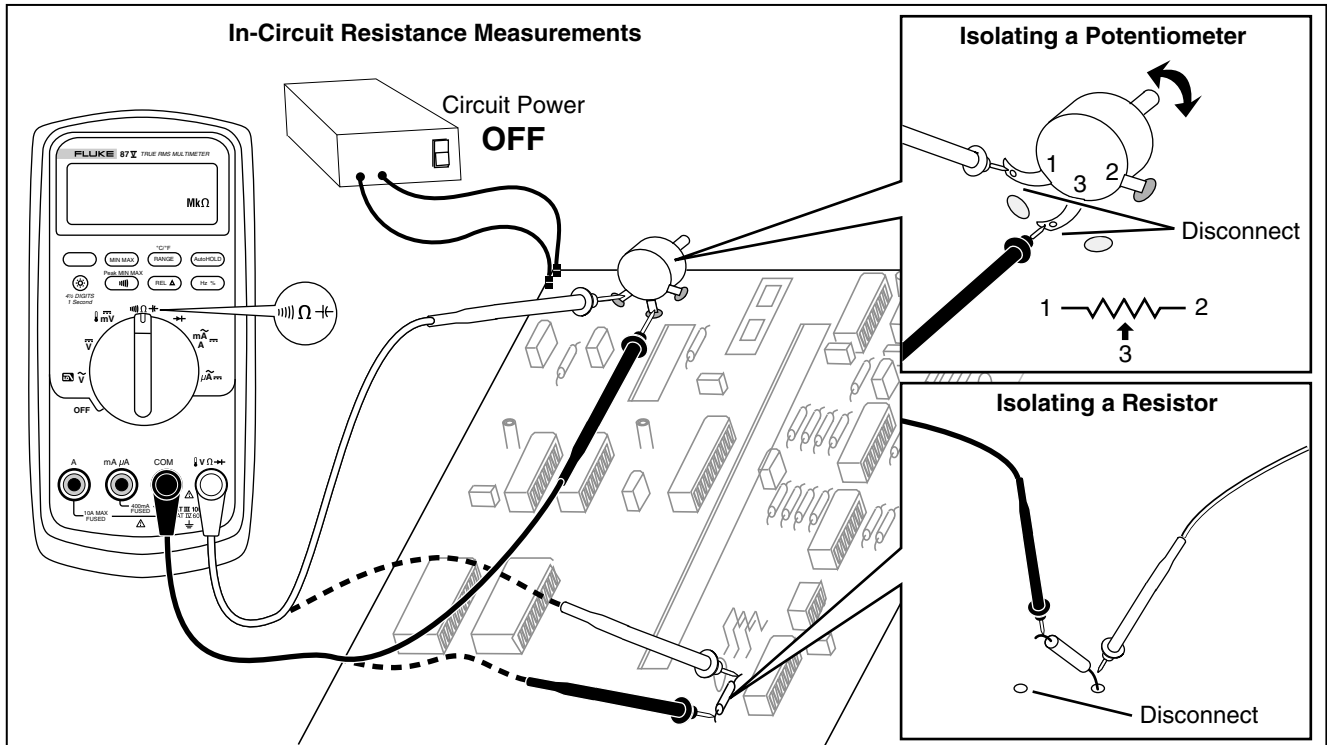



Figure 5. Measuring Resistance

aom6f.eps

Using Conductance for High Resistance or Leakage Tests

Conductance, the inverse of resistance, is the ability of a circuit to pass current. High values of conductance correspond to low values of resistance.

The Meter's 60 nS range measures conductance in nanosiemens (1 nS = 0.00000001 Siemens). Because such small amounts of conductance correspond to extremely high resistance, the nS range lets you determine the resistance of components up to 100,000 M Ω , 1/1 nS = 1,000 M Ω .

To measure conductance, set up the Meter as shown for measuring resistance (Figure 5); then press  until the nS indicator appears on the display.

The following are some tips for measuring conductance:

- High-resistance readings are susceptible to electrical noise. To smooth out most noisy readings, enter the MIN MAX recording mode; then step to the average (AVG) reading.
- There is normally a residual conductance reading with the test leads open. To ensure accurate readings, use the relative (REL) mode to subtract the residual value.

Measuring Capacitance

⚠ Caution

To avoid possible damage to the Meter or to the equipment under test, disconnect circuit power and discharge all high-voltage capacitors before measuring capacitance. Use the dc voltage function to confirm that the capacitor is discharged.

The Meter's capacitance ranges are 10.00 nF, 100.0 nF, 1.000 μ F, 10.00 μ F, 100.0 μ F, and 9999 μ F.

To measure capacitance, set up the Meter as shown in Figure 6.

To improve the accuracy of measurements less than 1000 nF, use the relative (REL) mode to subtract the residual capacitance of the Meter and leads.

Note

If too much electrical charge is present on the capacitor being tested, the display shows "diSC".

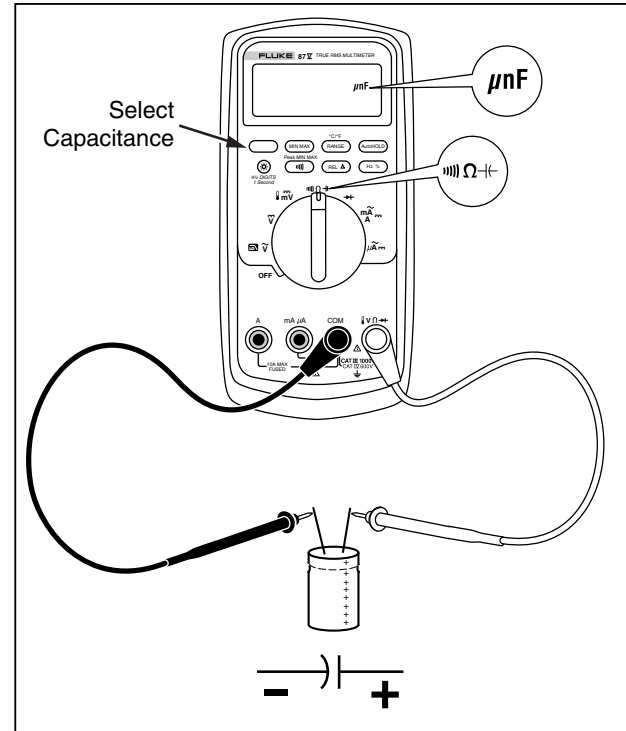

Figure 6. Measuring Capacitance

aom10f.eps

Testing Diodes

⚠ Caution

To avoid possible damage to the Meter or to the equipment under test, disconnect circuit power and discharge all high-voltage capacitors before testing diodes.

Use the diode test to check diodes, transistors, silicon controlled rectifiers (SCRs), and other semiconductor devices. This function tests a semiconductor junction by sending a current through the junction, then measuring the junction's voltage drop. A good silicon junction drops between 0.5 V and 0.8 V.

To test a diode out of a circuit, set up the Meter as shown in Figure 7. For forward-bias readings on any semiconductor component, place the red test lead on the component's positive terminal and place the black lead on the component's negative terminal.

In a circuit, a good diode should still produce a forward-bias reading of 0.5 V to 0.8 V; however, the reverse-bias reading can vary depending on the resistance of other pathways between the probe tips.

A short beep sounds if the diode is good (< 0.85 V). A continuous beep sounds if the reading is ≤ 0.100 V. This reading would indicate a short circuit. The display shows "OL" if the diode is open.

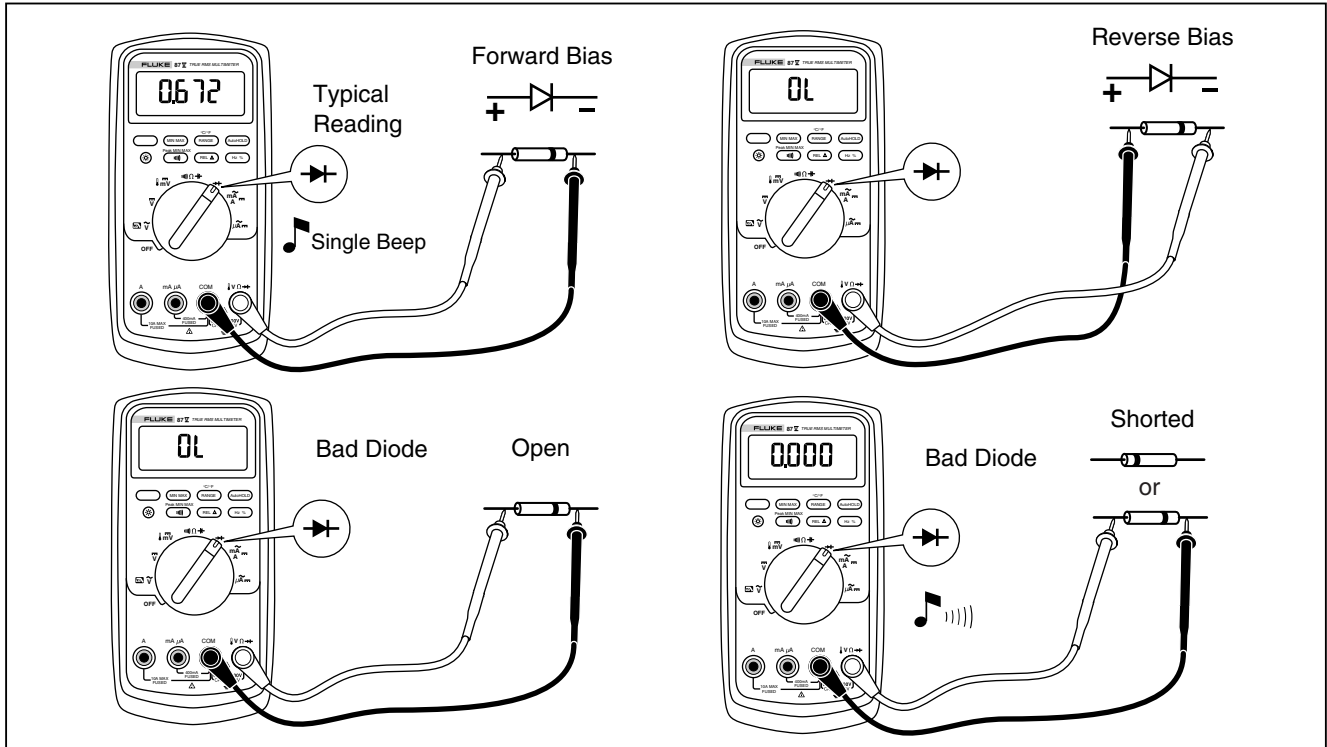

Figure 7. Testing a Diode

aom9f.eps

Measuring AC or DC Current

Warning

To avoid possible electric shock or personal injury, never attempt an in-circuit current measurement where the open-circuit potential to earth is greater than 1000 V. You may damage the Meter or be injured if the fuse blows during such a measurement.

Caution

To avoid possible damage to the Meter or to the equipment under test:

- Check the Meter's fuses before measuring current.
- Use the proper terminals, function, and range for all measurements.
- Never place the probes across (in parallel with) any circuit or component when the leads are plugged into the current terminals.

To measure current, you must break the circuit under test, then place the Meter in series with the circuit.

The Meter's current ranges are 600.0 μ A, 6000 μ A, 60.00 mA, 400.0 mA, 6000 mA, and 10 A. AC current is displayed as an rms value.

To measure current, refer to Figure 8 and proceed as follows:

1. Turn off power to the circuit. Discharge all high-voltage capacitors.
2. Insert the black lead into the **COM** terminal. For currents between 6 mA and 400 mA, insert the red lead into the **mA/ μ A** terminal. For currents above 400 mA, insert the red lead into the **A** terminal.

Note

To avoid blowing the Meter's 400 mA fuse, use the **mA/ μ A** terminal only if you are sure the current is less than 400 mA continuously or less than 600 mA for 18 hours or less.

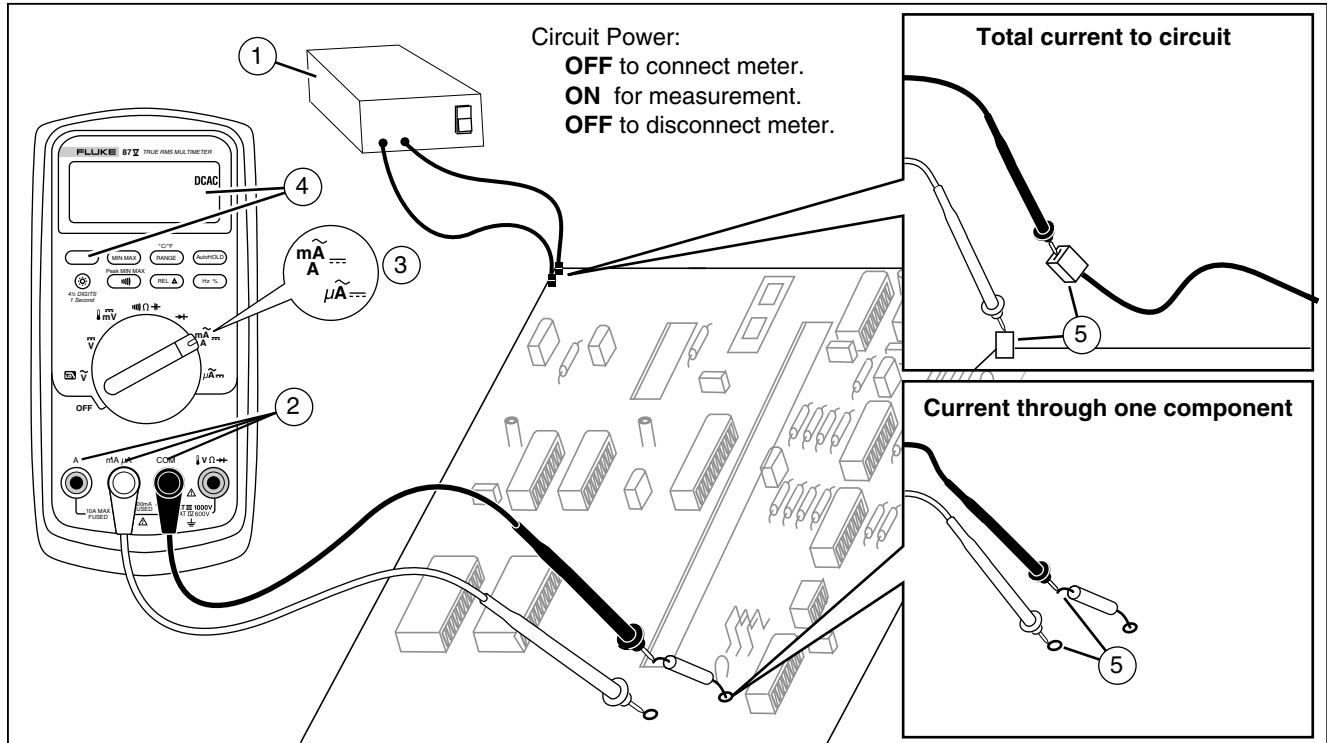



Figure 8. Measuring Current

aom7f.eps

3. If you are using the **A** terminal, set the rotary switch to mA/A. If you are using the **mA/μA** terminal, set the rotary switch to μA for currents below 6000 μA (6 mA), or mA/A for currents above 6000 μA.
4. To measure dc current, press .
5. Break the circuit path to be tested. Touch the black probe to the more negative side of the break; touch the red probe to the more positive side of the break. Reversing the leads will produce a negative reading, but will not damage the Meter.
6. Turn on power to the circuit; then read the display. Be sure to note the unit given at the right side of the display (μA, mA, or A).
7. Turn off power to the circuit and discharge all high-voltage capacitors. Remove the Meter and restore the circuit to normal operation.



The following are some tips for measuring current:

- If the current reading is 0 and you are sure the Meter is set up correctly, test the Meter's fuses as described under "Testing the Fuses".
- A current Meter drops a small voltage across itself, which might affect circuit operation. You can calculate this burden voltage using the values listed in the specifications in Table 14.

Measuring Frequency

The Meter measures the frequency of a voltage or current signal by counting the number of times the signal crosses a threshold level each second.

Table 6 summarizes the trigger levels and applications for measuring frequency using the various ranges of the Meter's voltage and current functions.

To measure frequency, connect the Meter to the signal source; then press . Pressing  switches the trigger slope between + and -, as indicated by the symbol at the left side of the display (refer to Figure 9 under "Measuring Duty Cycle"). Pressing  stops and starts the counter.

The Meter autoranges to one of five frequency ranges: 199.99 Hz, 1999.9 Hz, 19.999 kHz, 199.99 kHz, and greater than 200 kHz. For frequencies below 10 Hz, the display is updated at the frequency of the input. Below 0.5 Hz, the display may be unstable.

The following are some tips for measuring frequency:

- If a reading shows as 0 Hz or is unstable, the input signal may be below or near the trigger level. You can usually correct these problems by selecting a lower range, which increases the sensitivity of the Meter. In the \bar{V} function, the lower ranges also have lower trigger levels.
- If a reading seems to be a multiple of what you expect, the input signal may be distorted. Distortion can cause multiple triggerings of the frequency counter. Selecting a higher voltage range might solve this problem by decreasing the sensitivity of the Meter. You can also try selecting a dc range, which raises the trigger level. In general, the lowest frequency displayed is the correct one.

Table 6. Functions and Trigger Levels for Frequency Measurements

| Function | Range | Approximate Trigger Level | Typical Application |
|--|---|---------------------------|---|
| \tilde{V} | 6 V, 60 V, 600 V, 1000 V | ± 5 % of scale | Most signals. |
| \tilde{V} | 600 mV | ± 30 mV | High-frequency 5 V logic signals. (The dc-coupling of the \tilde{V} function can attenuate high-frequency logic signals, reducing their amplitude enough to interfere with triggering.) |
| $m\tilde{V}$ | 600 mV | 40 mV | Refer to the measurement tips given before this table. |
| \bar{V} | 6 V | 1.7 V | 5 V logic signals (TTL). |
| \bar{V} | 60 V | 4 V | Automotive switching signals. |
| \bar{V} | 600 V | 40 V | Refer to the measurement tips given before this table. |
| \bar{V} | 1000 V | 100 V | |
| Ω \rightarrow \rightarrow \rightarrow | Frequency counter characteristics are not available or specified for these functions. | | |
| $A\sim$ | All ranges | ± 5 % of scale | AC current signals. |
| $\mu A\rightarrow$ | 600 μ A, 6000 μ A | 30 μ A , 300 μ A | Refer to the measurement tips given before this table. |
| $mA\rightarrow$ | 60 mA, 400 mA | 3.0 mA , 30 mA | |
| $A\rightarrow$ | 6 A, 10 A | 0.30 A, 3.0 A | |

Measuring Duty Cycle

Duty cycle (or duty factor) is the percentage of time a signal is above or below a trigger level during one cycle (Figure 9). The duty cycle mode is optimized for measuring the on or off time of logic and switching signals. Systems such as electronic fuel injection systems and switching power supplies are controlled by pulses of varying width, which can be checked by measuring duty cycle.

To measure duty cycle, set up the Meter to measure frequency; then press Hz a second time. As with the

frequency function, you can change the slope for the Meter's counter by pressing .

For 5 V logic signals, use the 6 V dc range. For 12 V switching signals in automobiles, use the 60 V dc range. For sine waves, use the lowest range that does not result in multiple triggering. (Normally, a distortion-free signal can be up to ten times the amplitude of the selected voltage range.)

If a duty cycle reading is unstable, press MIN MAX; then scroll to the AVG (average) display.

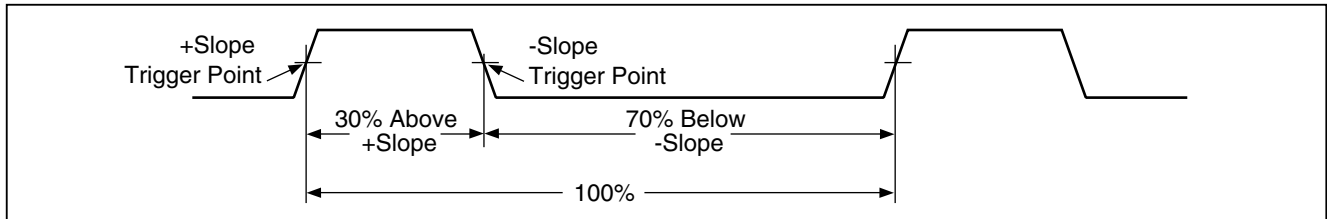



Figure 9. Components of Duty Cycle Measurements

iy3f.eps

Determining Pulse Width

For a periodic waveform (its pattern repeats at equal time intervals), you can determine the amount of time that the signal is high or low as follows:

1. Measure the signal's frequency.
2. Press  a second time to measure the signal's duty cycle. Press  to select a measurement of the signal's positive or negative pulse, refer to Figure 9.
3. Use the following formula to determine the pulse width:

$$\text{Pulse Width (in seconds)} = \frac{\% \text{ Duty Cycle} \div 100}{\text{Frequency}}$$

Bar Graph

The analog bar graph functions like the needle on an analog meter, but without the overshoot. The bar graph updates 40 times per second. Because the graph responds 10 times faster than the digital display, it is useful for making peak and null adjustments and observing rapidly changing inputs. The graph is not shown for capacitance, frequency counter functions, temperature, or peak min max.



The number of lit segments indicates the measured value and is relative to the full-scale value of the selected range.

In the 60 V range, for example, the major divisions on the scale represent 0, 15, 30, 45, and 60 V. An input of -30 V lights the negative sign and the segments up to the middle of the scale.

The bar graph also has a zoom function, as described under "Zoom Mode".

Zoom Mode (Power Up Option Only)

To use the Rel Zoom Bar Graph:



1. Hold down  while turning the Meter on. The display reads "REL".
2. Select the relative mode by pressing  again.
3. The center of the bar graph now represents zero and the sensitivity of the bar graph increases by a factor of 10. Measured values more negative than the stored reference activate segments to the left of center; values more positive activate segments to the right of center.

Uses for the Zoom Mode

The relative mode, combined with the increased sensitivity of the bar graph's zoom mode, helps you make fast and accurate zero and peak adjustments.

For zero adjustments, set the Meter to the desired function, short the test leads together, press ; then connect the leads to the circuit under test. Adjust the circuit's variable component until the display reads zero. Only the center segment on the zoom bar graph is lit.

For peak adjustments, set the Meter to the desired function, connect the leads to the circuit under test; then press . The display reads zero. As you adjust for a positive or negative peak, the bar graph length increases

to the right or left of zero. If an overrange symbol lights (), press  twice to set a new reference; then continue with the adjustment.

HiRes Mode (Model 87)

On a Model 87 Meter, pressing  for one second causes the Meter to enter the high-resolution (HiRes), 4-1/2 digit mode. Readings are displayed at 10 times the normal resolution with a maximum display of 19,999 counts. The HiRes mode works in all modes except capacitance, frequency counter functions, temperature, and the 250 μ s (peak) MIN MAX modes.

To return to the 3-1/2 digit mode, press  again for one second.

MIN MAX Recording Mode

The MIN MAX mode records minimum and maximum input values. When the inputs go below the recorded minimum value or above the recorded maximum value, the Meter beeps and records the new value. This mode can be used to capture intermittent readings, record maximum readings while you are away or record readings while you are operating the equipment under test and cannot watch the Meter. MIN MAX mode can also calculate an average of all readings taken since the MIN MAX mode was activated. To use MIN MAX mode, refer to the functions in Table 7.

Response time is the length of time an input must stay at a new value to be recorded. A shorter response time captures shorter events, but with decreased accuracy. Changing the response time erases all recorded readings. Model 83 has 100 millisecond response time; Model 87 has 100 millisecond, and 250 μ s (peak) response times. The 250 μ s response time is indicated by "**PEAK**" on the display.

The 100 millisecond response time is best for recording power supply surges, inrush currents, and finding intermittent failures.

The true average value (AVG) displayed in the 100 ms mode is the mathematical integral of all readings taken since the start of recording (overloads are discarded).

The average reading is useful for smoothing out unstable inputs, calculating power consumption, or estimating the percentage of time a circuit is active.

Min Max records the signal extremes lasting longer than 100 ms.

Peak records the signal extremes lasting longer than 250 μ s.

Smooth Feature (Power Up Option Only)

When the input signal changes rapidly, "smoothing" provides a steadier reading on the display.

To use the smooth feature:







1. Hold down **RANGE** while turning the Meter on. The display will read "5---" until **RANGE** is released.
2. The smooth icon () will appear on the left side of the display to let you know that smoothing is active.

Table 7. MIN MAX Functions

| Button | MIN MAX Function |
|--|--|
|  | Enter MIN MAX recording mode. The Meter is locked in the range displayed before you entered MIN MAX mode. (Select the desired measurement function and range before entering MIN MAX.) The Meter beeps each time a new minimum or maximum value is recorded. |
|  (while in MIN MAX mode) | Step through maximum (MAX), minimum (MIN), average (AVG) and present values. |
|  PEAK MIN MAX | Model 87 only: Select 100 ms or 250 μ s response time. (The 250 μ s response time is indicated by PEAK on the display.) Stored values are erased. The present and AVG (average) values are not available when 250 μ s is selected. |
|  | Stop recording without erasing stored values. Press again to resume recording. |
|  (hold for 1 second) | Exit MIN MAX mode. Stored values are erased. The Meter stays in the selected range. |



AutoHOLD Mode

Warning

To avoid possible electric shock or personal injury, do not use AutoHOLD mode to determine that circuits are without power. The AutoHOLD mode will not capture unstable or noisy readings.

The AutoHOLD mode captures the present reading on the display. When a new, stable reading is detected, the Meter beeps and displays the new reading. To enter or exit AutoHOLD mode, press .

Relative Mode

Selecting relative mode () causes the Meter to zero the display and store the present reading as the reference for subsequent measurements. The Meter is locked into the range selected when you pressed . Press  again to exit this mode.

In relative mode, the reading shown is always the difference between the present reading and the stored reference value. For example, if the stored reference value is 15.00 V and the present reading is 14.10 V, the display shows -0.90 V.

Maintenance

Warning

To avoid possible electric shock or personal injury, repairs or servicing not covered in this manual should be performed only by qualified personnel as described in the 80 Series V Service Information.

General Maintenance

Periodically wipe the case with a damp cloth and mild detergent. Do not use abrasives or solvents.

Dirt or moisture in the terminals can affect readings and can falsely activate the Input Alert feature. Clean the terminals as follows:

1. Turn the Meter off and remove all test leads.
2. Shake out any dirt that may be in the terminals.
3. Soak a new swab with a cleaning and oiling agent (such as WD-40). Work the swab around in each terminal. The oiling agent insulates the terminals from moisture-related activation of the Input Alert feature.

Fuse Test

If a test lead is plugged into the mA/μA or A terminal and the rotary switch is turned to a non-current function, the Meter chirps and flashes “L E R d” if the fuse associated with that current terminal is good. If the Meter does not chirp or flash “L E R d”, the fuse is bad and must be replaced. Refer to Table 8 for the appropriate replacement fuse.

To test the quality of the fuse before measuring current, test the appropriate fuse as shown in Figure 10. If the tests give readings other than those shown, have the Meter serviced.

Warning

To avoid electrical shock or personal injury, remove the test leads and any input signals before replacing the battery or fuses. To prevent damage or injury, install ONLY specified replacement fuses with the amperage, voltage, and speed ratings shown in Table 8.

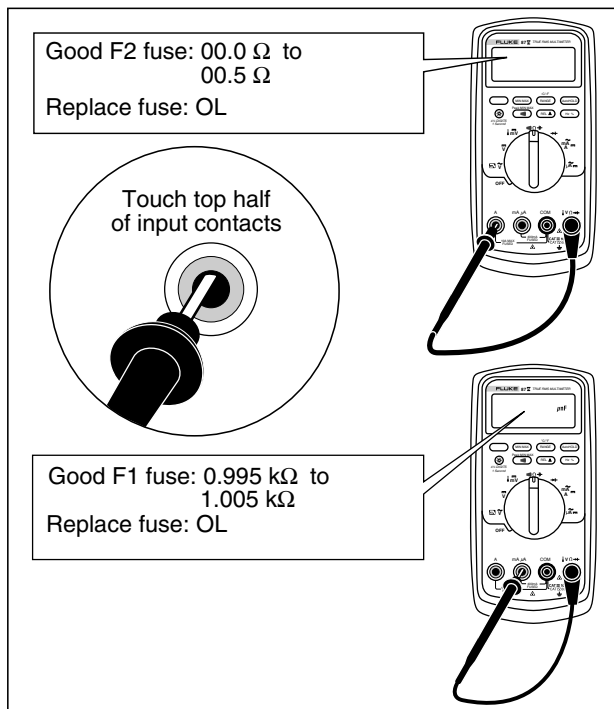

Figure 10. Testing the Current Fuses

Replacing the Battery

Replace the battery with a 9 V battery (NEDA A1604, 6F22, or 006P).

⚠ ⚠ Warning

To avoid false readings, which could lead to possible electric shock or personal injury, replace the battery as soon as the battery indicator (🔋) appears. If the display shows **bAt** the Meter will not function until the battery is replaced.

Replace the battery as follows, refer to Figure 11:

1. Turn the rotary switch to OFF and remove the test leads from the terminals.
2. Remove the battery door by using a standard-blade screwdriver to turn the battery door screws one-quarter turn counterclockwise.
3. Replace the battery and the battery door. Secure the door by turning the screws one-quarter turn clockwise.

Replacing the Fuses

Referring to Figure 11, examine or replace the Meter's fuses as follows:

1. Turn the rotary switch to OFF and remove the test leads from the terminals.
2. Remove the battery door by using a standard-blade screwdriver to turn the battery door screws one-quarter turn counterclockwise.
3. Remove the three Phillips-head screws from the case bottom and turn the case over.
4. Gently push up the input terminal-end of the top case from inside of the battery compartment to separate the two halves of the case.
5. Remove the fuse by gently prying one end loose, then sliding the fuse out of its bracket.
6. Install ONLY specified replacement fuses with the amperage, voltage, and speed ratings shown in Table 8.
7. Verify that the rotary switch and the circuit board switch are in the OFF position.
8. Replace the case top, ensuring that the gasket is properly seated and case snaps together above the LCD (item ①).
9. Reinstall the three screws and the battery door. Secure the door by turning the screws one-quarter turn clockwise.

Service and Parts

If the Meter fails, check the battery and fuses. Review this manual to verify proper use of the Meter.

Replacement parts and accessories are shown in Tables 8 and 9 and Figure 12.

To order parts and accessories, refer to "Contacting Fluke".

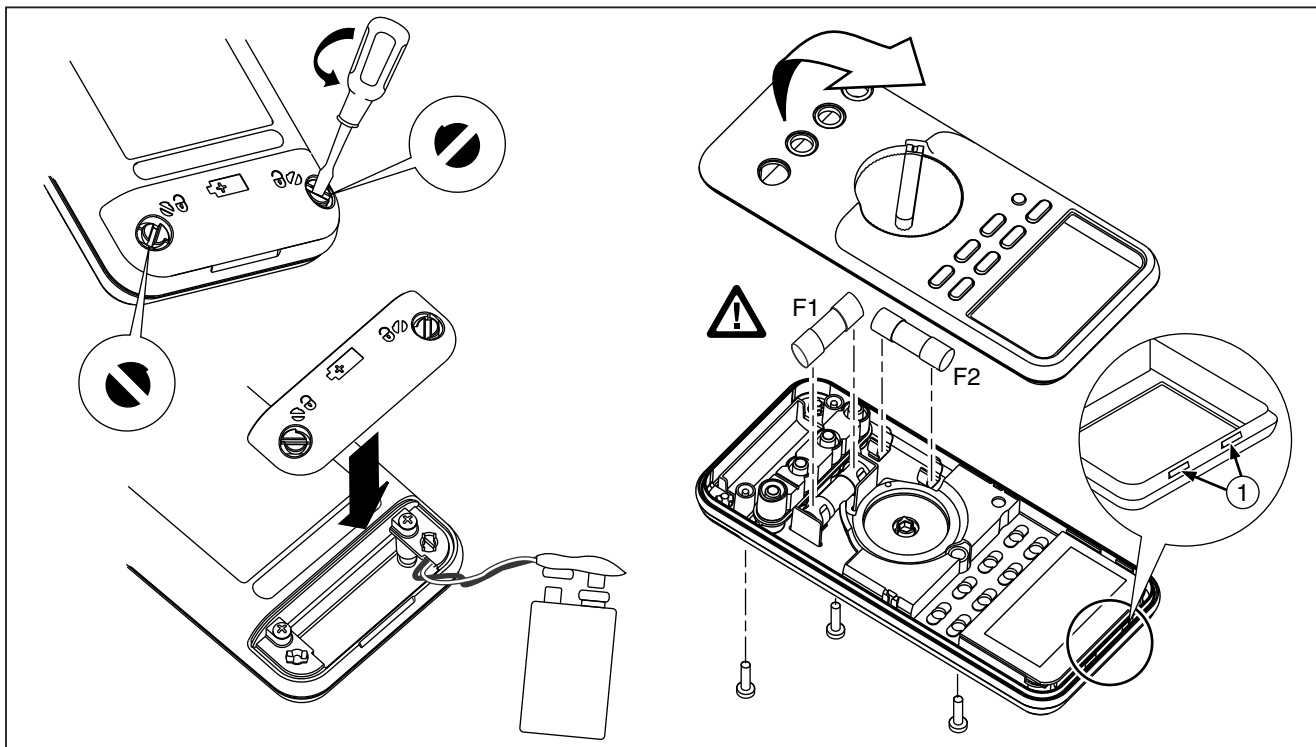



Figure 11. Battery and Fuse Replacement

aom12f.eps

Table 8. Replacement Parts

| Item | Description | Qty. | Fluke Part or Model Number |
|--|---------------------------------|------|----------------------------|
| BT1 | Battery, 9 V | 1 | 2139179 |
| BT2 | Cable Assy, 9 V Battery Snap | 1 | 2064217 |
| F1  | Fuse, 0.440 A, 1000 V, FAST | 1 | 943121 |
| F2  | Fuse, 11 A, 1000 V, FAST | 1 | 803293 |
| H2-4 | Screw, Case | 3 | 832246 |
| H5-9 | Screw, Bottom Shield | 5 | 448456 |
| J1-2 | Elastomeric Connector | 2 | 817460 |
| MP2 | Shield, Top | 1 | 2073906 |
| MP4 | Shield, Bottom | 1 | 2074025 |
| MP5 | Case Top (PAD XFER) With Window | 1 | 2073992 |
| MP6 | Case Bottom | 1 | 2073871 |
| MP8 | Knob, Switch (PAD XFER) | 1 | 2100482 |
| MP9 | Detent, Knob | 1 | 822643 |
| MP10-11 | Foot, Non-Skid | 2 | 824466 |
| MP13 | Shock Absorber | 1 | 828541 |
| MP14 | O-Ring, Input Receptacle | 1 | 831933 |
| MP15 | Holster | 1 | 2074033 |
| MP22 | Battery Door | 1 | 2073938 |
| MP27-MP30 | Contact RSOB | 4 | 1567683 |
| MP31 | Mask, LCD (PAD XFER) | 1 | 2073950 |
| MP41 | Housing, RSOB | 1 | 2073945 |

 To ensure safety, use exact replacement only.

Table 8. Replacement Parts (cont.)

| Item | Description | Qty. | Fluke Part or Model Number |
|-------------|--|-------------|-----------------------------------|
| AC72 | Alligator Clip, Black | 1 | 1670652 |
| AC72 | Alligator Clip, Red | 1 | 1670641 |
| TL75 | Test Lead Set | 1 | 855742 |
| MP81 | Thermocouple Assembly, K-Type, Beaded, Molded Dual Banana Plug, Coiled | 1 | 1273113 |
| MP390-391 | Access Door Fastener | 2 | 948609 |
| NA | Tiltstand | 1 | 2074040 |
| U5 | LCD, 4.5 DIGIT, TN, Transflective, Bar Graph, OSPR80 | 1 | 2065213 |
| CR6 | Lightpipe | 1 | 2074057 |
| S2 | Keypad | 1 | 2105884 |
| TM1 | 80 Series V Multi-Language Getting Started Manual | 1 | 2101973 |
| TM2 | 80 Series V Quick Reference Card | 1 | 2101986 |
| TM3 | CD ROM, 80 Series V User Manual | 1 | 2101999 |

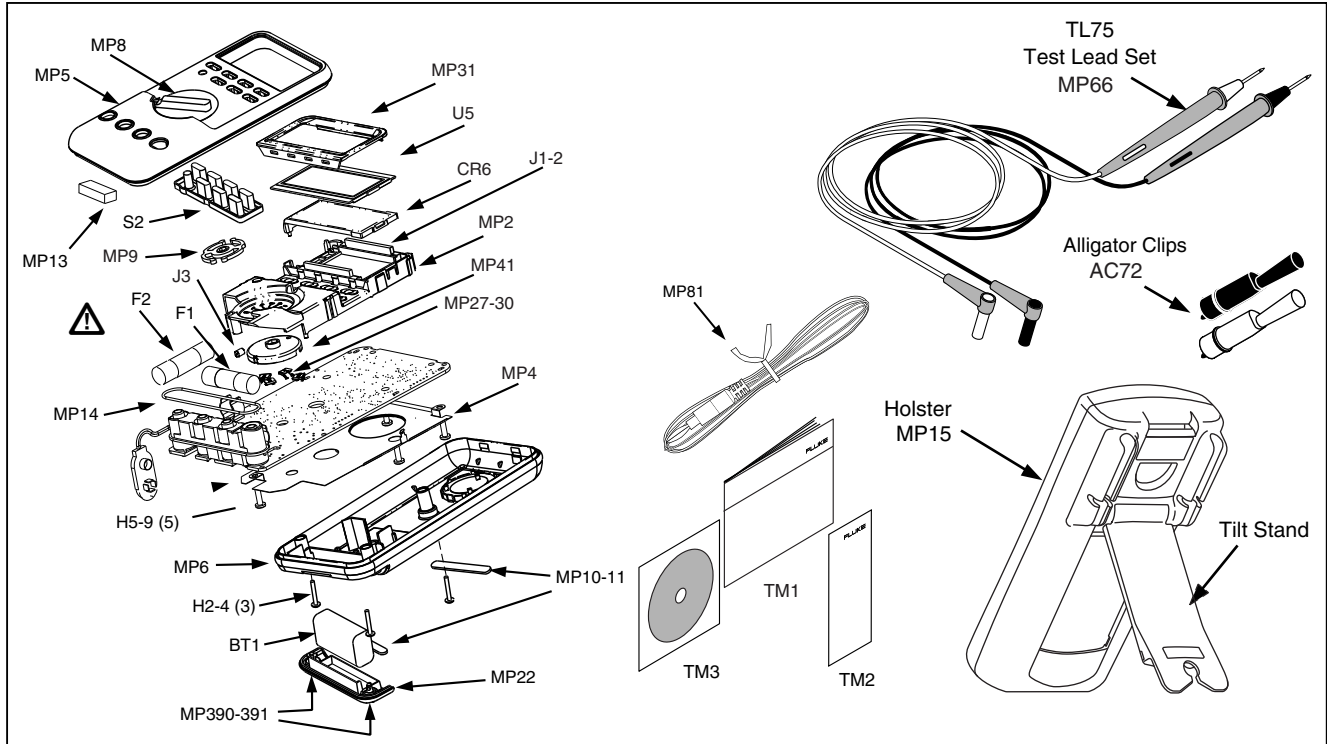

Figure 12. Replaceable Parts

aom015c.eps

Table 9. Accessories

| Item | Description |
|---|---|
| AC72 | Alligator Clips for use with TL75 test lead set |
| AC220 | Safety Grip, Wide-Jaw Alligator Clips |
| TPAK | ToolPak Magnetic Hanger |
| H87 | Holster, Yellow |
| C25 | Carrying Case, Soft |
| TL76 | 4 mm Diameter Test Leads |
| TL220 | Industrial Test Lead Set |
| TL224 | Test Lead Set, Heat-Resistant Silicone |
| TP1 | Test Probes, Flat Blade, Slim Reach |
| TP4 | Test Probes, 4 mm diameter, Slim Reach |
| Fluke accessories are available from an authorized Fluke distributor. | |

Specifications

Maximum Voltage between any Terminal and Earth Ground: 1000 V rms

⚠ Fuse Protection for mA or μ A inputs: 44/100 A, 1000 V FAST Fuse

⚠ Fuse Protection for A input: 11 A, 1000 V FAST Fuse

Display: Digital: 6000 counts updates 4/sec; (Model 87 also has 19,999 counts in high-resolution mode).

Analog Bargraph: 33 segments, updates 40/sec. Frequency: 19,999 counts, updates 3/sec at >10 Hz

Temperature: Operating: -20 °C to +55 °C; Storage: -40 °C to +60 °C

Altitude: Operating: 2000 m; Storage: 10,000 m

Temperature Coefficient: 0.05 x (specified accuracy)/ °C (<18 °C or >28 °C)

Electromagnetic Compatibility: In an RF field of 3 V/m total accuracy = specified accuracy + 20 counts

Except: 600 μ A dc range total accuracy=specified accuracy +60 counts.

Temperature not specified.

Relative Humidity: 0 % to 90 % (0 °C to 35 °C); 0 % to 70 % (35 °C to 55 °C)

Battery Type: 9 V zinc, NEDA 1604 or 6F22 or 006P

Battery Life: 400 hrs typical with alkaline (with backlight off)

Vibration: Per MIL-PRF-28800 for a Class 2 instrument

Shock: 1 Meter drop per IEC 61010-1:2001

Size (HxWxL): 1.25 in x 3.41 in x 7.35 in (3.1 cm x 8.6 cm x 18.6 cm)

Size with Holster and Flex-Stand: 2.06 in x 3.86 in x 7.93 in (5.2 cm x 9.8 cm x 20.1 cm)

Weight: 12.5 oz (355 g)

Weight with Holster and Flex-Stand: 22.0 oz (624 g)

Safety: Complies with ANSI/ISA S82.01-2004, CSA 22.2 No. 1010.1:2004 to 1000 V Overvoltage Category III, IEC 664 to 600 V Overvoltage Category IV. UL listed to UL61010-1. Licensed by TÜV to EN61010-1.

IP Rating: 30

Detailed Specifications

For all detailed specifications:

Accuracy is given as \pm ([% of reading] + [number of least significant digits]) at 18° C to 28° C, with relative humidity up to 90 %, for a period of one year after calibration.

For Model 87 in the 4 ½-digit mode, multiply the number of least significant digits (counts) by 10. AC conversions are ac-coupled and valid from 3 % to 100 % of range. Model 87 is true rms responding. AC crest factor can be up to 3 at full scale, 6 at half scale. For non-sinusoidal wave forms add $-(2 \% \text{ Rdg} + 2 \% \text{ full scale})$ typical, for a crest factor up to 3.

Table 10. Model 87 AC Voltage Function Specifications

| Function | Range | Resolution | Accuracy | | | | | |
|------------------------------|-----------------|------------------|--------------------|-------------------------------------|--------------------|----------------|--------------------|---------------------------|
| | | | 45 – 65 Hz | 30 – 200 Hz | 200 – 440 Hz | 440 Hz - 1 kHz | 1 - 5 kHz | 5 - 20 kHz ^[1] |
| \tilde{V} ^[2,4] | 600.0 mV | 0.1 mV | $\pm (0.7 \% + 4)$ | | $\pm (1.0 \% + 4)$ | | $\pm (2.0 \% + 4)$ | $\pm (2.0 \% + 20)$ |
| | 6.000 V | 0.001 V | $\pm (0.7 \% + 2)$ | | | | | |
| | 60.00 V | 0.01 V | | | | | | |
| | 600.0 V | 0.1 V | | | | | | |
| | 1000 V | 1 V | | | | | | |
| | Low pass filter | Same as 45-65 Hz | $\pm (1.0 \% + 4)$ | +1 % + 4 -6 % - 4 ^[5] | unspecified | unspecified | unspecified | |

[1] Below 10 % of range, add 12 counts.

[2] The Meter is a true rms responding meter. When the input leads are shorted together in the ac functions, the Meter may display a residual reading between 1 and 30 counts. A 30 count residual reading will cause only a 2-digit change for readings over 3 % of range. Using REL to offset this reading may produce a much larger constant error in later measurements.

[3] Frequency range: 1 kHz to 2.5 kHz.

[4] A residual reading of up to 13 digits with leads shorted, will not affect stated accuracy above 3 % of range.

[5] Specification increases from -1% at 200 Hz to -6% at 440 Hz when filter is in use.

Table 11. Model 83 AC Voltage Function Specifications

| Function | Range | Resolution | Accuracy | | |
|---|----------|------------|--------------------|--------------------|----------------------|
| | | | 50 Hz - 60 Hz | 30 Hz - 1 kHz | 1 kHz - 5 kHz |
| \tilde{V}^1 | 600.0 mV | 0.1 mV | $\pm (0.5 \% + 4)$ | $\pm (1.0 \% + 4)$ | $\pm (2.0 \% + 4)$ |
| | 6.000 V | 0.001 V | $\pm (0.5 \% + 2)$ | $\pm (1.0 \% + 4)$ | $\pm (2.0 \% + 4)$ |
| | 60.00 V | 0.01 V | $\pm (0.5 \% + 2)$ | $\pm (1.0 \% + 4)$ | $\pm (2.0 \% + 4)$ |
| | 600.0 V | 0.1 V | $\pm (0.5 \% + 2)$ | $\pm (1.0 \% + 4)$ | $\pm (2.0 \% + 4)^2$ |
| | 1000 V | 1 V | $\pm (0.5 \% + 2)$ | $\pm (1.0 \% + 4)$ | unspecified |
| 1. Below a reading of 200 counts, add 10 counts. 2. Frequency range: 1 kHz to 2.5 kHz. | | | | | |

Table 12. DC Voltage, Resistance, and Conductance Function Specifications

| Function | Range | Resolution | Accuracy | |
|--|------------------|------------------|-----------------------|-----------------------|
| | | | Model 83 | Model 87 |
| \bar{V} | 6.000 V | 0.001 V | $\pm (0.1 \% + 1)$ | $\pm (0.05 \% + 1)$ |
| | 60.00 V | 0.01 V | $\pm (0.1 \% + 1)$ | $\pm (0.05 \% + 1)$ |
| | 600.0 V | 0.1 V | $\pm (0.1 \% + 1)$ | $\pm (0.05 \% + 1)$ |
| | 1000 V | 1 V | $\pm (0.1 \% + 1)$ | $\pm (0.05 \% + 1)$ |
| \bar{mV} | 600.0 mV | 0.1 mV | $\pm (0.3 \% + 1)$ | $\pm (0.1 \% + 1)$ |
| Ω nS | 600.0 Ω | 0.1 Ω | $\pm (0.4 \% + 2)^1$ | $\pm (0.2 \% + 2)^1$ |
| | 6.000 k Ω | 0.001 k Ω | $\pm (0.4 \% + 1)$ | $\pm (0.2 \% + 1)$ |
| | 60.00 k Ω | 0.01 k Ω | $\pm (0.4 \% + 1)$ | $\pm (0.2 \% + 1)$ |
| | 600.0 k Ω | 0.1 k Ω | $\pm (0.7 \% + 1)$ | $\pm (0.6 \% + 1)$ |
| | 6.000 M Ω | 0.001 M Ω | $\pm (0.7 \% + 1)$ | $\pm (0.6 \% + 1)$ |
| | 50.00 M Ω | 0.01 M Ω | $\pm (1.0 \% + 3)^2$ | $\pm (1.0 \% + 3)^2$ |
| | 60.00 nS | 0.01 nS | $\pm (1.0 \% + 10)^1$ | $\pm (1.0 \% + 10)^1$ |
| <p>1. When using the REL Δ function to compensate for offsets. 2. Add 0.5 % of reading when measuring above 30 MΩ in the 50 MΩ range, and 20 counts below 33 nS in the 60 nS range.</p> | | | | |

Table 13. Temperature Specifications (87 Only)



| Temperature | Resolution | Accuracy^{1,2} |
|---|-------------------|-------------------------------|
| -200 °C to +1090 °C | 0.1 °C | 1 % + 10 |
| -328 °F to +1994 °F | 0.1 °F | 1 % + 18 |
| <p>1. Does not include error of the thermocouple probe. 2. Accuracy specification assumes ambient temperature stable to ± 1 °C. For ambient temperature changes of ± 5 °C, rated accuracy applies after 1 hour.</p> | | |

Table 14. Current Function Specifications

| Function | Range | Resolution | Accuracy | | Burden Voltage (typical) |
|--|-----------------------|------------|-----------------------|--------------------------|--------------------------|
| | | | Model 83 ¹ | Model 87 ^{2, 3} | |
| mA A~ (45 Hz to 2 kHz) | 60.00 mA | 0.01 mA | $\pm (1.2 \% + 2)^5$ | $\pm (1.0 \% + 2)$ | 1.8 mV/mA |
| | 400.0 mA ⁶ | 0.1 mA | $\pm (1.2 \% + 2)^5$ | $\pm (1.0 \% + 2)$ | 1.8 mV/mA |
| | 6.000 A | 0.001 A | $\pm (1.2 \% + 2)^5$ | $\pm (1.0 \% + 2)$ | 0.03 V/A |
| | 10.00 A ⁴ | 0.01 A | $\pm (1.2 \% + 2)^5$ | $\pm (1.0 \% + 2)$ | 0.03 V/A |
| mA A= | 60.00 mA | 0.01 mA | $\pm (0.4 \% + 4)$ | $\pm (0.2 \% + 4)$ | 1.8 mV/mA |
| | 400.0 mA ⁶ | 0.1 mA | $\pm (0.4 \% + 2)$ | $\pm (0.2 \% + 2)$ | 1.8 mV/mA |
| | 6.000 A | 0.001 A | $\pm (0.4 \% + 4)$ | $\pm (0.2 \% + 4)$ | 0.03 V/A |
| | 10.00 A ⁴ | 0.01 A | $\pm (0.4 \% + 2)$ | $\pm (0.2 \% + 2)$ | 0.03 V/A |
| μA ~ (45 Hz to 2 kHz) | 600.0 μA | 0.1 μA | $\pm (1.2 \% + 2)^5$ | $\pm (1.0 \% + 2)$ | 100 μV/μA |
| | 6000 μA | 1 μA | $\pm (1.2 \% + 2)^5$ | $\pm (1.0 \% + 2)$ | 100 μV/μA |
| μA= | 600.0 μA | 0.1 μA | $\pm (0.4 \% + 4)$ | $\pm (0.2 \% + 4)$ | 100 μV/μA |
| | 6000 μA | 1 μA | $\pm (0.4 \% + 2)$ | $\pm (0.2 \% + 2)$ | 100 μV/μA |

1. AC conversion for Model 83 is ac coupled and calibrated to the rms value of a sine wave input.
2. AC conversions for Model 87 are ac coupled, true rms responding, and valid from 3 % to 100 % of range, except 400 mA range (5 % to 100 % of range) and 10 A range (15 % to 100 % of range).
3. Model 87 is a true rms responding meter. When the input leads are shorted together in the ac functions, the Meter may display a residual reading between 1 and 30 counts. A 30 count residual reading will cause only a 2 digit change for readings over 3 % of range. Using REL to offset this reading may produce a much larger constant error in later measurements
4. Δ 10 A continuous up to 35 °C; < 20 minutes on, 5 minutes off at 35 °C to 55 °C. 20 A for 30 seconds maximum; > 10 A unspecified.
5. Below a reading of 200 counts, add 10 counts.
6. 400 mA continuous; 600 mA for 18 hrs maximum.

Table 15. Capacitance and Diode Function Specifications

| Function | Range | Resolution | Accuracy |
|---|---------------|---------------|--------------------|
|  | 10.00 nF | 0.01 nF | $\pm (1 \% + 2)^1$ |
| | 100.0 nF | 0.1 nF | $\pm (1 \% + 2)^1$ |
| | 1.000 μ F | 0.001 μ F | $\pm (1 \% + 2)$ |
| | 10.00 μ F | 0.01 μ F | $\pm (1 \% + 2)$ |
| | 100.0 μ F | 0.1 μ F | $\pm (1 \% + 2)$ |
| | 9999 μ F | 1 μ F | $\pm (1 \% + 2)$ |
|  | 3.000 V | 0.001 V | $\pm (2 \% + 1)$ |

1. With a film capacitor or better, using Relative mode to zero residual.

Table 16. Frequency Counter Specifications

| Function | Range | Resolution | Accuracy |
|--|------------|------------|----------------------|
| Frequency (0.5 Hz to 200 kHz, pulse width > 2 μ s) | 199.99 | 0.01 Hz | $\pm (0.005 \% + 1)$ |
| | 1999.9 | 0.1 Hz | $\pm (0.005 \% + 1)$ |
| | 19.999 kHz | 0.001 kHz | $\pm (0.005 \% + 1)$ |
| | 199.99 kHz | 0.01 kHz | $\pm (0.005 \% + 1)$ |
| | > 200 kHz | 0.1 kHz | unspecified |

Table 17. Frequency Counter Sensitivity and Trigger Levels

| Input Range ¹ | Minimum Sensitivity (RMS Sine wave) | | Approximate Trigger Level (DC Voltage Function) |
|--|---|-------------------------|--|
| | 5 Hz - 20 kHz | 0.5 Hz - 200 kHz | |
| 600 mV dc | 70 mV (to 400 Hz) | 70 mV (to 400 Hz) | 40 mV |
| 600 mV ac | 150 mV | 150 mV | — |
| 6 V | 0.3 V | 0.7 V | 1.7 V |
| 60 V | 3 V | 7 V (≤ 140 kHz) | 4 V |
| 600 V | 30 V | 70 V (≤ 14.0 kHz) | 40 V |
| 1000 V | 100 V | 200 V (≤ 1.4 kHz) | 100 V |
| Duty Cycle Range | Accuracy | | |
| 0.0 to 99.9 % | Within \pm (0.2% per kHz + 0.1 %) for rise times < 1 μ s. | | |
| 1. Maximum input for specified accuracy = 10X Range or 1000 V. | | | |

Table 18. Electrical Characteristics of the Terminals

| Function | Overload Protection ¹ | Input Impedance (nominal) | Common Mode Rejection Ratio (1 k Ω unbalance) | | Normal Mode Rejection | | | | | | |
|-----------------------------|----------------------------------|-------------------------------------|--|--------------------|---------------------------|-------------------------------|------------|-----------|-----------|-------------|------|
| \bar{V} | 1000 V rms | 10 M Ω < 100 pF | > 120 dB at dc, 50 Hz or 60 Hz | | > 60 dB at 50 Hz or 60 Hz | | | | | | |
| \bar{mV} | 1000 V rms | 10 M Ω < 100 pF | > 120 dB at dc, 50 Hz or 60 Hz | | > 60 dB at 50 Hz or 60 Hz | | | | | | |
| \tilde{V} | 1000 V rms | 10 M Ω < 100 pF (ac-coupled) | > 60 dB, dc to 60 Hz | | | | | | | | |
| | | | Open Circuit Test Voltage | Full Scale Voltage | | Typical Short Circuit Current | | | | | |
| | | | | To 6.0 M Ω | 50 M Ω or 60 nS | 600 Ω | 6 k | 60 k | 600 k | 6 M | 50 M |
| Ω | 1000 V rms | < 7.9 V dc | < 4.1 V dc | < 4.5 V dc | 1 mA | 100 μ A | 10 μ A | 1 μ A | 1 μ A | 0.5 μ A | |
| \rightarrow | 1000 V rms | < 7.9 V dc | 3.000 V dc | | 1.0 mA typical | | | | | | |
| 1. 10 ⁶ V Hz max | | | | | | | | | | | |

Table 19. MIN MAX Recording Specifications

| Model | Nominal Response | Accuracy |
|--|---|---|
| 83 | 100 ms to 80 % | Specified accuracy ± 12 counts for changes > 200 ms in duration (± 40 counts in ac with beeper on) |
| 87 | 100 ms to 80 % (dc functions) | Specified accuracy ± 12 counts for changes > 200 ms in duration |
| | 120 ms to 80 % (ac functions) | Specified accuracy ± 40 counts for changes > 350 ms and inputs > 25 % of range |
| | 250 μ s (peak) (Model 87 only) ¹ | Specified accuracy ± 100 counts for changes > 250 μ s in duration (add ± 100 counts for readings over 6000 counts) (add ± 100 counts for readings in Low Pass mode) |
| 1. For repetitive peaks: 1 ms for single events. | | |



205 Westwood Ave
Long Branch, NJ 07740
1-877-742-TEST (8378)
Fax: (732) 222-7088
salesteam@Equipment.NET