

# 88 AUTOMOTIVE METER



**USERS MANUAL**

PN 666842  
November 1998

© 1998 Fluke Corporation. All rights reserved. Printed in U.S.A.  
All products names are registered trademarks of their respective companies

**FLUKE®**

# Contents

TITLE	PAGE
INTRODUCTION .....	1
USING THE METER SAFELY .....	1
GETTING ACQUAINTED WITH YOUR METER .....	3
Terminals and Input Alert .....	3
Switch .....	4
Pushbuttons .....	5
Digital and Analog Displays .....	5
Display Symbols .....	5
Turning on the Display Backlight .....	5
HOW TO PERFORM BASIC ELECTRICAL TESTS .....	9
Automotive Electrical System Tests .....	9
What is a Measurement Range and Why It's Important .....	10
(RANGE) Selecting a Measurement Range .....	11
~V, =V, =mV Measuring Voltage .....	12
→ Testing Diodes .....	14
mA A =, mA A ~ Measuring Current .....	16
⦿))) Ω Testing Circuit Continuity .....	18
Ω Measuring Resistance .....	20

USING PUSHBUTTON FUNCTIONS IN TYPICAL APPLICATIONS .....	22
<i>RPM</i> Measuring RPM .....	22
<i>RPM</i> (Hz) Testing BP/ MAP Sensors with Frequency Output .....	24
<i>% DUTY</i> Measuring Duty Cycle on a Feedback Carburetor .....	26
<i>% DUTY</i> (ms-PULSE) Measuring Pulse Width .....	28
<i>MIN MAX</i> Measuring Voltages on an O <sub>2</sub> Sensor .....	30
<i>HOLD III</i> Measuring Starter Circuit Voltage Drop .....	32
Testing the Throttle Position Sensor Using the Analog Pointer .....	34
<i>ZERO Δ</i> Compensating for Test Lead Resistance .....	36
○ SMOOTHING Rapidly Changing Inputs .....	38
<i>ALERT II</i> (± TRIGGER) Changing the Trigger Slope .....	39
<i>ALERT II</i> Using Change Alert to Detect Input Signal Change .....	39
SELECTING POWER-UP OPTIONS .....	40
USING THE HOLSTER AND FLEX-STAND .....	41
MAINTENANCE .....	42
General Maintenance .....	42
Replacing the Battery .....	42
Testing the Fuse(s) .....	44
Replacing the Fuse(s) .....	44
Basic Performance Test .....	45
If the Meter Does Not Work .....	45
ACCESSORIES AND REPLACEMENT PARTS .....	46
SPECIFICATIONS .....	48
APPENDICES	
A Duty Cycle to Dwell Conversion Chart .....	55

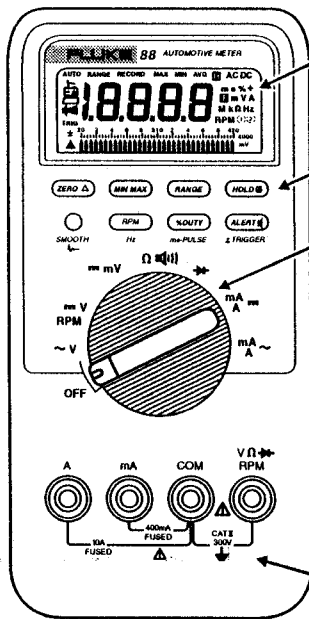

FRONT

DISPLAY

PUSHBUTTONS

ROTARY SWITCH

INPUT TERMINALS

POWER-UP OPTIONS

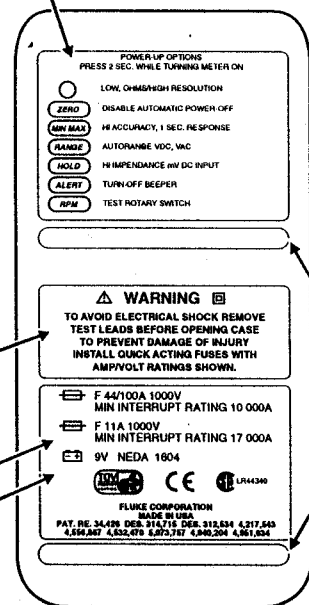

BACK

ELECTRICAL SHOCK AND FUSE WARNINGS

FUSE RATINGS  
BATTERY TYPE

SKID RESISTANT FEET

INTRODUCTION

**⚠ WARNING**

**READ "USING THE METER SAFELY"  
BEFORE USING THE METER.**

*NOTE*

*Some typical automotive tests are provided in this manual. These tests are designed to help you learn how to use the Meter. Consult your car's service manual for the test procedures that apply to your particular car.*

Your Fluke Automotive Meter (referred to as "the Meter") is a hand-held, battery-operated instrument for testing and troubleshooting automotive electronic systems. If the Meter is damaged or something is missing, contact the place of purchase immediately.

An Applications Guide on the inside of the front and back covers identifies some tests that you can perform with the Meter. For complete maintenance, repair, and calibration instructions, refer to the 88 Service Manual (PN 666856). To order in U.S.A. call 1-800-526-4731.

To contact Fluke, call one of the following telephone numbers:

USA and Canada: 1-888-99-FLUKE (1-888-993-5853)

Europe: +31 402-678-200

Japan: +81-3-3434-0181









Singapore: +65-\*276-6196

Anywhere in the world: +1-425-356-5500

Or, visit Fluke's Web site at [www.fluke.com](http://www.fluke.com).

**USING THE METER SAFELY**

A **WARNING** identifies conditions and actions that pose hazard(s) to the user; a **Caution** identifies conditions and actions that may damage the Meter. International electrical symbols used are explained in Figure 1.

	Conforms to European Union Directives		Ground
	AC-alternating current		See explanation in manual
	DC-Direct current		Double insulation (protection class)
	Either DC or AC		Fuse

**Figure 1. International Electrical Symbols**

## METER SAFETY

### Safety Information

This meter complies with EN 61010-1:1993, ANSI/ISA S82.01-1994 and CAN/CSA C22.2 No. 1010.1-92 Overvoltage Category II/300 volts. Use the meter only as specified in this Users Manual, otherwise the protection provided by the meter may be impaired.



To avoid possible electric shock or personal injury:

- Do not use the meter if it is damaged. Before use, inspect the case for cracks or missing plastic. Pay particular attention to the insulation surrounding the connectors.
- Inspect the test leads for damaged insulation or exposed metal. Check test lead continuity. Replace damaged leads.
- Do not use the meter if it operates abnormally. Protection may be impaired. When in doubt, have the meter serviced.
- Do not operate the meter around explosive gas, vapor or dust.
- Do not apply more than the rated voltage, as marked on the meter, between terminals or between any terminal and earth ground.
- Before each use, verify the meter's operation by measuring a known voltage.
- When servicing the meter, use only specified replacement parts.
- Use caution when working above 30V ac rms, 42V ac peak, or 60V dc. Such voltages pose a shock hazard.
- Keep fingers behind the finger guards on the probe when making measurements.
- Connect the common test lead before connecting the live test lead. Disconnect the live test lead first.
- Remove test leads from the meter before opening the case.
- Use only a single 9V battery, properly installed in the meter case, to power the meter.
- Follow all equipment safety procedures.
- Before measuring current, check the meter's fuses (see "How to Test the Fuse").
- Never touch the probe to a voltage source when the test leads are plugged into the 10 A input jack.
- Always use clamp-on probes (dc current clamps) when measure current exceeding 10 A.
- To avoid false readings, which could lead to possible electric shock or personal injury, replace the meter's battery as soon as the low battery indicator () appears.

## Caution

To avoid possible damage to the meter or to equipment under test:

- Disconnect the power to the circuit under test and discharge all high voltage capacitors before testing resistance, continuity or diodes.
- Use the proper function and range for your measurement applications.
- Avoid working alone.
- When measuring current, turn off circuit power before connecting the meter in the circuit. Remember to place the meter in series with the current.

## GETTING ACQUAINTED WITH YOUR METER

### Input Terminals and Input Alert

The Meter has four input terminals (Figure 2) that are protected against overloads to the limits shown in the specifications.

If a test lead is in an amp input terminal (A or mA) and the rotary switch is not set to an amp setting (mA A ac or dc), the beeper emits an Input Alert that sounds like a clicking noise. The Input Alert™ function can be disabled by holding **ALERT** down while turning the rotary switch from OFF to any position.



**WARNING**

**TO AVOID PERSONAL INJURY OR EQUIPMENT DAMAGE, NEVER ATTEMPT A VOLTAGE MEASUREMENT IF A TEST LEAD IS IN THE AMP (A) OR MILLIAMP (MA) INPUT TERMINAL.**

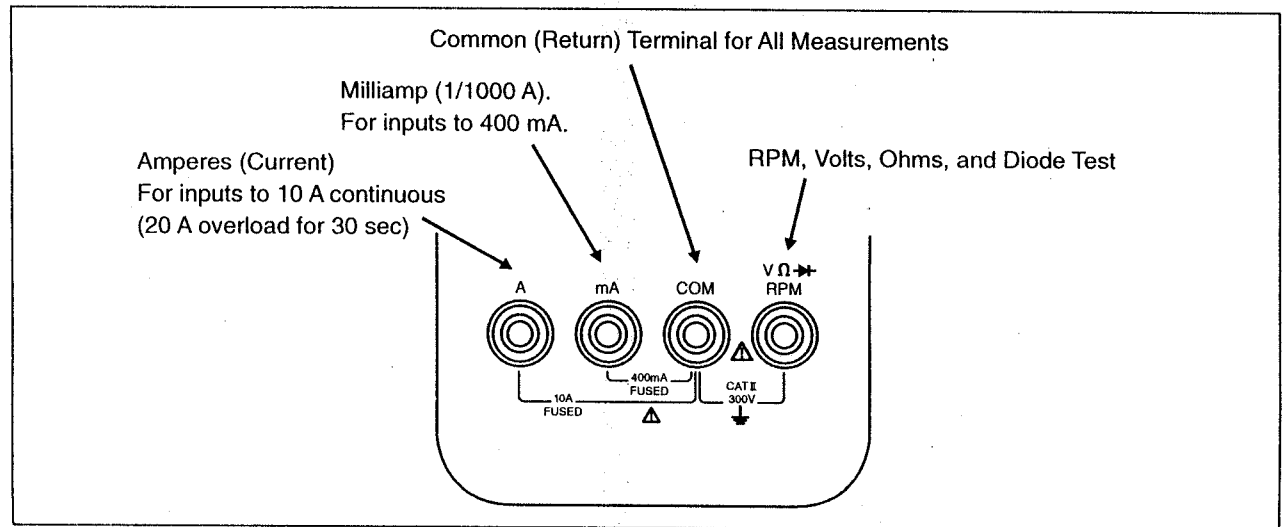

Figure 2. Input Terminals

## ROTARY SWITCH

### Rotary Switch

To turn the Meter on and select a function, turn the rotary switch (Figure 3) to a switch setting. The whole display lights for one second as part of a selftest

routine. Then the Meter is ready for use. (If you press and hold down any pushbutton while turning the meter from OFF to on, the display remains lit until the pushbutton is released.)

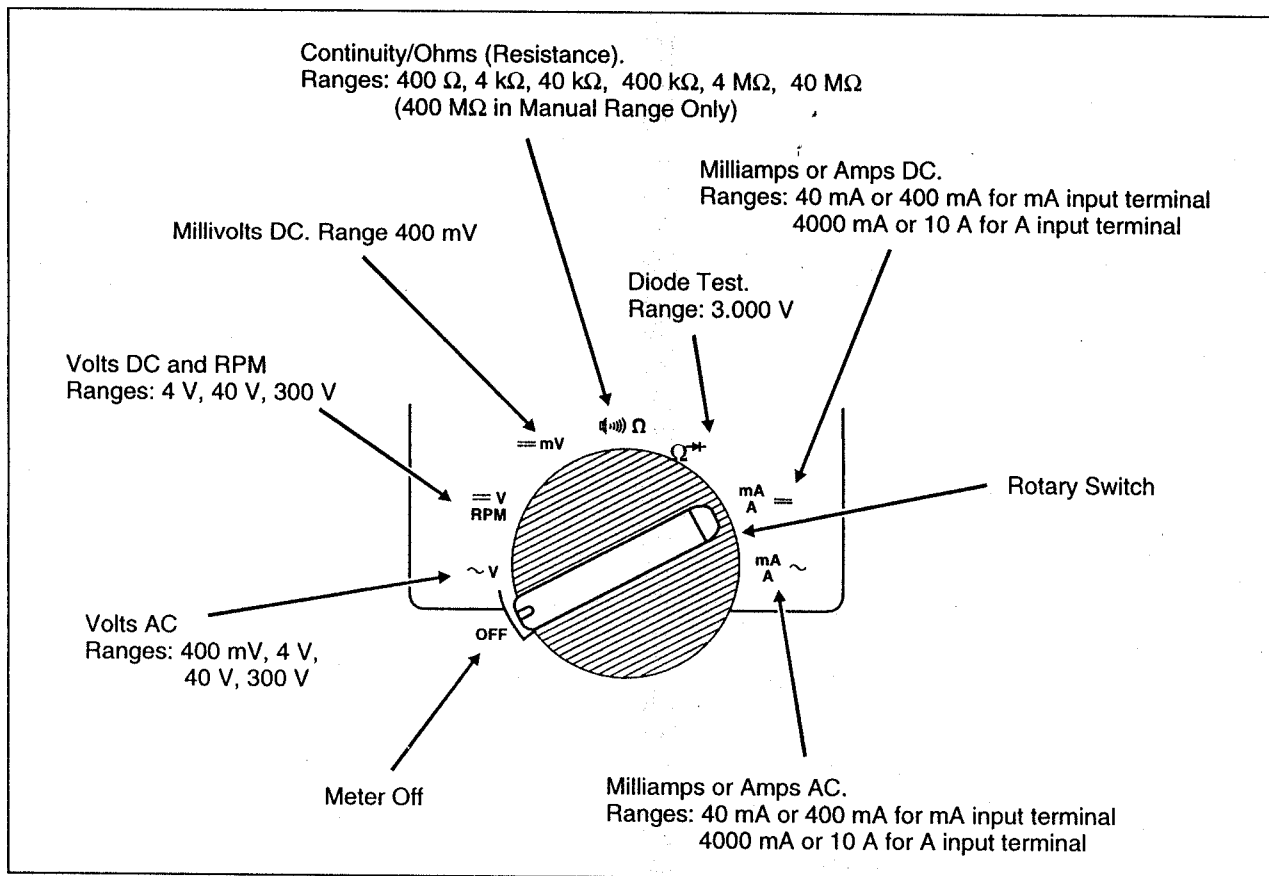

Figure 3. Rotary Switch



**Pushbuttons**

Pushbuttons select the operations shown in Figure 4 and Table 2. When a button is pushed, a display symbol lights, and the beeper sounds (unless all beeper functions have been turned off. [See SELECTING POWER-UP OPTIONS]). Turning the rotary switch to another switch setting resets all pushbuttons to their default state.

Refer to USING PUSHBUTTON FUNCTIONS IN TYPICAL APPLICATIONS later in this manual for examples using the pushbuttons.

**Digital and Analog Displays**

The Meter has a digital and analog display (Figure 5). If the inputs are stable, the digital display offers the more accurate reading; if the inputs are rapidly changing, read the analog pointer. If a measurement is too large to be displayed, OL (overload) is shown on the digital display and the whole analog display lights. In Duty Cycle, OL (overload) is displayed if the input signal stays high or low.

**Display Symbols**

Display symbols indicate what the Meter is doing. (See Figure 5 and Table 1.)

**Turning on the Display Backlight**

Press SMOOTH to toggle the display backlight on and off. The backlight turns off automatically after 68 seconds.

**Table 1. Measurement Unit Symbols**

SYMBOL	MEANING
AC	Alternating current or voltage
DC	Direct current or voltage
V	Volts
mV	Millivolts (1/1000 volts)
A	Ampere (amps). Current
mA	Milliamper (1/1000 amps)
%	Percent (for duty cycle readings only)
$\Omega$	Ohms. Resistance
k $\Omega$	Kilohm (1000 ohms). Resistance
M $\Omega$	Megohm (1,000,000 ohms). Resistance
Hz	Hertz (1 cycle/sec). Frequency
kHz	Kilohertz (1000 cycles/sec). Frequency
RPM 1	Revolutions/minute. Counting one cycle per spark.
RPM 2	Revolutions/minute. Counting 2 cycles per spark
ms	Milliseconds (1/1000 sec) for Pulse Width measurements.

# PUSHBUTTONS

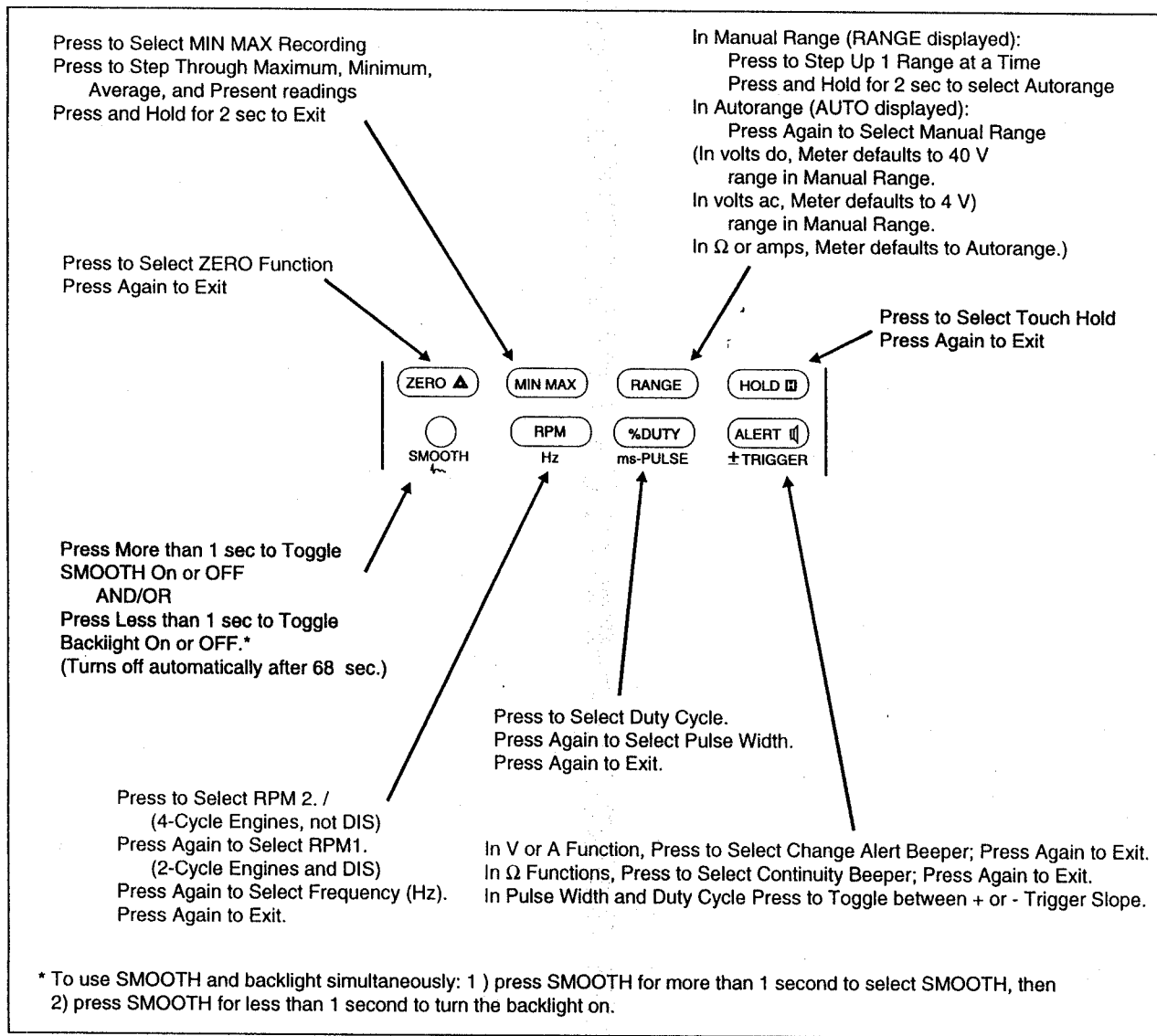















Figure 4. Pushbuttons

Table 2. Pushbutton Operations

PUSHBUTTON	FUNCTION	DISPLAY SYMBOLS
	ZERO (Relative Reading) Function Displays difference between the measured value and the stored value.	
	Minimum (MIN), Maximum (MAX), Average (AVG) Recording. Records minimum, maximum, & calculates true average.	RECORD, MAX, MIN, AVG
	Manual Range or Autorange In Manual Range user selects fixed range. Meter stays in that range until user changes it, selects autorange, or turns Meter off. In Autorange Meter selects range automatically.	RANGE, AUTO
	Touch Hold Touch Hold holds last stable reading on display. A new stable reading, causes beeper to sound and display to update.  If Meter is in MIN MAX Recording, RPM, Duty Cycle, Pulse Width, or Hz, Touch Hold interrupts the function. Display is frozen, but recorded readings are not erased.  Pressing  ,  , or SMOOTH when meter is in Touch Hold causes Meter to exit Touch Hold and enter MIN MAX Recording, change alert, or SMOOTH.	
 Hz	RPM 2, RPM 1, or Frequency RPM 2. 4-cycle engines, not DIS (counts 2 cycles/spark). RPM 1. 2-cycle engines and DIS (counts 1 cycle/spark). Hz counts frequency between 0.5 Hz and 200 kHz.	RPM①, RPM② Hz
 ms-PULSE	Duty Cycle or Pulse Width Duty Cycle between 0.0-99.9% displayed. Pulse Width between 0.002-1999.9 ms displayed.	%, ms
 ±TRIGGER	Change Alert, Continuity Beeper, or ± Trigger  In voltage or current function selects Change Alert. In Ω function selects Continuity Test. In Duty Cycle or Pulse Width selects trigger slope.	 , TRIG, +, -
	SMOOTHING Function and Back-light Display SMOOTH displays average of last eight readings. Press YELLOW button to turn on or off display back-light. (Backlight turns off automatically after 68 sec.)	

# DISPLAY

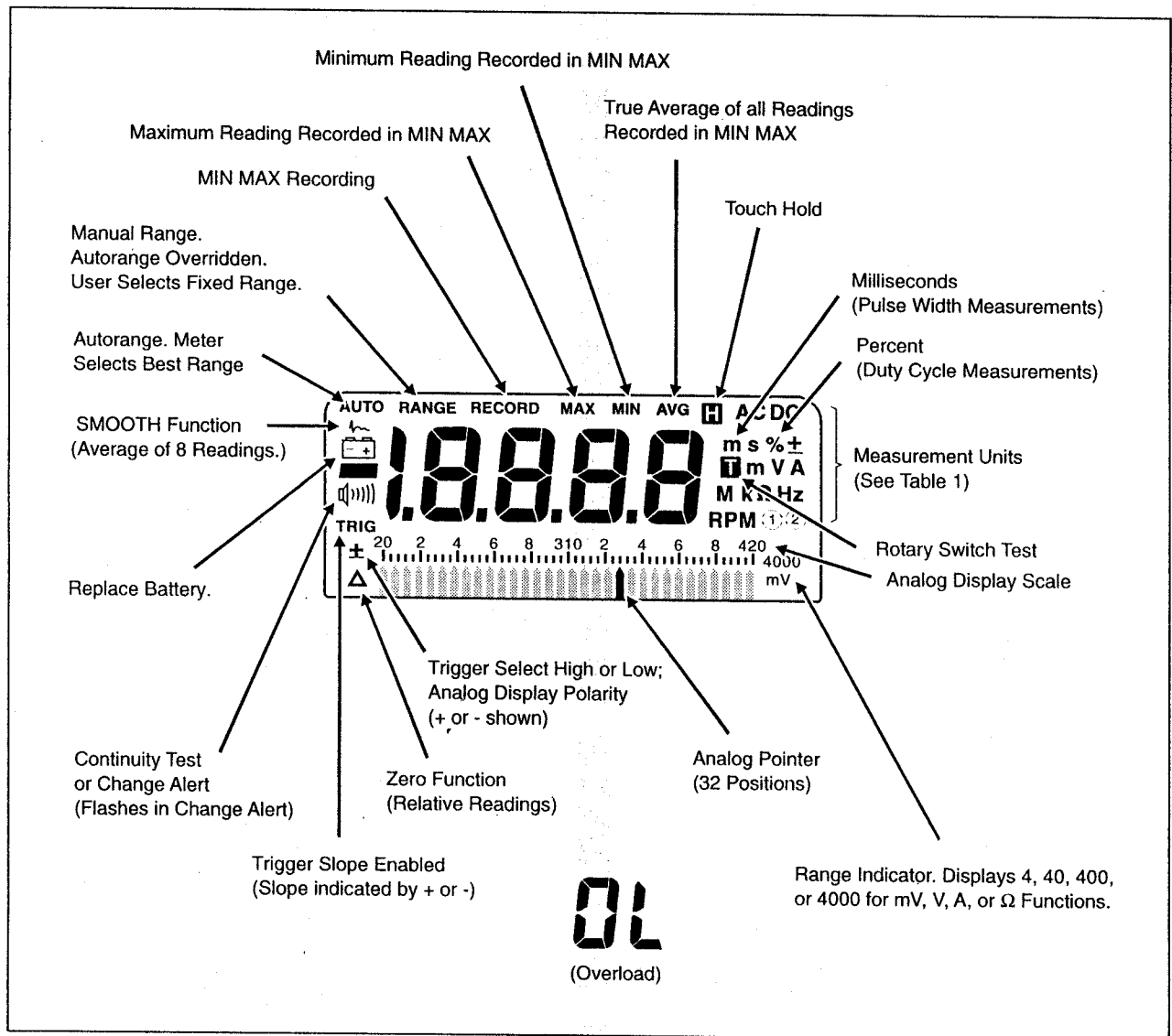

Figure 5. Displays

# AUTOMOTIVE ELECTRICAL SYSTEM TESTS

## HOW TO PERFORM BASIC ELECTRICAL TESTS Automotive Electrical Systems Tests

Table 3 shows some electrical tests that can be performed on common components.

Table 3. Automotive Systems and Electrical Tests

SYSTEM & COMPONENTS	MEASUREMENT TYPES				
	Voltage Presence & Level	Voltage Drop	Current (Amps)	Resistance (Ohms)	Frequency (Hz)
<b>Charging System</b>					
Alternators	•		•		•
Connectors	•	•		•	
Diodes		•		•	
Regulators	•				•
<b>Cooling System</b>					
Connectors	•	•		•	
Fan Motors	•		•	•	
Relays	•	•		•	
Temperature Switches	•	•		•	
<b>Ignition System</b>					
Coils	•			•	
Condensers	•			•	
Connectors	•	•		•	
Contact Set (points)	•			•	
MAF Sensors	•			•	
Magnetic Pick-up	•		•	•	
MAP/BP Sensors	•			•	
O <sub>2</sub> Sensors	•			•	•
<b>Starting System</b>					
Batteries	•	•			
Connectors		•	•		
Interlocks			•		
Solenoids	•	•		•	
Starters	•	•	•		

## **RANGE** RANGING

### **What is a Measurement Range and Why It's Important**

A measurement range determines the highest value the Meter can measure. Most Meter functions have more than one range (see SPECIFICATIONS.)

Being in the right measurement range is important:

- If the range is too low, the display shows OL (overload).
- If the range is too high, the display will not give you the most accurate measurement.

For example, the volts dc function has four ranges (4.000V, 40.00V, 300.00V, and 300V). When you select the volts dc function, the Meter defaults to the 40V range (in Manual Range). If the Meter measured 12.57V, the display shows:

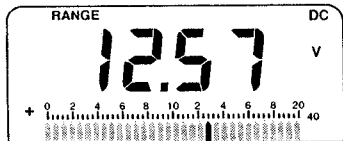

If you press **RANGE** once, you put the Meter in the 300.0V range. Because the 300.0V range is too high for the 12.57V input signal, the Meter drops the last digit and displays the measurement less accurately:



If you press **RANGE** twice more, you wrap to the 4V range. Because the 12.57V input signal is too high for the 4.000V range, the Meter displays overload:

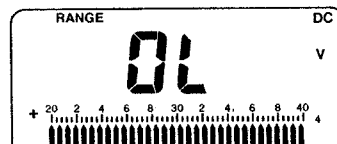

**RANGE Selecting a Measurement Range**

The Meter has Autorange and Manual Range options. When you select the volts dc function, the Meter defaults to the 40V Manual Range. When you select the volts ac function, the Meter defaults to the 4V Manual Range. When you select an  $\Omega$  or amp function, the Meter defaults to Autorange.

- In Autorange (AUTO), the Meter selects the best range. This allows you to switch from one test point to another without having to reset the range.
- In Manual Range (RANGE), you select the range. This allows you to override Autorange. (The Meter stays in the range you select until you change it or return to Autorange.)

**NOTE**

*If you manually change the measurement range after Touch Hold, MIN MAX Recording, and/or ZERO are entered, the Meter exits these functions.*

When in Manual Range, press **RANGE** to step up a range. In the highest range, the Meter wraps to the lowest range.

To switch from Manual Range to Autorange, press and hold down **RANGE** for two seconds.

To switch back to Manual Range, press **RANGE**. The Meter enters Manual Range in the range it is in.

## ~ V, = V, = mV MEASURING VOLTAGE

Voltage is the difference in electrical potential (charge) between two points. Measuring voltage allows you to answer the following questions:

- Is voltage present? The presence of voltage tells you that the circuit is delivering voltage to the component you are testing.
- What is the voltage level? The voltage level tells you whether the proper voltage is arriving at the component.
- What is the voltage drop? The voltage drop tells you how much of the voltage is being consumed by the component.

For example, to measure voltage drop:

1. Insert the red test lead in the **V  $\Omega$   $\rightarrow$**  input terminal, and insert the black test lead in the COM Terminal.
2. Set the rotary switch to a voltage function (mV dc or V ac/dc).

### WARNING

**TO AVOID PERSONAL INJURY OR EQUIPMENT DAMAGE, NEVER ATTEMPT A VOLTAGE MEASUREMENT WITH A TEST LEAD IN THE AMP (A) OR MILLIAMP (MA) INPUT TERMINAL. IF YOU ATTEMPT TO DO SO (AND THE BEEPER IS NOT DISABLED), THE BEEPER EMITS AN INPUT ALERT IN THE FORM OF A CLICKING SOUND.**

3. Touch the probes to the circuit, with the red probe nearer to the voltage source than the black probe. This puts the Meter in parallel with the circuit (see example in Figure 6). *Voltage must always be measured with the Meter in parallel with the circuit.*

Read the voltage. In dc voltage, if you reverse the connections, the display indicates negative polarity with a minus sign [-].

Figure 6 shows how to measure the no-load voltage of a battery.



1. Insert test leads in the input terminals shown.
2. Set switch to volts do.
3. Turn on lights for 1 minute to bleed off surface charge.
4. Turn lights off and touch probes to circuit as shown.
5. Read display. A fully charged battery typically shows about 12.6 V.  
(See other typical values in table below.)

The no-load voltage indicates the state of charge not the condition of the battery. A weak battery may indicate a full terminal voltage when it is not supplying current to some accessory.

Voltage	% Charge
12.60V	100
12.45V	75
12.30V	50
12.15V	25

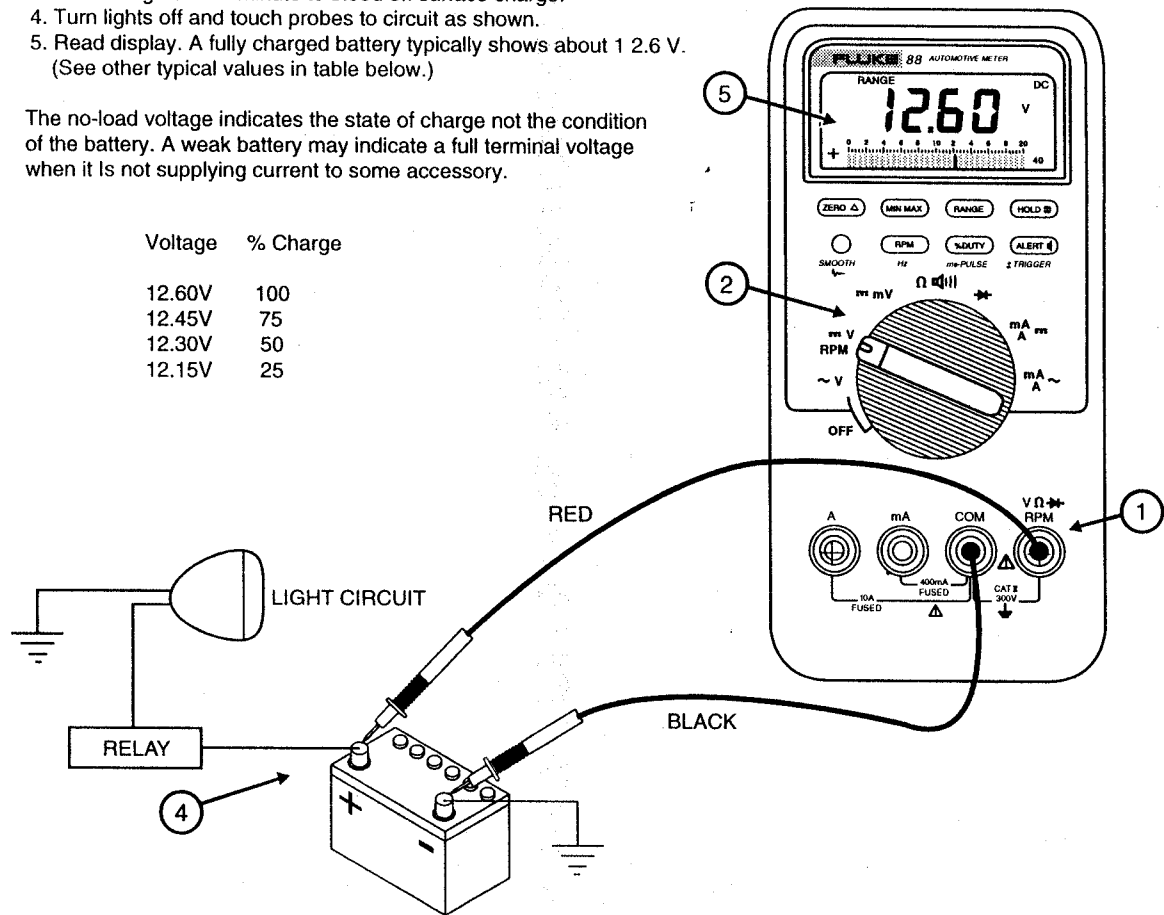

Figure 6. Measuring No-Load Voltage of Battery

## TESTING DIODES

### Caution

To avoid possible damage to the meter or to equipment under test, disconnect the power to the circuit under test and discharge all high voltage capacitors before testing resistance, continuity or diodes.

A good diode allows current to flow in one direction only. To test a single diode, turn the power off, remove the diode from the circuit, and proceed as follows:

1. Insert the red test lead in the  $V \Omega \rightarrow$  input terminal, and insert the black test lead in the COM Terminal.
2. Set the rotary switch to  $\rightarrow$ .
3. Touch the red probe to the positive side of the diode and the black probe to the negative (see Figure 7). Read the display.
4. Reverse the probes and measure the voltage across the diode again.
  - If the diode is good, the display shows OL.
  - If the diode is shorted, the display show 0 in both directions.
  - If display shows OL in both directions, the diode is open.

To perform diode tests using the beeper:

1. Perform steps 1 and 2 in the procedure above, then press  to enter Touch Hold.®
2. Touch the red probe to the positive side of the diode and the black probe to the negative. (The negative side has bands.) Reverse the probes.
  - If the diode is good, the Meter beeps when the probes are in one position and remains silent when they are reversed.
  - If the diode is shorted (or resistance is less than about  $4000\Omega$ ), the Meter beeps in both directions.
  - If a diode is open, the Meter remains silent in both directions.

Figure 7 shows how to check two diodes in series in an alternator.

### NOTE

*The procedure in Figure 7 is not valid for avalanche diodes found in many late model GM cars.*

Band(s) on negative side (cathode)

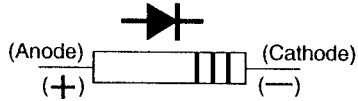

When a diode fails, it usually shorts (although it can sometimes open). Shorted diodes in the alternator can cause a low current output and run the battery dead overnight.

1. Disconnect battery cable from alternator output terminal.
2. Insert the test leads in the input terminals shown.
3. Turn switch to diode test.
4. Touch probes as shown.
5. Read Meter.

If neither diode shorted, about 0.800 V displayed.  
 If one diode shorted, about 0.400 V displayed.  
 If wire open, diode(s) open, or voltage above 3 V, OL is displayed.

If you suspect an open diode, dismantle the alternator and test each diode separately.

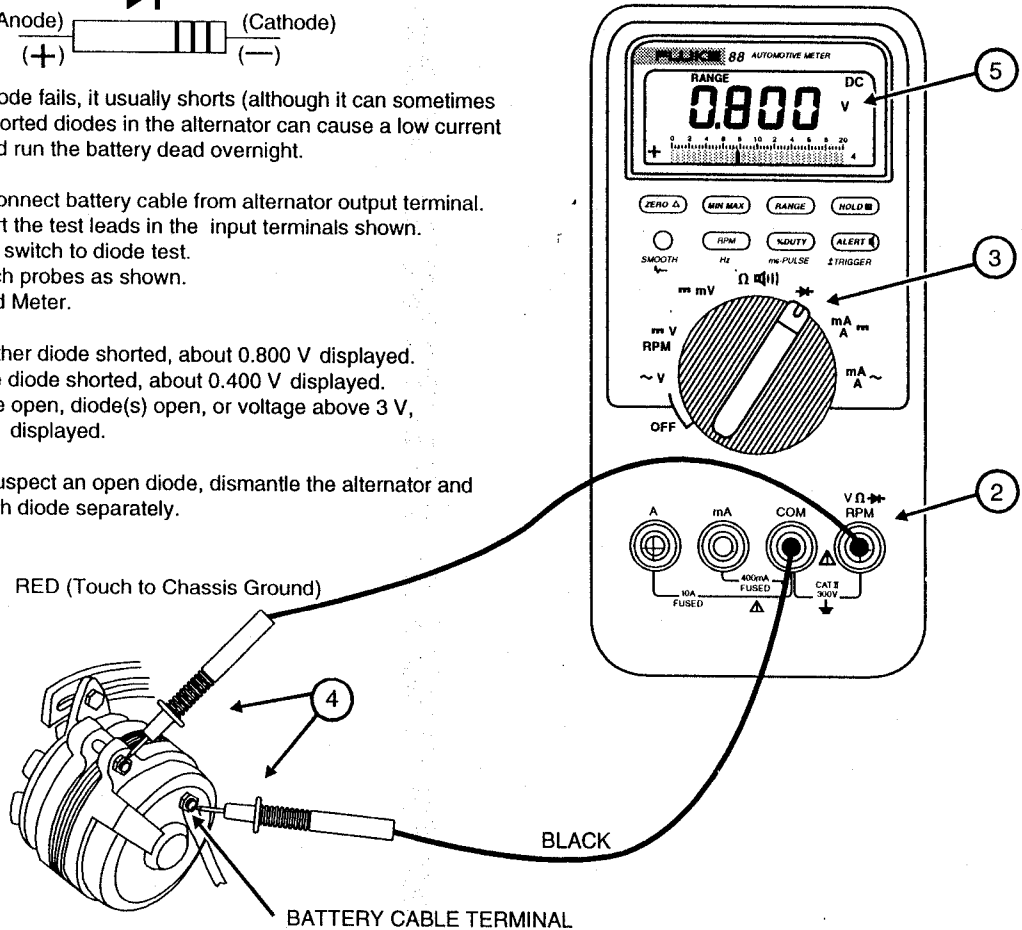

Figure 7. Testing Diodes on Alternator

 **WARNING**

TO AVOID ELECTRIC SHOCK OR PERSONAL INJURY:

- NEVER ATTEMPT AN IN-CIRCUIT CURRENT MEASUREMENT WHERE THE OPEN-CIRCUIT POTENTIAL TO EARTH IS GREATER THAN 300V.
- BEFORE MEASURING CURRENT, CHECK THE METER'S FUSES (SEE "TESTING THE FUSE(S)").
- TURN OFF CIRCUIT POWER BEFORE CONNECTING THE METER IN THE CIRCUIT. REMEMBER TO PLACE THE METER IN SERIES WITH THE CURRENT.
- USE PROPER TERMINALS, FUNCTION AND RANGE FOR YOUR MEASUREMENT.
- ALWAYS USE CLAMP-ON PROBES (DC CURRENT CLAMPS) FOR CIRCUITS OF MORE THAN 10A.

Current is the flow of electrons through a conductor.  
To measure current:

1. Turn off power to the circuit.
2. Disconnect the circuit from the battery or remove the fuse. (A current measurement can be made without breaking the circuit by using a current clamp. Use a current clamp for circuits of more than 10A.)

3. Insert the red test lead in the A or mA input terminal and the black lead in COM.

To avoid blowing the fuse on the Meter's 400 mA input, use the 10A input until you are sure the current draw is less than 400 mA.

4. Set the rotary switch to mA/A (ac or dc). If you set the switch to volts/ac or dc,  $\Omega$  or  $\rightarrow$  (and the beeper has not been disabled), the beeper emits a rapid clicking sound (Input Alert). Do not attempt a measurement until you set the switch to mA/A (ac or dc). You might be injured or damage the Meter.
5. Touch the red probe to the side of the break closest to the power source and the black probe closer to ground. This puts the Meter in series with the circuit being tested, causing all current to flow through the Meter (see Figure 8). *Current must always be measured with the Meter in series with the circuit.*

Figure 8 shows how to measure current to isolate a circuit drain.

**⚠ WARNING**

**TO AVOID ELECTRIC SHOCK OR PERSONAL INJURY, DO NOT ATTEMPT THIS TEST ON A LEAD-ACID BATTERY THAT HAS RECENTLY BEEN RECHARGED.**

**CAUTION**

**Do not crank the engine or operate accessories that draw more than 10 A. You could blow the fuse in the Meter.**

**NOTE**

*Many computers draw 10 mA or more continuously*

1. Insert the test leads in the input terminals shown.
2. Turn switch to mA/A dc.
3. Disconnect battery terminal and touch probes as shown.
4. Isolate circuit causing current drain by pulling out one fuse after another while reading the display.
5. Current reading will drop when the fuse on the bad circuit is pulled.
6. Reinstall fuse and test components (including connectors) of that circuit to find defective component(s)

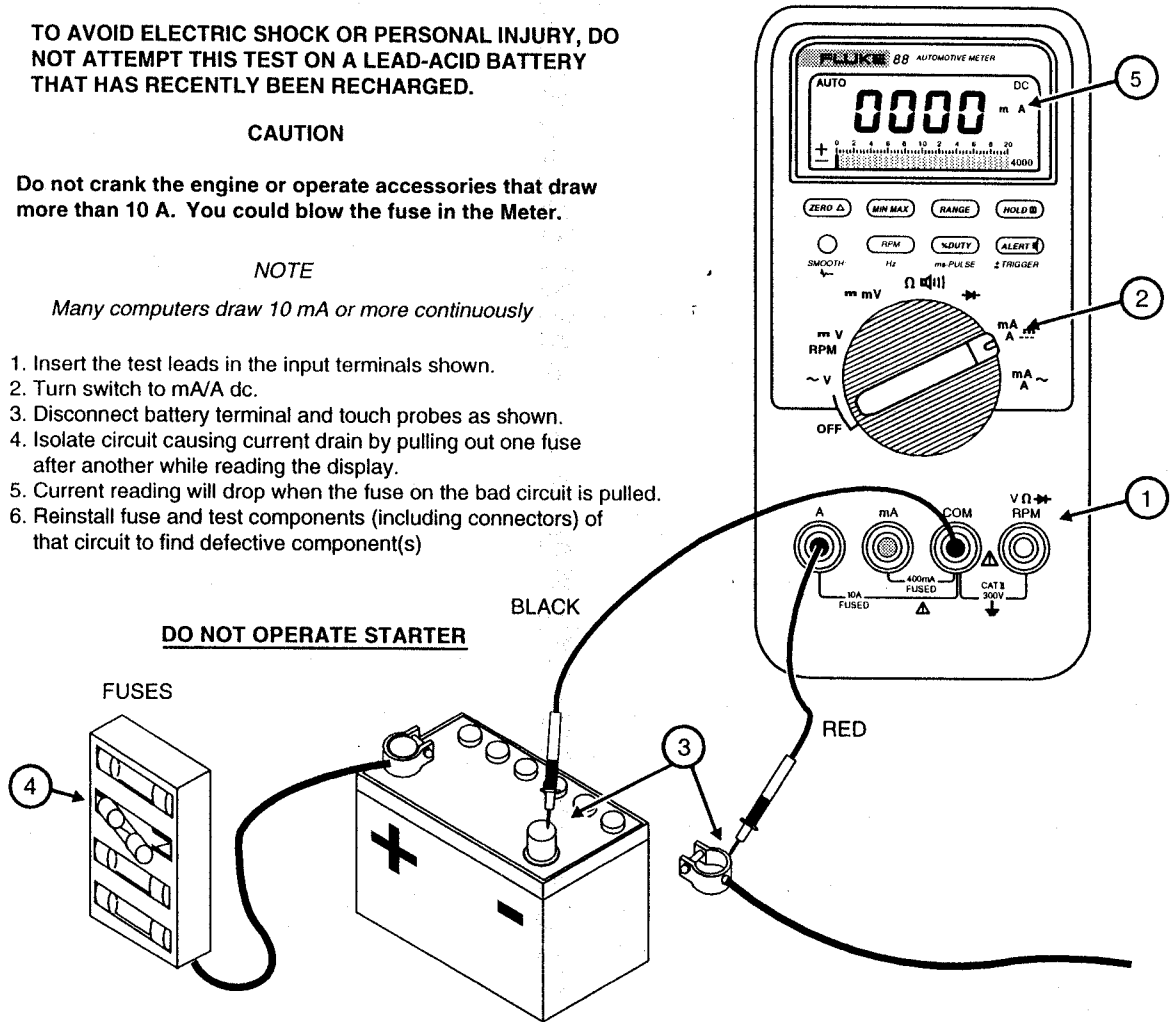

**DO NOT OPERATE STARTER**

**Figure 8. Isolating Circuit Causing Current Drain**

## Ω TESTING CIRCUIT CONTINUITY

### Caution

To avoid possible damage to the meter or to equipment under test, disconnect the power to the circuit under test and discharge all high voltage capacitors before testing resistance, continuity or diodes.

A continuity test verifies that you have a closed circuit. The continuity function detects opens or shorts of as little as 1 millisecond. This can be a valuable troubleshooting aid when looking for intermittents associated with cables, connections, switches, relays, etc.

To check continuity using the beeper:

1. Insert the test leads in the  $V \Omega \rightarrow$  and COM input terminals.
2. Set the rotary switch to  $\Omega$ .
3. Press **ALERT**. The  $\Omega$  symbol appears on the display.

The Meter defaults to the 400 $\Omega$  range (in Manual Range).

4. Touch the probes to the circuit and listen for the beeper. A continuous tone confirms that you have circuit continuity.

### NOTE

A beeper tone does not necessarily mean 0 resistance.

In the 400 $\Omega$  range, resistances of less than 40 $\Omega$  cause the beeper to come on. For other ranges, at resistances below the values listed in Table 4, the Meter always emits a continuous tone.

Figure 9 shows how to use continuity to check a stoplight switch.

Table 4. Beeper Responses in Continuity Test

Input Range	Beeper On @*
400.0 $\Omega$	less than 40 $\Omega$
4.000 k $\Omega$	less than 200 $\Omega$
40.00 k $\Omega$	less than 2 k $\Omega$
400.0 k $\Omega$	less than 20 k $\Omega$
4.000 M $\Omega$	less than 200 k $\Omega$
40.00 M $\Omega$	less than 200 k $\Omega$

\* Below these resistances the beeper will always sound. The beeper can sound at resistances above those indicated.

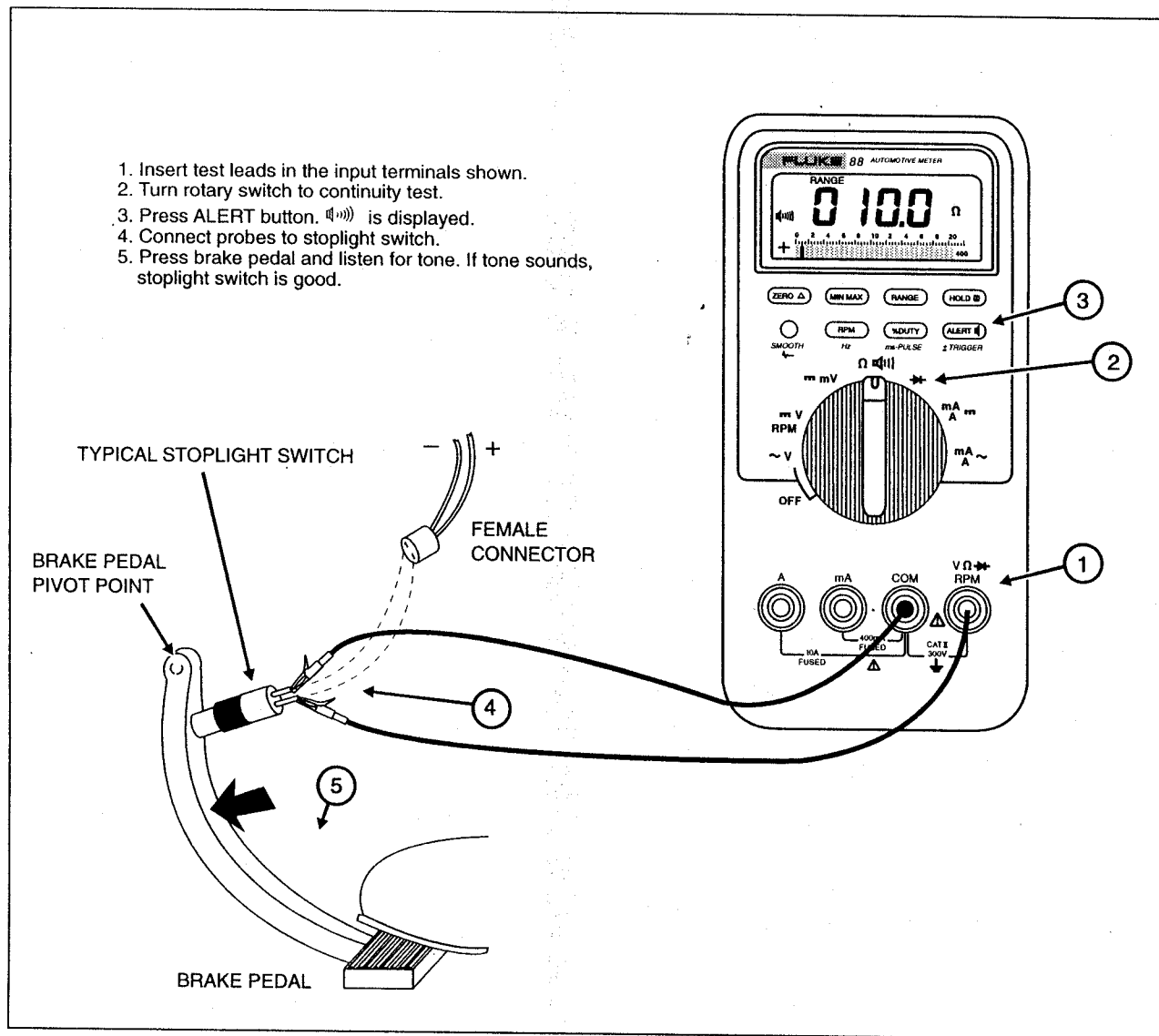

Figure 9. Testing for Continuity in a Switch

## Ω MEASURING RESISTANCE

### Caution

To avoid possible damage to the meter or to equipment under test, disconnect the power to the circuit under test and discharge all high voltage capacitors before testing resistance, continuity or diodes.

Resistance hinders the flow of current. To measure resistance:

1. Turn off power on the test circuit.

If an external voltage is present across a component, it is impossible to take an accurate measurement of the resistance of that component.

2. Insert the test leads into the  $V \Omega \rightarrow$  and COM inputs.
3. Set the rotary switch to  $\Omega$ .

### NOTE

*The Fluke 88 has a Lo Ohms/High Resolution power-up option that allows you to measure resistances as low as  $0.01\Omega$ . To select this feature, press the YELLOW button while turning the rotary switch on to  $\Omega$ .*

4. Touch the test lead probes across the resistance to be measured.
5. Read the resistance.

The resistance displayed is the total resistance through all possible paths between the probes. This is why the resistance of a resistor measured in-circuit often does not correspond to its color code.

### NOTE

*The Meter will not autorange into the  $400.0 M\Omega$  range. This range must be selected manually. (See "Selecting a Measurement Range" earlier in this manual.)*

Resistance in standard test leads is about  $0.1-0.2\Omega$ . The ZERO function can compensate for test lead resistance (see Figure 18).

Rapidly changing display readings (noise) can sometimes be eliminated if you change to a higher range. You can also smooth out noise somewhat by using the averaging (AVG) feature of the MIN MAX Recording function. Press **MIN MAX** to enter MIN MAX Recording. Then press **MIN MAX** three times to step to average (AVG). Refer to "SMOOTHING Rapidly Changing Inputs" later in this manual.

Figure 10 shows how to measure the internal resistance of an ignition coil.



## Ω INTERNAL RESISTANCE OF IGNITION COIL

- NOTES:** 1. When measuring resistance, be sure that the contact between the probes and the circuit is clean. Dirt, oil, paint, rust or other foreign matter seriously affect resistance.  
2. Measure resistance in the primary and secondary coils when the coil is hot and cold.

1. Insert test leads in the input terminals shown.
2. Turn rotary switch to  $\Omega$ .
3. Touch the probes as shown to measure resistance in primary windings.
4. Observe display. Resistance should be less than a few ohms.
5. Touch probes as shown to measure resistance in secondary windings.
6. Observe display. Resistance should typically be in the 10 k $\Omega$  range.

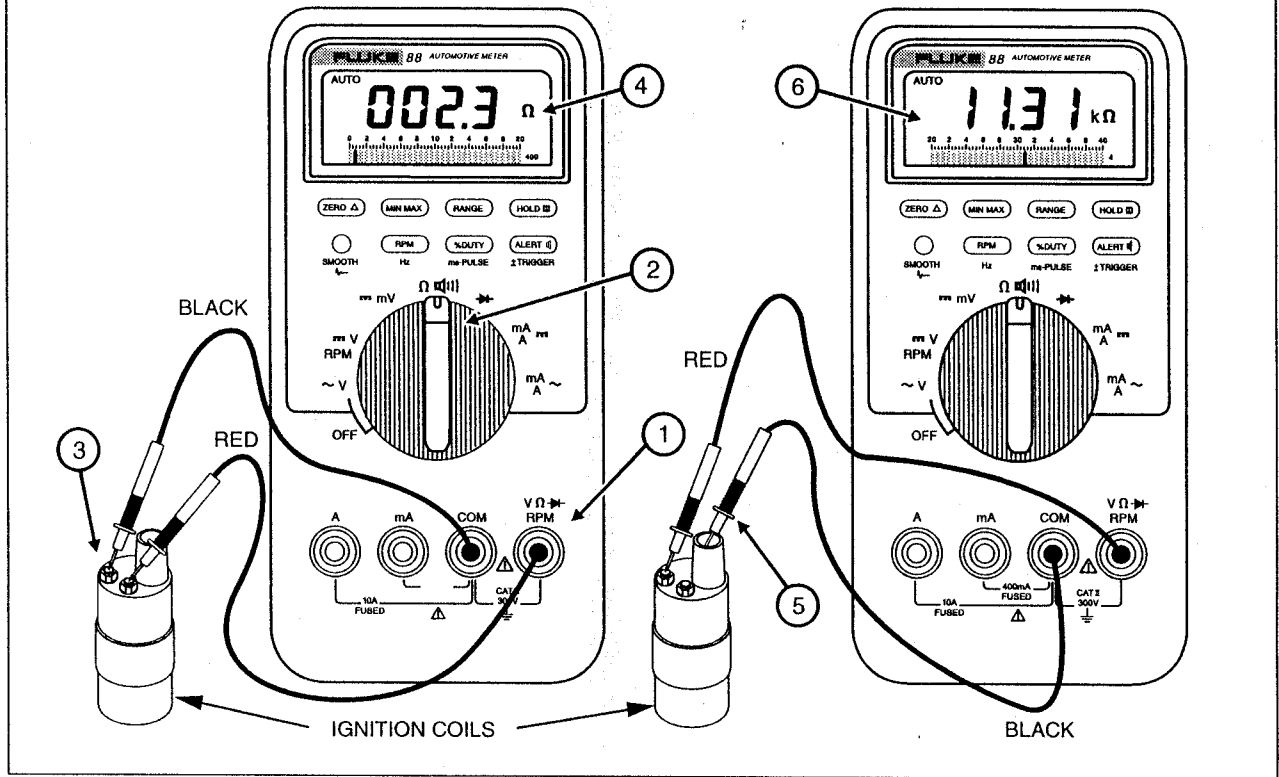

Figure 10. Measuring Internal Resistance of Ignition Coil

## USING PUSHBUTTON FUNCTIONS IN TYPICAL APPLICATIONS

This section uses some typical automotive testing applications to show you how to use the pushbuttons. These applications are intended only to assist you in learning how to use the Meter. Consult your car's service manual for the specific procedure(s) for your car.

### RPM Measuring RPM

Two RPM functions are available:

- Press **RPM** to select RPM 2 for conventional 4-cycle engines (1 count/2 revolutions); RPM (2) appears on the display.
- Press again to select RPM 1 for 2-cycle engines or waste spark 4-cycle engines (1 count/revolution); RPM (1) appears on the display.
- Press again to select the Frequency Mode; Hz appears on the display.
- Press again to exit.

When RPM is first selected, the Meter is in the 4V dc range. (The range is indicated by the number shown at the right end of the analog bar graph.) If the reading is unstable, move to the 40V range by pressing **RANGE** once.

The Meter comes with an Inductive Pickup. The Inductive Pickup takes the magnetic field generated by the current in the spark plug wire and converts it to a pulse that triggers the Meter's RPM measurement. The Meter can also read RPM directly from appropriate signals (like the camshaft position sensor or tach signals) using test leads rather than the inductive pickup.

Figure 11. shows how to measure RPM using the Inductive Pickup.

#### Note

*When RPM measurements are displayed, the last digit on the display might not settle. If you want a more stable display, use the SMOOTHING™ function. In SMOOTH, the last eight measurements are averaged before a value is displayed. Refer to "SMOOTHING Rapidly Changing Inputs" later in this manual.*

### ⚠ WARNING

**TO AVOID PERSONAL INJURY, ENSURE THAT THE ENGINE IS OFF BEFORE CONNECTING OR REMOVING THE PICKUP. THE IGNITION SYSTEM CAN CREATE A POTENTIAL SHOCK HAZARD.**

1. Turn engine off.
2. Connect output plug of Inductive Pickup in the input terminals shown. Make sure the black plug is in COM and the red is in RPM. If your Pickup has a dual banana connector, the plug with the GND (Ground) tab goes in COM.
3. Turn rotary switch to volts dc.
4. For 4-cycle engines that fire once every two revolutions, press RPM once to select RPM(2). For systems that fire every revolution (2-cycle engines), and for waste spark DIS systems, press RPM twice to select RPM(1).
5. Clamp the Inductive Pickup to a plug wire near the spark plug. (Make sure that the jaws are closed completely and the side labeled SPARK PLUG SIDE faces the spark plug).
6. Turn engine on. Read RPM on the display. Turn engine off before removing Pickup.

- NOTES**
1. If meter reading is too high or is unstable, move to the 40 V range by pressing RANGE once.
  2. On some systems with non-resistor plugs, the Pickup may need to be moved away from plug.
  3. On waste spark systems, the Pickup may need to be reversed, depending on what side of the coil the plug is on.

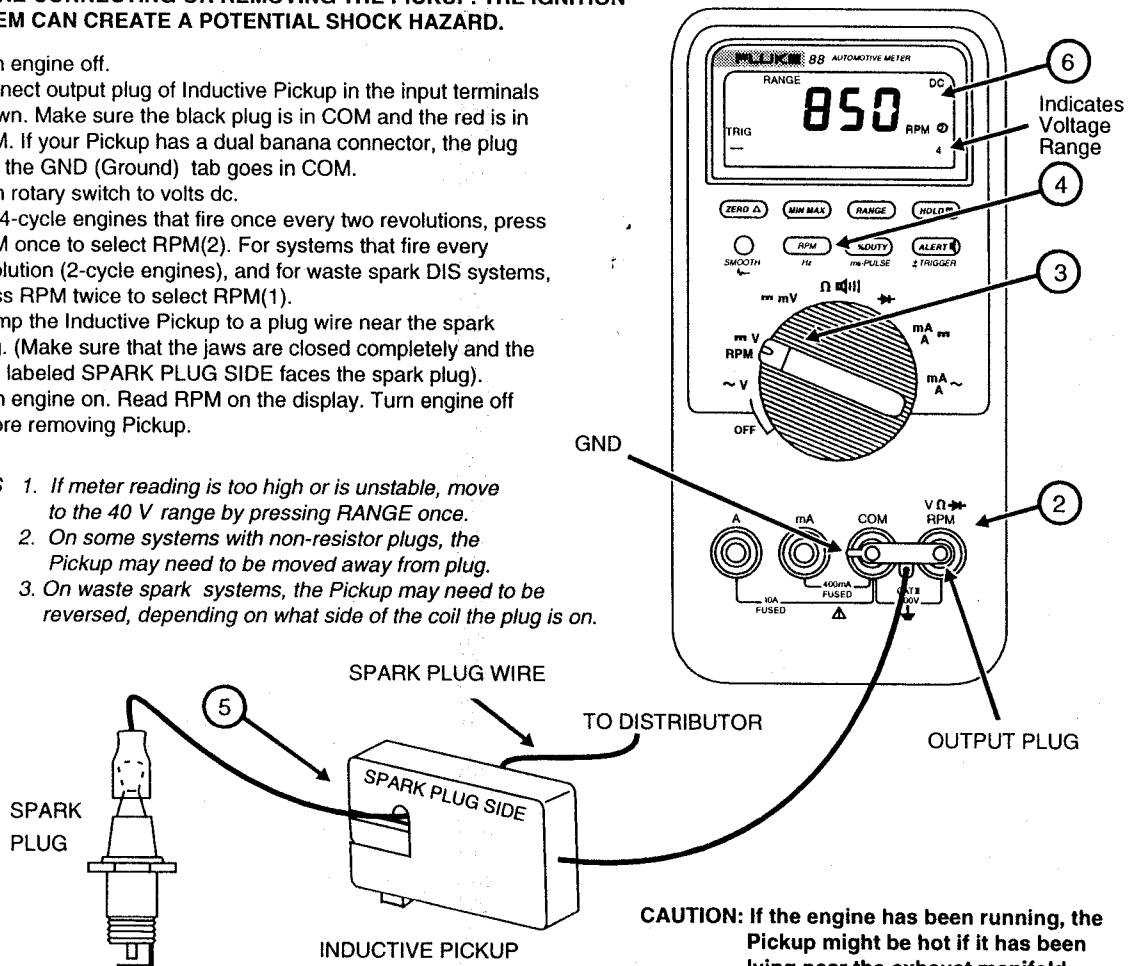

Figure 11. Measuring RPM with Inductive Pickup

### Testing BP/MAP Sensors with Frequency Output

To use the Frequency function to check barometric pressure/manifold absolute pressure (BP/MAP) sensors:

1. Insert the test leads in the input terminals shown in Figure 12.
2. Set the rotary switch to volts dc.
3. Connect the test lead clips to jumper wires.
4. Press **RPM** three times to select frequency.

Hz shows on the display.

Make sure the 4V range is selected. "4" should be showing at the right end of the analog pointer scale.

5. With the ignition KEY ON but the ENGINE OFF (KOEO), pump the vacuum up.

Watch the frequency change on the display. Compare the frequency at various vacuum readings with the specifications in your car's service manual. At 0 inches-of-Hg, frequency should match specification for your altitude.

#### NOTE

*Frequency measurements can be made on voltage (V dc, V ac, or mV dc) or current inputs (mA/A ac or dc). In automotive applications, however, most Frequency measurements will be made using the volts dc function.*

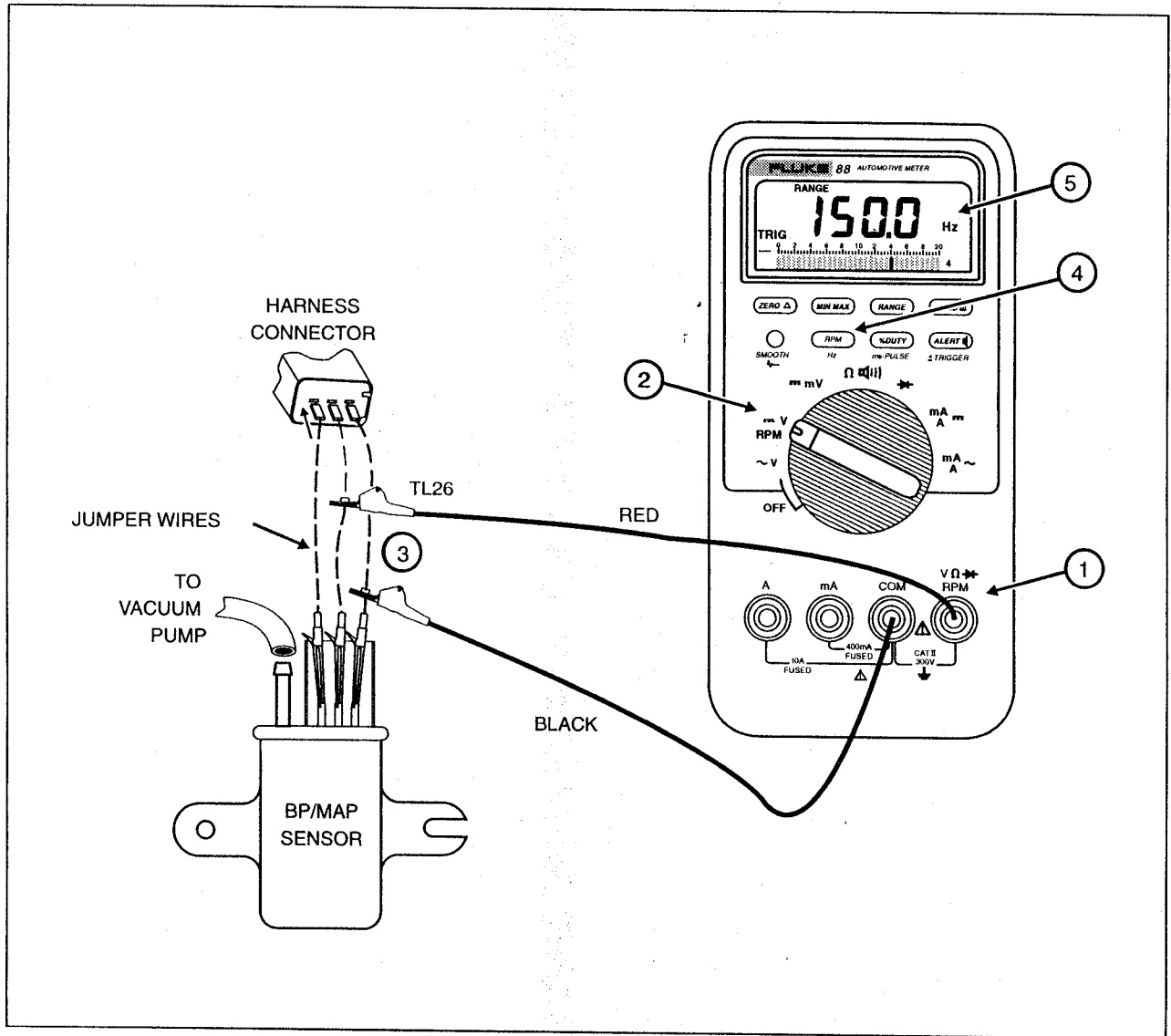

Figure 12. Checking Barometric Pressure/Manifold Absolute Pressure (BP/MAP) Sensors

### Measuring Duty Cycle on a Feedback Carburetor

Duty cycle is the percentage of time (0-99.9%) a voltage is positive versus negative. Most automobiles have the points closed for a duty cycle between 50-70%.

- Press **% DUTY** to select Duty Cycle; % is displayed.
- Press again to select Pulse Width Mode; ms+ or ms- is displayed.
- Press again to exit.

In Duty Cycle (and Pulse Width), press **ALERT** ( $\pm$  TRIGGER) to toggle between a positive or negative trigger slope. The slope is indicated by a + or - sign below TRIG in the lower-left corner of the display.

Dwell is the number of degrees of distributor rotation that the points remain closed. To convert duty cycle to dwell, refer to the Quick Reference Guide or the Duty Cycle to Dwell Conversion Chart in Appendix A. You can also use the formula shown in Figure 13.

To measure duty cycle on a feedback carburetor:

1. Insert test leads in the input terminals shown in Figure 13.
2. Set the rotary switch to volts dc.
3. Connect the test lead clips.
4. Press **% DUTY**. The Meter defaults to - trigger, and the display shows TRIG, -, and %.
5. Turn the car on, and read display when the engine is cold (open loop). Read display when the engine is warm (closed loop).

When the engine is in open loop operation, duty cycle is a steady value (see car's specifications). When the engine warms up and goes into closed loop, the reading should change up and down.

To Convert Duty Cycle To Dwell:

$$\text{Dwell} = \frac{360}{\text{No. of cylinders}} \times \frac{\% \text{ Duty Cycle}}{100\%}$$

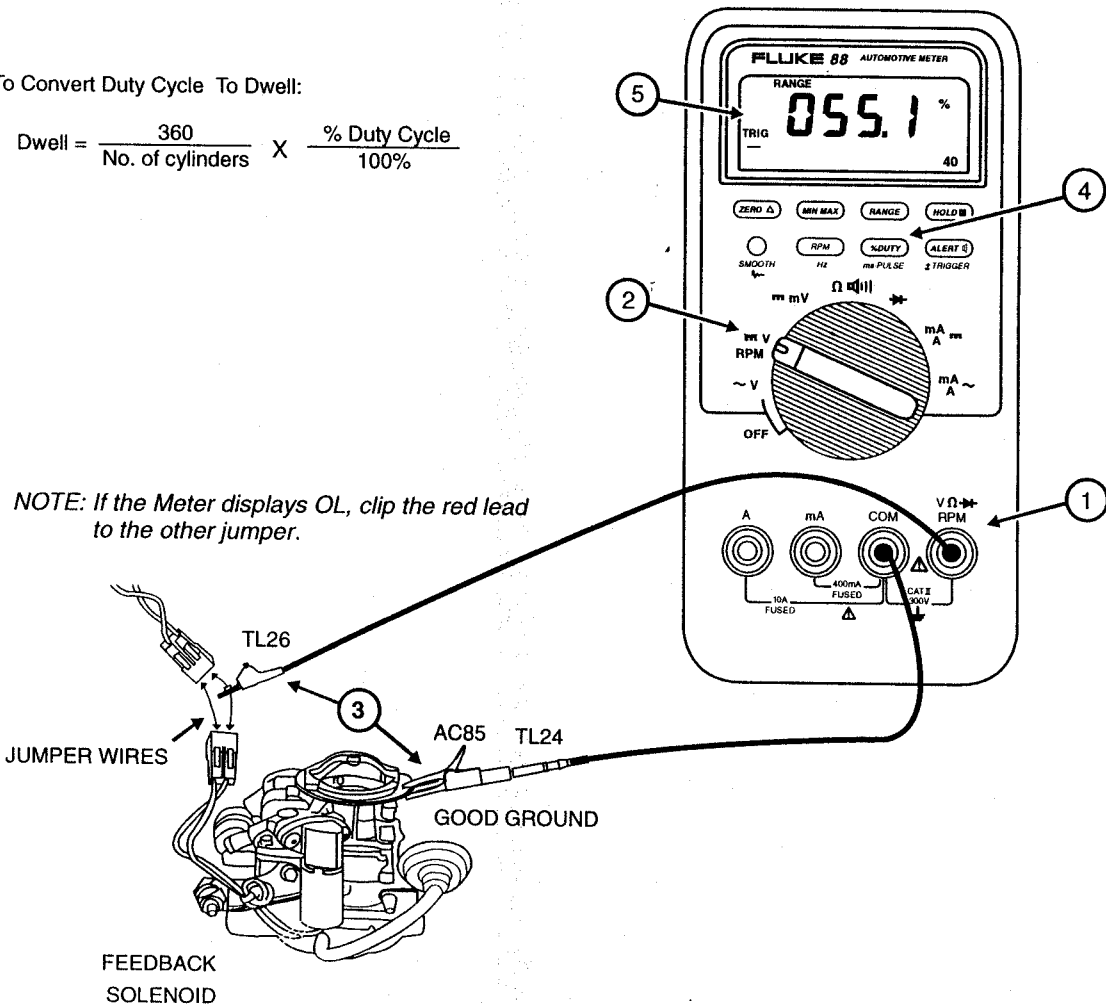

**Figure 13. Measuring Duty Cycle on a Feedback Carburetor**

## **% DUTY (ms-PULSE) MEASURING PULSE WIDTH**

Press **% DUTY** twice to select Pulse Width; ms is displayed.

Press again to exit.

In Pulse Width (and Duty Cycle), the meter defaults to (-) trigger slope; (time signal is low). Press **ALERT** (**± TRIGGER**) to toggle between (**±**) trigger slope. The slope is indicated by the + or - sign below TRIG in the lower-left corner of the display.

To measure pulse width on most port fuel injectors:

1. Insert test leads in the input terminals shown in Figure 14.
2. Set the rotary switch to volts dc.
3. Connect the test leads as shown.
4. Press **% DUTY** twice to select Pulse Width. The display shows ms.
5. Start the engine. Read the display.



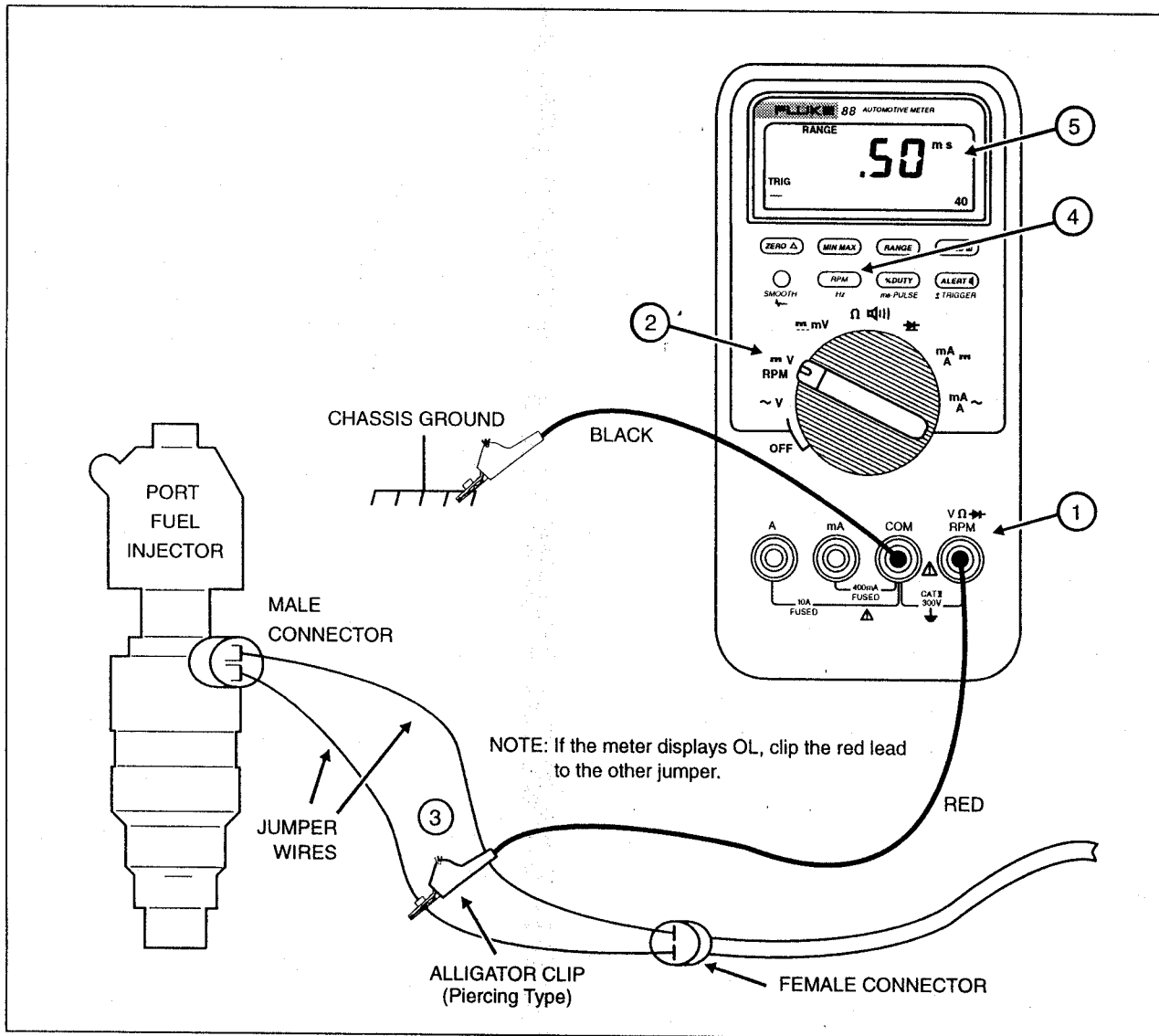

**Figure 14. Measuring Pulse Width on a Port Fuel Injector**

### Measuring Voltages on an O<sub>2</sub> (Lambda) Sensor

MIN MAX Recording stores the lowest and highest measurements, and maintains the average of all measurements. Readings are stored until you turn the Meter OFF or exit MIN MAX Recording. In MIN MAX Recording, Automatic Power-Down (Sleep Mode) and Autorange are turned off. If SMOOTH is selected, the Meter exits MIN MAX Recording and enters SMOOTH.

#### NOTE

*Because Autorange is turned off in MIN MAX Recording, use Manual Range to select the range before selecting MIN MAX Recording. (See "Selecting a Measurement Range" earlier in this manual.) If you manually change the measurement range after MIN MAX Recording is selected, the Meter exits MIN MAX Recording.*

Press **MIN MAX** to select MIN MAX Recording. RECORD and RANGE are displayed, indicating that MIN MAX Recording and Manual Range are selected. The beeper sounds when a new minimum or maximum value is recorded.

After MIN MAX Recording is selected, to see stored readings:

- Press **MIN MAX** to display the maximum reading (MAX).
- Press **MIN MAX** again to display the minimum reading (MIN).
- Press **MIN MAX** again to display the average value (AVG).

Press and hold **MIN MAX** for two seconds to erase stored measurements and exit.

If the Meter is in MIN MAX Recording for more than 35 hours, minimum and maximum readings are still recorded, but new averages are not calculated. The last average calculated is retained as the average reading. If an overload (OL) is recorded, the average value becomes OL.

In MIN MAX Recording, press **HOLD** to interrupt recording (stored readings are not erased); press **HOLD** again to resume recording. When recording is interrupted, the minimum, maximum, average, and present values are locked on the digital display, but the analog display continues to be active.

Figure 15 shows how to use MIN MAX Recording to store minimum, maximum, and average voltages of an O<sub>2</sub> sensor.

Watch analog pointer sweep as O<sub>2</sub> voltage changes. Depending on the driving conditions, the O<sub>2</sub> voltage will rise and fall, but it usually averages around 0.450 V do.

1. Shut the engine off and insert test lead in the input terminals shown.
2. Set the rotary switch to volts dc.
3. Manually select the 4 V range by depressing the range button three times.
4. Connect the test leads as shown.
5. Start the engine. If the O<sub>2</sub> sensor is unheated, fast-idle the car for a few minutes. Then press MIN MAX to select MIN MAX Recording.
6. Press MIN MAX button to display maximum (MAX) O<sub>2</sub> voltage; press again to display minimum (MIN) voltage; press again to display average (AVG) voltage; press and hold down MIN MAX for 2 seconds to exit.

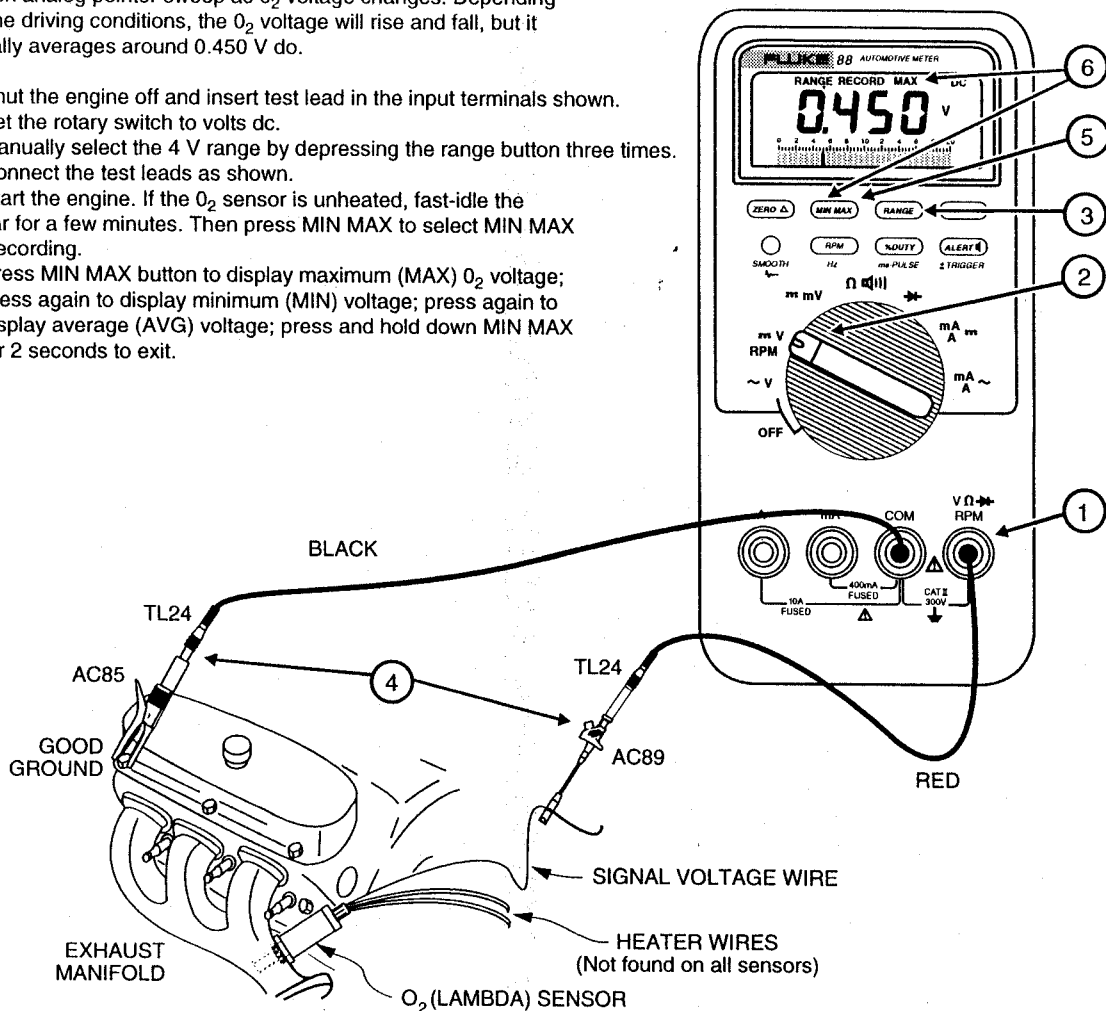

**Figure 15. Measuring Voltages on O<sub>2</sub> Sensor using MIN MAX Recording**

## Measuring Starter Circuit Voltage Drop

### WARNING

TO AVOID ELECTRIC SHOCK OR PERSONAL INJURY, DO NOT USE TOUCH HOLD TO DETERMINE THAT CIRCUITS WITH DANGEROUS VOLTAGES ARE DE-ENERGIZED. TOUCH HOLD WILL NOT CAPTURE UNSTABLE OR NOISY READINGS.

### NOTE

*If you manually change the measurement range after Touch Hold is selected, the Meter exits the Touch Hold function.*

Press **HOLD** to select the Touch Hold Function;  is displayed. Touch Hold operates in two different ways, depending on the function the Meter is in when Touch Hold is selected:

- If you are in MIN MAX Recording, RPM, Duty Cycle, Pulse Width, or Hz when Touch Hold is selected, Touch Hold interrupts the function. The display does not update, but recorded readings are not erased.

Pressing **MIN MAX** or SMOOTH when you are in Touch Hold causes you to exit Touch Hold and enter MIN MAX Recording or SMOOTH, respectively.

### OR

- If you are not in MIN MAX Recording, RPM, Duty Cycle, Pulse Width, or Hz when Touch Hold is selected, the last stable reading is held on the display. When a new, stable reading is detected, the beeper sounds, and the display updates.

This function allows you to take measurements in dangerous or difficult circumstances when you cannot look at the display.

Press **HOLD** again to exit Touch Hold (and resume recording or counting).

Figure 16 shows you how to use Touch Hold to measure voltage drop across components (except solenoids) and connections while you are inside the car cranking the engine.

Since Touch Hold ignores readings of 0, it will retain the voltage drop after you quit cranking.

1. Insert test leads in the input terminals shown.
2. Set the rotary switch to mV dc.
3. Press HOLD to select Touch Hold. **H** is displayed.
4. Touch probes across connection to be measured.
5. Crank engine 4-5 seconds. Meter holds voltage drop to ground on the display.

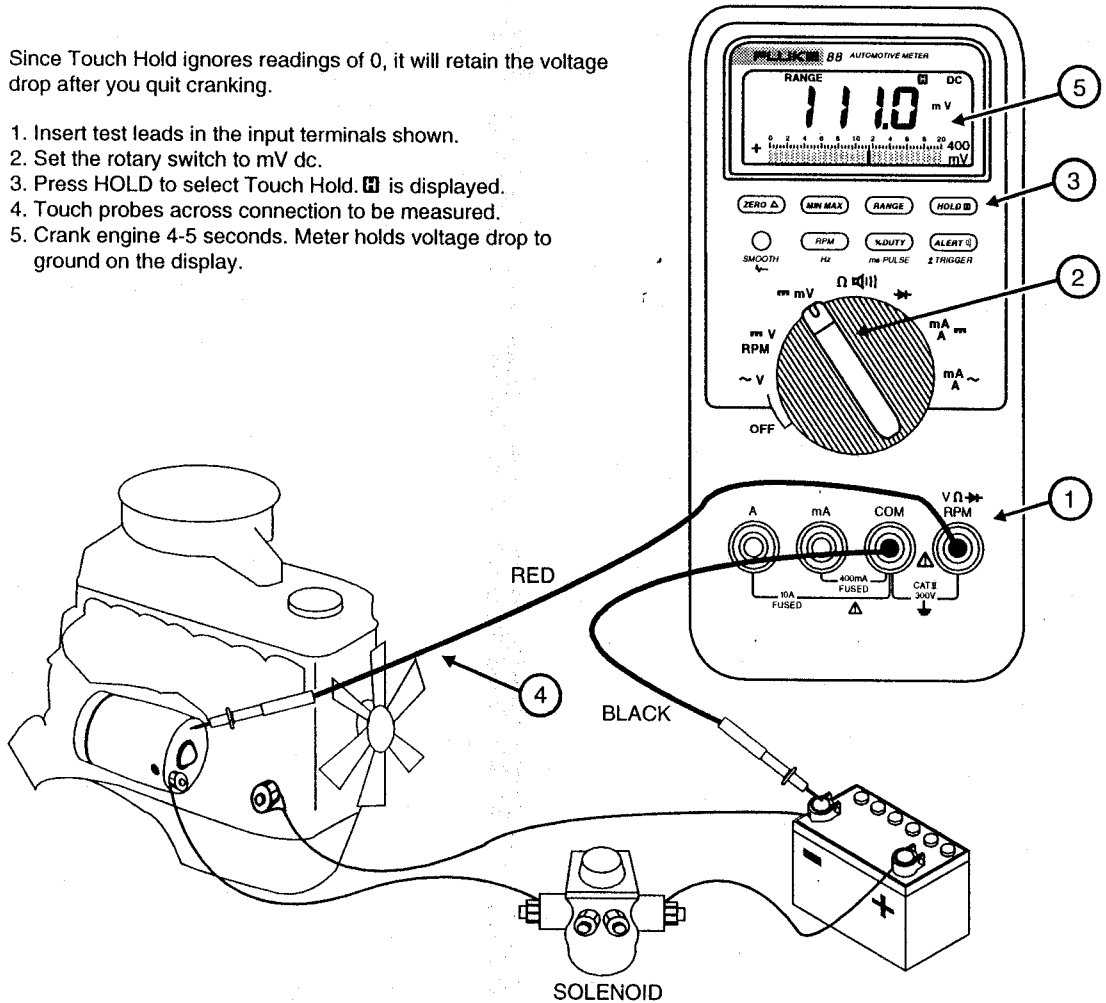

**Figure 16. Measuring Starter Circuit Voltage Drop Using Touch Hold**

## ANALOG POINTER

### Testing a Throttle Position Sensor (Throttle Valve Switch) with Analog Pointer

The analog pointer functions like the needle on an analog meter. Read the analog display when a rapidly changing signal makes the digital display hard to read. For example, the pointer is fast enough to capture contact bounce when relay contacts bounce open (causing intermittent problems).

In most functions, the pointer moves across the scale two times for each range. (If the pointer is too sensitive,

select a higher range.) The pointer turns off in RPM, %Duty Cycle, or ms-Pulse Width.

Examples 1-6 show a reading on the digital display and its equivalent on the analog display. In the 4V range, the first time across the scale, the digital and analog display shows examples 1-3. The second time across the scale, the digital and analog display shows examples 4-6.

Because the pointer excels at displaying trends or slowly changing signals, it can be used to check a throttle position sensor (TPS). See Figure 17.

Example 1



Example 2

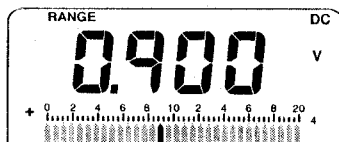

Example 3



Example 4

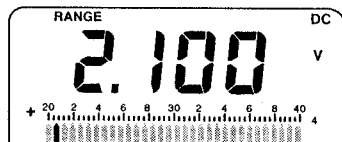

Example 5



Example 6

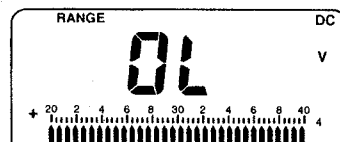

## TESTING THROTTLE POSITION SENSOR WITH ANALOG POINTER

Pull a TPS from stock or use one installed on a car.

1. Insert test leads in the input terminals shown.
2. Set the rotary switch to  $\Omega$
3. Press RANGE to select Manual range. Press RANGE repeatedly to step to 4 k $\Omega$  range.
4. Connect the test leads as shown.
5. Rotate the TPS by moving the throttle.
6. Look at the display and watch the pointer move as the TPS turns.

As you rotate the TPS to change resistance, the pointer moves smoothly if the TPS is good, and moves erratically if it is bad.

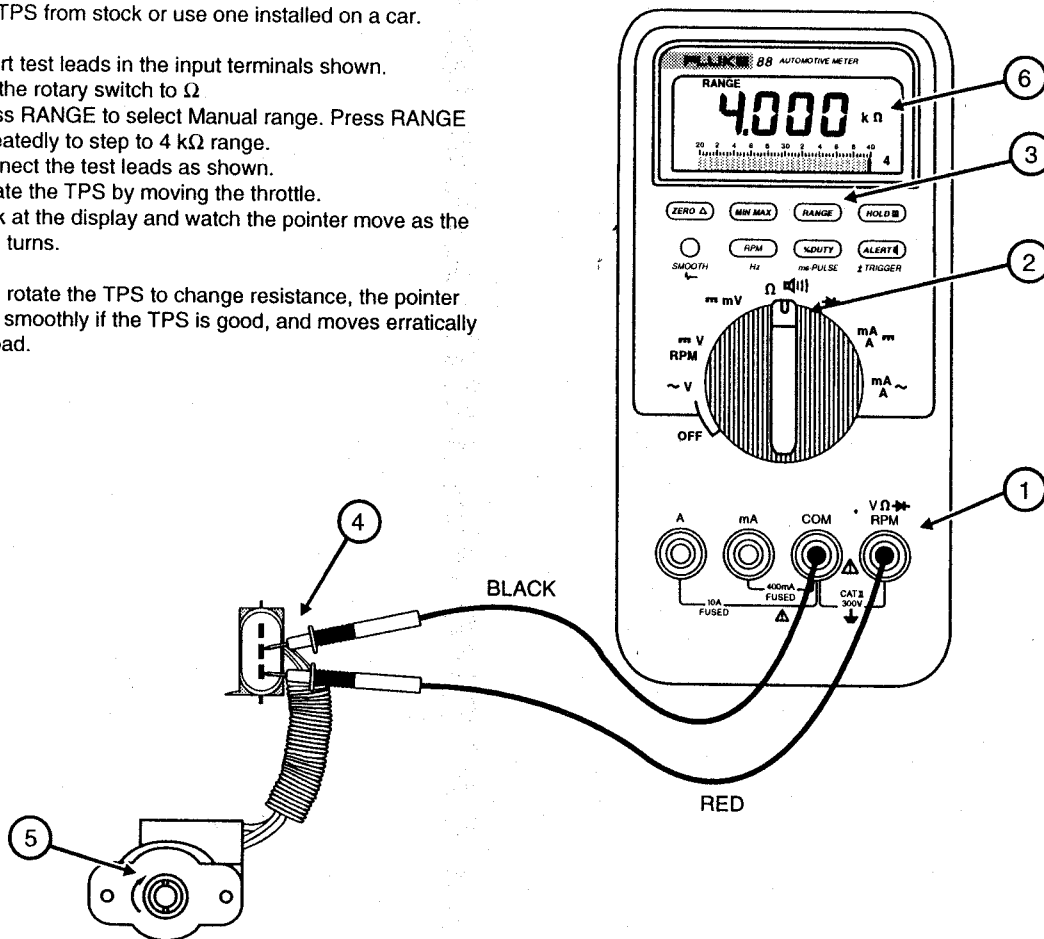

Figure 17. Using Analog Pointer to Observe Sweep of Throttle Position Sensor (TPS)

### Compensating for Test Lead Resistance

The ZERO function subtracts a stored value from the present measurement and displays the result. For example, if the stored measurement is 12.00V and the present measurement is 4.10V, the display shows -07.90V. If the new reading is the same as the stored value, the display shows 0.

#### NOTE

*When you press **ZERO  $\Delta$** , autoranging turns off, and you are locked in the range you are in. Use Manual Range **RANGE** to select the range before selecting ZERO. (See "Selecting a Measurement Range" earlier in this manual.) If you manually change the measurement range after ZERO is selected, the Meter exits the ZERO function.*

- Press **ZERO  $\Delta$**  to select the ZERO function.

The present reading is stored, the display reads 0 and  $\Delta$  is displayed.

- Press again (or change the switch setting) to clear the stored reading and exit the ZERO function.

Autoranging does not automatically resume when you exit the ZERO function. To exit Manual Range, press **RANGE** for more than 2 seconds.

Resistance in standard test leads can diminish the accuracy of resistance measurements by 0.1-0.2 $\Omega$ . The following procedure explains how to use **ZERO  $\Delta$**  to subtract test lead resistance from resistance measurements.

1. Plug the test leads into the input terminals shown in Figure 18.
2. Set the rotary switch to  $\Omega$ .
3. Touch the probes together. The display typically reads 000.1-000.2 $\Omega$ .
4. While the probes are touching, press **ZERO  $\Delta$** .
5. The display shows 000.0 and  $\Delta$ , indicating that ZERO is selected.

When a measurement is taken, the test lead resistance is subtracted from the measurement before it is displayed.



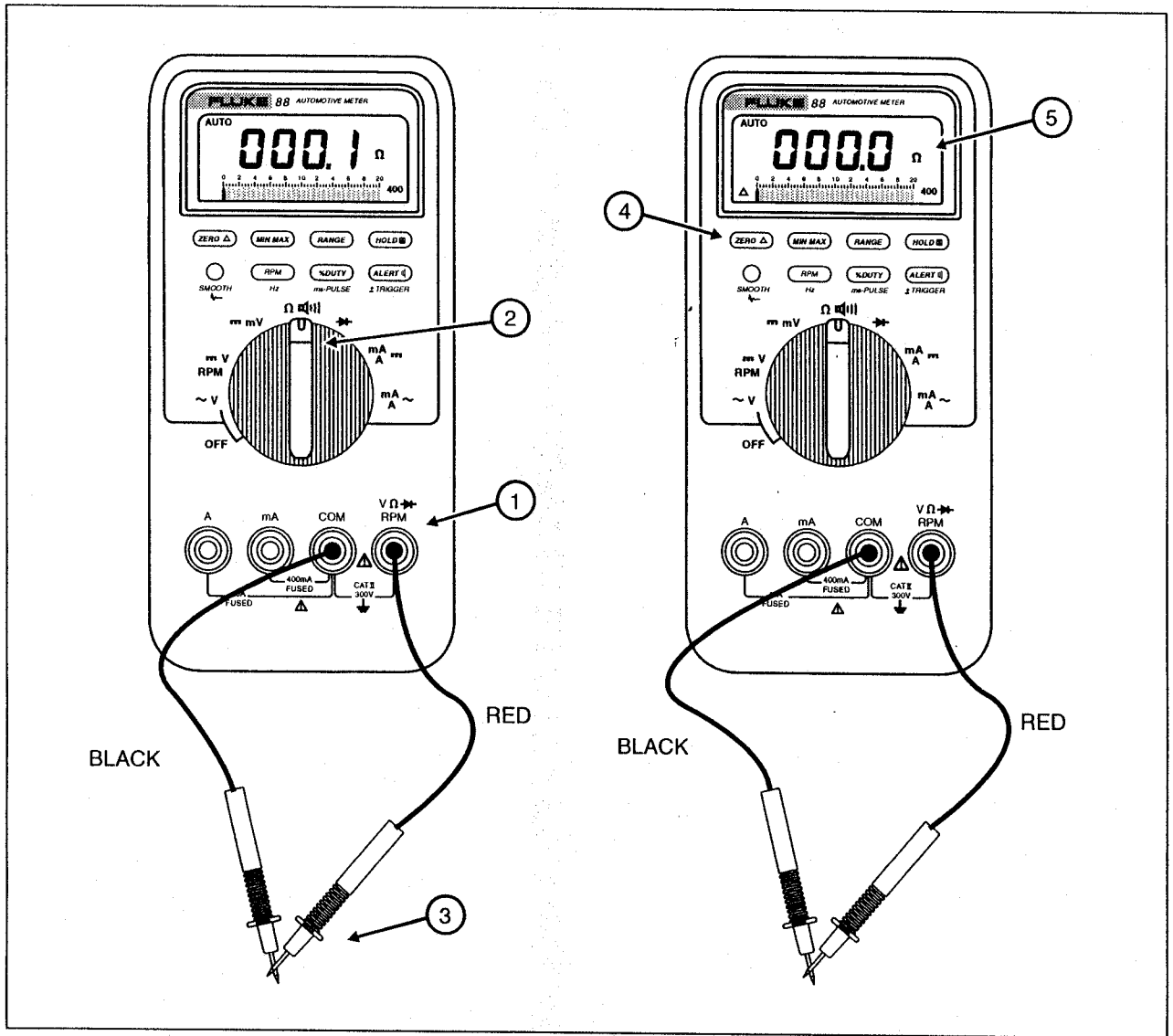

Figure 18. Using ZERO Function to Compensate for Test Lead Resistance



## SMOOTHING RAPIDLY CHANGING INPUTS

In the SMOOTHING function, the digital display shows the average of the last eight measurements, while the analog display continues to show actual measurements. When the input signal changes rapidly, SMOOTH provides a steadier reading on the digital display.

### NOTE

*Selecting SMOOTH while you are in MIN MAX or Touch Hold causes you to exit these functions and enter SMOOTH.*

To select the SMOOTHING function:

1. Set the rotary switch to any function.
2. Press SMOOTH for longer than 1 second.

If you are in the SMOOTHING function and:

- An overload condition is detected, OL is displayed. When the overload condition is removed, the Meter resumes smoothing.
- You press **HOLD III**, the Meter exits SMOOTH and enters Touch Hold. Press **HOLD III** again to exit Touch Hold.
- You press **MIN MAX**, the Meter exits SMOOTH and enters MIN MAX Recording.

3. Press SMOOTH again for longer than 1 second to exit SMOOTH.

### NOTE

*To use SMOOTH and backlight simultaneously, press SMOOTH for more than 1 second to select SMOOTH, then press SMOOTH again to turn the backlight on.*

**ALERT** (± TRIGGER) **Changing the Trigger Slope**

When the Meter is in Duty Cycle or Pulse Width, you can select a + or -trigger slope.

To toggle between a - and + trigger slope:

1. Put the Meter in Duty Cycle, or Pulse Width. TRIG is shown on the display.

The Meter defaults to a - trigger slope.

2. Press **ALERT** (± TRIGGER).

The trigger slope changes. The change in the trigger slope is indicated by the + or - symbol on the display.

**ALERT** **Using Change Alert to Detect Input Signal Change**

The Change Alert™ function causes the beeper to sound when the Meter detects a change in the input

signal. If an overload is detected, OL is displayed, and the beeper sounds until the overload condition is removed.

Use Change Alert when you want to know if the voltage or current changes from what you expect, or when you need to detect intermittent or rapid signal changes. For example, you can use Change Alert if you suspect a problem in a truck-type, trailer plug. Simply set up the Meter to measure volts dc, select Change Alert, touch the probes to the circuit, and wiggle the plug. A tone will sound if a change in the voltage is detected.

To select the Change Alert Function:

1. Set the rotary switch to a voltage or current setting.
2. Press **ALERT** ( ))) flashes.
3. Press again to exit.









## POWER-UP OPTIONS

### SELECTING POWER-UP OPTIONS

Some Meter options can be selected only when you turn the Meter on. These power-up options are listed in Table 5 and on the rear of the Meter. To select

power-up options, press and hold down one or more pushbuttons while turning the rotary switch to any on position. Power-up options remain selected until the Meter is turned off.

Table 5. Power-Up Options

PUSHBUTTON	OPTION DESCRIPTION
	<p>Lo-Ohms/High Resolution.            Selects 4<sup>1</sup>/<sub>2</sub>-digit display. Meter displays measurements at 10 times the resolution. Allows low ohm measurements to .01Ω.</p>
	<p>Disables Automatic Power-Down.            Automatic Power-Off turns the Meter off if neither rotary switch nor pushbutton is activated for 1/2 hour. (Automatic Power-Off is not allowed in the MIN MAX Recording.)            The Meter turns back on if rotary switch is turned or a button is pushed.</p>
	<p>Selects High Accuracy Recording Speed.            Only records changes of more than 1 sec duration. (In RPM, Duty Cycle, and Pulse Width, readings always recorded at 1 reading/sec.)</p>
	<p>Selects Autorange in Volts ac and dc Functions. When volts ac or dc function is selected, the Meter's selects Autorange. Press  to select Manual Range.</p>
	<p>Selects High Input Impedance.            Increases input impedance of mV dc function to about 4000 MΩ.</p>
	<p>Disables All Beeper Functions.</p>
	<p>Rotary Switch Test.  is displayed.            For servicing purposes only. All normal Meter functions are disabled. See 86/88 Service Manual.</p>

**USING THE HOLSTER AND FLEX-STAND**

The Meter comes with a snap-on holster that absorbs shocks and protects the Meter from rough handling.

The holster is equipped with a Flex-Stand™ rest. Some uses of the holster with Flex-Stand are shown in Figure 19.

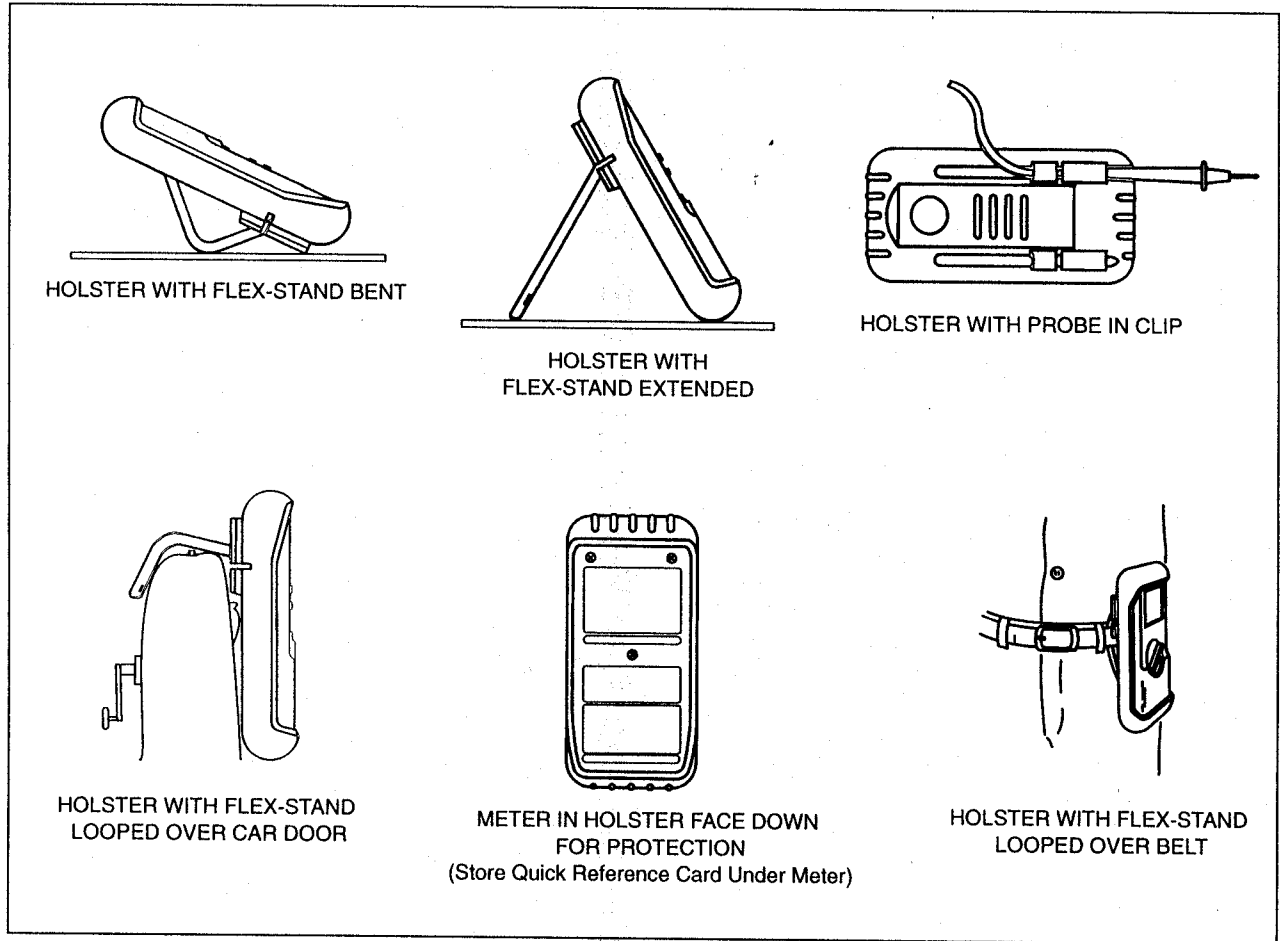

**Figure 19. Holster and Flex-Stand**

## TESTING & REPLACING BATTERY & FUSES

### MAINTENANCE

#### WARNING

TO AVOID ELECTRIC SHOCK OR PERSONAL INJURY,

- DO NOT ALLOW WATER TO GET INSIDE CASE
- REMOVE ANY INPUT SIGNALS PRIOR TO REMOVING TEST LEADS AND OPENING CASE
- USE ONLY SPECIFIED REPLACEMENT PARTS.
- MAKE SURE THE CASE IS CLOSED AND SCREWED TOGETHER BEFORE OPERATING THE METER.

This section provides some basic maintenance procedures. Complete disassembly, reassembly, service, repair, and calibration information is in the 88 Service Manual (P/N 666856).

#### General Maintenance

Periodically wipe the case with a damp cloth and detergent; do not use abrasives or solvents.

Calibrate the Meter once a year to maintain its performance specifications.

#### Replacing the Battery

#### WARNING

TO AVOID FALSE READINGS, WHICH COULD LEAD TO POSSIBLE ELECTRIC SHOCK OR PERSONAL INJURY, REPLACE THE BATTERY AS SOON AS THE BATTERY INDICATOR () APPEARS.

The Meter uses a 9V battery (NEDA 1604, 6F22, or 006P). To replace the battery:

1. Disconnect test leads from any live source, set the rotary switch to OFF, and remove the test leads from the input terminals.
2. The case bottom is secured to the top by three screws and two snaps at the LCD end (see Figure 20). Using a Phillips-head screwdriver, remove the three screws from the case bottom and turn the case over.
3. Lift the end of the case top nearest the input terminals until it gently unsnaps from the case bottom.
4. Lift the battery from the case bottom, and carefully disconnect the battery connector leads.
5. Snap the battery connector leads to the terminals of a new battery and reinsert the battery into the case bottom. Dress the battery leads so that they will not be pinched between the case bottom and case top.
6. Ensure that the rotary switch and circuit board switch are in the OFF position.
7. Replace the case top, ensuring that the gasket is properly seated and the two snaps on the case top (at the end near the LCD) are engaged. Reinstall the three screws.

# TESTING & REPLACING BATTERY & FUSES

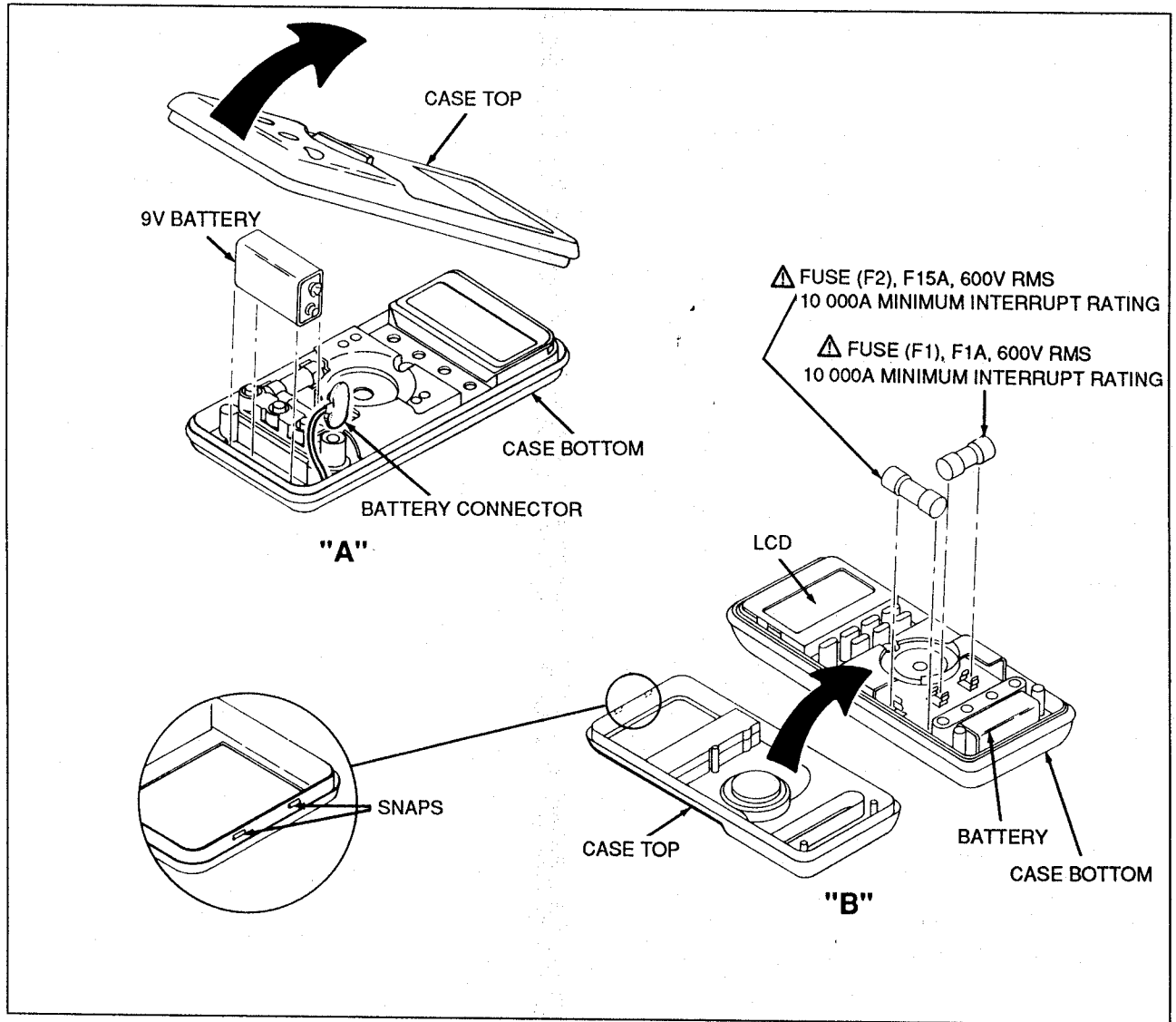

Figure 20. Battery and Fuse Replacement

## TESTING & REPLACING BATTERY & FUSES

### Testing the Fuse(s)

To test the internal fuses of the Meter:

1. Set the rotary switch to  $\Omega$ .
2. To test F2 (15A, 600V), plug a test lead into the  $V \ \Omega \ \rightarrow$  input terminal and touch the probe to the A input terminal. (Because the input terminals contain split contacts, be sure that you touch the probe to the upper half of the input terminal.)

The display should read between 000.0 and 000.5 $\Omega$ . If the display reads OL (overload), replace the fuse and test again. If the display reads any other value, have the Meter serviced.

3. To test F1 (1A, 600V), move the probe from the A input terminal to the mA Input terminal.

The display should indicate between 0.995 k $\Omega$  and 1.005 k $\Omega$ . If the display reads OL (overload), replace the fuse and test again. If the display reads any other value, have the Meter serviced.

### Replacing Fuse(s)



**TO AVOID ELECTRIC SHOCK OR PERSONAL INJURY, INSTALL ONLY SPECIFIED REPLACEMENT FUSES.**

To replace fuses:

1. Perform steps 1 through 3 of the battery replacement procedure.
2. Locate the defective fuse (see Figure 20) and remove it by gently prying loose one end of the fuse and sliding the fuse out of the fuse bracket.
3. Install a new fuse of the same size and rating. Make sure the new fuse is centered in the fuse holder.
4. Ensure that the rotary switch and circuit board switch are in the OFF position.
5. Replace the case top, ensuring that the gasket is properly seated, the battery leads are properly dressed, and the two snaps on the case top (at the end near the LCD) are engaged. Reinstall the three screws.



**Basic Performance Test**

Refer to the 88 Service Manual for complete performance test procedures. To run a basic performance test:

1. Set the rotary switch to  $\Omega$ .
2. Connect a test lead from the  $V \ \Omega \ \rightarrow$  input to the mA input terminal. (If you are using a test probe, touch the top half of the input contact.)

The display should read  $1.000 \text{ k}\Omega \pm 5$  digits.

3. With the rotary switch still at  $\Omega$ , test the A input fuse (15A) by inserting the plug end of the test lead into the A input. The beeper clicks if the fuse is good.
4. Remove the test lead from the A input terminal and insert it in the mA input. The beeper clicks if the mA input fuse (1A) is good.

**If the Meter does not Work**

- Examine the case for physical damage. If damage is detected, contact a Fluke service center or make repairs as described in the 88 Service Manual (PN 666856).
- Check the battery, fuse(s), and test leads and replace as needed.
- Review this manual to make sure you are operating it correctly.

If the Meter still does not work, pack it securely and forward it, postage paid, to the nearest service center. Include a description of the problem. Fluke assumes no responsibility for damage in transit.

A Meter under warranty will be repaired or replaced (at Fluke's option) and returned at no charge. See the registration card for warranty terms. If the warranty has lapsed, the Meter will be repaired and returned for a fixed fee. Contact the nearest service center for information and prices.

## ACCESSORIES AND PARTS

### NOTE

*When servicing the Meter use only the replacement parts specified.*

Accessories and replacement parts are shown in Figure 21 and listed in Table 6. To order replacement parts in the USA, call 1-800-526-4731. To order outside the USA, contact the nearest service center.

**Table 6. Replacement Parts and Accessories**

ITEM	DESCRIPTION	FLUKE PN	QTY
BT 1	Battery, 9V (NEDA 1604, 6F22 or 006P)	614487	1
C81Y	Holster, yellow		1
-	Case, molded carrying	875661	1
F1* $\Delta$	Fuse, F1A, 600V rms	830828	1
F2 $\Delta$	Fuse, F15A, 600V rms	820829	1
H1	Screw, case	832246	3
MP1	Foot, non-skid	824466	2
MP2	O-Ring, input receptacle	831933	1
MP3	RPM Pickup	875307	1
R1	Resistor, Fusible, 1k 2w	832550	1
AC70	Alligator Clips	-	-
AC85	Alligator Clips	-	-
AC89	Insulation Piercing Clip	-	-
TL20	Industrial Test Lead Set	-	-
TL24	Silicone Insulated Test Leads	-	1
TL26	5-Way Multipoint Test Leads	-	1
TL70	Right Angle Test Lead Set	-	1
TP20	Industrial Test Probes	-	-
TM1	Users Manual, Fluke 88 (English)	666842	1
TM 2	Users Manual, Fluke 88 (European)	666849	1
TM4	Service Manual, Fluke 88	666856	
TM5	Quick Reference Guide	880968	1

\* To ensure safety, use Bussman BBS-1 or Fluke Part No. 830828 only.  
 $\Delta$  To ensure safety, use exact replacement part only.

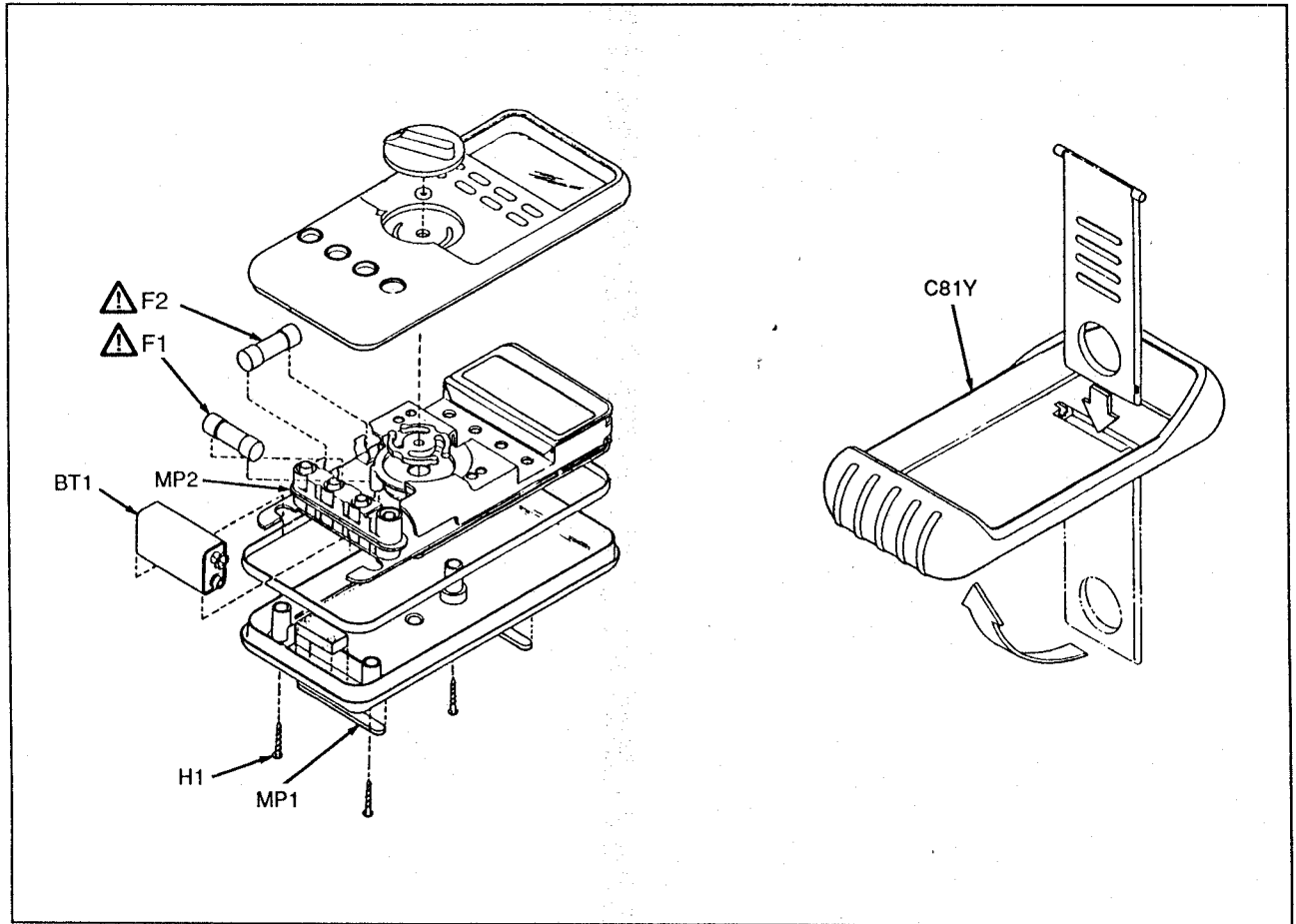

Figure 21. Replacement Parts

## SPECIFICATIONS

Accuracy is specified at 18°C to 28°C (64°F to 82°F) with relative humidity up to 90%, for a period of one year after calibration. AC Conversions are ac-coupled, average responding, and calibrated to the RMS value of a sine wave input.

### Summary of Accuracy Specifications

The table below provides summary accuracy specifications for basic meter functions.

#### Basic Accuracy

FUNCTION	BASIC ACCURACY (±% OF READING)
Volts AC ~ V	1.5%
Volts DC ≡ V	0.15%
Resistance Ω	0.2%
Milliamps/Amps DC (mA ≡)	0.8%
Milliamps/Amps AC (mA ~)	3.0%/1.5%
Frequency Hz	0.01%

#### Complete Accuracy Specifications

The complete Meter specifications follow. In the complete specifications, accuracy is given as:

$\pm([\% \text{ of Reading}] + [\text{Number of Least Significant Digits}])$ .

In the 4 1/2 - digit mode, multiply the number of least significant digits (counts) by 10.

**Input Terminals Limits**

ROTARY SWITCH FUNCTION	RED LEAD	MIN DISPLAY READING	MAX DISPLAY READING	MAXIMUM INPUT**
~V	VΩ↔RPM	0.01 mV	1000V	300V
↔V RPM	VΩ↔RPM	0.0001V	1000V	300V
↔ mV	VΩ↔RPM	0.01 mV	400.0 mV	300V
Ω	VΩ↔RPM	0.01Ω (Lo-ohms)	400.0 MΩ	300V
↔	VΩ↔RPM	0.0001V	3.000V	300V
mA A~	A mA	0.1 mA 0.01 mA	20.00 A* 400.0 mA	10 A/600V* 400 mA/600V
mA A↔	A mA	0.1 mA 0.001 mA	20.00 A* 400.0 mA	10 A/600V* 400 mA/600V

\* 10 A continuous, 20 A overload for 30 seconds maximum.

\*\* 10<sup>7</sup> V-Hz maximum.

**Volts AC ~V** (Input Impedance: 10 MΩ (nominal), <100 pF)

RANGE	RESOLUTION	ACCURACY		COMMON MODE REJECTION RATIO (1 kΩ unbalance)
		45 Hz - 1 kHz	1 kHz - 5 kHz	
400.0 mV	0.1 mV	±(1.5% + 10)	±(1.9% + 10)	>60 dB, dc to 60 Hz
4.000V	0.001V	±(1.5% + 5)	±(1.9% + 5)	>60 dB, dc to 60 Hz
40.00V	0.01V	±(1.5% + 5)	±(1.9% + 5)	>60 dB, dc to 60 Hz
300.0V	0.1V	±(1.5% + 5)	±(1.9% + 5)	>60 dB, dc to 60 Hz
300V	1V	±(2.5% + 5)	±(2.5% + 5)	>60 dB, dc to 60 Hz

\* Below a reading of 200 counts, add 10 digits.

## SPECIFICATIONS

Volts DC = V (Input Impedance: 10 M $\Omega$  (nominal), < 100 pF)

RANGE	RESOLUTION	ACCURACY	COMMON MODE REJECTION RATIO (1 k $\Omega$ unbalance)	NORMAL REJECTION MODE
4.000V	0.001V	$\pm(0.15\% + 2)$	>120 dB at dc, 50 Hz or 60 Hz	>60 dB at 50 Hz or 60 Hz
40.00V	0.01V	$\pm(0.15\% + 2)$	>120 dB at dc, 50 Hz or 60 Hz	>60 dB at 50 Hz or 60 Hz
300.0V	0.1V	$\pm(0.15\% + 2)$	>120 dB at dc, 50 Hz or 60 Hz	>60 dB at 50 Hz or 60 Hz
300V	1V	$\pm(0.3\% + 2)$	>120 dB at dc, 50 Hz or 60 Hz	>60 dB at 50 Hz or 60 Hz

Millivolts DC = mV

RANGE	RESOLUTION	ACCURACY	COMMON MODE REJECTION RATIO (1 k $\Omega$ unbalance)	NORMAL REJECTION MODE
400.0 mV	0.1 mV	$\pm(0.15\% + 2)$	>120 dB at dc, 50 Hz or 60 Hz	>60 dB at 50 Hz or 60 Hz

Resistance  $\Omega$

RANGE	RESOLUTION	ACCURACY*	SHORT CIRCUIT CURRENT
400.0 $\Omega$	0.01 $\Omega$	$\pm(0.2\% + 2)$	700 $\mu$ A
4.000 k $\Omega$	0.001 k $\Omega$	$\pm(0.2\% + 2)$	170 $\mu$ A
40.00 k $\Omega$	0.01 k $\Omega$	$\pm(0.2\% + 2)$	20 $\mu$ A
400.0 k $\Omega$	0.1 k $\Omega$	$\pm(0.2\% + 2)$	2 $\mu$ A
4.000 M $\Omega$	0.001 M $\Omega$	$\pm(0.2\% + 2)$	0.2 $\mu$ A
40.00 M $\Omega$	0.01 M $\Omega$	$\pm(1\% + 3)$	0.2 $\mu$ A
400.0 M $\Omega$ **	0.1 M $\Omega$	$\pm(1\% + 20)$	0.2 $\mu$ A

\*When using Lo-Ohms/High Resolution in combination with Touch Hold, Manual Range must be selected.

\*\*These ranges can be selected only in Manual Range.

**Diode Test**  $\rightarrow$

RANGE	RESOLUTION	ACCURACY	SHORT CIRCUIT CURRENT
3.000V	0.001V	$\pm(2\% + 2)$	1.0 mA typical

**mA/A DC**  $\frac{\text{mA}}{\text{A}}$   $\equiv$

RANGE	RESOLUTION	ACCURACY	BURDEN VOLTAGE (TYPICAL)
40.00 mA	0.01 mA	$\pm(0.8\% + 2)$	2.3 mV/mA
400.0 mA	0.1 mA	$\pm(0.8\% + 2)$	2.3 mV/mA
4000 mA	1 mA	$\pm(0.8\% + 2)$	0.03 V/A
10.00A *	0.01 A	$\pm(1.3\% + 2)$	0.03 V/A

\* 10A continuous, 20A overload for 30 seconds maximum.

**mA/A AC (45 Hz to 2 kHz)**  $\frac{\text{mA}}{\text{A}}$   $\sim$

RANGE	RESOLUTION	ACCURACY**	BURDEN VOLTAGE (TYPICAL)
40.00 mA	0.01 mA	$\pm(3\% + 10)$	2.3 mV/mA
400.0 mA	0.1 mA	$\pm(3\% + 5)$	2.3 mV/mA
4000 mA	1 mA	$\pm(1.5\% + 5)$	0.03 V/A
10.00A *	0.01A	$\pm(1.5\% + 5)$	0.03 V/A

\* 10A continuous, 20A overload for 30 seconds maximum.  
 \*\* Below a reading of 200 counts, add 10 digits.

## SPECIFICATIONS

### Frequency, RPM, Duty Cycle, and Pulse Width

FUNCTION	RANGE	RESOLUTION	ACCURACY	PULSE WIDTH RANGE (ms)#	RESOLUTION (ms)
Frequency*	199.99 Hz	0.01 Hz	$\pm(0.01\% + 1)$	1999.9	0.1
(0.5 Hz to 200 kHz,	1999.9 Hz	0.1 Hz	$\pm(0.01\% + 1)$	5.00	0.01
Pulse Width >2 $\mu$ s)	19.999 kHz	0.001 kHz	$\pm(0.01\% + 1)$	0.500	0.001
	199.99 kHz	0.01 kHz	$\pm(0.01\% + 1)$	0.0500	0.0001
	>200 kHz	0.1 kHz	Unspecified		
RPM 1	30-9,000	1 RPM	$\pm 2$ RPM		
RPM 2	60-12,000	1 RPM	$\pm 2$ RPM		
%Duty Cycle**	0.0-99.9% (0.5 Hz to 200 kHz, Pulse Width > 2 $\mu$ s)				
Pulse Width**	0.002-1999.9 ms (4 Hz to 200 kHz, Pulse Width >2 $\mu$ s)				

# Pulse Width range is determined by the frequency of the signal.  
 \* Frequency measurements can be made on voltage or current inputs. The current inputs are always dc-coupled.  
 \*\* For rise times <1  $\mu$ s. Duty Cycle accuracy:  $\pm(0.2\%$  per kHz + 0.1%).  
 Pulse Width accuracy:  $\pm(0.002$  ms + 3 digits).

### Counter Sensitivity and Trigger Level

INPUT RANGE*	MINIMUM SENSITIVITY @ 0.5 Hz - 200 kHz (RMS SINEWAVE)	APPROXIMATE TRIGGER LEVEL (DC VOLTAGE FUNCTION)
400 mV dc	70 mV (to 400 Hz)	40 mV
400 mV ac	150 mV	-
4.000V	0.7V	1.7V
40.00V	7V	4V
300V	70V ( $\leq 14$ kHz)	40V

\*Maximum Input for Specified Accuracy = 10 x range or 300V



**MIN MAX Recording**

<b>NOMINAL RESPONSE</b>	<b>ACCURACY</b>
100 ms to 80%	Specified accuracy $\pm$ 12 digits for changes > 200 ms in duration.
1 sec	Same as specified accuracy for changes > 2 seconds in duration.

**General**

<b>Maximum Voltage between any Terminal and Earth Ground</b>	300V
<b>Input Impedance</b>	10 M $\Omega$ (nominal), < 100 pF
<b>Fuse Protection</b>	
mA	1A 600V FAST FUSE
A	15A 600V FAST FUSE
<b>Display (LCD)</b>	
Digital	Counts: 4,000 19,999 in High Resolution, 4½-digit Mode only. Update Rate: 1/sec in High Resolution, 4½-digit Mode only. 3/sec in RPM, Frequency, Duty Cycle, and Pulse Width. 4/sec in all other functions and ranges.
Analog	2 x 32 Segments Update Rate: 40/sec
Frequency and RPM	Counts: 19,999 Update Rate: 3/sec @ >10 Hz
Backlight	Backlight turns on for 68 seconds, then turns off automatically if not turned off by user.
<b>Meter Operating Temperature</b>	-20 to 55°C (-4 to 131°F)
<b>Meter Storage Temperature</b>	-40 to 60°C (-40 to 140°F)

## SPECIFICATIONS

<b>Meter Storage Temperature</b>	-40 to 60°C (-40 to 140°F)
<b>Temperature Coefficient</b>	0.05 x (Specified Accuracy)/°C (<18 or >28°C; <64 or >82°F)
<b>Relative Humidity</b>	0% to 90% (0 to 35°C; 32 to 95°F) 0% to 70% (35 to 55°C; 95 to 131°F)
<b>Inductive Pickup</b>	
Input:	Magnetic field from Spark Plug
Output:	Pulse to Trigger
Maximum RPM:	12,000
<b>Electromagnetic Compatibility</b>	In an RF field of 1V/m on all ranges and functions: Total accuracy = Specified Accuracy. Performance above 1 V/m is not specified.
<b>Battery Type</b>	9V, NEDA 1604 or 6F22 or 006P
<b>Battery Life</b>	500 hrs typical with alkaline
<b>Shock, Vibration</b>	Per MIL-T-28800 for a Class 2 Instrument
<b>Size (HxWxL)</b>	
Meter only:	1.25 in x 3.41 in x 7.35 in (3.1 cm x 8.6 cm x 18.6 cm)
With Holster & Flex-Stand:	2.06 in x 3.86 in x 7.93 in (5.2 cm x 9.8 cm x 20.1 cm)
<b>Weight</b>	
Meter only:	12.5 oz (355g)
With Holster & Flex-Stand:	22.0 oz (624g)
<b>Altitude</b>	2000m
<b>Safety</b>	
Meter:	Complies with EN61010-1:1993, ANSI/ISA S82.01-1994, CAN/CSA 22.2 No. 1010.1:1992 Overvoltage Category II/300 volts. UL License, TUV License, CSA License.
Pickup:	Specified for spark-plug wire use only.

**APPENDIX A. DUTY CYCLE TO DWELL CONVERSION CHART**

DUTY CYCLE (%)	DWELL (NO. OF CYLINDERS)				
	3	4	5	6	8
0	0.0	0.0	0.0	0.0	0.0
1	1.2	0.9	0.7	0.6	0.5
2	2.4	1.8	1.4	1.2	0.9
3	3.6	2.7	2.2	1.8	1.4
4	4.8	3.6	2.9	2.4	1.8
5	6.0	4.5	3.6	3.0	2.3
6	7.2	5.4	4.3	3.6	2.7
7	8.4	6.3	5.0	4.2	3.2
8	9.6	7.2	5.8	4.8	3.6
9	10.8	8.1	6.5	5.4	4.1
10	12.0	9.0	7.2	6.0	4.5
11	13.2	9.9	7.9	6.6	5.0
12	14.4	10.8	8.6	7.2	5.4
13	15.6	11.7	9.4	7.8	5.9
14	16.8	12.6	10.1	8.4	6.3
15	18.0	13.5	10.8	9.0	6.8
16	19.2	14.4	11.5	9.6	7.2
17	20.4	15.3	12.2	10.2	7.7
18	21.6	16.2	13.0	10.8	8.1
19	22.8	17.1	13.7	11.4	8.6
20	24.0	18.0	14.4	12.0	9.0
21	25.2	18.9	15.1	12.6	9.5
22	26.4	19.8	15.8	13.2	9.9
23	27.6	20.7	16.6	13.8	10.4
24	28.8	21.6	17.3	14.4	10.8
25	30.0	22.5	18.0	15.0	11.3
26	31.2	23.4	18.7	15.6	11.7
27	32.4	24.3	19.4	16.2	12.2
28	33.6	25.2	20.2	16.8	12.6
29	34.8	26.1	20.9	17.4	13.1
30	36.0	27.0	21.6	18.0	13.5
31	37.2	27.9	22.3	18.6	14.0
32	38.4	28.8	23.0	19.2	14.4
33	39.6	29.7	23.8	19.8	14.9

DUTY CYCLE (%)	DWELL (NO. OF CYLINDERS)				
	3	4	5	6	8
34	40.8	30.6	24.5	20.4	15.3
35	42.0	31.5	25.2	21.0	15.8
36	43.2	32.4	25.9	21.6	16.2
37	44.4	33.3	26.6	22.2	16.7
38	45.6	34.2	27.4	22.8	17.1
39	46.8	35.1	28.1	23.4	17.6
40	48.0	36.0	28.8	24.0	18.0
41	49.2	36.9	29.5	24.6	18.5
42	50.4	37.8	30.2	25.2	18.9
43	51.6	38.7	31.0	25.8	19.4
44	52.8	39.6	31.7	26.4	19.8
45	54.0	40.5	32.4	27.0	20.3
46	55.2	41.4	33.1	27.6	20.7
47	56.4	42.3	33.8	28.2	21.2
48	57.6	43.2	34.6	28.8	21.6
49	58.8	44.1	35.3	29.4	22.1
50	60.0	45.0	36.0	30.0	22.5
51	61.2	45.9	36.7	30.6	23.0
52	62.4	46.8	37.4	31.2	23.4
53	63.6	47.7	38.2	31.8	23.9
54	64.8	48.6	38.9	32.4	24.3
55	66.0	49.5	39.6	33.0	24.8
56	67.2	50.4	40.3	33.6	25.2
57	68.4	51.3	41.0	34.2	25.7
58	69.6	52.2	41.8	34.8	26.1
59	70.8	53.1	42.5	35.4	26.6
60	72.0	54.0	43.2	36.0	27.0
61	73.2	54.9	43.9	36.6	27.5
62	74.4	55.8	44.6	37.2	27.9
63	75.6	56.7	45.4	37.8	28.4
64	76.8	57.6	46.1	38.4	28.8
65	78.0	58.5	46.8	39.0	29.3
66	79.2	59.4	47.5	39.6	29.7
67	80.4	60.3	48.2	40.2	30.2

## DUTY CYCLE TO DWELL CONVERSION

DUTY CYCLE (%)	DWELL (NO. OF CYLINDERS)				
	3	4	5	6	8
68	81.6	61.2	49.0	40.8	30.6
69	82.8	62.1	49.7	41.4	31.1
70	84.0	63.0	50.4	42.0	31.5
71	85.2	63.9	51.1	42.6	32.0
72	86.4	64.8	51.8	43.2	32.4
73	87.6	65.7	52.6	43.8	32.9
74	88.8	66.6	53.3	44.4	33.3
75	90.0	67.5	54.0	45.0	33.8
76	91.2	68.4	54.7	45.6	34.2
77	92.4	69.3	55.4	46.2	34.7
78	93.6	70.2	56.2	46.8	35.1
79	94.8	71.1	56.9	47.4	35.6
80	96.0	72.0	57.6	48.0	36.0
81	97.2	72.9	58.3	48.6	36.5
82	98.4	73.8	59.0	49.2	36.9
83	99.6	74.7	59.8	49.8	37.4
84	100.8	75.6	60.5	50.4	37.8
85	102.0	76.5	61.2	51.0	38.3
86	103.2	77.4	61.9	51.6	38.7
87	104.4	78.3	62.6	52.2	39.2
88	105.6	79.2	63.4	52.8	39.6
89	106.8	80.1	64.1	53.4	40.1
90	108.0	81.0	64.8	54.0	40.5
91	109.2	81.9	65.5	54.6	41.0
92	110.4	82.8	66.2	55.2	41.4
93	111.6	83.7	67.0	55.8	41.9
94	112.8	84.6	67.7	56.4	42.3
95	114.0	85.5	68.4	57.0	42.8
96	115.2	86.4	69.1	57.6	43.2
97	116.4	87.3	69.8	58.2	43.7
98	117.6	88.2	70.6	58.8	44.1
99	118.8	89.1	71.3	59.4	44.6

