

Tequipment
.NET



205 Westwood Ave
Long Branch, NJ 07740
1-877-742-TEST (8378)
Fax: (732) 222-7088
salesteam@Tequipment.NET

FLUKE®

80 Series V

Digital Multimeter

Calibration Manual

Lifetime Limited Warranty

Each Fluke 20, 70, 80, 170 and 180 Series DMM will be free from defects in material and workmanship for its lifetime. As used herein, "lifetime" is defined as seven years after Fluke discontinues manufacturing the product, but the warranty period shall be at least ten years from the date of purchase. This warranty does not cover fuses, disposable batteries, damage from neglect, misuse, contamination, alteration, accident or abnormal conditions of operation or handling, including failures caused by use outside of the product's specifications, or normal wear and tear of mechanical components. This warranty covers the original purchaser only and is not transferable.

For ten years from the date of purchase, this warranty also covers the LCD. Thereafter, for the lifetime of the DMM, Fluke will replace the LCD for a fee based on then current component acquisition costs.

To establish original ownership and prove date of purchase, please complete and return the registration card accompanying the product, or register your product on <http://www.fluke.com>. Fluke will, at its option, repair at no charge, replace or refund the purchase price of a defective product purchased through a Fluke authorized sales outlet and at the applicable international price. Fluke reserves the right to charge for importation costs of repair/replacement parts if the product purchased in one country is sent for repair elsewhere.

If the product is defective, contact your nearest Fluke authorized service center to obtain return authorization information, then send the product to that service center, with a description of the difficulty, postage and insurance prepaid (FOB Destination). Fluke assumes no risk for damage in transit. Fluke will pay return transportation for product repaired or replaced in-warranty. Before making any non-warranty repair, Fluke will estimate cost and obtain authorization, then invoice you for repair and return transportation.

THIS WARRANTY IS YOUR ONLY REMEDY. NO OTHER WARRANTIES, SUCH AS FITNESS FOR A PARTICULAR PURPOSE, ARE EXPRESSED OR IMPLIED. FLUKE SHALL NOT BE LIABLE FOR ANY SPECIAL, INDIRECT, INCIDENTAL OR CONSEQUENTIAL DAMAGES OR LOSSES, INCLUDING LOSS OF DATA, ARISING FROM ANY CAUSE OR THEORY. AUTHORIZED RESELLERS ARE NOT AUTHORIZED TO EXTEND ANY DIFFERENT WARRANTY ON FLUKE'S BEHALF. Since some states do not allow the exclusion or limitation of an implied warranty or of incidental or consequential damages, this limitation of liability may not apply to you. If any provision of this warranty is held invalid or unenforceable by a court or other decision-maker of competent jurisdiction, such holding will not affect the validity or enforceability of any other provision.

	Fluke Corporation	Fluke Europe B.V.
	P.O. Box 9090	P.O. Box 1186
	Everett WA	5602 B.D. Eindhoven
2/02	98206-9090	The Netherlands

Table of Contents

Title	Page
Introduction.....	1
Contacting Fluke.....	1
Precautions and Safety Information.....	2
Electrical Symbols.....	4
Specifications.....	4
General Specifications.....	4
Detailed Specifications.....	5
Basic Maintenance.....	9
Cleaning the Meter.....	9
Opening the Meter Case.....	9
Accessing the PCA and Replacing the LCD.....	10
Reassembling the Meter Case.....	11
Replacing the Battery.....	12
Testing Fuses and Current Circuitry.....	12
Replacing the Fuses.....	13
Required Equipment.....	13
Performance Tests.....	14
Basic Operability Tests.....	15
Testing the Fuses.....	15
Testing the Display.....	15
Testing the Pushbuttons.....	17
Testing Meter Accuracy.....	17
Testing the Inductive Pickup (88 Only).....	19
Calibration Adjustment.....	23
Calibration Adjustment Counter.....	23
Calibration Adjustment Password.....	23
Changing the Password.....	23
Restoring the Default Password.....	24
Meter Buttons Used in the Calibration Steps.....	25
Calibration Adjustment Procedure.....	25
Service and Parts.....	27

List of Tables

Table	Title	Page
1.	Electrical Symbols	4
2.	Model 87 AC Voltage Function Specifications	5
3.	Models 83 and 88 AC Voltage Function Specifications	5
4.	DC Voltage, Resistance, and Conductance Function Specifications	6
5.	Temperature Specifications (87 and 88 Only)	6
6.	Current Function Specifications.....	6
7.	Capacitance and Diode Function Specifications	7
8.	Frequency Counter Specifications (Models 87 and 83)	7
9.	Frequency Counter Specifications (Model 88)	7
10.	Frequency Counter Sensitivity and Trigger Levels.....	7
11.	Electrical Characteristics of the Terminals.....	8
12.	MIN MAX Recording Specifications	8
13.	Required Tools and Equipment.....	14
14.	Display Features.....	15
15.	Accuracy Tests	17
16.	Calibration Adjustment Steps.....	26
17.	80 Series V Final Assembly	27

List of Figures

Figure	Title	Page
1.	Opening the Meter, Battery and Fuse Replacement.....	10
2.	Removing LCD Mask to Access LCD.....	11
3.	Testing the Current Input Fuses.....	13
4.	Display Features.....	15
5.	Setup for Inductive Pickup Test.....	21
6.	Waveform for Inductive Pickup Test.....	22
7.	Restoring the Default Password.....	24
8.	80 Series V Final Assembly.....	28

Introduction

Warning

To avoid shock or injury:

- Read “Precautions and Safety Information” before performing the verification tests or calibration adjustment procedures documented in this manual.
- Do not perform the verification tests or calibration adjustment procedures described in this manual unless you are qualified to do so.
- The information provided in this manual is for the use of qualified personnel only.

Caution

- The 80 Series V Digital Multimeters contains parts that can be damaged by static discharge.
- Follow the standard practices for handling static sensitive devices.

The *80 Series V Calibration Manual* provides the following information:

- Safety information
- Specifications
- Basic maintenance (cleaning, replacing the battery and fuses)
- Performance test procedures
- Calibration adjustment procedures
- Replaceable parts

For complete operating instructions, refer to the *80 Series V* or *88 Series V Users Manual*.

Contacting Fluke

To contact Fluke or locate the nearest Service Center, call one of the following telephone numbers:

USA: 1-888-44-FLUKE (1-888-443-5853)
Canada: 1-800-36-FLUKE (1-800-363-5853)
Europe: +31 402-675-200
Japan: +81-3-3434-0181
Singapore: +65-738-5655
Anywhere in the world: +1-425-446-5500

Or, visit Fluke's Web site at www.fluke.com.

To register your product, visit register.fluke.com

⚠ ⚠ Warning

To avoid possible electric shock or personal injury, inspect the test leads for damaged insulation or exposed metal. Check the test leads for continuity. Replace damaged test leads before using the Meter.

Precautions and Safety Information

In this manual, a **Warning** identifies conditions and actions that pose hazard(s) to the user; a **Caution** identifies conditions and actions that may damage the Meter or the test instruments.

⚠ ⚠ Warning

To avoid possible electric shock or personal injury, follow these guidelines:

- Use this Meter only as specified in this manual or the protection provided by the Meter might be impaired.
- Do not use the Meter if it is damaged. Before using the Meter, inspect the case. Look for cracks or missing plastic. Pay particular attention to the insulation surrounding the connectors.
- Make sure the battery door is closed and latched before operating the Meter.
- Replace the battery as soon as the battery indicator (⊕) appears.
- Remove test leads from the Meter before opening the battery door.
- Inspect the test leads for damaged insulation or exposed metal. Check the test leads for continuity. Replace damaged test leads before using the Meter.
- Do not apply more than the rated voltage, as marked on the Meter, between the terminals or between any terminal and earth ground.
- Never operate the Meter with the cover removed or the case open.
- Use caution when working with voltages above 30 V ac rms, 42 V ac peak, or 60 V dc. These voltages pose a shock hazard.
- Use only the replacement fuses specified in this manual.
- Use the proper terminals, function, and range for measurements.
- Avoid working alone.
- When measuring current, turn off circuit power before connecting the Meter in the circuit. Remember to place the Meter in series with the circuit.

- **When making electrical connections, connect the common test lead before connecting the live test lead; when disconnecting, disconnect the live test lead before disconnecting the common test lead.**
- **Do not use the Meter if it operates abnormally. Protection may be impaired. When in doubt, have the Meter serviced.**
- **Do not operate the Meter around explosive gas, vapor, or dust.**
- **Use only a single 9 V battery, properly installed in the Meter case, to power the Meter.**
- **When servicing the Meter, use only specified replacement parts.**
- **When using probes, keep fingers behind the finger guards on the probes.**
- **Do not use the Low Pass Filter option to verify the presence of hazardous voltages. Voltages greater than what is indicated may be present. Make a voltage measurement without the filter to detect the possible presence of hazardous voltage, then select the filter function.**

⚠ Caution















To avoid possible damage to the Meter or to the equipment under test, follow these guidelines:

- **Disconnect circuit power and discharge all high-voltage capacitors before testing resistance, continuity, diodes, or capacitance.**
- **Before measuring current, check the Meter's fuses. See " Testing the Fuses".**

Electrical Symbols

Electrical symbols used on the Meter and in this manual are explained in Table 1.

Table 1. Electrical Symbols

	AC (Alternating Current)		Earth ground
	DC (Direct Current)		Fuse
	Hazardous voltage.		Conforms to European Union directives
	Risk of Danger. Important information. See Manual.		Conforms to relevant Canadian Standards Association directives
	Battery		Double insulated
	Continuity test or continuity beeper tone.		Capacitance
	Underwriters Laboratories		Diode
CAT III	IEC overvoltage category III CAT III equipment is designed to protect against transients in equipment in fixed-equipment installations, such as distribution panels, feeders and short branch circuits, and lighting systems in large buildings.	CAT IV	IEC overvoltage category IV CAT IV equipment is designed to protect against transients from the primary supply level, such as an electricity meter or an overhead or underground utility service.
	Inspected and licensed by TÜV Product Services.		

Specifications

General Specifications

Maximum Voltage between any Terminal and Earth Ground: 1000 V rms

 **Fuse Protection for mA or μ A inputs:** 44/100 A, 1000 V FAST Fuse

 **Fuse Protection for A input:** 11 A, 1000 V FAST Fuse

Display: Digital: 6000 counts updates 4/sec; (Model 87 and 88 also has 19,999 counts in high-resolution mode).

Analog Bargraph: 33 segments, updates 40/sec. Frequency: 19,999 counts, updates 3/sec at > 10 Hz

Temperature: Operating: -20 °C to +55 °C; Storage: -40 °C to +60 °C

Altitude: Operating: 2000 m; Storage: 10,000 m

Temperature Coefficient: 0.05 x (specified accuracy)/ °C (< 18 °C or > 28 °C)

Electromagnetic Compatibility: In an RF field of 3 V/m total accuracy = specified accuracy + 20 counts

Except: 600 μ A dc range total accuracy=specified accuracy + 60 counts.

Temperature not specified.

Relative Humidity: 0 % to 90 % (0 °C to 35 °C); 0 % to 70 % (35 °C to 55 °C)

Battery Type: 9 V zinc, NEDA 1604 or 6F22 or 006P

Battery Life: 400 hrs typical with alkaline battery (with backlight off)

Vibration: Per MIL-PRF-28800 for a Class 2 instrument

Shock: 1 Meter drop per IEC 61010-1:2001

Size (HxWxL): 1.25 in x 3.41 in x 7.35 in (3.1 cm x 8.6 cm x 18.6 cm)

Size with Holster and Flex-Stand: 2.06 in x 3.86 in x 7.93 in (5.2 cm x 9.8 cm x 20.1 cm)

Weight: 12.5 oz (355 g)

Weight with Holster and Flex-Stand: 22.0 oz (624 g)

Safety: Complies with ANSI/ISA S82.01-2004, CSA 22.2 No. 1010.1:2004 to 1000 V Overvoltage Category III, IEC

664 to 600 V Overvoltage Category IV. UL listed to UL61010-1. Licensed by TÜV to EN61010-1.

Detailed Specifications

For all detailed specifications:

Accuracy is given as $\pm([\% \text{ of reading}] + [\text{number of least significant digits}])$ at 18° C to 28° C, with relative humidity up to 90 %, for a period of one year after calibration.

For Model 87 in the 4 ½-digit mode, multiply the number of least significant digits (counts) by 10. AC conversions are ac-coupled and valid from 3 % to 100 % of range. Model 87 is true rms responding. AC crest factor can be up to 3 at full scale, 6 at half scale. For non-sinusoidal wave forms add $-(2 \% \text{ Rdg} + 2 \% \text{ full scale})$ typical, for a crest factor up to 3.

Table 2. Model 87 AC Voltage Function Specifications

Function	Range	Resolution	Accuracy						
			45 - 65 Hz	30 - 200 Hz	200 - 440 Hz	440 Hz - 1 kHz	1 - 5 kHz	5 - 20 kHz ¹	
\tilde{V} 2,4	600.0 mV	0.1 mV	$\pm (0.7 \% + 4)$	$\pm (1.0 \% + 4)$	$\pm (1.0 \% + 4)$	unspecified	$\pm (2.0 \% + 4)$	$\pm (2.0 \% + 20)$	
	6.000 V	0.001 V							
	60.00 V	0.01 V	$\pm (0.7 \% + 2)$					$\pm (2.0 \% + 4)^3$	unspecified
	600.0 V	0.1 V							
1000 V	1 V		unspecified	unspecified					
	Low pass filter		$\pm (0.7 \% + 2)$	$\pm (1.0 \% + 4)$	+1 % + 4 -6 % - 4 ⁵	unspecified	unspecified	unspecified	

1. Below 10 % of range, add 12 counts.
2. The Meter is a true rms responding meter. When the input leads are shorted together in the ac functions, the Meter may display a residual reading between 1 and 30 counts. A 30 count residual reading will cause only a 2-digit change for readings over 3 % of range. Using REL to offset this reading may produce a much larger constant error in later measurements.
3. Frequency range: 1 kHz to 2.5 kHz.
4. A residual reading of up to 13 digits with leads shorted, will not affect stated accuracy above 3 % of range.
5. Specification increases from -1% at 200 Hz to -6% at 440 Hz when filter is in use.

Table 3. Models 83 and 88 AC Voltage Function Specifications

Function	Range	Resolution	Accuracy		
			50 Hz - 60 Hz	30 Hz - 1 kHz	1 kHz - 5 kHz
\tilde{V} 1	600.0 mV	0.1 mV	$\pm (0.5 \% + 4)$	$\pm (1.0 \% + 4)$	$\pm (2.0 \% + 4)$
	6.000 V	0.001 V			
	60.00 V	0.01 V			
	600.0 V	0.1 V			
	1000 V	1 V			
					$\pm (2.0 \% + 4)^2$
					unspecified

1. Below a reading of 200 counts, add 10 counts.
2. Frequency range: 1 kHz to 2.5 kHz.

For models 83 and 88, ac conversions are ac-coupled and are average- responding, rms-indicating.

Table 4. DC Voltage, Resistance, and Conductance Function Specifications

Function	Range	Resolution	Accuracy		
			Model 83	Model 87	Model 88
\bar{V}	6.000 V	0.001 V	$\pm (0.1 \% + 1)$	$\pm (0.05 \% + 1)$	$\pm (0.1 \% + 1)$
	60.00 V	0.01 V	$\pm (0.1 \% + 1)$	$\pm (0.05 \% + 1)$	$\pm (0.1 \% + 1)$
	600.0 V	0.1 V	$\pm (0.1 \% + 1)$	$\pm (0.05 \% + 1)$	$\pm (0.1 \% + 1)$
	1000 V	1 V	$\pm (0.1 \% + 1)$	$\pm (0.05 \% + 1)$	$\pm (0.1 \% + 1)$
\bar{mV}	600.0 mV	0.1 mV	$\pm (0.3 \% + 1)$	$\pm (0.1 \% + 1)$	$\pm (0.3 \% + 1)$
Ω	600.0 Ω	0.1 Ω	$\pm (0.4 \% + 2)^1$	$\pm (0.2 \% + 2)^1$	$\pm (0.4 \% + 2)^1$
	6.000 k Ω	0.001 k Ω	$\pm (0.4 \% + 1)$	$\pm (0.2 \% + 1)$	$\pm (0.4 \% + 1)$
	60.00 k Ω	0.01 k Ω	$\pm (0.4 \% + 1)$	$\pm (0.2 \% + 1)$	$\pm (0.4 \% + 1)$
	600.0 k Ω	0.1 k Ω	$\pm (0.7 \% + 1)$	$\pm (0.6 \% + 1)$	$\pm (0.7 \% + 1)$
	6.000 M Ω	0.001 M Ω	$\pm (0.7 \% + 1)$	$\pm (0.6 \% + 1)$	$\pm (0.7 \% + 1)$
nS	50.00 M Ω	0.01 M Ω	$\pm (1.0 \% + 3)^2$	$\pm (1.0 \% + 3)^2$	$\pm (1.0 \% + 3)^2$
	60.00 nS	0.01 nS	$\pm (1.0 \% + 10)^1$	$\pm (1.0 \% + 10)^1$	$\pm (1.0 \% + 10)^1$

1. When using the REL Δ function to compensate for offsets.
2. Add 0.5 % of reading when measuring above 30 M Ω in the 50 M Ω range, and 20 counts below 33 nS in the 60 nS range.

Table 5. Temperature Specifications (87 and 88 Only)

Temperature	Resolution	Accuracy ^{1,2}
-200 °C to +1090 °C	0.1 °C	1 % + 10
-328 °F to +1994 °F	0.1 °F	1 % + 18



1. Does not include error of the thermocouple probe.
2. Accuracy specification assumes ambient temperature stable to ± 1 °C. For ambient temperature changes of ± 5 °C, rated accuracy applies after 1 hour.

Table 6. Current Function Specifications

Function	Range	Resolution	Accuracy			Burden Voltage (typical)
			Model 83 ¹	Model 87 ^{2, 3}	Model 88 ¹	
mA A~ (45 Hz to 2 kHz)	60.00 mA	0.01 mA	$\pm (1.2 \% + 2)^5$	$\pm (1.0 \% + 2)$	$\pm (1.2 \% + 2)^5$	1.8 mV/mA
	400.0 mA ⁶	0.1 mA	$\pm (1.2 \% + 2)^5$	$\pm (1.0 \% + 2)$	$\pm (1.2 \% + 2)^5$	1.8 mV/mA
	6.000 A	0.001 A	$\pm (1.2 \% + 2)^5$	$\pm (1.0 \% + 2)$	$\pm (1.2 \% + 2)^5$	0.03 V/A
	10.00 A ⁴	0.01 A	$\pm (1.2 \% + 2)^5$	$\pm (1.0 \% + 2)$	$\pm (1.2 \% + 2)^5$	0.03 V/A
mA A=	60.00 mA	0.01 mA	$\pm (0.4 \% + 4)$	$\pm (0.2 \% + 4)$	$\pm (0.4 \% + 4)$	1.8 mV/mA
	400.0 mA ⁶	0.1 mA	$\pm (0.4 \% + 2)$	$\pm (0.2 \% + 2)$	$\pm (0.4 \% + 2)$	1.8 mV/mA
	6.000 A	0.001 A	$\pm (0.4 \% + 4)$	$\pm (0.2 \% + 4)$	$\pm (0.4 \% + 4)$	0.03 V/A
	10.00 A ⁴	0.01 A	$\pm (0.4 \% + 2)$	$\pm (0.2 \% + 2)$	$\pm (0.4 \% + 2)$	0.03 V/A
μA ~ (45 Hz to 2 kHz)	600.0 μ A	0.1 μ A	$\pm (1.2 \% + 2)^5$	$\pm (1.0 \% + 2)$	$\pm (1.2 \% + 2)^5$	100 μ V/ μ A
	6000 μ A	1 μ A	$\pm (1.2 \% + 2)^5$	$\pm (1.0 \% + 2)$	$\pm (1.2 \% + 2)^5$	100 μ V/ μ A
μA =	600.0 μ A	0.1 μ A	$\pm (0.4 \% + 4)$	$\pm (0.2 \% + 4)$	$\pm (0.4 \% + 4)$	100 μ V/ μ A
	6000 μ A	1 μ A	$\pm (0.4 \% + 2)$	$\pm (0.2 \% + 2)$	$\pm (0.4 \% + 2)$	100 μ V/ μ A

1. AC conversion for Model 83 and 88 is ac coupled and calibrated to the rms value of a sine wave input.
2. AC conversions for Model 87 are ac coupled, true rms responding, and valid from 3 % to 100 % of range, except 400 mA range (5 % to 100 % of range) and 10 A range (15 % to 100 % of range).
3. Model 87 is a true rms responding meter. When the input leads are shorted together in the ac functions, the Meter may display a residual reading between 1 and 30 counts. A 30 count residual reading will cause only a 2 digit change for readings over 3 % of range. Using REL to offset this reading may produce a much larger constant error in later measurements
4. Δ 10 A continuous up to 35 °C; < 20 minutes on, 5 minutes off at 35 °C to 55 °C. 20 A for 30 seconds maximum; > 10 A unspecified.
5. Below a reading of 200 counts, add 10 counts.
6. 400 mA continuous; 600 mA for 18 hrs maximum.

Table 7. Capacitance and Diode Function Specifications



Function	Range	Resolution	Accuracy
	10.00 nF	0.01 nF	$\pm (1\% + 2)^1$
	100.0 nF	0.1 nF	$\pm (1\% + 2)^1$
	1.000 μ F	0.001 μ F	$\pm (1\% + 2)$
	10.00 μ F	0.01 μ F	$\pm (1\% + 2)$
	100.0 μ F	0.1 μ F	$\pm (1\% + 2)$
	9999 μ F	1 μ F	$\pm (1\% + 2)$
	3.000 V	0.001 V	$\pm (2\% + 1)$

1. With a film capacitor or better, using Relative mode to zero residual.

Table 8. Frequency Counter Specifications (Models 87 and 83)

Function	Range	Resolution	Accuracy
Frequency (0.5 Hz to 200 kHz, pulse width > 2 μ s)	199.99	0.01 Hz	$\pm (0.005\% + 1)$
	1999.9	0.1 Hz	$\pm (0.005\% + 1)$
	19.999 kHz	0.001 kHz	$\pm (0.005\% + 1)$
	199.99 kHz	0.01 kHz	$\pm (0.005\% + 1)$
	> 200 kHz	0.1 kHz	unspecified

Table 9. Frequency Counter Specifications (Model 88)

Function	Range	Resolution	Accuracy	Pulse Width Range (ms) ¹	Resolution (ms)
Frequency ² (0.5 Hz to 200 kHz, pulse width > 2 μ s)	199.99	0.01 Hz	$\pm (0.01\% + 1)$	1999.9	0.1
	1999.9	0.1 Hz	$\pm (0.01\% + 1)$	5.00	0.01
	19.999 kHz	0.001 kHz	$\pm (0.01\% + 1)$	0.500	0.001
	199.99 kHz	0.01 kHz	$\pm (0.01\% + 1)$	0.0500	0.0001
	> 200 kHz	0.1 kHz	unspecified		
RPM 	30 to 9,000	1 RPM	± 2 RPM		
RPM 	60 to 12,000	1 RPM	± 2 RPM		
% Duty Cycle ³	0.0 to 99.9% (0.5 Hz to 200 kHz, Pulse Width >2 μ s)				
Pulse Width ³	0.002 to 1999.9 ms (4 Hz to 200 kHz, Pulse Width >2 μ s)				

1. Pulse Width range is determined by the frequency of the signal.
2. Frequency measurements can be made on voltage or current inputs. The current inputs are always dc coupled.
3. For rise times >1 μ s. Duty Cycle Accuracy: $\pm(0.2\%$ per kHz + 0.1%). Pulse Width Accuracy: $\pm(0.002$ ms + 3).

Table 10. Frequency Counter Sensitivity and Trigger Levels

Input Range ¹	Minimum Sensitivity (RMS Sine wave)		Approximate Trigger Level (DC Voltage Function)
	5 Hz - 20 kHz	0.5 Hz - 200 kHz	
600 mV dc	70 mV (to 400 Hz)	70 mV (to 400 Hz)	40 mV
600 mV ac	150 mV	150 mV	—
6 V	0.3 V	0.7 V	1.7 V
60 V	3 V	7 V (\leq 140 kHz)	4 V
600 V	30 V	70 V (\leq 14.0 kHz)	40 V
1000 V	100 V	200 V (\leq 1.4 kHz)	100 V
Duty Cycle Range	Accuracy		
0.0 to 99.9 %	Within $\pm (0.2\%$ per kHz + 0.1 %) for rise times < 1 μ s.		

1. Maximum input for specified accuracy = 10X Range or 1000 V.

Table 11. Electrical Characteristics of the Terminals

Function	Overload Protection ¹	Input Impedance (nominal)	Common Mode Rejection Ratio (1 kΩ unbalance)	Normal Mode Rejection						
\bar{V}	1000 V rms	10 MΩ < 100 pF	> 120 dB at dc, 50 Hz or 60 Hz	> 60 dB at 50 Hz or 60 Hz						
\bar{mV}	1000 V rms	10 MΩ < 100 pF	> 120 dB at dc, 50 Hz or 60 Hz	> 60 dB at 50 Hz or 60 Hz						
\tilde{V}	1000 V rms	10 MΩ < 100 pF (ac-coupled)	> 60 dB, dc to 60 Hz	Full Scale Voltage			Typical Short Circuit Current			
				Open Circuit Test Voltage	To 6.0 MΩ	50 MΩ or 60 nS	600 Ω	6 k	60 k	600 k
Ω	1000 V rms	< 7.9 V dc	< 4.1 V dc	< 4.5 V dc	1 mA	100 μA	10 μA	1 μA	1 μA	0.5 μA
\rightarrow	1000 V rms	< 3.9 V dc	3.000 V dc		0.6 mA typical					
10 ⁶ V Hz max										

Table 12. MIN MAX Recording Specifications

Model	Nominal Response	Accuracy
83	100 ms to 80 %	Specified accuracy ± 12 counts for changes > 200 ms in duration (± 40 counts in ac with beeper on)
87, 88	100 ms to 80 % (dc functions) 120 ms to 80 % (ac functions) 250 μs (peak) ¹	Specified accuracy ± 12 counts for changes > 200 ms in duration Specified accuracy ± 40 counts for changes > 350 ms and inputs > 25 % of range Specified accuracy ± 100 counts for changes > 250 μs in duration (add ± 100 counts for readings over 6000 counts) (add ± 100 counts for readings in Low Pass mode)
1. For repetitive peaks: 1 ms for single events.		

Basic Maintenance

Warning

To avoid possible electric shock or personal injury:

- Remove the test leads and any input signals before opening the case or replacing the battery or fuses.
- Repairs or servicing covered in this manual should be performed only by qualified personnel.

Cleaning the Meter

Warning

To avoid possible electric shock, personal injury, or damage to the meter, never allow water inside the case.

Caution

To avoid damaging the Meter, never apply abrasives, solvents, aromatic hydrocarbons, chlorinated solvents, or methanol-based fluids to the Meter.

Periodically wipe the Meter case with Fluke “MeterCleaner™” or a damp cloth and mild detergent.

Dirt or moisture in the **A** or **mA** μ **A** input terminals can affect readings and can falsely activate the Input Alert feature without the test leads being inserted. Such contamination may be dislodged by turning the Meter over and, with all test leads removed, gently tapping on the case.

Thoroughly clean the terminals as follows:

1. Turn the Meter off and remove all test leads.
2. Soak a clean swab with isopropyl alcohol and work the swab around in each input terminal to remove contaminants.

Opening the Meter Case

Caution

To avoid unintended circuit shorting, always place the uncovered Meter assembly on a protective surface. When the case of the Meter is open, circuit connections are exposed.

To open the Meter case, refer to Figure 1 and do the following:

1. Disconnect test leads from any live source, turn the rotary knob to **OFF**, and remove the test leads from the front terminals.
2. Remove the battery door by using a flat-blade screwdriver to turn the battery door screws 1/4-turn counterclockwise.
3. The case bottom is secured to the case top by three screws and two internal snaps (at the LCD end). Using a Phillips-head screwdriver, remove the three screws.

⚠ Caution

To avoid damaging the Meter, the gasket that is sealed to the bottom case, and is between the two case halves, must remain with the case bottom. The case top lifts away from the gasket easily. Do not damage the gasket or attempt to separate the case bottom from the gasket.

4. Hold the Meter display side up.
5. Pushing up from the inside of the battery compartment, disengage the case top from the gasket.
6. Gently unsnap the case top at the display end, see Figure 1.

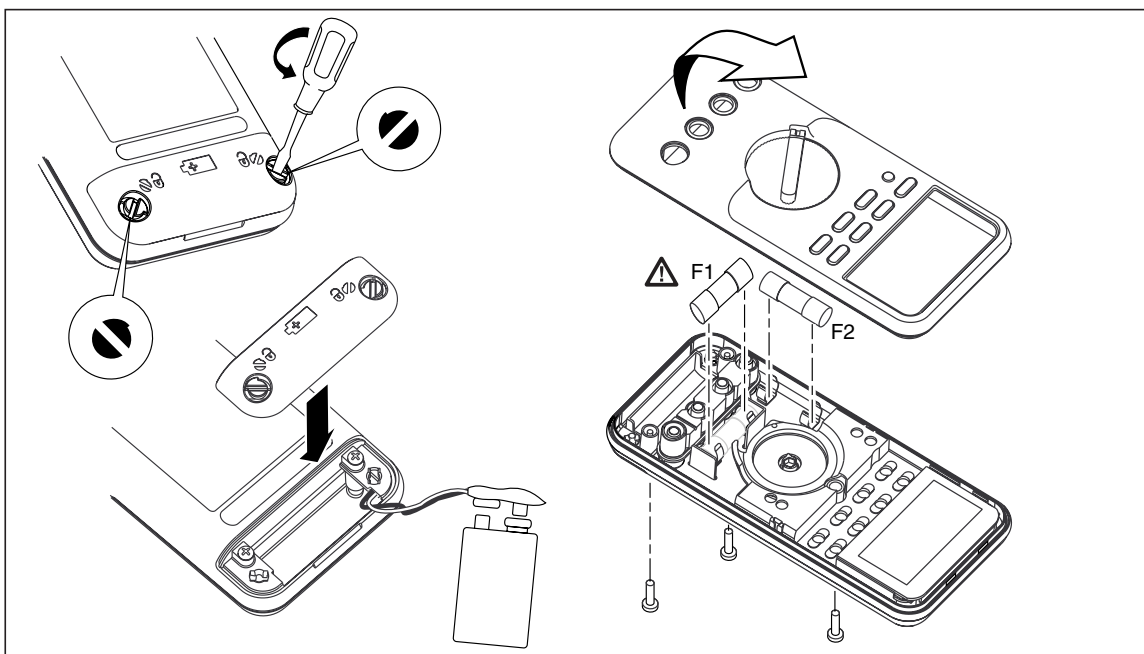

Figure 1. Opening the Meter, Battery and Fuse Replacement

ama12.eps

Accessing the PCA and Replacing the LCD

Once the case has been opened, the A1 Main PCA can easily be removed. The shields disconnect from the PCA as follows:

1. Remove the five Phillips-head screw securing the top and bottom shields to the PCA.
2. Remove the top shield assembly that also houses the LCD and lightpipe for the LCD backlight.
3. To access the LCD, unsnap the LCD mask using a small flat-blade screwdriver. The LCD may now be removed. Refer to Figure 2.

Note

Two elastomeric connectors make electrical contact between the LCD and the PCA. These connectors usually stick to the LCD when it is removed. If the connectors are to be reused, do not handle them, as the electrical contact points might become contaminated. Use tweezers to remove these connectors.

4. To reinstall the connectors, replace the LCD and LCD mask and lay the top shield face down. Install the elastomeric connector strips into the slots on the top shield.

5. Place the PCA onto the top shield so that the screw holes align.
6. Place the bottom shield onto the PCA and secure the assembly with five Phillips-head screws. Ensure that the shields are tightly attached. Properly fitted shields are required for the Meter to perform to specifications.

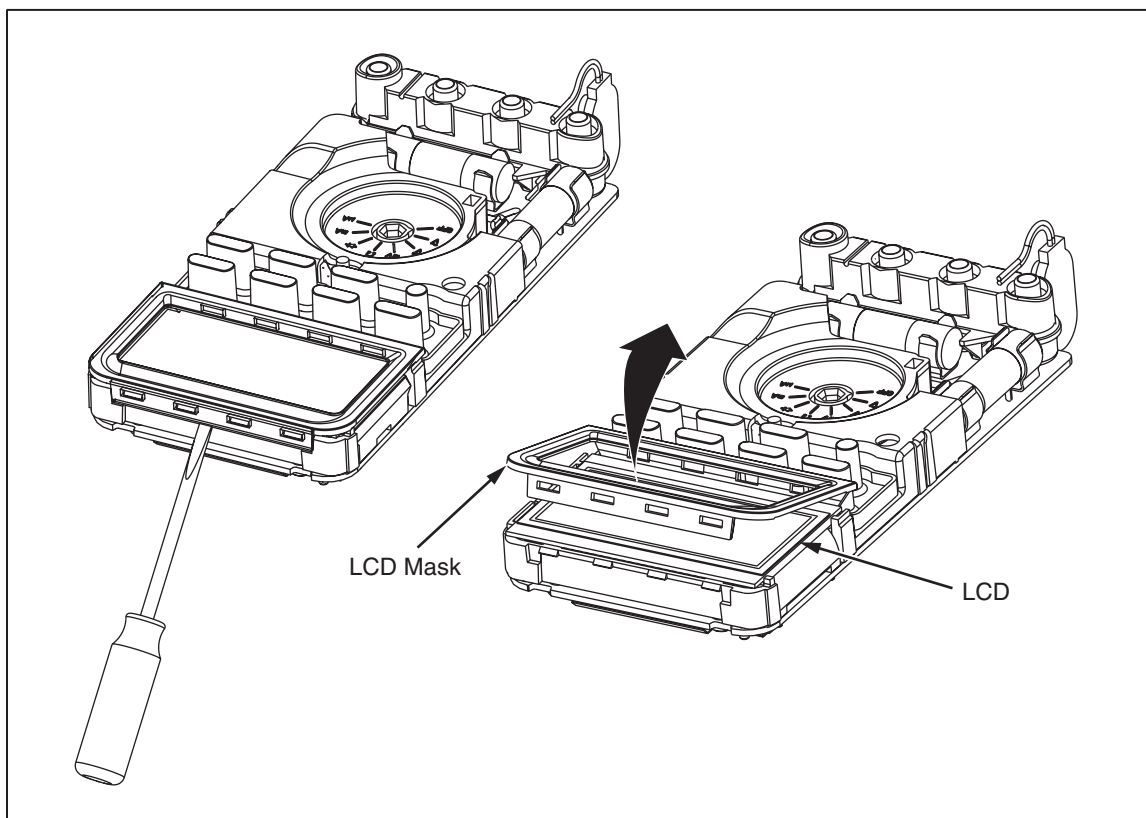

Figure 2. Removing LCD Mask to Access LCD

ama08f.eps

Reassembling the Meter Case

To reassemble the Meter case:

1. Verify that the rotary knob and circuit board switch are in the **OFF** position, and that the gasket remains secured to the bottom case.
2. Place the PCA into the bottom case.
3. Place the case top on the case bottom.
4. To avoid damaging the battery wire, ensure the wire exits the middle of the battery compartment.
5. Properly seat the case gasket and snap the case halves together above the LCD end. See Figure 1.
6. Reinstall the three case screws and the battery door.
7. Secure the battery door by turning the screw 1/4-turn clockwise.
8. Go to “Performance Tests” later in this document, and perform the procedures described.

Replacing the Battery

Replace the battery with a 9-V battery (NEDA A1604, 6F22, or 006P).

Warning

To avoid false readings, which could lead to possible electric shock or personal injury, replace the battery as soon as the battery indicator (🔋) appears. If the display shows “bAtt” the Meter will not function until the battery is replaced.

Replace the battery as follows, refer to Figure 1:

1. Turn the rotary knob to **OFF** and remove the test leads from the terminals.
2. Remove the battery door by using a standard-blade screwdriver to turn the battery door screws one-quarter turn counterclockwise.
3. Remove the old battery and replace it with a new one.
4. Align the battery leads so that they not pinched between the battery door and the case bottom.
5. Secure the door by turning the screws one-quarter turn clockwise.

Testing Fuses and Current Circuitry

If a test lead is plugged into the **mA/μA** or **A** terminal and the rotary knob is turned to a non-current function, the Meter chirps and flashes “LEAd” if the fuse associated with that current terminal is good. If the Meter does not chirp or flash “LEAd”, the fuse is bad and must be replaced. Refer to Table 17 for the appropriate replacement fuse.

After replacing the fuse, use the following procedure to verify the integrity of the new fuse and the current circuitry. Refer to Figure 3.

1. Turn the rotary knob to Ω .
2. To test F2, insert a test lead into the $V\Omega$ input terminal and touch the probe to the **A** input terminal.

Note

The input receptacles contain split contacts. Be sure to touch the probe to the half of the receptacle nearest the LCD.

3. The display should indicate between 00.0 Ω and 00.5 Ω . If the display reads OL, replace the fuse and test again. If the display reads another value, further servicing is required.
4. To test F1, move the probe from the **A** input terminal to the **mA/μA** input terminal.
5. The display should read between 0.995 k Ω and 1.005 k Ω . If the display reads OL, replace the fuse and test again. If the display reads another value, further servicing is required.

Warning

To avoid electrical shock or personal injury:

- Remove the test leads and any input signals before replacing the battery or fuses.
- Install **ONLY** specified replacement fuses with the amperage, voltage, and speed ratings shown in Table 17.

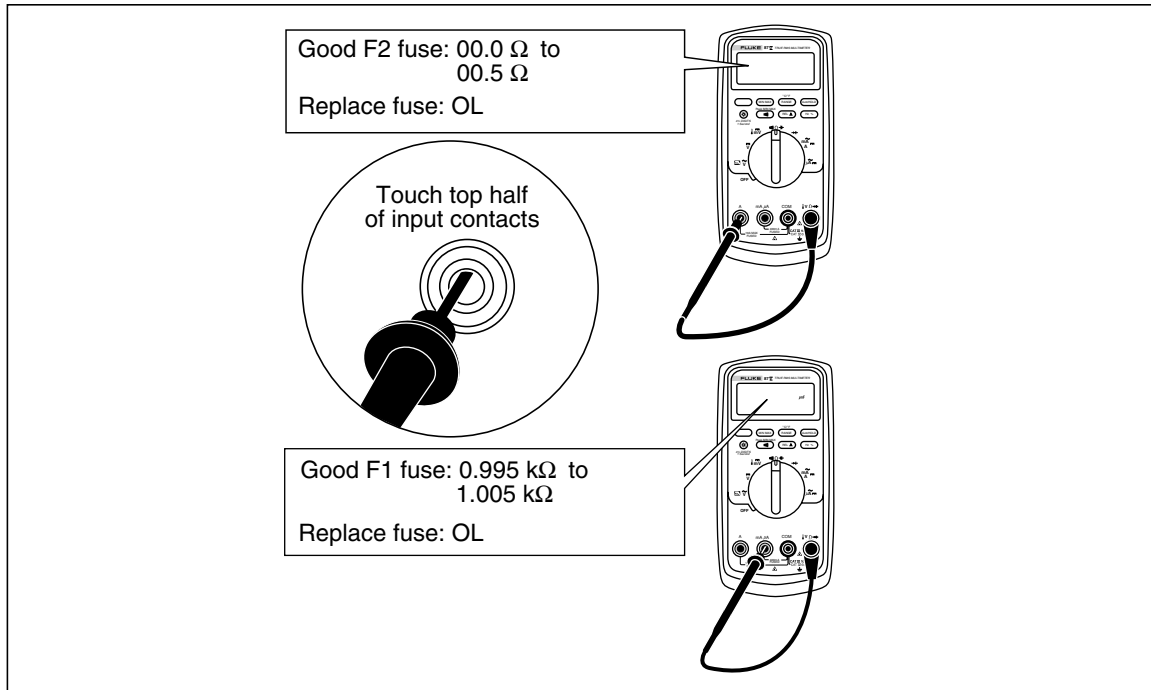

Figure 3. Testing the Current Input Fuses

Replacing the Fuses

To replace the fuse(s), perform the following procedure.

1. To open the Meter, refer to “Opening the Meter Case”. See Figure 1.
2. Grasp the fuse in the center with needle nose pliers. Pull straight up on the fuse to remove it from the fuse clips.
3. Install ONLY specified replacement fuses with the amperage, voltage, and speed ratings shown in Table 17.
4. To close the Meter, refer to “Reassembling the Meter Case”.

Required Equipment

Required equipment for the performance tests is listed in Table 13. If the recommended models are not available, equipment with equivalent specifications may be used.

⚠ ⚠ Warning

- **To avoid shock or injury, do not perform the verification tests or calibration adjustment procedures described in this manual unless you are qualified to do so.**
- **Repairs or servicing should be performed only by qualified personnel.**

Table 13. Required Equipment

Equipment	Required Characteristics	Recommended Model
Calibrator	AC Voltage Range: 0 - 1000 V ac Accuracy: $\pm 0.12\%$ Frequency Range: 60 - 20000 Hz Accuracy: $\pm 3\%$ DC Voltage Range: 0 - 1000 V dc Accuracy: $\pm 0.012\%$ Current Range: 350 μ A - 2 A Accuracy: AC (60 Hz to 1 kHz): $\pm 0.25\%$ DC: $\pm 0.05\%$ Frequency Source: 19.999 kHz - 199.99 kHz Accuracy: $\pm 0.0025\%$ Amplitude: 150 mV to 6V rms Accuracy: $\pm 5\%$ Range: 1 Ω - 100 M Ω Accuracy: 0.065 %	Fluke 5520A Multi-Product Calibrator or equivalent
Function Generator	Frequency = 900 kHz Amplitude = 8.3V Burst mode = 1 Burst rate = 100Hz Burst Phase = -90 degrees	HP33120
Fluke 80 AK TC Adapter Accessory	K-type	Fluke 80 AK
K-type Thermocouple	K-type, mini-plug on both ends	

Performance Tests

The following performance tests verify the complete operability of the Meter and check the accuracy of each Meter function against the Meter's specifications. Performance tests should be performed annually to ensure that the Meter is within accuracy specifications.

Accuracy specifications are valid for a period of one year after calibration adjustment, when measured at an operating temperature of 18 °C to 28 °C and at a maximum of 90 % relative humidity.

To perform the following tests, it is not necessary to open the case. No adjustments are necessary. Make the required connections, apply the designated inputs, and determine if the reading on the Meter display falls within the acceptable range indicated.

Note

If the Meter fails any of these tests, it needs calibration adjustment or repair.

Basic Operability Tests

Refer to the following sections to test the basic operability of the Meter.

Testing the Fuses

Refer to “Testing the Fuses”.

Testing the Display

Turn the Meter on while holding down (AutoHOLD) to view all segments of the display. Compare the display with the appropriate examples in Figure 4 and Table 14.

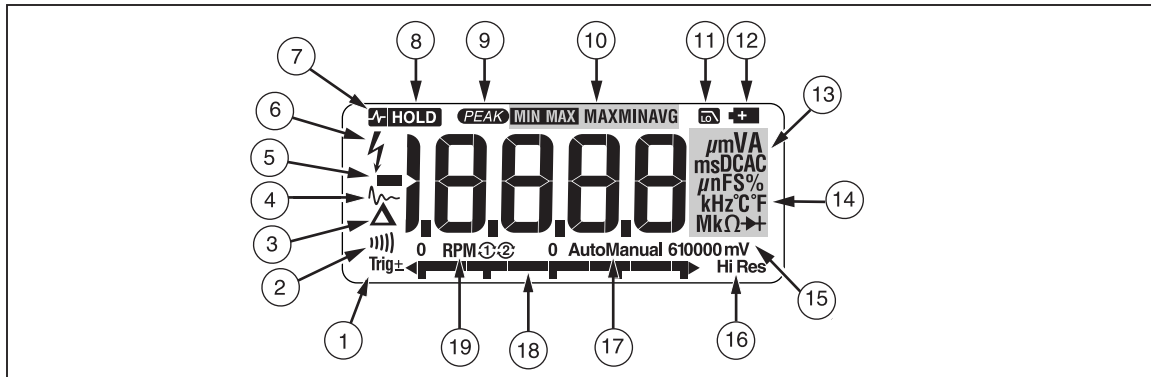







Figure 4. Display Features

ay104.eps

Table 14. Display Features



Number	Feature	Indication
①	±	Polarity indicator for the analog bar graph.
	Trig±	Positive or negative slope indicator for Hz/duty cycle triggering.
②		The continuity beeper is on.
③	△	Relative (REL) mode is active.
④	~	Smoothing is active.
⑤	-	Indicates negative readings. In relative mode, this sign indicates that the present input is less than the stored reference.
⑥	⚡	Indicates the presence of a high voltage input. Appears if the input voltage is 30 V or greater (ac or dc). Also appears in low pass filter mode. Also appears in cal, Hz, and duty cycle modes.
⑦	⏸ HOLD	AutoHOLD is active.
⑧	HOLD	Display Hold is active.
⑨	PEAK	Indicates the Meter is in Peak Min Max mode and the response time is 250 μs
⑩	MIN MAX MAX MIN AVG	Indicators for minimum-maximum recording mode.
⑪	LOW	Low pass filter mode.

Table 13. Display Features (cont.)

Number	Feature	Indication
⑫		The battery is low. $\Delta\Delta$ Warning: To avoid false readings, which could lead to possible electric shock or personal injury, replace the battery as soon as the battery indicator appears.
⑬	A, μA, mA V, mV μF, nF nS % Ω, MΩ, kΩ Hz, kHz AC DC	Amperes (amps), Microamp, Milliamp Volts, Millivolts Microfarad, Nanofarad Nanosiemens Percent. Used for duty cycle measurements. Ohm, Megohm, Kilohm Hertz, Kilohertz Alternating current, direct current
⑭	$^{\circ}$C, $^{\circ}$F	Degrees Celsius, Degrees Fahrenheit
⑮	610000 mV	Displays selected range
⑯	HiRes	The Meter is in high resolution (Hi Res) mode. HiRes=19,999
⑰	Auto	The Meter is in autorange mode and automatically selects the range with the best resolution.
	Manual	The Meter is in manual range mode.
⑱		The number of segments is relative to the full-scale value of the selected range. In normal operation 0 (zero) is on the left. The polarity indicator at the left of the graph indicates the polarity of the input. The graph does not operate with the capacitance, frequency counter functions, temperature, or peak min max. For more information, see "Bar Graph". The bar graph also has a zoom function, as described under "Zoom Mode".
⑲	RPM  	 conventional (4 cycle) Counts every other revolution.  waste spark of 2 cycle. Counts every revolution.
--	OL	Overload condition is detected.
Error Messages		
bAtt	Replace the battery immediately.	
diSC	In the capacitance function, too much electrical charge is present on the capacitor being tested.	
EEP Err	Invalid EEPROM data. Have Meter serviced.	
CAL Err	Invalid calibration data. Calibrate Meter.	
LEAD	Δ Test lead alert. Displayed when the test leads are in the A or mA/μA terminal and the selected rotary switch position does not correspond to the terminal being used.	

Testing the Pushbuttons

To test the pushbuttons

1. Turn the Meter rotary knob to  \tilde{V} .
2. Press each button and note that the meter responds with a beep for each button press.
3. Press and hold  a second time to exit MIN MAX mode.

Testing Meter Accuracy

Perform the accuracy test steps in Table 15.

Table 15. Accuracy Tests

Step	Test Function	Range	5500A Output	Display Reading	
				83 and 88	87
1	\tilde{V} AC Volts	600 mV	330 mV, 60 Hz	327.9 to 332.1	327.3 to 332.7
2		600 mV	600 mV, 13 kHz	N/A	586.0 to 614.0
3		6 V	3.3 V, 60 Hz	3.281 to 3.319	3.275 to 3.325
4		6 V	3.3 V, 20 kHz	N/A	3.214 to 3.386
5		60 V	33 V, 60 Hz	32.81 to 33.19	32.75 to 33.25
6		60 V	33 V, 20 kHz	N/A	32.14 to 33.86
7		600 V	330 V, 60 Hz	328.1 to 331.9	327.5 to 332.5
8		600 V	330 V, 2.5 kHz	N/A	323.0 to 337.0
9		1000 V	500 V, 60 Hz	495 to 505	494 to 506
10		1000 V	1000 V, 1 kHz	986 to 1014	986 to 1014
11	\tilde{V} Hz AC Volts Frequency	600 mV	150 mV, 99.95 kHz	99.93 to 99.97	99.93 to 99.97
12		600 mV	150 mV, 199.50 kHz	199.48 to 199.52	199.48 to 199.52
13	Sensitivity	6 V	0.7 V, 99.95 kHz	99.93 to 99.97	99.93 to 99.97
14		60 V	7 V, 99.95 kHz	99.93 to 99.97	99.93 to 99.97
15	$\overline{\overline{V}}$ Hz Trigger level	6 V	3.4 V, 1 kHz Sq. Wave	999.8 to 1000.2	999.8 to 1000.2
16	$\overline{\overline{V}}$ Hz Duty Cycle	6 V	5 V, 1 kHz, DC offset 2.5 V Sq. Wave	49.7% to 50.3 %	49.7 % to 50.3 %
17	$\overline{\overline{V}}$ DC Volts	6V	3.3 V dc	3.296 to 3.304	3.297 to 3.303
18		60 V	33 V dc	32.96 to 33.04	32.97 to 33.03
19		600 V	330 V dc	329.6 to 330.4	329.7 to 330.3
20		1000 V	1000 V dc	998 to 1002	998 to 1002
21	$\overline{\overline{mV}}$ DC Volts	600 mV	33 mV dc	32.8 to 33.2	32.9 to 33.1
22		600 mV	330 mV dc	328.9 to 331.1	329.6 to 330.4

Table 14. Accuracy Tests (cont.)

Step	Test Function	Range	5500A Output	Display Reading	
				83 and 88	87
23	Ω Ohms	600 Ω	330 Ω (Use 2 wire Comp) ¹	328.5 to 331.5	329.1 to 330.9
24		6 k Ω	3.3 k Ω (Use 2 wire Comp) ¹	3.286 to 3.314	3.292 to 3.308
25		60 k Ω	33 k Ω	32.86 to 33.14	32.92 to 33.08
26		600 k Ω	330 k Ω	327.6 to 332.4	327.9 to 332.1
27		6 M Ω	3.3 M Ω	3.276 to 3.324	3.279 to 3.321
28		50 M Ω	30 M Ω	29.67 to 30.33	29.67 to 30.33
29		nS Conductance	60 nS	Open input	- 0.30 to 0.30
30	60 nS		100 M Ω	9.60 to 10.40	9.60 to 10.40
31	\rightarrow — Diode	6 V	3.0 V dc	2.939 to 3.061	2.939 to 3.061
32	\tilde{A} AC Amps	6 A	3.0 A, 60 Hz	2.962 to 3.038	2.968 to 3.032
33	$\overline{\overline{A}}$ DC Amps	6 A	3.0 A	2.984 to 3.016	2.990 to 3.010
33B	$\overline{\overline{A}}$ DC Amps	10A ⁶	10A	9.94 to 10.06	9.96 to 10.04
34	mA $\tilde{}$ AC Milliamps	60 mA	33 mA, 60 Hz	32.58 to 33.42	32.65 to 33.35
35		400 mA	330 mA, 60 Hz	325.8 to 334.2	326.5 to 333.5
36	mA $\overline{\overline{}}$ DC Milliamp	60 mA	33 mA	32.83 to 33.17	32.89 to 33.11
37		400 mA	330 mA	328.5 to 331.5	329.1 to 330.9
38	$\mu\tilde{A}$ AC Microamps	600 μ A	330 μ A, 60 Hz	325.8 to 334.2	326.5 to 333.5
39		6000 μ A	3300 μ A, 60 Hz	3258 to 3342	3265 to 3335
40	$\mu\overline{\overline{A}}$ DC Microamps	600 μ A	330 μ A	328.3 to 331.7	328.9 to 331.1
41		6000 μ A	3300 μ A	3285 to 3315	3291 to 3309
42	— \leftarrow Capacitance	10 nf	Open input ²	0.21 to 0.31	0.21 to 0.31
43		100 nf	5 nf ⁵	04.7 to 05.3	04.7 to 05.3
44		100 μ f	9.5 μ f	09.2 to 09.8	09.2 to 09.8
45	\tilde{V} Low Pass Filter	1000 V	400 V, 400 Hz	N/A	376 to 408
46		1000 V	400 V, 800 Hz ⁴	N/A	226 to 340 ⁴

Table 14. Accuracy Tests (cont.)

Step	Test Function	Range	5500A Output	Display Reading	
				83 and 88	87
47	\bar{V} (87 and 88 only) Peak Min/Max	6 V dc	8 Vpp, 2 kHz Sq. Wave, DC offset 2 V	Max = 5.896 to 6.104	
48				Min = -1.898 to -2.102	
49	$m\bar{V}$ (87 and 88 only) Temperature ³		0 °C	-1.0 to 1.0	-1.0 to 1.0
50			100 °C	98.0 to 102.0	98.0 to 102.0
51	Backlight		Press backlight button	Backlight comes on	
52			Press backlight button	Backlight Intensifies	
53			Press backlight button	Backlight off	
<ol style="list-style-type: none"> 1. Or short test leads and use REL to offset test lead resistance. 2. Remove test leads from unit. 3. To ensure accurate measurement, the Meter and thermocouple adapter must be at the same temperature. After connecting the thermocouple adapter to the Meter allow for reading to stabilize before recording display reading. 4. The Meter accuracy is not specified at this input signal frequency with Low-pass filter selected. The display reading shown, check that the Low-pass filter is active and follows an expected roll-off curve. 5. Use REL to compensate for internal Meter and lead capacitance. Test leads must be disconnected from the calibrator before using REL. 6. Δ 10 A continuous up to 35 °C; < 20 minutes on, 5 minutes off at 35 °C to 55 °C. 20 A for 30 seconds maximum; > 10 A unspecified. 					

Testing the Inductive Pickup (88 Only)

To test the inductive pickup, a function generator output will simulate automobile spark plug signals on a loop of wire containing a 10 Ω resistor. The pickup will be clamped to the wire and output voltage from the pickup will be monitored by an oscilloscope.

Perform the following procedure to test the inductive pickup:

1. Solder a 10-inch piece of 14 AWG wire to one end of a 10 Ω 1 % resistor.
2. Connect the other end of the 10 Ω resistor to the terminal LOW output of the function generator. Place the other end of the 14-AWG wire to the HIGH output of the function generator. See Figure 5.
3. Connect a 10X scope probe from channel 2 (dc-coupled) of the oscilloscope across the 10 Ω resistor.
4. Clamp the inductive pickup to the wire loop on the HIGH side of the resistor as shown in Figure 5.

Make sure that the jaws of the inductive pickup are closed completely, and that the side of the inductive pickup that says "SPARK PLUG SIDE" points toward the HIGH output of the function generator.

5. Connect a 10X scope probe from channel 1 (dc-coupled) of the oscilloscope across the output of the inductive pickup.

6. Set up the function generator as follows:

Frequency	900 kHz
Amplitude	8.3 V
Burst Mode	yes
Burst Count	1
Burst Rate	100 Hz
Burst Phase	-90 Degrees
7. Set the oscilloscope for 0.5 V/DIV @ 0.5 μ s/DIV.
8. Trigger the waveform on channel 2.
9. Adjust the amplitude of the function generator to produce a 3 VP-P triangle wave. See Figure 6.
10. Set the oscilloscope for 1.0 V/DIV @ 5.0 ms/DIV.
11. Trigger the waveform on Channel 1.
12. Check that the peak voltage is greater than 5.7 V and decays to less than 1.0 V between pulses. See Figure 6. Record the peak value for later use.
13. Adjust the function generator output so the peak voltage is 6 V.
14. Set the scope for 1.0 ms/DIV and trigger waveform.
15. Check the amplitude after 3.0 ms from the waveform peak, the voltage amplitude is 2.4 V \pm 0.5/-0.8 (1.6 V to 2.9 V). (See Figure 3-5(C).)
16. Re-adjust the function generator output to obtain the value recorded in step 12.
17. Set the scope for 5.0 ms/DIV.
18. Turn the inductive pickup so that "SPARK PLUG SIDE" points along the wire connected to the LOW output of the function generator. Check that the waveform is less than 2 V.

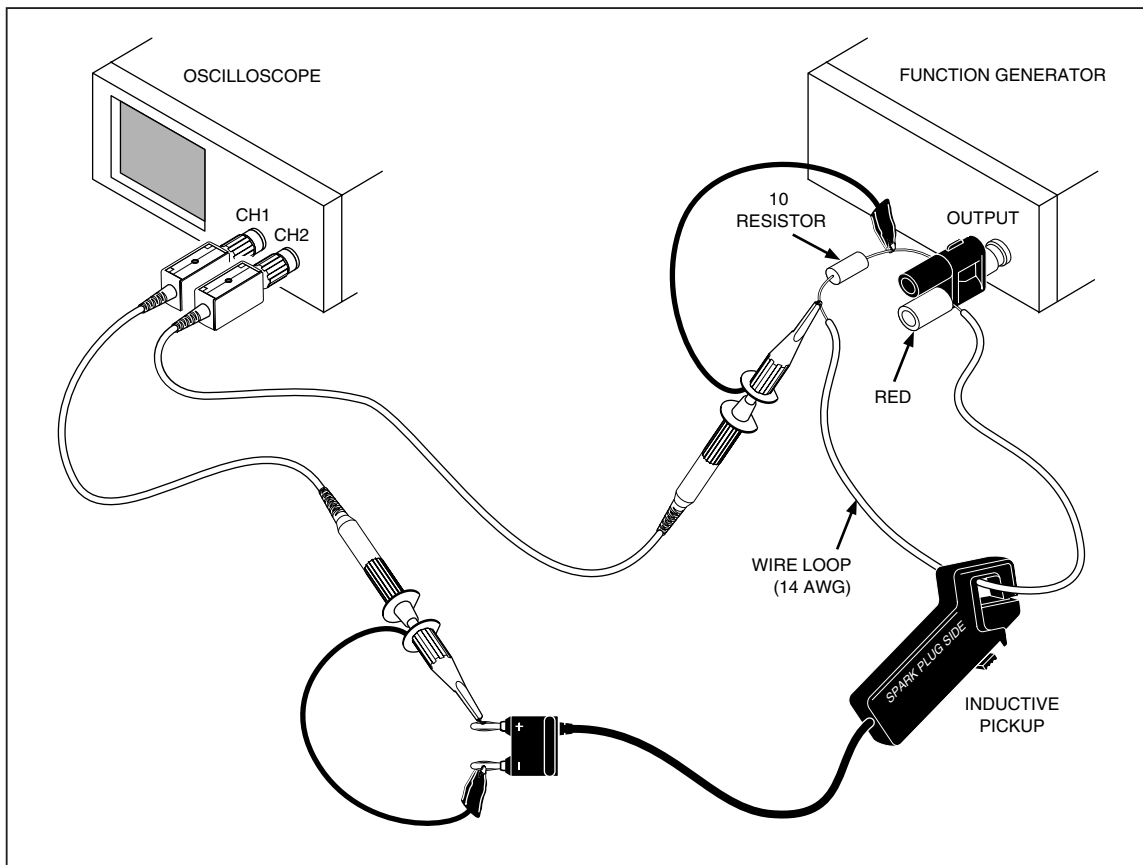

Figure 5. Setup for Inductive Pickup Test

aad08f.eps

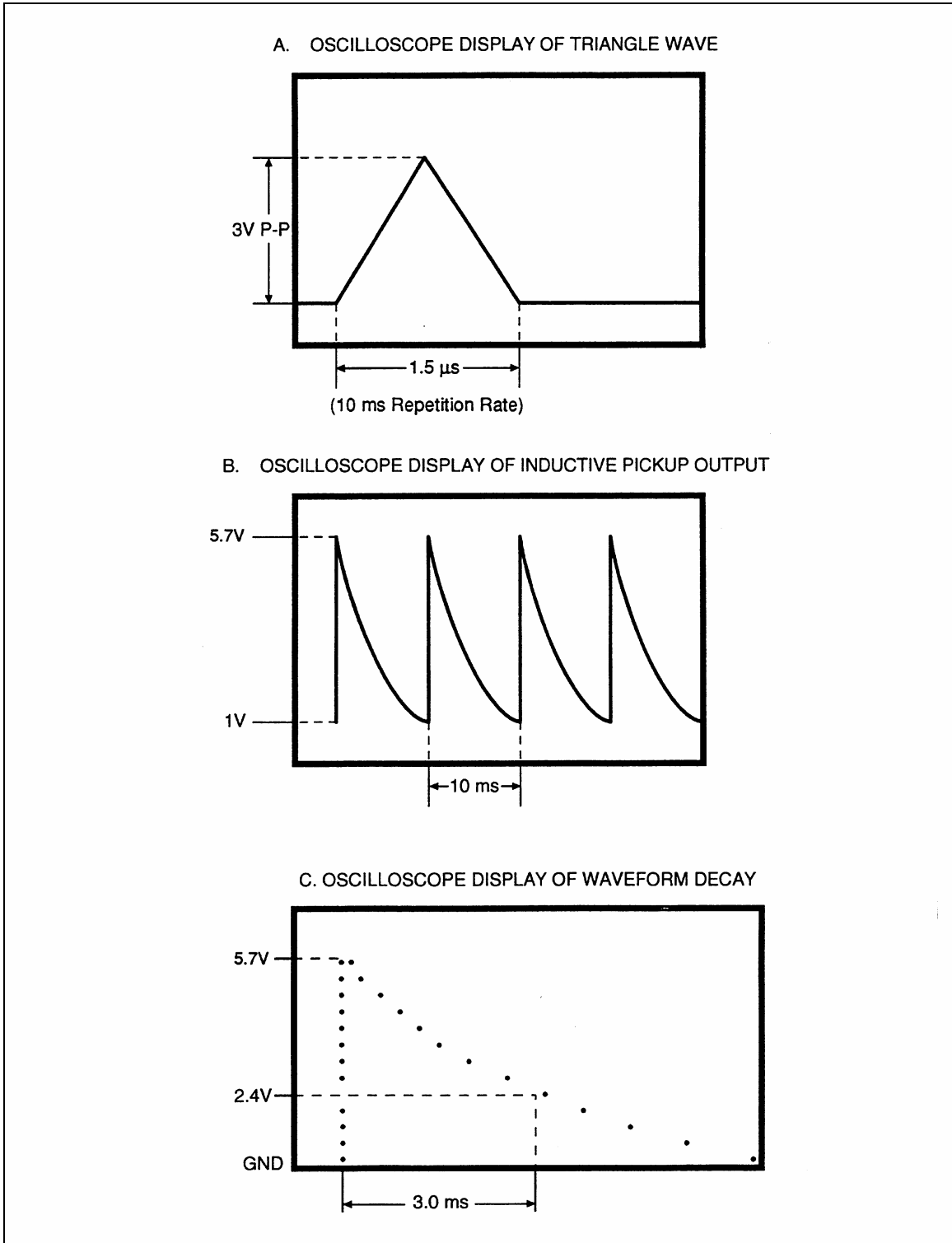

Figure 6. Waveform for Inductive Pickup Test

aad09f.wmf

Calibration Adjustment



The Meter features closed-case calibration adjustment using known reference sources. The Meter measures the applied reference source, calculates correction factors and stores the correction factors in nonvolatile memory.

The following sections present the features and Meter pushbutton functions that can be used during the Calibration Adjustment Procedure. Perform the Calibration Adjustment Procedure should the Meter fail any performance test listed in Table 15.

Calibration Adjustment Counter

The Meter contains a calibration adjustment counter. The counter is incremented each time a Calibration Adjustment Procedure is completed. The value in the counter can be recorded and used to show that no adjustments have been made during a calibration cycle.

Use the following steps to view the Meter's calibration counter.





1. While holding down , turn the rotary knob from **OFF** to **VAC**. The Meter should display “ **CAL**”.
2. Press  once to see the calibration counter. For example "n001".
3. Turn the rotary knob to **OFF**.









Calibration Adjustment Password

To start the Calibration Adjustment Procedure, the correct 4-button password must be entered. The password can be changed or reset to the default as described in following paragraphs. The default password is “1234”.



Changing the Password

Use the following steps to change the Meter's password:

1. While holding down , turn the rotary knob from **OFF** to **VAC**. The Meter displays “ **CAL**”.
2. Press  once to see the calibration counter.
3. Press  again to start the password entry. The Meter displays "????".
4. The Meter buttons represent the digit indicated below when entering or changing the password:

 = 1  = 2  = 3  = 4
 = 5  = 6  = 7  = 8

Press the 4 buttons to enter the old password. If changing the password for the first time, enter  (1)  (2)  (3)  (4).

5. Press  to change the password. The Meter displays "----" if the old password is correct. If the password is not correct, the Meter emits a double beep, displays "?????" and the password must be entered again. Repeat step 4.
6. Press the 4 buttons of the new password.
7. Press  to store the new password.

Restoring the Default Password

If the calibration password is forgotten, the default password (1234) can be restored using the following steps.

1. While holding down **MIN MAX**, turn the rotary knob from **OFF** to **VAC**. The Meter displays “⚡ CAL”.
2. Remove the Meter's top case. Leave the PCA in the bottom case. (See “Opening the Meter Case”.)

⚠ ⚠ Warning

To avoid electrical shock or personal injury, remove the test leads and any input signal before removing the Meter's top case.

3. Through an access hole provided in the top shield, short across the keypads on the PCA. See Figure 7. The Meter should beep. The default password is now restored.
4. Replace the Meter's top case and turn the rotary knob to **OFF**. (See “Reassembling the Meter Case”).

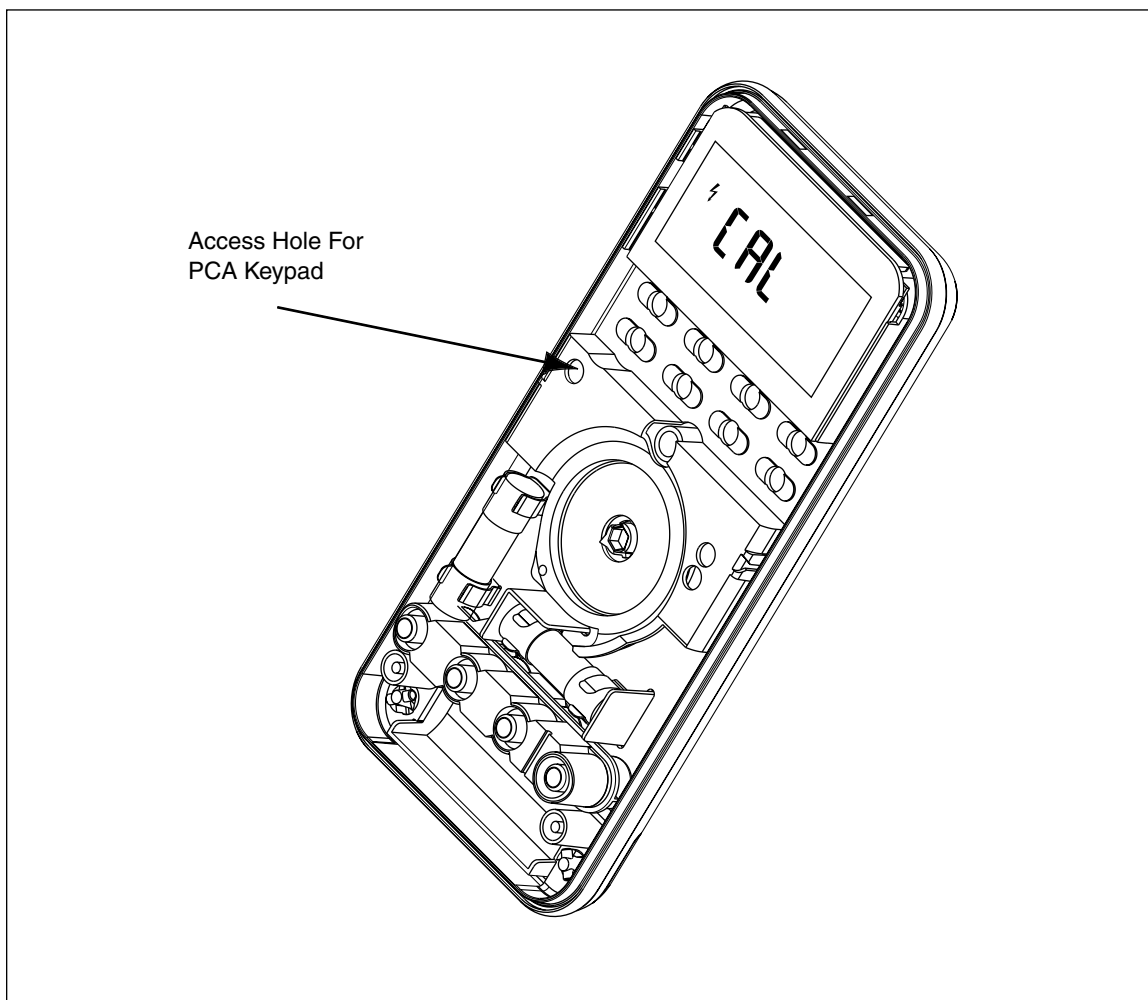





Figure 7. Restoring the Default Password

ama01f.eps





Meter Buttons Used in the Calibration Steps

The Meter buttons behave as follows when performing the Calibration Adjustment Procedure. This may be of help determining why a calibration step is not accepted and for determining the input value without referring to Table 16.

-  Press and hold to show the measured value. The measurement value is not calibrated so it may not match the input value. This is normal.
-  Press and hold to display the required input amplitude.
-  Press and hold to display the frequency of the required input.
-  Press to store the calibration value and advance to the next step. This button is also used to exit calibration mode after the calibration adjustment sequence is complete.

Calibration Adjustment Procedure

Use the following steps to adjust the Meter's calibration. If the Meter is turned off before completion of the adjustment procedure, the calibration constants are not changed.

1. While holding down , turn the rotary knob from **OFF** to **VAC**. The Meter displays “**⚡ CAL**”.
2. Press  once to see the calibration counter.
3. Press  again to start the password entry. The Meter displays "????".
4. Press 4 buttons to enter the password.
5. Press  to go to the first calibration step. The Meter displays "C-01" if the password is correct. If the password is not correct, the Meter emits a double beep, displays "????", and the password must be entered again. Repeat step 4.
6. Using Table 16, apply the input value listed for each calibration adjustment step. For each step, position the rotary switch and apply the input to the terminals as indicated in the table.
7. After each input value is applied, press  to accept the value and proceed to the next step (C-02 and so forth).

Notes

After pressing , wait until the step number advances before changing the calibrator source or turning the Meter rotary knob.

If the Meter rotary knob is not in the correct position, or if the measured value is not within the anticipated range of the input value, the Meter emits a double beep and will not continue to the next step.

Some adjustment steps take longer to execute than others (10 to 15 seconds). For these steps, the Meter will beep when the step is complete. Not all steps have this feature.

8. After the final step, the display shows "End" to indicate that the calibration adjustment is complete. Press  to go to meter mode.

Notes

Set the calibrator to Standby prior to changing the function switch position and or after completing adjustment of each function.

If the calibration adjustment procedure is not completed correctly, the Meter will not operate correctly.

Table 16. Calibration Adjustment Steps

Function (Switch Position)	Input Terminal	Adjustment Step	Input Value	
			Fluke 83-V and 88-V	Fluke 87-V
\tilde{V} (AC Volts)	$V \Omega \rightarrow \vdash$	C-01	600.0 mV, 60 Hz	600.0 mV, 60 Hz
		C-02	600.0 mV, 5 kHz	600.0 mV, 20 kHz
		C-03	6.000 V, 60 Hz	6.000 V, 60 Hz
		C-04	6.000 V, 5 kHz	6.000 V, 20 kHz
		C-05	60.00 V, 60 Hz	60.00 V, 60 Hz
		C-06	60.00 V, 5 kHz	60.00 V, 20 kHz
		C-07	600.0 V, 60 Hz	600.0 V, 60 Hz
		C-08	600.0 V, 5 kHz	600.0 V, 10 kHz
\bar{V} (DC Volts)		C-09	6.000 V	6.000 V
		C-10	60.00 V	60.00 V
		C-11	600.0 V	600.0 V
$m\bar{V}$ (DC Millivolts)	C-12	600.0 mV	600.0 mV	
	C-13	60.00 mV	60.00 mV	
Ω (Ohms)	C-14	600.0	600.0	
	C-15	6.000 k	6.000 k	
	C-16	60.00 k	60.00 k	
	C-17	600.0 k	600.0 k	
	C-18	6.000 M	6.000 M	
	C-19	0.000	0.000	
	C-20	50.0 M	50.0 M	
$\rightarrow \vdash$ (Diode Test)	C-21	3.000 V	3.000 V	
A (Amps)	A	C-22	6.000 A, 60 Hz	6.000 A, 60 Hz
		C-23	6.000 A dc	6.000 A dc
mA (Milliamps)	mA / μA	C-24	60.00 mA, 60 Hz	60.00 mA, 60 Hz
		C-25	400.0 mA, 60 Hz	400.0 mA, 60 Hz
		C-26	60.00 mA dc	60.00 mA dc
		C-27	400.0 mA dc	400.0 mA dc
μA (Microamps)		C-28	600.0 μ A ac, 60 Hz	600.0 μ A ac, 60 Hz
		C-29	6000 μ A, 60 Hz	6000 μ A, 60 Hz
		C-30	600.0 μ A dc	600.0 μ A dc
		C-31	6000 μ A dc	6000 μ A dc

Service and Parts

Replacement parts are shown in Table 17 and Figure 8. To order parts and accessories, refer to “Contacting Fluke”.

Table 17. 80 Series V Final Assembly

Ref Des	Description	Part Number	Qty
AC72	Alligator Clip, Black	1670652	1
AC72	Alligator Clip, Red	1670641	1
BT1	Battery, 9 V	2139179	1
BT2	Cable Assy, 9 V Battery Snap	2064217	1
CR6	Lightpipe	2074057	1
F1△	Fuse, 0.440 A, 1000 V, FAST	943121	1
F2△	Fuse, 11 A, 1000 V, FAST	803293	1
H2-4	Screw, Case	832246	3
H5-9	Screw, Bottom Shield	448456	5
J1-2	Elastomeric Connector	817460	2
J3	Top Shield Contact	674853	1
MP10, MP11	Foot, Non-Skid	824466	2
MP2	Shield, Top	2073906	1
MP4	Shield, Bottom	2074025	1
MP5	Case Top (PAD XFER) With Window (83-5)	2074002	
MP5	Case Top (PAD XFER) with Window (87-5)	2073992	1
MP5	Case Top (PAD XFER) with Window (88-5)	2115202	1
MP6	Case Bottom	2073871	1
MP8	Knob, Switch (PAD XFER)	2100482	1
MP9	Detent, Knob	822643	1
MP13	Shock Absorber	828541	1
MP14	O-Ring, Input Receptacle	831933	1
MP15	Holster w/ Tilt Stand	2074033	1
MP22	Battery Door	2073938	1
MP27- MP30	Contact RSOB	1567683	4
MP31	Mask, LCD (PAD XFER) (83-5)	2073961	1
MP31	Mask, LCD (PAD XFER) (87-5)	2073950	1
MP31	Mask, LCD (PAD XFER) (88-5)	2112410	1
MP41	Housing, RSOB	2073945	1
MP390- 391	Access Door Fastener	948609	2
NA	Tiltstand	2074040	1
S2	Keypad	2105884	1
TL75	Test Lead Set	855742	1
TM1	80 Series V Getting Started Manual (Multi-language)	2101973	1
TM2	80 Series V Quick Reference Card	2101986	1
TM 2	88 V Quick Reference Card	2279006	1
TM3	CD ROM (Contains 80 Series V Users Manual)	2101999	1
TM3	CD ROM (Contains 88 V Users Manual)	2278999	1
TM4 (not shown)	80 Series V Calibration Manual (this manual)	2102915	1
U5	LCD, 4.5 DIGIT, TN, Transflective, Bar Graph, OSPR80	2065213	1
MP81	80BK Thermocouple Assembly, K-Type, Beaded, Molded Dual Banana Plug, Coiled	1273113	1

△ To ensure safety, use exact replacement only.

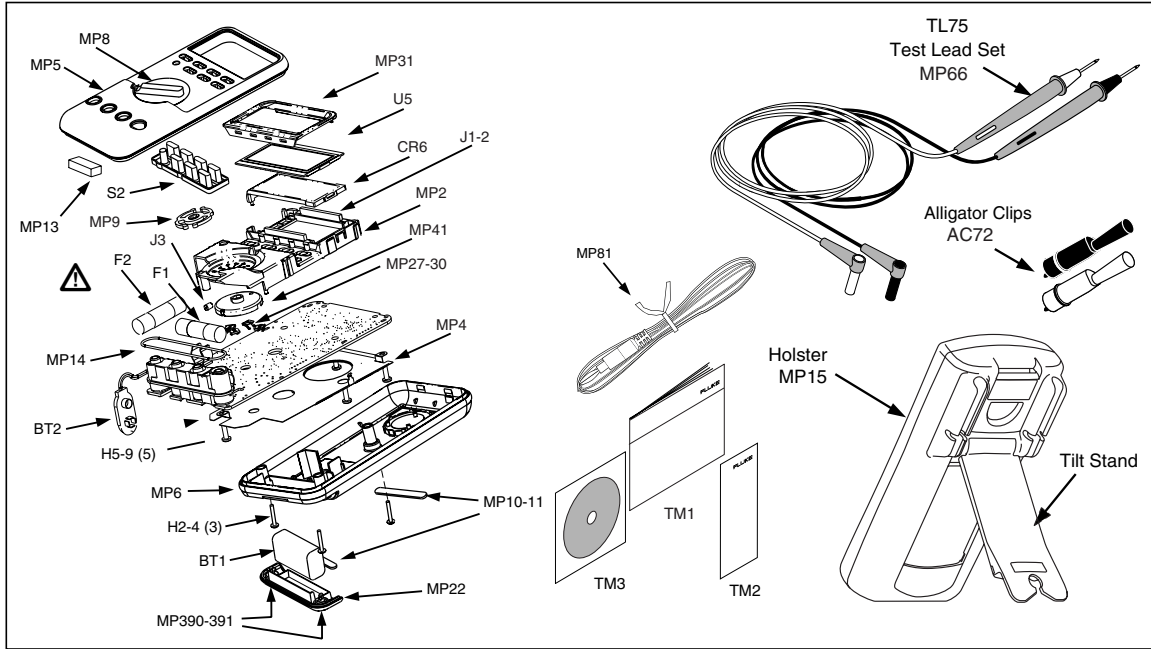

Figure 8. 80 Series V Final Assembly

aom015c.eps