



MicroScanner²TM

Cable Verifier

Users Manual

LIMITED WARRANTY AND LIMITATION OF LIABILITY

Each Fluke Networks product is warranted to be free from defects in material and workmanship under normal use and service. The warranty period for the mainframe is one year and begins on the date of purchase. Parts, accessories, product repairs and services are warranted for 90 days, unless otherwise stated. Ni-Cad, Ni-MH and Li-Ion batteries, cables or other peripherals are all considered parts or accessories. The warranty extends only to the original buyer or end user customer of a Fluke Networks authorized reseller, and does not apply to any product which, in Fluke Networks' opinion, has been misused, abused, altered, neglected, contaminated, or damaged by accident or abnormal conditions of operation or handling. Fluke Networks warrants that software will operate substantially in accordance with its functional specifications for 90 days and that it has been properly recorded on non-defective media. Fluke Networks does not warrant that software will be error free or operate without interruption.

Fluke Networks authorized resellers shall extend this warranty on new and unused products to end-user customers only but have no authority to extend a greater or different warranty on behalf of Fluke Networks. Warranty support is available only if product is purchased through a Fluke Networks authorized sales outlet or Buyer has paid the applicable international price. Fluke Networks reserves the right to invoice Buyer for importation costs of repair/replacement parts when product purchased in one country is submitted for repair in another country.

Fluke Networks warranty obligation is limited, at Fluke Networks option, to refund of the purchase price, free of charge repair, or replacement of a defective product which is returned to a Fluke Networks authorized service center within the warranty period.

To obtain warranty service, contact your nearest Fluke Networks authorized service center to obtain return authorization information, then send the product to that service center, with a description of the difficulty, postage and insurance prepaid (FOB destination). Fluke Networks assumes no risk for damage in transit. Following warranty repair, the product will be returned to Buyer, transportation prepaid (FOB destination). If Fluke Networks determines that failure was caused by neglect, misuse, contamination, alteration, accident or abnormal condition of operation or handling, or normal wear and tear of mechanical components, Fluke Networks will provide an estimate of repair costs and obtain authorization before commencing the work. Following repair, the product will be returned to the Buyer transportation prepaid and the Buyer will be billed for the repair and return transportation charges (FOB Shipping point).

THIS WARRANTY IS BUYER'S SOLE AND EXCLUSIVE REMEDY AND IS IN LIEU OF ALL OTHER WARRANTIES, EXPRESS OR IMPLIED, INCLUDING BUT NOT LIMITED TO ANY IMPLIED WARRANTY OR MERCHANTABILITY OR FITNESS FOR A PARTICULAR PURPOSE. FLUKE NETWORKS SHALL NOT BE LIABLE FOR ANY SPECIAL, INDIRECT, INCIDENTAL OR CONSEQUENTIAL DAMAGES OR LOSSES, INCLUDING LOSS OF DATA, ARISING FROM ANY CAUSE OR THEORY.

Since some countries or states do not allow limitation of the term of an implied warranty, or exclusion or limitation of incidental or consequential damages, the limitations and exclusions of this warranty may not apply to every buyer. If any provision of this Warranty is held invalid or unenforceable by a court or other decision-maker of competent jurisdiction, such holding will not affect the validity or enforceability of any other provision.

4/04

Fluke Networks
PO Box 777
Everett, WA 98206-0777
USA

Table of Contents

Title	Page
Introduction	1
Registration	2
Contacting Fluke Networks	2
Unpacking	3
MicroScanner ² Professional Kit (MS2-KIT)	3
MicroScanner ² Cable Verifier (MS2-100)	3
Safety Information	4
MicroScanner ² Features	6
Display Features	8
Auto Shutoff	9
Changing the Length Units	9
Using the Wiremap Adapter and Remote ID Locators	10
Testing Twisted Pair Cabling	11
Twisted Pair Test Results	12
Open on Twisted Pair Cabling	12
Short on Twisted Pair Cabling	13
Crossed Wires	13
Crossed Pairs	14

MicroScanner² Cable Verifier

Users Manual

Split Pair	15
Telephone Voltages Detected	16
Bridge Tap Detected	17
Ethernet Port Detected	18
Viewing Individual Results	20
Using Multiple Remote ID Locators	22
Connecting to Telephone Networks Wired in Star Topologies	24
Connecting to Telephone Networks Wired in Bus Topologies	26
Testing Coaxial Cabling	28
Coaxial Results	29
Open on Coaxial Cabling	29
Short on Coaxial Cabling	30
Unknown Termination on Coaxial Cabling	30
Detecting Power Over Ethernet	31
Using the Toner	32
Toning in IntelliTone Mode (optional IntelliTone probe required)	32
Analog Toner Mode (optional tone probe required)	35
Using the SmartTone Function	36
Using the IntelliTone Cable Map Function (optional IP200 probe required)	36
Calibrating Length Measurements	38
Setting the NVP to a Specified Value	38
Determining a Cable's Actual NVP	38
Maintenance	39
Cleaning	40
Battery Life, Status, and Replacement	40
Checking the Tester's Version and Serial Number	41
If Something Seems Wrong	41
Options and Accessories	42

Specifications 43

- Environmental Specifications 43
- General Specifications 44
- Test Modes 44
- Performance Specifications 45
- Regulatory Information 46

Appendix A: Diagnosing Wiremap Faults 47

- Open 47
- Split Pair 47
- Reversed Pairs 47
- Crossed Pairs 47
- Short 48

Index 49

List of Figures

Figure	Title	Page
1	High Voltage Display Example	5
2	MicroScanner ² Features	6
3	Display Features	8
4	Connecting a Remote ID Locator in a Confined Area or to an RJ11 Jack.....	10
5	Connecting to Twisted Pair Network Cabling	11
6	Open on Twisted Pair Cabling	12
7	Short on Twisted Pair Cabling	13
8	Crossed Wires	13
9	Crossed Pairs	14
10	Split Pair	15
11	Telephone Voltages Detected	16
12	Bridge Tap Detected	17
13	Ethernet Port Detected	19
14	Results Screens for Individual Wire Pairs	21
15	Using Multiple Remote ID Locators.....	23
16	Connecting to a Telephone Network Wired in a Star Topology.....	25
17	Connecting to a Telephone Network Wired in a Bus Topology.....	27
18	Connecting to Coaxial Cabling	28

MicroScanner² Cable Verifier

Users Manual

19	Coaxial Results	29
20	Open on Coaxial Cabling	29
21	Short on Coaxial Cabling.....	30
22	Unknown Termination on Coaxial Cabling.....	30
23	PoE Display.....	31
24	IntelliTone Toner Mode Display	33
25	Using the Toner in IntelliTone Mode	34
26	Analog Toner Mode Display	35
27	Using the Toner with the IP200 IntelliTone Cable Map Function	37
28	Replacing the Tester's Batteries.....	40

MicroScanner² Cable Verifier

Introduction

The MicroScanner² Cable Verifier is a hand-held test instrument that lets you verify and troubleshoot the wiring of twisted pair and coaxial cables and detect network services.

The tester does the following:

- Measures length up to 1500 ft (457 m) and detects opens and shorts on twisted pair and coaxial cabling.
- Detects split pairs on twisted pair cabling.
- Displays wiremap, cable length, proportional distance to opens, and the remote ID number all on one screen.
- Detects Ethernet ports on twisted pair cabling and reports the port speed.
- Detects PoE (Power over Ethernet) and telephone voltages on twisted pair cabling.
- IntelliTone™ function works with an optional Fluke Networks IntelliTone probe to help you locate and isolate cables behind walls, at patch panels, or in bundles. The analog toner works with standard analog probes and includes the SmartTone™ function for positive identification of cables in bundles.

Registration

Registering your product with Fluke Networks gives you access to valuable information on product updates, troubleshooting tips, and other support services. To register, fill out the online registration form on the Fluke Networks website at www.flukenetworks.com/registration.

Contacting Fluke Networks



www.flukenetworks.com



support@flukenetworks.com



+1-425-446-4519

- Australia: 61 (2) 8850-3333 or 61 (3) 9329 0244
- Beijing: 86 (10) 6512-3435
- Brazil: 11 3044 1277
- Canada: 1-800-363-5853
- Europe: +44-(0)1923 281 300
- Hong Kong: 852 2721-3228
- Japan: 03-3434-0510
- Korea: 82 2 539-6311
- Singapore: +65-6799-5566
- Taiwan: (886) 2-227-83199
- USA: 1-800-283-5853

Visit our website for a complete list of phone numbers.

Unpacking

The tester comes with the accessories listed below. If something is damaged or missing, contact the place of purchase immediately.

MicroScanner² Professional Kit (MS2-KIT)

- MicroScanner² tester with detachable wiremap adapter
- 2 AA alkaline batteries
- ITK200 IntelliTone probe
- 9 V alkaline battery
- Six remote ID adapters (numbers 2 through 7)
- Two shielded patch cords, 8-pin modular plug to 8-pin modular plug (RJ45 to RJ45), 2 m
- Two patch cords, 4-pin modular plug to 4-pin modular plug (RJ11 to RJ11), 15 cm
- Coaxial patch cord, F-connector to F-connector, 75 Ω, with push-on adapters, 1.8 m
- Test lead, 8-pin modular plug (RJ45) to 8 alligator clips
- Wrist strap
- Carrying case
- Folding pouch for accessories

- MicroScanner² Getting Started Guide
- IntelliTone Quick Reference Guide
- CD-ROM with MicroScanner² manuals
- CD-ROM with IntelliTone manuals





MicroScanner² Cable Verifier (MS2-100)

- MicroScanner² tester with detachable wiremap adapter
- 2 AA alkaline batteries
- Carrying pouch
- MicroScanner² Getting Started Guide
- CD-ROM with MicroScanner² manuals

Safety Information

Table 1 describes the international electrical symbols used on the tester and in this manual.

Table 1. International Electrical Symbols

	Warning or Caution: risk of damage or destruction to equipment or software. See explanations in the manual. On the tester's display this symbol indicates a cable fault or voltage on the cable.
	Warning: Risk of electric shock.
	This equipment not for connection to public communications networks, such as active telephone systems.
	Do not put products containing circuit boards into the garbage. Dispose of circuits boards in accordance with local regulations.

Warning

To avoid possible fire, electric shock, or personal injury:

- Do not open the case; no user-serviceable parts are inside.
- Do not modify the tester.
- Do not use the tester if it is damaged. Inspect the tester before use.
- If this equipment is used in a manner not specified by the manufacturer, the protection provided by the equipment may be impaired.
- The tester is not intended to be connected to active telephone inputs, systems, or equipment, including ISDN devices. Prolonged exposure to the voltages applied by these interfaces may damage the tester. The tester shows a warning symbol () and the voltage polarities when it detects high voltage. Figures 1 and 11 show examples of this display.

- Before using the optional IntelliTone probe, read the safety information in the probe's documentation provided on the IntelliTone manuals CD.
- Do not use the tester if it operates abnormally. Protection may be impaired.

⚠ Caution

To ensure maximum accuracy of test results replace the batteries as soon as the low battery indicator appears (see "Battery Life, Status, and Replacement" on page 40).

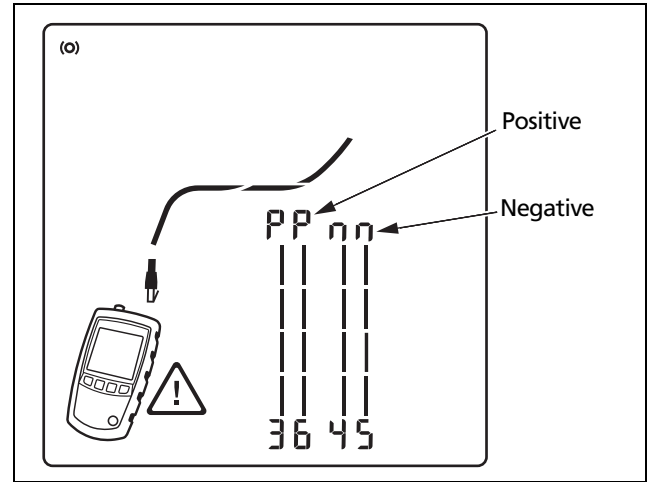

Figure 1. High Voltage Display Example

MicroScanner² Features

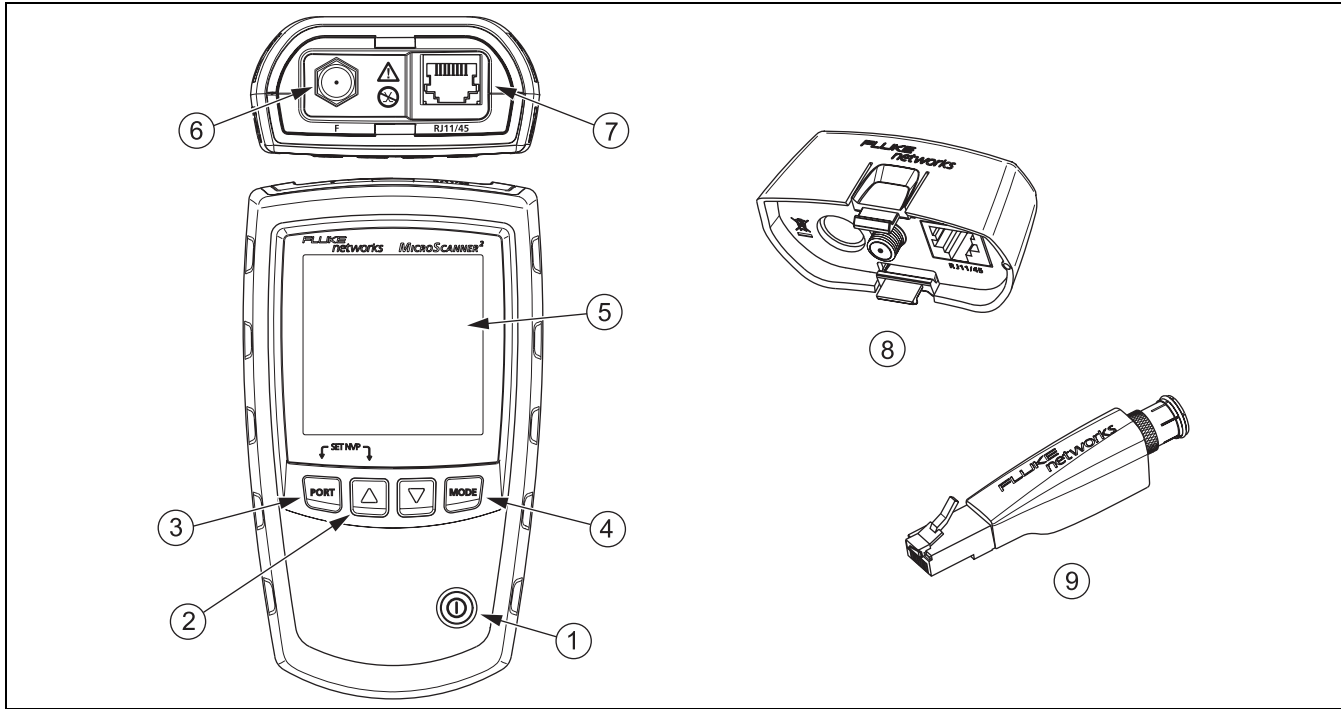









Figure 2. MicroScanner² Features

egk01.eps



- ① On/off key.
- ② , : Navigates through screens and changes settings. In toner mode, these keys cycle through the IntelliTone and analog toner songs.
- ③ : Selects the RJ45 or coaxial connector as the active port.
- ④ : Cycles through the cable test, toner, and PoE detect modes.
- ⑤ LCD display with backlight.
- ⑥ F-connector for connecting to 75 Ω coaxial cable.
- ⑦ Modular jack for connecting to telephone and twisted pair network cable. The jack accepts 8-pin modular (RJ45) and 6-pin modular (RJ11) connectors.
- ⑧ Wiremap adapter with F-connector and 8-pin modular jack. See page 10.
- ⑨ Optional remote ID locator with F-connector and 8-pin modular jack. See page 10.

For additional modes, hold down keys while turning the tester on:

-  + : Lets you calibrate length measurements and select meters or feet as the length unit.
-  + : Activates a demonstration mode where the tester shows examples of test result screens.

Note

Auto shutoff is disabled in demonstration mode.

-  + : Displays the version and serial number screens.

Display Features

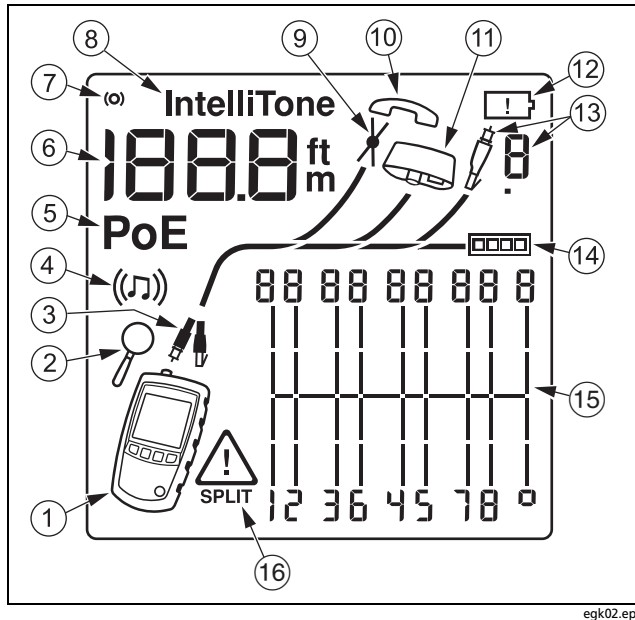



Figure 3. Display Features

- ① Tester icon
- ② Detail screen indicator. See page 20.
- ③ Indicates which port is active, the RJ45 port (📶) or the coaxial port (📡).
- ④ Tone mode indicator. See page 32.
- ⑤ Power over Ethernet mode indicator. See page 31.
- ⑥ Numeric display with feet/meters indicator.
- ⑦ Test activity indicator, which is animated when a test is running.
- ⑧ IntelliTone appears when the toner is in IntelliTone mode. See pages 32 and 36.
- ⑨ Indicates a short on the cable. See pages 13 and 30.
- ⑩ Telephone voltage indicator. See page 16.
- ⑪ Indicates a wiremap adapter is connected to the far end of the cable.
- ⑫ Low battery indicator. See page 40.
- ⑬ Indicates an ID locator is connected to the far end of the cable and shows the locator's number.
- ⑭ Ethernet port indicator. See page 18.

- ⑮ Wiremap diagram. For opens, the number of segments lit for the wire pair indicates the approximate distance to the fault. The rightmost segments indicate the shield. See pages 12 through 15.
- ⑯ The  Indicates a fault or high voltage on the cable. **SPLIT** appears when the fault is a split pair. See page 15.



Auto Shutoff

The tester turns off after 10 minutes if no keys are pressed and nothing changes at the tester's connectors.

Note

Auto shutoff is disabled in toner and demonstration modes.

Changing the Length Units

- 1 Hold down  and  while turning on the tester.
- 2 Press  to switch between meters and feet.
- 3 Turn the tester off then on to return to testing mode.

Using the Wiremap Adapter and Remote ID Locators

Terminating twisted pair cabling with the standard wiremap adapter or optional remote ID locators lets the tester detect all types of wiremap faults. Without this termination, the tester cannot detect crossed wires or crossed pairs. For a wire pair with one wire open, termination is required to detect which wire is open. Without termination, the tester shows both wires as open.

Using multiple remote ID locators helps you identify connections at patch panels. The tester shows the number of the locator connected to the far end of the cabling, as shown on page 23.

To connect a remote ID locator to a modular (RJ) jack in a confined area or to a 4-pin modular jack (RJ11), use the optional universal adapter and a patch cord, as shown in Figure 4.

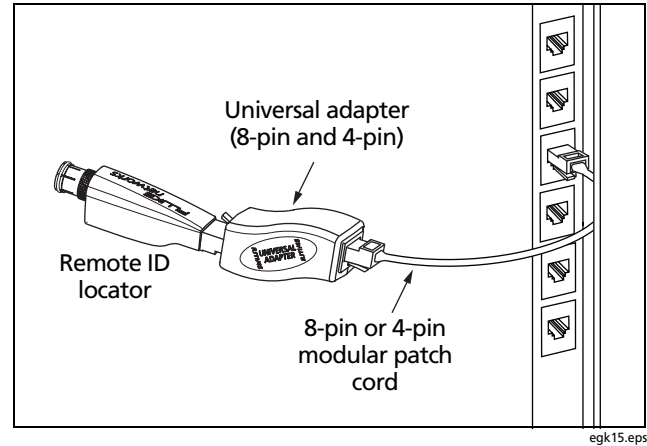

Figure 4. Connecting a Remote ID Locator in a Confined Area or to an RJ11 Jack

Testing Twisted Pair Cabling

- 1 Turn on the tester.

If the tester is already on and in coaxial test mode (🔌), press **PORT** to switch to twisted pair test mode (🔌).

- 2 Connect the tester and wiremap adapter or ID locator to the cabling as shown in Figures 5 through 17.

The test runs continuously until you change modes or turn the tester off.

Notes

You can measure length without connecting a far end adapter; however, an adapter is required for a complete wiremap test.

*If the **PoE** indicator appears, see page 31.*

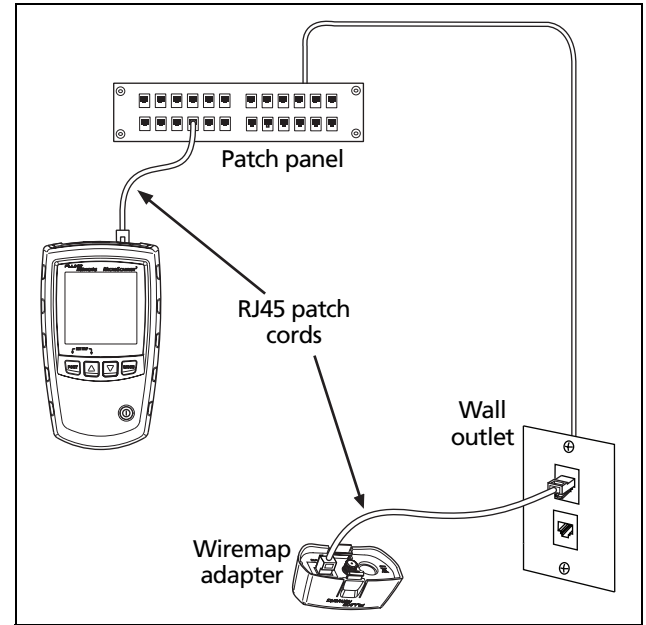

egk03.eps

Figure 5. Connecting to Twisted Pair Network Cabling

Twisted Pair Test Results

The following figures show typical test results for twisted pair cabling.

Open on Twisted Pair Cabling

Figure 6 shows an open on wire 4.

Notes

If only one wire in a pair is open and a wiremap adapter or remote ID locator is not connected, both wires are shown as open.

The warning icon (⚠) does not appear if both wires in a pair are open because open pairs are normal for some cabling applications.

The three segments shown for the wire pair length indicate the open is approximately 3/4 the distance to the end of the cabling. The cable length is 75.4 m.

To see the distance to the open, use or to view the individual result for the wire pair. See page 20.

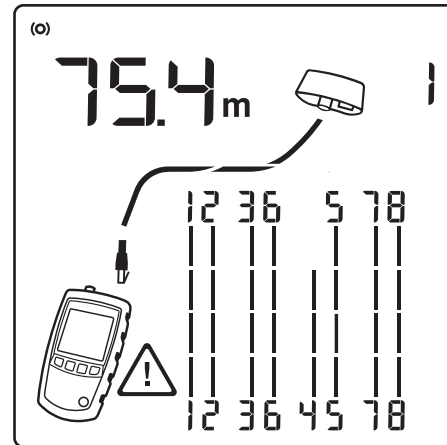

Figure 6. Open on Twisted Pair Cabling

egk05.eps

Short on Twisted Pair Cabling

Figure 7 shows a short between wires 5 and 6. The shorted wires flash to indicate the fault. The cable length is 75.4 m.

Note

When there is a short, the far-end adapter and the mapping of the unshorted wires are not shown.

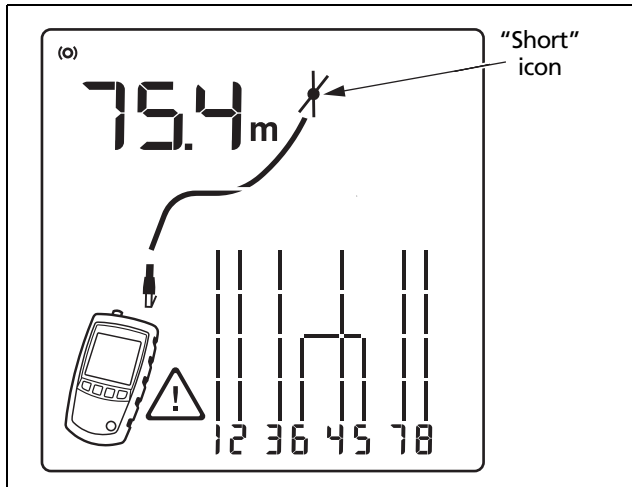

Figure 7. Short on Twisted Pair Cabling

Crossed Wires

Figure 8 shows that wires 3 and 4 are crossed. The the pin numbers flash to indicate the fault. Cable length is 53.9 m. The cable is shielded.

Detection of crossed wires requires a far-end adapter.

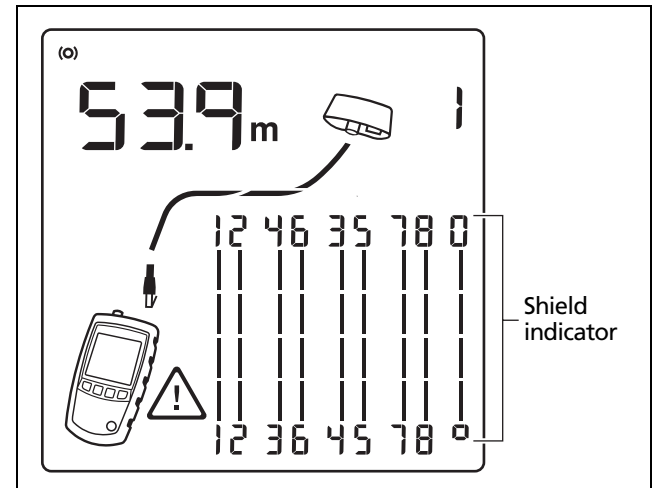

Figure 8. Crossed Wires

Crossed Pairs

Figure 9 shows that pairs 1,2 and 3,6 are crossed. The pin numbers flash to indicate the fault. This crossed pair is likely caused by mixing 568A and 568B cabling.

Detection of crossed pairs requires a far-end adapter.

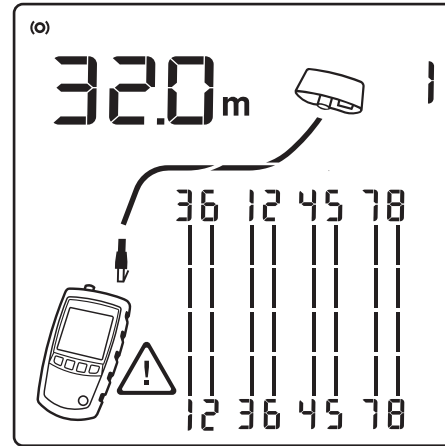

Figure 9. Crossed Pairs

egk09.eps

Split Pair

Figure 10 shows a split pair on 3,6 and 4,5. The split pair flashes to indicate the fault. The cable length is 75.4 m.

In a split pair, continuity from end to end is correct, but is made with wires from different pairs. Split pairs cause excessive crosstalk that interferes with network operation.

Note

Cables with untwisted pairs, such as telephone cords, typically show split pairs due to excessive crosstalk.

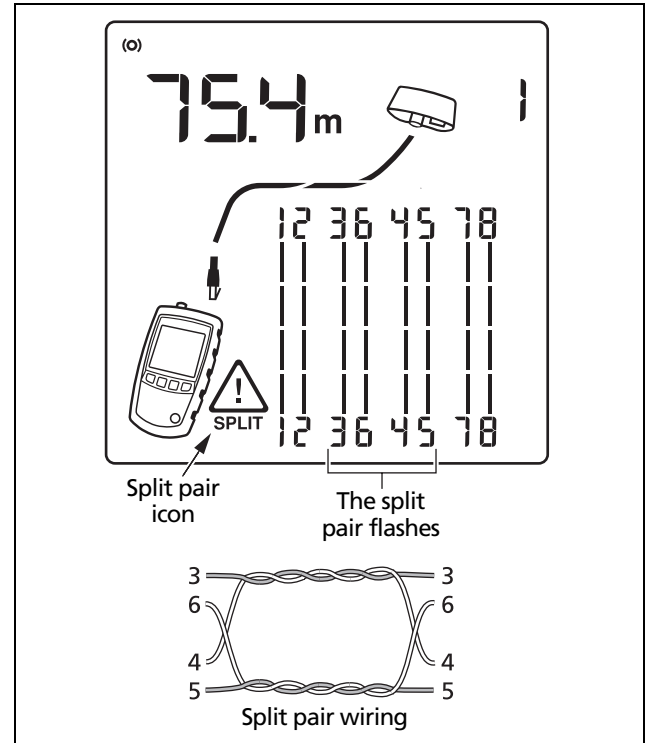

egk10.eps

Figure 10. Split Pair

Telephone Voltages Detected

Figure 11 shows that telephone voltage is detected on pair 4,5.

Length is not shown because the voltage interferes with length measurements.



The tester is not intended to be connected to active telephone inputs, systems, or equipment, including ISDN devices. Prolonged exposure to the voltages applied by these interfaces may damage the tester.

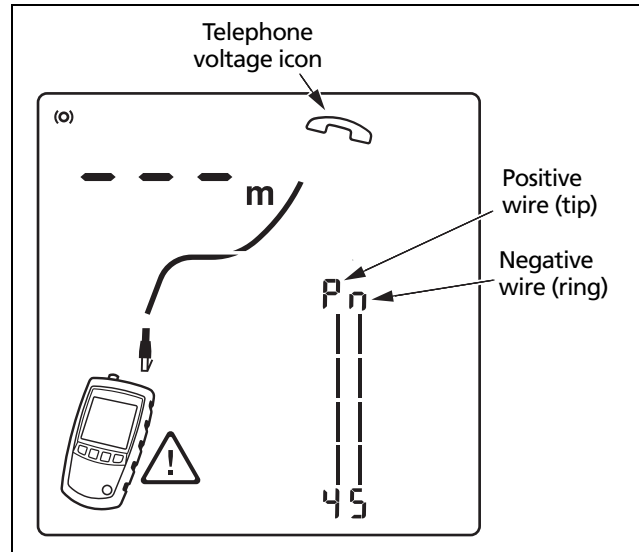

Figure 11. Telephone Voltages Detected

Bridge Tap Detected

Figure 12 shows a bridge tap detected at about 53.2 m. Only the first bridge tap detected is reported. The distance to a bridge tap is approximate because multiple reflections from the bridge tap interfere with length measurements.

Note

Bridge taps more than 328 ft (100 m) from the tester or taps less than 16 ft (5 m) long may not be detected.

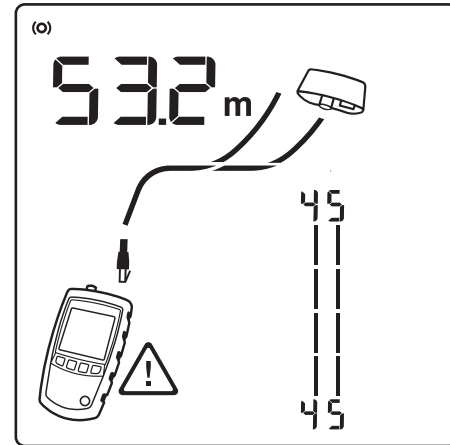

Figure 12. Bridge Tap Detected

egk12.eps

Ethernet Port Detected

The tester can detect active and inactive Ethernet ports, as shown in Figure 13.

- ① Ethernet port icon.
- ② Port speed for an active 1000 megabit port. The speeds are 10, 100, or 1000 megabits per second. The example shows 1000 megabits per second. If the port supports multiple speeds the number cycles through the speeds.

- ③ Cable length. Dashes are shown if the tester cannot measure the length. This can occur if the port does not produce reflections.

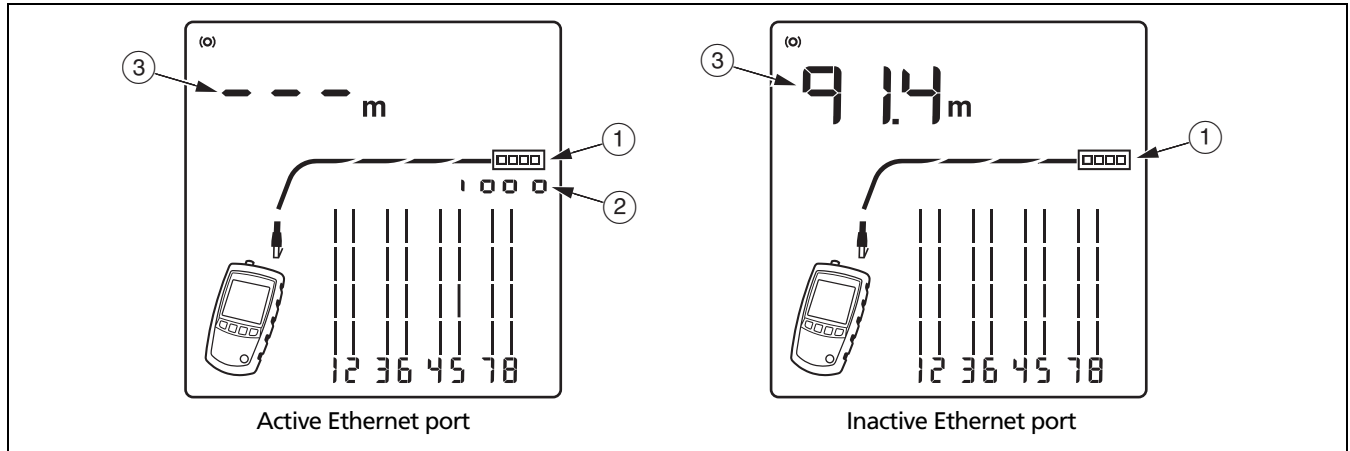

Length may fluctuate or be obviously too high if the port's impedance fluctuates or varies from the cable's impedance. When in doubt, disconnect the cable from the port to get an accurate length measurement.



egk13.eps

Figure 13. Ethernet Port Detected

Viewing Individual Results

To see individual results for each wire pair, use  or ; to move among the screens.

In this mode, the tester continuously tests only the wire pair you are viewing.

Figure 14 shows examples of these screens.

- ① Short on pair 1,2 at 29.8 m.

Notes

On the individual results screens, shorts are shown only when they are between wires in a pair.

When there is a short, the far-end adapter and the mapping of the unshorted wires are not shown.

- ② Pair 3,6 is 67.7 m long and is terminated with the wiremap adapter.
- ③ Open on pair 4,5 at 48.1 m. The open could be on one or both wires.

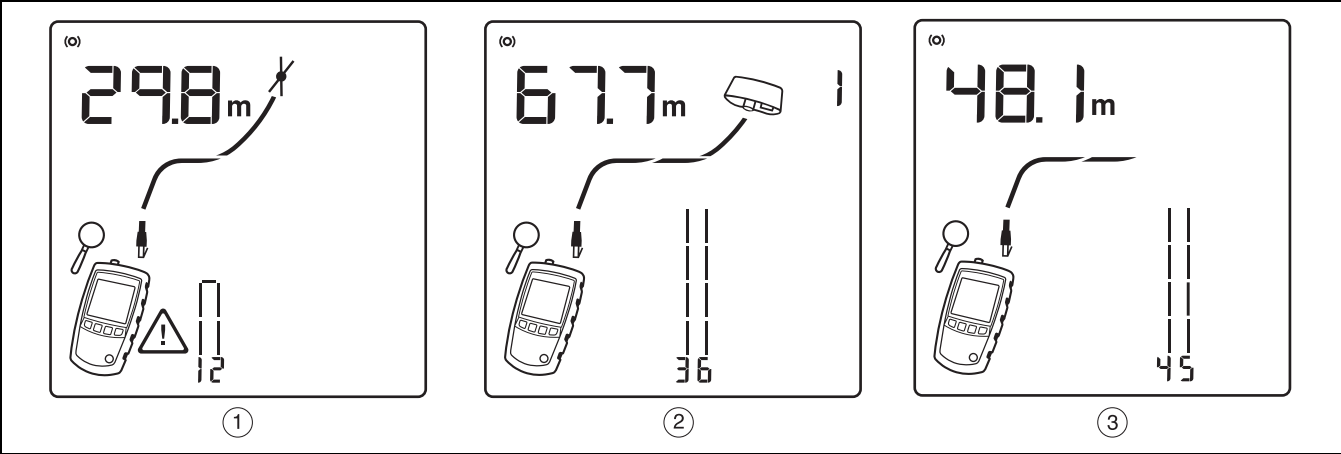

egk14.eps

Figure 14. Results Screens for Individual Wire Pairs

Using Multiple Remote ID Locators

Using multiple remote ID locators helps you identify multiple network connections at a patch panel, as shown in Figure 15.

The display in Figure 15 shows that the tester is connected to the cable terminated with remote ID locator number 3.

Caution

Do not use multiple far end adapters in star or bus topologies. Doing so causes incorrect wiremap results.

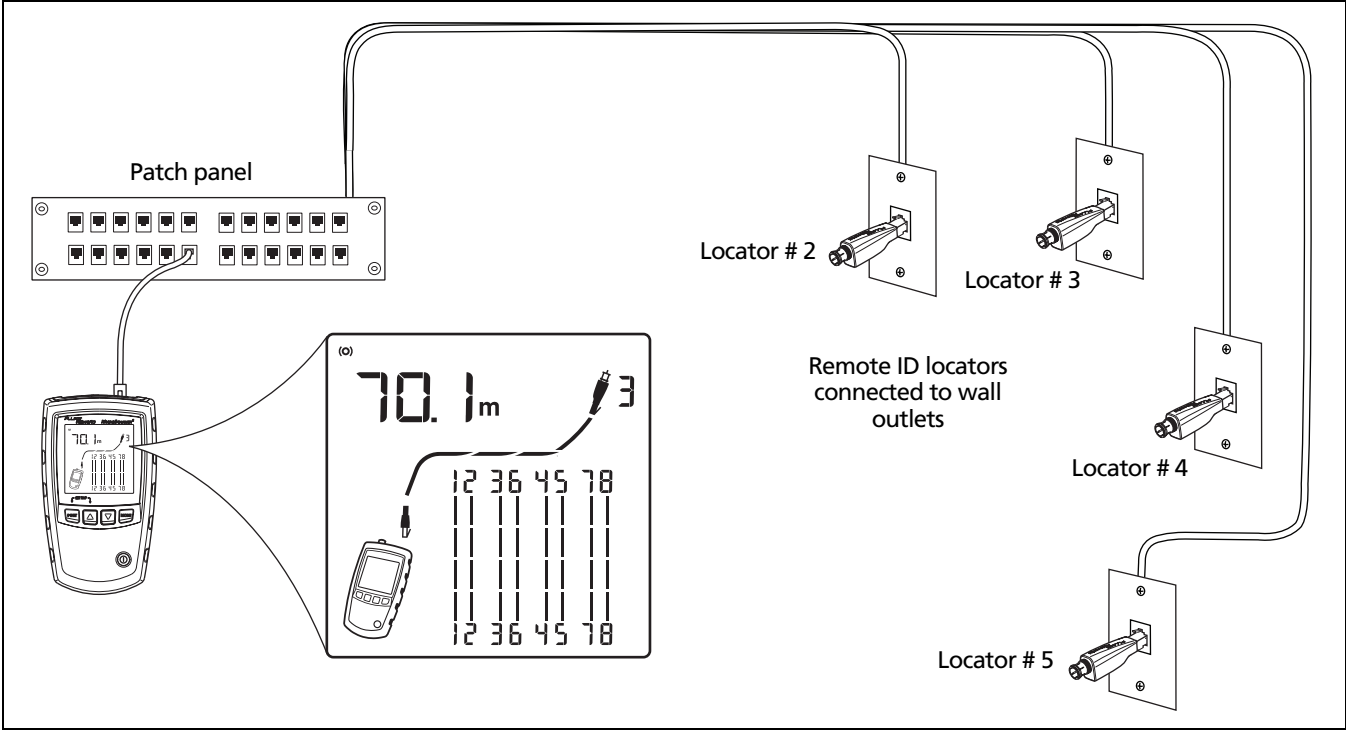

egk04.eps

Figure 15. Using Multiple Remote ID Locators

Connecting to Telephone Networks Wired in Star Topologies

Telephone cables wired in a star topology (Figure 16) are connected together at a bridge tap at the distribution center. The bridge tap connects each wire to all other wires of the same number.

The tester detects bridge taps and measures the distance to the bridge tap. To measure the length of each cable connected to the bridge tap, connect the wiremap adapter or remote ID locator to the bridge tap and the tester to the wall outlet.

The tester cannot measure length past the bridge tap because reflections from the bridge tap connections interfere with measurements.

If you connect the tester to the bridge tap, the tester measures the length only to the bridge tap, which is only the patch cord length.

Caution

Do not use multiple far end adapters in star or bus topologies. Doing so causes incorrect wiremap results.

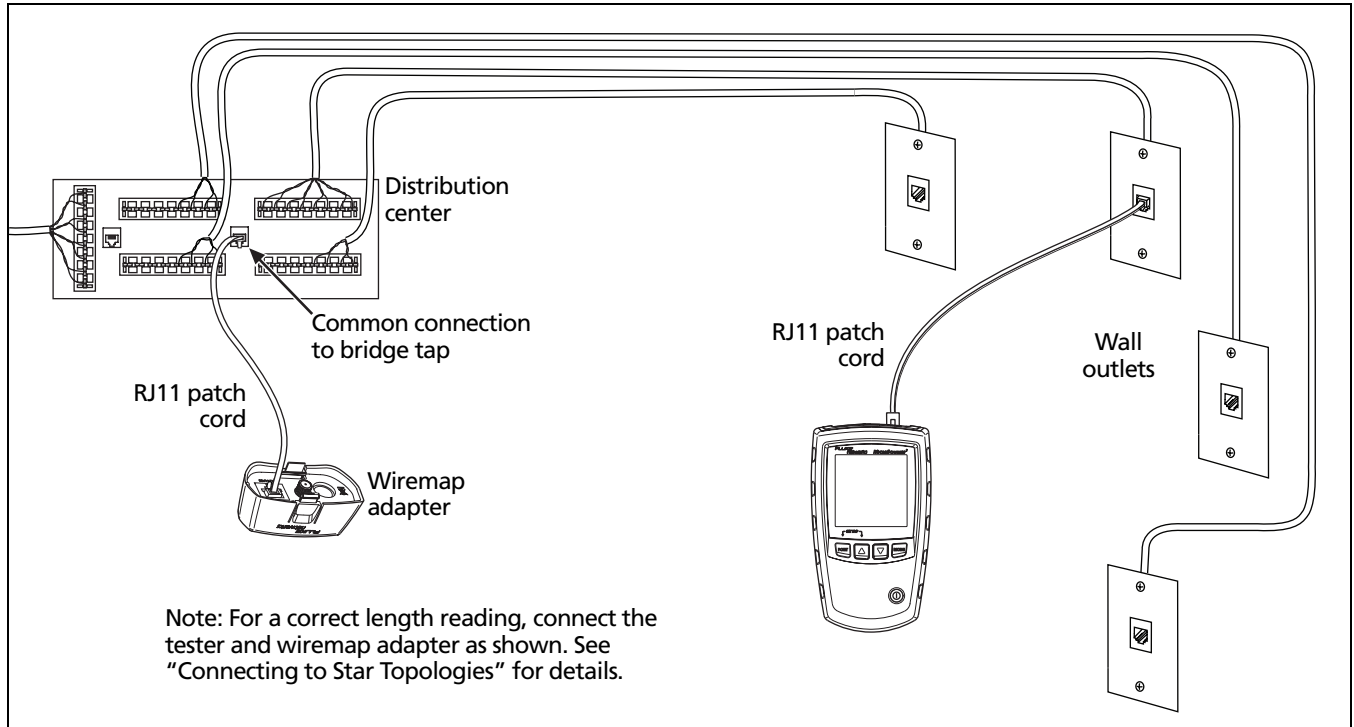

egk16.eps

Figure 16. Connecting to a Telephone Network Wired in a Star Topology

Connecting to Telephone Networks Wired in Bus Topologies

Telephone cables wired in a bus topology (Figure 17) connect the wall outlets in series. In this topology, you measure the length from the last outlet to the wiremap adapter.

If you connect to an outlet in the middle of the series, the tester reports a bridge tap. The length reported is the length to the outlet, which is the patch cord length. The tester cannot measure length past the outlet because reflections from the cables on either side interfere with measurements.

If you are unsure which outlet is the last in the bus, do the following:

- 1 Connect the wiremap adapter or ID locator to the beginning of the bus at the distribution center.
- 2 Connect the tester to an outlet and run the twisted pair cable test.

If the tester reports a bridge tap, move to another outlet. The last outlet will not show a bridge tap, and will show the length to the distribution center.

Caution

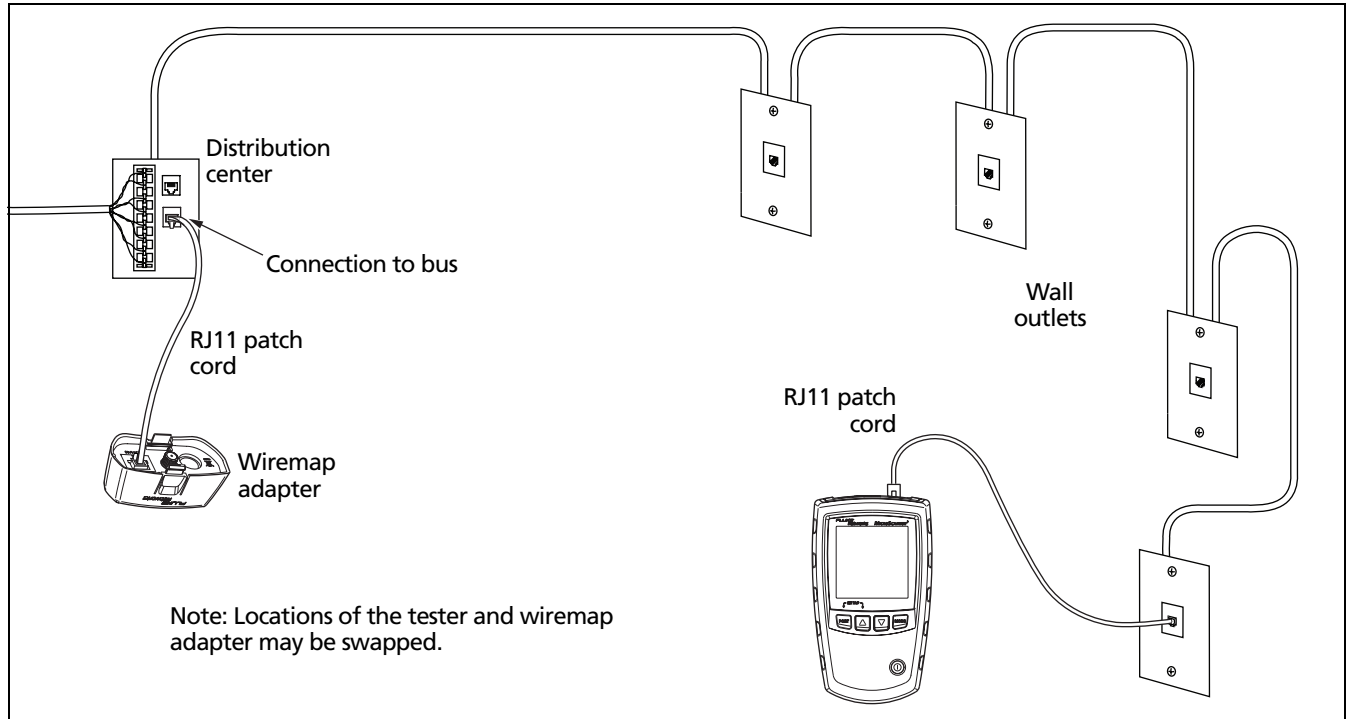

Do not use multiple far end adapters in star or bus topologies. Doing so causes incorrect wiremap results.



egk17.eps

Figure 17. Connecting to a Telephone Network Wired in a Bus Topology

Testing Coaxial Cabling

- 1 Turn on the tester; then press  to switch to coaxial test mode ().
- 2 Connect the tester and wiremap adapter or ID locator to the cabling as shown in Figure 18.

For cabling not terminated with an F-connector, use an adapter or hybrid patch cord to connect to the cabling.

The test runs continuously until you change modes or turn the tester off.

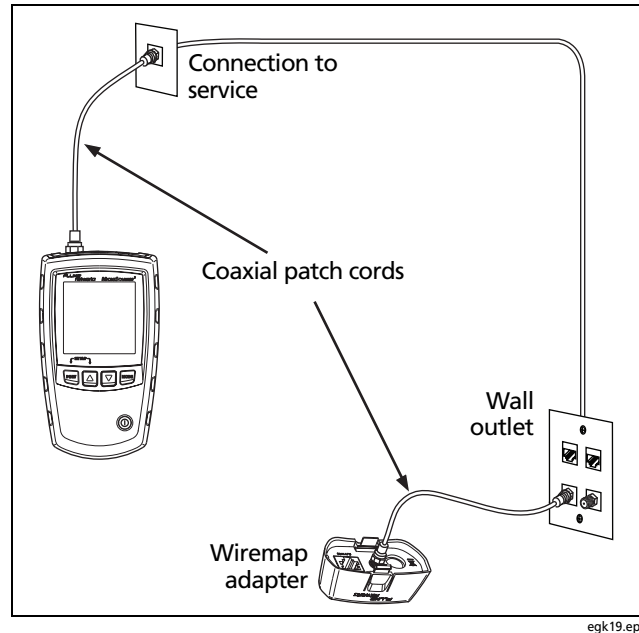

Figure 18. Connecting to Coaxial Cabling

Coaxial Results

Figure 19 shows a good coaxial cable 38.4 m long and terminated with remote ID number 3.

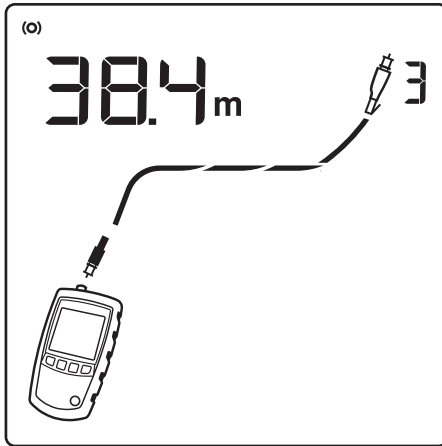

Figure 19. Coaxial Results

egk20.eps

Open on Coaxial Cabling

Figure 20 shows an open 12.1 m from the tester.

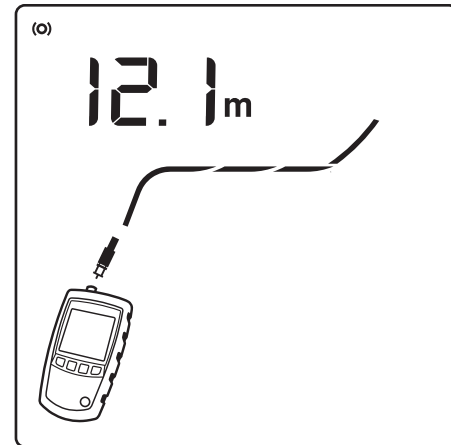

Figure 20. Open on Coaxial Cabling

egk21.eps

Short on Coaxial Cabling

Figure 21 shows a short 12.1 m from the tester.

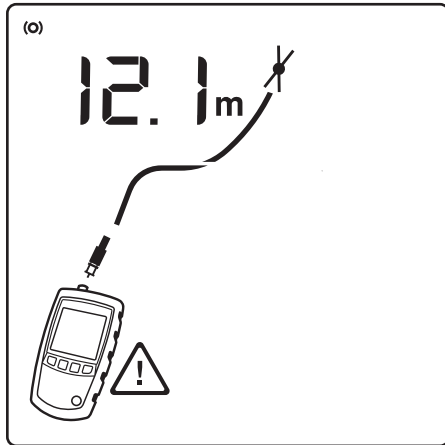

Figure 21. Short on Coaxial Cabling

egk22.eps

Unknown Termination on Coaxial Cabling

Figure 22 shows a cable connected to a device at the far end, such as a television, CATV service, VCR, DVD player, satellite dish, splitter, or antenna. Dashes shown for length mean the tester cannot measure length because the device does not produce reflections.

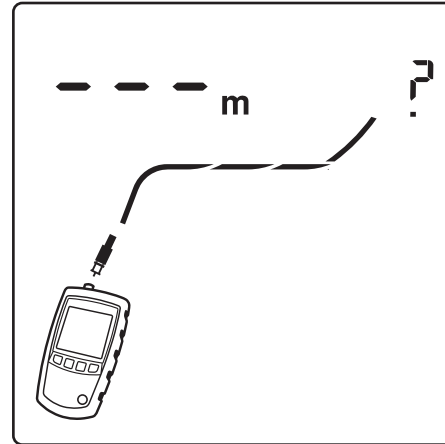

Figure 22. Unknown Termination on Coaxial Cabling

egk23.eps

Detecting Power Over Ethernet

The tester can detect PoE voltage from 802.3af sources.

To select PoE mode, press **MODE** until **PoE** appears on the display, as shown in Figure 23 (1).

In PoE mode, the tester solicits PoE power on pairs 1,2-3,6 and 4,5-7,8. The tester may activate a PoE source and will not be damaged by PoE power.

If PoE power is detected, **PoE** appears above the powered pairs (2). The **PoE** may blink as the PoE source turns the power on and off.

In twisted pair test mode, a flashing **PoE** mode indicator means that PoE power may be available. To verify the presence of a PoE source, switch the tester to PoE mode.

Note

The tester will not detect PoE schemes that are not compliant with the IEEE 802.3af standard, such as Cisco® Inline Power.

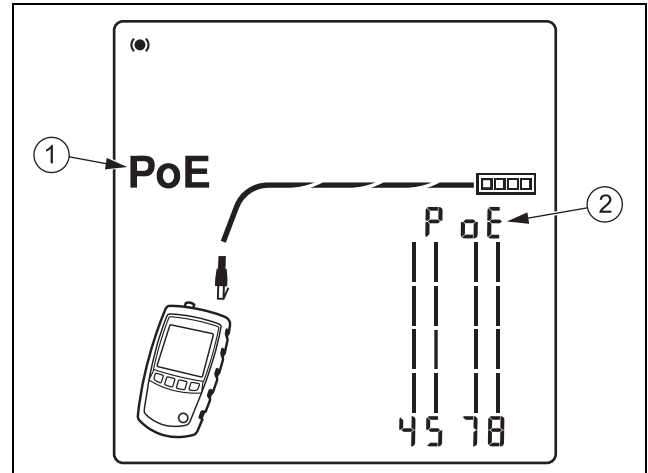

egk30.eps

Figure 23. PoE Display

Using the Toner

You can use the tester with an optional tone probe to locate cables in bundles, at patch panels, or behind walls.





Use the tester's IntelliTone™ mode with an optional Fluke Networks IP100 or IP200 tone probe. The digital IntelliTone signal is easier to detect at a distance than analog tones, and its frequency and encoding eliminate cable misidentification due to signal bleed and radiated or ambient noise.



The tester's analog tone mode is compatible with most tone probes.



The analog tone mode features the SmartTone™ function for positive identification of cables in bundles.

Toning in IntelliTone Mode (optional IntelliTone probe required)

Refer to Figures 24 and 25.

- 1 Connect the tester to the cable.
- 2 Press  to select twisted pair  or coaxial  cable.
- 3 Press  until , **IntelliTone**, and a scrolling pattern of 1s and 0s appear on the display (①, ②, and ③ in Figure 24).

- 4 To toggle between the two IntelliTone songs press  then . The display shows the song number (④).

If you press  or  repeatedly, the tester cycles through the IntelliTone and analog songs.

- 5 Turn the probe's rotary switch to  (locate).
- 6 Use the probe to find the general location of the tone at a cable rack, patch panel, or behind a wall, as shown in Figure 25. The **SYNC** LED lights up green when the probe is receiving the IntelliTone signal.

The probe's LEDs light up from 1 to 8 as the signal strength increases. The higher the number, the stronger the signal.

Notes

If you cannot locate the IntelliTone signal on 2-conductor cables, the cable may be shorted. Use the tester to check for shorts. See pages 11 and 13.

- 7 Turn the probe's rotary switch to  (isolate).
- 8 Use the probe to isolate the tone source in the cable bundle or at the patch panel. The **SYNC** LED lights up green when the probe is receiving the IntelliTone signal.

The probe's LEDs light up from 1 to 8 as the signal strength increases. The higher the number, the stronger the signal.

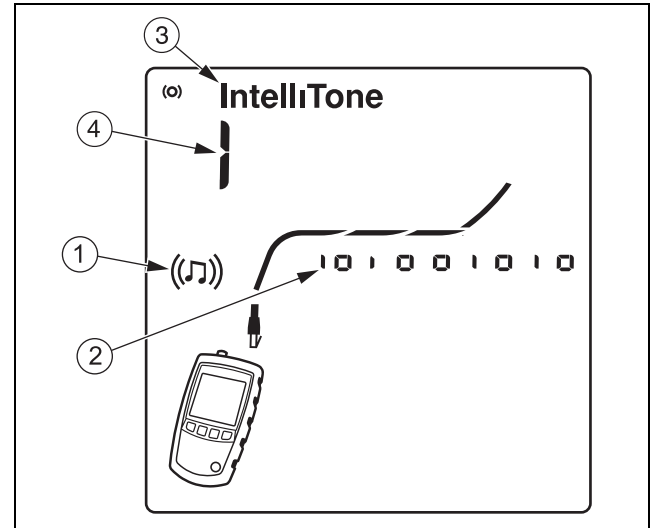

Figure 24. IntelliTone Toner Mode Display

egk07.eps

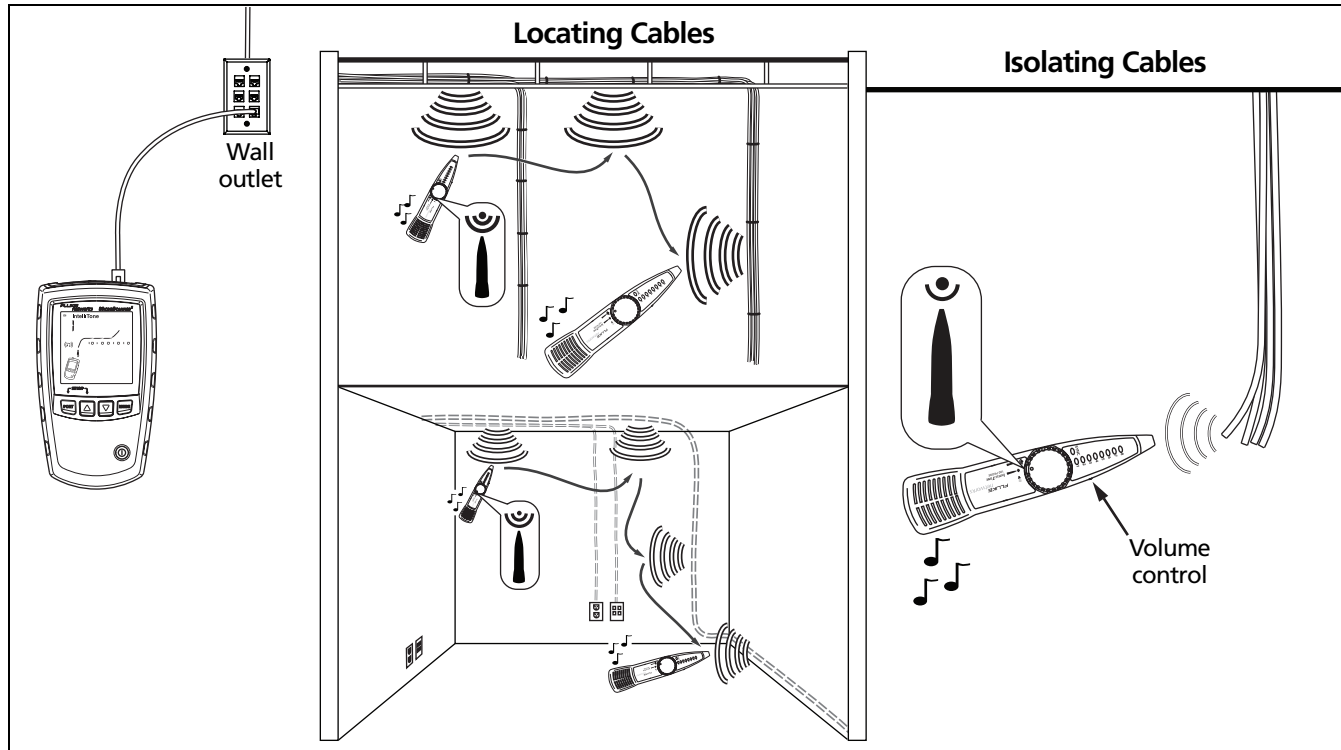

Figure 25. Using the Toner in IntelliTone Mode

egk24.eps

Analog Toner Mode (optional tone probe required)

Refer to Figure 26.

- 1 Connect the tester to the cable.
- 2 Press **PORT** to select twisted pair or coaxial cable.
- 3 Press **MODE** until **((J))** appears on the display (1); then press **▽** to enter analog toner mode. The display shows a scrolling sinewave in analog toner mode (2).
- 4 To change songs, press **▽**. The display shows the song number (3). The analog toner has four songs.

If you press **▽** or **△** repeatedly, the tester cycles through the analog and IntelliTone songs.

- 5 Use the probe to search for the cable.

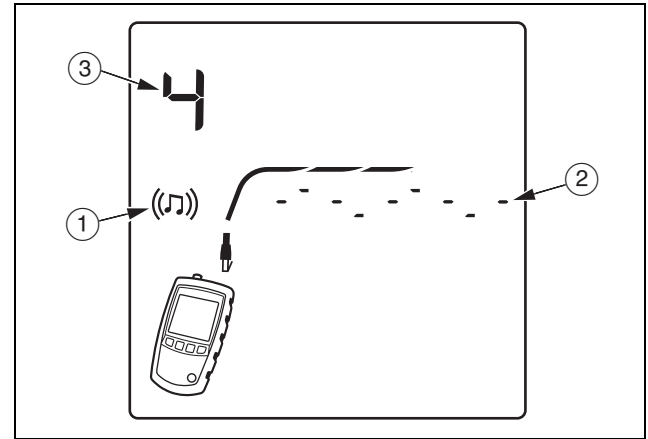

egk25.eps

Figure 26. Analog Toner Mode Display

Using the SmartTone Function

Use the SmartTone™ function when you have trouble locating a cable. This function changes the toner's song when you short a wire pair in the cable connected to the tester. SmartTone works with the IntelliTone probe and with analog probes.

Note

Use the SmartTone function only on dry pairs of wires that are unterminated at both ends. Do not use this function on powered wires.

- 1 Press **PORT** to select twisted pair or coaxial cabling.
- 2 Press **MODE** until ((JJ)) appears on the display.
- 3 Press **▽** to select the analog toner mode (**IntelliTone** disappears from the display).
- 4 At the far end of the cabling, place the probe near the ends of the cables.
- 5 Momentarily short a wire pair in a cable (twisted pair) or short the conductor and shield in a cable (coaxial). If the song changes when you release the short, you have found the cable connected to the tester.

Using the IntelliTone Cable Map Function (optional IP200 probe required)

The tester's IntelliTone function works with an optional IP200 probe's cable map function to verify wiring at the far end of the cabling. The probe's cable map function identifies the most common wiring faults on twisted pair cabling: shorts, opens, and crossed pairs.

- 1 Press **PORT** to select twisted pair cabling ((JJ)).
- 2 Turn the probe's rotary switch to **CABLE MAP**.
- 3 Connect the tester and probe to the cabling as shown in Figure 27.
- 4 Press **MODE** until ((JJ)) appears on the display. IntelliTone mode is indicated by **IntelliTone** and a scrolling pattern of 1s and 0s on the display. See Figure 27.
- 5 The probe's LEDs light in sequence to indicate the cable's wiring. See the probe's documentation for details.

Using the IntelliTone Cable Map Function (optional IP200 probe required)

Note

Normally, the probe's **SYNC LED** lights to indicate reception of the IntelliTone signal. You may change the LED's function to indicate shield continuity. See the probe's documentation for details.

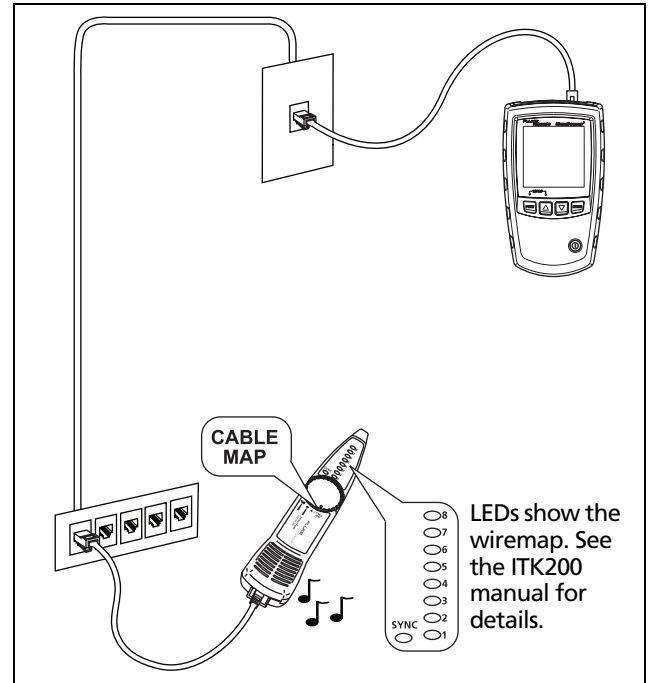

egk26.eps

Figure 27. Using the Toner with the IP200 IntelliTone Cable Map Function

Calibrating Length Measurements

The tester uses an NVP value (nominal velocity of propagation) and the signal delay through the cable to calculate length. The tester's default NVP values are usually accurate enough to verify length; however, you can increase the accuracy of length measurements by adjusting the NVP to a specified or actual value.







The default NVP values are 70 % for twisted pair cable and 82 % for coaxial cable.

Note

NVP values can vary among cable types, lots, and manufacturers. In most cases, these differences are minor and may be disregarded.

Setting the NVP to a Specified Value





To enter the NVP value specified by the manufacturer:

- 1 Turn on the tester while holding down the  and  keys.
- 2 To set the NVP for the coaxial port () , press .
- 3 Use  and  to set the NVP value.
- 4 To save the setting and exit NVP mode, turn the tester off then on again.

Determining a Cable's Actual NVP

You can determine a cable's actual NVP by adjusting the measured length to match a known length of cable.

To determine a cable's NVP:



- 1 Turn on the tester while holding down the  and  keys.
- 2 To set the NVP for the coaxial port () , press .
- 3 Connect a known length of the cable to be tested to the tester's twisted pair or coaxial connector.

Notes

The cable must be at least 49 ft (15 m) long. If the cable is too short, “---” appears for the length.

For the best accuracy, use a cable between 49 ft (15 m) and 98 ft (30 m) long.

The cable must not be connected to anything.

- 4 To switch between meters and feet, press .
- 5 Use  and  to change the NVP until the measured length matches the actual length of the cable.
- 6 To save the setting and exit NVP mode, turn the tester off then on again.

Maintenance



Warning

To avoid possible fire, electric shock, personal injury, or damage to the tester:

- Do not open the case. No user-serviceable parts are inside.
- Replacing electrical parts yourself will void the tester's warranty and might compromise its safety features.
- Use only specified replacement parts for user-replaceable items.
- Use only Fluke Networks authorized service centers.

Cleaning

Clean the display with glass cleaner and a soft, lint-free cloth. Clean the case with a soft cloth dampened with water or water and a mild soap.

⚠ Caution

- To avoid damaging the display or the case, do not use solvents or abrasive cleansers.

Battery Life, Status, and Replacement

⚠ Warning ⚠

- To avoid possible electric shock or personal injury:
- Turn off the tester and disconnect all test leads before replacing the battery.
- Use only the correct type of batteries, properly installed in the case, to power the tester.

The batteries last for about 20 hours of typical use.

Replace the tester's batteries when the low battery indicator () appears. See Figure 28.

You can use the following types of AA (IEC LR6) batteries in the tester:

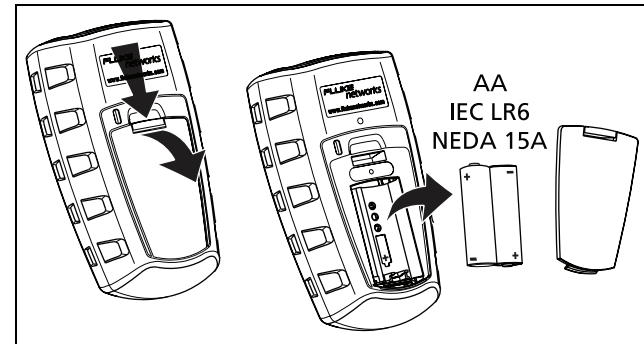

- Alkaline
- Lithium
- Rechargeable nickel-metal hydride (NiMH)
- Rechargeable nickel-cadmium batteries (NiCD)





egk28.eps

Figure 28. Replacing the Tester's Batteries

Checking the Tester's Version and Serial Number

Turn the tester on while holding down the  and  keys.

Use  and  to scroll through the screens:

- **SOF** : Software version
- **Sn** : Serial number
- **FRC** : Factory test date

To exit this mode, turn the tester off.

If Something Seems Wrong

If something seems wrong with the tester, refer to Table 2.

If Table 2 does not help you solve a problem with the tester, contact Fluke Networks for additional help. If possible, have the tester's version and serial number.

For warranty information, refer to the warranty at the beginning of this manual. If the warranty has lapsed, contact Fluke Networks for repair prices.

Table 2. Troubleshooting the Tester

Symptom	Action
The keypad does not respond.	Press and hold  until the tester turns off; then turn the tester on again.
The tester will not turn on.	Replace the batteries, verifying that they are installed correctly. See Figure 28 on page 40.
Length measurements are incorrect.	Check the NVP value. See "Calibrating Length Measurements" on page 38.

Options and Accessories

To order options and accessories (Table 3), contact Fluke Networks.

For the latest list of options and accessories visit the Fluke Networks website at www.flukenetworks.com.



Table 3. Options and Accessories

Option or Accessory	Fluke Networks Model Number
Remote ID Locator Kit, numbers 2-7	MS2-IDK27
Wiremap adapter	MS2-WM
Test lead, 8-pin modular plug (RJ45) to 8 alligator clips	CLIP-SET
Coaxial Adapter Kit (F-connector barrel adapter, female-to-female BNC adapter, female-to-female RCA adapter)	CIQ-COAX
Universal adapter, 8-pin/4-pin modular jack to 8-pin/4-pin modular jack	CIQ-RJA
Carrying case for MicroScanner ² Professional kit	MS2-CPK
Carrying pouch for MicroScanner ² tester	MS2-POUCH

Specifications

Specifications apply at 23 °C (73 °F), unless otherwise noted.

Environmental Specifications

Operating temperature	32 °F to 113 °F (0 °C to 45 °C)
Storage temperature	-4 °F to +140 °F (-20 °C to +60 °C)
Operating relative humidity (% RH without condensation)	90 % (50 °F to 95 °F; 10 °C to 35 °C) 75 % (95 °F to 113 °F; 35 °C to 45 °C)
Shock and Vibration	Random, 2 g, 5 Hz-500 Hz (Class 2) 1 m drop test with and without wiremap adapter attached
Safety	EN 61010-1 2 nd Edition
Altitude	4000 m; Storage: 12000 m
EMC	EN 61326-1
Certifications and compliance	 Conforms to relevant European Union directives.  Conforms to relevant Australian standards.

General Specifications

Test connectors	Shielded 8-pin modular jack accepts 8-pin modular (RJ45) and 4-pin modular (RJ11) plugs. F-connector for coaxial cable.
Power	Battery type: 2 AA (NEDA 15A, IEC LR6) alkaline batteries Battery life: 20 hours of typical use Other compatible battery types: 2 AA photo lithium, NIMH, NICAD
Dimensions and weight (with batteries installed and wiremap adapter attached)	3 in x 6.4" x 1.4 in (7.6 cm x 16.3 cm x 3.6 cm) 0.8 lb (0.36 kg)
Display	Monochrome LCD with backlight

Test Modes

Cable test	Measures length, verifies wiremap, identifies remote ID locators, and detects Ethernet ports. Displays results on one screen.
Tone	Generates Intellitone™ and normal analog toning signals
PoE	Solicits and detects the presence of 802.3af compatible PoE (Power over Ethernet) devices

Performance Specifications

Cable types tested	<p>Twisted pair: UTP, FTP, SSTP</p> <p>Coaxial: 75 Ω, 50 Ω, 93 Ω</p>
Length test	<p>Range: 460 m (1500 ft)</p> <p>Resolution: 0.3 m (1 ft)</p> <p>Typical accuracy: $\pm 4\%$ or 0.6 m (2 ft) whichever is greater. NVP uncertainty is an additional error.</p> <p>Calibration: User-settable NVP for twisted pair and coax. Can determine actual NVP with known length of cable.</p>
Wiremap test	<p>Detects single-wire faults, shorts, miswires, split pairs, and up to seven far-end adapter IDs. The wiremap is drawn with proportional length to visually indicate the approximate location of faults.</p>
Port detection	<p>Detects the advertised speed of 802.3 Ethernet ports.</p>
Tone generator	<p>Supports toning and cable mapping with a Fluke Networks digital IntelliTone™ probe. Generates four tones compatible with typical analog probes.</p> <p>SmartTone™ feature gives positive identification of cables in bundles when using an IntelliTone or an analog probe.</p>

Regulatory Information

This equipment generates, uses, and can radiate radio frequency energy, and, if not installed and used in accordance with the manual, may cause interference to radio communications. It has been tested and found to comply with the limits for a Class A digital device pursuant to Part 15, Subpart J of the FCC rules, which are designed to provide reasonable protection against such interference when operated in a commercial environment. Operation of the equipment in a residential area is likely to cause interference, in which case the user, at his own expense, will be required to take whatever measures may be required to correct the interference.

Appendix A: Diagnosing Wiremap Faults

Appendix A lists the typical causes of wiremap failures.

Open

- Wires connected to wrong pins at connector or punchdown blocks
- Faulty connections
- Damaged connector
- Damaged cable
- Wrong pairs selected in setup
- Wrong application for cable

Split Pair

Wires connected to wrong pins at connector or punchdown block.

Reversed Pairs

Wires connected to wrong pins at connector or punchdown block.

Crossed Pairs

- Wires connected to wrong pins at connector or punchdown block.
- Mix of 568A and 568B wiring standards (12 and 36 crossed).
- Crossover cables used where not needed (12 and 36 crossed).

Short

- Damaged connector
- Damaged cable
- Conductive material stuck between pins at connector.
- Improper connector termination
- Wrong application for cable

Index

Symbols

"?" on coaxial screen, 30

–A–

accessories

 optional, 42

 standard, 3

analog toner, 35

auto shutoff, 9

–B–

batteries, 40

bridge tap, 17

bus topology, 26

–C–

cable map function, 36

cable tests

 coaxial cabling, 28

 twisted pair, 11

cleaning, 40

coaxial

 connections, 28

 open, 29, 30

 short, 30

 unknown termination, 30

connections

 coaxial, 28

 twisted pair, 11

connectors, 7

crossed pairs, 14

crossed wires, 13

customer support

 contacting Fluke Networks, 2

 problem with the tester, 41

–E–

Ethernet port detected, 18

–F–

Fluke Networks, 2

–H–

help

 contacting Fluke Networks, 2

 problem with the tester, 41

high voltage, 4, 16

–I–

IntelliTone mode

 cable map function, 36

 toner, 32

ISDN, 4, 16

–K–

keys, 7

–L–

length calibration, 38

–M–

maintenance, 39

–N–

NVP, 38

–O–

open

 coaxial, 29, 30

 twisted pair, 12

options, 42

–P–

PoE (Power over Ethernet), 31

problems (with the tester), 41

–R–

registration, 2

remote ID locator, 10, 22

replacement parts, 42

RJ11 jack, 10

-S-

safety information, 4, 39
serial number, 41
service, 41
short
 coaxial, 30
 twisted pair, 13
SmartTone function, 35, 36
specifications, 43
split pair, 15
star topology, 24, 27

-T-

telephone cord (split pair), 15
telephone voltages, 4, 16
testing
 coaxial cabling, 28
 twisted pair cabling, 11
toner, 32
 analog mode, 35
 IntelliTone mode, 32
 SmartTone function, 35, 36
troubleshooting
 cabling faults, 47

 the tester, 41
twisted pair
 bridge tap, 17
 connections
 bus topology, 26
 network cabling, 11
 star topology, 24, 27
 crossed pairs, 14
 crossed wires, 13
 individual results, 20
 open, 12
 PoE detection, 18
 short, 13
 split pair, 15
 telephone voltages, 16

-U-

universal adapter, 10

-V-

version information, 41
voltage detection, 4, 16

–W–

wiremap adapter, 10

The logo for Tequipment.NET features a large red letter 'T' on the left. To its right is a small graphic of the United States flag with the word 'USA' in blue text above it. Below the 'T' and the flag graphic, the word 'Tequipment' is written in a blue, sans-serif font. Underneath 'Tequipment', the word '.NET' is written in a red, sans-serif font. A blue horizontal line is positioned below 'Tequipment', and a red horizontal line is positioned below '.NET'.

**205 Westwood Ave
Long Branch, NJ 07740
1-877-742-TEST (8378)
Fax: (732) 222-7088
salesteam@Tequipment.NET**