



205 Westwood Ave  
Long Branch, NJ 07740  
1-877-742-TEST (8378)  
Fax: (732) 222-7088  
salesteam@Tequipment.NET

**FLUKE®**

# FTK200

Optical Fiber Test Kit

## Users Guide

April 2000, Rev. 1 4/03

© 2000, 2003 Fluke Corporation. All rights reserved. Printed in USA.

All product names are trademarks of their respective companies.

### **LIMITED WARRANTY AND LIMITATION OF LIABILITY**

Each Fluke product is warranted to be free from defects in material and workmanship under normal use and service. The warranty period is one year and begins on the date of shipment. Parts, product repairs, and services are warranted for 90 days. This warranty extends only to the original buyer or end-user customer of a Fluke authorized reseller, and does not apply to fuses, disposable batteries, or to any product which, in Fluke's opinion, has been misused, altered, neglected, contaminated, or damaged by accident or abnormal conditions of operation or handling. Fluke warrants that software will operate substantially in accordance with its functional specifications for 90 days and that it has been properly recorded on non-defective media. Fluke does not warrant that software will be error free or operate without interruption.

Fluke authorized resellers shall extend this warranty on new and unused products to end-user customers only but have no authority to extend a greater or different warranty on behalf of Fluke. Warranty support is available only if product is purchased through a Fluke authorized sales outlet or Buyer has paid the applicable international price. Fluke reserves the right to invoice Buyer for importation costs of repair/replacement parts when product purchased in one country is submitted for repair in another country.

Fluke's warranty obligation is limited, at Fluke's option, to refund of the purchase price, free of charge repair, or replacement of a defective product which is returned to a Fluke authorized service center within the warranty period.

To obtain warranty service, contact your nearest Fluke authorized service center to obtain return authorization information, then send the product to that service center, with a description of the difficulty, postage and insurance prepaid (FOB Destination). Fluke assumes no risk for damage in transit. Following warranty repair, the product will be returned to Buyer, transportation prepaid (FOB Destination). If Fluke determines that failure was caused by neglect, misuse, contamination, alteration, accident, or abnormal condition of operation or handling, including overvoltage failures caused by use outside the product's specified rating, or normal wear and tear of mechanical components, Fluke will provide an estimate of repair costs and obtain authorization before commencing the work. Following repair, the product will be returned to the Buyer transportation prepaid and the Buyer will be billed for the repair and return transportation charges (FOB Shipping Point).

**THIS WARRANTY IS BUYER'S SOLE AND EXCLUSIVE REMEDY AND IS IN LIEU OF ALL OTHER WARRANTIES, EXPRESS OR IMPLIED, INCLUDING BUT NOT LIMITED TO ANY IMPLIED WARRANTY OF MERCHANTABILITY OR FITNESS FOR A PARTICULAR PURPOSE. FLUKE SHALL NOT BE LIABLE FOR ANY SPECIAL, INDIRECT, INCIDENTAL, OR CONSEQUENTIAL DAMAGES OR LOSSES, INCLUDING LOSS OF DATA, ARISING FROM ANY CAUSE OR THEORY.**

Since some countries or states do not allow limitation of the term of an implied warranty, or exclusion or limitation of incidental or consequential damages, the limitations and exclusions of this warranty may not apply to every buyer. If any provision of this Warranty is held invalid or unenforceable by a court or other decision-maker of competent jurisdiction, such holding will not affect the validity or enforceability of any other provision.

Fluke Corporation  
P.O. Box 9090  
Everett, WA 98206-9090  
U.S.A.

Fluke Europe B.V.  
P.O. Box 1186  
5602 BD Eindhoven  
The Netherlands

# Table of Contents

Title	Page
△ Safety Information .....	iv
Cleaning Fiber Connections .....	iv
Introduction .....	1
Contacting Fluke .....	2
Unpacking.....	2
Features .....	4
Measuring Optical Power.....	8
Setting a Reference for Loss Measurements.....	10
Measuring Optical Power Loss .....	12
Memory Functions .....	14
Saving and Reviewing Measurements.....	14
Replacing Saved Measurements .....	14
Deleting Saved Measurements .....	14
Maintenance .....	15
Battery Replacement .....	15
Accessories and Replacement Parts .....	16
Calibration and Service.....	17
FM150 Fiber Meter Specifications .....	17
FS150 Fiber Source Specifications .....	18

Appendix A: Using the Serial Port.....	21
Appendix B: Glossary.....	23

## ***List of Figures***

<b>Figure</b>	<b>Title</b>	<b>Page</b>
1.	Standard Equipment .....	3
2.	FM150 Fiber Meter Features .....	4
3.	Display Features .....	6
4.	FS150 Fiber Source Features.....	7
5.	Measuring Optical Power.....	9
6.	Setting a Reference .....	11
7.	Measuring Loss.....	13
8.	Battery Replacement .....	15

## ***List of Tables***

<b>Table</b>	<b>Title</b>	<b>Page</b>
1.	FM150 Fiber Meter Features .....	5
2.	Accessories and Replacement Parts .....	16
3.	Pin Assignments for Serial Cable .....	21

## **⚠ Safety Information**

### **⚠ Warning**

**To avoid possible eye damage caused by hazardous radiation:**

- **Never look directly into optical output connectors. Some sources produce invisible radiation that can permanently damage your eyes.**
- **Do not open the case, except to change the battery; no user-serviceable parts are inside.**

### **Caution**

**To avoid false test results, replace the battery as soon as the low battery indicator (BAT) appears.**

## **Cleaning Fiber Connections**

Always clean the fiber ends before making connections. Use any of the following:

- Lint-free swabs or wipes moistened with isopropyl alcohol
- Pre-moistened swabs or wipes approved for use on fiber connectors

Canned air approved for use on fiber connectors is also useful for dislodging contamination. Protect all connectors with dust caps when not in use.

# ***Optical Fiber Test Kit***

## ***Introduction***

The FTK200 Optical Fiber Test Kit is used to measure optical power and optical power loss at 850 nm, 1300 nm, 1310 nm, and 1550 nm. This test kit includes the FM150 Fiber Meter (also referred to as “the meter”), which has the following features:

- Measures optical power loss of multimode or singlemode fibers.
- Measures output power from optical sources such as network interface cards or optical test equipment.
- Displays output power measurements in dBm or  $\mu$ W.
- Operates for up to 30 hours on a single 9 V alkaline battery. Automatic power-down feature helps conserve battery power.
- Displays remaining battery life.
- Designed to use the optional ToolPak™ Meter Hanging Kit from Fluke.
- Saves up to 500 measurements for each wavelength.
- Serial port lets you print measurements on a serial printer or upload measurements to a PC.
- LinkWare™ software runs on a PC to let you upload measurements from the meter, view measurements, add header information to create test reports, and save and print reports.

The FTK200 Kit also includes a Fluke FS150 Fiber Source, which provides light for multimode testing at 850 nm and 1300 nm. For testing singlemode fiber, Fluke offers the optional LS-1310/1550 Laser Source.

The instructions in this guide assume you are using the FS150 source included. For other optical sources, refer to the manufacturer's instructions.

## ***Contacting Fluke Networks***

Visit Fluke's Web site at **[www.flukenetworks.com](http://www.flukenetworks.com)**.

To order accessories, receive operating assistance, or get the location of the nearest Fluke distributor or Service Center, call:

- USA: 1-800-283-5853
- Canada: 1-800-363-5853
- Europe: +44 1923 281 300
- Japan: +81-3-3434-0181
- Singapore: +65-6738-5655
- Anywhere in the world: +1-425-446-4519

## ***Unpacking***

The equipment listed below and shown in Figure 1 is included with the FTK200 Kit. If anything is missing or damaged, contact the place of purchase immediately.

- FM150 Fiber Meter (with 9 V battery installed)
- ST adapter cap (with dust cap) for FM150 Fiber Meter
- FS150 Fiber Source (with 9 V battery and dust cap installed)
- ST adapter cap (with dust cap) for FS150 Fiber Source
- 2 ST/ST 3 ft (1 m) 62.5  $\mu$ m multimode patch cords
- 1 ST/ST 1 ft (0.3 m) 62.5  $\mu$ m multimode test jumper
- 1 ST/ST adapter (singlemode quality)
- LinkWare PC utility diskette
- RS-232 PC interface cable
- 2 recording pads
- FTK100/FTK200 Manuals CD-ROM
- Warranty registration card
- Hard carrying case



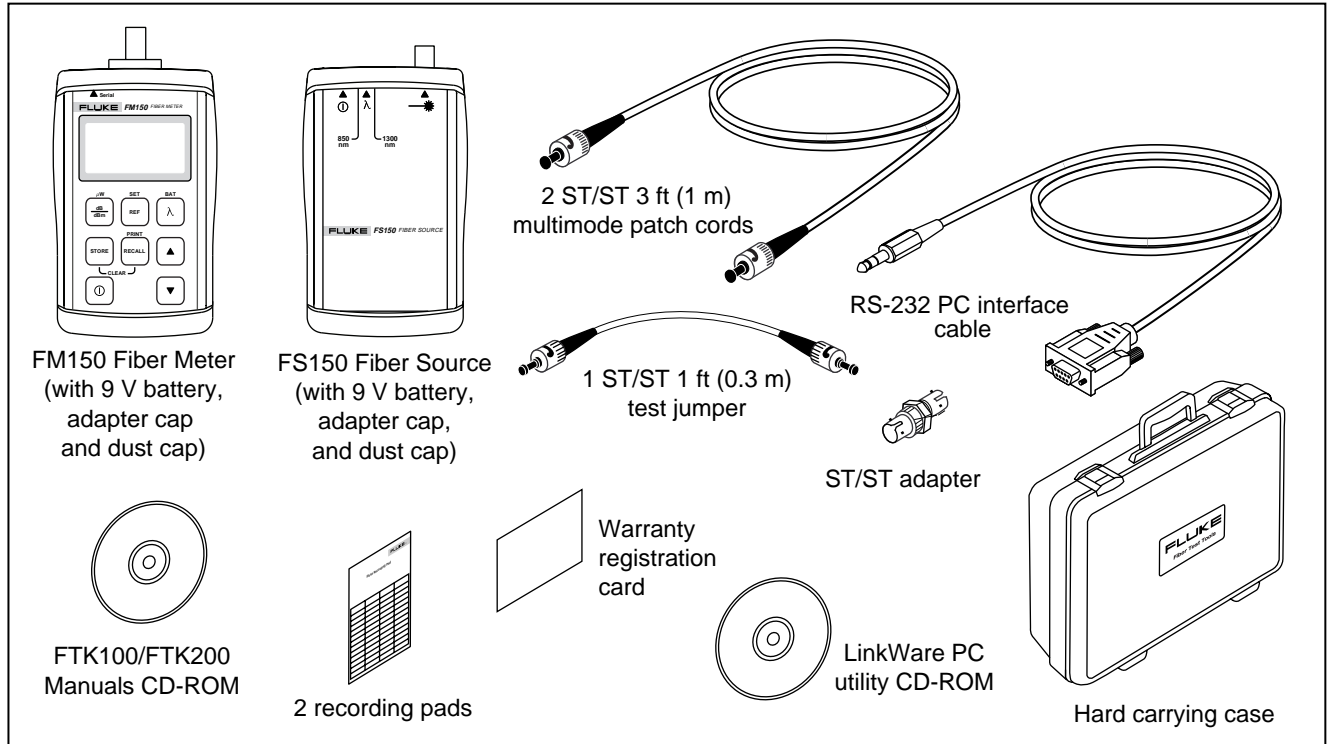
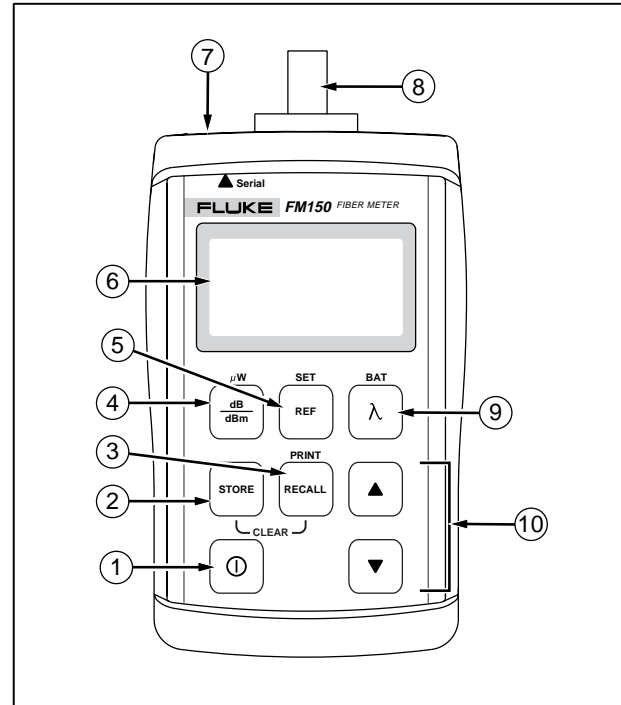

**Figure 1. Standard Equipment**

afz02f.eps.

## Features











Figures 2 and 3 and Table 1 describe the meter's features. Figure 4 describes the features of the FS150 Fiber Source included in the kit.

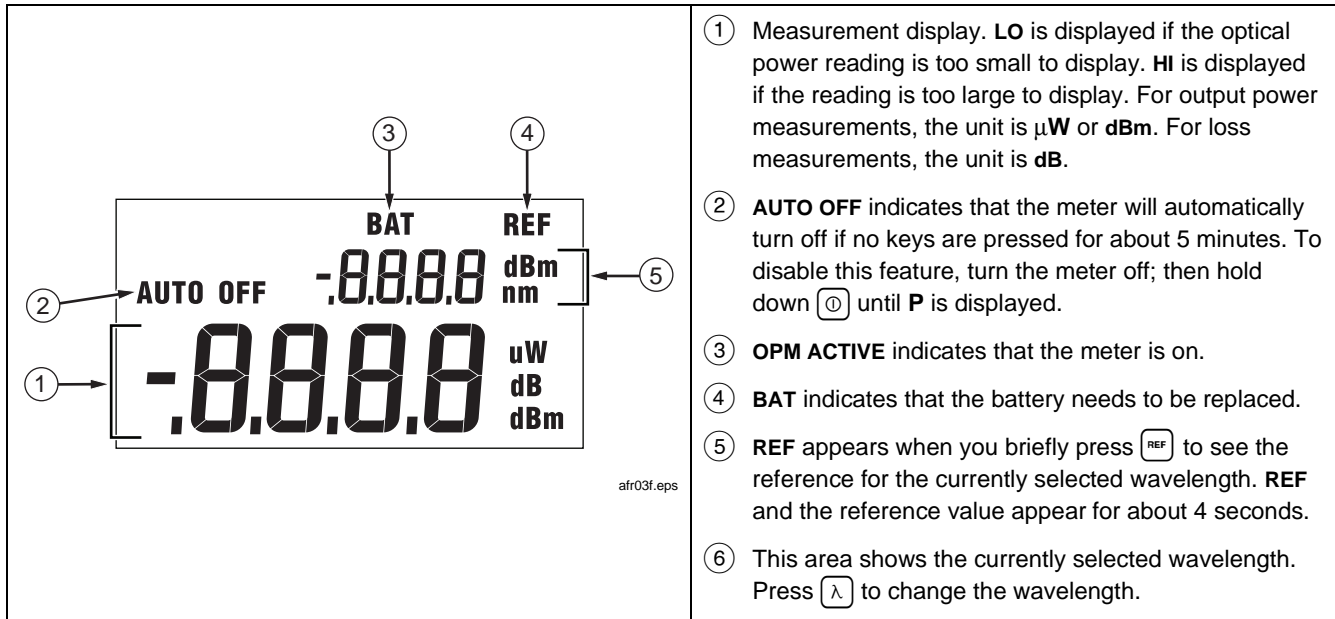

**Figure 2. FM150 Fiber Meter Features**

afz01f.eps

**Table 1. FM150 Fiber Meter Features**

Item	Description
①	On/off key. Hold down  to turn the meter on. The automatic power-down feature, which turns the meter off if no keys are pressed for 5 minutes, is enabled when you turn the meter on. To disable this feature, turn the meter off; then hold down  until <b>P</b> is displayed.
② ③	Press  to save the current measurement in non-volatile memory. Press  briefly to view or replace a saved measurement. Hold down  to send stored measurements to a PC or serial printer. See “Memory Functions” and Appendices A and B for details. To clear from memory all saved measurements for the current wavelength, hold down  and  together until <b>HELD</b> appears.
④	Toggles the meter between power (dBm) and loss (dB) measurements. Loss readings are compared to the stored reference level. Hold down  until <b>HELD</b> appears to change the measurement units to $\mu$ W.
⑤	Press  briefly to display the reference value for the currently selected wavelength. Hold down  to store a new reference value for the displayed wavelength.
⑥	LCD display. See Figure 3 for details.
⑦	Serial connector for printing to a serial printer or uploading saved measurements to a PC.
⑧	Removable adapter cap with an ST connector for connecting to multimode or singlemode patch cords.
⑨	Changes the wavelength to be measured. To see the percentage of battery life remaining, hold down  until <b>HELD</b> appears.
⑩	Used in recall mode to scroll through saved measurements.



- ① Measurement display. **LO** is displayed if the optical power reading is too small to display. **HI** is displayed if the reading is too large to display. For output power measurements, the unit is  $\mu\mathbf{W}$  or **dBm**. For loss measurements, the unit is **dB**.
- ② **AUTO OFF** indicates that the meter will automatically turn off if no keys are pressed for about 5 minutes. To disable this feature, turn the meter off; then hold down  $\text{⓪}$  until **P** is displayed.
- ③ **OPM ACTIVE** indicates that the meter is on.
- ④ **BAT** indicates that the battery needs to be replaced.
- ⑤ **REF** appears when you briefly press  $\text{REF}$  to see the reference for the currently selected wavelength. **REF** and the reference value appear for about 4 seconds.
- ⑥ This area shows the currently selected wavelength. Press  $\text{λ}$  to change the wavelength.

**Figure 3. Display Features**

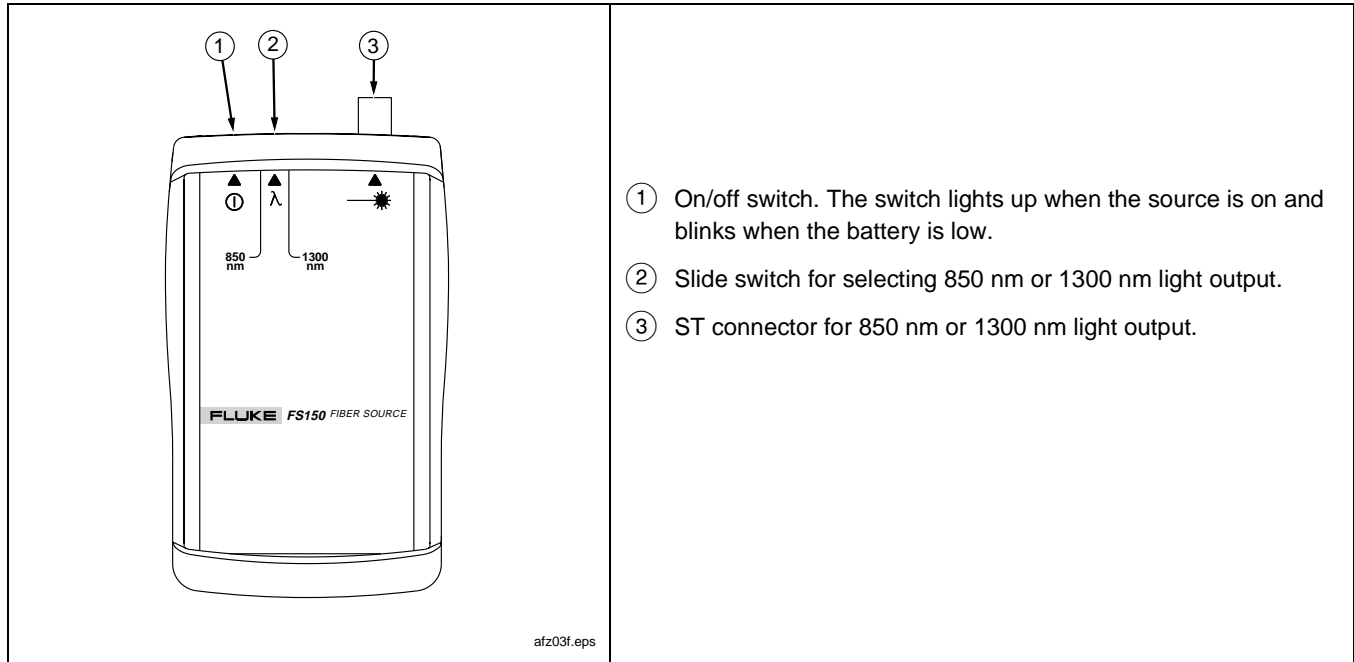



**Figure 4. FS150 Fiber Source Features**

## **Measuring Optical Power**

Optical power is the output power produced by a source such as an optical network interface card or optical test equipment. You can measure power at a source or at the end of a fiber link.

To measure optical power, proceed as follows:

1. Verify that the meter and source are set to the proper wavelength. Let the source warm up for two minutes, if necessary.
2. Clean all fiber ends.
3. Make the connections shown in Figure 5.
4. Verify that the meter is in the power measurement mode. The measurement unit should be **dBm**. If necessary, press  to change the measurement unit to **dB**. To change the unit to  $\mu\mathbf{W}$ , hold down  until **HELD** appears on the display.
5. Read the power measurement.

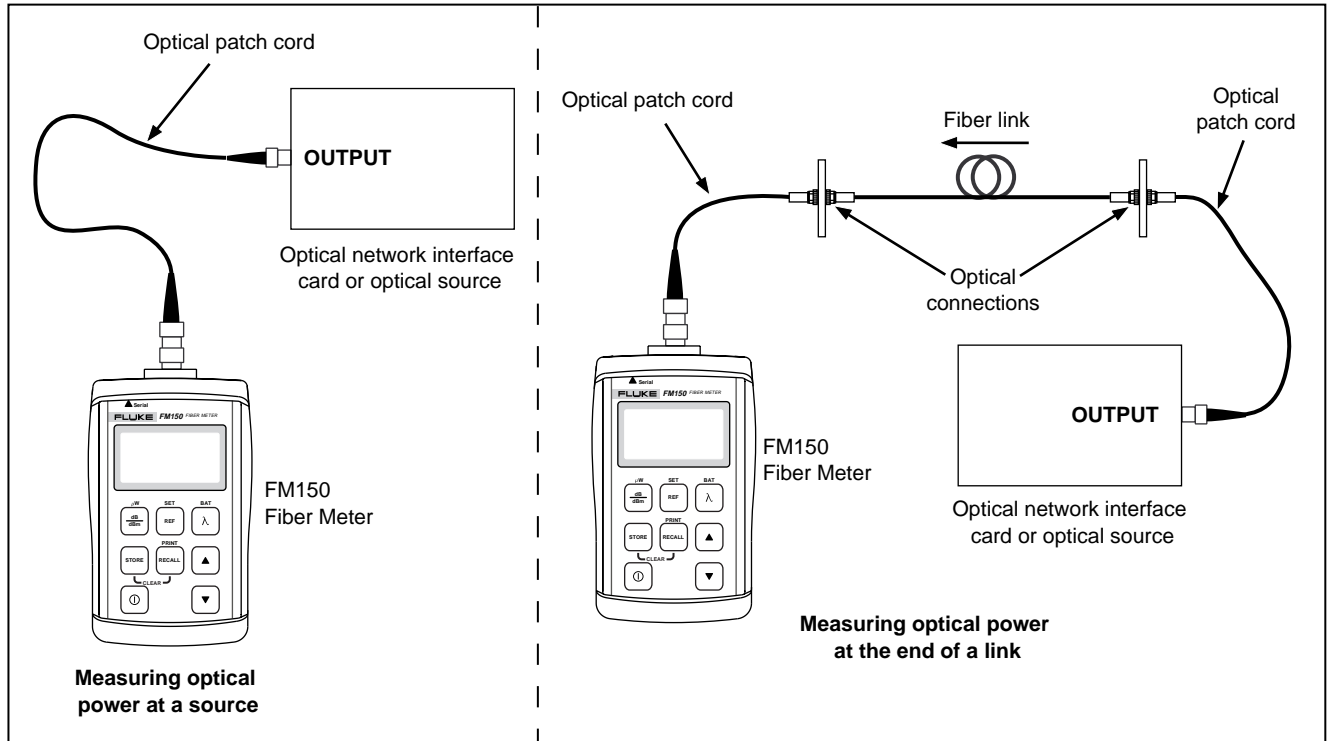

**Figure 5. Measuring Optical Power**

afz04f.eps

## Setting a Reference for Loss Measurements

Setting a reference lets the meter automatically subtract from loss measurements the losses due to patch cords. The loss for a fiber under test is automatically calculated as the difference between the reference loss and the loss with the fiber inserted.

For the most accurate test results, you should set the reference at these times:

- Anytime you start using a different optical source for loss measurements
- Anytime you change the patch cord used on the meter or source.



### Note

*For the most accurate test results, set the reference at the beginning of each day using the patch cords and wavelength settings you will use for testing.*

The meter stores a separate reference value for each wavelength. The reference values are not affected when you turn the meter off or change the battery.

To view the reference for the selected wavelength, press  briefly.

To set a reference, proceed as follows:

1. Set the source to the wavelength you will use for testing. Let the source warm up for two minutes.
2. Select two known-good patch cords of the same type as the fiber to be tested. Select one known-good adapter of the appropriate type. Clean all fiber ends.
3. Make the connections shown in Figure 6. Turn on the meter. Press  to select the proper wavelength. Normally, the reading will be about -20 dBm. If the reading is too low, check the source connections and wavelength, or clean the fiber ends again, or select different patch cords, or use a different adapter.
4. To set the reference, hold down  until **HELD** appears on the display. The loss reading should then change to 0 dB. The last digit may vary slightly because of fiber movement and minor variations in the output power of the source.
5. If you are testing with more than one wavelength, change the meter and source to the new wavelength, then repeat step 4.



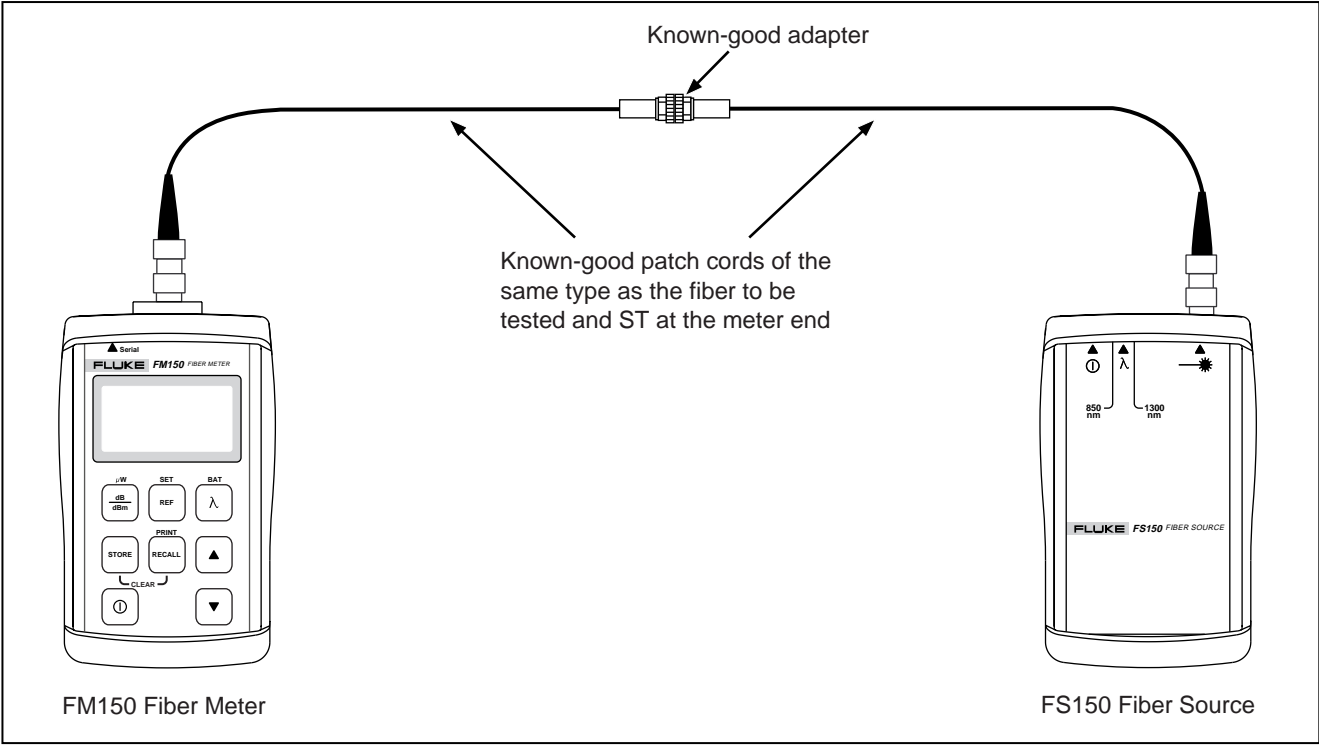

**Figure 6. Setting a Reference**

## Measuring Optical Power Loss

Optical power loss is the light energy lost through the fiber, adapters, splices, and other components in a fiber link. The loss for a fiber under test is automatically calculated as the difference between the loss with the fiber inserted and the reference loss. (See Figures 6 and 7.)

To measure loss, proceed as follows:

1. Verify that the meter and source are set to the proper wavelength. Let the source warm up for two minutes, if necessary.

### Note

*The patch cords used for loss measurements should be the same patch cords used to set the reference at the wavelength you are testing. If the patch cords have been disconnected from the meter or source since the reference was set, set the reference again before measuring loss.*

2. Clean all fiber ends.
3. Set a reference, if necessary. (See the previous section “Setting a Reference for Loss Measurements” for details.)
4. Make the connections shown in Figure 7.

### Note

*The additional test jumper used during loss measurement ensures that the loss you measure includes the fiber to be tested and the connections at both ends of the fiber.*

5. Verify that the meter is in the loss measurement mode. If so, the unit of measurement will be **dB**. If it is not, press  $\left( \begin{smallmatrix} \text{dB} \\ \text{dBm} \end{smallmatrix} \right)$ .
6. Read the loss measurement.

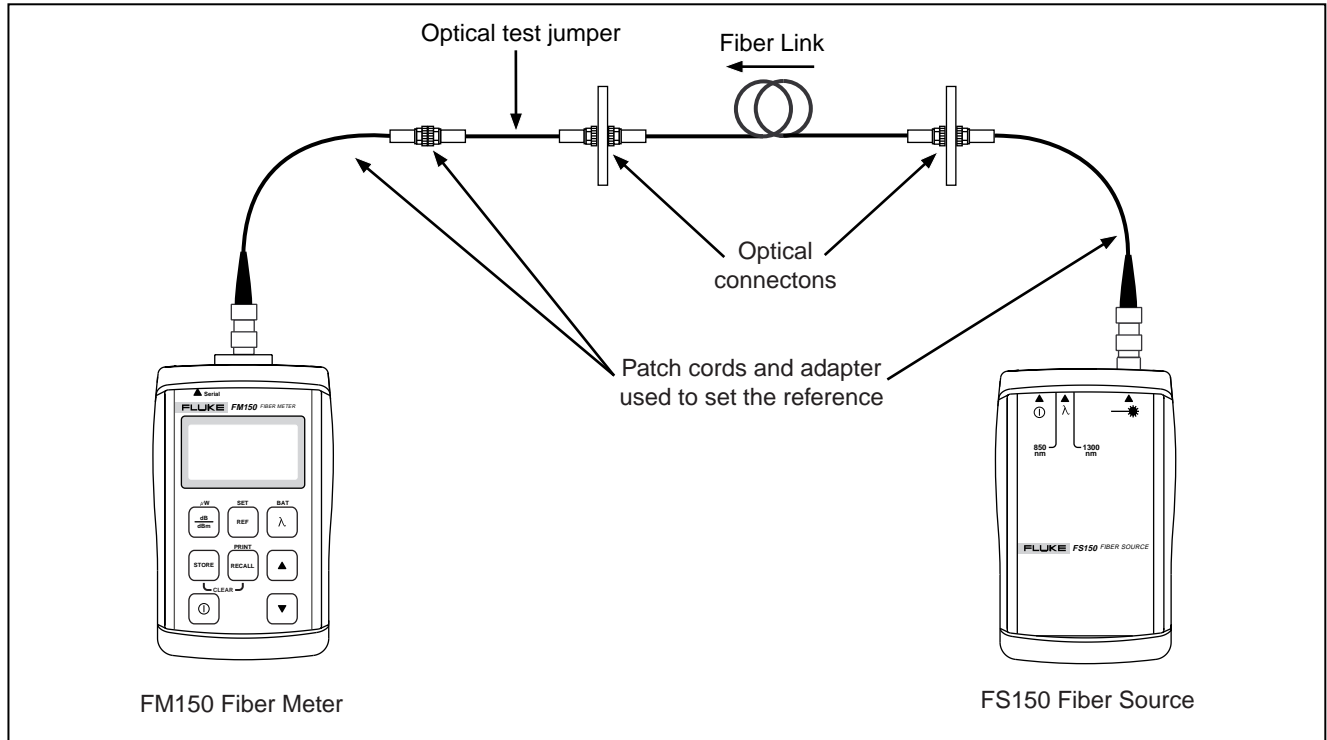





**Figure 7. Measuring Loss**



## Memory Functions

The FM150 Fiber Meter lets you save loss and power measurements in non-volatile memory. Saved measurements are not lost when you change the battery. You can save up to 500 measurements for each wavelength. You can send the measurements directly to a serial printer or upload them to a PC. Refer to the Appendix for more information on connecting to a printer or PC.

### Saving and Reviewing Measurements





To save the current reading, press . The reading is saved in the next available memory location, which is briefly displayed. You can also use the test results pad included with the meter to record the storage location number, fiber identification, file name, and comments about the results.

To review saved measurements, press  to select the desired wavelength; then press . The highest memory location used is alternately displayed with its contents. Use   to scroll through the memory locations.



To exit the recall mode, press  or .

### Replacing Saved Measurements

You can save a new measurement in any memory location, as follows:

1. Press ; then use   to select the memory location you want to change.
2. Hold down the  key until **HELD** appears. The meter then switches to measurement mode.
3. Make a new loss or power measurement; then press .

### Deleting Saved Measurements

To delete all measurements saved for the currently selected wavelength, hold down both  and  until **HELD** appears.

To delete all saved measurements, delete the measurements for each wavelength.

## **Maintenance**

Clean the case with a soft cloth dampened with water or a mild detergent. Do not use solvents or abrasive cleansers.

Always cover the connector with the dust cap when not using the meter.

Do not open the case (except to replace the battery). No user-serviceable parts are inside.

## **Battery Replacement**

Replace the battery in the FM150 Fiber Meter when **BAT** appears at the top of the display. Refer to Figure 8.

Replace the battery in the FS150 Fiber Source when the light in the power switch blinks or does not turn on. Refer to Figure 8.

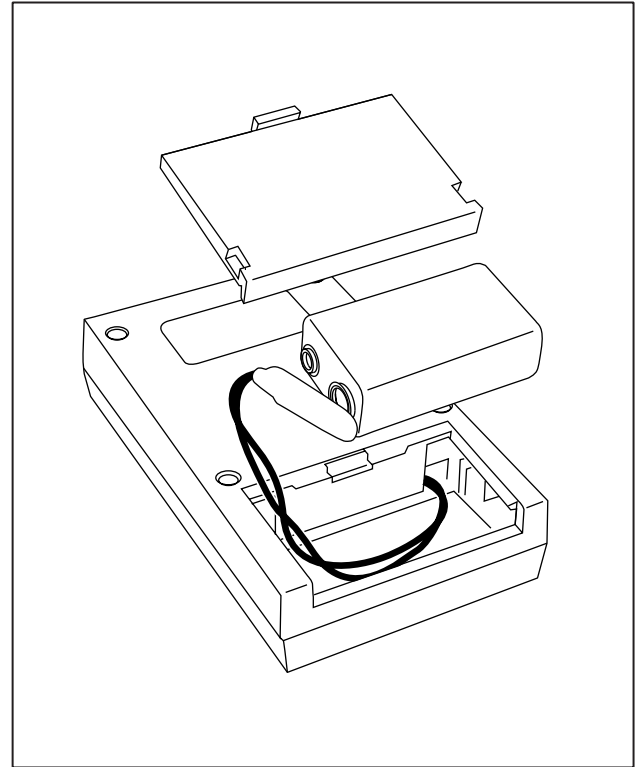

**Figure 8. Battery Replacement**

afz07f.eps

**Accessories and Replacement Parts**

Table 2 shows the accessories and replacement parts available from Fluke for the FTK200 Optical Fiber Test Kit.

**Table 2. Accessories and Replacement Parts**

Description	Fluke Model or Part Number
Recording pads, pack of 10	NF410
ToolPak™ meter hanging kit	TPAK
ST adapter cap for FM150 Fiber Meter	1568277
ST adapter cap for FS150 Fiber Source	1568292
ST/ST 62.5 µm multimode patch cord	FOC-ST/ST
ST/SC 62.5 µm multimode patch cord	FOC-ST/SC
ST/ST 62.5 µm short test jumper	NF230
ST/ST adapter	NF300SM
SC/SC adapter	NF310SM

**Table 2. Accessories and Replacement Parts (cont.)**

Description	Fluke Model or Part Number
LS-1310/1550 Laser Source	LS-1310/1550
RS-232 PC interface cable, 9-pin to 3-conductor plug	1568303
Battery door for FM150 Fiber Meter or FS150 Fiber Source	1568289
FTK100/FTK200 Manuals CD-ROM	2072094
LinkWare CD-ROM	LinkWare

### **Calibration and Service**

Have the meter calibrated at an authorized Fluke Service Center every 12 months.

For service, contact an authorized service center. To locate the nearest service center, contact Fluke as described at the beginning of this guide.

### **FM150 Fiber Meter Specifications**

<b>Detector type</b>	Germanium
<b>Calibrated wavelengths</b>	850 nm, 1300 nm, 1310 nm, and 1550 nm
<b>Measurement range</b>	+6 dBm to -50 dBm
<b>Resolution</b>	0.01 dB
<b>Loss and power measurement accuracy</b>	$\pm 0.25$ dB at 25 °C and -10 dBm
<b>Temperature range</b>	Operating: 0 °C to +50 °C; Storage: -30 °C to +60 °C
<b>Humidity range</b>	Operating: 0 to 95 % RH, non-condensing
<b>Battery type and life</b>	9 V alkaline (NEDA 1604A or IEC 6LR61); 30 hours typical with alkaline battery
<b>Low battery indication</b>	<b>BAT</b> appears on the display.
<b>Display</b>	4-digit LCD display

**FM150 Fiber Meter Specifications (cont.)**

<b>Memory</b>	Stores up to 500 measurements for each wavelength. Measurements are stored in non-volatile memory, which is retained when power is off or the battery is changed.  Memory contents can be uploaded to a PC or sent directly to a serial printer.
<b>Serial port connector</b>	3.5 mm, 3-conductor phone jack
<b>Certifications</b>	CE
<b>Dimensions</b>	3.2 in x 5.8 in x 1.5 in (8.1 cm x 14.7 cm x 3.8 cm)
<b>Weight</b>	8.6 oz (244 g)

***FS150 Fiber Source Specifications***

<b>Light source</b>	Infrared LED
<b>Wavelength</b>	850 nm $\pm$ 30 nm; 1300 nm -10 nm/+50 nm
<b>Output power</b>	-20 dBm nominal into 62.5 $\mu$ m multimode fiber
<b>Connector</b>	ST



**FS150 Fiber Source Specifications (cont.)**

<b>Stability</b>	±0.1 dB per 8 hours at 25 °C
<b>Battery type and life</b>	9 V alkaline (NEDA 1604A or IEC 6LR61); 30 hours typical with alkaline battery
<b>Low battery indication</b>	Blinking LED in power switch
<b>Temperature range</b>	Operating: 0 °C to 50 °C; Storage: -20 °C to +70 °C
<b>Humidity</b>	Up to 90 % RH
<b>Certifications</b>	CE
<b>Dimensions</b>	3.2 in x 5.6 in x 1.5 in (8.1 cm x 14.2 cm x 3.8 cm)
<b>Weight</b>	7.2 oz (204 g)



# Appendix A

## Serial Communications

### Using the Serial Port

The serial port on the FM150 Fiber Meter lets you send saved measurements to a PC or a serial printer.

The interface cable provided is configured for serial communication with a PC. An adapter might be required for connecting directly to a serial printer. Table 3 gives the pin assignments for the serial cable. Refer to your printer's documentation for the printer's serial port pin assignments.



Table 3. Pin Assignments for Serial Cable

Phone Plug Conductor	Pins on 9-pin Connector	Signal
Tip	7	Clear to Send
Ring	2	Transmit Data
Sleeve	5	Ground

The data protocol for the serial port is 1200 baud, 8 data bits, 1 stop bit, no parity, and XON/XOFF data flow control.

### ***Sending Measurements to a Printer***

To send measurements directly to a serial printer, proceed as follows:

1. Turn on the FM150 Fiber Meter and the printer.
2. If necessary, set the printer to the data protocol given under “Using the Serial Port” in this appendix. Refer to the documentation for your printer for its configuration instructions.
3. Use the RS-232 interface cable provided (with an adapter, if necessary) to connect the meter to the printer.
4. On the meter, press  to enter the recall mode; then hold down  until **HELD** appears. All measurements stored for all wavelengths are transmitted to the printer. When all measurements are transferred, **HELD** disappears.

### ***Sending Measurements to a PC***

To send measurements to a PC, use the LinkWare™ software provided with the meter.

## ***Appendix B*** ***Glossary***

### ***Adapter***

A device used to mate fiber connectors of the same or different styles.

### ***Attenuation***

A loss of optical power due to losses in the fiber itself or in connections between fibers.

### ***Core***

The light-conducting central portion of an optical fiber.

### ***dBm***

A unit of power (in decibels), assuming a reference of 1 mW (1/1000 of a watt).

### ***Insertion loss***

Loss of optical power caused by adding a connector, adapter, splice, or other optical component to a fiber path.

### ***Launch cable***

A fiber patch cord used to couple an optical source to a fiber.

### ***Macrobending losses***

Light losses due to large-radius bends in a fiber, such as bends made during installation.

### ***Microbending losses***

Light losses due to microscopic imperfections in a fiber.

### ***Multimode fiber***

Fiber with a relatively large core (50  $\mu\text{m}$  or more) that offers many paths, or modes, for propagation of light.

### ***Optical power***

Optical power measured at a source or the end of a fiber and expressed in microwatts ( $\mu\text{W}$ ) or in decibels with reference to one milliwatt (dBm).

### ***Receive cable***

A fiber patch cord used to couple a fiber to an optical receiver.

### ***SC connector***

Subscription Channel Connector. An optical connector that originated in Japan and provides push-pull connections, low loss, and low backreflection.

### ***Singlemode fiber***

Fiber with a small core (8  $\mu\text{m}$  to 10  $\mu\text{m}$ ) that offers just one path, or mode, for propagation of light.

### ***ST connector***

Straight-Tip Connector. A popular fiber connector originally developed by AT&T.

### ***Test Jumper***

A short patch cord used when testing a fiber link.

