

Instruction Manual

Thank you for purchasing HAKKO FA-400 smoke absorber.
Please read this manual before operating the HAKKO FA-400.
Keep this manual readily accessible for reference.

1. PACKING LIST AND PART NAMES

Please check to make sure that all items listed below are included in the package.

HAKKO FA-400 Smoke absorber 1 Instruction manual 1
Filter 1

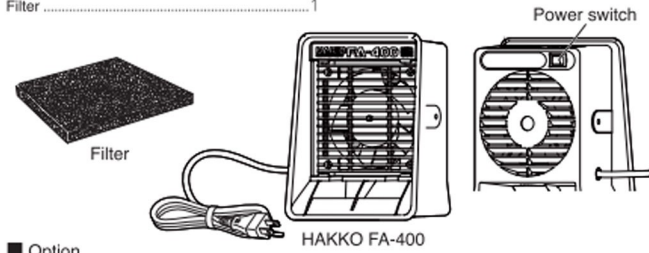

Option

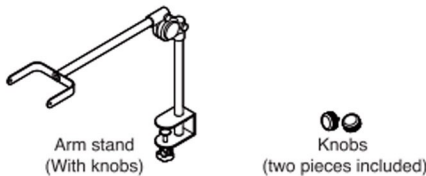

2. SPECIFICATIONS

●HAKKO FA-400

Name	HAKKO FA-400	
Power consumption	50Hz	60Hz
	100V	15W 13W
	110V	18W 15W
	120V	- 19W
	220V	19W 16W
	230V	22W 18W
	240V	24W 19W
Dimensions	166(W)×212(H)×113(D) mm	
Weight	930g	
Accessories	Filter (1 pcs)	

●Activated-carbon filter

Size	130 × 130 × 10 mm
* This product is protected against electrostatic discharge.	
* Specifications and design are subject to change without notice.	

3. WARNINGS, CAUTIONS AND NOTES

⚠ WARNINGS

To reduce the risk of fire or electric shock, do not use this fan with any solid-state speed control device.
Disconnect the power cord before servicing. Failure to do so may result in electric shock.

⚠ CAUTION

- Do not absorb combustible or explosive gas with the absorber.
- Avoid a humid location to store the absorber.
- Use genuine parts as the replacement parts of the absorber.
- Do not cover the exhaust vent of the absorber.
- Before you stop or finish using the absorber, or leave the place, turn off the power.
- Do not insert your finger or a stick into the fan.
- Be sure to turn off the power before you replace the part or put away the absorber.
- Be careful not to allow a person who has no experience in or knowledge for the use of the absorber (including children) to use this product without authorization of the responsible manager.
- Be careful not to allow children to play with this product.
- If the power cord was broken, it is required to be replaced with a new one by the manufacturer, service agency, or a person who has an equivalent qualification, in order to prevent danger.

To prevent accidents or damage to the HAKKO FA-400, be sure to observe the following:

- Do not operate the absorber without the filter; otherwise it may cause the absorber to malfunction.
- Hold the plug when inserting or removing the cord in/from the outlet.
- Do not get the product wet or use it with a wet hand.
- Do not make any other action considered to be dangerous.

4. OPERATION

4.1 Absorbing widespread smoke

- In order to absorb widespread smoke, install the absorber as the right figure shows and turn on the power.

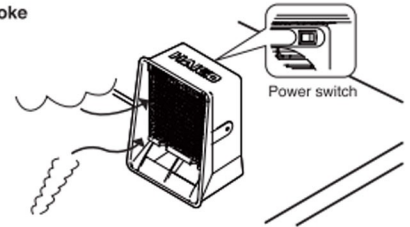

4.2 Absorbing smoke around you

- To absorb smoke around you, install the absorber on a table as the right figure shows and turn on the power.

The absorption power is much stronger in this installation than in the conventional installation.
On the contrary, this installation is not suitable for absorption of widespread smoke.

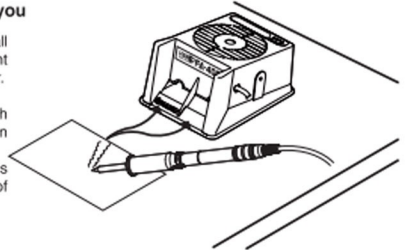

■ When using the optional arm stand

- When using the absorber with the arm stand, be careful of the direction in which HAKKO FA-400 is mounted by reference to the right figure.

NOTE :

- The arm stand and the knobs (two pieces included) are optional products. Order them separately from the absorber.
- The screw holes on HAKKO FA-400 are covered by stickers. Peel off the stickers before mounting the absorber in the arm stand.

⚠ CAUTION

You cannot mount HAKKO FA-400 in the arm stand in the opposite direction.

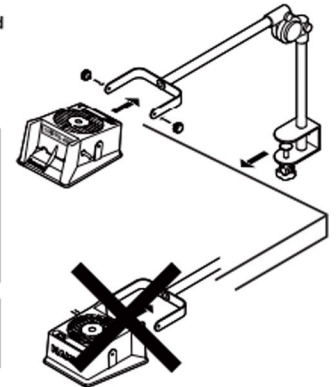

5. MAINTENANCE

• Replacing the filter

Absorption capacity will decline by using the filter. Replace the filter when the filter surface totally turns white. The filter may also need replacement when the dust adhere. (Never allow the filter to become wet.)

5.1 Removing the filter

- When replacing the filter with a new one, put your fingers on the filter as the right figure shows and remove it by pulling it out.

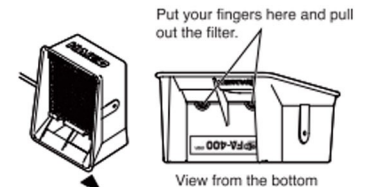

5.2 Attaching the filter

- Push the filter in the absorber so that it is fixed in place with the four nails which the right figure shows.

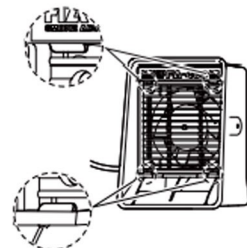

6. PARTS LIST

● Replacement Parts

Part No.	Part Name	Specifications
A1001	Filter set	Activated-carbon filter, set of 5

● Optional Parts

Part No.	Part Name	Specifications
C1568	Arm stand	With knobs (set of 2, ESD)
B1166	Knob	Set of 2, ESD

⚠CAUTION

This product is protected against electrostatic discharge. Be sure to observe the following instructions:

1. The plastic parts are not insulators, they are conductors. When replacing parts or repairing, take sufficient care not to expose live electrical parts or damage insulation materials.
2. Be sure to ground the unit during use.

※ 各言語（日本語、英語、中国語、フランス語、ドイツ語、韓国語）の取扱説明書は以下のURL、HAKKO Document Portalからダウンロードしてご覧いただけます。

（商品によっては設定の無い言語がありますが、ご了承ください）

* 各國語言(日語,英語,中文,法語,德語,韓語)的使用說明書可以通過以下网站的HAKKO Document Portal 下載參閱。
(有一部分的产品沒有設定外語對應,請見諒)

* Instruction manual for the language, Japanese, English, Chinese, French, German and Korean can be downloaded from the following URL, HAKKO Document Portal.

(Please note that some language may not be available depending on the product.)

