

Thank you for purchasing the HAKKO FX-300 soldering pot.  
Please read this manual before operating the HAKKO FX-300.  
Keep this manual readily accessible for reference.

### 1. PACKING LIST AND PART NAMES

Please check to make sure that all items listed below are included in the package.

HAKKO FX-300	1	Hexagon wrench	1
Spatula	1	Instruction manual	1
J-shaped waste collector	1		

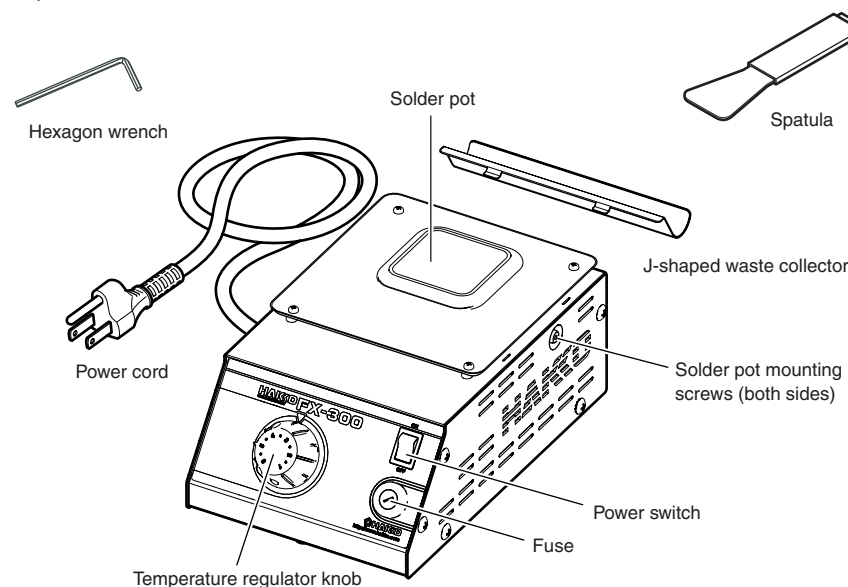

### 2. SPECIFICATIONS

	50 × 50 Square	75 × 75 Square
Power consumption	100V - 195W, 110V - 220W, 120V - 200W, 220V - 190W, 230V - 205W, 240V - 215W	
Temperature range	200 - 450°C (400 - 840°F)	200 - 380°C (400 - 720°F)
Solder pot dimensions	50 (W) × 50 (D) × 43.5 (H) mm (2.0 × 2.0 × 1.7 in.)	75 (W) × 75 (D) × 52.5 (H) mm (3.0 × 3.0 × 2.1 in.)
Molten solder capacity	0.85 kg (1.87 lb.)	1.2 kg (2.64 lb.)
Weight (w/o solder and cord)	1.7 kg (3.74 lb.)	
Outer dimensions	143 (W) × 100 (H) × 220 (D) mm (5.6 × 4.0 × 8.7 in.)	

\* Only a 50 × 50 square solder pot is included in this product.  
\* The 75 × 75 square solder pot is an optional part.  
\* This product meets China RoHS requirements.  
\* Specifications and design are subject to change without notice.

#### 產品中有毒有害物質或元素的名稱及含量

部件名稱	有毒有害物質或元素					
	鉛(Pb)	汞(Hg)	鎘(Cd)	六價鉻(Cr(VI))	多溴聯苯(PBB)	多溴二苯醚(PBDE)
插頭	×	○	○	○	○	○

○：表示該有毒有害物質在該部件所有均質材料中的含量均在SJ/T 11363-2006標準規定的限量要求以下。  
×：表示該有毒有害物質至少在該部件的某一均質材料中的含量超出SJ/T 11363-2006標準規定的限量要求。

注有「附帶BS插頭」之時，表示「插頭」為含有有害物質的部件。

### 3. SAFETY INSTRUCTIONS

#### ⚠ WARNING

Warnings, cautions and notes are placed at critical points in this manual to direct the operator's attention to significant items. They are defined as follows:

- ⚠ **WARNING:** Failure to comply with a WARNING may result in serious injury or death.
- ⚠ **CAUTION:** Failure to comply with a CAUTION may result in injury to the operator, or damage to the items involved. Two examples are given below.

#### ⚠ WARNING

When the power is ON, the temperature of the melted solder in the solder pot is approximately 450°C/842°F. Before changing the solder pot, be sure to unplug the power cord and let the solder and the unit cool to room temperature.

Observe the following precautions to ensure safety.

#### ⚠ CAUTION

The molten solder in the solder pot is dangerous since it reaches about 450°C/842°F. The pot cover also becomes a high temperature when the power is ON. Wrong handling may cause burns or fire. Be sure to observe the following precautions.

- Use this product on highly stable metal workbench. Never use it near paper or other flammable materials.
- Inform others in the area that the product is hot and should not be touched.
- Never put water in the solder pot as this will cause solder to spatter out of the solder pot.
- Turn the power off when not in use, or left unattended.
- Before changing parts or storing the unit, be sure to turn the power off and allow the unit to cool to room temperature.

Observe the following precautions to prevent accidents or damage to the unit.

- Do not use the HAKKO FX-300 for applications other than soldering.
- Do not modify the HAKKO FX-300.
- Use only genuine HAKKO replacement parts.
- Do not allow the HAKKO FX-300 to become wet, or use it with wet hands.
- Be sure the work area is well ventilated. Soldering produces smoke.
- Do not do anything else that might be dangerous.

### 4. INITIAL SETUP

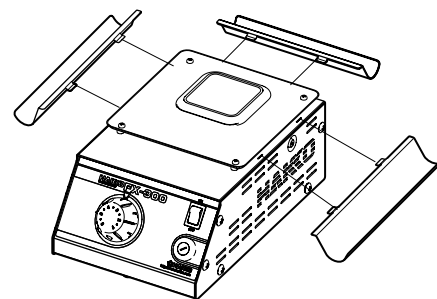

1. Install the J-shaped waste collector to the unit. (Three-way installation is possible to meet your operating needs.)
2. Cut the solder sticks into small pieces and put them in the solder pot.
3. Plug the power cord into a grounded wall socket.

#### ⚠ CAUTION

Make sure the power switch is off before plugging in the power plug.

### 5. OPERATION

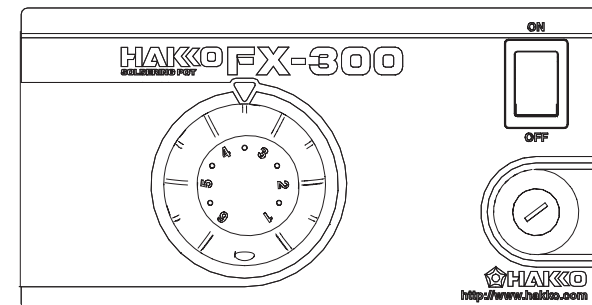

#### Temperature regulator knob

The set temperature can be changed with the temperature regulator knob. Turning the knob clockwise increases the set temperature and turning the knob counterclockwise decreases the set temperature.

1. Turn the power switch ON.
2. The temperature control is started, causing the temperature to increase.

Knob	Temperature (50 × 50 Square)	Temperature (75 × 75 Square)
1-3	Approximately 200°C (400°F)	Approximately 200°C (400°F)
3-4	Approximately 300°C (570°F)	Approximately 300°C (570°F)
4-5	Approximately 400°C (750°F)	Approximately 350°C (660°F)
5-6	Approximately 450°C (840°F)	Approximately 380°C (720°F)

#### NOTE:

Temperature depends on a soldering pot. Please use the table above as a guide. Measure an exact temperature by the FG-100 or the FG-101 with an applicable temperature probe if necessary.

## 6. MAINTENANCE

### ⚠ WARNING

Unless otherwise directed, carry out these procedures after turning the power switch OFF, unplugging the power plug and waiting for both the unit and the solder to sufficiently cool down.

### ● Changing the solder pot

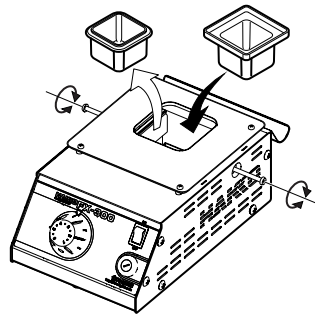

- Using the hexagon wrench (provided with the HAKKO FX-300) to loosen the screws on both sides of the unit.

**NOTE:**  
Screws do not have to be removed.

- Pull out the solder pot.
- Insert a new solder pot and then tighten the screws on both sides.

### ⚠ CAUTION

Check that the solder pot has been locked now. Otherwise, the temperature may not increase properly.

### ⚠ WARNING

When the power is ON, the temperature of the melted solder in the solder pot is approximately 450°C/842°F. Before changing the solder pot, be sure to unplug the power cord and let the solder and the unit cool to room temperature.

### ● Replacing the heating element

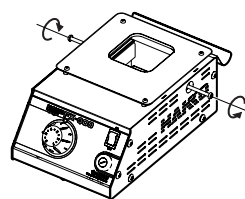

Fig. 1

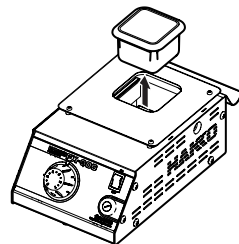

Fig. 2

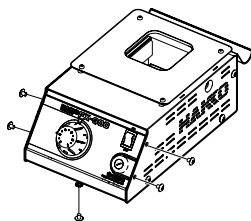

Fig. 3

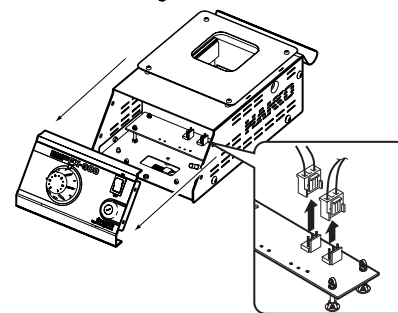

Fig. 4

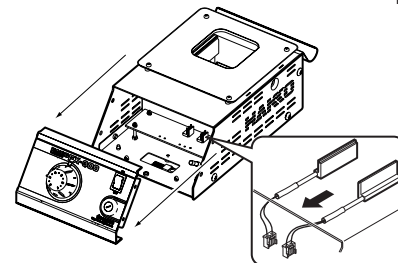

Fig. 5

- Loosen the screws on both sides of the unit. (Fig. 1)

**NOTE:**  
Screws do not have to be removed.

- Pull out the solder pot. (Fig. 2)

- Remove the setscrews (5 pieces) on the unit. (Fig. 3)

- Slide the front panel forward, disconnect the two connectors (Fig. 4) from the connector circuit board, and then pull out the units of the heating elements (Fig. 5).

- Insert the right and left heating elements in the reverse procedure to removing the heating elements.

### ⚠ CAUTION

The heating element is a discrete type.

### ● Daily Check

Solder gradually corrodes and makes holes through the stainless solder pot, which can lead to solder leakage from the holes.

Daily check and replacement (if necessary) of the solder pot is recommended to ensure comfortable and safe execution of work.

**⚠ CAUTION**  
Make sure that the solder pot has sufficiently cooled down before performing the daily check.

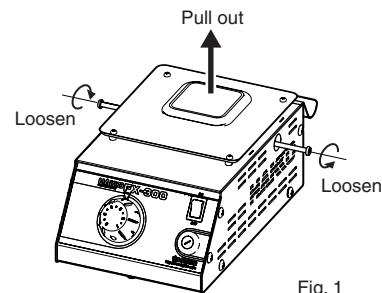

Fig. 1

### CHECK!

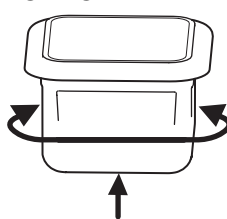

Fig. 2

### CHECK

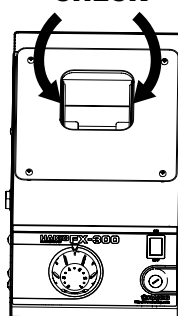

Fig. 3

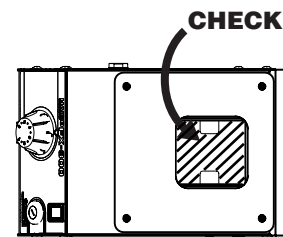

Fig. 4

## 7. TROUBLE SHOOTING GUIDE

### ⚠ WARNING

Before checking the inside of the FX-300 or replacing parts, be sure to disconnect the power plug.

- The unit does not operate when the power switch is turned on.

**CHECK** : Is the power cord and/or the connection plug disconnected?  
**ACTION** : Connect it.

**CHECK** : Is the fuse blown?  
**ACTION** : Investigate why the fuse blew and then replace the fuse. If the cause can not be determined, replace the fuse. If the fuse blows again, send the unit in for repair.

## 8. PARTS LIST

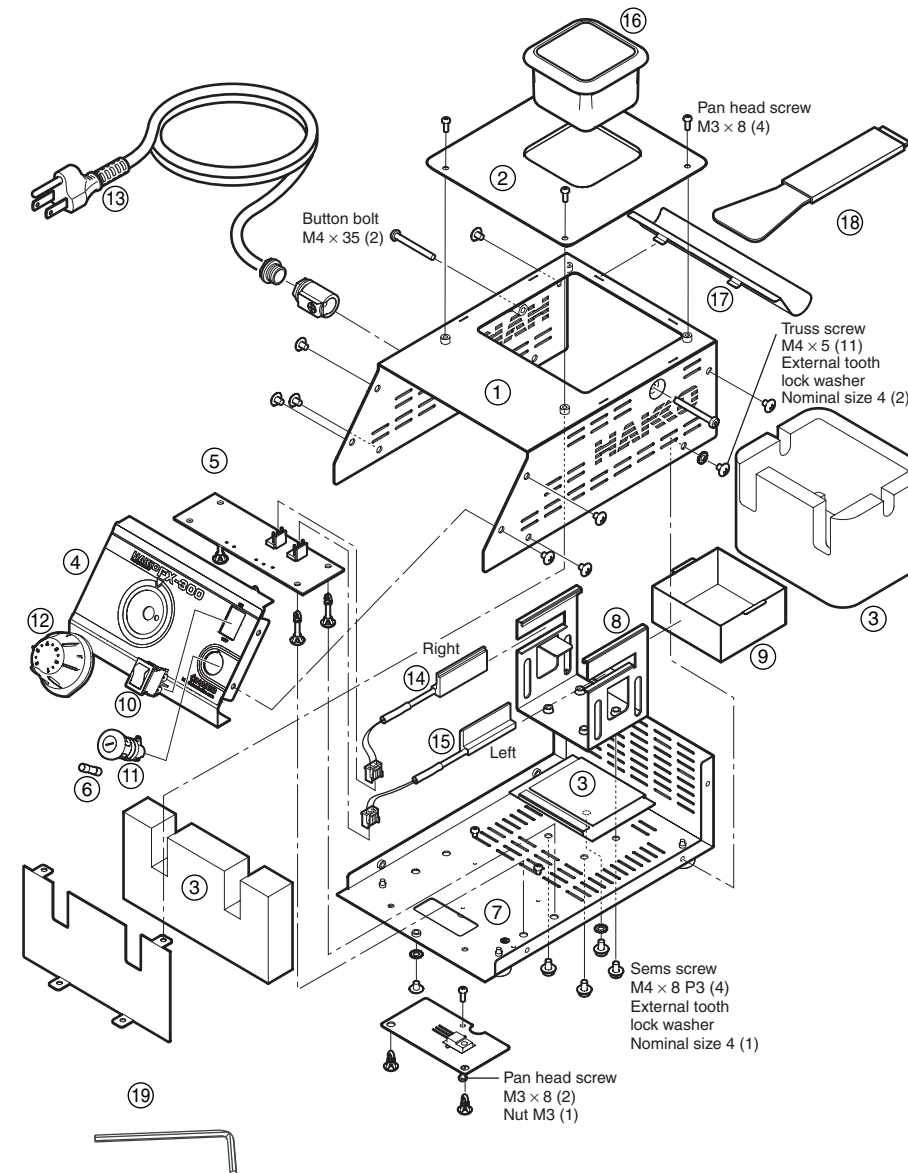

### ● FX-300 Soldering pot

Item No.	Part No.	Part Name	Specifications
①	B3382	Cover	
②	B2918	Overflow tray	
③	B2916	Heat insulator	
④	B3383	Front panel	With membrane sheet
⑤	B3385	P.W.B.	100 - 110V
	B3386	P.W.B.	120V
	B3387	P.W.B.	220 - 240V
	B2705	Midget fuse/125V-5A	100 - 110V
	B2468	Fuse/125V-5A	120V
⑥	B2922	Fuse/250V-5A	220 - 240V
	B3045	Fuse/250V-5A CE	230V CE, KTL
	B3384	Chassis	With rubber feet
⑧	B2927	Solder pot support	
⑨	B2928	Solder pot tray	
⑩	B1487	Power switch	100 - 120V
	B2604	Power switch	220 - 240V
⑪	B1134	Fuse holder	
⑫	B3348	Knob	
⑬	B1238	Power cord, 2 wired cord & flat 2 pin plug	
	B1795	Power cord, 3 wired cord & American plug	
	B1796	Power cord, 3 wired cord but no plug	
	B2913	Power cord, 3 wired cord & BS plug	
	B2914	Power cord, 3 wired cord & Chinese plug	
	B1797	Power cord, 3 wired cord & European plug	KTL, CE
	B1798	Power cord, 3 wired cord & Australian plug	
	B3046	Power cord, 3 wired cord & BS plug CE	

### ● Replacement parts

Item No.	Part No.	Part Name	Specifications
⑭	A1551	Heating element/Right	100 - 110V
	A1553	Heating element/Right	120V
	A1549	Heating element/Right	220 - 240V
⑮	A1552	Heating element/Left	100 - 110V
	A1554	Heating element/Left	120V
	A1555	Heating element/Left	220 - 240V
⑯	A1517	Solder pot	50 × 50 × 43.5(mm) /2.0 × 2.0 × 1.7(in.)
⑰	B2919	J-shaped waste collector	
⑱	B2932	Spatula	
⑲	B1417	Hexagon wrench	

### ● Optional parts

Part No.	Part Name	Specifications
A1539	Solder pot	Special coating 50 × 50 × 43.5(mm) /2.0 × 2.0 × 1.7(in.)
A1540	Solder pot	Special coating 75 × 75 × 52.5(mm) /3.0 × 3.0 × 2.1(in.)
A1518	Solder pot	75 × 75 × 52.5(mm) /3.0 × 3.0 × 2.1(in.)