

HIOKI

3126-01

PHASE DETECTOR

INSTRUCTION MANUAL

June 2002 Revised edition 7 Printed in Japan
3126A980-07 02-06H

Introduction

Thank you for purchasing the HIOKI "3126-01 PHASE DETECTOR". To obtain maximum performance from the product, please read this manual first, and keep it handy for future reference.

HIOKI E. E. CORPORATION

HEAD OFFICE

81 Koizumi, Ueda, Nagano 386-1192, Japan
TEL +81-268-28-0562 / FAX +81-268-28-0568
E-mail: os-com@hioki.co.jp URL http://www.hioki.co.jp/

HIOKI USA CORPORATION

6 Corporate Drive, Cranbury, NJ 08512, USA
TEL +1-609-409-9109 / FAX +1-609-409-9108

Inspection and Maintenance

Initial Inspection

When you receive the product, inspect it carefully to ensure that no damage occurred during shipping. If damage is evident, or if it fails to operate according to the specifications, contact your dealer or Hioki representative.

Preliminary Checks

- Before using the product the first time, verify that it operates normally to ensure that no damage occurred during storage or shipping. If you find any damage, contact your dealer or Hioki representative.
- Before using the product, make sure that the insulation on the cables and the protective tube of the fuse holder is undamaged and that no bare conductors are improperly exposed. Using the product in such conditions could cause an electric shock, so contact your dealer or Hioki representative for repair.

Maintenance and Service

- To clean the product, wipe it gently with a soft cloth moistened with water or mild detergent. Never use solvents such as benzene, alcohol, acetone, ether, ketones, thinners or gasoline, as they can deform and discolor the case.
- To verify that the product operates normally, connect the tester to a three-phase power supply that has a correct phase order and make sure that the indicator dial rotates in the direction of the arrow.
- If the product seems to be malfunctioning, your dealer or Hioki representative. Pack the product carefully so that it will not be damaged during shipment, and include a detailed written description of the problem. Hioki cannot be responsible for damage that occurs during shipment.



Specifications

Voltage range	110 to 480 V
Permissible time limits	110 V: continuous 220 V: 30 minutes 480 V: 4 minutes
Frequency range	40 to 70 Hz
Using position	Horizontal position $\pm 15^\circ$
Operating temperature & humidity	0 to 40°C (32 to 104°F), 70%RH or less (non-condensating)
Storage temperature & humidity	-10 to 50°C (14 to 122°F), 70%RH or less (non-condensating)
Dielectric strength	2000 VAC for 1 minute (between circuit and product, at 50/60 Hz)
Insulation resistance	100 M Ω or more/500 VDC (between circuit and product)
Connection cable length	1.2 m (472.44")
Accessories	Carrying case, Instruction manual, Protective fuse (7012540 (made by SIBA Inc.), Rating FF0.5 A/700 V non-arcing (6.35 dia. x 32 mm))
Dimensions and mass	70W x 95H x 55D mm (2.76"W x 3.74"H x 2.17"D) 280 g (9.9 oz.)





Safety

Follow these precautions to ensure safe operation and to obtain the full benefits of the various functions.

Safety Symbol

	In the manual, the  symbol indicates particularly important information that the user should read before using the product.
---	--

The following symbols in this manual indicate the relative importance of cautions and warnings.

-  **DANGER** Indicates that incorrect operation presents an extreme hazard that could result in serious injury or death to the user.
-  **WARNING** Indicates that incorrect operation presents a significant hazard that could result in serious injury or death to the user.
-  **CAUTION** Indicates that incorrect operation presents a possibility of injury to the user or damage to the product
-  **NOTE** Advisory items related to performance or correct operation of the product.

Usage Notes

This manual contains information and warnings essential for safe operation of the product and for maintaining it in safe operating condition. Before using the product, be sure to carefully read the following safety notes.

DANGER

The maximum rated working voltage is 480 VrmsAC. Attempting to measure voltage in excess of the maximum rating could destroy the product and result in personal injury or death.

WARNING

- To avoid electric shock, do not allow the product to get wet, and do not use it when your hands are wet.
- To avoid electric shock when measuring live lines, wear appropriate protective gear, such as insulated rubber gloves, boots and a safety helmet.
- Do not use the product where it may be exposed to corrosive or combustible gases. The product may be damaged or cause an explosion.
- To avoid electric shock, turn off the power before attaching a clip, and then turn on the power to measure.

CAUTION

- Do not store or use the product where it could be exposed to direct sunlight, high temperature or humidity, or condensation. Under such conditions, the product may be damaged and insulation may deteriorate so that it no longer meets specifications.
- To avoid damage to the product, protect it from vibration or shock during transport and handling, and be especially careful to avoid dropping.

NOTE

- Continuous use for long periods of time may be dangerous. Be sure to use the tester within the maximum permissible use times given above.
- If the power voltage is unknown, be sure to check it first with a voltmeter before connection the tester.
- This tester is designed to be used in the horizontal position ($\pm 15^\circ$). Using it in other attitudes may prevent the dial from rotating, and cause faulty readings.

Features

The ABS case and all movable components are resistant to vibration and impact, providing the strength needed for field application. And its compact size and light weight provides superior portability. In addition, the leads are color-coded to match the dial, making it easy to tell R, S and T leads from each other.

Measurement Procedure

Connect the tester to a three-phase circuit. If the circular dial rotates in the direction of the arrow, the phase connection order is RST.

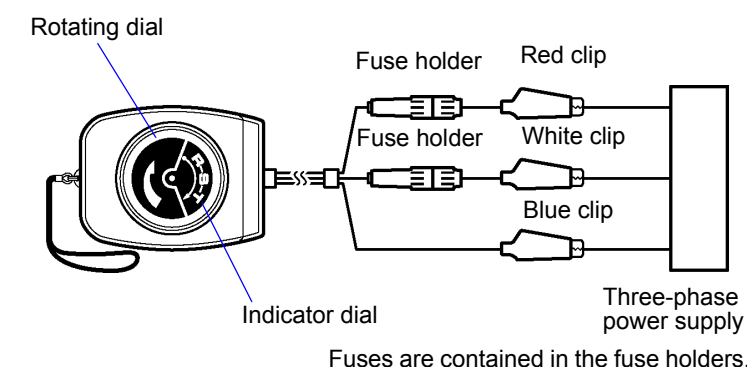

Fuse Replacement

WARNING

- To avoid electric shock when replacing the fuse, first disconnect the clip from the object to be measured.
- Replace the fuse only with one of the specified characteristics and voltage and current ratings. Using a non-specified fuse or shorting the fuse holder may cause a life-threatening hazard. Fuse type: 7012540 (made by SIBA Inc.), Rating FF0.5 A/700 V (non-arcing) 6.35 X 32 mm dia.

CAUTION

The leads on the clip side of the fuse holders do not rotate independently of the fuse holders. To avoid damaging the leads, do not turn the fuse holders unless the leads are free to turn with them.

1. Open the fuse holder by turning one end counterclockwise.
2. Replace the fuse inside the fuse holder.
3. Close the fuse holder by pushing the ends back together, then turning one end clockwise.

