

3151

EARTH HiTESTER

INSTRUCTION MANUAL

Contents

Introduction	i
Inspection	i
Safety Notes	ii
Notes on Use	vi
Chapter 1 Outline	1
1.1 Product Outline	1
1.2 Features	2
1.3 Names and Functions of Parts	4
Chapter 2 Specifications	7
2.1 General Specifications	7
2.2 Measurement Range and Tolerances	9
Chapter 3 Technical Information	11
3.1 Earthing Resistance	11
3.2 Measurement Principle	13
Chapter 4 Measurement Procedure	15
4.1 Preparations	16
4.2 Normal Measurement (3-Pole Method)	17
4.3 Simplified Measurement (2-Pole Method)	22
4.4 Using the Earthing Net	28
4.5 Measurement Precautions and Hints	29
Chapter 5 Maintenance and Service	35
5.1 Attaching the Hand Strap	35
5.2 Changing the Batteries	36
5.3 Cleaning the Unit	38
5.4 Service	38

Introduction

Thank you for purchasing the HIOKI"3151 EARTH HiTESTER." To obtain maximum performance from the instrument, please read this manual first, and keep it handy for future reference.

Inspection

When you receive the instrument, inspect it carefully to ensure that no damage occurred during shipping. In particular, check the accessories, panel switches, and connectors. If damage is evident, or if it fails to operate according to the specifications, contact your dealer or Hioki representative.

Accessories

9214 AUXILIARY EARTHING RODS (two)

9215 MEASURING CABLE
(black 5 m, yellow 10 m, red 20 m)

9216 CABLE WINDER (with 9215) (three)

9393 CARRYING CASE

Hand strap

Instruction manual

R6P Manganese batteries (six)







Safety Notes

This manual contains information and warnings essential for safe operation of the instrument and for maintaining it in safe operating condition. Before using the instrument, be sure to carefully read the following safety notes.





 **DANGER**

This instrument is designed to comply with IEC 61010 Safety Standards, and has been thoroughly tested for safety prior to shipment. However, mishandling during use could result in injury or death, as well as damage to the instrument. Be certain that you understand the instructions and precautions in the manual before use. We disclaim any responsibility for accidents or injuries not resulting directly from instrument defects.

Safety Symbols

	<ul style="list-style-type: none"> • The  symbol printed on the instrument indicates that the user should refer to a corresponding topic in the manual (marked with the  symbol) before using the relevant function. • In the manual, the  symbol indicates particularly important information that the user should read before using the instrument.
	<p>Indicates a double-insulated device.</p>
	<p>Indicates AC (Alternating Current).</p>

The following symbols in this manual indicate the relative importance of cautions and warnings.

	<p>Indicates that incorrect operation presents an extreme hazard that could result in serious injury or death to the user.</p>
	<p>Indicates that incorrect operation presents a significant hazard that could result in serious injury or death to the use.</p>
	<p>Indicates that incorrect operation presents a possibility of injury to the user or damage to the instrument.</p>
	<p>Indicates advisory items related to performance or correct operation of the instrument.</p>

Overvoltage categories (CAT)

This instrument complies with CAT II safety requirements.

To ensure safe operation of measurement instruments, IEC 60664 establishes safety standards for various electrical environments, categorized as CAT I to CAT IV, and called overvoltage categories. These are defined as follows.

- CAT I : Secondary electrical circuits connected to an AC electrical outlet through a transformer or similar device.
- CAT II : Primary electrical circuits in equipment connected to an AC electrical outlet by a power cord (portable tools, household appliances, etc.)
- CAT III : Primary electrical circuits of heavy equipment (fixed installations) connected directly to the distribution panel, and feeders from the distribution panel to outlets.
- CAT IV : The circuit from the service drop to the service entrance, and to the power meter and primary overcurrent protection device (distribution panel).

Higher-numbered categories correspond to electrical environments with greater momentary energy. So a measurement device designed for CAT III environments can endure greater momentary energy than a device designed for CAT II.

Using a measurement instrument in an environment designated with a higher-numbered category than that for which the instrument is rated could result in a severe accident, and must be carefully avoided.

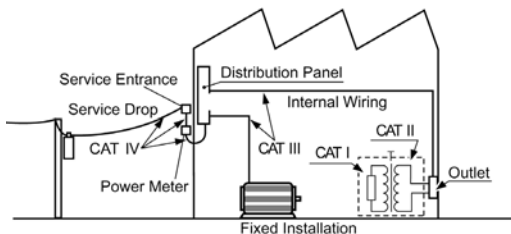



Notes on Use

Follow these precautions to ensure safe operation and to obtain the full benefits of the various functions.

⚠ DANGER

- **When measuring earthing resistance, a voltage of maximum 50 Vrms exists across the measurement terminals E - C(H). Take proper precautions against electric shock.**
- **When performing a simplified measurement (2-pole method) with the instrument connected to the earth side of a household power supply (AC outlet), take proper precautions against electric shock.**

 **WARNING**

- Do not allow the instrument to get wet, and do not take measurements with wet hands. This may cause an electric shock. Take appropriate care when using the instrument outdoors.
- Do not use the instrument where it may be exposed to corrosive or combustible gases. The instrument may be damaged or cause an explosion.
- Do not power the instrument from sources other than batteries, to prevent damage and the risk of electric shock.
- Before using the instrument, make sure that the insulation on the measuring cable is undamaged and that no bare conductors are improperly exposed. Using the instrument in such conditions could cause an electric shock, so contact your dealer or Hioki representative for replacements. (Model 9215).

 **CAUTION**

- Do not store or use the instrument where it could be exposed to direct sunlight, high temperature or humidity, or condensation. Under such conditions, the instrument may be damaged and insulation may deteriorate so that it no longer meets specifications.
- Although this instrument is dust resistant, it is not completely dust- or waterproof. To prevent possible damage, avoid using in dusty or wet environments.
- To avoid damage to the instrument, protect it from physical shock when transporting and handling. Be especially careful to avoid physical shock from dropping.

Chapter 1

Outline

1.1 Product Outline

The earthing (grounding) of electrical equipment is essential in maintaining safety and protecting lives, as well as preventing damage to equipment.

This instrument uses the AC phase differential system to measure earthing resistance. This assures accurate measurements unaffected by earth voltage and auxiliary earthing resistance.

1.2 Features

(1) High performance

Performance of this instrument surpasses the requirements of the Japanese standard JISC-1304-1995 and complies with the safety standard IEC 61010.

(2) Wide measurement range

Measurement scope was extended to 115% of the earthing resistance measurement range. This is useful especially in the 10 Ω and 100 Ω measurement modes which are important for earthing evaluation during electrical installation work.

(3) Auxiliary earthing resistance check function

Auxiliary earthing resistance can be checked for each pole, in order to evaluate possible influences upon the measurement.

(4) Switchable measurement frequency

Measurement frequency can be changed by the user, to minimize the influence of harmonic earth voltage and to assure stable measurement.

(5) Simplified measurement function

Simplified earthing resistance measurement is possible using the earth of an AC outlet.

(6) Over-voltage protection and warning buzzer

When an AC outlet is used for simplified measurement and a voltage is input by mistake, the protection circuit is activated and a warning tone is heard.

(7) Semi-dust-proof construction

Measurement switches, indicators and other moving parts are designed to withstand use in tough environments.

(8) Easy to use

The supplied carrying case is designed to hold the instrument and all accessories. A cable winder is standard, making it easy to deploy and store measurement leads.

1.3 Names and Functions of Parts

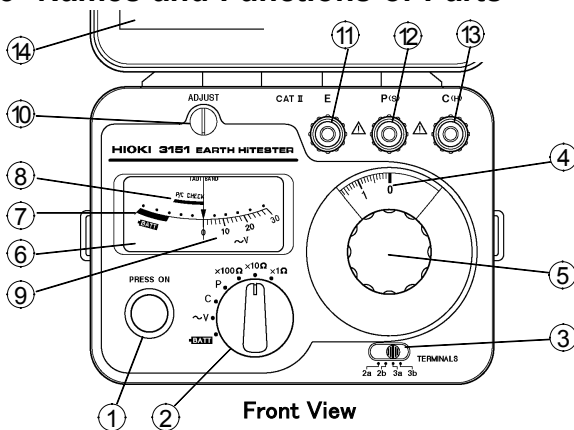

- ① Measurement button (PRESS ON)
Press this button for earthing resistance measurement, auxiliary earthing resistance check, and battery check.
- ② Range selector
Serves to switch the instrument to battery check, earth voltage measurement, auxiliary earthing resistance check, and earthing resistance measurement.
- ③ 2/3 pole measurement selector (TERMINALS)
Serves to switch between 2-pole measurement (simplified measurement) and 3-pole measurement. Also serves to switch the measurement frequency (a/b) to reduce the influence of harmonic earth voltage.

④ Resistance dial

The measured resistance value can be read from this dial.

⑤ Dial knob

⑥ Galvanometer

⑦ Battery effective range

⑧ Auxiliary earthing resistance effective range

⑨ Earth voltage scale

⑩ ADJUST: Zero adjustment

⑪ E: Earth terminal

This terminal is to be connected to the earth of the measurement object.

⑫ P (S): Probe terminal

Terminal for potential detection

⑬ C (H): Auxiliary earthing terminal

This terminal supplies measurement current.

⑭ Explanation label

Contains brief instructions and instrument specifications.

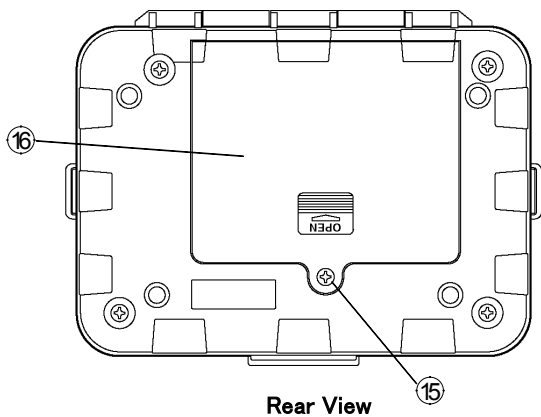

⑮ Fixing screw on the battery cover

⑯ Battery cover

Chapter 2

Specifications

2.1 General Specifications

Operating system	AC potentiometer
Display Method	Resistance indication on meter with linear scale galvanometer
Open circuit voltage	50 V AC max
Measurement current	15 mA AC max (using the 2-pole method: 3 mA AC max)
Measurement frequency	575 Hz (during setting to 2a or 3a) 600 Hz (during setting to 2b or 3b)
Operating temperature and humidity range	0 to 40°C (32°F to 104°F), 80% RH or less (with no condensation)
Storage temperature and humidity range	-10 to 50°C (14°F to 122°F), 80% RH or less (with no condensation)
Usage range	Instrument is designed for earthing resistance measurements in locations up to a height of 3,000 meters (except farms)
Power supply	Six R6P manganese batteries or six LR6 alkaline batteries Rated supply voltage: 1.5 V x 6
Maximum rated power	2.5 VA max

Battery Life	More than 500 times (R6P in use) or more than 1400 (LR6 in use) (30-second measurement/30-second pause cycle)
Overvoltage protection	250 VAC for one minute between E-P (S) and E-C (H) terminals
Insulation resistance	100 M Ω or more/500 V DC between electric circuit and case
Dielectric voltage	3000 V AC for one minute between electric circuit and case
External dimensions	Approx. 164W x 119H x 88D mm (6.46W" x 4.37H" x 3.47D") (excluding protrusion)
Mass	Approx. 800 g (28.2oz.) (instrument only)
Accessories	9214 AUXILIARY EARTHING ROD 9215 MEASURING CABLE (black 5m, yellow 10 m, red 20 m each one, 9216 CABLE WINDER x 3) 9393 CARRYING CASE R6P manganese battery x 6 Instruction manual, Hand strap
Option	9050 EARTH NETS 30 x 30cm
Standards applying	
Earthing resistance measurement	JIS C1304-1995 EN61557-5:1997
Safety	JIS C1004-1996 EN61010-1:2001 Pollution Degree 2, Measurement Category II (anticipated transient overvoltage 500 V) EN61010-2-031:1994
EMC	EN61326:1997+A1:1998+A2:2001
Environment protection	EN60529:1991 "IP40" JIS C920-1993

2.2 Measurement Range and Tolerances

Accuracy is guaranteed for 1 year at following conditions.
(Temperature and humidity: $23^{\circ}\text{C} \pm 5^{\circ}\text{C}$ ($73^{\circ}\text{F} \pm 5^{\circ}\text{F}$), 80% RH or less)

Measurement item	Measurement range	Tolerances
Earthing resistance (Ω)	10 (0 to 11.5) 100 (0 to 115) 1000 (0 to 1150)	2.5%f.s.
Earth voltage (V)	30 (0 to 30)	3.0%f.s.

When using 2-pole method, applies 100 Ω and 1000 Ω only

Effect of temperature	Within $\pm 0.1\%/^{\circ}\text{C}$ at 0 to 40°C (32°F to 104°F)
Effect of auxiliary earth resistance	Within $\pm 5\%$ when fluctuation is 0 to 5 k Ω
Effect of earth voltage	Within $\pm 2\%$ at 0 to 5 V Within $\pm 2\%$ at 0 to 10 V (at 50 or 60 Hz) Within $\pm 5\%$ at 0 to 3 V (at DC, 16 2/3, 400 Hz)
Effect of power voltage	Within specifications for 6 - 10 V DC
Effect of radiated radio-frequency electromagnetic field	At 3 V/m Within +2.5%f.s. to -40%f.s. (earthing resistance)

Operating error

(according to EN61557-5, 4.3:1997)

The operating error is calculated by the following combination of the values of influence quantity in the operating range.

$$\text{Operating error (B)} = \pm \left(|A| + 1.15 \sqrt{E_1^2 + E_2^2 + E_3^2 + E_4^2 + E_5^2 + E_7^2 + E_8^2} \right) \\ = \pm 12.8\%$$

Intrinsic error / influence quantity	1	2	3	4
Intrinsic error	±2.5%	A	Reference conditions	Part 5, 6.1
Position	±5.0%	E ₁	Reference position ±90	Part 1, 4.2
Supply voltage	±0.0%	E ₂	At the limits stated by the manufacturer	Part 1, 4.2, 4.3
Temperature	±2.3%	E ₃	0°C and 35°C	Part 1, 4.2
Series interference voltage	±5.0%	E ₄	See 4.2 and 4.3	Part 5, 4.2, 4.3
Resistance of the probes and auxiliary earth electrodes	±5.0%	E ₅	0 to 100 x R _A but 50 kΩ by PC check	Part 5, 4.3
System frequency	—	E ₇	99% to 101% of the nominal frequency	Part 5, 4.3
System voltage	—	E ₈	85% to 110% of the nominal frequency	Part 5, 4.3

1: Error

2: Designation code

3: Reference conditions or specified operating range

4: Requirements or test in accordance with the relevant parts of EN61557

Chapter 3

Technical Information

3.1 Earthing Resistance

Earthing resistance measurements differ from ordinary resistance measurements, due to the factors described below.

(1) Polarization

Because of polarization between the earthing body and the earth ground, using a direct current for measurement is not possible.

(2) Special conditions

Because one pole of the earth resistance measurement object is buried in the ground, it cannot be taken out for measurement. Also, because the earthing resistance is a spreading resistance from the earthing body, it is necessary to use the 3-pole measurement method with sufficient distance between the measuring electrodes.

(3) External noise

When measuring earthing resistance, leakage current from connected equipment, earth voltage caused by earth current, and auxiliary earthing resistance can affect the measurement and cause erroneous readings.

To eliminate such influences as much as possible, the 3151 uses a newly developed AC phase differential method to measure earthing resistance. This assures accurate results also under difficult conditions.

3.2 Measurement Principle

(1) Normal measurement (3-pole method)

Figure 1 shows the basic circuit principle for earthing resistance measurement. The measuring current I , driven by the oscillating voltage of the oscillator, flows through the loop formed as follows: oscillator R_c R_x C.T. If the galvanometer is balanced, the voltage between the measurement terminals E - P(S) is taken as E_x , and the resistance between the measurement terminal E and the slider S of the variable resistor is taken as R_s . The voltage drop at the variable resistor is E_s .

The following equations then apply:

$$E_x = IR_x, E_s = IR_s/n \quad (n: \text{C.T. winding ratio})$$

$$E_x = E_s, \text{ therefore } R_x = R_s/n$$

If the dial connected directly to the sliding resistor has a scale of $1/n$ for R_s , the dial reading corresponds to the earthing resistance R_x .

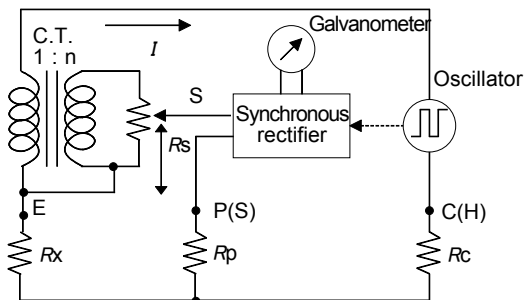

Figure 1 Measurement Principle (3-pole method)

(2) Simplified measurement (2-pole method)

Figure 2 shows the basic circuit principle for a simplified earthing resistance measurement using an existing earthing body.

If the earthing resistance of the existing earthing body is taken as R_o and the earthing resistance of the measurement object as R_x , the same equation as for the 3-pole method applies:

$$R_x + R_o = R_s/n$$

Therefore, the earthing resistance can be found by adding the earthing resistance of the existing earthing body (R_o) to the earthing resistance of the measurement object (R_x).

The 3151 uses a very low measurement current, so that the leakage current circuit breaker of a household power supply will not be tripped when the grounded side of an AC outlet is used as existing earthing body.

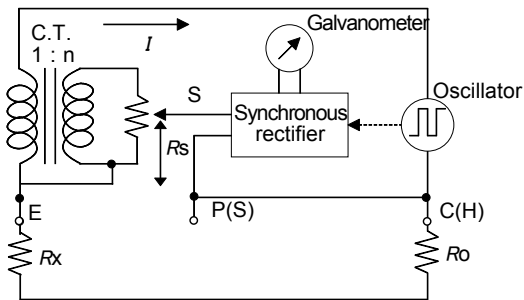

Figure 2 Measurement Principle (2-pole method)



Chapter 4

Measurement Procedure

⚠ WARNING

- When the measurement button (PRESS ON) is operated, a voltage of maximum 50 Vrms AC is produced. Take proper precautions against electric shock.
- When using the grounded side of an AC outlet for simplified measurement, be sure to check the outlet first, to determine the grounded side. Use a suitable checker (electroscope or similar) for this purpose. Take proper precautions against electric shock.

⚠ CAUTION

If the batteries are exhausted, the warning tone will not sound also when a voltage is applied due to a wrong connection. Always check the batteries before starting to use the instrument.



4.1 Preparations

(1) Zero adjustment

Before use, adjust the needle of the galvanometer to the zero point.

Use a small flat-blade screwdriver to turn the ADJUST control until the needle points at the center of the ▼ scale.

This must be performed while the measurement button (PRESS ON) is not depressed.

(2) Battery check

Perform a battery check to verify that the batteries are still good. If exhausted, replace the batteries with fresh ones. (See Section 5.2.)



4.2 Normal Measurement (3-Pole Method)

(1) Connections

Connect the measurement terminals to the measurement object using the supplied measurement leads, as shown in Figure 3. Drive the auxiliary earthing rods P and C deep into the ground, at intervals of 5 - 10 meters (straight line) from the measurement object E.

Measurement terminal	Lead	Object to be connected
E P (S) C (H)	black yellow red	Measurement object E Auxiliary earthing rods P Auxiliary earthing rods C

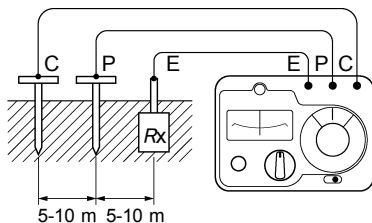

Figure 3 Normal Measurement Connection

NOTE

The ground into which the auxiliary earthing rods are driven should be as humid as possible. If the rods cannot be driven into the ground, such as on concrete surfaces, use the 9050 EARTH NETS available as an option. (See Section 4.4)

(2) Settings for 3-pole measurement

Set the 2/3 pole measurement selector (TERMINALS) to "3a".

NOTE

When using the 3-pole measurement method, measurement can be carried out with a measurement frequency of 575 Hz (3a) or 600 Hz (3b). Normally, you should choose the "3a" setting. If the galvanometer fluctuates during measurement, try choosing the "3b" setting. This reduces the influence of harmonics earth voltage and other extraneous earth voltage components.

(3) Battery check

Set the range selector to **BATT** and press the measurement button (PRESS ON). If the needle of the galvanometer is within the **BATT** range of the scale, the batteries can be used for measurement. Perform this check in the actual measurement condition, with the measurement leads already connected.

NOTE

If the needle of the galvanometer is not within the "BATT" range of the scale, the batteries must be replaced. (See Section 5.2)

(4) Earth voltage check

Set the range selector to $\sim V$ to check for the presence of earth voltage. Do not press the measurement button (PRESS ON) at this time.

 **CAUTION**

- If the measurement button (PRESS ON) is depressed, earth voltage cannot be measured. The needle of the galvanometer may fluctuate or register to the end of the scale. This is not a defect.
- If there is an earth voltage of more than 10 V, the earthing body should be isolated from the electrical installation and power line switches or similar should be turned off in order to minimize the earth voltage for measurement. Also, if the earth voltage is high, a risk of electric shock exists and proper precautions should be taken.

(5) Auxiliary earthing resistance check

The 3151 has a function for checking the auxiliary earthing resistance. Be sure to perform this check before measuring earthing resistance.

The check result should be evaluated as follows: The more the needle of the galvanometer deflects to the left, the higher is the auxiliary earthing resistance. (If the needle remains in the vicinity of the zero point, auxiliary earthing resistance poses no problem.)

① Checking earthing condition of auxiliary earthing rod C

Set the range selector to **C** and press the measurement button (PRESS ON). Verify that the needle of the galvanometer is within the green "P/C CHECK" range.

② Checking earthing condition of auxiliary earthing rod P

Set the range selector to **P** and press the measurement button (PRESS ON). Verify that the needle of the galvanometer is within the green "P/C CHECK" range.

NOTE

- If the needle of the galvanometer is not within the green range, the earthing resistance of the auxiliary earthing rod is too high and accurate measurement results will not be obtained.

Change the position of the rod, and/or make sure that the ground has sufficient humidity (pour water if necessary). Then repeat the check.

- If the 2/3 pole measurement selector (TERMINALS) is set to "2a" or "2b", the check will not give correct results.

(6) Earthing resistance measurement

Set the range selector to a suitable position ($\times 1 \Omega$, $\times 10 \Omega$, $\times 100 \Omega$) and press the measurement button (PRESS ON). While keeping the button depressed, turn the dial knob until the galvanometer is balanced.

(until the needle points at the center of the ▼ scale.)

Then read the indication on the resistance dial and multiply it with the setting of the range selector. The result is the earthing resistance.

NOTE

- In general, you should first choose the $\times 100 \Omega$ setting of the range selector and then reduce the setting as necessary.
- If the 2/3 pole measurement selector (TERMINALS) is set to "2a" or "2b", correct measurement is not possible.
- Balancing the galvanometer is invalid where no scale on the resistance dial.



4.3 Simplified Measurement (2-Pole Method)

 **DANGER**

When using the grounded side of an AC outlet for simplified measurement, be sure to check the outlet first, to determine the grounded side. Use a suitable checker (electroscope or similar) for this purpose.

Take proper precautions against electric shock.

If the 3151 is connected by mistake to the live (hot) side of an outlet and a voltage of 80 V or more is applied to the input, a warning tone (beep) is heard.

In this case, immediately disconnect the leads and check the outlet again.

 **CAUTION**

The warning tone will not sound if the earthing body is not connected to terminal E. Connect terminal E first. When the connection is made by mistake on the power line with the leakage current circuit breaker, the breaker may be tripped before the beep sounds.

The simplified measurement (2-pole method) makes use of an existing earthing body. It should only be used in cases where the auxiliary earthing rods cannot be driven into the ground.

The existing earthing body must have a sufficiently lower resistance than the earthing body to be measured.

When the 2-pole method is used, the measurement current of the 3151 is kept to 3 mA or less, so that the leakage current circuit breaker of a household power supply will not be tripped when the grounded side of an AC outlet is used as an existing earthing body.

NOTE

When using the simplified measurement method, the resistance of the existing earthing body is added to the measurement result.

For measurements in the range of 10 Ω and below, you should always use the normal measurement (3-pole method).



(1) Connections

Figure 4 shows connection for a simplified measurement using the grounded side of a household power supply (AC outlet).

Use the supplied measurement leads to make connections as shown in the illustration.

Set the range switch to **BATT** or $\sim V$, connect terminal E to the measurement object E, and then connect terminal C (H) to the grounded side of the AC outlet.

Measurement terminal	Lead	Connection
E	black	Measurement object E
P (S)		Not connected
C (H)	red/yellow	Ground line (R ₀)

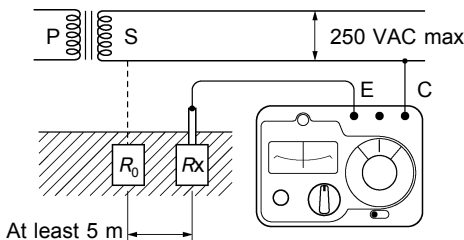

Figure 4 Simplified Measurement Connection

NOTE

A metal water pipe or similar can also be used as existing earthing body for simplified measurement.

The distance between the existing earthing body and the measurement object should be at least 5 meters. If the distance is less, correct results will not be obtained.

(2) Settings for 2-pole measurement

Set the 2/3 pole measurement selector (TERMINALS) to "2a".

NOTE

When using the 2-pole measurement method, measurement can be carried out with a measurement frequency of 575 Hz (2a) or 600 Hz (2b). Normally, you should choose the "2a" setting. If the galvanometer fluctuates during measurement, try choosing the "2b" setting. This reduces the influence of harmonics earth voltage and other extraneous earth voltage components.

(3) Battery check

Set the range selector to **BATT** and press the measurement button (PRESS ON). If the needle of the galvanometer is within the **BATT** range of the scale, the batteries can be used for measurement. Perform this check in the actual measurement condition, with the measurement leads already connected.

NOTE

If the needle of the galvanometer is not within the "BATT" range of the scale, the batteries must be replaced. (See Section 5.2)

(4) Earth voltage check

Set the range selector to $\sim V$ to check for the presence of earth voltage. Do not press the measurement button (PRESS ON) at this time.

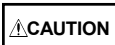

- If the measurement button (PRESS ON) is depressed, earth voltage cannot be measured. The needle of the galvanometer may fluctuate or register to the end of the scale. This is not a defect.
- If there is an earth voltage of more than 10 V, the earthing body should be isolated from the electrical installation and power line switches or similar should be turned off in order to minimize the earth voltage for measurement. Also, if the earth voltage is high, a risk of electric shock exists and proper precautions should be taken.

(5) Auxiliary earthing resistance check

Auxiliary earthing resistance check is not required.

NOTE

When the function **P** or **C** is selected and the measurement button (PRESS ON) is pressed, the needle of the galvanometer may fluctuate or register to the end of the scale. This is not a defect, but the check result is invalid.

(6) Earthing resistance measurement

Set the function switch to a suitable position ($\times 10 \Omega$, $\times 100 \Omega$) and press the measurement button (PRESS ON).

While keeping the button depressed, turn the dial knob until the galvanometer is balanced. Then read the indication on the resistance dial and multiply it with the setting of the range selector. The result is the earthing resistance.

Measurement result = $R_x + R_o$ (combined resistance)

NOTE

- In general, you should first choose the $\times 100 \Omega$ setting of the range selector and then reduce the setting as necessary.
- If the 2/3 pole measurement selector (TERMINALS) is set to "3a" or "3b", correct measurement is not possible. Since the measurement current will be higher in a position for 3-pole measurement, the leakage current circuit breaker of a household power supply may be tripped.
- Balancing the galvanometer is invalid where no scale on the resistance dial.

4.4 Using the Earthing Net

If auxiliary earthing rods cannot be driven into the ground, such as on rock, gravel, or concrete, use the earthing net available as an option.

1. Place the grid flat on the ground, and pour a sufficient amount of water on it to ensure good surface contact.
2. Connect the measurement leads as shown in the illustration, using a clip to connect the lead directly to the grid or placing the auxiliary earthing rod on the grid.
3. Set the range selector to the "P, C" range, verify that the grid has good contact, and perform the measurement.

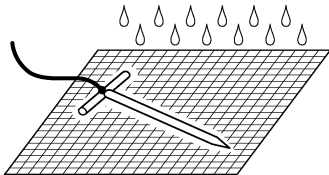
**NOTE**

- On surfaces such as asphalt or similar where water will not permeate the ground, measurement with the earthing net is not possible.
- If the earthing net is not available or if it is too small, a metal plate or other conducting object can be used as a substitute, provided that it is watered sufficiently.

4.5 Measurement Precautions and Hints

(1) Using the auxiliary earthing rods

For 3-pole measurement, two auxiliary earthing rods are required. Be sure to drive the rods well into the ground to assure correct measurement results.

(2) Earthing resistance of auxiliary earthing rods

When the earthing resistance of the auxiliary earthing rods is not higher than about $10\text{ k}\Omega$, the 3151 can carry out correct measurement. However, especially when measuring low earthing resistance values, high earthing resistance of the auxiliary earthing rods can impair measurement sensitivity.

To assure correct measurement results, be sure to check the earthing resistance of the auxiliary earthing rods by setting the range selector to C and P.

If the needle of the galvanometer is within a green band of the scale, the auxiliary earthing resistance is within $5\text{ k}\Omega$.

If check results are unsatisfactory:

Drive the auxiliary earthing rods deep into the ground and water the entire area with a sufficient amount of water. Watering is usually very effective in reducing the contact resistance.

Change the location of the auxiliary earthing rods. Choose a location with high humidity.

If the ground is volcanic rock or sand, the supplied auxiliary earthing rods may not be sufficient. In such a case, use a metal pipe or other conductive object with a large surface and bury it as deep as possible in the ground.

(3) Distance between earthing electrodes

As shown in the figure (a) on the next page, when the distance between E and C is l m, and the distance between the E and P electrodes is varied (x m), the resistance of the earthing body E will measure as shown in the figure (b).

Therefore, when the position of the auxiliary earthing rod P is closer to the earthing body E or the auxiliary earthing rod C, a measurement error occurs.

When the distance between the electrodes E - C is small, the earthing resistance of the measurement object (R_x) and the auxiliary earthing rods cannot be separated, leading to a measurement error.

In the case of an architectural structure which is grounded over a large area, the resistance range of the earthing resistance (R_x) in the figure (a) becomes very wide. This means that it is necessary to position the auxiliary earthing rods (P and C) at a sufficiently large distance from the earthing body (R_x).

To determine the proper distance, move the auxiliary earthing rod P towards the auxiliary earthing rod C and perform measurement at several points. Check whether there is an area where the measured resistance remains approximately constant also when the auxiliary earthing rod P is moved. This corresponds to the horizontal section in the figure (b).

If such an area cannot be found, the measurement distance is not sufficient, and the auxiliary earthing rods P and C should be moved further away from measurement object.

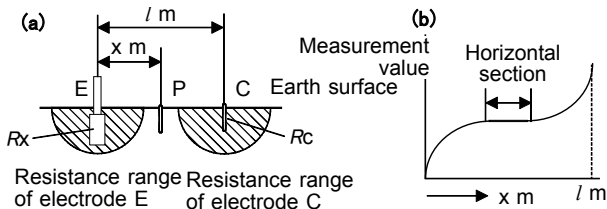

(4) Position relationship of auxiliary earthing rods

The auxiliary earthing rod P should normally be positioned halfway on a straight line between the earthing body E and the auxiliary earthing rod C. If this is not possible due to obstacles or the like, the area within a radius of 5 meters from the earthing body E and the auxiliary earthing rod C should be avoided, and the auxiliary earthing rod P should be positioned on a line not diverging more than 29 degrees from the line between the earthing body E and the auxiliary earthing rod C. This will help to reduce measurement errors.

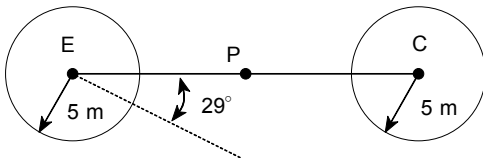

(5) Influence of earth voltage

Due to the presence of leakage current from electrical equipment connected to the earthing body or of earth current, a voltage may exist at the earthing body. If the voltage is less than about 10 V, it will normally not affect the earthing resistance measurement. However, if the earth voltage is distorted, it may cause measurement errors even at lower voltage levels. For this reason, if an earth voltage of more than about 5 V is detected, other electrical equipment should be switched off or the equipment should be disconnected to eliminate the influence of earth voltage on the measurement.

During simplified measurement, harmonic leakage current in the ground line can cause the galvanometer to fluctuate. In such a case, change the setting of the 2/3 pole measurement selector (TERMINALS) from "2a" to "2b" (from "3a" to "3b" for normal measurement). This may allow stable measurement.

If earth voltage is high, the insulation of the electrical path or electrical equipment may have deteriorated. Check the insulation and perform a leakage current test.

(6) Other points

- If the measurement button (PRESS ON) is operated while nothing is connected to the measurement terminals, the galvanometer may register to the end of the scale. This is not a defect.
- When the measurement button (PRESS ON) is operated, a high-pitched tone will be heard from inside the instrument. This is caused by the oscillator and is not a defect.

Chapter 5

Maintenance and Service

5.1 Attaching the Hand Strap

The supplied hand strap is useful for removing the instrument from the carrying case or for carrying the instrument.

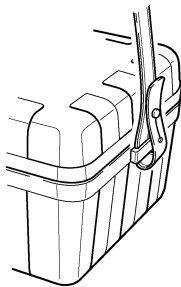

5.2 Changing the Batteries



- To avoid electric shock when replacing the batteries, first disconnect the measuring cable from the object to be measured. After replacing the batteries, replace the cover and screws before using the instrument.
- To avoid the possibility of explosion, do not short circuit, disassemble or incinerate batteries.
- Handle and dispose of batteries in accordance with local regulations.

NOTE

To avoid corrosion from battery leakage, remove the batteries from the instrument if it is to be stored for a long time.

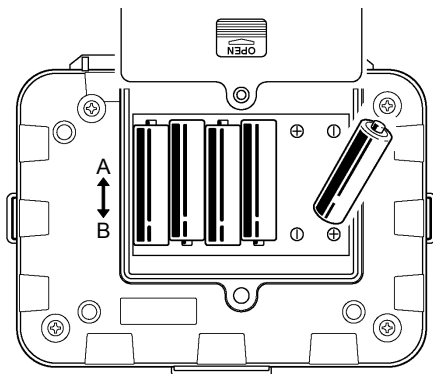

1. For safety, disconnect the measurement leads from the instrument.
2. Remove the fastening screw.
3. Remove the cover of the battery compartment in direction A, as shown in the illustration.
4. Replace all six batteries with fresh ones.
5. Reattach the cover of the battery compartment in direction B, as shown in the illustration.
6. Fasten the battery compartment cover to the instrument with the fastening screw.

5.3 Cleaning the Unit

- After use, wipe the auxiliary earthing rods to remove mud and other contamination. Otherwise the rods may rust.
- To clean the instrument, wipe it gently with a soft cloth moistened with water or mild detergent. Never use solvents such as benzene, alcohol, acetone, ether, ketones, thinners or gasoline, as they can deform and discolor the case.

5.4 Service

- If the instrument seems to be malfunctioning, confirm that the batteries are not discharged, and the measuring cable are not open circuited before contacting your dealer or Hioki representative.
- Pack the instrument carefully so that it will not be damaged during shipment, and include a detailed written description of the problem. Hioki cannot be responsible for damage that occurs during shipment.

HIOKI

DECLARATION OF CONFORMITY

Manufacturer's Name: HIOKI E.E. CORPORATION
Manufacturer's Address: 81 Koizumi, Ueda, Nagano 386-1192, Japan
Product Name: EARTH HITESTER
Model Number: 3151
Accessories: 9215 MEASURING CABLE
9214 AUXILIARY EARTHING ROD
Option: 9050 EARTH NETS

The above mentioned products conform to the following product specifications:

Safety: EN61010-1:2001
EN61010-2-031:1994
EN61557-5:1997
EMC: EN61326:1997+A1:1998+A2:2001
ClassB equipment
Portable test and measurement equipment

Supplementary Information:

The products herewith comply with the requirements of the EMC Directive 89/336/EEC, but is not applicable to the Low Voltage Directive 73/23/EEC.

HIOKI E.E. CORPORATION

21 November 2003

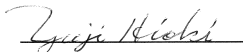

Yuji Hioki

President

3151A999-03

HIOKI 3151 EARTH HiTESTER

Instruction Manual

Publication date: December 2003 Revised edition 6

Edited and published by HIOKI E.E. CORPORATION
Technical Support Section

All inquiries to Sales and Marketing International
Department

81 Koizumi, Ueda, Nagano, 386-1192, Japan

TEL: +81-268-28-0562 / FAX: +81-268-28-0568

E-mail: os-com@hioki.co.jp

URL <http://www.hioki.co.jp/>

Printed in Japan 3151A980-06

- All reasonable care has been taken in the production of this manual, but if you find any points which are unclear or in error, please contact your supplier or the International Sales and Marketing Department at HIOKI headquarters.
- In the interests of product development, the contents of this manual are subject to revision without prior notice.
- Unauthorized reproduction or copying of this manual is prohibited.

HIOKI

HIOKI E. E. CORPORATION

HEAD OFFICE

81 Koizumi, Ueda, Nagano 386-1192, Japan
TEL +81-268-28-0562 / FAX +81-268-28-0568
E-mail: os-com@hioki.co.jp
URL <http://WWW.hioki.co.jp>

HIOKI USA CORPORATION

6 Corporate Drive, Cranbury, NJ 08512, USA
TEL +1-609-409-9109 / FAX +1-609-409-9108

3151A980-06 03-12H



Printed on recycled paper

T  **USA**
Equipment
.NETTM
1-877-742-TEST (8378)