

INSTRUCTION MANUAL

3157

3157-01

AC GROUNDING HiTESTER

HIOKI E. E. CORPORATION

Contents

Introduction	i
Inspection	i
Safety Notes	ii
Notes on Use	iv
Contents and Indications of this Manual	vi
Chapter 1 Overview	1
1.1 Product Introduction	1
1.2 Features of the 3157	2
1.3 Names and Functions of Parts	3
Chapter 2 Testing Arrangements	9
2.1 Power Cord Connection	9
2.2 Powering on and off the Unit	10
2.3 Probe Connection	11
2.4 Short Bar Connection	12
2.5 Connecting the REMOTE CONTROL BOX	13
2.6 Installation Site and Position	14
2.7 Connection to the Measured Object	15
2.8 Connection to the 3155 LEAK CURRENT HiTESTER ..	16
Chapter 3 Testing Method	17
3.1 Procedural Flow for Testing and Setting Parameters ..	18
3.2 Making Testing Arrangements (in READY State)	20
3.2.1 Setting Output Current Values	21
3.2.2 Setting the Maximum (Minimum) Test Value	21
3.2.3 Setting the Testing Time	22
3.2.4 Setting the Output Current Frequency (in READY State)	23
3.2.5 Setting the Test Data Count (in READY State)	23
3.3 Initial Settings for Optional Functions	24
3.4 Zero Adjustment Function	25
3.5 Key-lock Function	26
3.6 Examples of Settings	27
3.7 Starting a Test	29
3.8 Testing (in TEST State)	32
3.9 Screening (in PASS State)	33
3.10 Screening (in FAIL State)	34
Chapter 4 Optional Functions	35
4.1 Switching the Output Current Frequency	38
4.2 PASS/FAIL Hold Function	39
4.3 HOLD Function	40
4.4 Setting the Minimum Test Value	42
4.5 Endless Timer Function	43
4.6 Test Data Count Function	44

4.7	Buzzer Setting	45
4.8	Changing the Current Value in TEST State	46
4.9	Momentary OUT	47
4.9.1	Trigger Operation with Switching Probe	48
4.9.2	Momentary OUT Operation with Switching Probe	50
4.10	Setting the Test Mode	53
4.10.1	Soft Start Mode	53
4.10.2	Normal Mode	55
4.10.3	Continuous Test Mode	56
4.11	Printer Output	58
4.12	Example of Optional Function Settings	60
4.13	Example of Optional Functions Use	62
Chapter 5	Saving/loading Preset Values	65
5.1	Saving Preset Values	65
5.1.1	Procedure for Saving Data	66
5.1.2	Example of Saving	67
5.2	Loading Preset Values	69
5.2.1	Procedure for Loading Data	70
5.2.2	Example of Loading	71
Chapter 6	External I/O	73
6.1	Signal Line	74
6.2	Timing Chart of External I/O Terminal	78
Chapter 7	Maintenance, Inspection and Ultimate Disposal	81
7.1	Maintenance and Inspection	81
7.2	Fuse Replacement	82
7.3	Troubleshooting	83
7.4	Displaying Errors	83
7.5	Resetting the System	84
7.6	Ultimate Disposal (Removal of the Lithium Battery)	85
7.7	External Dimensions	86
Chapter 8	Specifications	87
8.1	Basic Specifications	87
8.2	General Specifications	89
Appendix	APPENDIX1	
Appendix 1	Options	APPENDIX1
Appendix 1.1	9442 PRINTER	APPENDIX1
Appendix 1.2	Probe	APPENDIX2
Appendix 1.3	9613 REMOTE CONTROL BOX (SINGLE)	APPENDIX2
Appendix 1.4	9614 REMOTE CONTROL BOX (DUAL)	APPENDIX3
Appendix 1.5	Interface Board	APPENDIX3
Appendix 2	Table of Optional Functions	APPENDIX4
Appendix 3	Standards	APPENDIX5
Index	INDEX 1	

Introduction

Thank you for purchasing the HIOKI "3157 AC GROUNDING HiTESTER". To obtain maximum performance from the product, please read this manual first, and keep it handy for future reference.

Inspection

When you receive the product, inspect it carefully to ensure that no damage occurred during shipping. In particular, check the accessories, and connectors. If damage is evident, or if it fails to operate according to the specifications, contact your dealer or Hioki representative.

Checking the main unit and accessories

Main unit

"3157 AC GROUNDING HiTESTER"

Accessories

Verify that the following standard accessories are complete.

- (1) Instruction Manual
- (2) Spare fuse (built into the power inlet)
- (3) Grounded three-core power cord
- (4) Short bar (installed between the SOURCE and SENSE terminals) × 2

NOTE

The 9296 CURRENT PROBE and 9297 CURRENT APPLY PROBE are not included. Please purchase separately according to your needs.

Shipment of the unit

Use the original packing materials when reshipping the product, if possible.

Warranty

HIOKI cannot be responsible for losses caused either directly or indirectly by the use of the 3157 with other equipment, or if ownership is transferred to a third party.







Safety Notes

⚠ DANGER





This product is designed to conform to IEC 61010 Safety Standards, and has been thoroughly tested for safety prior to shipment. However, mishandling during use could result in injury or death, as well as damage to the product. Be certain that you understand the instructions and precautions in the manual before use. We disclaim any responsibility for accidents or injuries not resulting directly from product defects.

This manual contains information and warnings essential for safe operation of the product and for maintaining it in safe operating condition. Before using the product, be sure to carefully read the following safety notes.

Safety symbols

	<ul style="list-style-type: none"> • The ⚠ symbol printed on the product indicates that the user should refer to a corresponding topic in the manual (marked with the ⚠ symbol) before using the relevant function. • In the manual, the ⚠ symbol indicates particularly important information that the user should read before using the product.
	Indicates a fuse.
	Indicates AC (Alternating Current).
	Indicates both DC (Direct Current) and AC (Alternating Current).
	Indicates the ON side of the power switch.
	Indicates the OFF side of the power switch.

The following symbols in this manual indicate the relative importance of cautions and warnings.

	Indicates that incorrect operation presents an extreme hazard that could result in serious injury or death to the user.
	Indicates that incorrect operation presents a significant hazard that could result in serious injury or death to the user.
	Indicates that incorrect operation presents a possibility of injury to the user or damage to the product.
	Advisory items related to performance or correct operation of the product.

We define measurement tolerances in terms of rdg. (reading) and dgt. (digit) values, with the following meanings:

rdg. (displayed or indicated value)

The value currently being measured and indicated on the measuring product.

dgt. (resolution)

The smallest displayable unit on a digital measuring product, i.e., the input value that causes the digital display to show a "1".

Measurement categories (Overvoltage categories)

To ensure safe operation of measurement product, IEC 61010 establishes safety standards for various electrical environments, categorized as CAT I to CAT IV, and called measurement categories. These are defined as follows.

CAT I	Secondary electrical circuits connected to an AC electrical outlet through a transformer or similar device.
CAT II	Primary electrical circuits in equipment connected to an AC electrical outlet by a power cord (portable tools, household appliances, etc.)
CAT III	Primary electrical circuits of heavy equipment (fixed installations) connected directly to the distribution panel, and feeders from the distribution panel to outlets.
CAT IV	The circuit from the service drop to the service entrance, and to the power meter and primary overcurrent protection device (distribution panel).

Higher-numbered categories correspond to electrical environments with greater momentary energy. So a measurement device designed for CAT III environments can endure greater momentary energy than a device designed for CAT II. Using a measurement product in an environment designated with a higher-numbered category than that for which the product is rated could result in a severe accident, and must be carefully avoided.

Never use a CAT I measuring product in CAT II, III, or IV environments. The measurement categories comply with the Overvoltage Categories of the IEC60664 Standards.

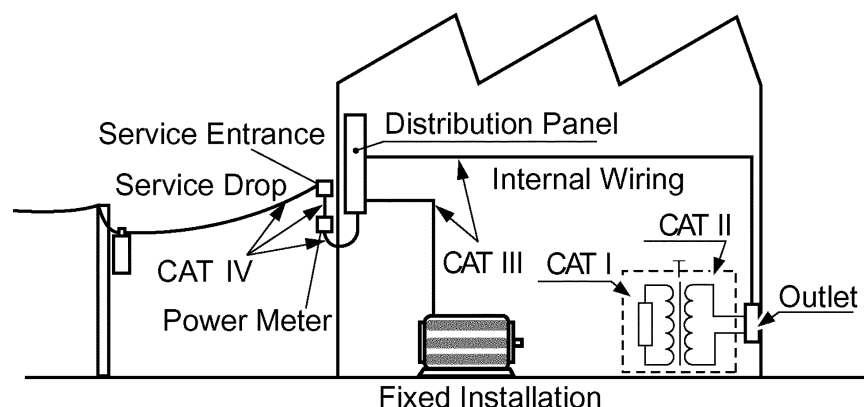

Notes on Use

Follow these precautions to ensure safe operation and to obtain the full benefits of the various functions.

⚠ WARNING

- Before turning the product on, make sure the source voltage matches that indicated on the product's power connector. Connection to an improper supply voltage may damage the product and present an electrical hazard.
 - To avoid electric shock and ensure safe operation, connect the power cable to a grounded (3-contact) outlet.
 - To avoid electric shock, do not remove the cover panel. The internal components of the product carry high voltages and may become very hot during operation.
 - To avoid electric shock, do not allow the product to get wet, and do not use it when your hands are wet.
 - Replace the fuse only with one of the specified characteristics and voltage and current ratings. Using a non-specified fuse or shorting the fuse holder may cause a life-threatening hazard.
(Fuse type: 250 V T3.15 AL)
-
-

⚠ CAUTION

- Before using the product, make sure that the insulation on the probes(9296 or 9297) is undamaged and that no bare conductors are improperly exposed. Using the product in such conditions could cause an electric shock, so contact your dealer or Hioki representative for repair.
- For safety reasons, only use the optional 9296 or 9297 probe for measurement.
- This product should be installed and operated indoors only, between 0 and 40°C and 90%RH max.
- Do not store or use the product where it could be exposed to direct sunlight, high temperature or humidity, or condensation. Under such conditions, the product may be damaged and insulation may deteriorate so that it no longer meets specifications.
- To avoid electrocution, turn off the power to all devices before plugging or unplugging any of the interface connectors.
- To avoid damaging the output cable, grasp the connector, not the cable, when unplugging the cable from the product.
- To avoid damaging probes (especially where the leads connect to the probes), do not kink or pull on the leads.
- Keep in mind that, in some cases, conductors to be measured may be hot.
- Avoid obstructing the ventilation holes on the sides of the 3157, as it could overheat and be damaged, or cause a fire.
- To avoid damage to the product, protect it from vibration or shock during transport and handling, and be especially careful to avoid dropping.
- Do not insert a board other than optional interface boards into the Interface slot. The unit software or calibration data may be lost.
- In the event that the equipment malfunctions in any manner during use, turn off the power immediately, and contact your dealer or HIOKI representative.

NOTE

Do not use the product near a device that generates a strong electromagnetic field or electrostatic charge, as these may cause erroneous measurements.

Contents and Indications of this Manual

- Chapter 1: Overview
Describes an overview, features, and the names and functions of the parts of the unit.
- Chapter 2: Testing Arrangements
Describes particulars of testing arrangements.
- Chapter 3: Testing Method
Describes procedures for setting, testing, and test results judgement.
- Chapter 4: Optional Functions
Describes procedures for setting optional functions.
- Chapter 5: Saving/loading Preset Values
Describes procedure for saving and loading test values.
- Chapter 6: External I/O
Describes use of the external I/O.
- Chapter 7: Maintenance, Inspection and Ultimate Disposal
Covers the maintenance and inspection, fuse replacement, and ultimate disposal.
- Chapter 8: Specifications
Contains the unit specifications such as the general specifications, measurement accuracy, etc. of the unit.
- Appendix:
Covers the options of the unit and standards.

Indications in the Instruction Manual



Indicates that settings can be made for optional functions. For more information, see Chapter 4, "Optional Functions."

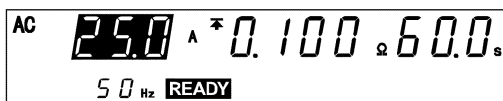

In this Instruction Manual, the flashing area of the screen is represented in reverse mode.

In this figure, for example, the current value of 25.0 A flashes.

Chapter 1

Overview

1.1 Product Introduction

The HIOKI "3157 AC GROUNDING HiTESTER" is designed for protection circuit testing of a wide range of electrical equipment, including industrial machinery, medical equipment, and measuring instruments.

Using a constant current system, the HIOKI 3157 provides stable output current. The unit is capable of accurate four-terminal measurement. The comparator function, timer function, and screening function permit simple testing, conforming to technical standards and regulations.

1.2 Features of the 3157

- (1) **Simple testing procedures conforming to technical standards**

This unit incorporates a constant current method to provide stable output current. Voltage drop is measured with four terminals. The 3157 is also equipped with a function timer and a screening function, using maximum and minimum values, allowing straightforward testing in conformance with applicable technical standards.
- (2) **Test data counting function**

This function enables test point counting for measured objects that have large numbers of test points.
- (3) **Soft-start function**

By constantly monitoring current fluctuations, this function checks that the probe is connected to the measured object. The function also prevents sparking when the probe is connected to a test point after measurement begins.
- (4) **Compact and lightweight**

With a compact lightweight design, the unit is highly portable and well-suited to maintenance measurement.
- (5) **Fluorescent indicator**

The large, easy-to-read fluorescent display permits quick checking of the testing state and result.
- (6) **Probe**

The 3157 is equipped with an alligator-clip probe (the 9296 CURRENT PROBE) and a switching probe (the 9297 CURRENT APPLY PROBE). To improve testing efficiency, the push switch on the switching probe starts testing and inactivates result-checking mode.
- (7) **Saving testing set values**

This unit is provided with a function for saving the set values used in a test, allowing quick switching between different testing set values to meet a variety of standards and regulations. Up to 20 values may be saved.
- (8) **Interface**

By using the optional 9593-02 RS-232C and 9518-02 GP-IB INTERFACE boards, the user can perform automatic testing and save the test results by means of a PC. Test results can be printed on the optional 9442 PRINTER. Connecting with the optional 3155 LEAK CURRENT HiTESTER enables testing and the test results can be saved and printed together with the 3155 leakage current test results.
- (9) **External I/O**

The external I/O terminal generates signals according to the state of the 3157. It can be used to feed signals for the start and stop key.

1.3 Names and Functions of Parts

Front panel

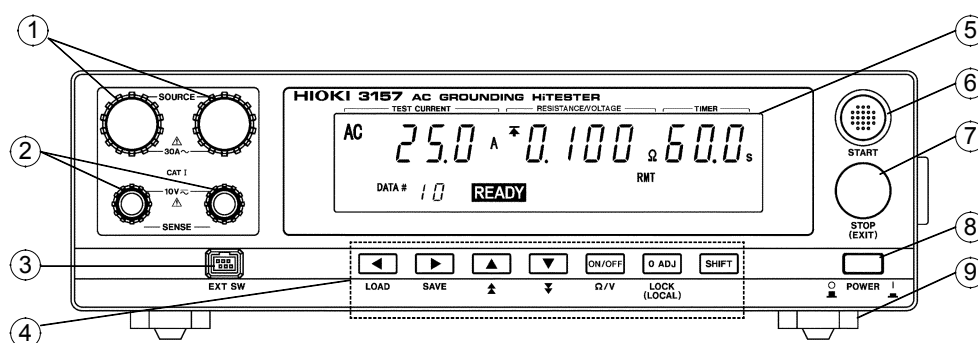

- ① **Current output terminal**
Providing current during a test, this terminal serves as the SOURCE terminal for four-terminal measurement.
- ② **Voltage measurement terminal**
Used to measure voltage. This terminal serves as the SENSE terminal for four-terminal measurement.
- ③ **External switch terminal**
Used for the switch signal line connected to the switching probe (the 9297 CURRENT APPLY PROBE), the 9613 REMOTE CONTROL BOX(SINGLE) or the 9614 REMOTE CONTROL BOX(DUAL).
- ④ **Rubber keys**
The seven rubber keys include six function keys and a **SHIFT** key.
The six function keys offer a variety of settings, used in combination with the **SHIFT** key.
- ⑤ **Fluorescent indicator**
Displays various kinds of information, such as test state and results.
- ⑥ **START key**
Used to start a test. On starting a test with a preset value, the unit enters TEST mode. The test starts whether or not the flashing cursor is displayed.
- ⑦ **STOP key**
 - Used to perform forcible ending of a test.
 - Pressing the STOP key when the flashing cursor is displayed causes it to disappear. To display the flashing cursor again, press the **◀** or **▶** key. The cursor appears, displaying the preset current value.
- ⑧ **Main power switch**
Powers the 3157 on or off.
- ⑨ **Stand**
The 3157 can be tilted up by using this stand.

Rubber keys (in READY state)

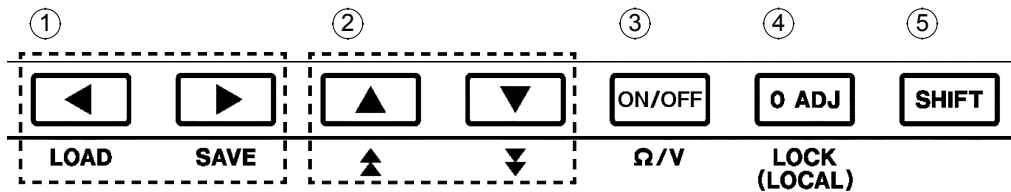

① Left/Right cursor key

Moves the flashing cursor. The switching range is preset before shipment: Preset current value ↔ Maximum Test Value ↔ Testing time ↔ Output Frequency.

The key can be set to shift to the minimum test value and the test data count, when these values are set with the optional functions.

To display the flashing cursor, press the ◀ or ▶ key. The cursor appears, displaying the preset current value.

② Up/Down cursor key

Changes the position at which the flashing cursor appears.

③ ON/OFF (Ω/V) key

Switches on/off the set value for the position of the flashing cursor.

However, this key can't perform the switching on/off of the preset current value. If turned off, the set value is not used in testing.

④ Zero Adjustment key

Use this key to perform zero adjustment within the effective range of adjustment.

The zero adjustment function is active when the 0ADJ lamp is lit.

For zero adjustment procedure, see Section 3.4, "Zero Adjustment Function."

⑤ SHIFT key

Used in combination with other keys.

(1) Switching between voltage and resistance indicators

Press **ON/OFF** (Ω/V) while holding down the **SHIFT** key (**SHIFT** + **ON/OFF** (Ω/V)) to switch between voltage and resistance indicators.

(2) Setting the key lock

Press **SHIFT** + **0ADJ** (LOCK) key to activate key-lock mode.

For more information, see Section 3.5, "Key-lock Function."

(3) Displaying the Preset-data loading screen

Press **SHIFT** + ◀ to display the Preset-data loading screen.

For more information, see Chapter 5, "Saving/loading Preset Values."

(4) Displaying the Preset-data saving screen

Press **SHIFT** + ▶ to display the Preset-data saving screen.

For more information, see Chapter 5, "Saving/loading Preset Values."

(5) Displaying the Optional function setting screen

Press **SHIFT** + **STOP** to display the Optional function setting screen.

For more information, see Chapter 4, "Optional Functions."

Left side view

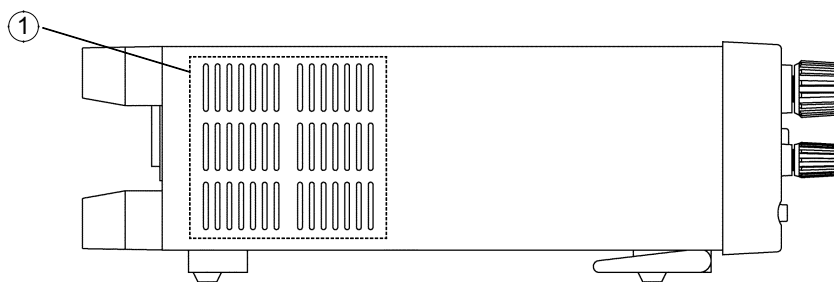

① Air outlet

Never touch the air outlet. The air outlet is provided with an internal cooling fan.

Right side view

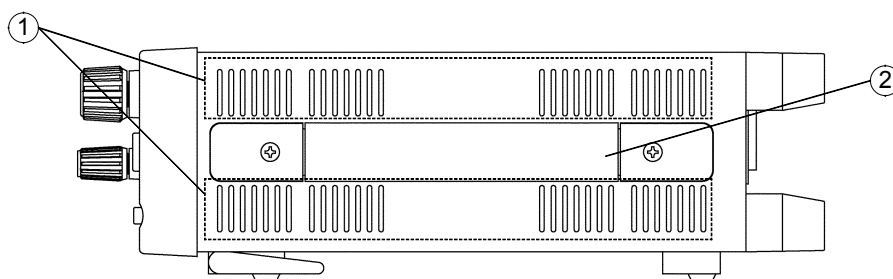

① Air inlet

Never touch the air inlet. Air for cooling is drawn through this opening.

② Handle

This is used for transporting the 3157.

Rear panel

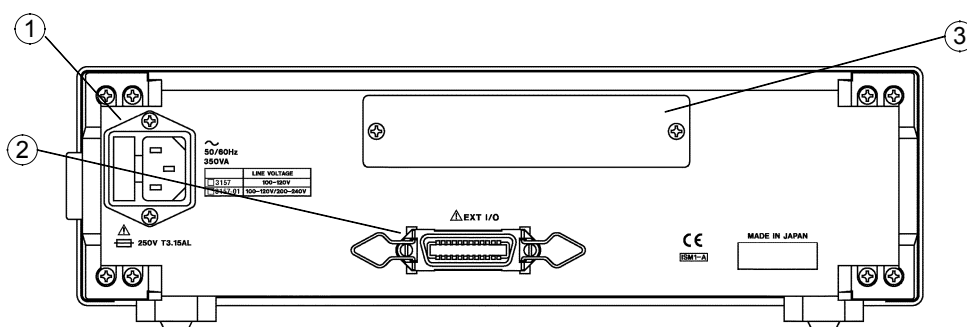

① Power inlet

Connect the grounded three-core power cord supplied here. Integrated with a fuse holder.

② External I/O terminal

For output of 3157 state and input of start and stop signals.

③ Interface slot

Expansion slot for installation of the optional 9593-02 RS-232C INTERFACER or 9518-02 GP-IB INTERFASER board.

9296 CURRENT PROBE

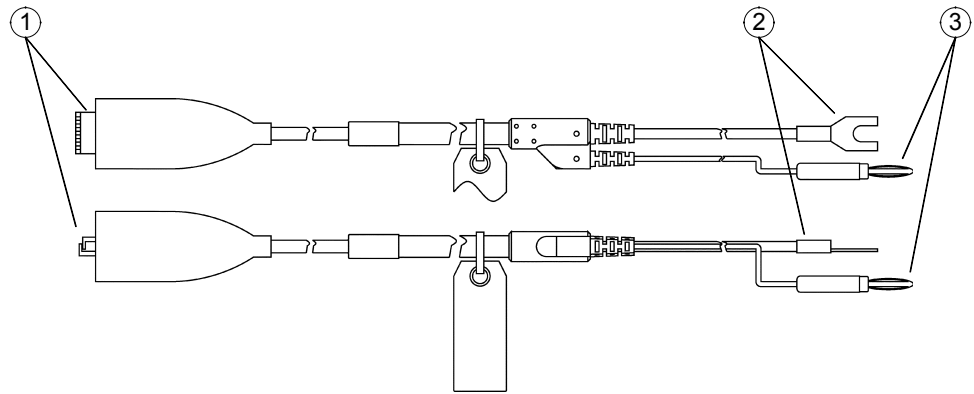

- ① Alligator clip
Clipped to the measured object.
- ② Current output plug
Connected to the unit's current output terminal.
- ③ Banana-type voltage measurement plug
Connected to the unit's voltage measurement terminal.

9297 CURRENT APPLY PROBE

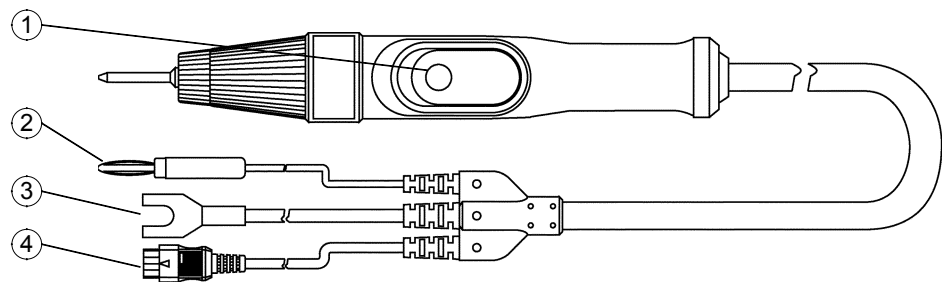

- ① Push switch
External switch equivalent for the **START** and **STOP** keys.
- ② Banana-type voltage measurement plug
Connected to the unit's voltage measurement terminal.
- ③ Current output plug
Connected to the unit's current output terminal.
- ④ Switch signal line plug
Connected to the unit's controller terminal.

REMOTE CONTROL BOX

9613 REMOTE CONTROL BOX (SINGLE)

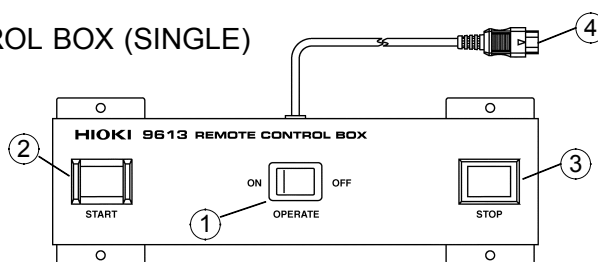

9614 REMOTE CONTROL BOX (DUAL)

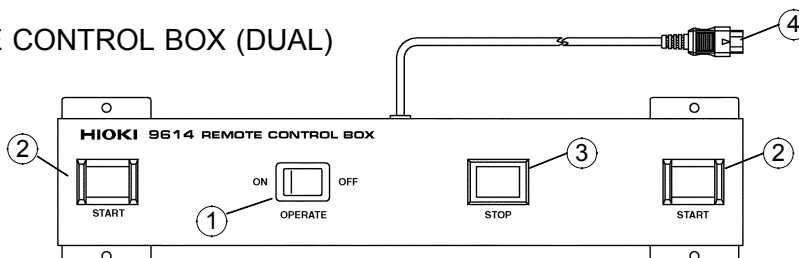

- ① OPERATE switch
Used to enable remote-control operation. When this switch is ON, the START and STOP keys for remote control are active.
- ② START key
Works in the same manner as the **START** key on the unit. With the 9614 dual remote-control box, the two START switches must be pressed.
- ③ STOP key
Works in the same manner as the **STOP** key on the unit. The STOP key is ON during a test or when a voltage is being output.
- ④ Switch signal line plug
Connect to the external switch terminal on the unit.

NOTE

Priority for control of the **START** key is in the following order: the external switch, the external I/O, and the front panel of the unit. Connecting the switch signal line plug disables the **START** key on the front panel of the unit and the start signal for the external I/O.

Chapter 2

Testing Arrangements

2.1 Power Cord Connection

WARNING

- The 3157 and the 3157-01 use different rated power voltages. Before turning the product on, make sure the source voltage matches that indicated on the product's power connector. Connection to an improper supply voltage may damage the product and present an electrical hazard.
- To avoid electric shock and ensure safe operation, connect the power cable to a grounded (3-contact) outlet.

Supply voltage indicated on the rear panel

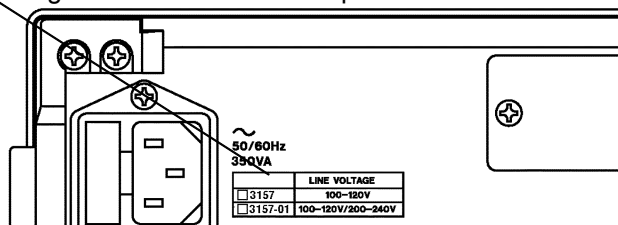

- (1) Be sure that the main power switch is turned to OFF.
- (2) Connect the grounded three-core power cord provided to the power inlet on the back of the unit.
- (3) Insert the plug into the grounded outlet.

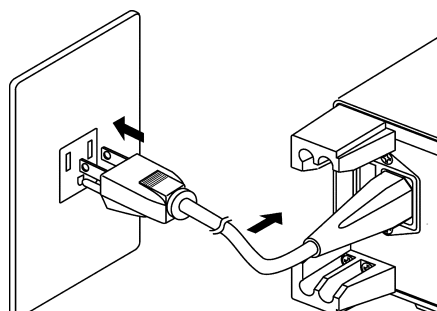

2.2 Powering on and off the Unit

WARNING

Before turning the product on, make sure the source voltage matches that indicated on the product's power connector. Connection to an improper supply voltage may damage the product and present an electrical hazard.

NOTE

- Allow 10 minutes warming up after powering on.
- To use the external controller, the external I/O terminal, and the interface, you must connect them before startup. Only devices or peripherals connected before startup are activated. Connection following startup may lead to operational or equipment failure.

For connection procedures, see Section 2.3, "Probe Connection" for the external controller, Chapter 6, "External I/O" for the external I/O terminal, and the instruction manual accompanying the interface for each interface.

Powering on the unit

- (1) Turn the main power switch to ON (I).

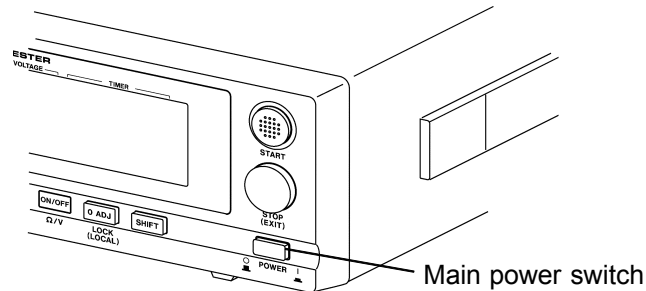

- (2) The model name and version number are displayed as below:

The model name is displayed. The version number is displayed.

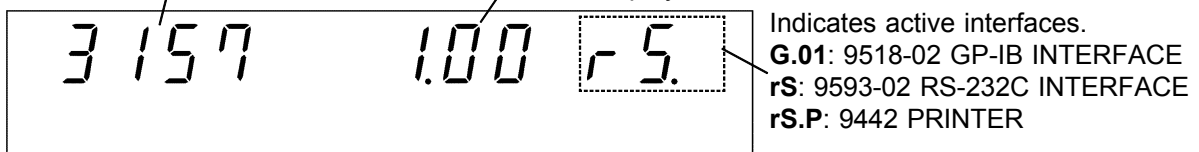

- (3) The unit enters READY state five seconds after startup.
Key operation is disabled unless the **READY** lamp is lit.

Powering off the unit

After the testing has finished, being sure that the **READY** lamp is turned on, turn the main power switch on the back of the unit to OFF.

Note that the unit may be damaged if the main power switch is turned to OFF while the unit is outputting current.

NOTE

The current settings are all preserved when the unit is next turned on. If there has been a power failure or other malfunction of the power supply, the settings in effect at the time the malfunction occurred are preserved.

2.3 Probe Connection

⚠ WARNING

- To avoid shock and short circuits, turn off all power before connecting probes.
- To avoid electrical accidents, confirm that all connections are secure. The increased resistance of loose connections can lead to overheating and fire.

The 9296 CURRENT PROBE (with alligator clip) and 9297 CURRENT APPLY PROBE are available as optional probes. Connect two sets of the 9296 or a single combined set of 9296 and 9297.

You can use a custom-built probe. If you do use a custom-built probe, make sure the wire/cable used for it has sufficient current capacity (AWG 12/cross-sectional area 3.5 mm² min.)

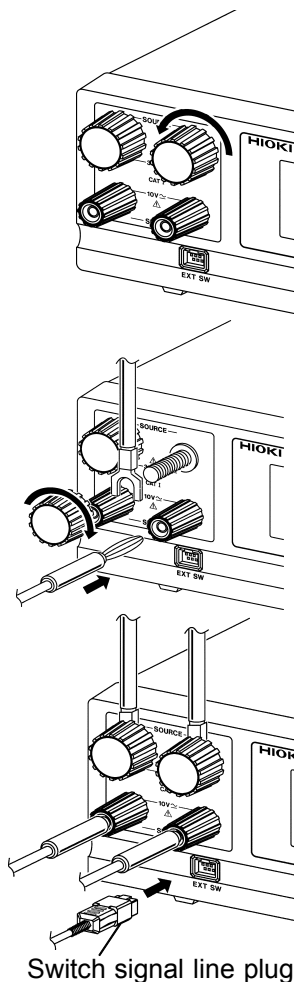

(1) Rotate the current output terminal counter-clockwise to open.

(2) Connect the current output plug as shown in the figure on the left.

(3) Rotate the current output terminal clockwise to close.

(4) Insert the banana-type voltage measurement plug into the voltage measurement terminal.

(5) With the 9296 CURRENT PROBE, be sure to connect the probe to the other terminals using the same procedure.

To use the 9297 CURRENT APPLY PROBE, insert the switch signal line plug into the external switch terminal.

- To use the push switch on the 9297 CURRENT APPLY PROBE, use the current output terminal and the voltage measurement terminal on the right, as shown in the figure.
- Make sure the switch signal line plug is correctly oriented. If the plug is dislocated during testing, the unit will enter READY state.

NOTE

- To activate the push switch, connect the switch signal line plug to the external switch terminal before startup. For more information on the push switch, see Section 4.9, "Momentary OUT."
- The 9297 CURRENT APPLY PROBE can be used unless it is connected to the external switch terminal. In this case, the push switch cannot be used.

2.4 Short Bar Connection

WARNING

- To avoid shock and short circuits, turn off all power before connecting probes.
- To avoid electrical accidents, confirm that all connections are secure. The increased resistance of loose connections can lead to overheating and fire.
- In a test using two terminals, be sure to use the current output terminal. Use of the voltage measurement terminal may lead to the terminal overheating, resulting in burns or equipment damage.

When connecting a probe incompatible with four-terminal measurement, or when measuring with two terminals, connect the short bar between the voltage measurement terminal (the SENSE terminal) and the current output terminal (the SOURCE terminal) on the right. In this case, be sure to connect the probe to the current output terminal.

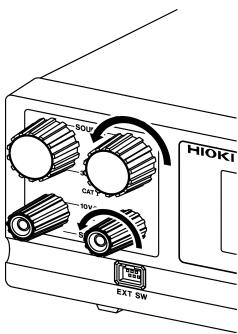

- (1) Rotate the current output terminal and the voltage measurement terminal counter-clockwise to open.

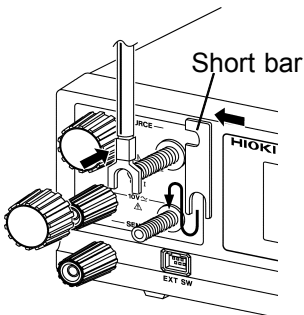

- (2) Connect the probe and short bar as shown in the figure on the left.

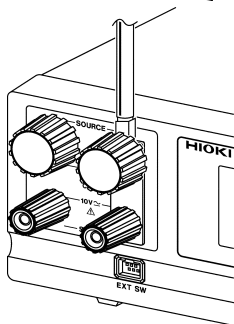

- (3) Rotate the current output terminal and the voltage measurement terminal clockwise to close. Be sure to connect the other terminals using the same procedure.

In a test using two terminals, be sure to use the current output terminal.

NOTE

Measurement with two terminals will be affected by a voltage drop in the probe, leading to inaccurate results. Before beginning a test, perform zero adjustment (see Section 3.4, Zero Adjustment Function).

2.5 Connecting the REMOTE CONTROL BOX

⚠ WARNING

To avoid shock and short circuits, turn off all power before connecting probes.

NOTE

To prevent malfunctions, do not remove the remote-control box following startup. Before removing it, be sure to turn OFF the power.

Connection of the remote-control box (9613/9614) enables start/stop operations to be performed easily.

- (1) Make sure the Main Power switch and OPERATE switch on the remote-control box are OFF.

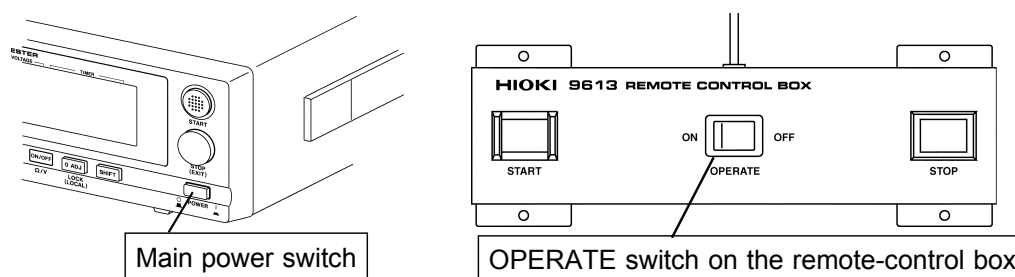

- (2) Insert the switch signal line plug into the external switch terminal.
Check the direction of the switch signal line.

- (3) Turn ON the OPERATE switch of the remote-control box. The OPERATE switch can be turned ON/OFF even following startup.

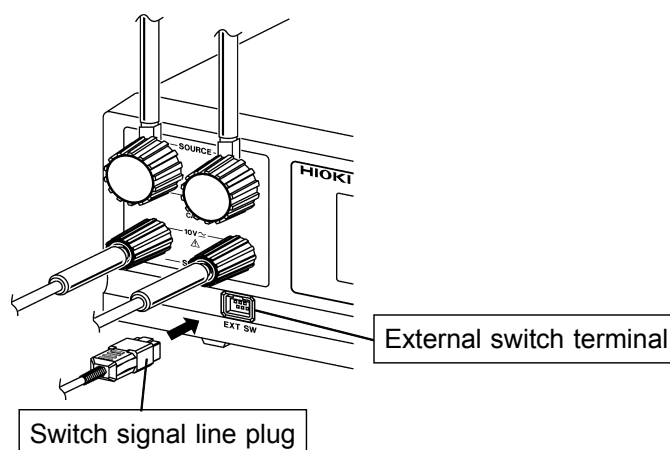

2.6 Installation Site and Position

Place on a stable, flat surface, using the four-footed stand. Orienting the unit vertically will block its air outlet, greatly increasing the risk of overheating. In positioning the unit, make sure the air inlet and outlet are kept open.

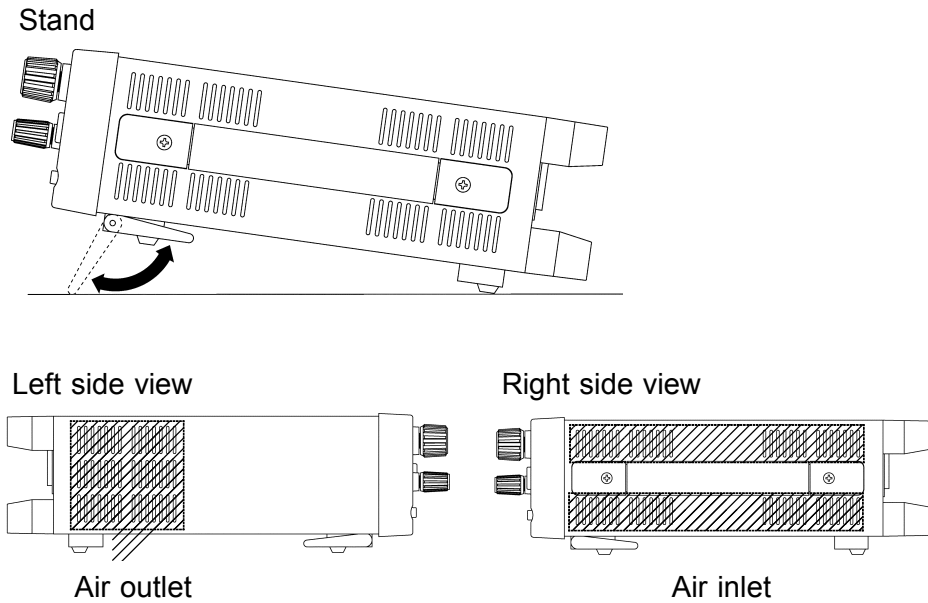
**NOTE**

- Do not insert the foreign objects into the air inlet or outlet.
- Do not apply strong downward pressure with the stand extended. Damage to the stand will result.
- Magnetic fields generated by the unit may affect CRT displays. During testing, keep the current probe away from such subjects.

2.7 Connection to the Measured Object

⚠ WARNING

- To avoid burns, never touch the output current terminal, probe tip, or contact point while testing (i.e., in TEST state).
- Take particular care to avoid touching the tip of the current application probe, which may be quite hot when operating, due to its small surface area.

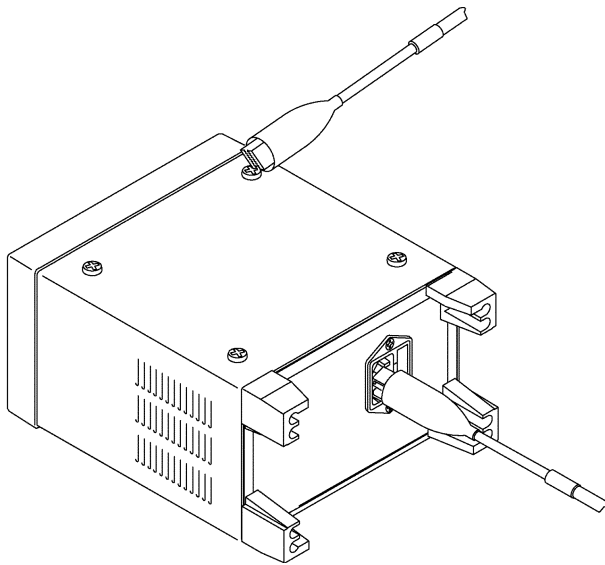

(1) Connecting using two 9296 units

Connect one 9296 to the protection ground terminal on the measured object.

Connect the other 9296 to the test point. Connect the probe firmly to prevent disconnection during testing.

During current output, take care to ensure that adjacent probes do not touch, as this may result in a short-circuit.

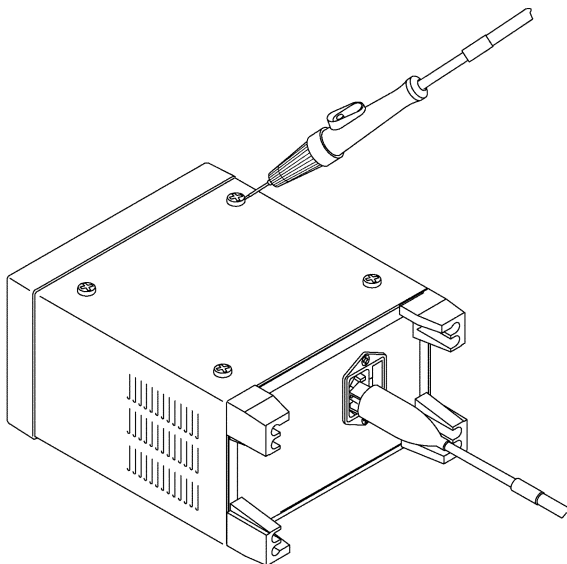

(2) Connecting using a single combined set of 9296 and 9297

Connect the 9296 to the protection ground terminal on the measured object.

Connect the 9297 to the test point. Connect the probe firmly to prevent disconnection during testing.

During current output, take care to ensure that adjacent probes do not touch, as this may result in a short-circuit.

2.8 Connection to the 3155 LEAK CURRENT HiTESTER

Attaching optional 9593-02 RS-232C INTERFACE to 3157 enables testing when connected with 3155.

3155 sends command to 3157 to start testing and receives test results when the 3157 testing is complete. The test results can be saved and printed together with the 3155 leakage current test results.

For usage for the 3155, see 3155 (-01) Instruction Manual.

When connecting 3155 with 3157 (9593-02), use connection cable as specified below.

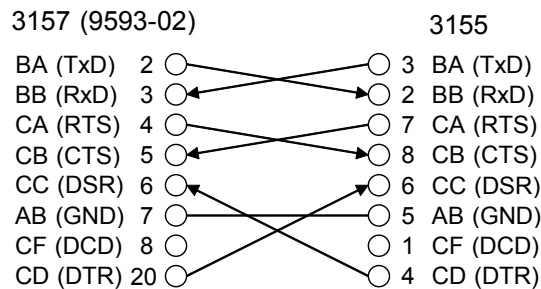

Specification: D-subminiature 25-pin male to D-subminiature 9-pin female connectors, with "crossed" data connections

Settings

- (1) Leave power OFF for both 3155 and 3157 while connecting each RS-232C connector with the RS-232C cable.
- (2) Turn the power ON for both 3155 and 3157.
- (3) Set up 3157 test settings. Measurement does not start unless the following conditions are met.
 1. Test settings
 - Unit of the maximum and minimum test values: Resistance
 - Test time: ON
 - Maximum test value: ON
 When the optional minimum test value setting function is ON.
 - Minimum test value: OFF
 2. Optional function setting
 - Endless timer function: Not set

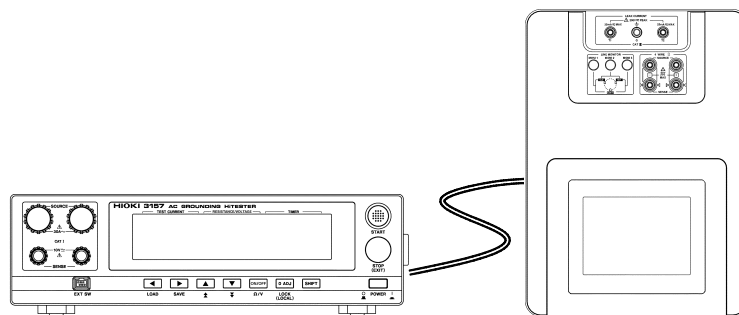



Chapter 3

Testing Method



This chapter describes the procedural flow for testing, making settings, and proper testing procedure.

Read Chapter 2, "Testing Arrangements" and make the necessary arrangements for testing.

Press + to display the Optional function setting screen.

Setting the optional functions allows testing under various conditions.

For more information, see Chapter 4, "Optional Functions."

3.1 Procedural Flow for Testing and Setting Parameters

The 3157 is in one of four states:

READY state

The unit is ready for starting a test. The **READY** lamp is turned on.

To enter TEST state, press the **START** key while in READY state.

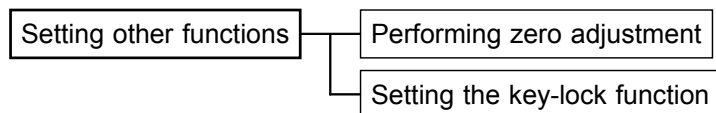
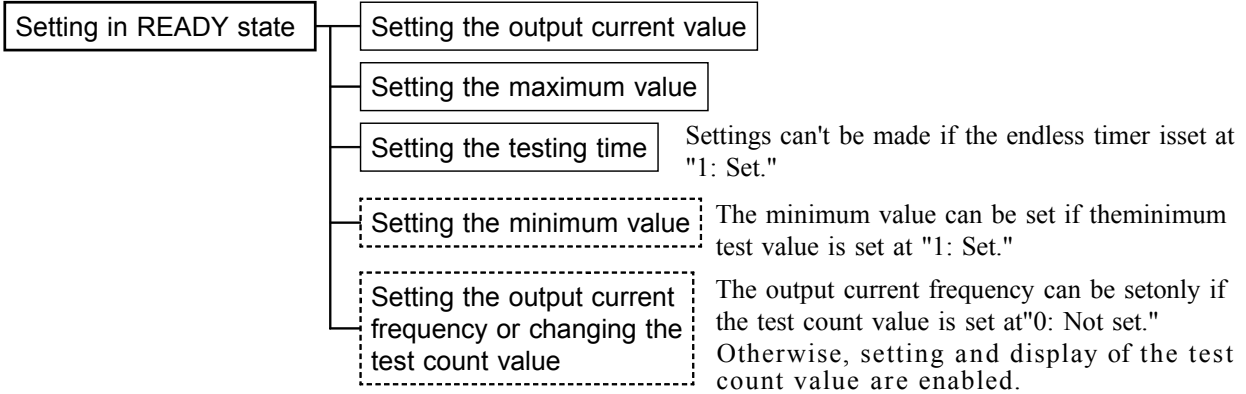
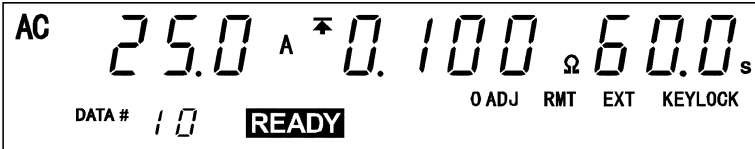

Setting the optional functions allows testing under various conditions.

Press **SHIFT** + **STOP** to display the Optional Function Setting screen.

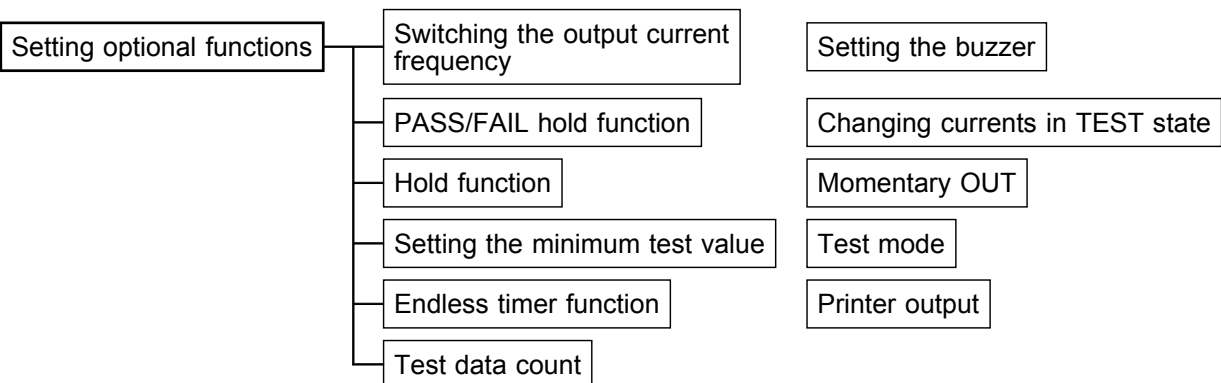
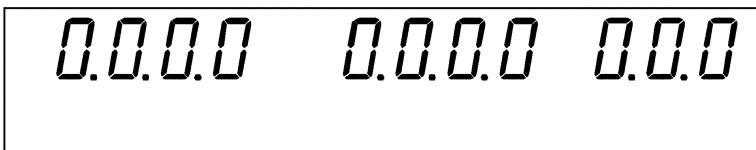

TEST state

This state indicates that a test is underway. The **TEST** lamp is turned on. The current preset in the READY state is output.

The current output value, a decrease in voltage, and resistance are measured and displayed. The measured values are compared against the comparator values preset in the READY state.

If the measured value deviate from the comparator value, the unit enters FAIL state and halts measurement.

If the preset testing time completes without the measured value deviating from the comparator value, the unit enters PASS state.



Key operation in the TEST status

Changing output current values

The output current value can be made changeable by pressing the **▲** and **▼** keys if the current is set to "1: Changeable" in TEST status.

Forced ending

Press the **STOP** key.

PASS state

PASS indicates that the measured object passed the test set in READY state. The **PASS** lamp is turned on. The PASS state screen is displayed for about 1 second before switching to READY state.

Enabling the PASS hold function in the optional settings makes it possible to retain the PASS state. To check the test results, enable the PASS/FAIL hold function.

To switch the display between resistance and voltage, press **SHIFT** + **ON/OFF** (Ω/V) while in PASS state (see Section 4.2, "PASS/FAIL Hold Function").

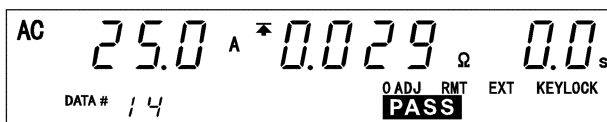

FAIL state

FAIL indicates that the measured object failed the test set in READY state. Both the **FAIL** and **UPPER** lamps light when the measured value exceeds the maximum test value. Both **FAIL** and **LOWER** lamps light when the measured value drops below the minimum test value. The FAIL state screen is displayed for about 1 second before switching to READY state.

Enabling the FAIL hold function in the optional settings makes it possible to retain the FAIL state. To check the test results, enable the PASS/FAIL hold function.

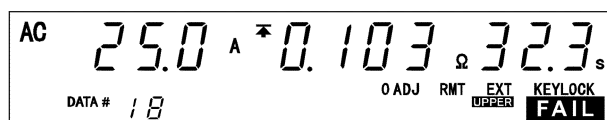

To switch the display between resistance and voltage, press **SHIFT** + **ON/OFF** (Ω/V) while in FAIL state (see Section 4.2, "PASS/FAIL Hold Function").







3.2 Making Testing Arrangements (in READY State)

Make testing arrangements in READY state, including test parameter settings, key-locking, and zero adjustment. Saving and loading for setting data and the setting of optional functions are made following the READY state. The **READY** lamp remains lit to indicate READY state.

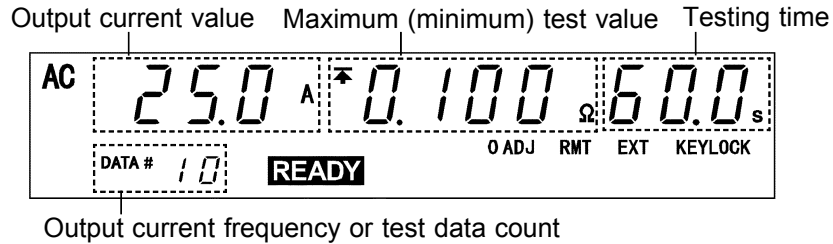
Starting and completing settings

Display the flashing cursor to change set values. Press the  or  key to display the flashing cursor with the output current value.



Press the / keys to move the flashing cursor through different settings when it is lit till the cursor reaches the value to be re-set. Then, press the / keys to change the settings.

To erase the flashing cursor, or when settings are complete, press the  key.

OPTION

The set values can be printed using the printer output function (see Section 4.11).

NOTE

The value range that can be set on the flashing cursor depends on the minimum test value, the state of the endless timer, and the test data count value on optional settings.

The range set at the factory is as follows: Output current value ↔ Maximum test value ↔ Testing time ↔ Output frequency.

3.2.1 Setting Output Current Values

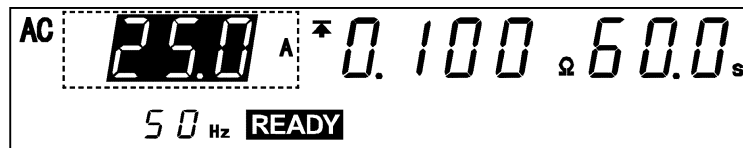

- (1) If no flashing cursor is displayed in the READY state, press either the \leftarrow key or the \rightarrow key to display the cursor while the output current value is lit.
- (2) Change output current values using the \uparrow / \downarrow keys. The value changes in 0.1 A increments.
To change the value by 1.0 A, press SHIFT + \uparrow / \downarrow keys.
The output current value can be set from 3.0 A to 31.0 A.
- (3) When settings are complete, press the STOP key.

OPTION

The output current can be changed using the current changeability in TEST State (see Section 4.8).

3.2.2 Setting the Maximum (Minimum) Test Value

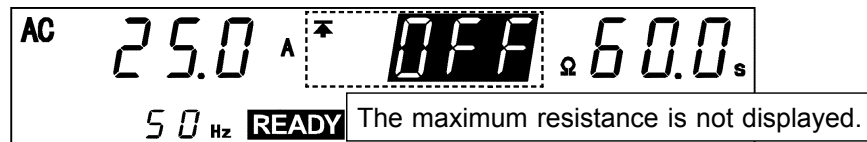
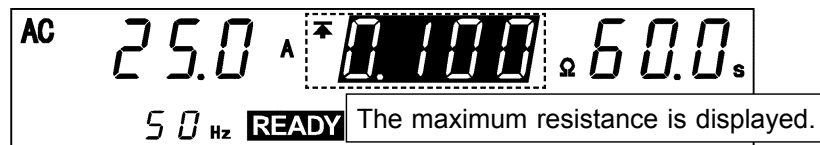

- (1) Using the \leftarrow / \rightarrow keys, move the flashing cursor to the maximum test value.
- (2) Switching between resistance and voltage indicators
The maximum test value can be set for both resistance and voltage. If both are set, only the one displayed in READY state is activated.
Press SHIFT + ON/OFF (Ω / V) to switch between resistance and voltage indicators. (This key operation is valid no matter where the flashing cursor is located.)
- (3) Setting the maximum test value
After selecting between the resistance and the voltage, set the maximum value using the \uparrow / \downarrow keys.
To change the value by 0.010 Ω , press SHIFT + \uparrow / \downarrow keys (0.10 V when the voltage is displayed).
Resistance may be set from 0.000 Ω to 2.000 Ω , while voltage may be set from 0.00 V to 6.00 V.
If no maximum test value is required, turn off the ON/OFF key.
- (4) When settings are complete, press the STOP key.

OPTION

The minimum test value can be set using the minimum test value setting function (see Section 4.4).

Once a minimum test value is set, both minimum and maximum values are provided for resistance or voltage.

To set a minimum test value, activate the optional minimum test value setting function.

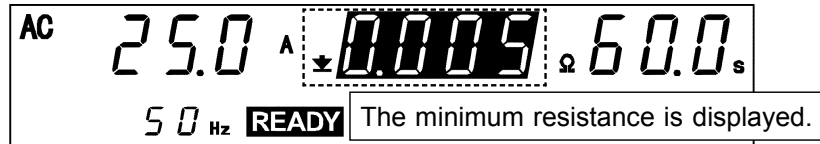

To set a minimum test value, do the same as when setting a maximum test value. The minimum test value must be smaller than the maximum test value. Otherwise, a test will not start when the **START** key is pressed.

NOTE

- Four values may be set - the maximum and minimum test values for resistance and maximum and minimum test values for voltage. However, the reference value for testing is expressed in the unit displayed in TEST state. That is, screening is conducted using the reference resistance when resistance is displayed, and reference voltage when voltage is displayed.
- A combination of resistance and voltage values (such as a maximum resistance value and a minimum voltage value) can't be tested.

3.2.3 Setting the Testing Time

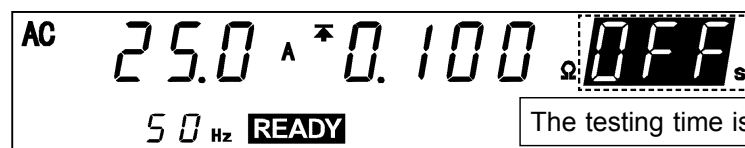
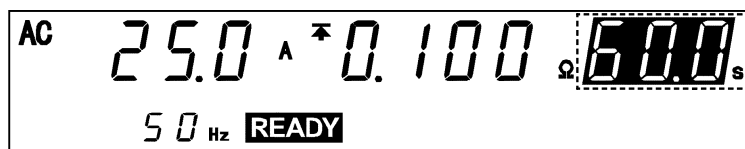

- (1) Using the **◀**/**▶** keys, move the flashing cursor to the testing time.
- (2) Set the testing time using the **▲**/**▼** keys.
 - With time set at 0.5 s to 99.9 s, the time changes in 0.1 s increments (1 s increments when the set time scale is 100 s to 999 s).
 - With time set at 0.5 s to 99.9 s, press **SHIFT** + **▲**/**▼**. The time changes in 1.0 s increments (10 s increments when the set time scale is 100 s to 999 s).
 - Settings may be made along a scale ranging from 0.5 s to 999 s (in gradations of 0.1 s for the range 0.5 s to 99.9 s and 1 s for the range 100 s to 999 s).
 - If no testing time is required, turn off the **ON/OFF** key.
- (3) When settings are complete, press the **STOP** key.

OPTION

The endless timer function allows continuous testing regardless of the testing time set (see Section 4.5).

NOTE

The test automatically stops after the lapse of 999 s while the testing time setting can be disabled by using the **ON/OFF** key.

3.2.4 Setting the Output Current Frequency (in READY State)

If the optional test data count function is activated, the output current frequency is not displayed in READY state. To display or modify the output current frequency in READY state, change the setting for the test data count to "0: Not set."

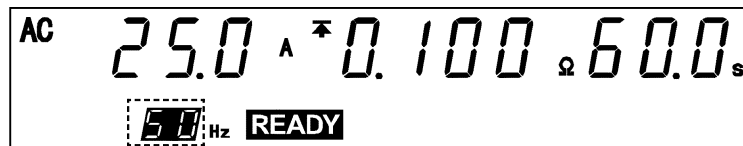

- (1) Using the **◀/▶** keys, move the flashing cursor to the testing time.
- (2) Change the output current frequency (50/60 Hz) using the **▲/▼** keys.
- (3) When settings are complete, press the **STOP** key.

OPTION

The frequency can also be changed using the output current frequency switching function (see Section 4.1).

NOTE

Changing the frequency in READY state automatically changes the contents of the optional output current frequency switching function.

3.2.5 Setting the Test Data Count (in READY State)

The number of test data may be changed in the READY state. For the test data count setting, see Section 4.6, "Test Data Count Function."

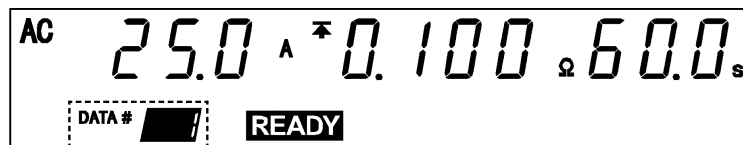

- (1) Using the **◀/▶** keys, move the flashing cursor to the test data count.
- (2) Change the test data count using the **▲/▼** keys.
- (3) When settings are complete, press the **STOP** key.

NOTE

If you make settings for the test data count, output frequency cannot be changed in the READY state. To change output frequency, use the optional function setting screen.

3.3 Initial Settings for Optional Functions

Press **SHIFT** + **STOP** while in READY state to display the Optional function setting screen.

Setting the optional functions allows testing under various conditions.

Settings can be made for the following eleven optional functions. One number is assigned to each function. Settings are made by changing the number by using the **▲**/**▼** keys.

For more information on the settings, see Chapter 4, "Optional Functions."

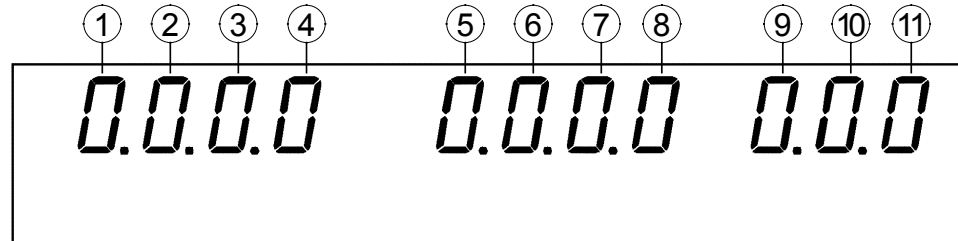

The optional functions of the 3157 are factory-preset to the following settings:

Setting item	Initial setting
① Switching the output current frequency	0: 50 Hz
② PASS/FAIL HOLD function	0: PASS not held, FAIL held
③ HOLD function	0: Not held
④ Setting the minimum test value	0: Not set
⑤ Endless timer function	0: Not set
⑥ Test data count	0: Not set
⑦ Setting the buzzer	0: ON at screening, ON at error
⑧ Changing currents in TEST state	0: Not changeable
⑨ Momentary OUT	0: Not set
⑩ Test mode	0: Soft start mode
⑪ Setting the printer output	0: Not used

NOTE

To reset the system, turn on power while pressing the **SHIFT** key. Once the system is reset, settings for the optional functions and the recorded parameters will return to their default values (factory-preset values). For more information, see Section 7.5, "Resetting the System."

3.4 Zero Adjustment Function

Measurements may be affected by a voltage drop in the probe. Zero adjustment is necessary for accurate measurement, especially when measuring with two terminals using the short bar. The **0ADJ** lamp is lit while the zero adjustment function is active. Following zero adjustment, the probe's voltage drop is accounted for in returning measurement data. Note that the zero adjustment function is automatically disabled if the output current value is changed or when setting data is loaded.

Zero adjustment procedure

- (1) Confirm that the unit is in READY state, then short-circuit the probe.
- (2) Set an output current value. The value set must be the same as the one used in the test.
- (3) Press the **0ADJ** key; **0ADJ** lamp starts flashing and then zero adjustment is executed.

Note that a preset current is output during zero adjustment.

Zero adjustment is completed in about 3 seconds. On completion, the unit enters READY state, and the **0ADJ** lamp lights.

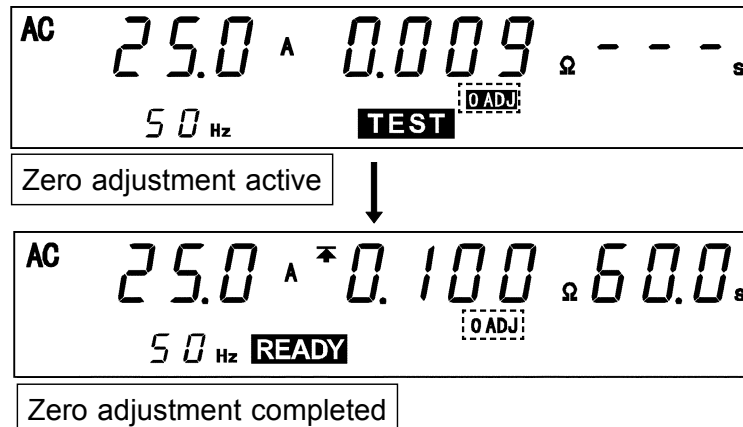

Zero adjustment is possible within a range equivalent to a resistance between 0.000 Ω and 0.100 Ω , on either the voltage or resistance indicator. If the measured value falls outside this range, either the resistance value or the voltage value will blink, and the unit will enter READY state.

Canceling zero adjustments

To disable zero adjustment function, press the **0ADJ** key while it is active. When the zero adjustment function is inactivated, the **0ADJ** lamp goes out, indicating that the function is inactive. This function is automatically inactivated when the output current value is changed or when setting data is loaded.

NOTE

- The zero adjustment function will not be inactivated, even if you change the output current by selecting "1: Changeable" on the optional "Current Changeability in TEST State." Note that if the zero adjustment function is active, changing the output current value may produce inaccurate results.
- Current outputs will soft-start during zero adjustment, regardless of the setting for "Test mode" on the optional function (see Section 4.10.1, "Soft Start Mode").

3.5 Key-lock Function

This function is used to keep lock the current set values. It inactivates all keys except the **START** key, **STOP** key, and the resistance/voltage switch. The **KEYLOCK** lamp is lit while the key-lock function is active.

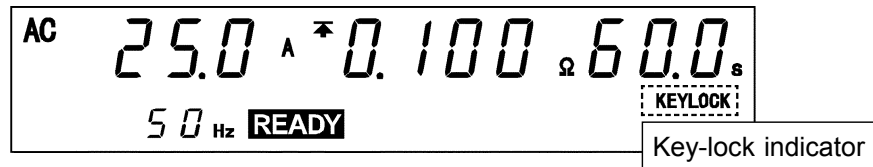

Setting and inactivating the key-lock function

To activate the key-lock function, press **SHIFT** + **0ADJ**.

To inactivate the key-lock function, press **SHIFT** + **0ADJ** while the function is active.

NOTE

Even when the key-lock function is activated, the external switch and the start and stop signals on the external I/O terminal remain active.

How to inactivate key-lock function in REMOTE state

Once interface communication starts in REMOTE state (the **RMT** lamp lights), all keys except the **STOP** key are inactivated.

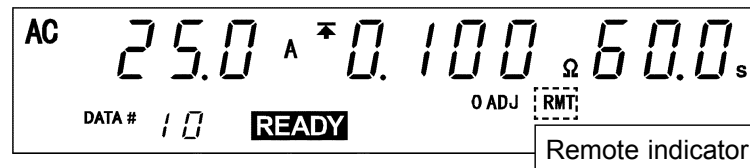

To inactivate the REMOTE state, press **SHIFT** + **0ADJ** (LOCK).

NOTE

Even in REMOTE state, the external switch and the start and stop signals on the external I/O terminal remain active.

3.6 Examples of Settings

Output current value set: 25.0 A, Maximum test value: 0.100 Ω , Testing time: 1 minute.

Assume that "0: not set" is selected for "Minimum test value setting," "Timer setting," and "Test data count" on the optional functions.

The following provides an example of changing set values.

Values currently set		➔	Values to be set	
Output current value	30.0 A		Output current value	25.0 A
Maximum test value	0.050 Ω		Maximum test value	0.100 Ω
Testing time	10.0 s		Testing time	60.0 s

AC 30.0 A 0.050 Ω 10.0 s
50 Hz READY

(1) Setting output current values

Using the \leftarrow / \rightarrow keys, move the flashing cursor to the output current value.

AC 30.0 A 0.050 Ω 10.0 s
50 Hz READY

Using the \uparrow / \downarrow keys, set "Output current value" to 25.0 A.

To change the value by 1.0 A, press SHIFT + \uparrow / \downarrow keys.

In this example, press the \downarrow key five times while holding down the SHIFT key to set the output current value to 25.0 A.

AC 25.0 A 0.050 Ω 10.0 s
50 Hz READY

(2) Setting the maximum test value

Using the \rightarrow key, move the flashing cursor to the maximum test value.

AC 25.0 A 0.050 Ω 10.0 s
50 Hz READY

In this example, "Maximum test value" is preset to the resistance value.

Using the \uparrow / \downarrow keys, set "Maximum test value" to 0.100 Ω .

To change the value by 0.010 Ω , press SHIFT + \uparrow / \downarrow keys (0.10 V when the voltage is displayed).

In this example, press the \uparrow key five times while holding down the SHIFT key to set the maximum test value to 0.100 Ω .

When the voltage indicator is displayed, or to set in a voltage value, first switch to the resistance indicator, then set the maximum and minimum test values.

Press **SHIFT** + **ON/OFF** (Ω/V) to switch between resistance and voltage indicators.



(3) Setting the testing time

Using the **▶** key, move the flashing cursor to the testing time.

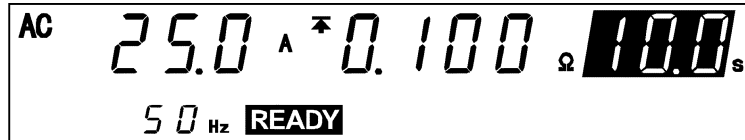

Using the **▲**/**▼** keys, set "Testing time" to 60.0 s.

To change the time by 1.0 s, press **SHIFT** + **▲**/**▼** keys.

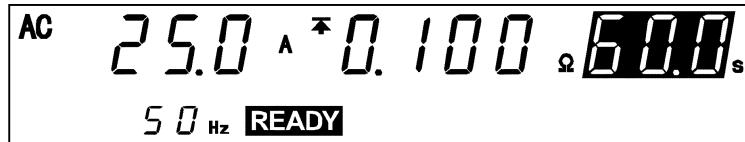

The new parameters following setting are shown below:

Output current value	25.0 A
Maximum test value	0.100 Ω
Testing time	60.0 s

Press the **START** key while in this state. The unit enters TEST state to begin testing.

Press the **STOP** key to finalize the test parameters. The flashing cursor disappears.

Press the **◀** or **▶** key to restore the flashing cursor and allow the test parameters to be changed.

NOTE

Even if "Minimum test value setting" on the optional function is active, you can get the same results obtained in the example above by moving the flashing cursor to the minimum test value and turning it off with the **ON/OFF** key.

Output current value: 25.0 A, Maximum test value: 0.100 Ω , Minimum test value: OFF, Testing time: 60.0 s.

3.7 Starting a Test

⚠ WARNING

- To avoid electrical accidents, confirm that all connections are secure. The increased resistance of loose connections can lead to overheating and fire.
- To avoid burns, never touch the output current terminal, probe tip, or contact point while testing (i.e., in TEST state).
- Take particular care to avoid touching the tip of the current application probe, which may be quite hot when operating, due to its small surface area.

NOTE

- The soft start mode is active only with a load $0.200\ \Omega$ or less. If the load exceeds this value, the state of connection of the probe is not known, and a test cannot be started. In this case, set the test mode to normal mode.
- Priority for control of the **START** key is in the following order: the external switch, the external I/O, and the front panel of the unit. Connecting the switch signal line plug disables the **START** key on the front panel of the unit and the start signal for the external I/O.

Normally, the 9296 CURRENT PROBE should be connected to the protection ground terminal on the equipment being tested. Connect the probe securely, so that it's not easily dislodged. During current output, take care to ensure that adjacent probes do not touch, as this may result in a short-circuit. In most cases, the 9297 CURRENT APPLY PROBE is connected to a test point on the equipment being tested.

Starting a test

The test start procedure varies according to the test mode setting. The unit is initially set to Soft start mode. For more information, see Section 4.10, "Setting the Test Mode."

Depending on the output current value and the state of the test object, it will generally take about 2 seconds to output the set current. After a while, the output current value equals the set current value $\pm 1\ \text{A}$, and the test screening function activates.

- (1) Set the appropriate parameters in the READY state.
- (2) Press the **START** key to start the test. If the probe is detached from the measured object, the test will not start, and the unit will enter the stand-by state (as indicated by a blinking **TEST** lamp). If this state continues for more than 30 seconds, the unit returns to the READY state. The test begins when the probe is connected to the measured object.
- (3) The **TEST** lamp lights when the unit enters TEST state. While the **TEST** lamp is lit, be careful not to cause electrical shock by touching the terminal or other parts through which the current is passing.
- (4) If the probe is detached from the measured object during testing, the **FAIL** lamp lights together with the **UPPER** and the **LOWER** lamps, and the unit enters FAIL state.
- (5) To end the test normally, the probe must contact the measured object throughout the test.

Forcible ending of a test

To perform forcible ending of a test, press the **STOP** key. This stops current output, and the unit enters READY state. No screening operation is performed.

OPTION

The value at which to forcibly end the test can be held using the hold function (see Section 4.3).

Failure to start a test

The following cases may make prevent starting a test. In case of failure, check the settings and reset parameters, if necessary.

- (1) The maximum test value is lower than the minimum test value:
After the minimum test value flickers, the unit returns to the READY state. Reset the maximum or minimum test values.
- (2) The output current value is lower than the output current set value:
 - The probe can be disconnected from the tested equipment.
Never attempt to reconnect the probe before the unit returns to READY state. Sparks may be given off. Before reconnecting, make sure the unit has returned to READY state.
 - The load resistance may exceed the output capacity of this unit.
In this case, the **FAIL** lamp lights together with the **UPPER** and the **LOWER** lamps, and the unit enters FAIL state.

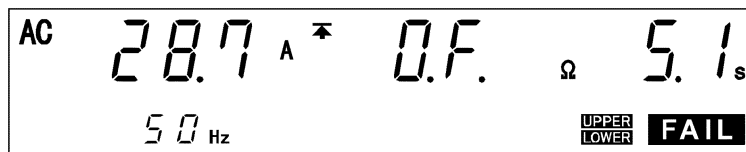

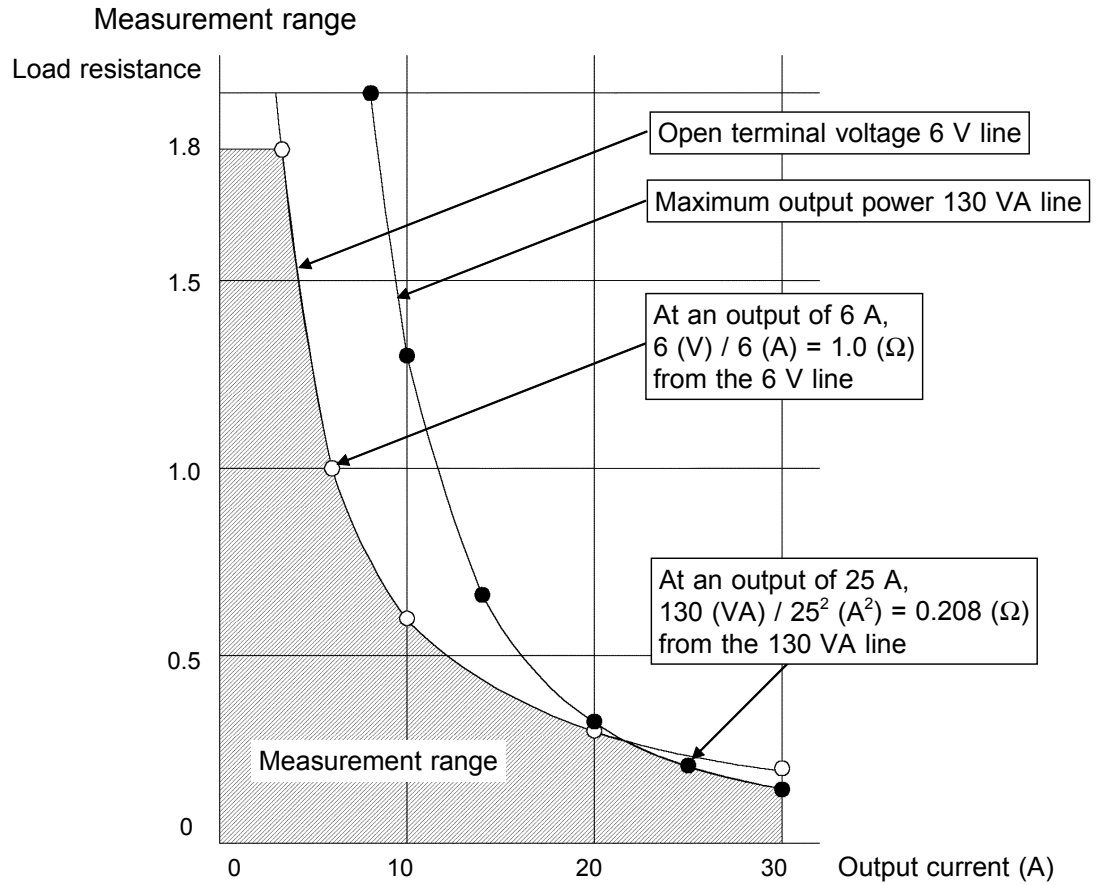

3.8 Testing (in TEST State)

TEST state indicates that the unit is performing a test. Be careful not to cause electrical shock by touching the terminal or other parts through which the current (the value of which has been set in READY state) is passing.

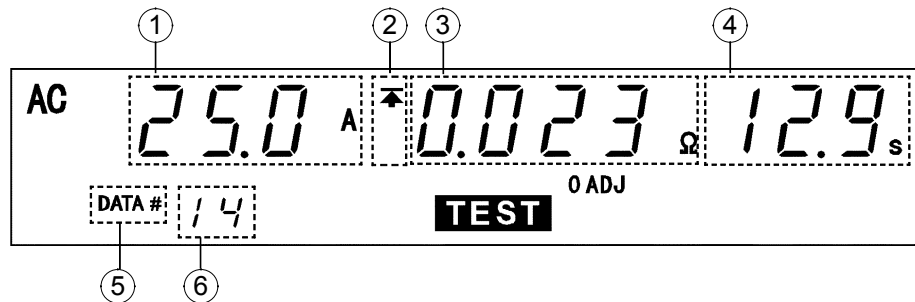

① Measured current value

Indicates the current value being output.

OPTION

The output current can be changed using the current changeability in TEST State (see Section 4.8).

② Maximum value icon and minimum value icon

The symbol ▲ appears when the maximum test value is set, and the symbol ▼ appears when the minimum value is set.

③ Measured voltage value and measured resistance value

The measured voltage value is displayed if the voltage indicator is selected and the measured resistance value is displayed if the resistance indicator is selected. Press **SHIFT** + **ON/OFF** (Ω/V) to switch between resistance and voltage indicators. Only the indicators are switched. The maximum and minimum test values are not changed.

④ Testing time elapsed

When the testing time is set, countdown starts from the time set, and is displayed. When the testing time is set to OFF, the time elapsed after the start of the test is displayed. Once elapsed testing time reaches 999 s, the unit completes the test and returns to READY state. If either the maximum or minimum test value has been set, the unit enters PASS state.

OPTION

The endless timer function allows continuous testing regardless of the testing time set (see Section 4.5).

⑤ Data count indicator

Lights when the optional test data count function is set to "1: Set."

⑥ Test data count (output current frequency)

Displays test data when the data count indicator described in ⑤ above is lit or the output frequency.

3.9 Screening (in PASS State)

The unit enters PASS state when either the maximum or minimum test value is set, and when the test is completed. The **PASS** lamp lights while in PASS state, displaying the value established at the end of the testing period. The PASS state screen is displayed for about 0.5 second before the unit resumes READY state.

OPTION

The PASS state is held using the PASS/FAIL HOLD function (see Section 4.2). The test data count can be displayed using the test data count function (see Section 4.6).

The test result can be printed using the printer output function (see Section 4.11).

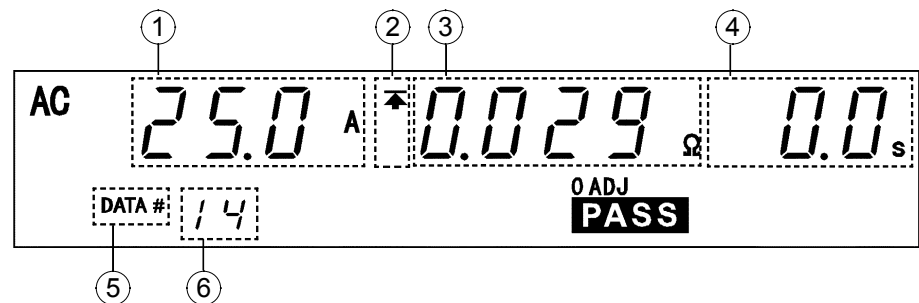

- ① Measured current value at the end of a test
Displays the current value being output at the end of the test.
- ② Maximum value icon and minimum value icon
The symbol \blacktriangle appears when the maximum test value is set, and the symbol \blacktriangledown appears when the minimum value is set.
- ③ Measured voltage value and measured resistance value at the end of a test
The measured voltage value is displayed if the voltage indicator is selected and the measured resistance value is displayed if the resistance indicator is selected. Press **SHIFT** + **ON/OFF** (Ω/V) to switch between resistance and voltage indicators.
- ④ Test completion time
Displays the time in which the test has been completed. In PASS state, "0.0s" is displayed.
- ⑤ Test data count indicator
Lights when the optional test data count function is set to "1: Set."
- ⑥ Test data count (output current frequency)
Displays test data when the data count indicator described in ⑤ above is lit or the output frequency.

3.10 Screening (in FAIL State)

The unit enters FAIL state if the measured value deviates from the maximum (or minimum) test value set.

The FAIL state indicates the time at which the measured value deviated from the maximum (or minimum) value. The **FAIL** lamp lights together with the **UPPER** or the **LOWER** lamp while in FAIL state (together with the **UPPER** and the **LOWER** lamps if the set current cannot be output).

The FAIL state screen is displayed for about 1 second before the unit resumes READY state.

OPTION

The FAIL state is held using the PASS/FAIL HOLD function (see Section 4.2).

The test data count can be displayed using the test data count function (see Section 4.6).

The test result can be printed using the printer output function (see Section 4.11).

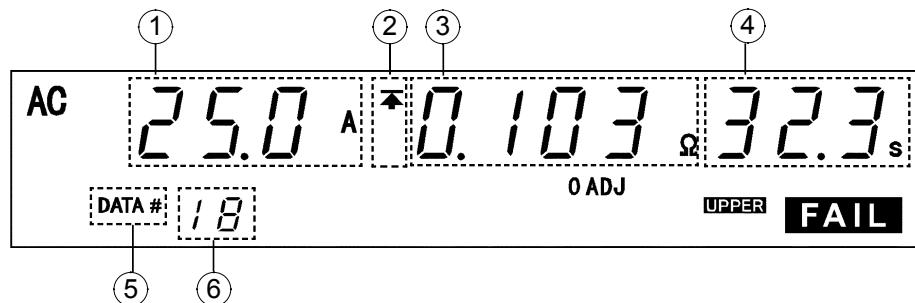

- ① Measured current value at the end of a test
Displays the current value being output at the end of the test.
- ② Maximum value icon and minimum value icon
The symbol \uparrow appears when the maximum test value is set, and the symbol \downarrow appears when the minimum value is set.
- ③ Measured voltage value and measured resistance value at the end of a test
The measured voltage value is displayed if the voltage indicator is selected and the measured resistance value is displayed if the resistance indicator is selected. Press **SHIFT** + **ON/OFF** (Ω/V) to switch between resistance and voltage indicators.
- ④ Test completion time
If the testing time is set in FAIL state, the testing time elapsed displays the set testing time remaining.
When the testing time is set to OFF, the elapsed time is displayed.
- ⑤ Test data count indicator
Lights when the optional test data count function is set to "1: Set."
- ⑥ Test data count (output current frequency)
Displays test data when the data count indicator described in ⑤ above is lit or the output frequency.

Chapter 4

Optional Functions

Setting the optional functions allows testing under various conditions.

Settings can be made for the following eleven optional functions. One number is assigned to each function. Settings are made by changing the number by moving the cursor key.

Since improper settings can produce inaccurate results, this chapter explains the correct way to make settings. Please read it carefully.

Entering the Optional function setting screen

Press **SHIFT** + **STOP** while in READY state to display the Optional function setting screen.

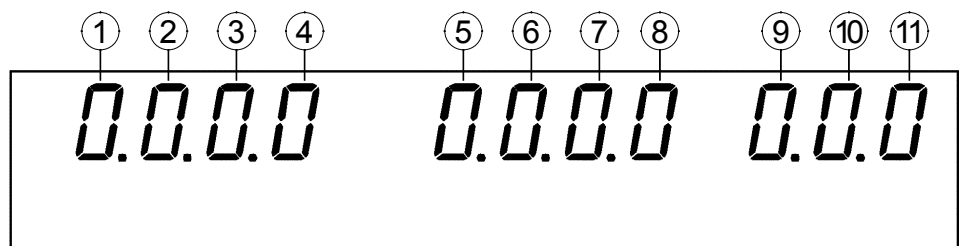

Setting optional functions

Use the **◀/▶** keys to move the flashing cursor to the target function.

Use the **▲/▼** keys to set a value at the flashing cursor location.

To complete the optional settings, press **SHIFT** + **STOP**. The unit reverts to the READY state.

Press the **STOP** key to abort the setting process. The unit reverts to the READY state without finalizing settings.

The following describes the numbers corresponding to the functions. For additional information, see Section APPINDIX 2, "Table of Optional Functions."

①	<p>Switching the output current frequency</p> <p>Switches output current frequencies (50 Hz or 60 Hz). When the test data count is at "0: Not set," the frequency is displayed in the READY state.</p>
Selection	0: 50 Hz, 1: 60 Hz
②	<p>PASS/FAIL hold function</p> <p>This function retains PASS and FAIL states to help verify the value screened in the test.</p>
Selection	<p>0: PASS not held, FAIL held 1: PASS held, FAIL held 2: PASS not held, FAIL not held 3: PASS held, FAIL not held</p>
③	<p>Hold function</p> <p>When the hold function is set in the following cases, the current state is retained:</p> <ul style="list-style-type: none"> • Following selection of only the test time, some time has elapsed without setting the maximum or minimum test value. • Press the STOP key to cancel the test in progress.
Selection	0: Not held, 1: Held
④	<p>Setting minimum test value</p> <p>The minimum test value can be set as a test parameter.</p>
Selection	0: Not set, 1: Set
⑤	<p>Endless timer function</p> <p>If this function is not selected, the test ends after 999 s, after which the test time is set to OFF in the READY state. Select this function to continue until it returns a FAIL state, or until you press the STOP key.</p>
Selection	0: Not set, 1: Set
⑥	<p>Test data count function</p> <p>The test data count function can be preset. This function counts the number of tests, and is used when testing a large number of points for a single measured object.</p>
Selection	0: Not set, 1: Set

⑦ Buzzer setting	
The buzzer ON/OFF may be set in the PASS, FAIL, error state, and other states.	
Selection	0: ON at screening, ON at error 1: OFF at screening, OFF at error 2: OFF at screening, ON at error 3: ON at screening, OFF at error
⑧ Changing the current value in TEST state	
In TEST state, the current value can be changed during output by pressing the <input type="button" value="▲"/> / <input type="button" value="▼"/> keys.	
Selection	0: Not changeable, 1: Changeable
⑨ Momentary OUT	
The momentary OUT function allows current output only while the <input type="button" value="START"/> key is held down. Once this function is set, working with the 9297 CURRENT APPLY PROBE requires different procedures.	
Selection	0: Not set (Trigger operation), 1: Set (Momentary OUT operation)
⑩ Test mode	
Soft start mode, normal mode and continuous test mode can be set. For more information, see Section 4.10, "Test mode."	
Selection	0: Soft start mode, 1: Normal mode, 2: Continuous test mode
⑪ Printer output	
You can print test parameters and results with the optional 9442 PRINTER. This printer offers the following two print modes.	
Selection	0: Not used (Initial setting) 1: Automatically print for PASS/FAIL screening. 2: Print selectively when the PASS/FAIL state is held.

4.1 Switching the Output Current Frequency

Changes the output current frequency. When the optional test data count function is set to "1: Not set," the output current frequency set in the READY state is displayed and can be changed. If you change the frequency in the READY state, the output current frequency can be changed automatically in the optional function setting screen.

Setting procedure

- (1) Press **SHIFT** + **STOP** while in READY state to display the Optional function setting screen.

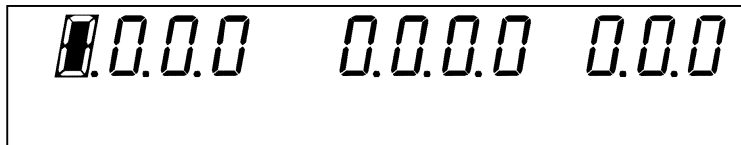

- (2) Use the **◀**/**▶** keys to move the flashing cursor to the position shown in the figure.
- (3) Use the **▲**/**▼** keys to set a value at the flashing cursor location.

0: 50 Hz (Initial setting)

1: 60 Hz

- (4) To complete the optional settings, press **SHIFT** + **STOP**. The unit reverts to the READY state.

NOTE

Setting the optional test data count function prevents display of the output current frequency in the READY state. To display and change the frequency in the READY state, set the test data count function to "1: Not set."

4.2 PASS/FAIL Hold Function

If the maximum or minimum value has been set, this function retains the value for the PASS or FAIL state on test completion. If the PASS or FAIL hold function is not selected, the test result is displayed for approximately 0.5 seconds for PASS and approximately 1 second for FAIL before the unit reverts to the READY state.

To check test results, press the **SHIFT** + **ON/OFF** (Ω/V). This allows you to switch the display between resistance and voltage. The conditions at which the settings are made do not change, even after switching.

To inactivate the hold function, press the **STOP** key. The unit reverts to the READY state.

Setting procedure

- (1) Press **SHIFT** + **STOP** while in READY state to display the Optional function setting screen.

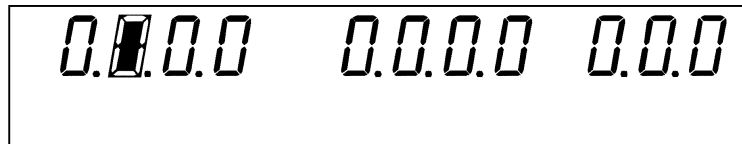

- (2) Use the **◀/▶** keys to move the flashing cursor to the position shown in the figure.
- (3) Use the **▲/▼** keys to set a value at the flashing cursor location.

0: PASS not held, FAIL held (Initial setting)

1: PASS held, FAIL held

2: PASS not held, FAIL not held

3: PASS held, FAIL not held

- (4) To complete the optional settings, press **SHIFT** + **STOP**. The unit reverts to the READY state.

NOTE

- Even when the key-lock function is activated, to switch the display between resistance and voltage, press **SHIFT** + **ON/OFF** (Ω/V).
- When continuous test mode is selected on the optional function, the PASS/FAIL hold function works somewhat differently. For more information, see Section 4.10.3, "Continuous Test Mode."

4.3 HOLD Function

If a test is conducted with both the maximum test value and the minimum test value turned off, the unit enters the READY state as soon as test time elapses (after the lapse of 999 s if the testing time is set to OFF), or if the test is aborted with the **STOP** key. Select "1: Held" to retain the last value and to check test results. To check test results, press the **SHIFT** + **ON/OFF** (Ω/V). This allows you to switch the display between resistance and voltage. The conditions at which the settings are made do not change, even after switching. To inactivate the hold function, press the **STOP** key. The unit reverts to the READY state.

Setting procedure

- Press **SHIFT** + **STOP** while in READY state to display the Optional function setting screen.

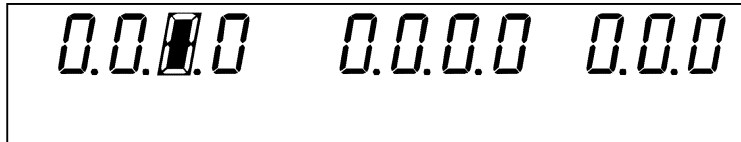

- Use the **◀**/**▶** keys to move the flashing cursor to the position shown in the figure.
- Use the **▲**/**▼** keys to set a value at the flashing cursor location.

0: Not held (Initial setting)

1: Held

- To complete the optional settings, press **SHIFT** + **STOP**. The unit reverts to the READY state.

NOTE

- Even when the key-lock function is activated, to switch the display between resistance and voltage, press **SHIFT** + **ON/OFF** (Ω/V).
- When continuous test mode is selected on the optional function, the hold function works somewhat differently. For more information, see Section 4.10.3, "Continuous Test Mode."

Differences between PASS/FAIL hold and hold functions

- Unless the test reference value is set, PASS/FAIL screening is not performed.
- If a test is conducted with both the maximum test value and the minimum test value turned off, the unit enters the READY state as soon as test time elapses (after the lapse of 999 s if the testing time is set to OFF). If the hold function is set to "ON," the last value is retained. This function is disabled if you use the endless timer.

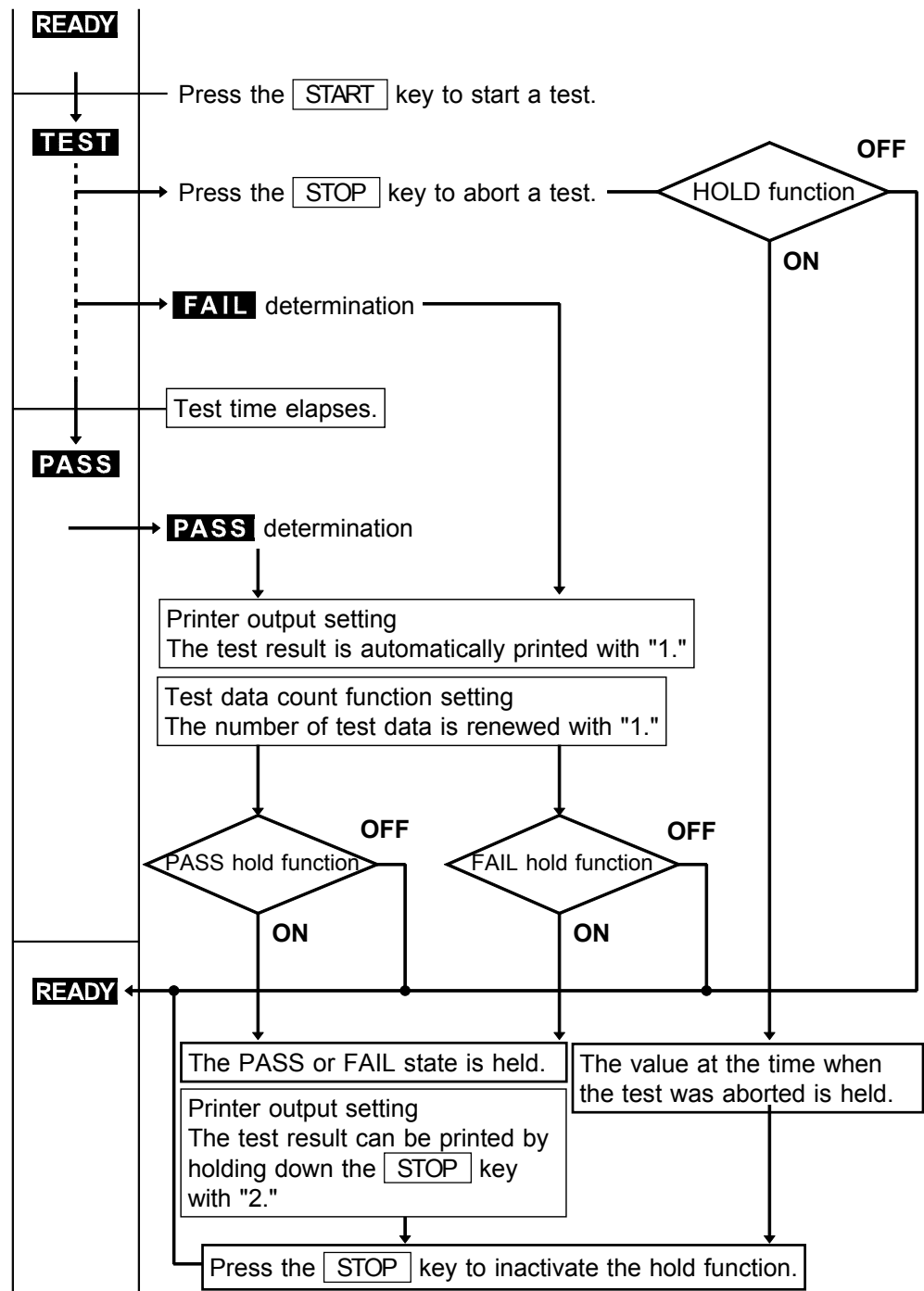

NOTE

- To print test results with an optional 9442 PRINTER with the printer output function set to "2," the unit must be in a PASS/FAIL hold state.

4.4 Setting the Minimum Test Value

If the minimum test value is set to "0: Not set," the flashing cursor does not move to the minimum test value, thus disabling test settings.

If the minimum test value is set to "1: Set," both maximum and minimum test values may be set.

Even selecting OFF with the **ON/OFF** key will not reflect the minimum test value in the test, but the flashing cursor will move to the minimum test value. Select "0: Not set," unless the minimum test value is required.

These settings are saved or loaded along with the test data.

Setting procedure

- Press **SHIFT** + **STOP** while in READY state to display the Optional function setting screen.

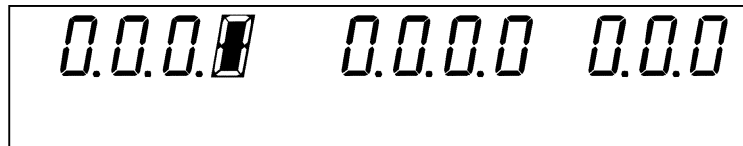

- Use the **◀**/**▶** keys to move the flashing cursor to the position shown in the figure.
- Use the **▲**/**▼** keys to set a value at the flashing cursor location.

0: Not set (Initial setting)

1: Set

- To complete the optional settings, press **SHIFT** + **STOP**. The unit reverts to the READY state.

NOTE

- The maximum and minimum resistance values and maximum and minimum voltage values can be set independently. The value displayed just before you enter the TEST state serves as the reference test value; if a resistance value is displayed, the reference resistance value is used for screening. Similarly, the voltage resistance value is used if a voltage value is displayed.
- A combination of resistance and voltage values (e.g. the maximum resistance value and the minimum voltage) is not possible.

4.5 Endless Timer Function

In setting the endless timer, if "1: Set" is selected, currents are continually output in the TEST status regardless of the test time elapsed. In the READY state "-" is displayed for the test time, and the cursor stops moving to "Test Time."

To end the test, the unit must enter the FAIL state or the **STOP** key must be pressed.

These settings are saved or loaded along with the test data.

Setting procedure

- (1) Press **SHIFT** + **STOP** while in READY state to display the Optional function setting screen.

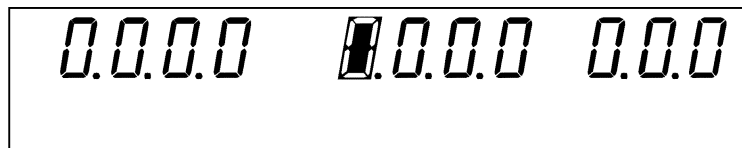

- (2) Use the **◀**/**▶** keys to move the flashing cursor to the position shown in the figure.
- (3) Use the **▲**/**▼** keys to set a value at the flashing cursor location.

0: Not set (Initial setting)

1: Set

- (4) To complete the optional settings, press **SHIFT** + **STOP**. The unit reverts to the READY state.

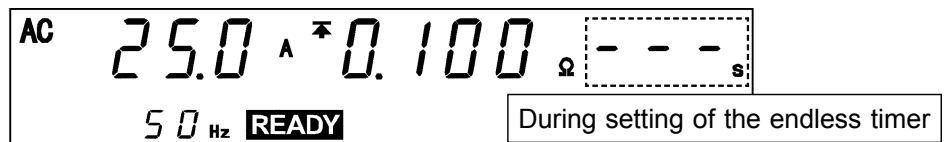

NOTE

If the test time is set to OFF with the **ON/OFF** key instead of using the endless timer function, the test is ended after the test time of 999 s.

4.6 Test Data Count Function

Use the test data count function to display the number of test data.

The test begins with "the number of test data: 1." The number increments by one each time a test completes. Once the maximum number of data is attained, counting restarts at "1."

Increase or decrease of the number of test data can be performed in the READY state, except for the maximum number of test data which cannot be changed. To change the number of test data in the READY state, see Section 3.2.5, "Setting the Test Data Count."

Setting procedure

- (1) Press **SHIFT** + **STOP** while in READY state to display the Optional function setting screen.

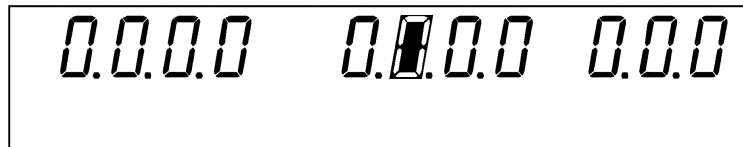

- (2) Use the **◀/▶** keys to move the flashing cursor to the position shown in the figure.
- (3) Use the **▲/▼** keys to set a value at the flashing cursor location.

0: Not set (Initial setting)

1: Set

- (4) Setting the maximum number of test data Select "1: Set" to display the maximum number of test data.

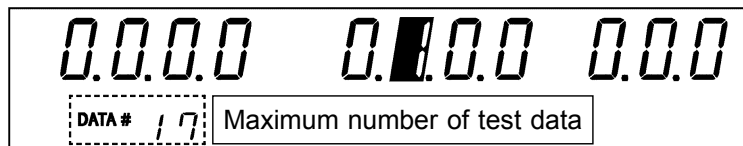

In this example, the maximum number of test data is set at 17. Counting starts at 1 and ends at 17, after which the number reverts to 1.

To change the maximum number of test data, move the flashing cursor to the test data count using the **◀/▶** keys. Change the maximum number of test data using the **▲/▼** keys. To change the number by 10, press **SHIFT** + **▲/▼** keys. The maximum number may be set from 1 to 99.

- (5) To complete the optional settings, press **SHIFT** + **STOP**. The unit reverts to the READY state.

NOTE

- The data can be renewed as the PASS or FAIL state shifts to the READY state. To perform PASS/FAIL screening, you must set maximum and minimum test values and the test time.
- If the test is stopped with the **STOP** key without performing test screening, as in the case of aborting a test, the number of test data is not renewed.
- Output frequency cannot be changed in the READY state if you set the test data count function. To change the frequency, make your settings in the Optional function setting screen.

4.7 Buzzer Setting

The buzzer function is enabled in PASS or FAIL state, or when an error occurs with setting or key operation.

When the buzzer is set to ON, the sound of the buzzer cannot be controlled. The sound is disabled when the buzzer is set to OFF.

Setting procedure

- (1) Press **SHIFT** + **STOP** while in READY state to display the Optional function setting screen.

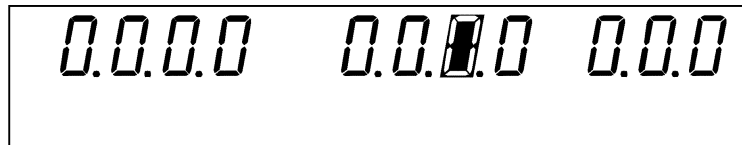

- (2) Use the **◀**/**▶** keys to move the flashing cursor to the position shown in the figure.
- (3) Use the **▲**/**▼** keys to set a value at the flashing cursor location.

0: ON at screening, ON at error (Initial setting)

1: OFF at screening, OFF at error

2: OFF at screening, ON at error

3: ON at screening, OFF at error

- (4) To complete the optional settings, press **SHIFT** + **STOP**. The unit reverts to the READY state.

NOTE

During screening, the length of time the buzzer sounds depends on the settings for the PASS and FAIL hold. For more about the PASS and FAIL hold setting, see "4.2 PASS/FAIL Hold Function."

PASS, FAIL hold setting	PASS buzzer	FAIL buzzer
PASS not held, FAIL held	Approx. 0.5 s	Until held status is reset.
PASS held, FAIL held	Approx. 0.5 s	Until held status is reset.
PASS not held, FAIL not held	Approx. 0.5 s	Approx. 1 s
PASS held, FAIL not held	Approx. 0.5 s	Approx. 1 s

4.8 Changing the Current Value in TEST State

Selecting "1: Changeable" makes it possible to change the output current value during testing in 0.1 A increments, using the \uparrow/\downarrow keys. To change the value by 1.0 A, press SHIFT + \uparrow/\downarrow keys.

The output current value can be set from 3.0 A to 31.0 A. The value cannot be changed if the key-lock function remains active.

If the current value is changed in the TEST state, the current value set in the READY state cannot be changed.

A current value set in the TEST state remains valid until the test is completed.

Selecting "0: Not changeable" disables changing the value, even if you press the \uparrow/\downarrow keys in the TEST state.

Setting procedure

- (1) Press SHIFT + STOP while in READY state to display the Optional function setting screen.

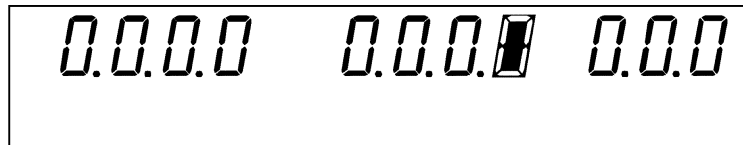

- (2) Use the \leftarrow/\rightarrow keys to move the flashing cursor to the position shown in the figure.
- (3) Use the \uparrow/\downarrow keys to set a value at the flashing cursor location.

0: Not changeable (Initial setting)

1: Changeable

- (4) To complete the optional settings, press SHIFT + STOP . The unit reverts to the READY state.

NOTE

- Because the measured current value is displayed after an averaging operation, there is a brief delay after you press the key before the display reflects the change.
- The zero adjustment function will not be inactivated, even if you change the output current. Note that if the zero adjustment function is active, changing the output current value may produce inaccurate results.

4.9 Momentary OUT

The momentary OUT function allows current output only while the **START** key is held down. Releasing the **START** key is equivalent to pressing the **STOP** key and ends the test.

Keep the **START** key depressed until the test time elapses. After the test time elapses, the unit enters the READY or PASS state, depending on the optional settings. In either state, the next test will not begin even if the **START** key is held down.

To start the next test, release, then press the **START** key. When the unit enters the PASS or FAIL state, cancel the state with the **STOP** key.

If you set the momentary OUT function to "1: Set," a different procedure is required with the **START** key, the START signal for the external I/O terminal and the 9297 CURRENT APPLY PROBE.

For the 9297 CURRENT APPLY PROBE, selecting "0: Not set" enables trigger operation, and selecting "1: Set" enables the momentary OUT function.

Setting procedure

- (1) Press **SHIFT** + **STOP** while in READY state to display the Optional function setting screen.

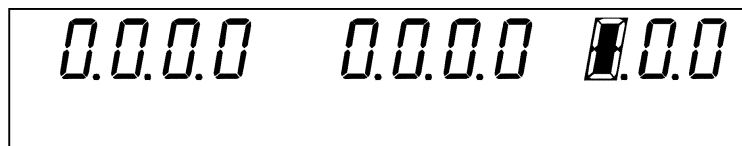

- (2) Use the **◀**/**▶** keys to move the flashing cursor to the position shown in the figure.
- (3) Use the **▲**/**▼** keys to set a value at the flashing cursor location.

0: Not set (Initial setting) (Trigger operation is performed with the 9297.)

1: Set (Momentary OUT operation)

- (4) To complete the optional settings, press **SHIFT** + **STOP**. The unit reverts to the READY state.

NOTE

- Priority for control of the **START** key is in the following order: the external switch, the external I/O, and the front panel of the unit. Connecting the switch signal line plug disables the **START** key on the front panel of the unit and the start signal for the external I/O.
- For the switching probe, you can select between "trigger operation" and "momentary OUT operation." Note that a different switching procedure is required for the operations.
- When the optional continuous test mode is selected, the momentary OUT function is automatically set to "0."

4.9.1 Trigger Operation with Switching Probe

When in the READY state, the push switch performs the same functions as the **START** key.

When not in the READY state, the push switch performs the same functions as the **STOP** key. Pressing the push switch in the TEST state is equivalent to pressing the **STOP** key and ends the test.

If the optional PASS/FAIL state hold function is active, pressing the push switch in either the PASS or FAIL state is equivalent to pressing the **STOP** key, with both actions canceling the hold state.



For the switching probe, you can select between "trigger operation" and "momentary OUT operation." Note that a different switching procedure is required for the operations.

In setting "momentary OUT," select "1: Not set."

The push switch is turned ON at LO level and OFF at HI level in the timing chart.

Example 1 PASS/FAIL hold function: "1: PASS held, FAIL held"
 Endless timer function: "0: Not set"

(1) When the tested sample passes the test:

1. To start the test, press the push switch while in the READY state.
2. The test is complete when the preset test time elapses. The unit enters the PASS state. Since the PASS hold function is active, the PASS state is retained.
3. To release the hold state, press the push switch. The unit enters the READY state.
4. To restart the test, press the push switch.

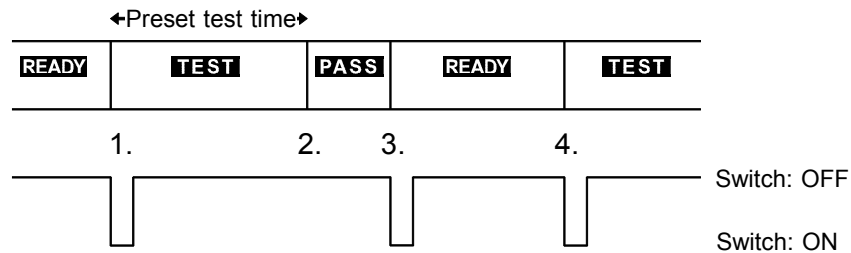

(2) When the test is aborted:

1. To start the test, press the push switch while in the READY state.
2. The test is aborted if the push switch is pressed before the preset test time elapses, with the unit then entering the READY state.
3. To restart the test, press the push switch.

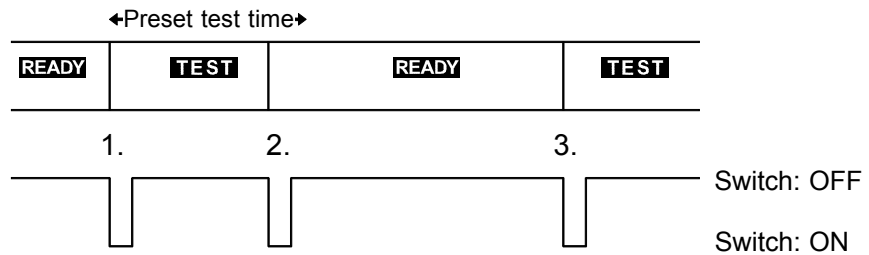

Example 2 PASS/FAIL hold function: "0: PASS not held, FAIL held"

Endless timer function: "0: Not set"

Hold function: "0: Not held"

(1) When the tested sample passes the test:

1. To start the test, press the push switch while in the READY state.
2. The test is complete when the preset test time elapses. The unit enters the PASS state. Since the PASS hold function is inactive, the unit enters the READY state in about 0.5 seconds.
3. To restart the test, press the push switch.

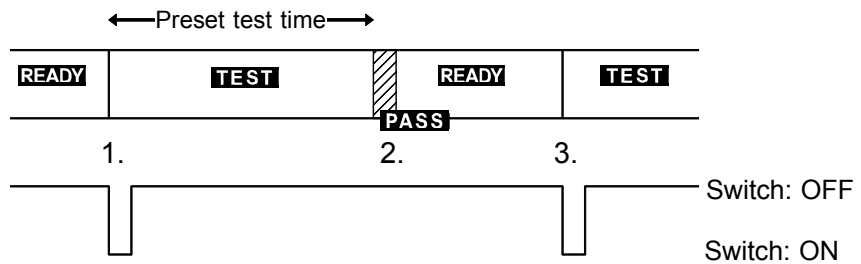

(2) When the tested sample fails the test:

1. To start the test, press the push switch while in the READY state.
2. The unit enters the FAIL state. Since the FAIL hold function is active, the FAIL state is retained.
3. To release the hold state, press the push switch. The unit enters the READY state.
4. To restart the test, press the push switch.

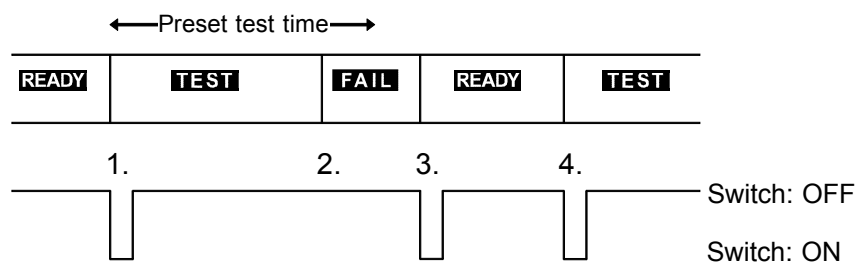

4.9.2 Momentary OUT Operation with Switching Probe

The momentary OUT function allows current output only while the push switch is held down. Releasing the push switch is equivalent to pressing the **STOP** key and ends the test.

A test ends when the test time elapses, even if the push switch is held down.

Depending on the settings, the unit enters either the READY or PASS state. The test also ends if the unit enters the FAIL state during testing, even if you hold down the push switch.

If the optional PASS/FAIL state hold function is active, pressing the push switch in either the PASS or FAIL state is equivalent to pressing the **STOP** key, with both actions canceling the hold state.

NOTE

For the switching probe, you can select between "trigger operation" and "momentary OUT operation." Note that a different switching procedure is required for the operations.

In setting "momentary OUT," select "1: Set."

The push switch is turned ON at LO level and OFF at HI level in the timing chart.

Example 1 PASS/FAIL hold function: "1: PASS held, FAIL held"
 Endless timer function: "0: Not set"

(1) When the tested sample passes the test:

1. To start the test, press the push switch while in the READY state.
2. Hold down the push switch for the duration of the test. Releasing this switch will abort the test.
3. The test is complete when the preset test time elapses. The unit enters the PASS state. Since the PASS hold function is active, the PASS state is retained. In this state, the push switch may be released. The same state is maintained.
4. To release the hold state, press the push switch. The unit enters the READY state.
5. To restart the test, press the push switch.

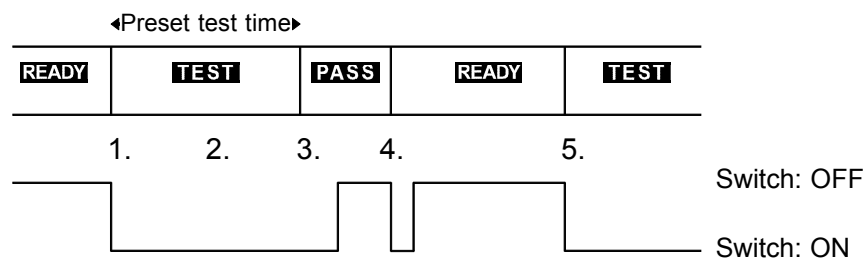

(2) When the test is aborted:

1. To start the test, press the push switch while in the READY state. The TEST state is maintained as long as the push switch is held down.
2. The test is aborted if the push switch is released before the preset test time elapses, with the unit then entering the READY state.
3. To restart the test, press the push switch.

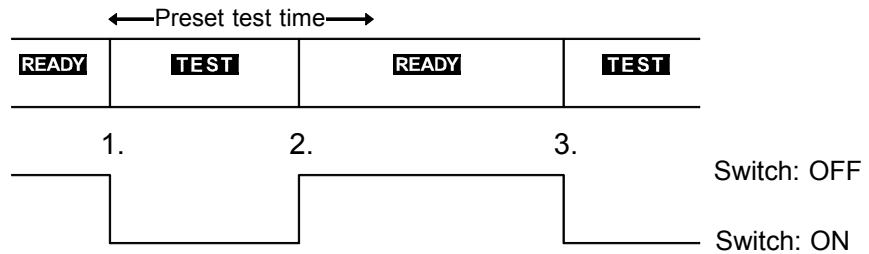

Example 2 PASS/FAIL hold function: "0: PASS not held, FAIL held"

Endless timer function: "0: Not set"

Hold function: "0: Not held"

(1) When the tested sample passes the test:

1. To start the test, press the push switch while in the READY state.
2. Hold down the push switch for the duration of the test. Releasing this switch will abort the test.
3. The test is complete when the preset test time elapses. The unit enters the PASS state. Since the PASS hold function is inactive, the unit enters the READY state in about 0.5 seconds. In this state, the push switch may be released. The same state is maintained.
4. To restart the test, press the push switch.

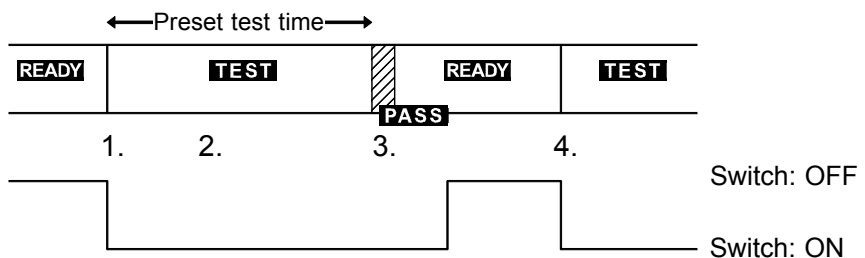

(2) When the tested sample fails the test:

1. To start the test, press the push switch while in the READY state.
2. Hold down the push switch for the duration of the test. The unit enters the FAIL state. Since the FAIL hold function is active, the FAIL state is retained. In this state, the push switch may be released. The same state is maintained.
3. To release the hold state, press the push switch. The unit enters the READY state.
4. To restart the test, press the push switch.

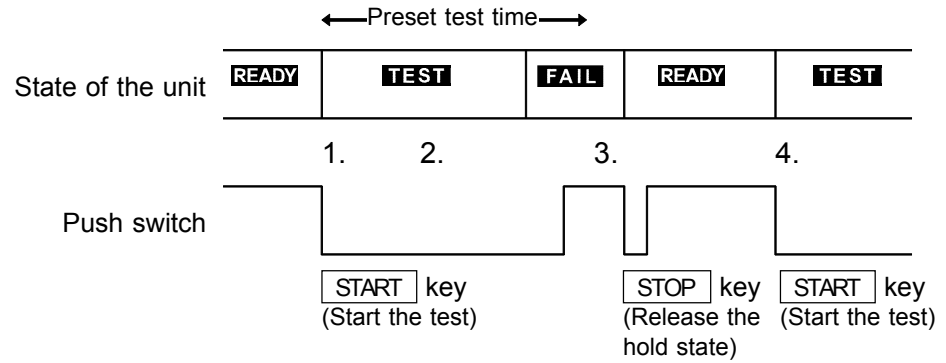

4.10 Setting the Test Mode

Soft start mode, normal mode and continuous test mode can be set.

Setting procedure

- (1) Press **SHIFT** + **STOP** while in READY state to display the Optional function setting screen.

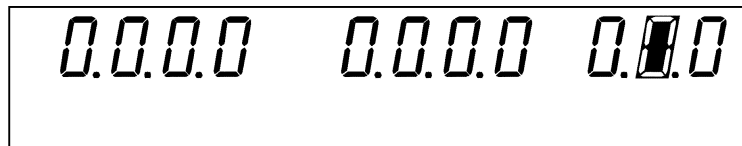

- (2) Use the **◀/▶** keys to move the flashing cursor to the position shown in the figure.
- (3) Use the **▲/▼** keys to set a value at the flashing cursor location.

0: Soft start mode (Initial setting)

1: Normal mode

2: Continuous test mode

- (4) To complete the optional settings, press **SHIFT** + **STOP**. The unit reverts to the READY state.

NOTE

When the continuous test mode is selected, the optional momentary OUT function is automatically set to "0."

4.10.1 Soft Start Mode

NOTE

The soft start mode is active only with a load $0.200\ \Omega$ or less. If the load exceeds this value, the state of connection of the probe is not known, and a test cannot be started.

This function checks whether the probe is in contact with the measured object by constantly monitoring the output current value. With this function selected, no current is output if the test begins with a disconnected probe. When the probe contacts the measured object, the test begins without sparks. The instant the probe is detached from the measured object during testing, output current is halted, and the unit enters the READY state.

- (1) Set the appropriate parameters in the READY state.
- (2) Press the **START** key to start the test. If the probe is detached from the measured object, the test will not start, and the unit will enter the stand-by state (as indicated by a blinking **TEST** lamp). If this state continues for more than 30 seconds, the unit returns to the READY state. The test begins when the probe is connected to the measured object.
- (3) If the probe is detached from the measured object during testing, the **FAIL** lamp lights together with the **UPPER** and the **LOWER** lamps, and the unit enters FAIL state.
- (4) To end the test normally, the probe must contact the measured object throughout the test.

Flow of operation in Soft start mode

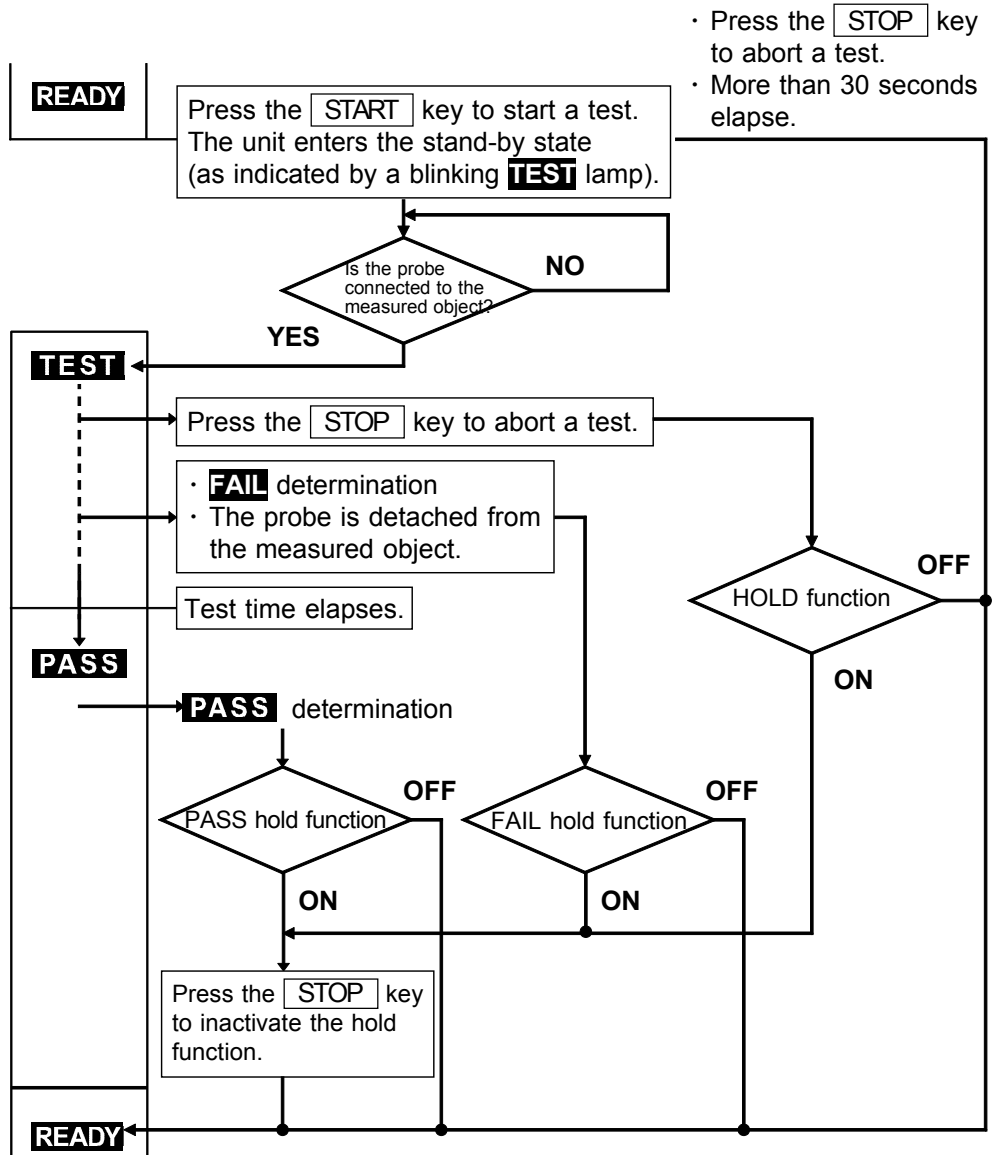

4.10.2 Normal Mode

Select normal mode if the anticipated load resistance is $0.200\ \Omega$ or greater.

In normal mode, press the **START** key in READY state while the soft start function is in the stand-by state (as indicated by a blinking **TEST** lamp). When the **START** key is pressed, the unit enters TEST state.

If the probe is detached from the measured object during testing, the **FAIL** lamp lights together with the **UPPER** and the **LOWER** lamps, and the unit enters FAIL state.

The unit will not detect the connection state of the probe. To avoid occurrence of sparks between the probe and the device being tested, make the connections before pressing the **START** key.

Flow of operation in Normal mode

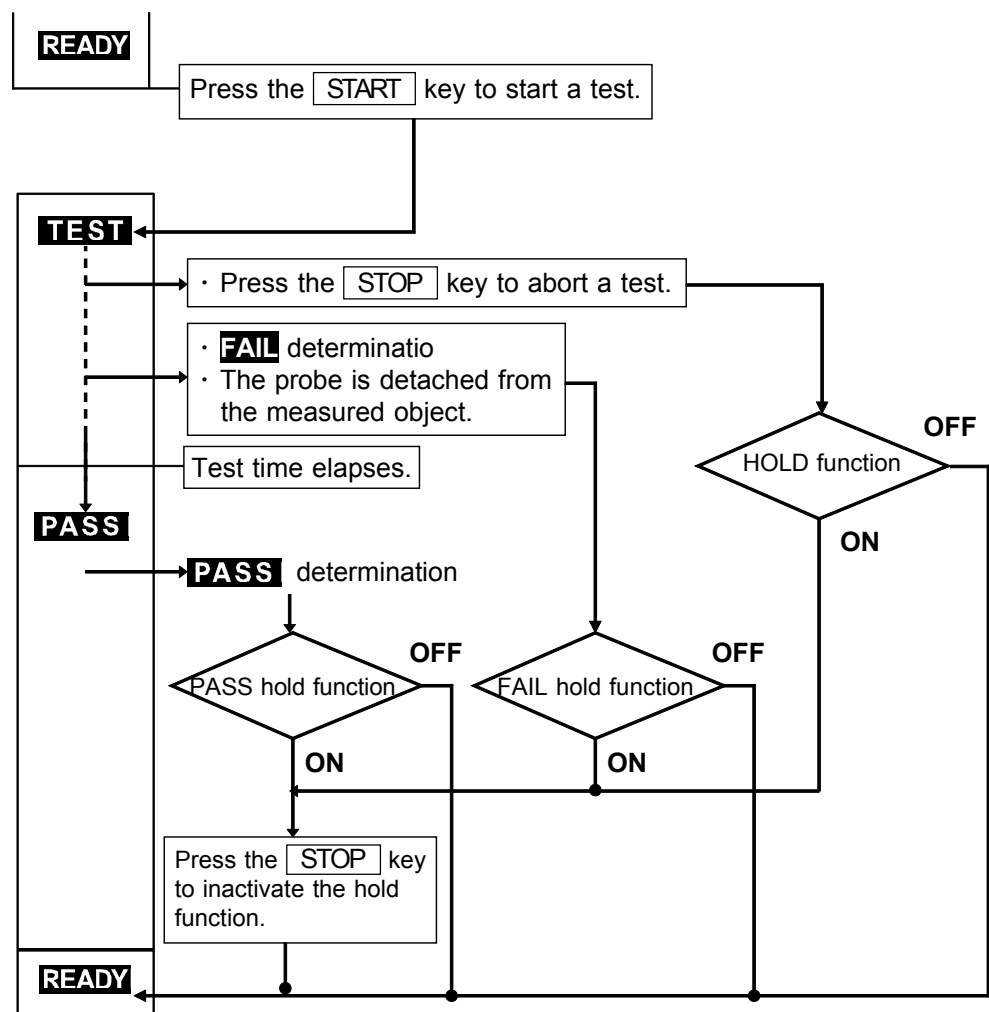

NOTE

Select normal mode if the anticipated load resistance is $0.200\ \Omega$ or greater.

4.10.3 Continuous Test Mode

Unlike the soft start mode, the continuous test mode places the unit into the hold state if the probe is detached from the measured object, suspending output. To restart the test, cancel the hold state and connect the probe to the measuring object.

- (1) Set the appropriate parameters in the READY state.
- (2) Press the **START** key to start the test. If the probe is detached from the measured object, the test will not start, and the unit will enter the stand-by state (as indicated by a blinking **TEST** lamp). If this state continues for more than 30 seconds, the unit returns to the READY state. The test begins when the probe is connected to the measured object.
- (3) If the probe is detached from the measured object during testing, the test is aborted. The unit enters the hold state instead of the READY state. To end the test normally, the probe must contact the measured object throughout the test. When the test finishes, the screening results will determine a state of PASS or FAIL.
- (4) Cancel the hold state. The unit enters the stand-by state (as indicated by a blinking **TEST** lamp) preparatory to beginning a test. The values measured in the preceding test are retained, even in this state.

Canceling hold state

HOLD ON: Press the **STOP** key and detach the probe from the measured object (the reverse step is allowed).

HOLD OFF: Detach the probe from the measured object.

- (5) Connect the probe to begin the next test.
- (6) To enter the READY state after testing, press the **STOP** key in the TEST or stand-by state (as indicated by the blinking **TEST** lamp). If you press the **STOP** key while the unit is in the hold state, the unit will not enter the READY state. This is because the action is interpreted as canceling the hold state.

NOTE

- The values measured in the test are retained by the PASS/FAIL hold function and the hold function at the end of the testing if the unit is in continuous test mode. Note that different settings require different methods of canceling.
- The continuous test mode and the momentary OUT function are not compatible. If continuous test mode is selected in test mode, the momentary OUT function is automatically reset to "0."

Flow of operation in Continuous test mode

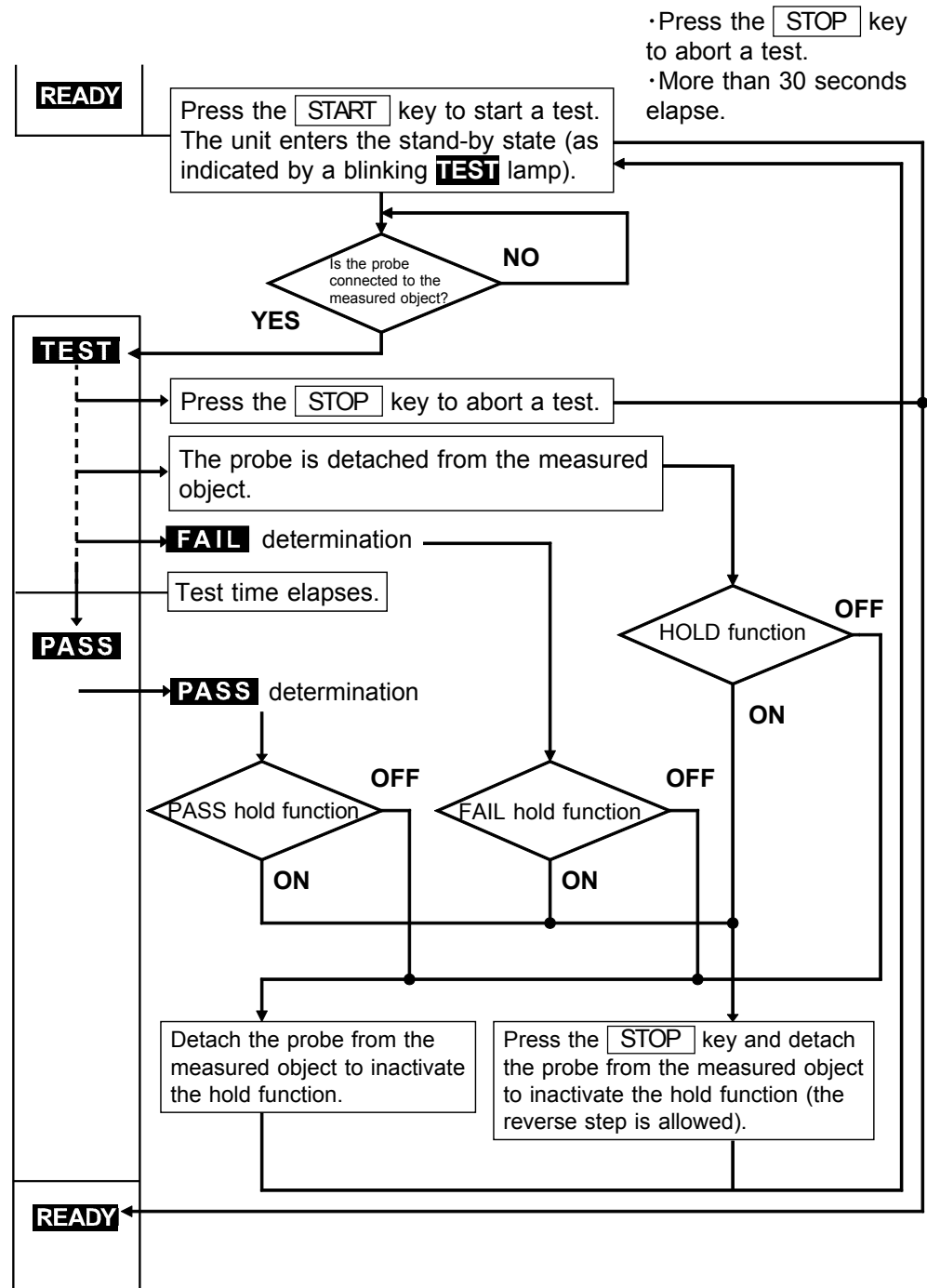

4.11 Printer Output

You can print test parameters and results with the optional 9442 PRINTER. This printer offers the following two print modes.

When "0: Not used" is selected, the printer will not print, even if connected.

When "1: Automatically print for PASS/FAIL screening" is selected, press the **STOP** key for about two seconds in the READY state to print the test results.

The test results are printed automatically when the unit enters the PASS or FAIL state, whether or not the state is retained.

When "2: Selectively print when the PASS/FAIL state is held" is selected, printing begins about two seconds after the **STOP** key is pressed to cancel the PASS/FAIL hold state. Unless the **STOP** key is kept pressed, the **STOP** key cancels the PASS/FAIL hold state without printing, and the unit reverts to the READY state.

To print the test results, you must make the appropriate settings to retain either the PASS or FAIL state, using the PASS/FAIL hold function.

Setting procedure

- (1) Press **SHIFT** + **STOP** while in READY state to display the Optional function setting screen.

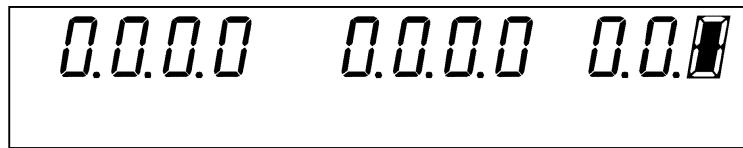

- (2) Use the **◀/▶** keys to move the flashing cursor to the position shown in the figure.
- (3) Use the **▲/▼** keys to set a value at the flashing cursor location.

0: Not used (Initial setting)

1: Automatically print for PASS/FAIL screening.

2: Print selectively when the PASS/FAIL state is held.

- (4) To complete the optional settings, press **SHIFT** + **STOP**. The unit reverts to the READY state.

NOTE

- The printer output settings apply only when the 9593-02 RS-232C INTERFACE and the 9442 PRINTER are connected. Connect the 9593-02 and the 9442 before starting up.
For more information on settings, see the accompanying manual and Appendix 1, "Options".
- If the printer output function is set to "1: Automatically print for PASS/FAIL screening" and the PASS/FAIL hold function to "PASS/FAIL not held," the PASS or FAIL state may be verified on the printer, but not on screen.
If the continuous test mode and the test data count mode are set, you can continue testing as the results print by keeping your hand on the probe.
- The test parameters cannot be printed using the push switch on the 9297 CURRENT APPLY PROBE.

Example of printing

Example of set value printing

```

SETTING
CURRENT   : 25.0 A , 50 Hz
UPPER     : 0.100 ohm
LOWER     : 0.005 ohm
TIME      : 60.0 s
MAX DATA # : 10

```

Example of test result printing

```

HIOKI 3157 AC GROUNDING HiTESTER
DATA #    : 1 / 10
JUDGEMENT : PASS
RESISTANCE : 0.030 ohm ( 0.75 V )
CURRENT   : 24.9 A , 50 Hz

```

```

DATA #    : 2 / 10
JUDGEMENT : UPPER FAIL
           5.1 s / 60.0 s
RESISTANCE : 0.129 ohm ( 3.23 V )
CURRENT   : 25.0 A , 50 Hz

```

Actual size

Set value printing

SETTING	Shows test parameter printing.
CURRENT	Set current value and output current frequency
UPPER	Maximum test value
LOWER	Minimum test value "---" is printed if the optional minimum test value setting function is set to "0: Not set."
TIMER	Testing Time "---" is printed if the optional endless timer function is set to "1: Set."
MAX DATA #	Maximum number of test data (Not printed for OFF)

Test result printing

HIOKI 3157 GROUNDING HiTESTER	Model name This is printed if the test data count function is not used or if the number of test data is 1.)
DATA #	Number of test data and maximum number of test data These are not printed if the test data count function is not used.
JUDGEMENT	Test result PASS, UPPER FAIL or LOWER FAIL is printed. The elapsed time and testing time are also printed for FAIL.
RESISTANCE	Measured resistance value and measured voltage value at the end of a test
CURRENT	Measured current value and frequency at the end of a test

4.12 Example of Optional Function Settings

We assume that the 3157 is in the READY state and that the minimum test value setting function and the test data count function are inactive.

The following example shows how to set the number of test data to "5," after activating the minimum test value setting and test data count functions.

Since the minimum test value setting function is disabled, the flashing cursor does not move to the minimum test value. Because the test data count function is also inactive, the output current frequency is displayed.

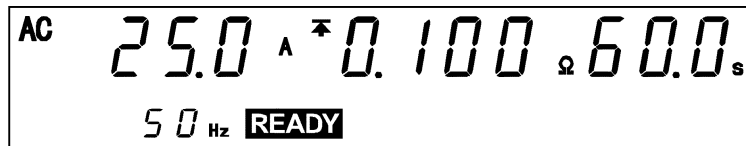

- (1) Press **SHIFT** + **STOP** to display the Optional function setting screen.

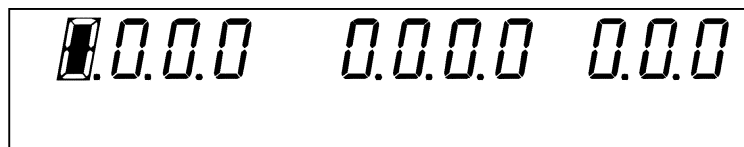

- (2) To change the setting of the minimum test value, move the flashing cursor to the fourth number from the left. In the optional function setting screen, the flashing cursor will first appear at the leftmost position. Press the **▶** key three times to move to the fourth number.

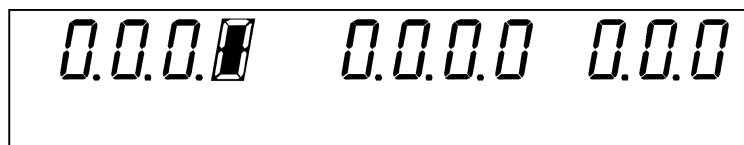

- (3) "Minimum test value setting" is set to "0: Not set." Using the **▲**/**▼** keys, change the setting to "1: Set."

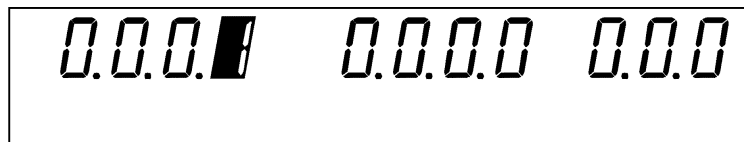

- (4) Next, using the \uparrow/\downarrow keys, change "Test data count" from "0: Set" to "1: Not set." In "Test data count," change the sixth number from the left to "1."

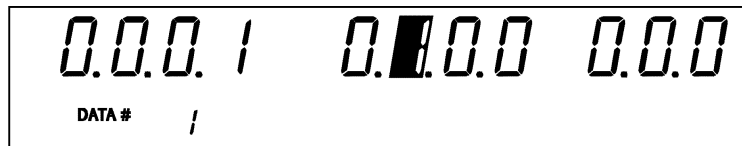

When "Test data count" is activated, the screen shifts to allow you to set a maximum value for the number of test data. In this example, the current maximum number is "1."

- (5) To change the maximum number of test data to "5," move the flashing cursor by using the \leftarrow/\rightarrow keys to the maximum value in "Number of test data."

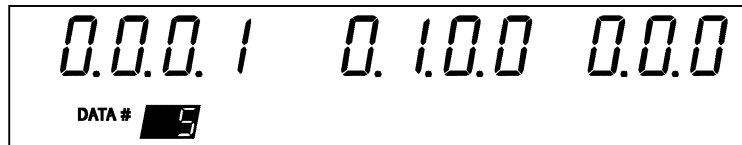

Use the \uparrow/\downarrow keys to change the maximum value for the number of test data. In this example, press the \uparrow key four times.

- (6) Press $\text{SHIFT} + \text{STOP}$. This operation finalizes the optional settings, after which the unit reverts to the READY state.

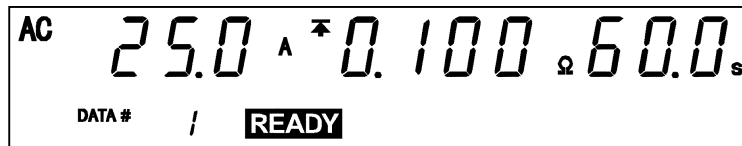

After "Test data count" is set, the output current frequency is replaced by "Number of test data."

4.13 Example of Optional Functions Use

The following describes how 3157 optional functions are used in testing. Varying combinations of optional functions are available for testing.

(1) Testing to check test results, using the 3157

Optional function settings

0.10.0	0.10.0	0.0.0
DATA# 10		

Optional function	Selection
PASS/FAIL hold function	1: PASS held, FAIL held
Test data count function	1: Set
Test mode	0: Soft start mode

Advantages of these settings

- PASS or FAIL state is held, allowing inspection of test results. Test results can also be checked with the buzzer.
- The number of tests can be counted using the test data count function.
- The soft start function allows safe testing.

(2) Testing to check test results, using the printer

Optional function settings

0.20.0	0.10.0	0.0.1
DATA# 10		

Optional function	Selection
PASS/FAIL hold function	2: PASS not held, FAIL not held
Test data count function	1: Set
Test mode	0: Soft start mode
Printer output	1: Automatically print for PASS/FAIL screening.

Advantages of these settings

- The test results are output to a printer, which is set to "Automatically print for PASS/FAIL screening." The results will not appear on screen, since the PASS or FAIL state is not held. This setting is useful when checking results after performing a number of tests.
- Once enabled, the test data count function allows you to print the total number of test data. This permits inspection of failed items.
- The soft start function allows safe testing.

(3) Continuous test mode using the 9297 CURRENT APPLY PROBE
Optional function settings

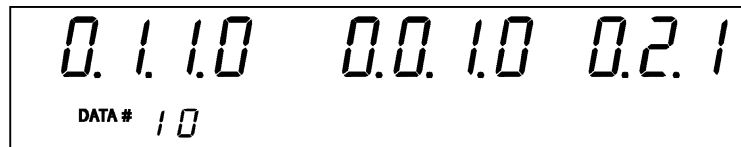

Optional function	Selection
PASS/FAIL hold function	2 : PASS not held, FAIL not held
Hold function	0 : Not held
Test data count function	1 : Set
Test mode	2 : Continuous test mode
Printer output	1 : Automatically print for PASS/FAIL screening.

Advantages of these settings

- This setting is useful when testing a device with more than one test point. Connect the 9296 CURRENT PROBE to the protection conduction terminal and apply the 9297 CURRENT APPLY PROBE to a test point. Since continuous test mode is active, test results are displayed for the preset time period as long as the probe is held against a test point.
- In continuous test mode, a new test begins when the probe comes in contact with the next test point. The PASS/FAIL hold function and the hold function must be set to "Not held."
- If the maximum number of test data is set to the number of tests, the number of test data is reset to "1" after all test points are tested. This allows accurate counting of test points.
- Test results are sent to the printer after each device is tested.

Chapter 5

Saving/loading Preset Values

5.1 Saving Preset Values

The following describes a function used to save values set in the READY state. Up to twenty parameters may be saved. To retrieve saved data, follow the procedures described in Section 5.2, "Loading Preset Values."

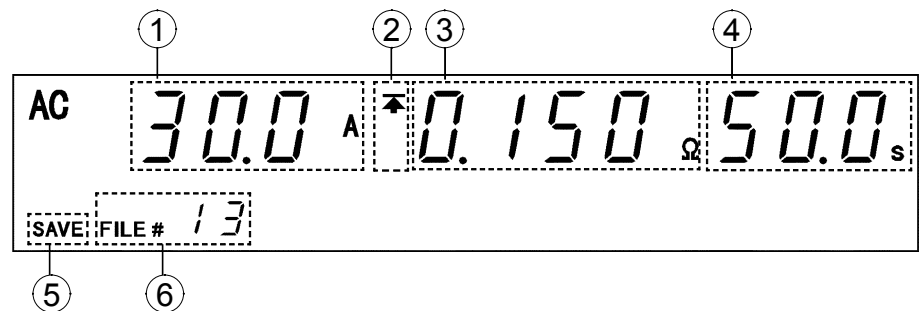

- ① Preset current value
Shows the preset current value for the set data being displayed.
- ② Maximum value icon and minimum value icon
The symbol \uparrow appears when the maximum test value is displayed, and the symbol \downarrow appears when the minimum value is displayed.
- ③ Maximum and minimum test values
Shows maximum and minimum test values for the data being displayed.
- ④ Test time
Shows the test time for the data being displayed.
- ⑤ SAVE
Shows that the screen appearing is for saving the data (the save screen).
- ⑥ File number
This value indicates the file number for the data containing the preset current value, maximum test value, minimum test value, and the test time currently displayed.

5.1.1 Procedure for Saving Data

To select a preset value to be saved, the unit must be in the READY state. Preset values cannot be changed in the save screen.

The following six parameters may be saved:

1. Preset current value
2. Maximum test value
3. Minimum test value
4. Test time
5. Optional maximum test value setting function
6. Optional endless timer setting function

(1) Displaying the save screen

With the target preset value displayed in the READY state, press **SHIFT** + **▶** key to shift to the save screen.

In the save screen, the saved data for the file number replaces the target value displayed in the READY state.

The first saved data displayed is the last data from the previous save screen.

(2) Selecting a file to save

The new data overwrites the previous data. Look for the saved data to be deleted, using the **▲**/**▼** keys. Press **SHIFT** + **▲**/**▼** keys to increase the file number by five.

Use the **◀**/**▶** keys to switch between maximum and minimum test values (these keys are disabled if the saved data is set to "0: Not set" by the optional minimum test value setting function).

(3) Saving and canceling data

When the saved data to be deleted is displayed, press **SHIFT** + **▶**. This deletes the saved data and saves the value set in the READY state.

After the **SAVE** lamp flashes, the unit reverts to the READY state.

Press the **STOP** key to revert to the READY state without saving the target data.

NOTE

- Even if maximum and minimum test values for data to be saved are expressed in resistance, voltage values are also saved. The voltage value saved is the one displayed when the display shifts between resistance and voltage in the READY state. This process is reversed when data is represented in voltage. Since information is also saved that determines whether the maximum and minimum test values for the saved setting data is in resistance or in voltage, the set value is displayed in the save screen. Since all of this data is loaded, the screen also displays irrelevant values.
- The minimum test value and test time are saved even if the optional minimum test value setting function and endless timer functions are set to "0: Not set." If these settings are modified after loading, the screen may display irrelevant values.
- Even if it is preset, the zero adjustment value is not saved. This value is valid when the unit reverts to the READY state from the save screen.

5.1.2 Example of Saving

The following example shows how to save in File No.3. We assume that the 3157 is in the READY state.

- (1) In the READY state, set the preset value to save. For more information on making these settings, see Chapter 3, "Testing Method."

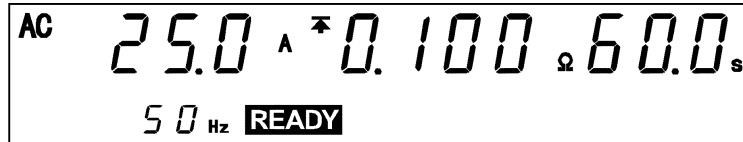

In this example, settings are made as follows:

Preset current value	25.0 A
Maximum test value	0.100 Ω
Minimum test value	OFF
Testing time	60.0 s

- (2) Press **SHIFT** + **▶** to bring up the save screen.

In the save screen, the value set in the READY state is replaced by the saved data being displayed. The first saved data displayed is the last data item from the previous save screen. This example shows "File No.1."

The new data overwrites the previous data. Use the **▲**/**▼** keys to select the data to be overwritten. The new data in this example is to be saved in File No.3.

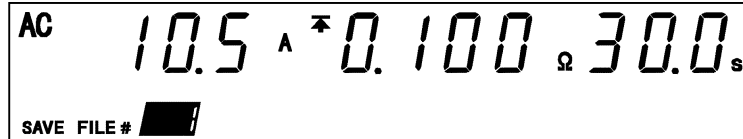

In this status, the preset minimum test valve can be checked by using the **◀** or **▶** key.

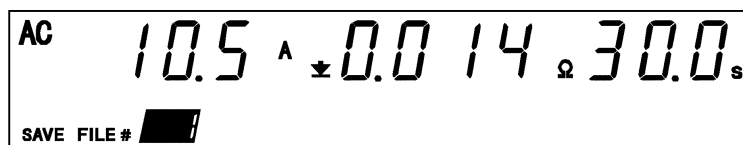

In this example, File No. 1 contains the following settings.

Preset current value	10.5 A
Maximum test value	0.100 Ω
Minimum test value	0.014 Ω
Testing time	30.0 s

- (3) Use the \uparrow/\downarrow keys to select File No.3.

This example shows File No. 1. Press the \uparrow key twice to display File No.3.

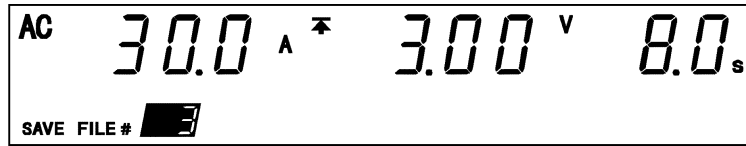

- (4) Use the \leftarrow/\rightarrow keys to check maximum and minimum test values.

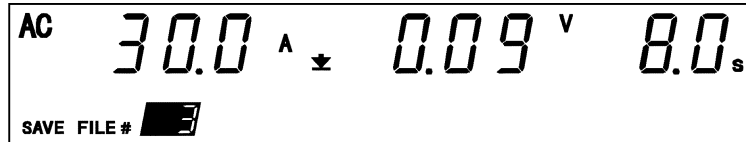

In this example, File No. 3 contains the following settings.

Preset current value	30.0 A
Maximum test value	3.00 V
Minimum test value	0.09 V
Testing time	8.0 s

- (5) To save the data, press **SHIFT** + \rightarrow . The unit reverts to the READY state. Once saved, the value set in the READY state is retained in File No.3. Note that File No.3, shown in Step (4) above, is deleted.

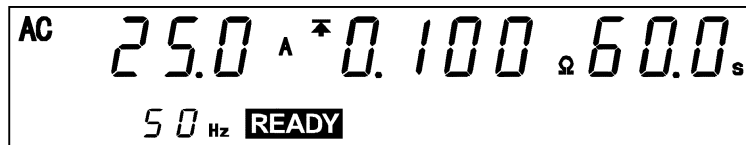

To abort the save procedure, press the **STOP** key at Step (4). The unit halts the save procedure and reverts to the READY state.

5.2 Loading Preset Values

The following describes how to load saved data. Twenty preset values may be saved. Use this function to instantly change a preset value.

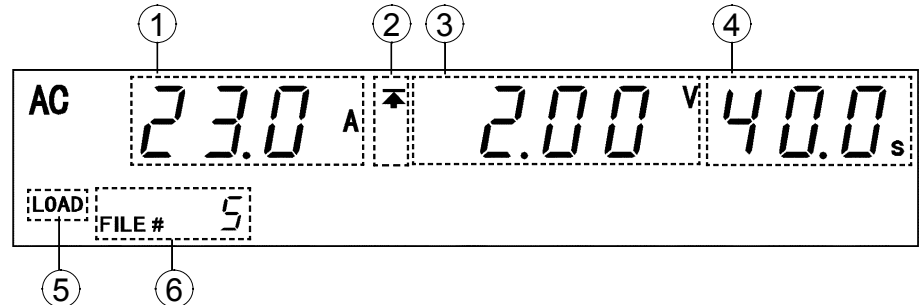

- ① Preset current value
Shows the preset current value for the set data being displayed.
- ② Maximum value icon and minimum value icon
The symbol \uparrow appears when the maximum test value is displayed, and the symbol \downarrow appears when the minimum value is displayed.
- ③ Maximum and minimum test values
Shows maximum and minimum test values for the data being displayed.
- ④ Test time
Shows the test time for the data being displayed.
- ⑤ Load
Shows that the screen appearing is for loading the data (the load screen).
- ⑥ File number
This value indicates the file number for the data containing the preset current value, maximum test value, minimum test value, and the test time currently displayed.

5.2.1 Procedure for Loading Data

Before loading, carefully read Section 5.1, "Saving Preset Values" and prepare the data to be saved. The following are factory-set data.

Preset current value	25.0 A
Maximum test value	0.100 Ω (2.5 V)
Minimum test value	OFF (OFF)
Testing time	60.0 s
Minimum test value setting	Inactive
Testing time setting	Active

(): Voltage value

The following six parameters may be loaded:

1. Preset current value
2. Maximum test value
3. Minimum test value
4. Test time
5. Optional maximum test value setting function
6. Optional endless timer setting function

(1) Displaying the load screen

To load the saved data, Press **SHIFT** + **◀** key in the READY state to shift to the load screen.

In the load screen, a number for saved data equal to the file preset replaces the target value displayed in the READY state.

The first saved data displayed is the last data from the previous load screen.

(2) Selecting a file to save

Look for the saved data to be loaded, using the **▲**/**▼** keys.

Use the **◀**/**▶** keys to switch between maximum and minimum test values (these keys are disabled if the saved data is set to "0: Not set" by the optional minimum test value setting function).

(3) Loading and canceling data

When the saved data to be loaded is displayed, press **SHIFT** + **◀**. This loads the saved data and the unit reverts to the READY state.

Press the **STOP** key to revert to the READY state without loading the target data.

NOTE

- Even if maximum and minimum test values for data to be saved are expressed in resistance, voltage values are also saved. The voltage value saved is the one displayed when the display shifts between resistance and voltage in the READY state. This process is reversed when data is represented in voltage. Since information is also saved that determines whether the maximum and minimum test values for the saved setting data is in resistance or in voltage, the set value is displayed in the load screen. Since all of this data is loaded, the screen also displays irrelevant values.
- The minimum test value and test time are saved even if the optional minimum test value setting function and endless timer functions are set to "0: Not set." If these settings are modified after loading, the screen may display irrelevant values.
- If data is loaded with the zero adjustment value set, the zero adjustment function is automatically disabled. This value is valid when the unit reverts to the READY state from the load screen without loading data.

5.2.2 Example of Loading

The following example shows how to load File No.3. We assume that the 3157 is in the READY state.

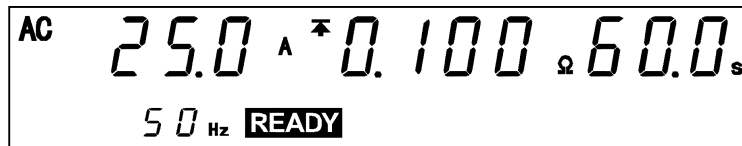

- (1) Press **SHIFT** + **◀** to bring up the load screen.

In the load screen, the value set in the READY state is replaced by the saved data being displayed. The first saved data displayed is the last data item from the previous load screen. This example shows "File No.1."

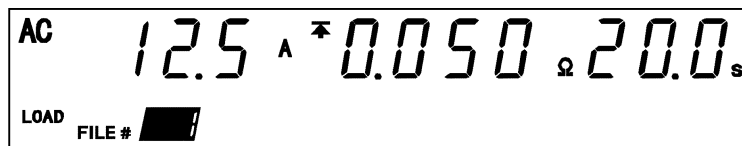

In this status, the preset minimum test valve can be checked by using the **◀** or **▶** key.

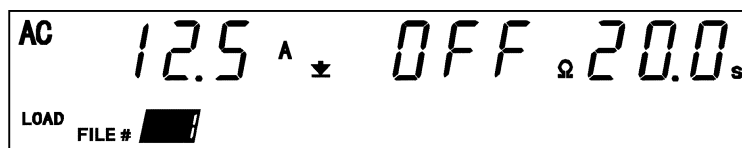



In this example, File No. 1 contains the following settings.

Preset current value	12.5 A
Maximum test value	0.050 Ω
Minimum test value	OFF
Testing time	20.0 s

- (2) Use the **▲**/**▼** keys to select File No.3.

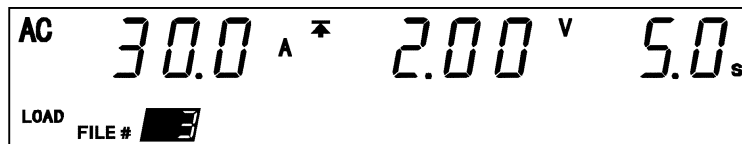
This example shows File No. 1. Press the **▲** key twice to display File No.3.



(3) Use the / keys to check maximum and minimum test values.

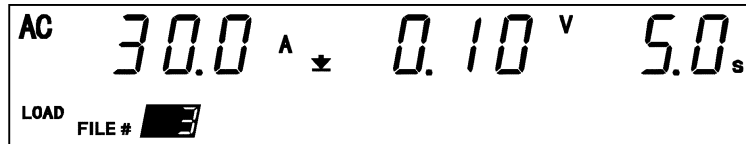

In this example, File No. 3 contains the following settings.

Preset current value	30.0 A
Maximum test value	2.00 V
Minimum test value	0.10 V
Testing time	5.0 s

(4) To load the data, press  + . The unit reverts to the READY state. To abort the load procedure, press the  key.

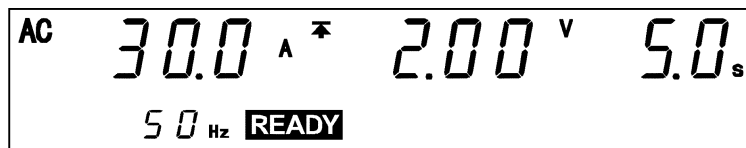

Chapter 6

External I/O

Both output signals regarding the status of the 3157 (e.g., READY state) and input signals to the **START** key and the **STOP** key are controlled through the external I/O terminal, located at the back of the unit.

All signal lines are internally insulated by the photocoupler. Prepare an external power source (5 V to 24 VDC). The external I/O function can be temporarily used since the internal power source (5 V) and GND are output from the external I/O terminal. Care must be taken because the signal lines are not insulated when the external I/O function is used.

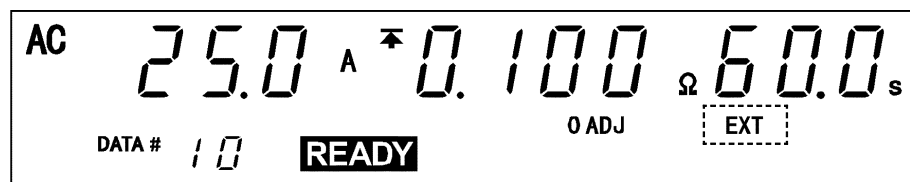

When $\overline{\text{EXT-E}}$ of the external I/O terminal is at LO, the **EXT** lamp lights to indicate that the external I/O is active.

NOTE

When $\overline{\text{EXT-E}}$ of the external I/O terminal is at LO, the unit **START** key is disabled. If you use an external switch, the START signal for the external I/O terminal is disabled. The priority hierarchy for the **START** keys is given below. When a **START** key with a higher priority is in use, lower-priority keys are disabled:

Priority: External switch > External I/O > Front panel of the unit.

6.1 Signal Line

The following external I/O connectors are used.

Connector of the 3157 main unit	DDK Ltd.'s 57RE-40360-730B (D29) 36-pin receptacle
Compatible connector	DDK Ltd.'s 57-30360, 57E-30360, 57F-30360 and 57FE-30360 Hirose Electric's RC30-36P 36-pin

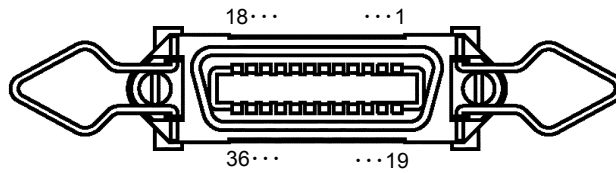

External I/O connector pin numbering

Pin number	I/O	Signal line name	Pin number	I/O	Signal line name
1	OUT	READY	19	OUT	INT.GND
2	OUT	L-FAIL	20	OUT	INT.GND
3	OUT	U-FAIL	21	OUT	INT.GND
4	OUT	PASS	22	OUT	INT.GND
5	OUT	TEST	23	OUT	INT.GND
6	OUT	INT.GND	24	OUT	INT.GND
7	IN	EXT-E	25	OUT	INT.GND
8	IN	START	26	OUT	INT.GND
9	IN	STOP	27	OUT	INT.GND
10	OUT	INT.GND	28	OUT	INT.GND
11	IN	EXT.DCV	29	OUT	INT.DCV
12	IN	EXT.DCV	30	OUT	INT.DCV
13	IN	EXT.DCV	31	OUT	INT.DCV
14	IN	EXT.DCV	32	OUT	INT.DCV
15	IN	EXT.COM	33	OUT	INT.GND
16	IN	EXT.COM	34	OUT	INT.GND
17	IN	EXT.COM	35	OUT	INT.GND
18	IN	EXT.COM	36	OUT	INT.GND

Function of the signal line

Signal line name	I/O	Function
READY	OUT	LO in the READY state
$\overline{\text{L-FAIL}}$	OUT	LO in the FAIL state at LOWER (minimum value)
$\overline{\text{U-FAIL}}$	OUT	LO in the FAIL state at UPPER (maximum value)
PASS	OUT	LO in the PASS state
TEST	OUT	LO in the TEST state
$\overline{\text{EXT-E}}$	IN	When this signal becomes LO, the START signal on the external I/O connector becomes valid.
START	IN	LO is equivalent to pressing the unit START key and provides the same functions. 100 ms min.
STOP	IN	LO is equivalent to pressing the unit STOP key and provides the same functions. This signal is valid regardless of $\overline{\text{EXT-E}}$ status. 50 ms min.
EXT.DCV	IN	Terminal for supplying power from external equipment. Use this to insulate the unit from external equipment. Effective source voltage: 5 V to 24 VDC.
EXT.COM	IN	This terminal is used to input GND for the external equipment. Use this to insulate the unit from external equipment.
INT.DCV	IN	Generates an internal source (5 VDC) for the unit. Used temporarily to activate the external I/O function. Note that the signal line is not insulated.
INT.GND	IN	Generates an internal GND for the unit. Used temporarily to activate the external I/O function. Note that the signal line is not insulated.

The signal ($\overline{\text{STOP}}$) is valid regardless of $\overline{\text{EXT-E}}$ status.

External I/O

The output signals are the open collector outputs of the photocouplers, and are connected to the external DC power supply (EXT. DCV) via 4.7 k Ω pull-up resistors.

The input signals are connected to the drive of the photocouplers, and are connected to the external DC power supply (EXT. DCV) via 4.7 k Ω pull-up resistors.

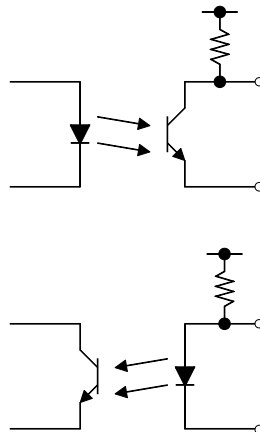

The insulation of the signal lines is for eliminating mutual influences between the signals. Any external device which is connected to the 3157 unit should always be properly protectively grounded. If proper connection to a protective ground is not established, there is a danger of damage to the insulation. The voltage of the external DC power supply to be connected to the EXT DCV and EXT COM terminals should be from 5 V to 24 V. Do not supply DC voltage greater than 24 V. If you do, there is a danger of damage to the unit. Moreover, for driving the circuitry, connect any device which is capable of providing an output current of more than 200 mA.

The relationship between the external DC power supply voltage, the voltage of the output signals, and the current, is as shown in the following table:

External DC power supply voltage	Output signals (internal pull-up resistors 4.7 kΩ)			
	High level	Low level		
		Output current 10 mA	Output current 40 mA	Output current 60 mA max.
5 V	5 V	0.9 V	1.1 V	1.2 V
12 V	12 V	0.9 V	1.1 V	1.2 V
24 V	24 V	0.9 V	1.1 V	1.2 V

Direct connection of a circuit whose input voltage is regulated to a maximum of 0.8 V or the like is not possible.

In such a case, keep input voltage below 0.8 V by incorporating a transistor or a drive capable buffer circuit or the like.

Example of input signal connection

When using the internal power supply, use the wiring indicated by the dotted lines (INT.DCV to EXT.DCV and INT.GND to EXT.COM) instead of external power supply and EXT.DCV connection.

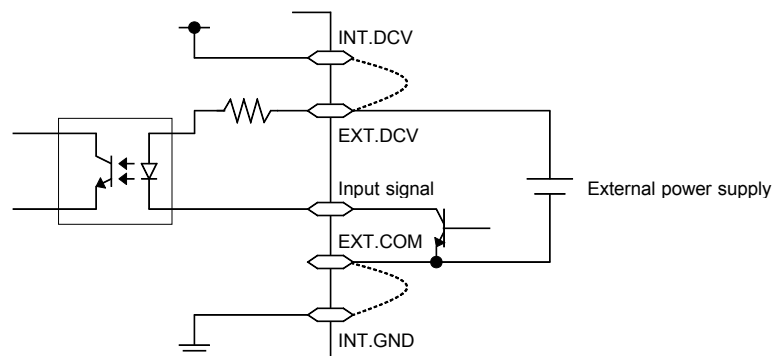

Example of output signal connection

When using the internal power supply, use the wiring indicated by the dotted lines (INT.DCV to EXT.DCV and INT.GND to EXT.COM) instead of external power supply and EXT.DCV connection.

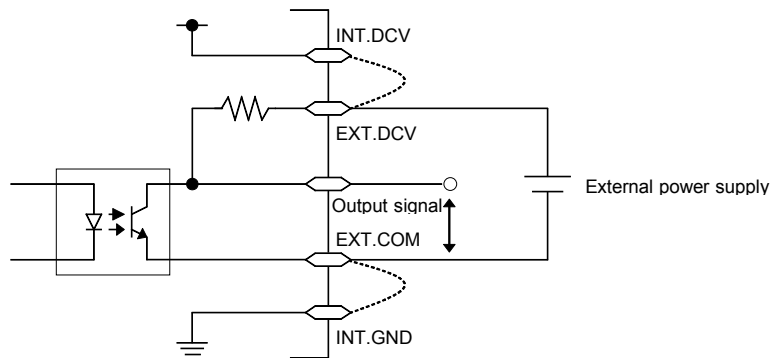

NOTE

- When using the external I/O connector, provide the external DC power supply between EXT.DCV and EXT.COM.
The output signal low level output current is a maximum of 60 mA. If a current greater than this is required, you should connect a transistor circuit using a current amplifier driven by an external power source or the like externally.
- If no external DC power supply is available, use the internal DC power supply. Connect INT.DCV to EXT.DCV and INT.GND to EXT.COM.
- The internal DC power supply of 5 VDC is provided between INT DCV and INT GND. The maximum current capacity is 100 mA. Do not connect any external circuit whose current consumption is greater than 100 mA. INT GND is grounded to the chassis of the 3157 unit.
- The output signal status upon power-on may be undetermined. Care should be taken in the operation of equipment connected to the external I/O.

6.2 Timing Chart of External I/O Terminal

(1) Timing chart at time of start of testing

When a test starts, the $\overline{\text{READY}}$ signal indicates HI and the $\overline{\text{TEST}}$ signal indicates LO.

The $\overline{\text{TEST}}$ signal changes according to the **TEST** indicator on the fluorescent display, indicating LO at zero adjustment as well as during testing.

The $\overline{\text{TEST}}$ signal will indicate LO in the stand-by state (as indicated by a blinking **TEST** lamp) if soft start or continuous test mode is active.

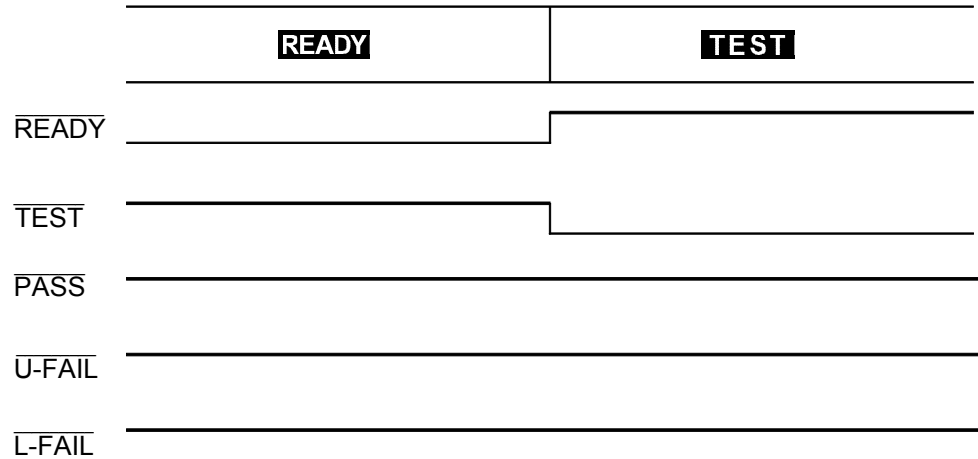

(2) Timing chart during a test decision

The figure shows the timing chart of the unit in PASS state after a test. In PASS state, the $\overline{\text{TEST}}$ signal indicates HI.

The $\overline{\text{PASS}}$ signal changes according to the **PASS** indicator on the fluorescent display. If the PASS hold function is enabled, the $\overline{\text{PASS}}$ signal continues to indicate LO until the function is disabled.

If the hold function is disabled or if the unit automatically returns to READY state, the $\overline{\text{PASS}}$ signal indicates HI and the $\overline{\text{READY}}$ signal indicates LO.

In UPPER-LOWER FAIL state, which results when output currents remain below the set value, both the $\overline{\text{U-FAIL}}$ signal and the $\overline{\text{L-FAIL}}$ signal indicate LO.

Likewise, in FAIL state, the $\overline{\text{U-FAIL}}$ signal indicates LO in the UPPER FAIL state, and the $\overline{\text{L-FAIL}}$ signal indicates LO in LOWER FAIL state. If the FAIL hold function is enabled, the signals will continue to indicate LO until the function is disabled.

If the hold function is disabled or if the unit returns automatically to READY state, the signal will indicate HI, and the $\overline{\text{READY}}$ signal will indicate LO.

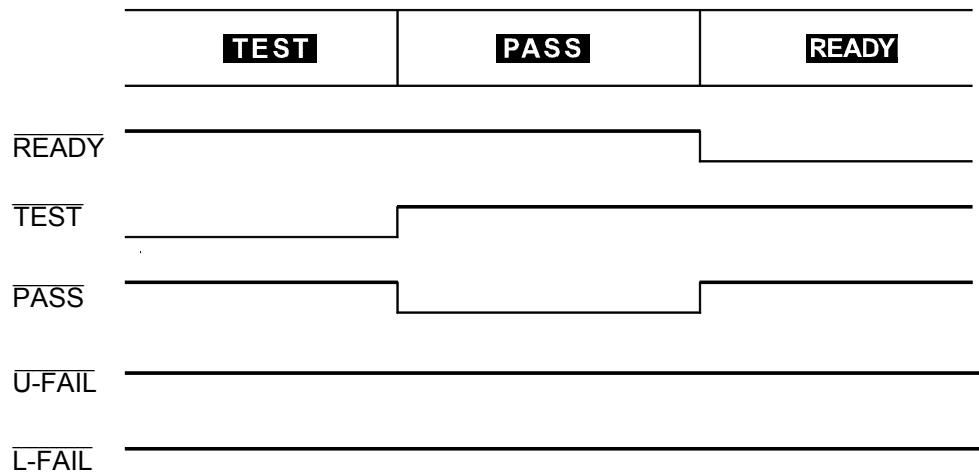

(3) Timing chart when testing is aborted

No test determination is returned if the **STOP** key is pressed to abort testing, or if the testing duration passes without settings for maximum test value or minimum test value. Under these conditions, the unit does not enter PASS or FAIL state, and signals indicate HI. The signal lines also continue to indicate HI as long as this state is held by the hold function.

All signal lines will indicate HI while set values are saved, loaded, or when no state indicator (READY/TEST/FAIL/PASS) lights - as when optional functions are being set.

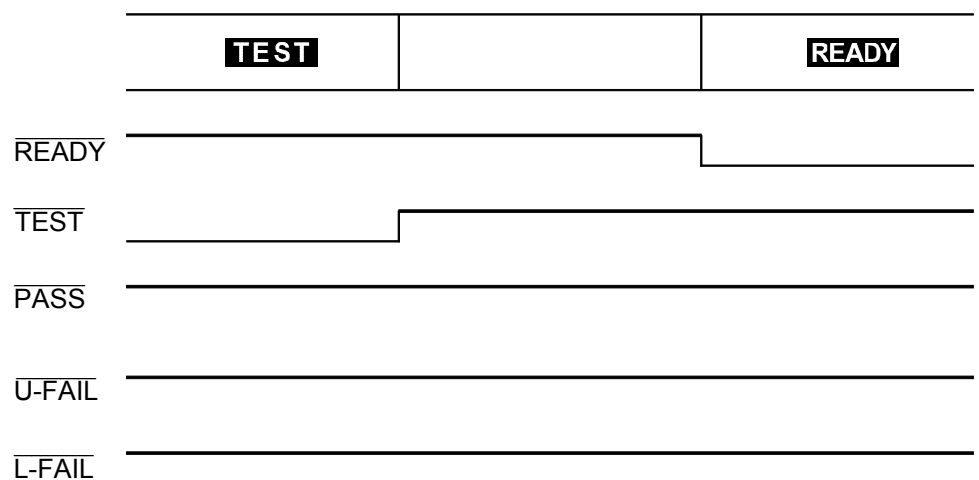

Chapter 7

Maintenance, Inspection and Ultimate Disposal

7.1 Maintenance and Inspection

To ensure the safe operation of this unit, perform maintenance regularly.

- Be sure to read assiduously the various items highlighted in this manual for attention, in order to use the unit correctly.
- If damage is suspected, check the "Troubleshooting" section before contacting your dealer or Hioki representative.
- Pack the product carefully so that it will not be damaged during shipment, and include a detailed written description of the problem. Hioki cannot be responsible for damage that occurs during shipment.
- If the unit has been subject to moisture, or if oil and dust have accumulated in the unit interior, the danger of electrical shock or fires resulting from the deterioration of insulation increases greatly. If the unit is ever subject to excessive moisture, oil, or dust, cease use immediately, and return the unit to us for maintenance.
- Periodic calibration is necessary to verify and maintain accuracy. If calibration becomes necessary, return the unit to us for maintenance.
- Replaceable Parts

Main parts to be replaced periodically, and their life times: (Useful life depends on the operating environment and frequency of use. Operation cannot be guaranteed beyond the following periods.)

Part	Life
Fan Motor	Approx. 70000 hours
Lithium Battery	Approx. 10 years
Start Switch	Approx. 500000 cycles
Stop Switch	Approx. 500000 cycles

- This product uses a lithium battery to back up it's memory. As the battery power is consumed, it's ability to store measurement conditions diminishes. In the event that measurement conditions can no longer be stored, please contact the manufacturer for repair service.
- Spare and replacement parts for this product are guaranteed to be available only until 7 years after manufacture of this model is terminated.

Cleaning

- To clean the product, wipe it gently with a soft cloth moistened with water or mild detergent. Never use solvents such as benzene, alcohol, acetone, ether, ketones, thinners or gasoline, as they can deform and discolor the case.

7.2 Fuse Replacement

⚠ WARNING

- To avoid electric shock, turn off the power switch and disconnect the probe and power cord before replacing the fuse.
 - Replace the fuse only with one of the specified characteristics and voltage and current ratings. Using a non-specified fuse or shorting the fuse holder may cause a life-threatening hazard.
(Fuse type: 250 V T3.15 AL)
-

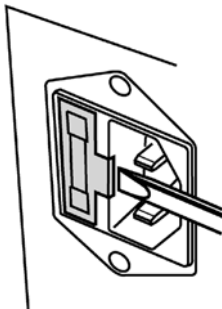

- (1) Turn the power OFF, and disconnect the power cord.
- (2) Using a slot head screwdriver or the like, bias sideways the catch which holds the fuse box into the power inlet socket as shown in the figure, and then remove the fuse box.

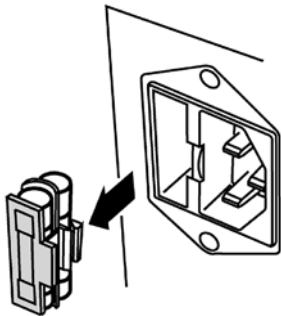

- (3) Replace the fuse with an equivalent replacement.
- (4) Replace the fuse box by reinserting it into the power inlet socket.

7.3 Troubleshooting

If the unit is not functioning properly, check the following items before sending it for repair.

Symptom	What to check	Solution
The screen does not illuminate when the power is turned on.	Is the power cord disconnected?	Connect the power cord.
	Has the fuse blown?	Replace the fuse.
The keys do not operate. ("RMT" lights.)	Is the unit being remotely controlled through the RS-232C or GP-IB interface?	Set RS-232C or GP-IB to local. (The keys do not operate during RS-232C or GP-IB communication.)
	Has the unit been put into the key lock condition?	Clear the key lock condition.

If any of the following should occur, stop using the unit, disconnect the power cord and probe, and contact your dealer or HIOKI representative.

- If you are certain that the unit is damaged.
- If the measurement you wish to perform is inoperative.
- If the unit was stored for a long period of time in high temperatures and humidity, or other undesirable conditions.
- If the unit was damaged in transit.

7.4 Displaying Errors

If an error occurs, the 3157 displays the following on the screen.

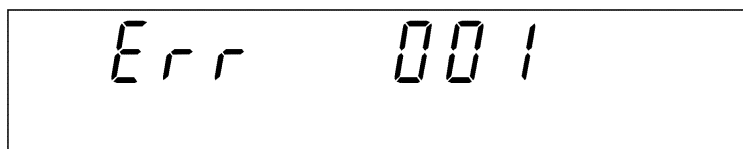

When errors other than the above are displayed, the unit may be malfunctioning. Contact your dealer or Hioki representative.

Err001	Overheat error. The inside of the unit is overheated due to an overload or the like. Leave the unit for several minutes without turning OFF the power switch. If the unit is not restored, it may be malfunctioning. Contact your dealer or Hioki representative.
Err002	Over current error. Turn OFF the main power switch on the unit, After it passed through the enough time (about 10 minutes), and then turn it ON again. (Don't turn ON the power switch without turning OFF the power switch and waiting.) If the unit is not restored, it may be malfunctioning. Contact your sales agent or nearest sales office.
Err003 to Err005	System error has occurred. Turn OFF the main power switch on the unit, and then turn it ON again. (A switch is turned OFF, and you must not turn ON a power switch soon. Turn ON a power switch after you pass about one minute.) If this action fails to reset the system, perform the system reset. (See.7.5, "Resetting the System") If this action also fails to reset the system, the system may be malfunctioning. Contact your sales agent or nearest sales office.

7.5 Resetting the System

Resetting the system

While pressing the **SHIFT** key, press the main power switch to turn on power.

Parameters after resetting the system

When the system is reset, the following parameters are initialized.

(1) Testing set values and saved data

Preset current value	25.0 A
Maximum test value	0.100 Ω (2.5 V)
Minimum test value	OFF (OFF)
Testing time	60.0 s
Minimum test value setting	Inactive
Testing time setting	Active

(2) Optional functions

Switching the output current frequency	0: 50 Hz
PASS/FAIL HOLD function	0: PASS not held, FAIL held
HOLD function	0: Not held
Setting the minimum test value	0: Not set
Endless timer function	0: Not set
Test data count	0: Not set
Setting the buzzer	0: ON at screening, ON at error
Changing currents in TEST state	0: Not changeable
Momentary OUT	0: Not set
Test mode	0: Soft start mode
Setting the printer output	0: Not used

7.6 Ultimate Disposal (Removal of the Lithium Battery)

⚠ WARNING

- To prevent electric shock when removing the lithium battery, always disconnect the power cord and probe.
- When disposing of this product, remove the lithium battery and dispose of battery and product in accordance with local regulations.
- If the protective functions of the unit are damaged, either remove the unit from service or post warnings to prevent others from using the unit inadvertently.

This unit uses a lithium battery as a power source for recording measurement settings. When disposing of this unit, open the unit, remove the lithium battery and dispose of it properly.

Tools necessary for opening the unit:

Phillips screwdriver, College pliers

Procedure

- (1) Turn OFF the power switch, and disconnect the power cord and probe.
- (2) Remove the four feet (fastened with eight screws) at the back of the 3157 and the two screws on the handle on the right side.
- (3) Move the cover backward and remove it.
- (4) The figure indicates the location of the battery holder. Insert a sharp object (e.g. college pliers) between the battery and the battery holder, then remove the battery while lifting it.

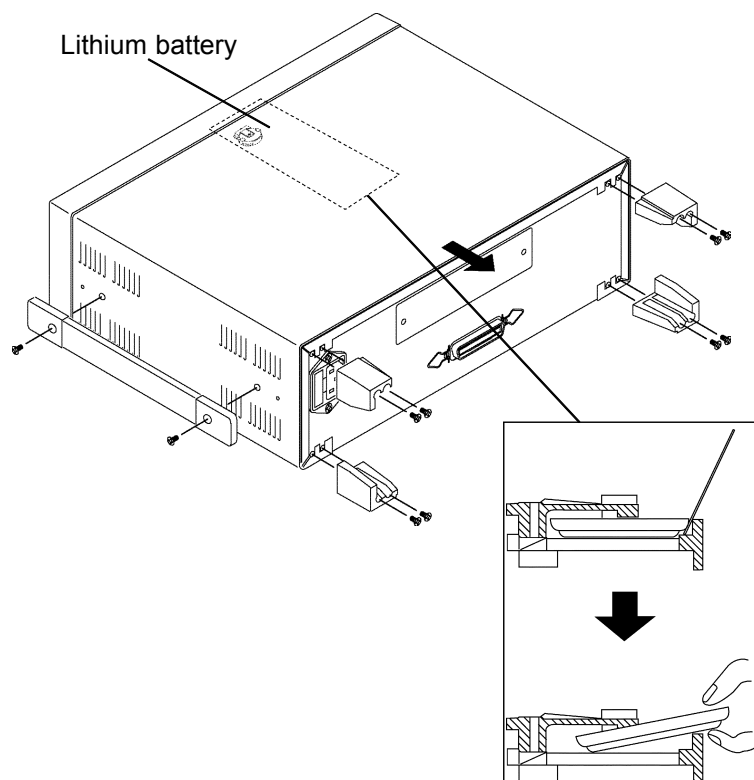

7.7 External Dimensions

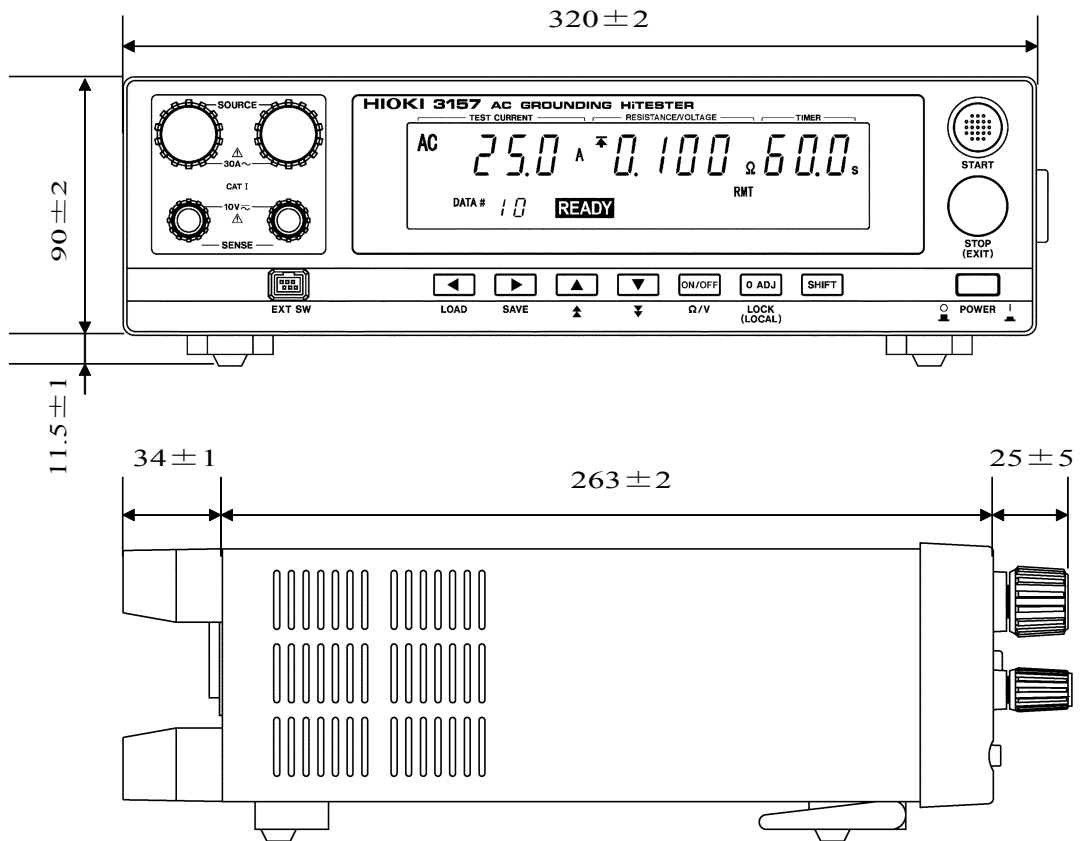

Chapter 8

Specifications

8.1 Basic Specifications

Current generator

Current generating method	PWM constant current control
Current preset range	3.0 A to 31.0 AAC (resolution of 0.1 A) at a resistance of 0.1 Ω .
Current preset accuracy	$\pm(1\%$ of setting + 0.2 A) within maximum output power.
Maximum output power	130 VA (on output terminal) * ¹
Open terminal voltage	6 VAC max.
Generated frequency	50 Hz or 60 Hz sine wave adjustable.
Distortion factor	5% max. (at an output of 5 A or greater).
Soft start function	Increase to the preset current value after checking power supply to load.

Monitor

Measuring method	AC low-resistance measurement with four terminals.
Monitor parameter	Output current and loaded terminal voltage.
Monitor cycle	Twice per second
Current monitoring range	0 A to 35.0 AAC (resolution of 0.1 A).
Current monitoring accuracy	$\pm(1\%$ rdg. + 5 dgt.) at 3 A or greater
Voltage monitoring range	0 V to 6.00 VAC (single range, resolution of 0.01 V).
Voltage monitoring accuracy	$\pm(1\%$ rdg. + 5 dgt.)
Resistance measurement range	0 Ω to 1.800 Ω (resolution of 0.001 Ω).
Resistance measurement accuracy	$\pm(2\%$ rdg. + 4 dgt.) after zero adjustment.

NOTE

The specifications in this manual include figures for "measurement accuracy" when referring to digital measuring instruments, and for "measurement tolerance" when referring to analog instruments.

Timer

ON preset : Displays remaining time by counting down from the preset time

OFF preset : Displays elapsed time

Setting range	0.5 s to 999 s
Setting resolution	0.1 s (0.5 s to 99.9 s), 1 s (100 s to 999 s)
Timer accuracy	± 50 ms (0.5 s to 99.9 s), ± 0.5 s (100 s to 999 s)

Interface

External I/O	Output signal: PASS, UP_FAIL, LOW_FAIL, TEST, READY (open collector) Input signal: START, STOP, External I/O_ENABLE (5 V to 24 VDC)
Front EXT terminal	Inputs external START/STOP signals (contact signal) The unit <input type="button" value="START"/> key is not accepted when the external terminal is used)
RS-232C or GP-IB (May not be used in combination)	Remote function Outputs measurement data. (Key-locked when the RMT lights, accepting only the <input type="button" value="LOCAL"/> , <input type="button" value="STOP"/> and external keys)

Other functions

Maximum/minimum test value screening function	Screening with maximum and minimum test values (PASS/FAIL)
Screening result output	Internal buzzer (ON/OFF enabled in PASS/FAIL state), and I/O output.
Zero adjustment function	Cancels the resistance of the measurement probe.
Zero adjustment range	0 Ω to 0.100 Ω
Saving test parameters	Saves up to twenty values (saving/loading enabled).

*1: Derating is necessary at the operating ambient temperature.

Output characteristics

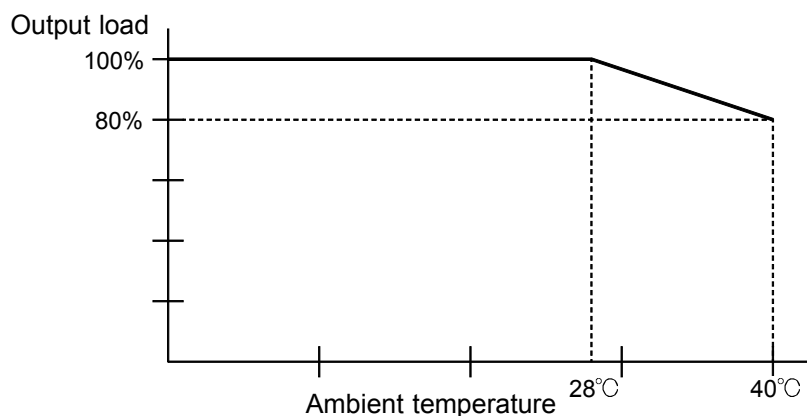

8.2 General Specifications

3157

Display	Fluorescent display tube (digital)
Operating temperature and humidity range	0 to 40°C (32 to 104°F), 90%RH max. (no condensation)
Storage temperature and humidity range	-10 to 50°C (14 to 122°F), 95%RH max. (no condensation)
Operating temperature and humidity for guaranteed accuracy	23 ± 5°C (73 ± 9°F), 90%RH max. (no condensation) (after 30 minutes of warm-up operation)
Period of guaranteed accuracy	1 year
Operating environment	<2000 m ASL (6562 feet)
Backup battery lifetime	Approx. 10 years (at 25°C reference value)
Rated power voltage range	100 to 120 VAC (3157), 100 to 120 VAC/ 200 to 240 VAC (3157-01) (Voltage fluctuations of ±10% from the rated supply voltage are taken into account.)
Rated power frequency	50 to 60 Hz
Dielectric strength	1.39 kVAC, 20 mA, 15 seconds between power supply and frame
Maximum rated power	350 VA (when options are installed)
Dimensions	Approx. 320W × 90H × 263D mm (12.60"W × 3.54"H × 10.35"D) (excluding projections)
Mass	Approx. 7 kg (246.9 oz.)
Fuse	250 V T3.15 AL
Accessories	Grounded three-core power cord, instruction manual, spare fuse (built into the power inlet), short bar (installed between the SOURCE and SENSE terminals) × 2
Options	9296 CURRENT PROBE (with alligator clip) 9297 CURRENT APPLY PROBE 9613 REMOTE CONTROL BOX (SINGLE) 9614 REMOTE CONTROL BOX (DUAL) 9518-02 GP-IB INTERFACE 9593-02 RS-232C INTERFACE 9267 SAFETY TEST DATA MANAGEMENT SOFTWARE (RS-232C is used) 9442 PRINTER 1196 RECORDING PAPER (25 m, 10 rolls) 9443 AC ADAPTER (for printer) 9446 CONNECTION CABLE (for printer)
Standards applying	EMC EN61326:1997+A1:1998+A2:2001+A3:2003 Class A EN61000-3-2: 2000 EN61000-3-3: 1995+A1: 2001 Safety EN61010-1: 2001 Pollution Degree 2

9296 CURRENT PROBE

Rated voltage	30 VAC or 60 VDC
Rated current	30 AAC or 30 ADC
Dielectric strength	400 VAC, 1 mA, 1 minute
Test point	Between current and voltage, and coated cable
Operating temperature and humidity range	0 to 40°C (32 to 104°F), 90%RH max. (no condensation)
Storage temperature and humidity range	-10 to 50°C (14 to 122°F), 95%RH max. (no condensation)
Operating environment	<2000 m ASL (6562 feet)
Dimension	Approx. 1450 mm ("57.09)
Mass	Approx. 180 g (6.3 oz.)
Standards applying	EN61010-031: 2002 Pollution Degree 2, Measurement Category I (anticipated transient overvoltage 330 V)

9297 CURRENT APPLY PROBE

Rated voltage	30 VAC or 60 VDC
Rated current	40 AAC or 40 ADC
Trigger switch	Outputs contact signals. START/STOP operations
Dielectric strength	400 VAC, 1 mA, 1 minute
Test point	Between current and voltage, and exterior and coated cable
Operating temperature and humidity range	0 to 40°C (32 to 104°F), 90%RH max. (no condensation)
Storage temperature and humidity range	-10 to 50°C (14 to 122°F), 95%RH max. (no condensation)
Operating environment	<2000 m ASL (6562 feet)
Dimension	Approx. 1480 mm ("58.27)
Mass	Approx. 200 g (7 oz.)
Standards applying	EN61010-031: 2002 Pollution Degree 2, Measurement Category I (anticipated transient overvoltage 330 V)

Appendix

Appendix 1 Options

Appendix 1.1 9442 PRINTER

Using with the optional 9593-02 RS-232C INTERFACE, 9442 PRINTER, and 9446 CONNECTION CABLE, the test values can be printed out.

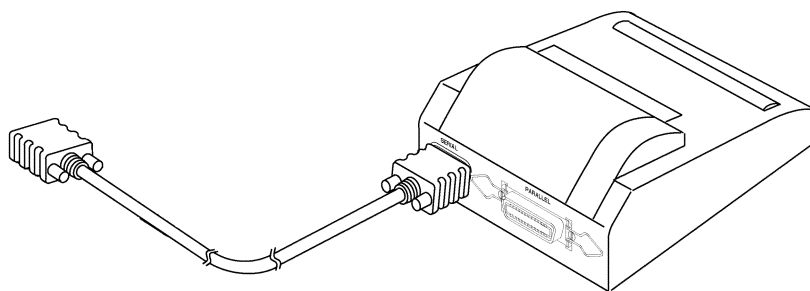

Use the 9442 PRINTER, the 9443* AC ADAPTER, and the 1196 RECORDING PAPER. To connect the main unit and printer, use the 9593-02 RS-232C INTERFACE and the 9446 CONNECTION CABLE. (All are options.)

9442	DPU-414	Seiko Instruments Inc.
*9443-01	PW-4007-J1	Seiko Instruments Inc. (for Japan)
*9443-02	PW-4007-E1	Seiko Instruments Inc. (for EU)
*9443-03	PW-4007-U1	Seiko Instruments Inc. (for U.S.A.)

NOTE

- The 9442 is shipped with the function settings for use with the HIOKI 3166 CLAMP ON POWER HiTESTER. Before using, always change the settings of the DIP switches.
- For details on connection of the printer and the 9593-02 RS-232C INTERFACE, refer to the instruction manual for the 9593-02.
- For details on the operations and handling of the printer, refer to the operation manual supplied to the printer. For the printer, use the 1196 RECORDING PAPER or an equivalent.

Appendix 1.2 Probe

The 9296 CURRENT PROBE (with alligator clip) and 9297 CURRENT APPLY PROBE are available.

Use two sets of the 9296 or a single combined set of 9296 and 9297.

An external switch can be used for the 9297 CURRENT APPLY PROBE.

9296 CURRENT PROBE

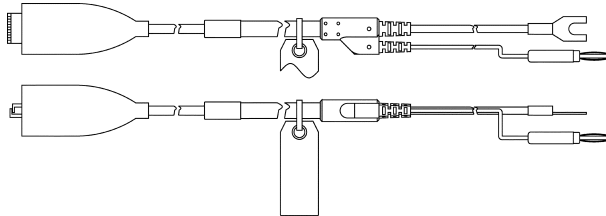

9297 CURRENT APPLY PROBE

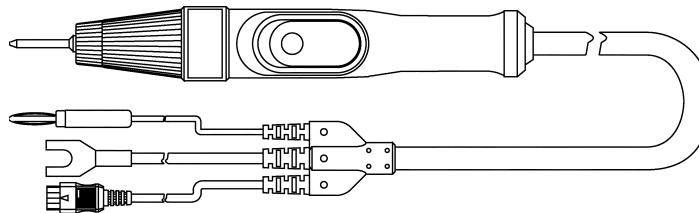

Appendix 1.3 9613 REMOTE CONTROL BOX (SINGLE)

Two types of remote-control boxes are available: the 9613 for use with a single hand and the 9614 for use with both hands. The 9613 REMOTE CONTROL BOX (SINGLE) is equipped with a START key, a STOP key, and an OPERATE switch, which turns ON/OFF the remote-control box. The STOP key remains lit as long as a voltage is being output.

Operating temperature and humidity range	0 to 40°C (32 to 104°F), 80%RH max. (no condensation)
Storage temperature and humidity range	-10 to 50°C (14 to 122°F), 90%RH max. (no condensation)
Operating environment	<2000 m ASL (6562 feet)
Dimensions	Approx. 193W×50H×30D mm (7.60"W×1.97"H×1.18"D) (excluding projections)
Mass	Approx. 500 g (17.6 oz.)
Cord length	Approx. 1500 mm ("59.06)

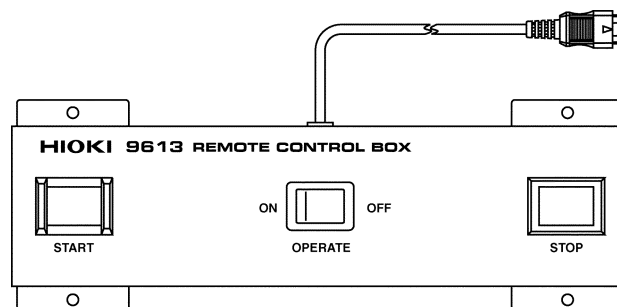

Appendix 1.4 9614 REMOTE CONTROL BOX (DUAL)

Unlike the 9613, the 9614 REMOTE CONTROL BOX (DUAL) has two START keys. Pressing both keys is equivalent to pressing the START key on the unit. By using the Momentary-OUT function in Optional Functions, the 9614 allows the control box to be used with both hands, thus ensuring safer testing.

Operating temperature and humidity range	0 to 40°C (32 to 104°F), 80%RH max. (no condensation)
Storage temperature and humidity range	-10 to 50°C (14 to 122°F), 90%RH max. (no condensation)
Operating environment	<2000 m ASL (6562 feet)
Dimensions	Approx. 270W × 50H × 30D mm (10.63"W × 1.97"H × 1.18"D) (excluding projections)
Mass	Approx. 700 g (24.7 oz.)
Cord length	Approx. 1500 mm (59.06")

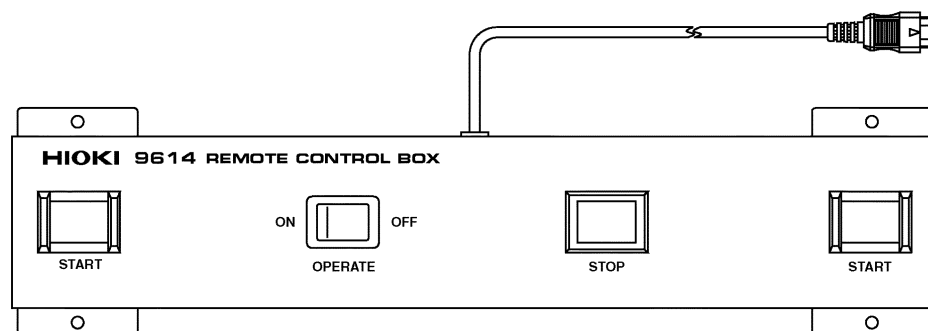

Appendix 1.5 Interface Board

The unit can be remotely controlled through the 9518-02 GP-IB INTERFACE or the 9593-02 RS-232C INTERFACE.

For information on installation, use, and various commands, please refer to the specific instruction manual for each interface.

9518-02 GP-IB INTERFACE

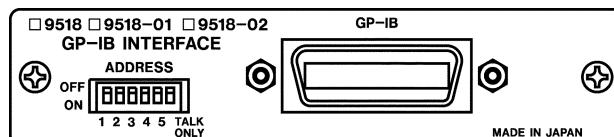

9593-02 RS-232C INTERFACE

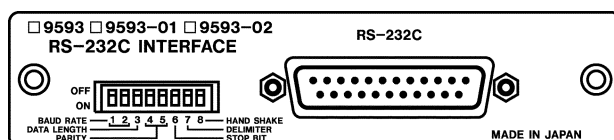

Appendix 2 Table of Optional Functions

The following shows the optional functions.

For more information on settings, see Chapter 4, "Optional Functions."

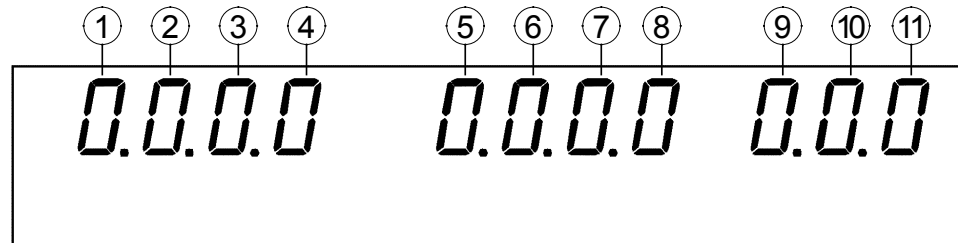

Optional function	Selection
(1) Switching the output current frequency	0: 50 Hz 1: 60 Hz
(2) PASS/FAIL hold function	0: PASS not held, FAIL held 1: PASS held, FAIL held 2: PASS not held, FAIL not held 3: PASS held, FAIL not held
(3) Hold function	0: Not held 1: Held
(4) Setting minimum test value	0: Not set 1: Set
(5) Endless timer function	0: Not set 1: Set
(6) Test data count function	0: Not set 1: Set
(7) Buzzer setting	0: ON at screening, ON at error 1: OFF at screening, OFF at error 2: OFF at screening, ON at error 3: ON at screening, OFF at error
(8) Changing the current value in TEST state	0: Not changeable 1: Changeable
(9) Momentary OUT	0: Not set (Trigger operation) 1: Set (Momentary OUT operation)
(10) Test mode	0: Soft start mode 1: Normal mode 2: Continuous test mode
(11) Printer output	0: Not used 1: Automatically print for PASS/FAIL screening. 2: Print selectively when the PASS/FAIL state is held.

Appendix 3 Standards

Information current as of June 2005. Provided for reference.

For more details, please refer to the latest version of the standards.

Specifications for this product do not necessarily meet all the required standards.

Use this product after confirming its measurement range.

(See Section 3.7, "Starting a Test")

Medical electrical equipment - Part1: General requirements for safety (IEC60601-1(1988-12)+am1(1991-11)+am2(1995-03))

Test current: A current of 25 A or 1.5 times the rated current of the EQUIPMENT, whichever is greater ($\pm 10\%$), from current source with a frequency of 50 Hz or 60 Hz with a no-load voltage not exceeding 6 V

Test time: 5 s to 10 s

Test point: Through the PROTECTIVE EARTH TERMINAL or the protective earth contact in the APPLIANCE INLET or the protective earth pin in the MAINS PLUG and each ACCESSIBLE METAL PART which could become LIVE in case of failure in BASIC INSULATION

Allowable range: The voltage drop between the parts described is measured and the impedance determined from the current and voltage drop.

- For EQUIPMENT without a POWER SUPPLY CORD the impedance between the PROTECTIVE EARTH TERMINAL and any ACCESSIBLE METAL PART which is PROTECTIVELY EARTHED shall not exceed 0.1 Ω .
- For EQUIPMENT with an APPLIANCE INLET the impedance between the protective contact in the APPLIANCE INLET and any ACCESSIBLE METAL PART which is PROTECTIVELY EARTHED shall not exceed 0.1 Ω .
- For EQUIPMENT with a non-detachable POWER SUPPLY CORD the impedance between the protective contact in the MAINS PLUG and any ACCESSIBLE METAL PART which is PROTECTIVELY EARTHED shall not exceed 0.2 Ω .

Audio, video and similar electronic apparatus - Safety requirements(IEC60065(2001-12))

Type tests: "15.2 Provisions for protective earthing"

Test current: 25 A a.c. or d.c.; the test voltage shall not exceed 12 V.

Test time: 1 min

Test point: Between the protective earth terminal or contact and the part to be connected thereto

Allowable range: The resistance shall not exceed 0.1 Ω

The voltage drop shall be measured and the resistance is calculated from the current and this voltage drop.

The resistance of the protective earthing conductor of the power supply cord shall not be included in the resistance measurement.

*In Canada, a 30 A test current is used.

Care should be taken that the contact resistance between the tip of the measurement probe and the metal part under test does not influence the test result.

ROUTINE TEST omitted

Household and similar electrical appliances - Safety - Part1: General requirements(IEC60335-1(2001-05)+am1(2004-03))

Type test: "27. Provision for earthing"

Test current: A current derived from a source having a no-load voltage not exceeding 12 V(a.c. or d.c.) and equal to 1.5 times rated current of the appliance or 25 A, whichever is higher.

Test time: In case of doubt, the test is carried out until steady conditions have been established.

Test point: Between the earthing terminal or earthing contact and each of the accessible metal parts

Allowable range: The voltage drop is measured.

The resistance calculated from the current and this voltage drop shall not exceed 0.1 Ω .

The resistance of the supply cord is not included in the measurement.

Care is to be taken to ensure that the contact resistance between the tip of the measuring probe and the metal part under test does not influence the test results.

Annex A(informative)

Routine tests

A.1 Earth continuity test

Test current: A current of at least 10 A, derived from a source having a no-load voltage not exceeding 12 V(a.c. or d.c.)

Test point: Between each of the accessible earthed metal parts and

- for class 0 I appliances, and for class I appliances intended to be permanently connected to fixed wiring, the earthing terminal;
- for other class I appliances,
 - the earthing pin or earthing contact of the plug;
 - the earthing pin of the appliance inlet.

Test time: The test is only carried out for the duration necessary to enable the voltage drop to be measured.

Allowable range: The voltage drop is measured and the resistance is calculated and shall not exceed

- for appliances having a supply cord, 0.2 Ω , or 0.1 Ω plus the resistance of the supply cord,
- for other appliances, 0.1 Ω .

Care is to be taken to ensure that the contact resistance between the tip of the measuring probe and the metal part under test does not influence the test results.

Information technology equipment - Safety - Part1: General requirements(IEC60950-1(2001-10))

Type tests: "2.6.3.4 Resistance of earthing conductors and their terminations"

If the current rating of the circuit under test is 16 A or less

Test current: 1.5 times the current rating of the circuit under test

Test time: 60 s

Test point: Between the main protective earthing terminal and the point in the equipment that is required by 2.6.1 to be earthed

Allowable range: The resistance of the PROTECTIVE BONDING CONDUCTOR, calculated from the voltage drop, shall not exceed 0.1 Ω

If the current rating of the circuit under test exceeds 16 A

- for a.c. powered equipment

Test current: Two times the current rating of the circuit under test

Test time: 2 min

Test point: Between the main protective earthing terminal and the point in the equipment that is required by 2.6.1 to be earthed

Allowable range: The voltage drop across the PROTECTIVE BONDING CONDUCTOR shall not exceed 2.5 V

- for d.c. powered equipment

Test current: Specified by the manufacturer

Test time: Specified by the manufacturer

Test point: Between the main protective earthing terminal and the point in the equipment that is required by 2.6.1 to be earthed

Allowable range: The voltage drop across the PROTECTIVE BONDING CONDUCTOR shall not exceed 2.5 V

The test current can be either a.c. or d.c. and the test voltage shall not exceed 12V.

The resistance of the PROTECTIVE EARTHING CONDUCTOR is not included in the measurement. However, if the PROTECTIVE EARTHING CONDUCTOR is supplied with the equipment, it is permitted to include the conductor in the test circuit but the measurement of the voltage drop is made only from the main protective earthing terminal to the part required to be earthed.

Care is taken that the contact resistance between the tip of the measuring probe and the conductive part under test does not influence the test results.

Information technology equipment - Safety - Part1: General requirements(UL60950-1(2003-04))

Type tests "2.6.3.4 Resistance of earthing conductors and their terminations"

If the current rating of the circuit under test is 16 A or less

Test current: Two times the current rating of the circuit under test

Test time: 120 s

Test point: Between the main protective earthing terminal and the point in the equipment that is required by 2.6.1 to be earthed

Allowable range: The resistance of the PROTECTIVE BONDING CONDUCTOR, calculated from the voltage drop, shall not exceed 0.1 Ω

If the current rating of the circuit under test exceeds 16 A

- for a.c. powered equipment

Test current: Two times the current rating of the circuit under test up to a maximum test current of 500 A

Test time: The time durations noted below

Current rating of circuit, A	Time, minutes
≤ 30	2
$>30 \leq 60$	4
$>60 \leq 100$	6
$>100 \leq 200$	8
>200	10

Test point: Between the main protective earthing terminal and the point in the equipment that is required by 2.6.1 to be earthed

Allowable range: The voltage drop across the PROTECTIVE BONDING CONDUCTOR shall not exceed 2.5 V

- for d.c. powered equipment

Test current: Specified by the manufacturer

Test time: Specified by the manufacturer

Test point: Between the main protective earthing terminal and the point in the equipment that is required by 2.6.1 to be earthed

Allowable range: The voltage drop across the PROTECTIVE BONDING CONDUCTOR shall not exceed 2.5 V

The test current can be either a.c. or d.c. and the test voltage shall not exceed 12 V.

The resistance of the PROTECTIVE EARTHING CONDUCTOR is not included in the measurement. However, if the PROTECTIVE EARTHING CONDUCTOR is supplied with the equipment, it is permitted to include the conductor in the test circuit but the measurement of the voltage drop is made only from the main protective earthing terminal to the part required to be earthed.

Care is taken that the contact resistance between the tip of the measuring probe and the conductive part under test does not influence the test results.

* Annex NAE "2.6.3.3 Size of protective bonding conductors"

For PLUGGABLE EQUIPMENT TYPE A, and if neither a) or b) is applicable, the current rating of the circuit shall be taken as 20 A since the Pluggable Equipment Type A configurations described in 1.2.5.1 are protected by maximum 20 ampere branch circuit overcurrent protection.

Safety requirements for electrical equipment for measurement, control, and laboratory use - Part 1: General requirements (IEC61010-1(2001-02), UL61010-1(2004-07))

Type tests: "6.5.1.3 Impedance of PROTECTIVE BONDING of plug-connected equipment", "6.5.1.4 Bonding impedance of PERMANENTLY CONNECTED EQUIPMENT"

PLUG-CONNECTED EQUIPMENT

Test current: The test current is the greater of:

- 25 A d.c. or a.c. r.m.s. at RATED mains frequency;
- a current equal to twice the RATED current of the equipment.

Test time: 1 min

Test point: Between the PROTECTIVE CONDUCTOR TERMINAL and each ACCESSIBLE part for which PROTECTIVE BONDING is specified.

Allowable range: Not exceeding 0.1 Ω

Calculating impedance. The impedance shall not exceed 0.1 Ω .

MAINS cord impedance does not form part of the specified bonding impedance.

PERMANENTLY CONNECTED EQUIPMENT

Test current: A test current of twice the value of the overcurrent protection means specified in the equipment installation instructions for the building supply MAINS CIRCUIT

Test time: 1 min

Test point: Between the PROTECTIVE CONDUCTOR TERMINAL and each ACCESSIBLE conductive part for which PROTECTIVE BONDING is required.

Allowable range: It shall be of low impedance.

The voltage between them shall not exceed 10 V a.c. r.m.s. or d.c.

ROUTINE TESTS: "Annex F (normative) ROOUTINE TESTS"

The manufacturer shall perform the tests of F.1 to F.3 on 100% of equipment produced which has both HAZARDOUS LIVE parts and ACCESSIBLE conductive parts.

F.1 Protective earth

Test current: No value is specified for the test current.

Test time: No description

Test point: Between the earth pin of the appliance inlet or the MAINS plug of plug-connected equipment, or the PROTECTIVE CONDUCTOR TERMINAL of PERMANENTLY CONNECTED EQUIPMENT on the one side, and all ACCESSIBLE conductive parts which are required by 6.5.1 to be connected to the PROTECTIVE CONDUCTOR TEMINAL on the other side.

Allowable range: No description

Safety of machinery - Electrical equipment of machines - Part1: General requirements(IEC60204-1(1997-10)+am1(1999-04))**"19.2 Continuity of the protective bonding circuit"**

When the machine is installed and the electrical connections are complete, including those to the power supply, the continuity of the protective bonding circuit can be verified by a loop impedance test in accordance with 612.6.3 of the IEC60364-6-61. For small machines, pre-manufactured machines or parts of machines with protective bonding loops not exceeding approximately 30 m, and where the machine cannot be connected to the power supply for the loop impedance test, the following method may be appropriate.

Test current: A current of at least 10 A at 50 Hz or 60 Hz derived from a PELV source

Test time: No description

Test point: Between the PE terminal and relevant points that are part of the protective bonding circuit

Allowable range: Not to exceed the next values

Minimum effective protective conductor Cross-sectional area of the branch (mm) ²	Maximum measured voltage drop (values are given for a test current of the 10 A) (V)
1.0	3.3
1.5	2.6
2.5	1.9
4.0	1.4
>6.0	1.0

Information current as of June 2005. Provided for reference.

For more details, please refer to the latest version of the standards.

Specifications for this product do not necessarily meet all the required standards.

Use this product after confirming its measurement range.

(See Section 3.7, "Starting a Test")

Index

- A -

Alligator clip 6

- B -

Banana-type voltage measurement plug 6,11

Buzzer 18,24,36,45,84,APPENDIX4

- C -

Continuous test mode 37,53,56,APPENDIX4

Current application probe 15,29

Current output plug 6,11

Current output terminal 3,11,12

Current probe 14

- D -

Derating 88

- E -

Endless timer
..... 18,24,36,43,66,70,84,APPENDIX4

Error 83

External dimensions 86

External I/O terminal 5,26,73

External switch 7,30,47

External switch terminal 3,11

- F -

FAIL hold function 39,41

FAIL state 19,34

File number 65,66,69

Flashing cursor 4,20,35

Forcible ending 30

Four-terminal measurement 3

Fuse 82,83

- H -

Hold function 18,24,36,40,84,APPENDIX4

- I -

Initial settings 24

Interface 5,10,88,APPENDIX3

- K -

Key-lock function 18,26

- L -

Lithium battery 85

Load 70

- M -

Maximum number of test data	44
Maximum test value	21,66,70,84
Maximum value icon	32-34,65,69
Measured current value	32-34
Measured resistance value	32-34
Measured voltage value	32-34
Measurement with two terminals	12
Minimum test value	18,22,24,36,42,66,70,84,APPENDIX4
Minimum value icon	32-34,65,69
Momentary OUT	18,24,37,47,50,84,APPENDIX4

- N -

Normal mode	37,53,55,APPENDIX4
-------------------	--------------------

- O -

OPERATE switch	7
Optional functions	18,24,60,62,84,APPENDIX4
Output characteristics	88
Output current frequency	23
Output current value	18-21,46

- P -

PASS hold function	39,41
PASS state	19,33
Power cord	9
Printer	58,APPENDIX1
Printer output	18,24,41,58,84,APPENDIX4
Priority for control of the START key	7,30,47
Probe	11,12,15,25,29,30,53-56,APPENDIX2
Push switch	6,11,48-52

- R -

READY state	4,18,20
REMOTE state	26
Resistance indicator	4,21

- S -

Save	66
Short bar	12
Soft start mode	24,37,53,84,APPENDIX4
Stand	3,14
Stand-by state	29,53,56
Switch signal line plug	6,7,11

- T -

Test data count	18,23,24,36,44,84,APPENDIX4
Test mode	18,24,37,53,84,APPENDIX4
TEST state	19,32
Testing time	18,22,84
Testing time elapsed	32
Timing chart	78
Trigger operation	48

- V -

Voltage indicator	4,21
Voltage measurement terminal	3,11,12

- Z -

Zero adjustment function	25
--------------------------------	----

- Others -

9296	6,11,15,APPENDIX2
9297	6,11,15,APPENDIX2
9442	58,APPENDIX1
9518-02	5,APPENDIX3
9593-02	5,58,APPENDIX3
9613	7,13,APPENDIX2
9614	7,13,APPENDIX3

HIOKI

DECLARATION OF CONFORMITY

Manufacturer's Name: HIOKI E.E. CORPORATION
Manufacturer's Address: 81 Koizumi, Ueda, Nagano 386-1192, Japan

Product Name: AC GROUNDING HiTESTER
Model Number: 3157-01
Options: 9296 CURRENT PROBE
9297 CURRENT APPLY PROBE
9518-02 GP-IB INTERFACE
9593-02 RS-232C INTERFACE
9613 REMOTE CONTROL BOX (SINGLE)
9614 REMOTE CONTROL BOX (DUAL)

The above mentioned products conform to the following product specifications:

Safety: EN61010-1:2001
EMC: EN61326:1997+A1:1998+A2:2001+A3:2003
Class A equipment
Minimum immunity test requirement
EN61000-3-2:2000
EN61000-3-3:1995+A1:2001

Supplementary Information:

The products herewith comply with the requirements of the Low Voltage Directive 73/23/EEC and the EMC Directive 89/336/EEC.

HIOKI E.E. CORPORATION

15 September 2006

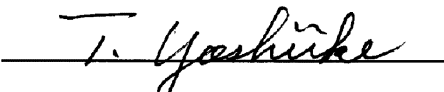
Tatsuyoshi Yoshiike
President

3157A999-04

HIOKI 3157/3157-01 AC GROUNDING HiTESTER

Instruction Manual

Publication date: September 2006 Revised edition 8

Edited and published by HIOKI E.E. CORPORATION
Technical Support Section

All inquiries to International Sales and Marketing Department

81 Koizumi, Ueda, Nagano, 386-1192, Japan

TEL: +81-268-28-0562 / FAX: +81-268-28-0568

E-mail: os-com@hioki.co.jp

URL <http://www.hioki.co.jp/>

Printed in Japan 3157A981-08

-
-
- All reasonable care has been taken in the production of this manual, but if you find any points which are unclear or in error, please contact your supplier or the International Sales and Marketing Department at HIOKI headquarters.
 - In the interests of product development, the contents of this manual are subject to revision without prior notice.
 - Unauthorized reproduction or copying of this manual is prohibited.
-
-

HIOKI

HIOKI E. E. CORPORATION

HEAD OFFICE

81 Koizumi, Ueda, Nagano 386-1192, Japan
TEL +81-268-28-0562 / FAX +81-268-28-0568
E-mail: os-com@hioki.co.jp / URL <http://www.hioki.co.jp/>

HIOKI USA CORPORATION

6 Corporate Drive, Cranbury, NJ 08512, USA
TEL +1-609-409-9109 / FAX +1-609-409-9108

3157A981-08 06-09H



Printed on recycled paper
