

INSTRUCTION MANUAL

3159

INSULATION/ WITHSTANDING HiTESTER

HIOKI E. E. CORPORATION

Contents

Introduction	i
Inspection	i
Safety Notes	ii
Notes on Use	v
Chapter Summary	vi
Chapter 1 Overview	1
1.1 Product Introduction	2
1.2 Names and Functions of Parts	3
1.2.1 Front panel	3
1.2.2 Rubber keys	4
1.2.3 Rear panel	5
1.2.4 9615 H.V. TEST LEAD	6
1.2.5 REMOTE CONTROL BOX	7
1.3 External Dimensions	8
Chapter 2 Testing Arrangements	9
2.1 Connecting the Protective Ground Terminal	10
2.2 Connecting the External I/O Connector	11
2.3 Power Cord Connection	12
2.4 Powering On and Off the Unit	13
2.5 Connecting the 9615 H.V. TEST LEAD	14
2.6 Connecting the REMOTE CONTROL BOX	15
2.7 Installation of the Unit	16
2.8 Connection to the Measured Equipment	17
2.9 Startup Inspection	18
Chapter 3 Withstand Voltage Mode Testing Method	19
3.1 Withstand Voltage Mode Display	20
3.2 Displaying the READY State	22
3.2.1 Key-lock Function	23
3.3 "SETTING" State	24
3.3.1 Setting the Comparative Voltage Value	25
3.3.2 Setting the Upper (Lower) Limit Value	26
3.3.3 Setting the Test Time	27
3.3.4 Setting the Output Voltage range	28
3.3.5 Examples of Settings	29

3.4	Starting a Test	32
3.4.1	Setting the Output Voltage	33
3.4.2	Executing a Test	34
3.4.3	Screening in "TEST" State	36
3.5	PASS or FAIL Determination	37
3.5.1	"PASS" State	37
3.5.2	Screening in "PASS" State	39
3.5.3	"FAIL" State	40
3.5.4	Screening in "FAIL" State	44

Chapter 4 Insulation Resistance Mode Testing

	Method	45
4.1	Insulation Resistance Mode Display	46
4.2	Displaying the READY State	48
4.2.1	Key-lock Function	49
4.3	"SETTING" State	50
4.3.1	Setting the Test Voltage Value	51
4.3.2	Setting the Lower (Upper) Limit Value	52
4.3.3	Setting the Test Time	54
4.3.4	Examples of Settings	55
4.4	Starting a Test	58
4.4.1	Executing a Test	58
4.4.2	Screening in "TEST" State	59
4.5	PASS or FAIL Determination	60
4.5.1	"PASS" State	60
4.5.2	Screening in "PASS" State	62
4.5.3	"FAIL" State	63
4.5.4	Screening in "FAIL" State	65
4.6	About the Auto Discharge Function	66

Chapter 5 Auto Test Mode Testing Method

5.1	Withstand Voltage Mode Display	68
5.2	Displaying the READY State	70
5.2.1	Key-lock Function	71
5.3	"SETTING" State	72
5.4	Starting a Test	73
5.4.1	Executing a Test	74
5.4.2	Screening in "TEST State"	75

5.5	PASS or FAIL Determination	76
5.5.1	"PASS" State	76
5.5.2	Screening in "PASS" State	78
5.5.3	"FAIL" State	79
5.5.4	Screening in "FAIL" State	81
5.6	Auto Discharge Function for insulation resistance Tests	82
Chapter 6 Optional Functions		83
6.1	PASS Hold Function	85
6.2	FAIL Hold Function	86
6.3	Hold Function	87
6.4	Momentary Out	89
6.5	Double Action	90
6.6	FAIL Mode	91
6.7	RS Command [START]	92
6.8	Inter-lock Function	93
6.9	Voltage Comparator Position	94
6.10	Insulation Resistance Test Measurement Range ..	95
6.11	Insulation Resistance Test Termination Mode Settings	96
6.12	Example of Optional Functions Use	98
Chapter 7 Saving/loading Preset Values		99
7.1	Saving Preset Values	99
7.1.1	Procedure for Saving Data	99
7.1.2	Example of Saving	102
7.2	Loading Preset Values	104
7.2.1	Procedure for Loading Data	104
7.2.2	Example of Loading	106
Chapter 8 External Interface		109
8.1	External I/O Terminal	109
8.1.1	Signal Line	110
8.1.2	Example of Input Signal Connection	112
8.1.3	Example of Output Signal Connection	113
8.1.4	Inter-lock Function	115
8.1.5	Timing Chart of External I/O Terminal	117
8.2	Status Out	122
8.3	Buzzer	124

Chapter 9 RS-232C Interface	125
9.1 Specifications	125
9.2 Connection Method	126
9.3 Command Transfer Methods	127
9.4 Command	129
9.4.1 Common Command Messages	130
9.4.2 Specific Command Messages	131
9.5 Response Formats	152
Chapter 10 Specifications	155
10.1 Basic Specifications	155
10.1.1 Withstand Voltage test portion	155
10.1.2 Insulation resistance test portion	157
10.1.3 Timer Section	157
10.1.4 Interface	158
10.2 General Specifications	160
Chapter 11 Maintenance and Inspection	161
11.1 Maintenance and Service	162
11.2 Fuse Replacement	163
11.3 Troubleshooting	164
11.4 Displaying Errors	165
11.5 Resetting the System	166
Appendix	APPENDIX 1
Appendix 1 9613 REMOTE CONTROL BOX (SINGLE)	APPENDIX 1
Appendix 2 9614 REMOTE CONTROL BOX (DUAL)	APPENDIX 2
Appendix 3 9615 H.V. TEST LEAD (Standard Accessory)	APPENDIX 3

Introduction

Thank you for purchasing the HIOKI 3159 INSULATION/WITHSTANDING HiTESTER. To obtain maximum performance from the product, please read this manual first, and keep it handy for future reference.

Inspection

When you receive the product, inspect it carefully to ensure that no damage occurred during shipping. In particular, check the connectors. If damage is evident, or if it fails to operate according to the specifications, contact your dealer or Hioki representative.

Accessories

Verify that the following standard accessories are complete.

Instruction Manual	1
Spare fuse (built into the power inlet)	1
Grounded three-core power cord	1
9615 H.V. TEST LEAD (High voltage and return side)	2

Shipment of the unit

Use the original packing materials when reshipping the product, if possible.

Warranty

HIOKI cannot be responsible for losses caused either directly or indirectly by the use of the 3159 with other equipment, or if ownership is transferred to a third party.

NOTE

Before using the product, make sure that the insulation on the leads is undamaged and that no bare conductors are improperly exposed. Using the product in such conditions could cause an electric shock, so contact your dealer or Hioki representative for repair.



Safety Notes



This product is designed to conform to IEC 61010 Safety Standards, and has been thoroughly tested for safety prior to shipment. However, mishandling during use could result in injury or death, as well as damage to the product. Be certain that you understand the instructions and precautions in the manual before use. We disclaim any responsibility for accidents or injuries not resulting directly from product defects.

This manual contains information and warnings essential for safe operation of the product and for maintaining it in safe operating condition. Before using the product, be sure to carefully read the following safety notes.

Safety Symbols

	<ul style="list-style-type: none"> The  symbol printed on the product indicates that the user should refer to a corresponding topic in the manual (marked with the  symbol) before using the relevant function. In the manual, the  symbol indicates particularly important information that the user should read before using the product.
	Indicates that dangerous voltage may be present at this terminal.
	Indicates a fuse.
	Indicates AC (Alternating Current).
	Indicates DC (Direct Current).
	Indicates a protective conductor terminal.
	Indicates a grounding terminal.
	Indicates the ON side of the power switch.
	Indicates the OFF side of the power switch.

The following symbols in this manual indicate the relative importance of cautions and warnings.

	Indicates that incorrect operation presents an extreme hazard that could result in serious injury or death to the user.
	Indicates that incorrect operation presents a significant hazard that could result in serious injury or death to the user.
	Indicates that incorrect operation presents a possibility of injury to the user or damage to the product.
	Advisory items related to performance or correct operation of the product.

Overvoltage Categories

This product conforms to the safety requirements for CAT II measurement products.

To ensure safe operation of measurement products, IEC 60664 establishes safety standards for various electrical environments, categorized as CAT I to CAT IV, and called overvoltage categories. These are defined as follows.

CAT I	Secondary electrical circuits connected to an AC electrical outlet through a transformer or similar device.
CAT II	Primary electrical circuits in equipment connected to an AC electrical outlet by a power cord (portable tools, household appliances, etc.)
CAT III	Primary electrical circuits of heavy equipment (fixed installations) connected directly to the distribution panel, and feeders from the distribution panel to outlets.
CAT IV	The circuit from the service drop to the service entrance, and to the power meter and primary overcurrent protection device (distribution panel).

Higher-numbered categories correspond to electrical environments with greater momentary energy, so a measurement product designed for CAT III environments can endure greater momentary energy than one designed for CAT II. Using a measurement product in an environment designated with a higher-numbered category than that for which the product is rated could result in a severe accident, and must be carefully avoided.

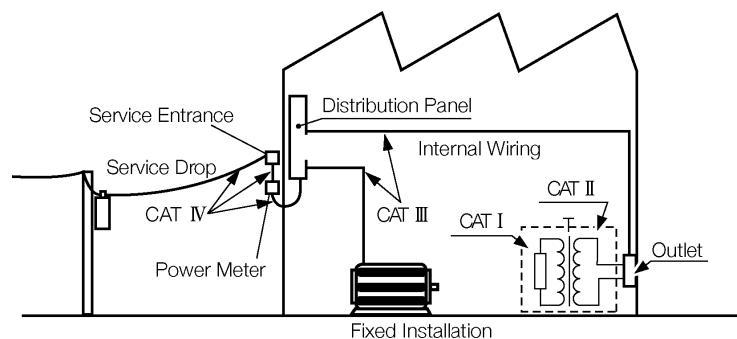

Accuracy

The specifications in this manual include figures for "measurement accuracy" when referring to digital measuring instruments, and for "measurement tolerance" when referring to analog instruments.

-
- f.s. (maximum display or scale value, or length of scale)
Signifies the maximum display (scale) value or the length of the scale (in cases where the scale consists of unequal increments or where the maximum value cannot be defined).
In general, this is the range value (the value written on the range selector or equivalent) currently in use.
 - rdg. (displayed or indicated value)
This signifies the value actually being measured, i.e., the value that is currently indicated or displayed by the measuring instrument.
 - dgt. (resolution)
Signifies the smallest display unit on a digital measuring instrument, i.e., the value displayed when the last digit on the digital display is "1".
-

Notes on Use



Follow these precautions to ensure safe operation and to obtain the full benefits of the various functions.



- **To avoid electric shock, do not remove the product's case. The internal components of the product carry high voltages and may become very hot during operation.**
- **The vinyl shield on the 9615 H.V. TEST LEAD alligator clip is not high voltage insulated. Do not touch when high voltage is applied.**



- **To avoid electric shock, do not allow the product to get wet, and do not use it when your hands are wet.**
- **To avoid electric shock, be sure to connect the protective ground terminal to a grounded conductor.**
- **Avoid stepping on or pinching the cable, which could damage the cable insulation.**
- **Before turning the product on, make sure the source voltage matches that indicated on the product's power connector. Connection to an improper supply voltage may damage the product and present an electrical hazard.**
- **Replace the fuse only with one of the specified characteristics and voltage and current ratings. Using a non-specified fuse or shorting the fuse holder may cause a life-threatening hazard.**
Fuse type: 250VT8AL (3159, 3159-01), 250VT4AL (3159-02 to 3159-04)

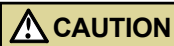

- **To avoid electrocution, turn off the power to all devices before plugging or unplugging any of the interface connectors.**
- **To avoid damaging the power cord, grasp the plug, not the cord, when unplugging the cord from the power outlet.**
- **To avoid damaging H.V. TEST LEAD, do not kink or pull on the leads.**
- **For safety reasons, when taking measurements, only use the H.V. TEST LEAD provided with the product.**
- **To avoid damage to the product, protect it from vibration or shock during transport and handling, and be especially careful to avoid dropping.**



Do not use the product near a device that generates a strong electromagnetic field or electrostatic charge, as these may cause erroneous measurements.

Chapter Summary

Chapter 1 Overview

Describes an overview, features, and the names and functions of the parts of the product.

Chapter 2 Testing Arrangements

Describes particulars of testing arrangements.

Chapter 3 Withstand Voltage Mode Testing Method

Describes procedures for setting, testing, and test results judgment.

Chapter 4 Insulation Resistance Mode Testing Method

Describes the procedures for setting the insulation resistance mode testing, testing method, and test decisions.

Chapter 5 Auto Test Mode Testing Method

Describes the procedures for setting the auto test mode testing, testing method, and test decisions.

Chapter 6 Optional Functions

Describes procedures for setting optional functions.

Chapter 7 Saving/Loading Preset Values

Describes procedure for saving and loading test values.

Chapter 8 External Interface

Describes use of the external I/O, status out and buzzer.

Chapter 9 RS-232C Interface

Describes communication procedures and commands for an RS-232C interface.

Chapter 10 Specifications

Contains the unit specifications such as the general specifications, measurement accuracy, etc. of the unit.

Chapter 11 Maintenance and Inspection

Covers the maintenance and inspection, fuse replacement, and ultimate disposal.

Appendix

Covers the options of the unit.

Chapter 1 Overview

1.1 Product Introduction

(1) Easy testing conforming to standards

With the unit insulation resistance and withstand voltage tests based on a wide variety of standards can be performed. The timer and comparative screening functions using the upper- and lower-limit values provide accurate test results. When testing withstand voltage, the unit does not operate until the output-voltage preset using the voltage adjustment knob is within $\pm 5\%$ (output-voltage ≤ 1 kV: ± 50 V) of the comparative-voltage value, thus ensuring more accurate readings.

(2) Automatic insulation resistance testing and withstand voltage testing

The Auto Test mode allows consecutive insulation resistance and withstand voltage tests to be performed.

(3) Fluorescent indicator

The large, easy-to-read fluorescent display permits quick checking of the testing state and result.

(4) Analog Voltage Measurement

The voltage is digitally displayed on the fluorescent indicator. This value can also be checked on the analog voltmeter. (withstand voltage test only)

(5) Saving testing set values (Memory function)

This unit is provided with a function for saving the set values used in a test, allowing quick switching between different testing set values to meet a variety of standards and regulations. Up to 10 values may be saved for each testing mode.

The values immediately prior to a power shutdown are saved in the unit. These values are valid at the next startup.

(6) REMOTE CONTROL BOX

The 9613 REMOTE CONTROL BOX (SINGLE) or the 9614 REMOTE CONTROL BOX (DUAL) can be connected to the external switch terminal to perform 3159 start/stop control.

(7) External I/O

The external I/O terminal generates signals according to the state of the 3159. It can be used to feed signals for the **START** and **STOP** key.

(8) RS-232C interface as a standard feature

Automatic testing and saving of the test results are possible with the use of a computer.

(9) Status Out

Relay contact signals are output from the terminal on the rear panel according to the state of the 3159. The **DANGER** lamp can be connected to ensure safer testing.

1.2 Names and Functions of Parts

1.2.1 Front panel



To prevent electric shock, when the **DANGER** lamp is lit, never touch the **HIGH** or **LOW** terminals, **H.V. TEST LEAD**, or the tested object.

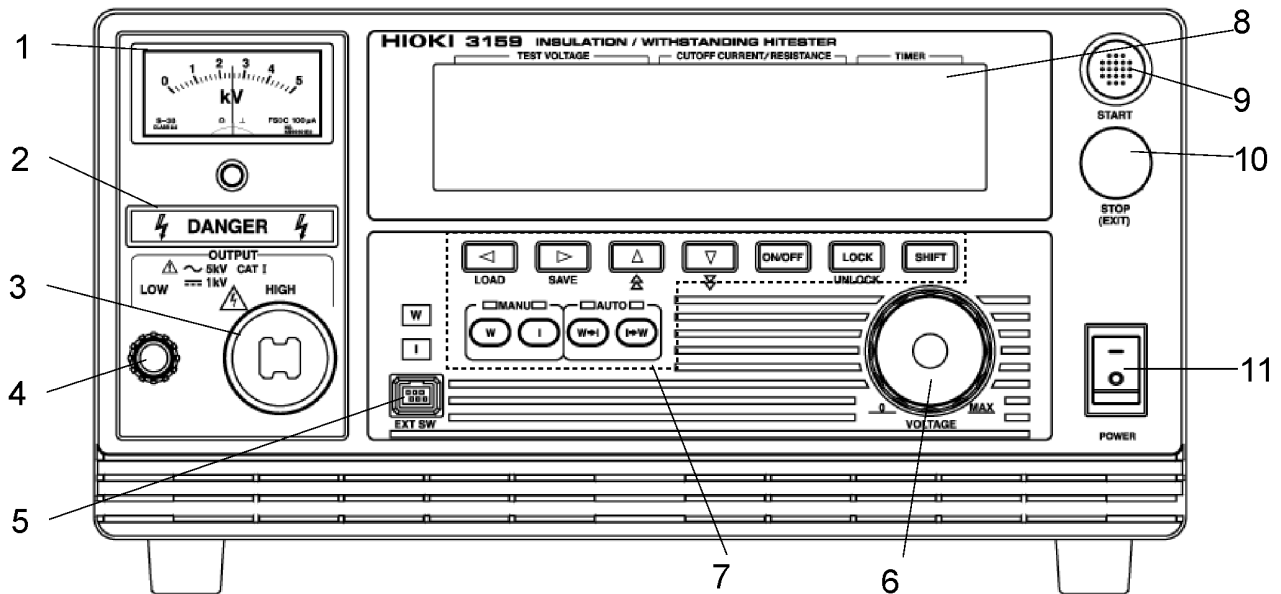

1	Analog voltmeter	Indicates output-voltage when testing withstand voltage.
2	DANGER lamp	This lamp lights to warn that voltage is present between the terminals during testing.
3	HIGH terminal	The HIGH terminal is a high-voltage terminal for voltage outputs. A high voltage is generated between this terminal and the LOW terminal. When the DANGER lamp is lit, never touch this terminal.
4	LOW terminal	The LOW terminal is a low-voltage terminal for voltage outputs. It has the same electric potential as the unit body.
5	External switch terminal	Used for the signal line for the REMOTE CONTROL BOX.
6	Output voltage knob	Sets the output-voltage.
7	Rubber keys	The 10 rubber keys include six function keys and a SHIFT key. The six function keys offer a variety of settings, used in combination with the SHIFT key.
8	VFD (vacuum fluorescent display)	Displays various information, such as the test state and test results.
9	START key	Used to start a test. This key functions only when the READY lamp is lit.
10	STOP key	Normally used to terminate a test.
11	Main power switch	Powers the 3159 on or off.

1.2.2 Rubber keys

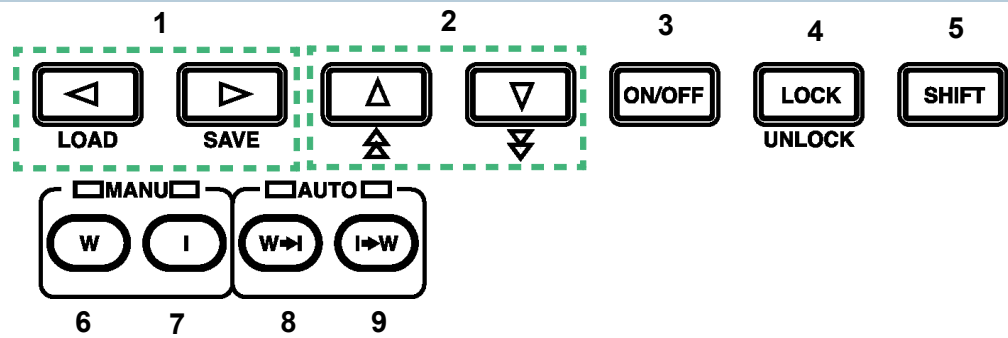

1 key	<p>Moves the flashing cursor. The switching range is preset before shipment:</p> <p>Withstand voltage test: Comparative voltage value ↔ Upper limit Value ↔ Lower limit Value ↔ Test time ↔ Output voltage range</p> <p>Insulation resistance test: Test voltage value ↔ Lower limit Value ↔ Upper limit Value ↔ Test time</p> <p>To display the flashing cursor, press the keys. The cursor appears, displaying the preset comparative voltage value or test voltage value.</p>
2 key	Changes the position at which the flashing cursor appears.
3 ON/OFF key	<p>Switches on/off the set value for the position of the flashing cursor. If turned off, the set value is not used in testing. However, the following key can't perform the switching on/off:</p> <ul style="list-style-type: none"> • Upper limit Value (Withstand voltage test) • Output voltage range (Withstand voltage test) • Test voltage value (Insulation resistance test) • Lower limit Value (Insulation resistance test)
4 LOCK key	<p>Used to lock the keys. When pressed, the LOCK key disables all keys except the START key, STOP key, and UNLOCK key (LOCK + SHIFT key). (See Section 3.3.2)</p>
5 SHIFT key	<p>Used in combination with other keys.</p> <ol style="list-style-type: none"> (1) SHIFT + key Displaying the Preset-data loading screen. (See Chapter 7) (2) SHIFT + key Displaying the Preset-data saving screen. (See Chapter 7) (3) SHIFT + UNLOCK key Disabling the key lock function. (4) SHIFT + key Changing the increment size of setting values.
6 W key (withstand-voltage test)	Performs withstand voltage tests and settings.
7 I key (insulation-resistance test)	Performs insulation resistance tests and settings.
8 W → I key	Tests for voltage, then insulation resistance.
9 I → W key	Tests for insulation resistance, then withstand voltage.

1.2.3 Rear panel



To prevent electric shock, when the **DANGER** lamp is lit, never touch the **HIGH** or **LOW** terminals, **H.V. TEST LEAD**, or the tested object.

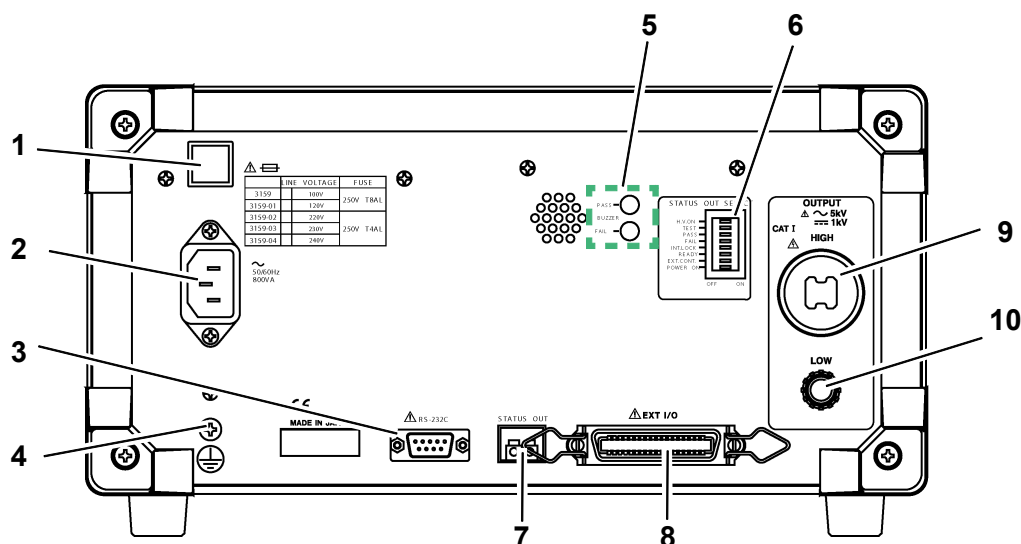

1	Fuse holder	Contains a power fuse.
2	Power inlet	Connect the grounded three-core power cord supplied here. Integrated with a fuse holder.
3	RS-232C terminal	Used for remote control with RS-232C.
4	Protective ground terminal	Used to earth a protective ground wire. Be sure to make grounding connections before starting a test.
5	Buzzer adjustment knob	Used for buzzer sound adjustment. Two knobs are provided: one for PASS screening and one for FAIL screening.
6	STATUS OUT dip switch	Used to set the output conditions for relay contacts when using the status out function.
7	STATUS OUT relay terminal	Switches on the relay contacts if the conditions set with the STATUS OUT dip switch are met.
8	External I/O terminal	For output of 3159 state and input of start and stop signals.
9	HIGH terminal	A high-voltage terminal for voltage output. Connected to the HIGH terminal on the front panel.
10	LOW terminal	A low-voltage terminal for voltage output. Contains the same electrical potential as this units casing.

1.2.4 9615 H.V. TEST LEAD



The vinyl shield on the 9615 H.V. TEST LEAD alligator clip is not high voltage insulated. Do not touch when high voltage is applied.

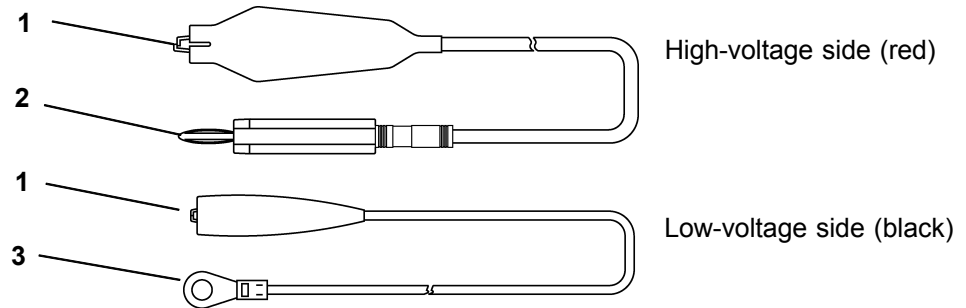

1	Alligator clip	Connect to a test point on the tested object.
2	High-voltage output plug	Connect to the HIGH terminal on the unit.
3	Low-voltage output plug	Connect to the LOW terminal on the unit.

1.2.5 REMOTE CONTROL BOX

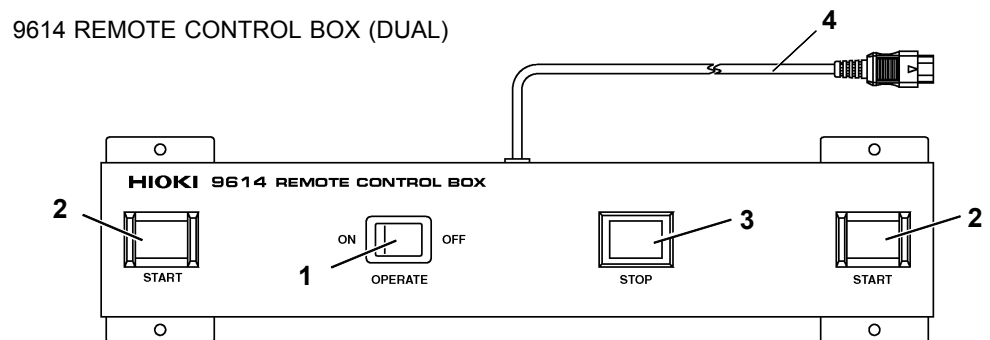
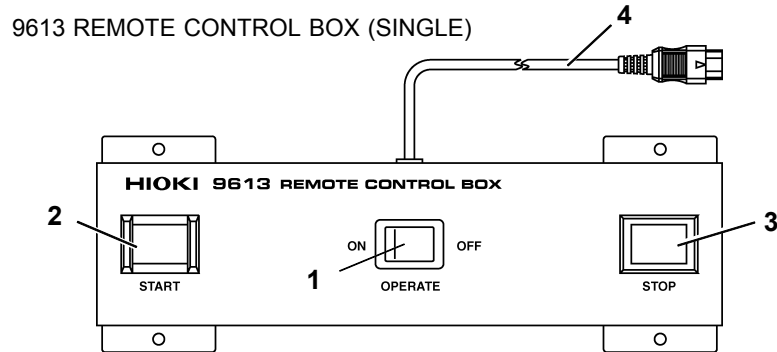

1 OPERATE switch	Used to enable remote-control operation. When this switch is ON, the START and STOP keys for remote control are active.
2 START key	Works in the same manner as the START key on the unit. With the 9614 REMOTE CONTROL BOX (dual-hand), the two START switches must be pressed.
3 STOP key	Works in the same manner as the STOP key on the unit. The STOP key is ON during a test or when a voltage is being output.
4 Switch signal-line plug	Connect to the external switch terminal on the unit.

1.3 External Dimensions

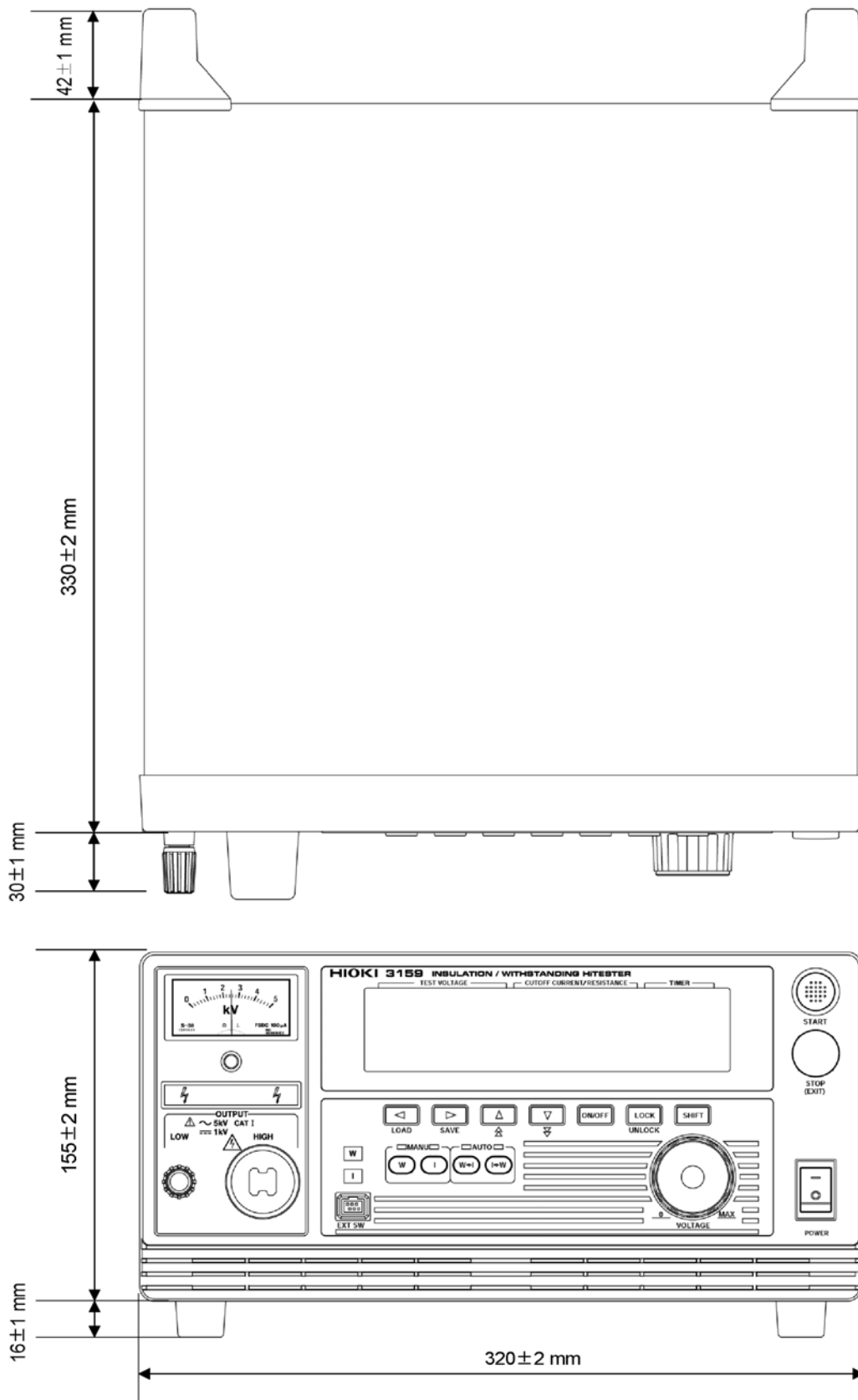

Chapter 2

Testing Arrangements

2

2.1 Connecting the Protective Ground Terminal



- To avoid electric shock, be sure to connect the protective ground terminal to a grounded conductor.
- To avoid electric shock, connect the protective ground terminal to a grounded conductor before making any other connections.

1. Using a Phillips-head screwdriver, remove the protective ground terminal from the rear of the unit.
2. Connect an electric wire with a sufficient current capacity to the protective ground terminal, and secure the wire using a Phillips-head screwdriver.
3. Ground the other end of the wire.

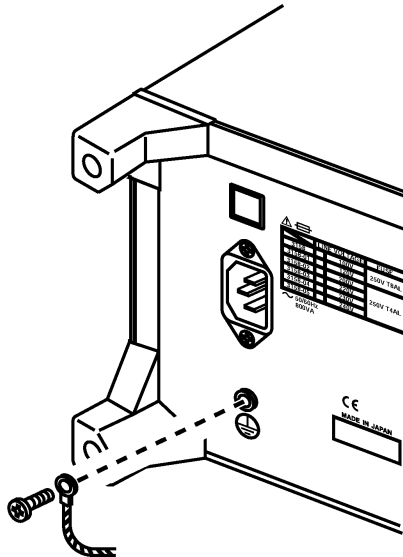

2.2 Connecting the External I/O Connector

2

Connect the external I/O connector before turning on the power. If the external I/O connector is installed or removed following startup, malfunction may result.

1. Insert the external I/O connector into the external I/O terminal.
2. Secure the external I/O connector using the hooks of the external I/O terminal.

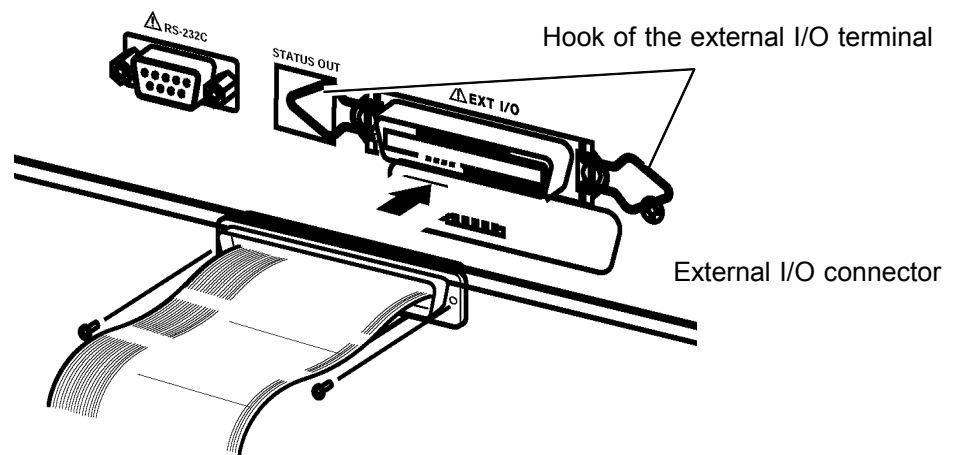

NOTE

- For the specifications of the external I/O connector, see [Section 8.1](#).
- If the optional "Interlock" function is set to "1: Set," set Pin 10 of the external I/O terminal to "Lo" before starting a test. "Err. 0" will be indicated until "Lo" is set. (See [Section 8.1.4](#))

2.3 Power Cord Connection



Before turning the product on, make sure the source voltage matches that indicated on the product's power connector. Connection to an improper supply voltage may damage the product and present an electrical hazard.

Supply voltage indicated on the rear panel

	LINE VOLTAGE	FUSE
3159	● 100V	250V T8AL
3159-01	120V	
3159-02	220V	250V T4AL
3159-03	230V	
3159-04	240V	

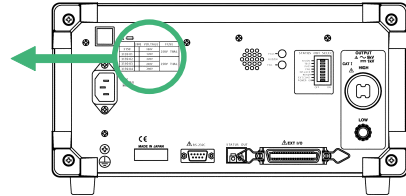

1. Be sure that the main power switch is turned to OFF.
2. Connect the grounded three-core power cord provided to the power inlet on the back of the unit.
3. Insert the plug into the grounded outlet.

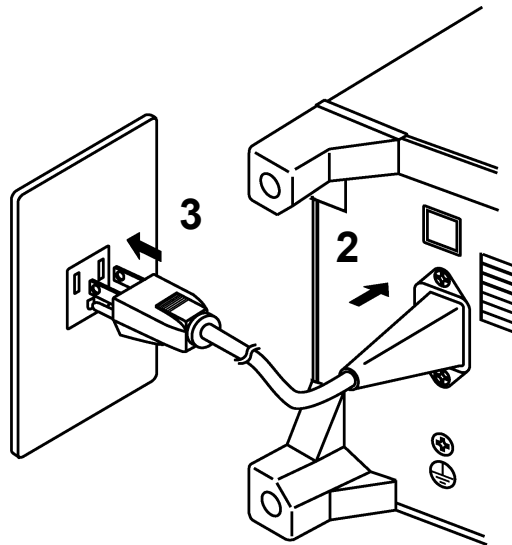

2.4 Powering On and Off the Unit



Before turning on the power, make sure that the voltage of the power supply being used matches the supply voltage indicated on the rear panel of the unit. If an attempt is made to use an improper supply voltage, there is danger of damage to this unit and of life-threatening risk to the operator. Apply a voltage within the acceptable power voltage range. Otherwise, damage to the unit or electrical accidents may result.

NOTE

- The settings immediately prior to power shutdown are saved. The unit restarts with these settings, even following a power interruption. When settings are modified, however they are only saved after running a test.
- Allow 5 minutes warming up after powering on.
- The REMOTE CONTROL BOX, external I/O device, RS-232C interface, and status out function are active only when they are connected prior to startup. If these devices are connected after the power is turned on, the protective function may be activated, thus causing a malfunction.

(1) Powering on the unit

1. Turn the main power switch to ON (|).

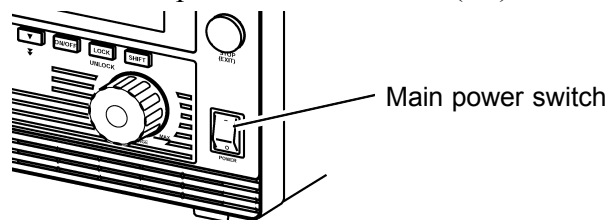

2. The model name and version number are displayed as below:
3. When the **READY** lamp is lit (it does not light up in the Double Action mode), the keys are ready for operation.

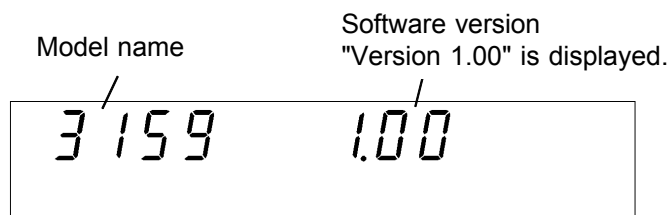

(2) Powering off the unit

1. Following a test, make sure the analog voltmeter is at 0 kV, the **DANGER** lamp is OFF, and the **READY** lamp is lit.
2. Turn the voltage adjustment knob counterclockwise until the output reaches 0 kV. Do not turn OFF the Main Power switch when a voltage is being output, as the unit may be damaged as a result.
3. Turn OFF the Main Power switch.

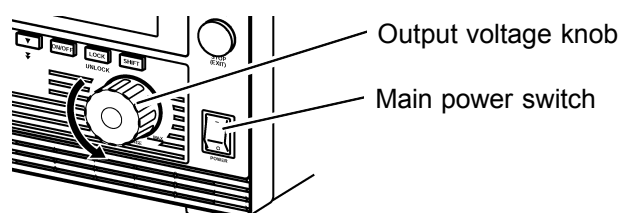

2.5 Connecting the 9615 H.V. TEST LEAD



- To prevent electrical shock, turn off the power unit and tested object, make sure that there is no high voltage being applied to the output, confirm the following 3 items, and connect the 9615 H.V. TEST LEAD.
 - (1) The analog voltmeter reads 0 kV.
 - (2) The **DANGER** lamp is OFF.
 - (3) The **READY** lamp is lit (it is off in the Double Action mode).
- Before connecting the 9615 H.V. TEST LEAD, be sure to check its insulation for tearing and metal exposure. Using the product in such conditions could cause an electric shock, so contact your dealer or Hioki representative for repair.
- To avoid electric shock, make sure the 9615 H.V. TEST LEAD is securely connected before starting a test, as a loose test lead can cause a hazard when a voltage is output.

1. Remove the LOW terminal by turning it counterclockwise.

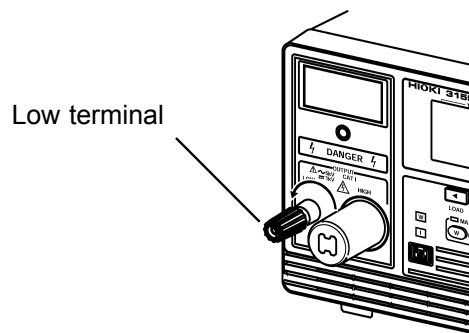

2. As shown in the figure, insert the plug on the H.V. TEST LEAD (low voltage side).
3. Secure the LOW terminal by turning it clockwise.
4. Connect the plug on the H.V. TEST LEAD (high voltage side) to the HIGH terminal.

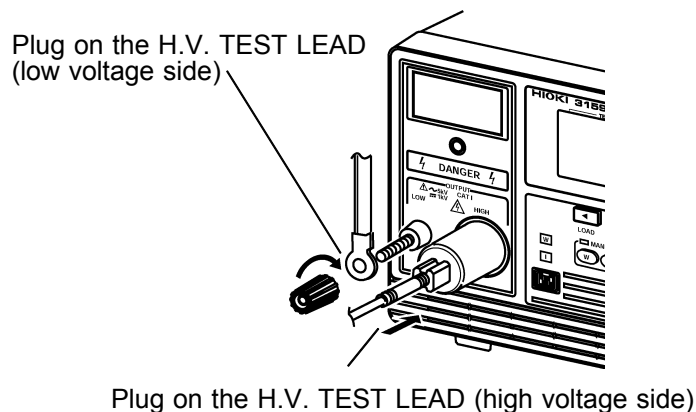

2.6 Connecting the REMOTE CONTROL BOX



- To prevent electrical shock, turn off the power unit and tested object, make sure that there is no high voltage being applied to the output, confirm the following 3 items, and connect the 9615 H.V. TEST LEAD.
 - (1) The analog voltmeter reads 0 kV.
 - (2) The **DANGER** lamp is OFF.
 - (3) The **READY** lamp is lit (it is off in the Double Action mode).
- To prevent malfunctions, do not remove the REMOTE CONTROL BOX following startup. Before removing it, be sure to turn OFF the power.
- To avoid electric shock, when using the REMOTE CONTROL BOX, provide safety measures to keep the output-voltage terminal, tested object, and H.V. TEST LEAD out of contact with one another when they are in the TEST state.

Connection of the REMOTE CONTROL BOX (9613/9614) enables start/stop operations to be performed easily.

1. Make sure the Main Power switch and OPERATE switch on the REMOTE CONTROL BOX are OFF.

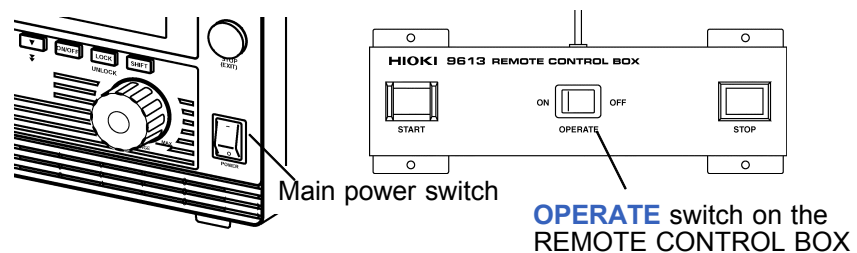

2. Insert the switch signal-line plug into the external switch terminal. Check the direction of the switch signal line.
3. Turn ON the **OPERATE** switch of the REMOTE CONTROL BOX. The **OPERATE** switch can be turned ON/OFF even following startup.

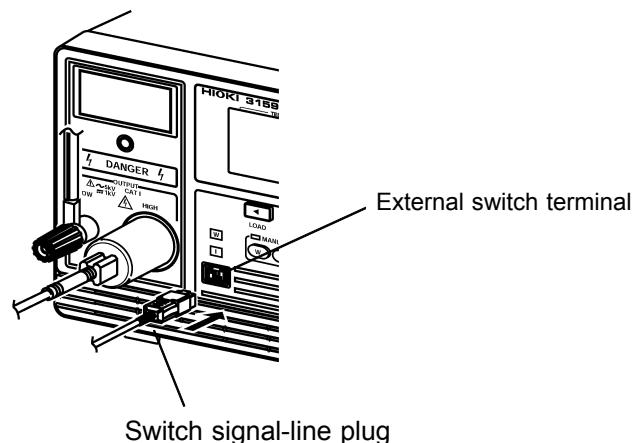

2.7 Installation of the Unit

Temperature: 0 to 40°C

Humidity: 80%RH or less (no condensation)

Avoid the following locations:

- Subject to direct sunlight.
- Subject to high levels of dust, steam, or corrosive gases (Avoid using the equipment in an environment containing corrosive gases (e.g., H₂S, SO₂, NI₂, and Cl₂) or substances that generate harmful gasses (e.g., organic silicones, cyanides, and formalins)).
- Subject to vibrations.
- In the vicinity of equipment generating strong electromagnetic fields.



NOTE

Noise from the unit may affect peripheral equipment.

2.8 Connection to the Measured Equipment



Observe the following precautions to avoid electric shock.

- Make sure that no high voltage is being applied to the output, confirm the following items, and connect the H.V. TEST LEAD.
 - (1) The analog voltmeter reads 0 kV.
 - (2) The DANGER lamp is OFF.
 - (3) The **READY** lamp is lit (it is off in the Double Action mode).
- In the TEST state, never touch the output-voltage terminal, H.V. TEST LEAD, or tested object.
- Even following a test, there may be a residual voltage at the output terminal. Therefore, before touching the output-voltage terminal, H.V. TEST LEAD, or tested object, make sure that no high voltage is being applied between the output terminals.

1. Make sure the analog voltmeter is at 0 kV and the **DANGER** lamp is OFF.
2. Make sure the unit is in the READY state with the **READY** lamp ON (it is OFF in the Double Action mode).
3. Connect the LOW terminal probe to the tested object. Fasten the probe securely to prevent it from loosening during a test.
4. Following the procedure described above, connect the HIGH terminal probe to the tested object.

2.9 Startup Inspection

To ensure safe testing, check the following before starting operation:

(1) Breaking current (withstand voltage mode)

1. Calculate the resistance based on the output-voltage set for withstand voltage testing and the upper test value, and prepare a resistor corresponding to the calculation result.

$$(\text{Output voltage} \div \text{Upper-limit value (Breaking current)}) = \text{Resistance}$$

2. Set an upper-limit value.
3. Connect the resistor to the H.V. TEST LEAD.
4. Increase the output voltage beyond the set value, and make sure the current is cut off (i.e., make sure the unit is in the FAIL state).

A high-voltage resistor with a power rating larger than the power calculated from the output voltage and resistance is recommended.

$$((\text{Output voltage})^2 \div \text{Resistance}) < \text{Power rating}$$

Example high-voltage resistor:

KOA Corp.'s GS Series High Voltage High Resistance Thick Film Resistor

(2) Measured resistance (insulation-resistance mode)

1. Calculate the resistance based on the test voltage set for insulation resistance testing and the measured current (1 mA), and prepare a resistor whose resistance is larger than that of the calculation result.
output-voltage \div measured current (1 mA) \leq resistance value
2. Specify the test voltage.
3. Connect the resistor that you prepared to the H.V. TEST LEAD.
4. Make sure that the resistance measured matches the resistor that you prepared.

(3) Analog voltmeter

1. Before turning on the power, make sure the analog voltmeter is at 0 kV.
2. If the voltage reading is not at zero, adjust the value to zero using a slotted screwdriver.

(4) Interlock

If the Interlock function is set, make sure the Interlock function works properly before starting operation. (See [Section 8.1.4](#))

(5) Key inspection

1. Turn off the power, and unplug the power cord from the power outlet.
 2. For both the START and STOP keys on the front panel of the unit, press the center of the key, and make sure you feel it click. The click is less noticeable when the edges of the keys are pressed.
- * Clicking
When a key is pressed slowly, there is a moment of slight resistance and a feeling that the key cannot be pressed any further. When the key is pressed further after this point, a clicking sensation can be felt.
3. If you do not feel a click, the key may be broken.

Chapter 3

Withstand Voltage Mode Testing Method

3

This chapter describes how to set withstand voltage mode test conditions and the proper testing procedure.

Read Chapter 2, and make the necessary preparations for testing.

Press the **W** key to enter withstand voltage mode. (The lamp above the key lights.)

Flashing

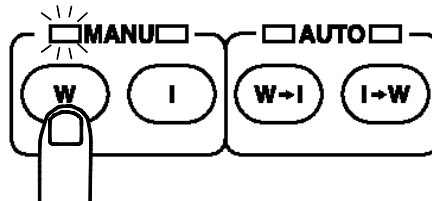

NOTE

- Note that the output waveform may be distorted when conducting an AC withstand voltage test for a voltage-dependent device or object (e.g., ceramic capacitor). Excessively large distortion may damage the device or tested object.
- When the device or tested object is a capacitive load, resonance may occur (when conducting an AC withstand voltage test) with the coil inductance of the output high-voltage transformer, depending on the capacitance value. This condition may generate several tens of volts at the voltage output terminal before the test is started. If the START key is disabled, reset the output voltage knob to zero, then set it back to the desired voltage after starting the test.

3.1 Withstand Voltage Mode Display

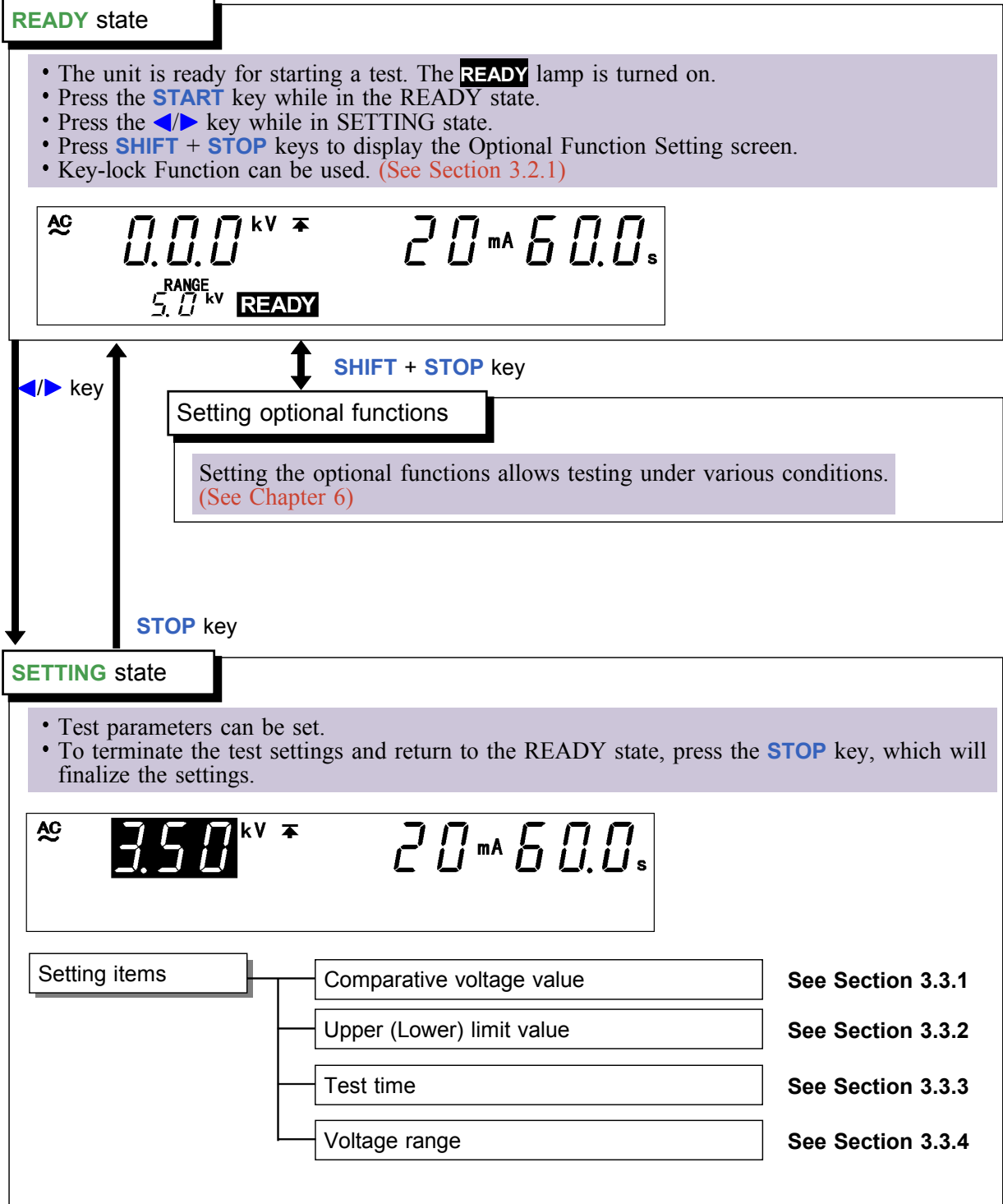

START key

TEST state

See Section 3.4.3

- When the unit is in the TEST state, the **TEST** lamp is lit. This indicates that a test is in progress.
- The measured-voltage value is compared with the comparative-voltage value set in the SETTING state. If the measured-voltage value deviates from the comparative-voltage range, the unit shifts to the FAIL state and the test is terminated.
- The measured-current value is compared with the upper- and lower-limit values. If the measured-current value deviates from these values, the unit shifts to the FAIL state and the test is terminated. When the preset test time has elapsed, if there have been no deviations, the unit shifts to the PASS state.
- Press the **STOP** key to forcibly terminate the test.



Key operation in the TEST status

Forced ending

Press the **STOP** key.**PASS** state

See Section 3.5.1

- **PASS** indicates that the measured object passed the test set in the READY state.
- The **PASS** lamp is turned on. The PASS state screen is displayed for about 0.3 second before switching to the READY state.
- The PASS state can be maintained if the PASS Hold function is disabled in the optional settings. (See Section 6.1)

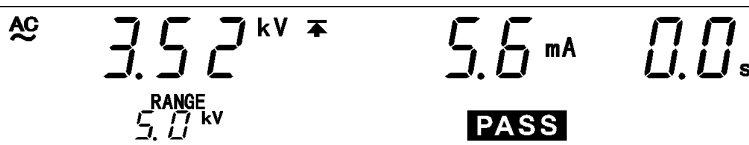
**FAIL** state

See Section 3.5.3

- **FAIL** indicates that the tested object failed to pass the test set in the READY state.
- The **FAIL** lamp will light up, accompanied by **UPPER** if the measured value exceeds the upper-limit value, or by **LOWER** if the measured value is below the lower-limit value.
- If the measured value deviates from the comparative-voltage range, the **FAIL** lamp will light up, accompanied by both **UPPER** and **LOWER**.
- The FAIL state can be maintained. To return to the READY state, press the **STOP** key, which will cancel the FAIL Hold function.
- FAIL Hold function can be disabled in the optional settings. The FAIL-state screen is displayed for 0.3 seconds, and the unit then switches to the READY state. (See Section 6.2)

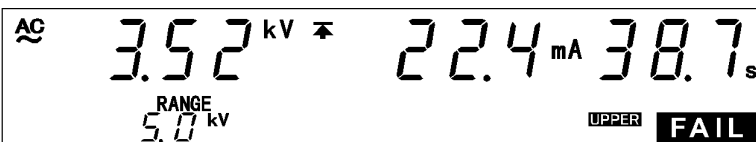

3.2 Displaying the READY State

In the READY state, the unit is always ready to start a test. The unit can be shifted to the SETTING state only when it is in the READY state.

The **READY** lamp remains lit to indicate the READY state.

Saving and loading for setting data and the setting of optional functions are made following the READY state.

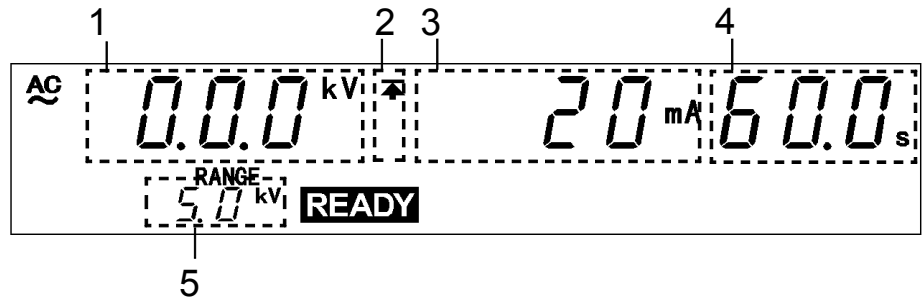

1	Measured voltage value	Indicates the voltage value being output. In the READY state, the value indicates at 0 kV.
2	Upper limit value icon Lower limit value icon	The symbol \blacktriangle appears when the upper limit value is set, and the symbol \blacktriangledown appears when the lower limit value is set.
3	Upper (Lower) limit value	Indicates Upper (Lower) limit value.
4	Test time	Indicates the preset test time. "OFF" is indicated when no test-time setting has been made.
5	Output voltage range	Indicates the output-voltage range.

Danger lamp

Indicates that a voltage is being output. This lamp remains lit as long as a voltage is being applied to the output terminal. It does not light up in the READY state.

Analog voltmeter

Indicates the voltage value being output. In the READY state, the value remains at 0 kV.

External I/O

The READY signal is ON when **READY** is lit on the fluorescent indicator.

The READY signal is turned OFF when **READY** is not lit.

Key Operations

◀▶	Displays the SETTING state. (See Section 3.3)
SHIFT + ▶	Displays the set data Save screen. (See Section 7.1)
SHIFT + ◀	Displays the set data Load screen. (See Section 7.2)
SHIFT + STOP	Displays the Optional functions setting screen. (See Chapter 6)
START	Test Start (See Section 3.4)
LOCK	Key-lock function (See Section 3.2.1)

3.2.1 Key-lock Function

It inactivates all keys except the **START** key, **STOP** key, and the range switch. The **KEYLOCK** lamp is lit while the key-lock function is active. Use this function when you do not want to change the test mode or test settings.

To switch to the KEY-LOCK state, press the **LOCK** key. The **KEYLOCK** lamp is lit.

To cancel the key-lock function, press the **LOCK** key in the Key-LOCK state while holding down the **SHIFT** key. The **KEYLOCK** lamp is not lit.

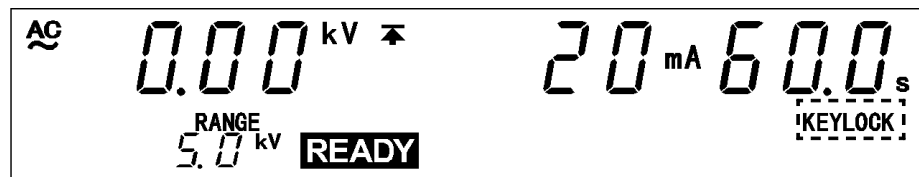

NOTE

Even when the key-lock function is activated, the **START** and **STOP** keys on the REMOTE CONTROL BOX and the start and stop signals on the external I/O terminal remain active.



3.3 "SETTING" State

To set or change test settings, switch to the SETTING state.

NOTE

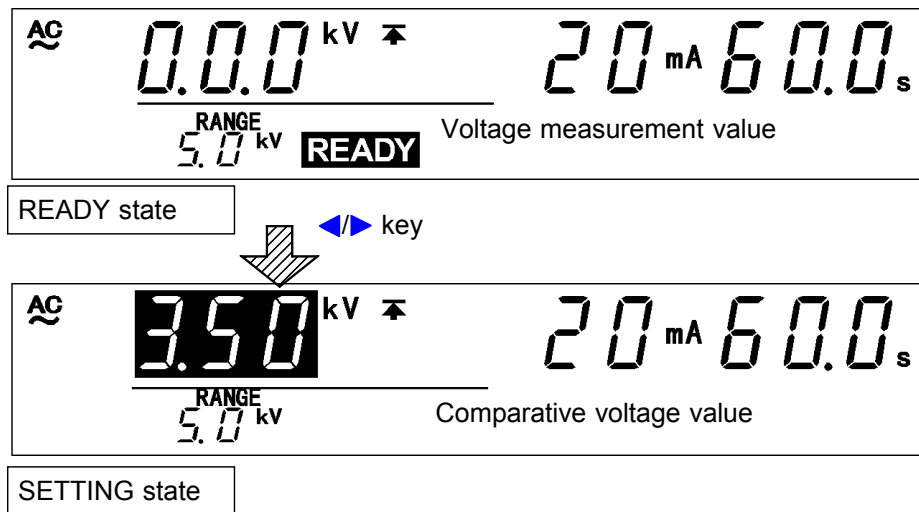
- In the SETTING state, the **READY** light goes out and tests cannot start.
- In withstand voltage mode, the READY state displays the measured voltage value, whereas the SETTING state displays the comparative-voltage value. Note that the presence of a comparative-voltage value does not mean that voltage is being output.



1. In the withstand voltage mode READY state, when you press the  keys, the flashing cursor appears where the comparative-voltage is indicated to show that the unit is in the SETTING state. (The **READY** light goes out and tests cannot start even if the **START** key is pressed.)
2. Use the following operation keys to make settings:
 -  key: Move the flashing cursor.
 -  key: Change settings.
 - ON/OFF** keys: Activate and deactivate values.
 - The flashing cursor moves between the comparative-voltage value, upper-limit value, lower-limit value, test time, and the output-voltage range
 - If the value indicated by the flashing cursor is not needed in the test, turn it OFF using the **ON/OFF** keys. The upper-limit value and the output-voltage range, however, cannot be turned OFF.
3. To finalize the test settings, press the **STOP** key. The settings are confirmed and the unit returns to the READY state.

NOTE

Note that the unit does not return to the READY state if the lower-limit value is greater than the upper-limit value. In this case, correct the settings and press the **STOP** key to confirm them.

3.3.1 Setting the Comparative Voltage Value

- If a comparative-voltage value needs to be set, value settings must be made. Check that the output-voltage reaches the set comparative-voltage range, which is $\pm 5\%$ (± 50 V when the output-voltage ≤ 1 kV).
- If the output-voltage value fails to reach the comparative-voltage range, the test does not start. **TEST** flickers and if the value fails to reach the comparative-voltage range within approximately 5 seconds, the unit returns a FAIL result and the test ends. Further, if the output-voltage value deviates from the value range, the test is immediately terminated.
- If this function is not to be used, press the **ON/OFF** key to turn the setting for that value OFF.

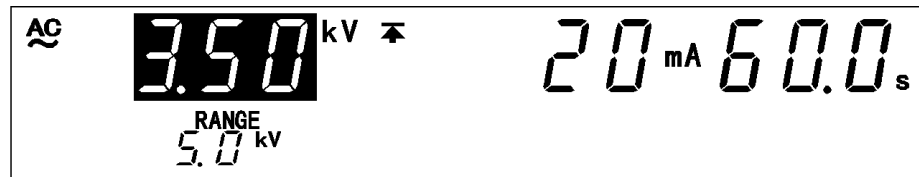

Comparative voltage value: 3.50 kV

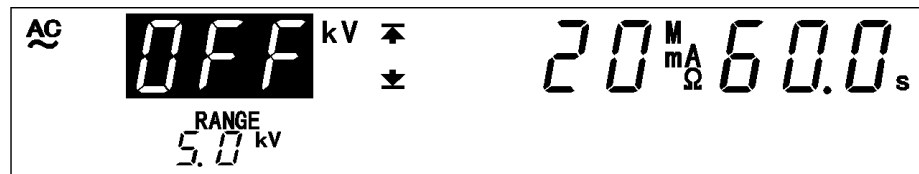

Comparative voltage value: OFF

1. If no flashing cursor is displayed in the withstand voltage mode READY state, press either the **◀/▶** key to display the cursor in the comparativevoltage value position.
2. Change the comparative voltage value using the **▼/▲** keys. The value changes in 0.01 kV increments. To change the value by 0.10 kV, press **SHIFT + ▼/▲** keys.
The comparative voltage value can be set from 0.00 kV to 5.00 kV.
If a comparative voltage value is not to be used, press the ON/OFF key to turn the setting for that value OFF.
3. To finalize the test settings, press the **STOP** key. The settings are confirmed and the unit returns to the READY state.

Optional Function

You can select whether you want to check the output-voltage when the test starts or ends. (When the default is set to the start of testing.)

(See Section 6.9)



When test time is off, the voltage comparator function is disabled.

3.3.2 Setting the Upper (Lower) Limit Value

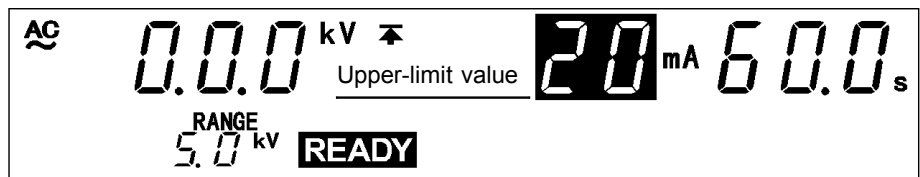

Upper (Lower) Limit Value: 20 mA

1. If no flashing cursor is displayed in the withstand voltage mode READY state, press either the $\blacktriangleleft/\blacktriangleright$ key to display the cursor in the upper (lower) limit value position.
2. Set the upper (lower) limit value using the $\blacktriangledown/\blacktriangle$ keys.
The upper (lower)-limit value will change by 0.1 mA (by 1 mA at 10 mA to 120 mA).
While holding down the **SHIFT** key, press the $\blacktriangledown/\blacktriangle$ keys. The upper (lower)-limit value will change by 1.0 mA (by 10 mA at 10 mA to 120 mA).
The upper-limit value can be set between 0.1 and 120 mA. The lower limit value can be set between 0.1 and 119 mA.
If no lower limit value is required, turn off the **ON/OFF** key. Upper limit value can not be turn off.
3. To finalize the test settings, press the **STOP** key. The settings are confirmed and the unit returns to the READY state.

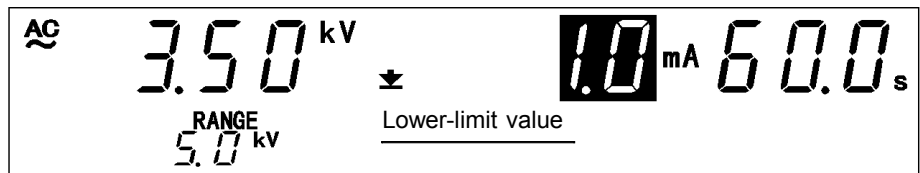

Lower-limit value: 1.0 mA

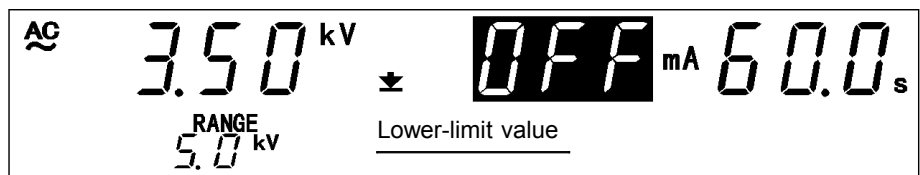

Lower-limit value: OFF

NOTE

- The setting resolution of the upper (lower)-limit value is 0.1 mA at 0.1 mA to 9.9 mA, and 1 mA at 10 mA to 120 mA.
- The current measurement resolution during a test depends on the set upper-limit value: 0.01 mA at 0.1 mA to 8.0 mA, 0.1 mA at 8.1 mA to 32 mA, and 1 mA at 33 mA to 120 mA.
- If the set lower-limit value is greater than the upper-limit value, the unit will not return to the READY state even when the **STOP** key is pressed. In such a case, correct the upper- or lower-limit value.

3.3.3 Setting the Test Time

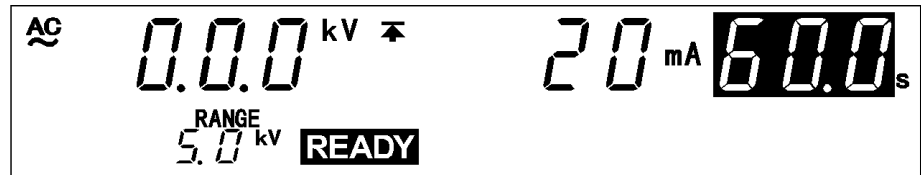

Test Time: 60.0 s

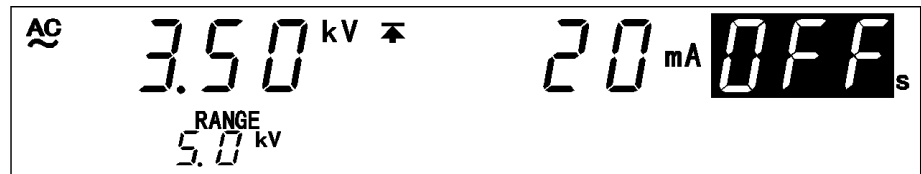

Test Time: OFF

1. If no flashing cursor is displayed in the withstand voltage mode READY state, press either the ◀/▶ key to display the cursor in the test time position.
2. Set the test time using the ▼/▲ keys.
 With time set the time changes in 0.1 s increments (1 s increments when the set time scale is 100 to 999 s).
 With time set at 0.5 s to 99.9 s, press **SHIFT** + ▼/▲ keys. The time changes in 1.0 s increments (10 s increments when the set time scale is 100 s to 999 s).
 Settings may be made along a scale ranging from 0.5 s to 999 s.
 If no testing time is required, turn off the **ON/OFF** key.
3. To finalize the test settings, press the **STOP** key. The settings are confirmed and the unit returns to the READY state.

NOTE

- The setting resolution of the test time is 0.1 s between 0.5 and 99.9 s, and becomes 1 s between 100 and 999 s.
- If a test time has been set, the reduction timer will operate during the test.
- If the test time is set to OFF, the comparative-voltage value becomes ineffective. If the test time is set to OFF, it facilitates output-voltage settings.
- If the test time is set to OFF, the time elapsed during the test is displayed. When this time exceeds 999 s, "---" will appear, but the test will continue.

3.3.4 Setting the Output Voltage range

CAUTION

The output-voltage nearly doubles when the output-voltage range is changed from 2.5 kV to 5.0 kV. To avoid damaging the unit, after changing the range, make sure that you adjust the output-voltage using the voltage adjustment knob.

Set the output voltage range in withstand voltage mode. The output voltage range indicates the maximum output voltage range that can be set using the voltage adjustment knob.

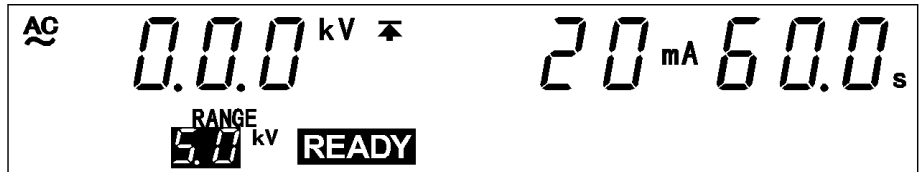

Output voltage range: 5.0 kV

1. If no flashing cursor is displayed in the withstand voltage mode READY state, press either the ◀/▶ key to display the cursor in the output voltage range position.
2. Change the voltage range using the ▼/▲ keys. The voltage range can be set to 2.5 kV or 5.0 kV.
3. To finalize the test settings, press the STOP key.

3.3.5 Examples of Settings

This section describes the procedure for making withstand voltage test settings under the following conditions.

Test voltage value: 2.00 kV
 Upper limit value: 20 mA
 Lower limit value: OFF
 Test time: 60.0 s
 Output voltage range: 2.5 kV

The 3159 is in the READY state in withstand voltage mode.

Values currently set	
Comparative voltage value	OFF
Upper limit value	120 mA
Lower limit value	40 mA
Test time	120 s
Output voltage range	5.0 kV



Values to be set	
Comparative voltage value	2.00 kV
Upper limit value	20 mA
Lower limit value	OFF
Test time	60.0 s
Output voltage range	2.5 kV

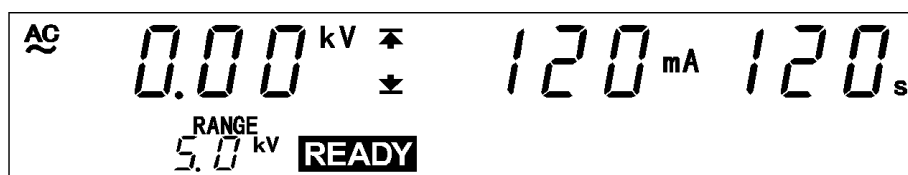

(1) Changing to the SETTING state

Press the ◀/▶ keys to switch to the SETTING state. The **READY** light will go out, and the flashing cursor will be displayed at the position where the comparative-voltage value is indicated.

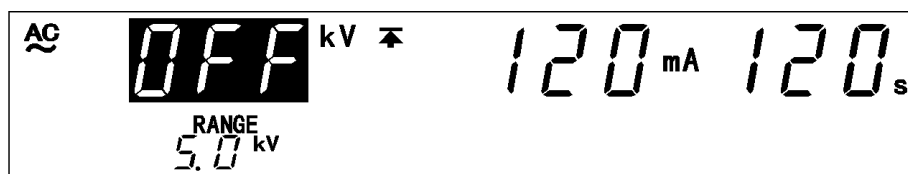

In the READY state, a measured-voltage value is displayed. In the SETTING state, the display changes to the comparative-voltage value (in this example, OFF).

(2) Setting the comparative-voltage value

The comparative-voltage value is initially set to OFF. It must be changed to ON before the value is changed. To do so, press the ON/OFF key.

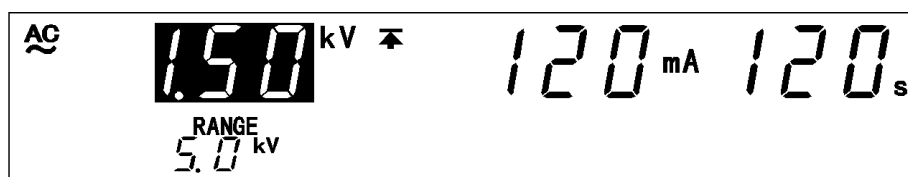

The comparative-voltage value in the OFF state is displayed. In this example, the value is **1.50 kV**.

Using the / keys, set the comparative voltage value to **2.00 kV**.

To change the value by 0.01 kV, press **▼/▲** keys.

To change the value by 0.10 kV, press **SHIFT + ▼/▲** keys.

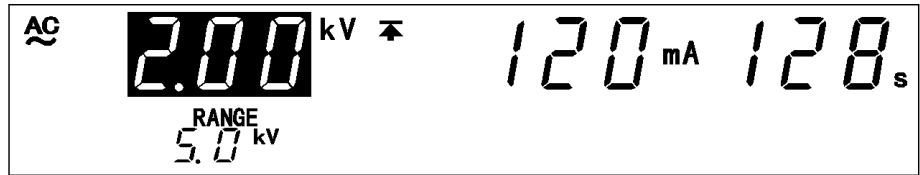

(3) Setting an upper-limit value

Press the **▶** key to move the flashing cursor to the upper-limit value.



In this example, switch from **120 mA** to **20 mA** using the **▼/▲** keys.

To change the upper limit value by **1 mA**, press **▼/▲** keys.

To change the upper limit value by **10 mA**, press **SHIFT + ▼/▲** keys.

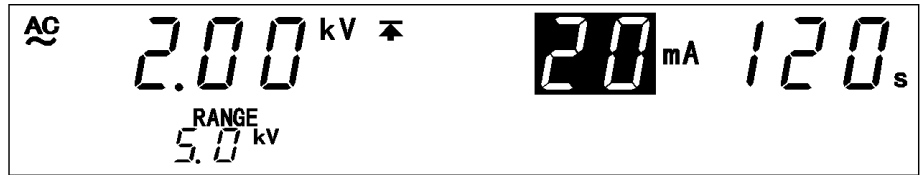

(4) Setting a lower-limit value

Using the **▶** key, move the flashing cursor to the lower limit value.

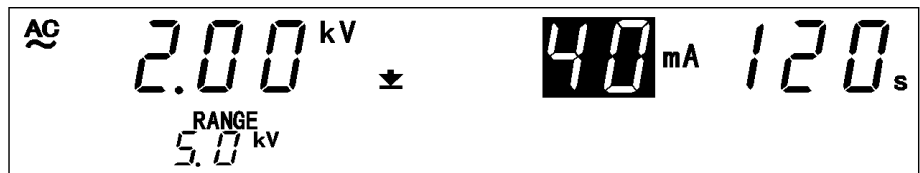

The lower-limit value is set at **40 mA**. Turn it OFF, as it is not needed. To change to **OFF**, press the **ON/OFF** key.

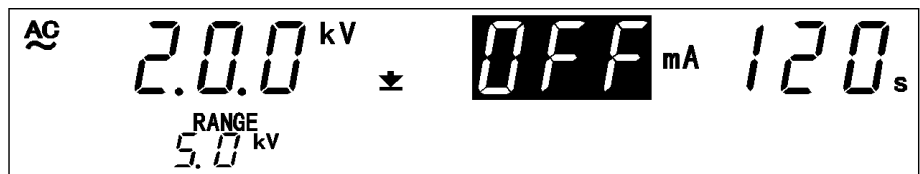

(5) Setting the test time

Using the ► key, move the flashing cursor to the test time.

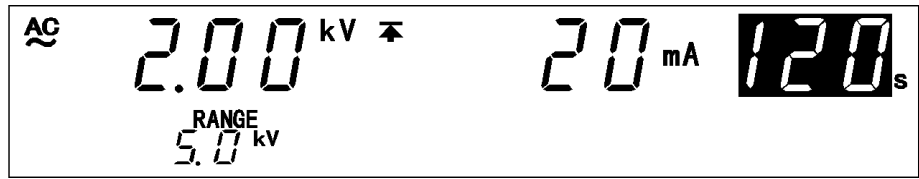

In this example, change the test time from 120 s to 60.0 s.

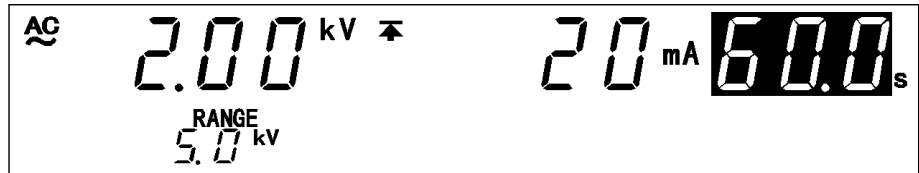

(6) Setting an output voltage range

Press the ► key to move the flashing cursor to the output voltage range.

In this example, change the output voltage range from 5.0 kV to 2.5 kV using ▼/▲ keys.

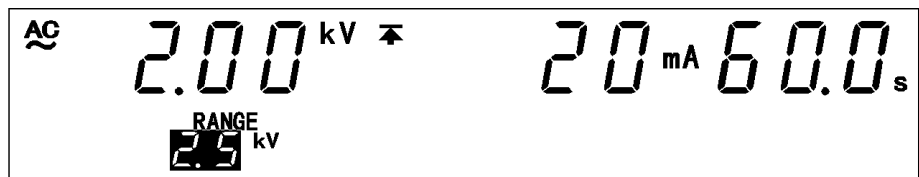

(7) Changing to the READY state

To return to the READY state, press the STOP key, which will finalize the test settings. In the READY state, the displayed comparative-voltage value is replaced with a measured-voltage value, and **READY** lights up.

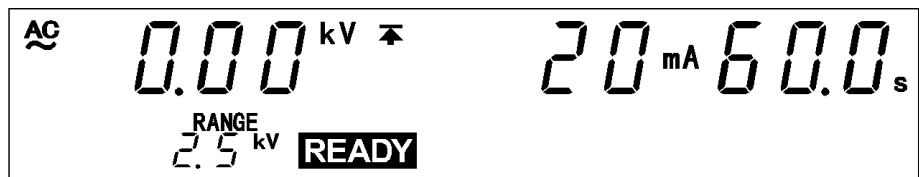

The new parameters following setting are shown below:

Comparative voltage value: 2.00 kV
 Upper limit value: 20 mA
 Lower limit value: OFF
 Test time: 60.0 s
 Output voltage range: 2.5 kV

3.4 Starting a Test

The flowchart below explains how a test is carried out.

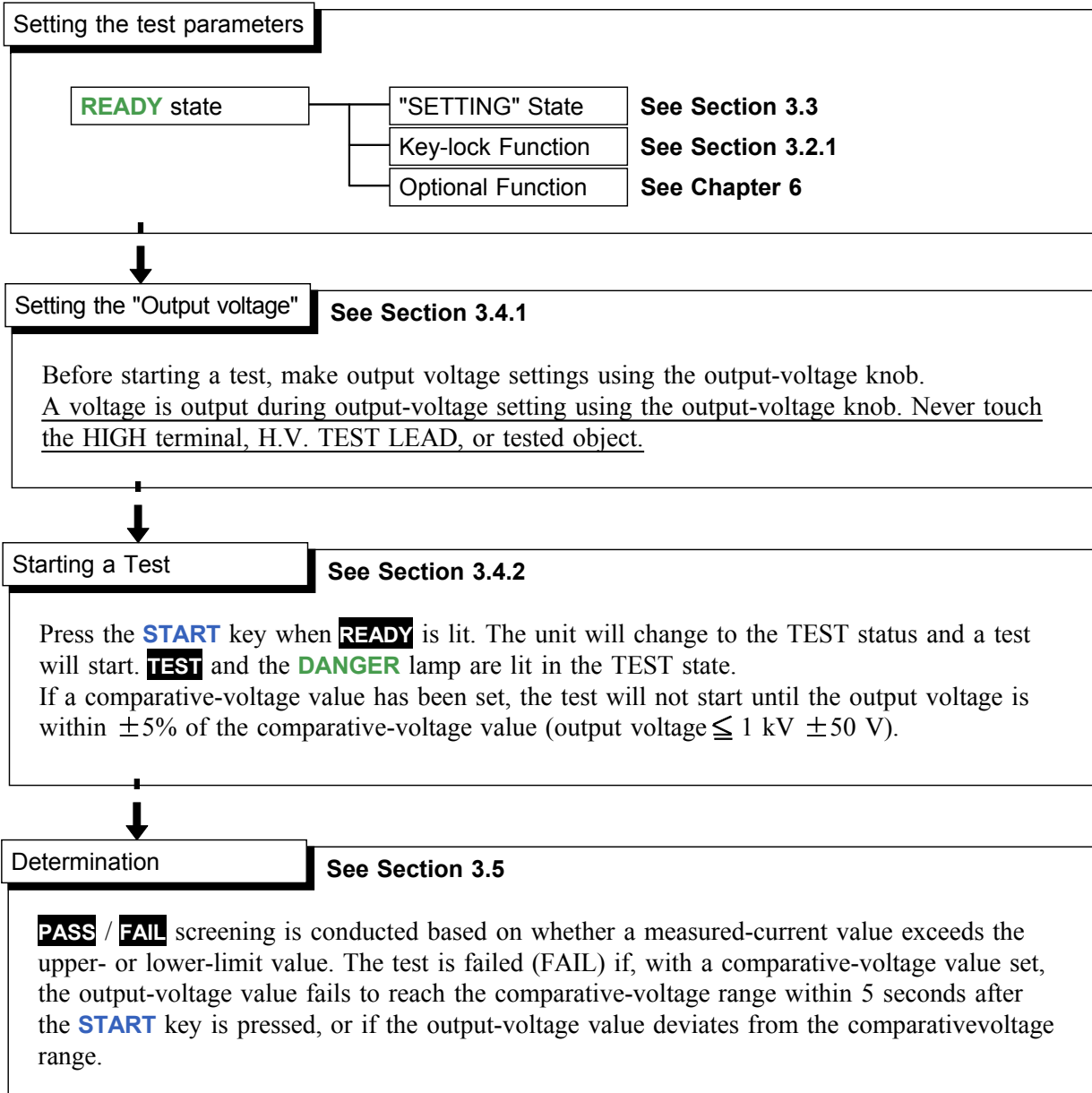

3.4.1 Setting the Output Voltage



Before starting a test, make output voltage settings using the output-voltage knob.



Observe the following precautions to avoid electric shock.

- Make sure that no high voltage is being applied to the output, confirm the following items, and output voltage.
 - (1) The analog voltmeter reads 0 kV.
 - (2) The **DANGER** lamp is OFF.
 - (3) The **READY** lamp is lit (it is off in the Double Action mode).
- A voltage is output during output-voltage setting using the outputvoltage adjustment knob. Never touch the HIGH terminal, H.V. TEST LEAD, or tested object.

1. In accordance with the instructions given in Section 2.8, connect the probe to the tested object.
2. Make sure the analog voltmeter is at 0 kV, the **DANGER** lamp is OFF, and the unit is in the READY state.
3. Press the **START** key. **TEST** will light up and a voltage will be output.
4. Set an output voltage using the output-voltage knob. The output-voltage knob increases the output voltage when turned clockwise, and decreases the voltage when turned counterclockwise.
 - The maximum value is 2.5 kV or 5.0 kV, depending on the output-voltage range set in step 3.3.
 - The output voltage is displayed on the analog voltmeter and the fluorescent indicator.
5. Press the **STOP** key to stop the output.

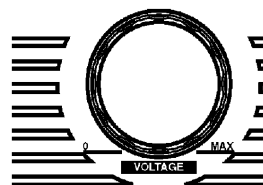
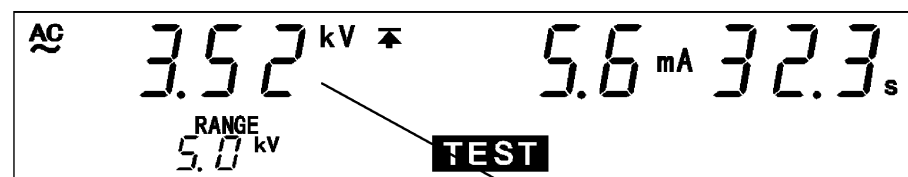

Range Selection Switch

Set an output voltage using the output-voltage knob.

Rated time for output voltages (at an ambient temperature of 40°C)

The transformer capacity of the unit is approximately half the rated output. Use the unit within the rated time. If the rated time is exceeded, the unit may overheat and thereby cause the thermal fuse for the internal circuit to blow out.

Current measurement range	Maximum test time	Pause
$I \leq 60 \text{ mA}$	Continuous	None
$60 \text{ mA} < I \leq 100 \text{ mA}$	30 minutes	30 minutes
$100 \text{ mA} < I \leq 120 \text{ mA}$	10 minutes	30 minutes



If the test time is set to OFF, the comparative-voltage value becomes ineffective, thereby facilitating output-voltage adjustments.

3.4.2 Executing a Test



Observe the following precautions to avoid electric shock.

- Make sure that no high voltage is being applied to the output, confirm the following items, and output voltage.
 - (1) The analog voltmeter reads 0 kV.
 - (2) The **DANGER** lamp is OFF.
 - (3) The **READY** lamp is lit (it is off in the Double Action mode).
- A voltage is output during output-voltage setting using the outputvoltage adjustment knob. Never touch the HIGH terminal, H.V. TEST LEAD, or tested object.

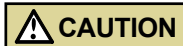

- For output, the unit uses a high-voltage transformer that boosts the power voltage. If an unstable power voltage is used to operate the unit, the tested object may be damaged by the distortion of the output-voltage waveform and by the output of a voltage higher than the preset voltage.
- If a capacity load is applied to the tested object, the output voltage may exceed the preset voltage, thereby damaging the equipment.
- Continuous output of a high voltage may heat the bottom of the unit. Take special care when handling the unit (e.g. transporting the unit).



Priority for control of the **START** key is in the following order: the **START** key on the REMOTE CONTROL BOX, the external I/O, and the front panel of the unit. Connecting the switch signal line plug on the REMOTE CONTROL BOX disables the **START** key on the front panel of the unit and the start signal for the external I/O.

1. Press the **START** key when **READY** is lit.
The unit will change to the TEST status and a test will start. **TEST** and the **DANGER** lamp are lit in the TEST state.
2. If a comparative-voltage value has been set, the test will not start until the output voltage is within $\pm 5\%$ of the comparative-voltage value (output voltage $\leq 1 \text{ kV} \pm 50 \text{ V}$).
3. In a test with a comparative-voltage value set, the test is forcibly terminated when the output voltage deviates by $\pm 5\%$ from the comparative-voltage value (output voltage $\leq 1 \text{ kV} \pm 50 \text{ V}$). In such a case, **UPPER**, **LOWER**, and **FAIL** will light up. Reset the output voltage and restart the test.

To terminate the test, press the **STOP** key. The unit will immediately stop outputting a voltage and switch to the READY state. In such a case, no screening is conducted.

Optional Functions

- You can select whether you want to check the output-voltage when the test starts or ends. (Starting a test with default settings:) (See Section 6.9)
- The FAIL Hold function can be used to hold the effective value at the time of termination of the test using FAIL screening. (See Section 6.2)
- The Hold function can be used to hold the value that was effective at the time of forced termination of the test. (See Section 6.3)

3.4.3 Screening in "TEST" State

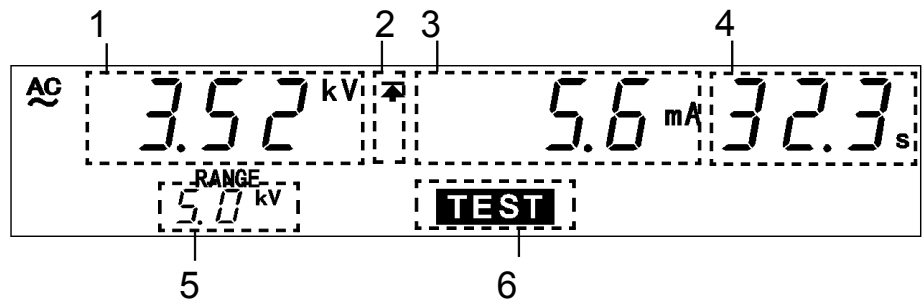

1	Measured voltage value	Indicates the voltage value being output.
2	Upper limit value icon Lower limit value icon	The symbol \blacktriangle appears when the upper limit value is set, and the symbol \blacktriangledown appears when the lower limit value is set.
3	Measured current value	Represent the value of a current flowing between the HIGH and LOW terminals.
4	Test time elapsed	<ul style="list-style-type: none"> • When the testing time is set, countdown starts from the time set, and is displayed. When the testing time is set to OFF, the time elapsed after the start of the test is displayed. • If the elapsed test time exceeds 999 s, "---" is displayed, but the voltage continues to be output.
5	Output voltage range	Indicates the output-voltage range.
6	TEST	TEST flickers for up to five seconds at the start of a test and when the output voltage exceeds the comparative-voltage range.

Danger lamp

Indicates that a voltage is being output. This lamp remains lit as long as a voltage of at least 0.03 kV is being applied to the output terminal in the withstand voltage mode.

Analog voltmeter

Indicates the voltage value being output.

External I/O

The TEST signal is turned ON when **TEST** on the fluorescent indicator lights up. The H.V.ON signal is turned on when the **DANGER** lamp lights up. The two signals are turned OFF at the same time. At the start of a test, the unit waits for up to five seconds for the output voltage to switch to the comparative-voltage range. During this period, **TEST** flickers but the TEST signal is ON. The U-FAIL and L-FAIL signals are turned ON when the output-voltage value deviates from the comparative-voltage value range when **UPPER**, **LOWER**, and **FAIL** are lit.

3.5 PASS or FAIL Determination

3.5.1 "PASS" State



Even when a test has been terminated, there may still be voltage in the output-voltage terminal. Before touching the output-voltage terminal, H.V. TEST LEAD, or tested object, confirm the following items.

- (1) The analog voltmeter reads 0 kV.
- (2) The **DANGER** lamp is OFF.
- (3) The **READY** lamp is lit (it is off in the Double Action mode).

When the preset test time has elapsed, the unit switches to the PASS state and immediately stops outputting a voltage. If the test time has not been set, PASS screening is not performed. To the test, press the **STOP** key, which will forcibly terminate the test.

Optional Functions

- The PASS state is held using the PASS Hold function. (See Section 6.1)
- You can select whether you want to check the output-voltage when the test starts or ends. (When starting a test with default settings) (See Section 6.9)

Flow of PASS determination

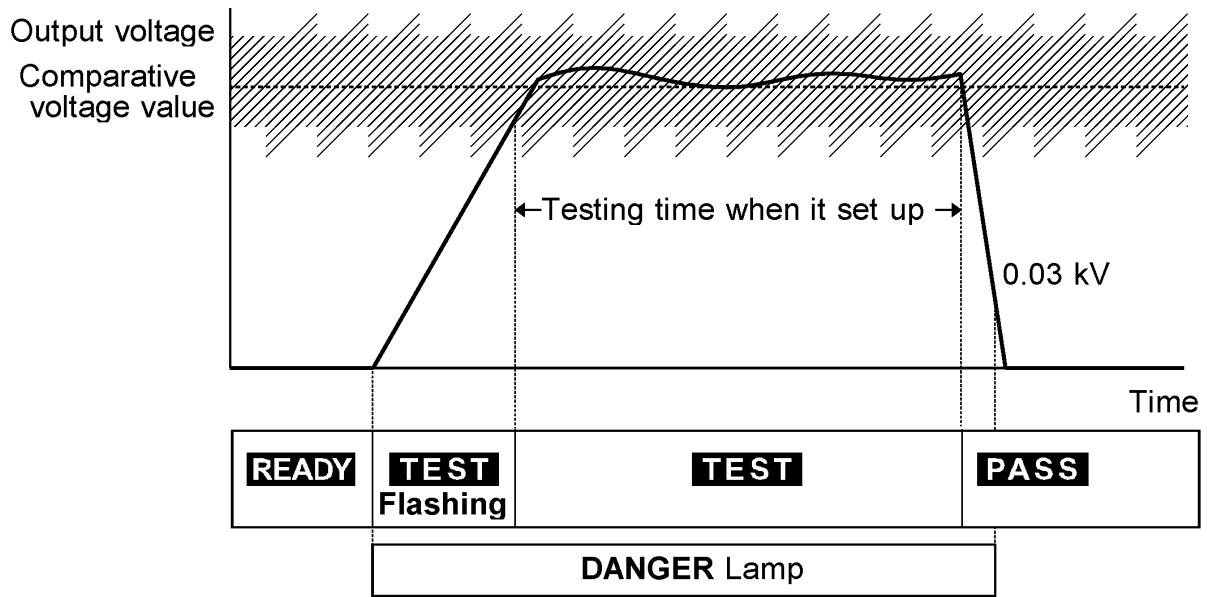

1. Press the **START** key to start a test.
2. If a comparative-voltage value has been set, **TEST** flickers until the output voltage switches to the comparative-voltage range. When the output voltage switches to that range, **TEST** remains lit and the reduction timer begins counting down the test time.
3. A voltage is output until the test time elapses. (If the measured-current value deviates from the upper- and lower-limit values, the unit switches to the FAIL state.
4. When the preset test time has elapsed, the unit stops outputting a voltage and switches to the PASS state. **PASS** lights up in the PASS state.

NOTE

If the optional "Voltage Comparator Position" function is set to "1: End of test time", since the unit shifts to the TEST state whenever voltage is output, **TEST** does not flash before the output-voltage value reaches the comparative-voltage value range.

3.5.2 Screening in "PASS" State

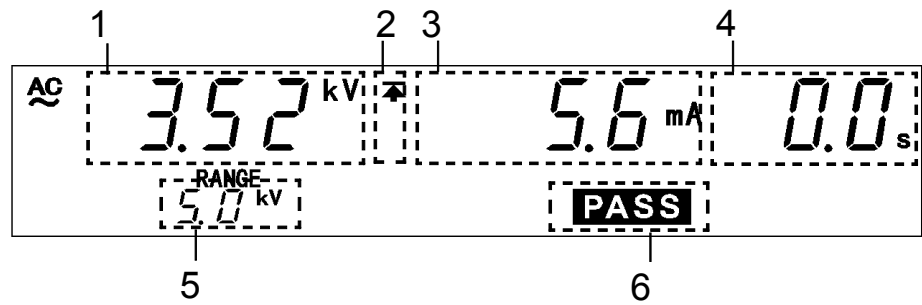

1	Measured voltage value	Indicates the voltage in the PASS state.
2	Upper limit value icon Lower limit value icon	The symbol \blacktriangle appears when the upper limit value is set, and the \blacktriangledown symbol appears when the lower limit value is set.
3	Measured current value	Indicates the value of the current flowing between the HIGH and LOW terminals in the PASS state
4	Test time elapsed	Displays the time in which the test has been completed. In PASS state, "0.0s" is displayed.
5	Output voltage range	Indicates the output-voltage range.
6	PASS	Indicates that the unit is in the PASS state.

Danger lamp

Indicates that a voltage is being output. This lamp remains lit as long as a voltage of at least 0.03 kV is being applied to the output terminal.

Analog voltmeter

Indicates the voltage being output in withstand voltage test. The analog voltmeter is not held even if the PASS Hold function is disabled.
Indicates the voltage value being output.

External I/O

The PASS signal is turned ON when **PASS** on the fluorescent indicator is lit. As long as the PASS state is held, the PASS signal remains ON. The PASS signal is turned OFF when the **PASS** light on the fluorescent indicator goes out. If voltage remains in the output-voltage terminal following termination of a test, the H.V.ON signal remains ON. When the **DANGER** lamp goes out, the H.V.ON signal is immediately turned OFF.

3.5.3 "FAIL" State



Even when a test has been terminated, there may still be voltage in the output-voltage terminal. Before touching the output-voltage terminal, H.V. TEST LEAD, or tested object, confirm the following items.

- (1) The analog voltmeter reads 0 kV.
- (2) The **DANGER** lamp is OFF.
- (3) The **READY** lamp is lit (it is off in the Double Action mode).

If the measured voltage deviates from the upper or lower value during the test, the unit switches to the FAIL state and immediately stops outputting a voltage.

The FAIL state can be divided into UPPER FAIL and LOWER FAIL states. UPPER FAIL indicates that the measured current has exceeded the upperlimit value.

LOWER FAIL indicates that the measured current has dropped below the lower-limit value.

(When the lower-limit value is set to OFF, LOWER FAIL is ineffective.)

With a comparative voltage value set, if the output voltage deviates from the comparative-voltage range, the unit switches to the FAIL state and **UPPER**, **LOWER**, and **FAIL** light up.

Optional Functions

- The FAIL state is held using the FAIL Hold function. (See Section 6.2)
- You can select whether you want to check the output-voltage when the test starts or ends. (When starting a test with default settings) (See Section 6.9)

Flow of FAIL determination

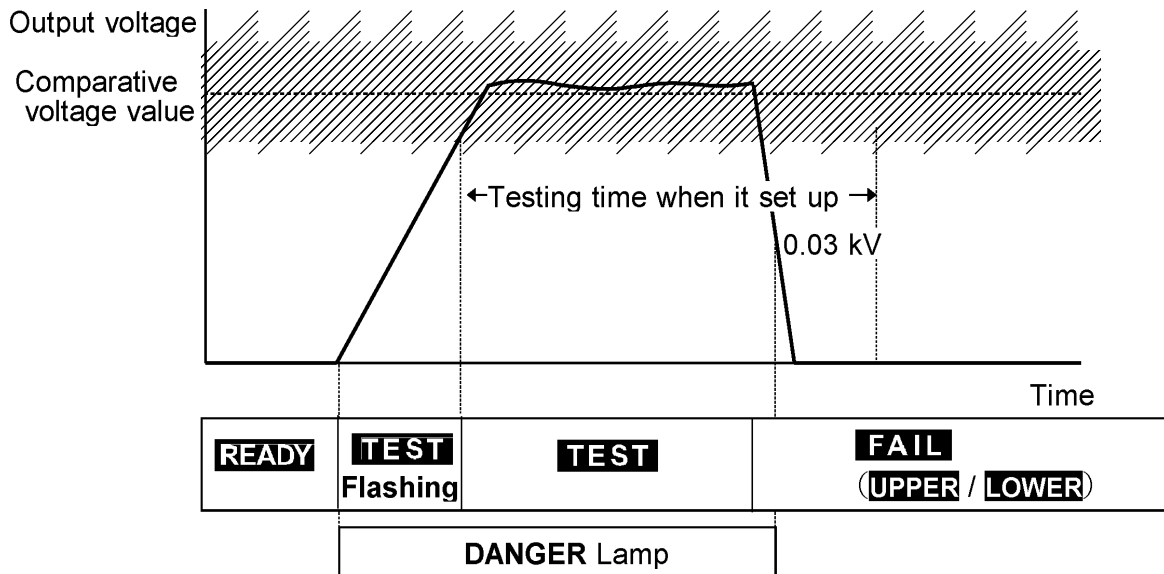

1. Press the **START** key to start a test.
2. When a comparative-voltage value has been set, **TEST** flickers until the output voltage switches to the comparative-voltage range. Once the output voltage switches to this range, **TEST** lights up and the reduction timer begins counting down the test time.
3. A voltage continues to be output until the test time elapses. If the measured current deviates from the upper- or lower-level value during this period, the unit switches to the FAIL state.
4. Once a switch is made to the FAIL state, **FAIL** lights up, together with **UPPER** or **LOWER**. The unit stops outputting a voltage and the reduction timer stops.

NOTE

- If the current generated is several times as large as the upper-limit value, a circuit promptly cuts off the high voltage, thereby switching the unit to **UPPER FAIL**. At this point, an incorrect value for the measured current is displayed.
- If the optional "Voltage Comparator Position" function is set to "1: End of test time", since the unit shifts to the TEST state whenever voltage is output, **TEST** does not flash before the output-voltage value reaches the comparative-voltage value range.

FAIL Screening Using the Comparative-Voltage Value

When the output-voltage value fails to reach the comparative-voltage range:

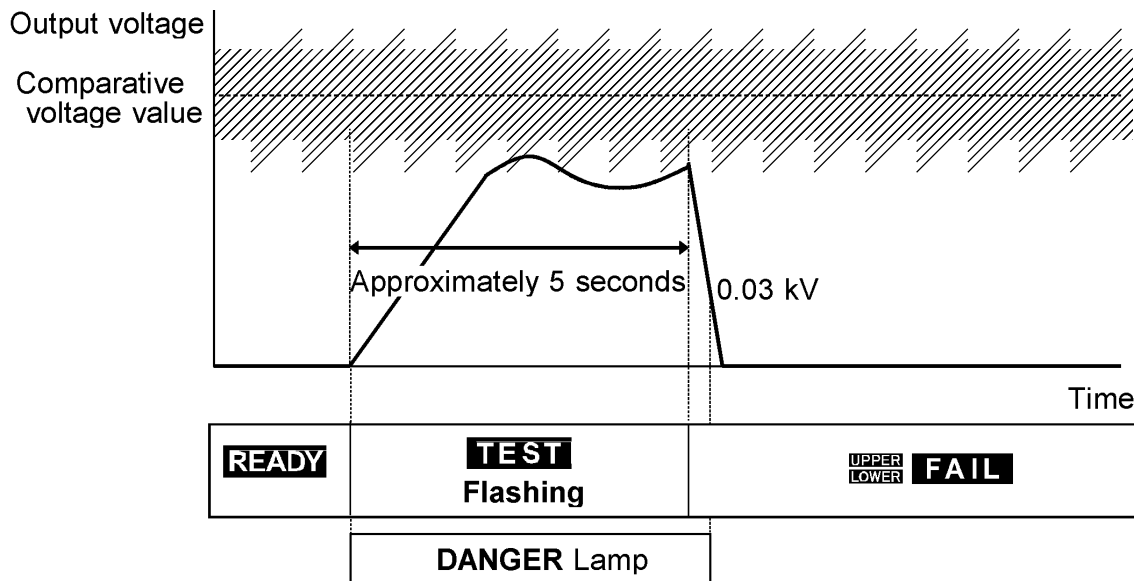

1. Press the **START** key to start a test.
2. **TEST** will flicker until the output voltage switches to the comparative voltage range.
3. If the output voltage fails to switch to this range in 5 seconds, the unit switches to the FAIL state and stops outputting a voltage.
4. In the FAIL state, **UPPER**, **LOWER**, and **FAIL** light up to indicate that an improper voltage has been output.

When the output-voltage deviates from the comparative-voltage range:

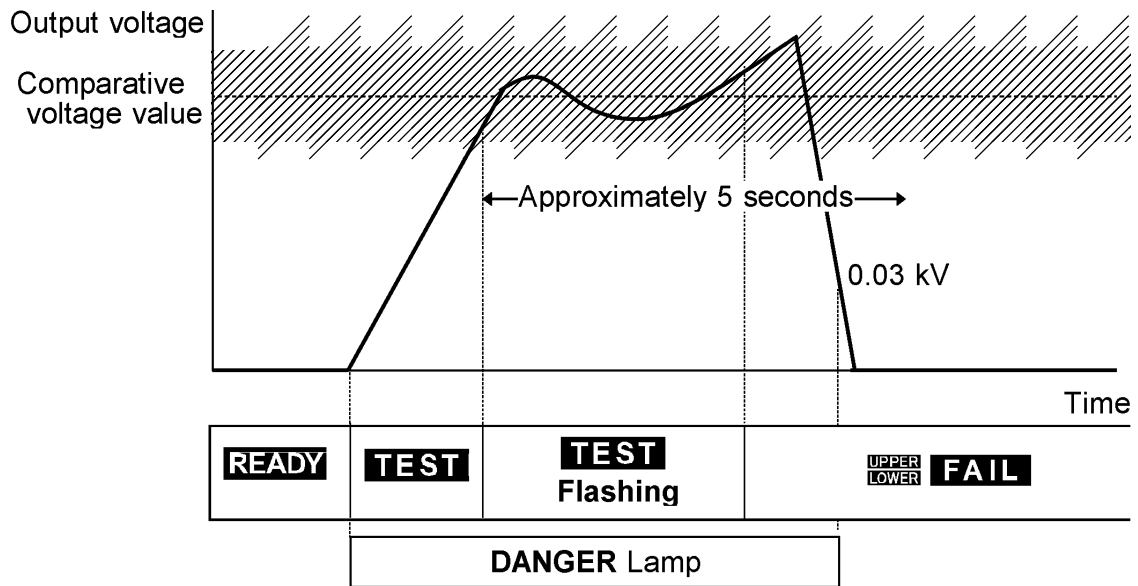



1. Press the **START** key to start a test.
2. **TEST** will flicker until the output voltage switches to the comparative-voltage range.
3. If the output voltage fails to switch to this range in 5 seconds, the unit switches to the FAIL state and stops outputting a voltage.
4. In the FAIL state, **UPPER**, **LOWER**, and **FAIL** light up to indicate that an improper voltage has been output.

NOTE

- If the optional "Voltage Comparator Position" function is set to "**1**: End of test time", since the unit shifts to the TEST state whenever voltage is output, **TEST** does not flash before the output-voltage value reaches the comparative-voltage value range.
- If the optional "Voltage Comparator Position" function is set to "**1**: End of test time", this function checks whether the output voltage is within the standard voltage range only when the test is terminated.

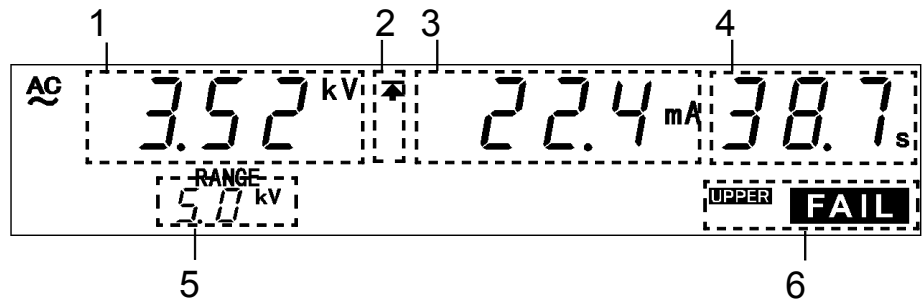
3.5.4 Screening in "FAIL" State



1	Measured voltage value	Indicates the voltage in the FAIL state.
2	Upper limit value icon Lower limit value icon	The symbol  appears when the upper limit value is set, and the symbol  appears when the lower limit value is set.
3	Measured current value	Indicates the current flowing between the HIGH and LOW terminals in the FAIL state.
4	Test completion time	Indicates the time when the unit switched to the FAIL state. If the test time has been set, the remaining test time is displayed. If the test time is set at OFF, the period of time during which a voltage is output is displayed.
5	Output voltage range	Indicates the output-voltage range.
6	FAIL	Indicates that the unit is in the FAIL state. FAIL lights up with UPPER to indicate UPPER FAIL , and with LOWER to indicate LOWER FAIL . If the output voltage deviates from the comparative-voltage range and switches the unit to the FAIL state, UPPER , LOWER , and FAIL light up.

Danger lamp

Indicates that a voltage is being output. This lamp remains lit as long as a voltage of at least 0.03 kV is being applied to the output terminal.

Analog voltmeter

Indicates the voltage being output in withstand voltage test. The analog voltmeter is not held even if the FAIL Hold function is disabled. Indicates the voltage value being output.

External I/O

The W-FAIL signal and either the U-FAIL or L-FAIL signal come on when **FAIL** lights on the fluorescent indicator. If the output-voltage deviates from the comparative-voltage range, both the W-FAIL and U-FAIL signals, as well as the L-FAIL signal are turned ON.

Both the W-FAIL and U-FAIL signals, as well as the L-FAIL signal remain ON as long as the FAIL state is held. The W-FAIL, U-FAIL and L-FAIL signals are turned OFF when the **FAIL** light on the fluorescent indicator goes out. If voltage remains in the output-voltage terminal following the termination of a test, the H.V.ON signal remains ON. When the **DANGER** lamp goes out, the H.V.ON signal is immediately turned OFF.

Chapter 4

Insulation Resistance Mode

Testing Method

4

This chapter describes how to set insulation resistance mode test conditions and the proper testing procedure.

Read Chapter 2, and make the necessary preparations for testing.

Press the I key to enter insulation resistance mode. (The lamp above the key lights.)

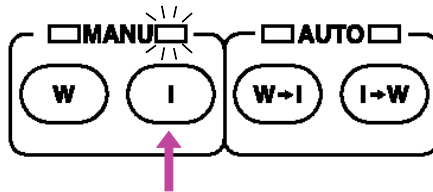

4.1 Insulation Resistance Mode Display

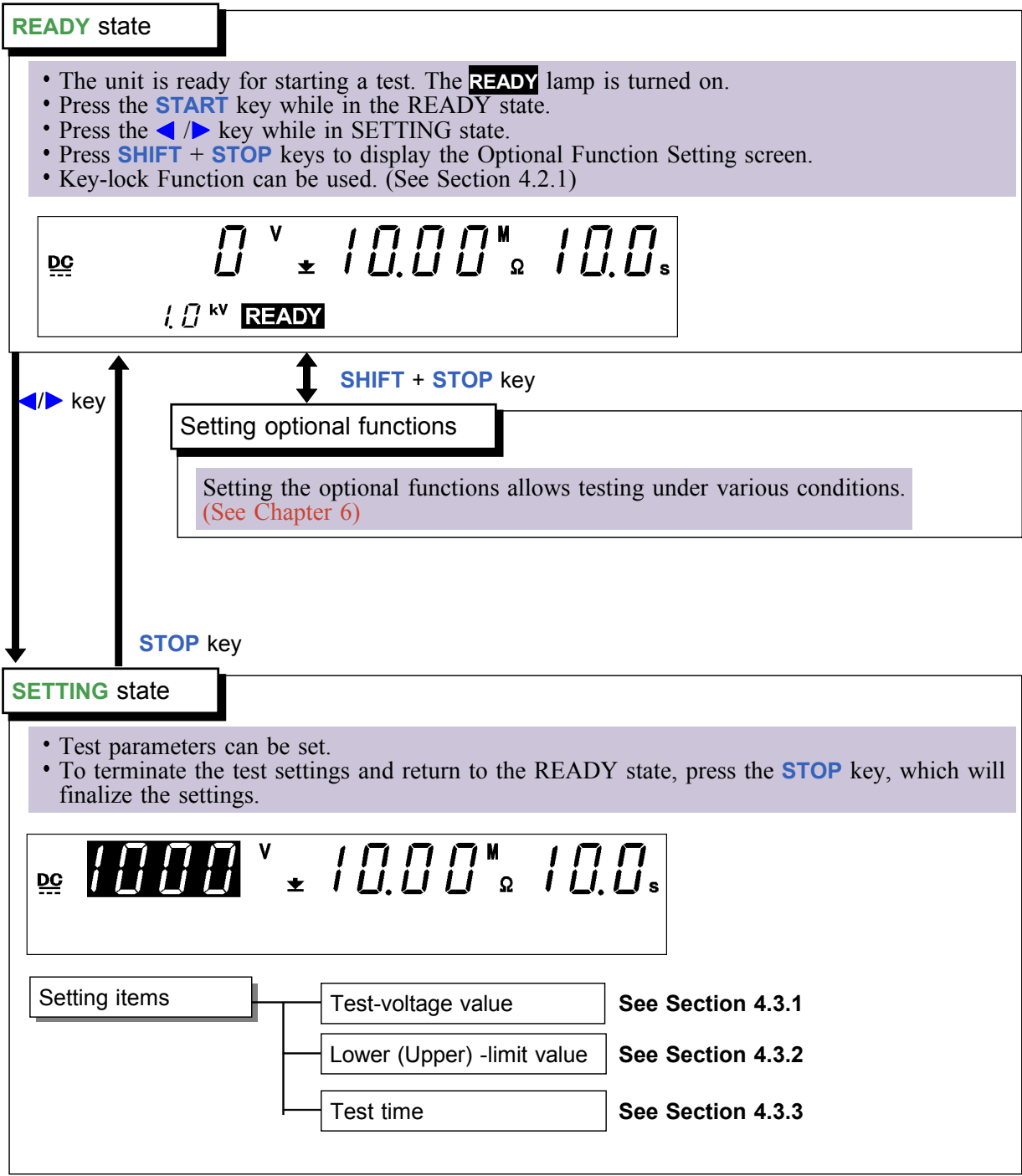

START key

TEST state

See Section 4.4.2

- When the unit is in the TEST state, the **TEST** lamp is lit. This indicates that a test is in progress.
- Compares the upper- and lower-limit measured resistance values. If the measured resistance value deviates from either of these values once the test time has elapsed, the unit shifts to the FAIL state. If the value does not deviate, the unit shifts to the PASS state.
- Press the **STOP** key to forcibly terminate the test.

DC 10 15 V 18.50^M Ω 8.8 s
1.0 kV **TEST**

Key operation in the TEST status

Forced ending

Press the **STOP** key.

4

PASS state

See Section 4.5.1

- **PASS** indicates that the measured object passed the test set in the READY state.
- The **PASS** lamp is turned on. The PASS state screen is displayed for about 0.3 second before switching to the READY state.
- The PASS state can be maintained if the PASS Hold function is disabled in the optional settings. (See Section 6.1)

DC 10 15 V 18.50^M Ω 0.0 s
1.0 kV **PASS**

FAIL state

See Section 4.5.3

- **READY** indicates that the tested object failed to pass the test set in the READY state.
- The **FAIL** lamp will light up, accompanied by **UPPER** if the measured value exceeds the upper-limit value, or by **LOWER** if the measured value is below the lower-limit value.
- The FAIL state can be maintained. To return to the READY state, press the **STOP** key, which will cancel the FAIL Hold function.
- FAIL Hold function can be disabled in the optional settings. The FAIL-state screen is displayed for 0.3 seconds, and the unit then switches to the READY state. (See Section 6.2)

DC 10 15 V 6.23^M Ω 0.0 s
1.0 kV **LOWER FAIL**

4.2 Displaying the READY State

In the READY state, the unit is always ready to start a test. The unit can be shifted to the SETTING state only when it is in the READY state. The **READY** lamp remains lit to indicate the READY state. Saving and loading for setting data and the setting of optional functions are made following the READY state.

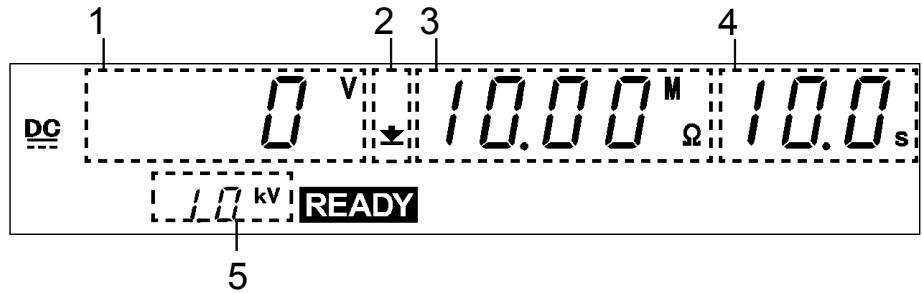

1	Measured voltage value	Indicates the voltage value being output. In the READY state, the value indicates at 0 kV.
2	Upper limit value icon Lower limit value icon	The symbol \blacktriangle appears when the upper limit value is set, and the symbol \blacktriangledown appears when the lower limit value is set.
3	Lower limit value	Indicates Lower limit value.
4	Test time	Indicates the preset test time. "OFF" is indicated when no test-time setting has been made.
5	Output voltage range	Indicates the set test-voltage value.

Danger lamp

Indicates that a voltage is being output. This lamp remains lit as long as a voltage is being applied to the output terminal. It does not light up in the READY state.

Analog voltmeter

Does not move in insulation resistance mode.

External I/O

The READY signal is ON when **READY** is lit on the fluorescent indicator. The READY signal is turned OFF when **READY** is not lit.

Key Operations

◀▶	Displays the SETTING state. (See Section 4.3)
SHIFT + ▶	Displays the set data Save screen. (See Section 7.1)
SHIFT + ◀	Displays the set data Load screen. (See Section 7.2)
SHIFT + STOP	Displays the Optional functions setting screen. (See Chapter 6)
START	Test Start (See Section 4.4)
LOCK	Key-lock function (See Section 4.2.1)

4.2.1 Key-lock Function

It inactivates all keys except the **START** key, **STOP** key, and the range switch. The **KEYLOCK** lamp is lit while the key-lock function is active. Use this function when you do not want to change the test mode or test settings. To switch to the KEY-LOCK state, press the **LOCK** key. The **KEYLOCK** lamp is lit.

To cancel the key-lock function, press the **LOCK** key in the Key-LOCK state while holding down the **SHIFT** key. The **KEYLOCK** lamp is not lit.

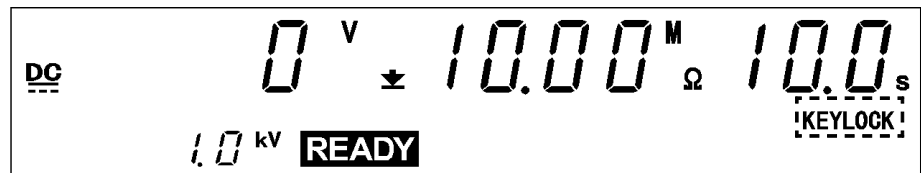

NOTE

Even when the key-lock function is activated, the **START** and **STOP** keys on the REMOTE CONTROL BOX and the start and stop signals on the external I/O terminal remain active.

4.3 "SETTING" State

NOTE

To set or change test settings, switch to the SETTING state.

- In the SETTING state, the **READY** light goes out and tests cannot start.
- In insulation resistance mode, the READY state displays the measured voltage value, whereas the SETTING state displays the test-voltage value. Note that the presence of a test-voltage value does not mean that voltage is being output.

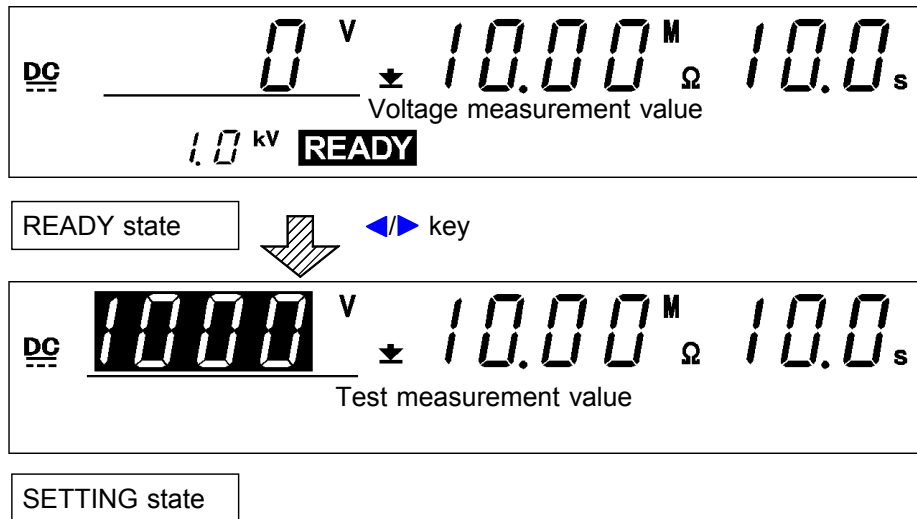

1. In the insulation resistance mode READY state, when you press the **◀▶** keys, the flashing cursor appears where the test-voltage is indicated to show that the unit is in the SETTING state. (The **READY** light goes out and tests cannot start even if the **START** key is pressed.)
2. Use the following operation keys to make settings:
 - ◀▶ key: Move the flashing cursor.
 - ▼▲ key: Change settings.
 - ON/OFF keys: Activate and deactivate values.
 - The flashing cursor moves between the test-voltage value, lower-limit value, upper-limit value, and the test time
 - If the value indicated by the flashing cursor is not needed in the test, turn it OFF using the ON/OFF keys. The lower-limit value and the test-voltage value, however, cannot be turned OFF.
3. To finalize the test settings, press the **STOP** key. The settings are confirmed and the unit returns to the READY state.

NOTE

Note that the unit does not return to the READY state if the lower-limit value is greater than the upper-limit value. In this case, correct the settings and press the **STOP** key to confirm them.

4.3.1 Setting the Test Voltage Value

The test-voltage value can be set to 500 V or 1000 V.

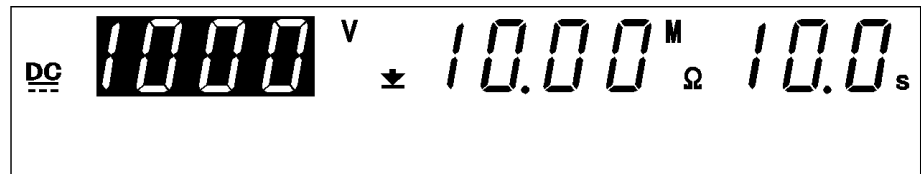

Test-voltage value: 1000 V

1. If no flashing cursor is displayed in the insulation resistance mode READY state, press either the ◀▶ key to display the cursor in the testvoltage value position.
2. Change the test-voltage value using the ▼/▲ keys. The test-voltage value can be set to 500 V or 1000 V.
3. To finalize the test settings, press the **STOP** key. The settings are confirmed and the unit returns to the READY state.

4.3.2 Setting the Lower (Upper) Limit Value

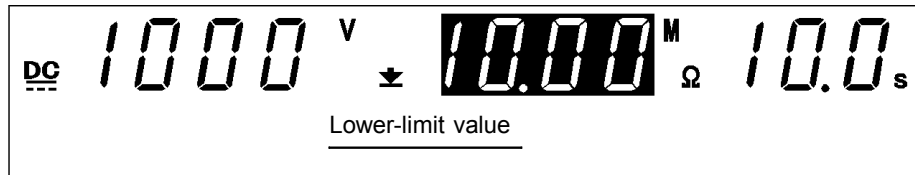

Lower Limit Value: 10 MΩ

1. If no flashing cursor is displayed in the insulation resistance mode READY state, press either the $\blacktriangleleft/\blacktriangleright$ key to display the cursor in the lower (upper) limit value position.
2. Set the lower (upper) limit value using the $\blacktriangledown/\blacktriangle$ keys. The lower(upper)-limit value increases for each setting resolution function shown in the list below.
Press the keys, **SHIFT** + $\blacktriangledown/\blacktriangle$ key. The value increases or decreases 10 times more rapidly than when the **SHIFT** key is not held down. The lower (upper)-limit value can be set between 0.2 and 2000 MΩ. If no Upper limit value is required, turn off the **ON/OFF** key. Lower limit value can not be turn off.
3. To finalize the test settings, press the **STOP** key. The settings are confirmed and the unit returns to the READY state.

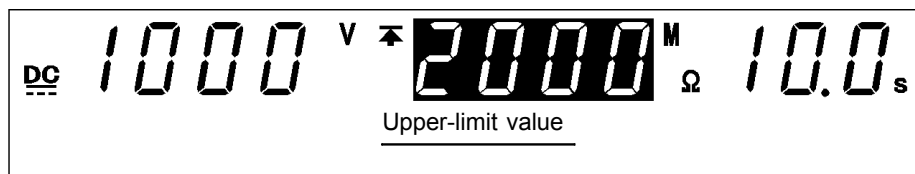

Upper-limit value: 2000 MΩ

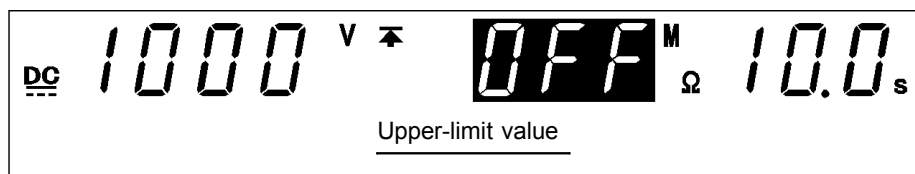

Upper-limit value: OFF

NOTE

- If the lower-limit value is greater than the upper-limit value, the unit does not return to the READY state even when the **STOP** key is pressed. In this case, correct the upper- or lower-limit value.
- The measured resistance and measurement ranges depend on the set upper-limit and test-voltage values.
- Resistance values larger than 2000 MΩ are displayed as "O.F." (overflow).

Upper- or lower-value

Setting range (M Ω)	Setting resolution (M Ω)
0.20 to 2.00	0.01
2.10 to 20.0	0.1
21.0 to 200	1
210 to 2000	10

Items related to test voltages, lower-limit values and ranges, and measurement ranges

Test voltage (V)	Lower-value (M Ω)	Range	Measurement range (M Ω)
500	0.20 to 2.00	2 M Ω	0.17 to 10.0 ^{*1}
	2.10 to 20.0	20 M Ω	1.70 to 100
	21.0 to 200	200 M Ω	17.0 to 1000
	210 to 2000	2000 M Ω	170 to 2200 ^{*2}
1000	0.20 to 4.00	4 M Ω	0.01 to 20.0 ^{*3}
	4.10 to 40.0	40 M Ω	3.40 to 200
	41.0 to 400	400 M Ω	34.0 to 2000
	410 to 2000	2000 M Ω	340 to 2200 ^{*2}

*1 The range from 0.17 to 0.49 is outside the guaranteed range of accuracy.

*2 The range from 2001 to 2200 is outside the guaranteed range of accuracy.

*3 The range from 0.01 to 0.99 is outside the guaranteed range of accuracy.

When the resistance value exceeds the measurement range, it is displayed as "**O.F.**" (overflow).

When the set resistance value does not reach the measurement range, values are displayed on the "**U.F.**" (underflow).

Optional Functions

You can make the low measurement range a fixed range or an automatic range, depending on the optional function settings. (See Section 6.10)

4.3.3 Setting the Test Time

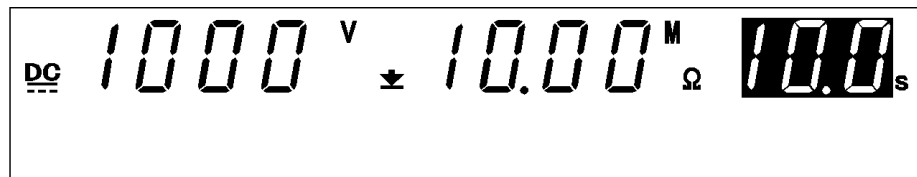

Test Time: 10.0 s

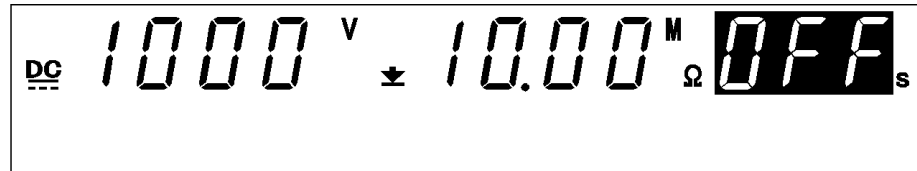

Test Time: OFF

1. If no flashing cursor is displayed in the insulation resistance mode READY state, press either the ◀/▶ key to display the cursor in the test time position.
2. Set the test time using the ▼/▲ keys.
 With time set the time changes in 0.1 s increments (1 s increments when the set time scale is 100 s to 999 s).
 With time set at 0.5 s to 99.9 s, press **SHIFT** + ▼/▲ keys. The time changes in 1.0 s increments (10 s increments when the set time scale is 100 s to 999 s).
 Settings may be made along a scale ranging from 0.5 s to 999 s.
 If no testing time is required, turn off the **ON/OFF** key.
3. To finalize the test settings, press the **STOP** key. The settings are confirmed and the unit returns to the READY state.

NOTE

- Screening is not conducted for insulation resistance tests when the test time is set to OFF.
- If the test time is set to OFF, the time elapsed during the test is displayed. When this time exceeds 999 s, "---" will appear, but the test will continue.
- The setting resolution of the test time is 0.1 s between 0.5 and 99.9 s, and becomes 1 s between 100 and 999 s.
- If a test time has been set, the reduction timer will operate during the test.
- Screening is not performed for the first 0.5 s of the test.
- When Auto Range is set (see Section 6.10), it takes approximately 1.3 s for the range to stabilize after the test starts. When the set test time is shorter than this, the test results in a LOWER FAIL.

Optional Functions

When the test time is set, the test can be terminated before the set test time for PASS or FAIL determination has elapsed depending on optional function settings. (See Section 6.11)

4.3.4 Examples of Settings

This section describes the procedure for making withstand voltage test settings under the following conditions.

Test voltage value: 500 V
 Upper limit value: 100 M Ω
 Lower limit value: OFF
 Test time: 5.0 s

The 3159 is in the READY state in insulation resistance mode.

Values currently set		➔	Values to be set	
Test voltage value	1000 V		Test voltage value	500 V
Lower limit value	10.0 M Ω		Lower limit value	100 M Ω
Upper limit value	2000 M Ω		Upper limit value	OFF
Test time	20.0 s		Test time	5.0 s

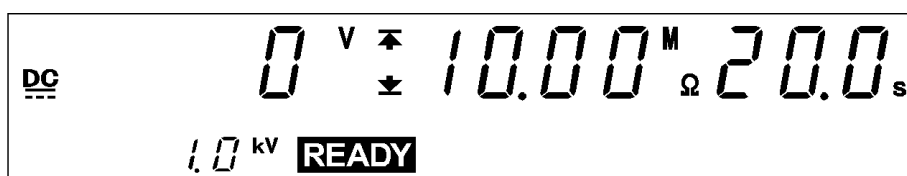

(1) Changing to the SETTING state

Press the $\blacktriangleleft/\blacktriangleright$ keys to switch to the SETTING state. The **READY** light will go out, and the flashing cursor will be displayed at the position where the test-voltage value is indicated.

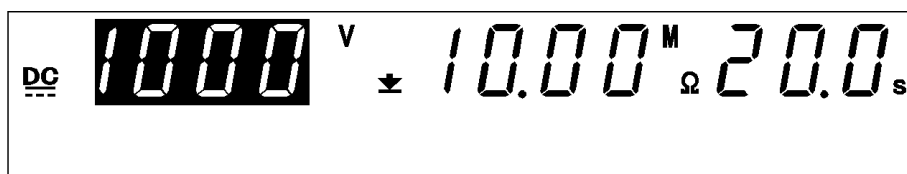

In the READY state, a measured-voltage value is displayed. In the SETTING state, the display changes to the test-voltage value (in this example, 1000 V).

(2) Setting the test-voltage value

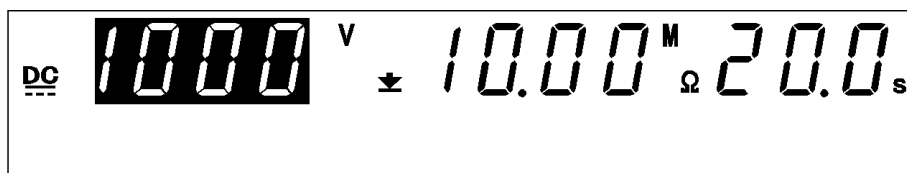

In this example, the value is 1000 V.

Using the ▼/▲ keys, set the comparative voltage value to **500 V**.

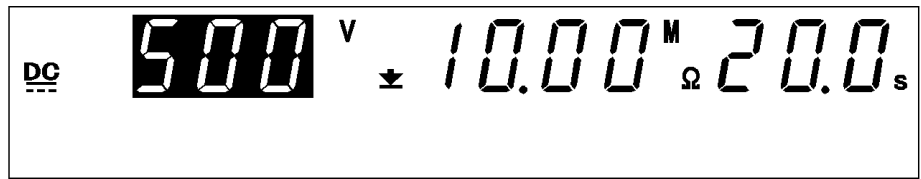

(3) Setting an lower-limit value

Press the ► key to move the flashing cursor to the lower-limit value.

In this example, switch from **10.0 MΩ** to **100 MΩ** using the ▼/▲ keys.

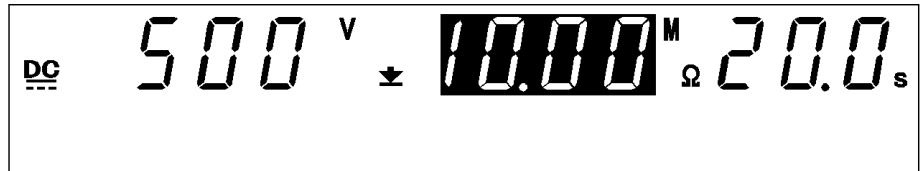

To change the lower limit value, press ▼/▲ keys.

Press the keys, **SHIFT** + ▼/▲ key. The value increases or decreases 10 times more rapidly than when the **SHIFT** key is not held down.

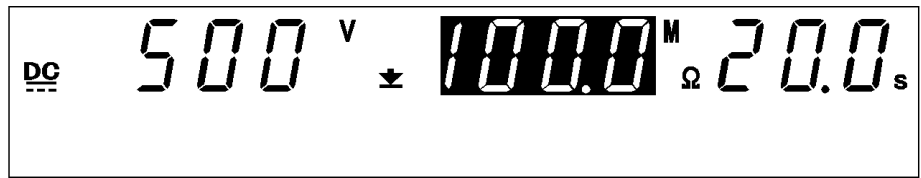

(4) Setting an upper-limit value

Using the ► key, move the flashing cursor to the upper limit value.



The upper-limit value is set at **2000 MΩ**. Turn it **OFF**, as it is not needed. To change to **OFF**, press the **ON/OFF** key.

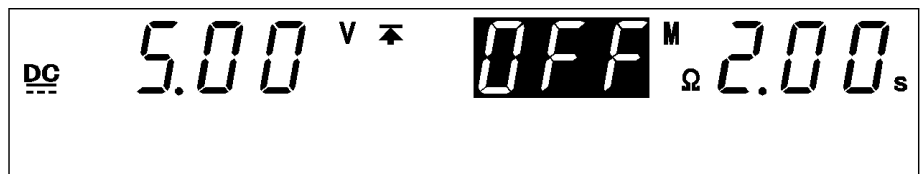

(5) Setting the test time

Using the ► key, move the flashing cursor to the test time.

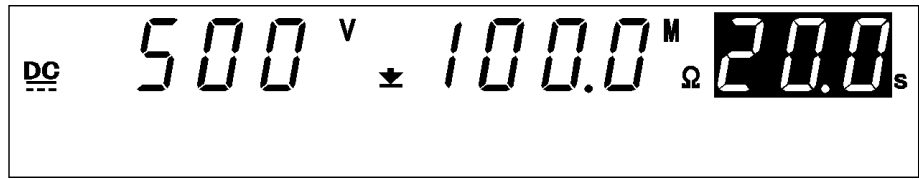

In this example, change the test time from 20.0 s to 5.0 s.

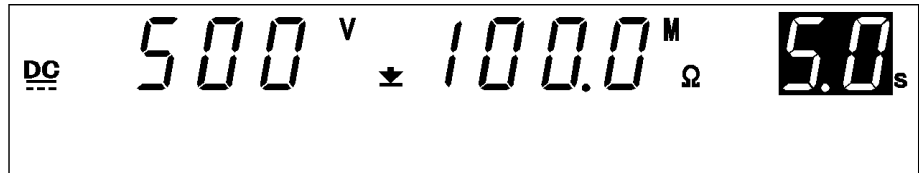

(6) Changing to the READY state

To return to the READY state, press the STOP key, which will finalize the test settings. In the READY state, the displayed test-voltage value is replaced with a measured-voltage value, and **READY** lights up. The test-voltage value is shown below.

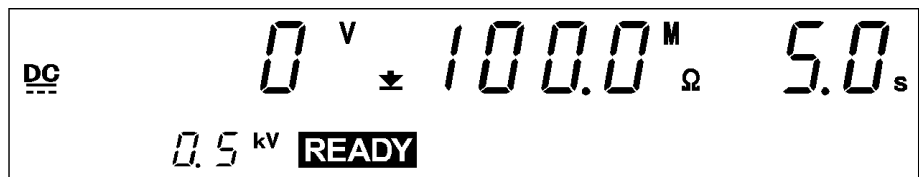

The new parameters following setting are shown below:

Test voltage value: 500 V
 Upper limit value: 100 MΩ
 Lower limit value: OFF
 Test time: 5.0 s

4.4 Starting a Test

The flowchart below explains how a test is carried out.

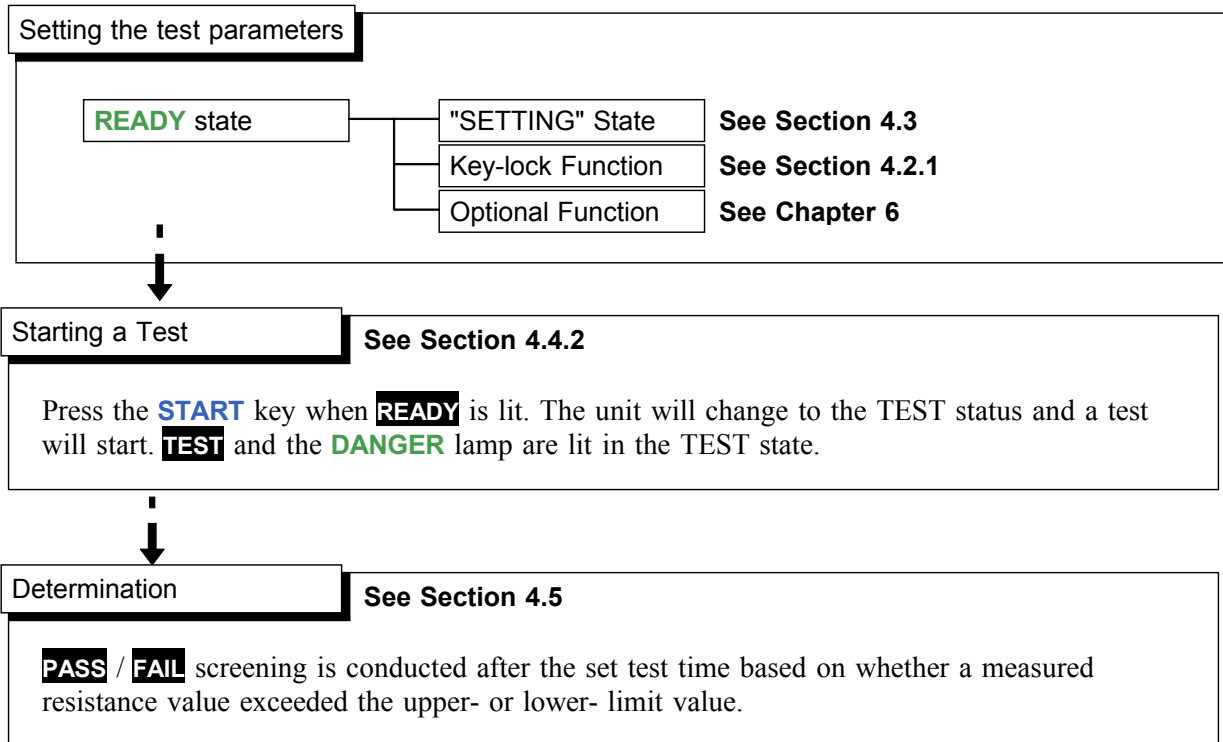

4.4.1 Executing a Test



To avoid electric shock, make sure that no high voltage is being applied to the output, confirm the following items, and output voltage.

- (1) The analog voltmeter reads 0 kV.
- (2) The **DANGER** lamp is OFF.
- (3) The **READY** lamp is lit (it is off in the Double Action mode).



Priority for control of the **START** key is in the following order: the **START** key on the REMOTE CONTROL BOX, the external I/O, and the front panel of the unit. Connecting the switch signal line plug on the REMOTE CONTROL BOX disables the START key on the front panel of the unit and the start signal for the external I/O.

1. Press the **START** key when **READY** is lit.
The unit will change to the TEST status and a test will start. TEST and the **DANGER** lamp are lit in the **TEST** state.
2. To terminate the test, press the STOP key. The unit will immediately stop outputting a voltage and switch to the READY state. In such a case, no screening is conducted.

Optional Functions

The Hold function can be used to hold the value that was effective at the time of forced termination of the test. (See Section 6.3)

4.4.2 Screening in "TEST" State

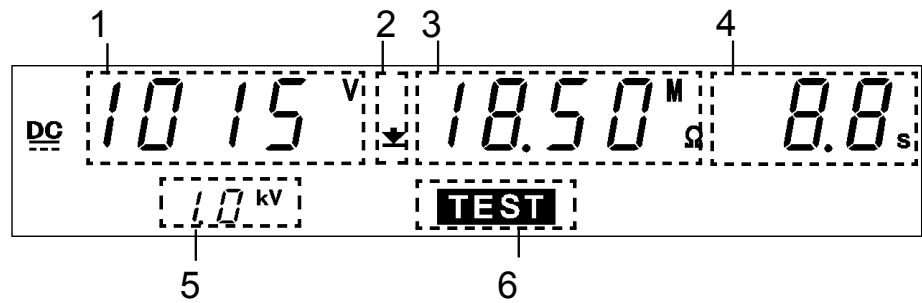

1	Measured voltage value	Indicates the voltage value being output.
2	Upper limit value icon Lower limit value icon	The symbol \uparrow appears when the upper limit value is set, and the symbol \downarrow appears when the lower limit value is set.
3	Measured resistance value	Represent the value of a resistance flowing between the HIGH and LOW terminals.
4	Test time elapsed	<ul style="list-style-type: none"> When the testing time is set, countdown starts from the time set, and is displayed. When the testing time is set to OFF, the time elapsed after the start of the test is displayed. If the elapsed test time exceeds 999 s, "---" is displayed, but the voltage continues to be output.
5	Test voltage range	Indicates the test-voltage value.
6	TEST	Remains lit during the test.

Danger lamp

Indicates that a voltage is being output. This lamp remains lit as long as a voltage of at least 50 V is being applied to the output terminal in the insulation resistance mode.

Analog voltmeter

Does not move in insulation resistance mode.

External I/O

The TEST signal is turned ON when **TEST** on the fluorescent indicator lights up. The H.V.ON signal is turned on when the **DANGER** lamp lights up. The two signals are turned OFF at the same time.

4.5 PASS or FAIL Determination

4.5.1 "PASS" State



Even when a test has been terminated, there may still be voltage in the output-voltage terminal. Before touching the output-voltage terminal, H.V. TEST LEAD, or tested object, confirm the following items.

- (1) The analog voltmeter reads 0 kV.
- (2) The **DANGER** lamp is OFF.
- (3) The **READY** lamp is lit (it is off in the Double Action mode).

When the preset test time has elapsed, and the measured resistance value exceeds the lower-limit value, or falls below the upper-limit value, the unit switches to the PASS state. The unit switches to the PASS state and immediately stops outputting a voltage.

If the test time has not been set, PASS screening is not performed. To the test, press the **STOP** key, which will forcibly terminate the test.

Optional Functions

- The PASS state is held using the PASS Hold function. (See Section 6.1)
- If the test time is set, the test can be forcibly terminated when the measured resistance value enters the PASS range before the preset time has elapsed. This is convenient when testing objects that contains capacity loads. (See Section 6.11)

Flow of PASS determination

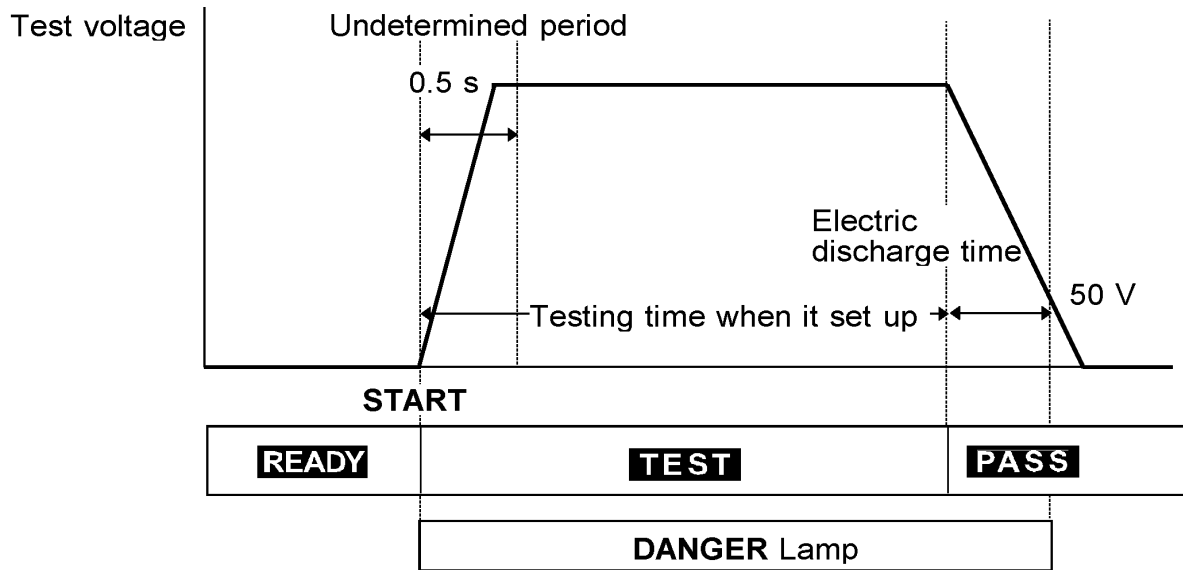

1. Press the **START** key to start a test.
2. A voltage is output until the test time elapses and the resistance is measured.
3. When the preset test time has elapsed and the measured resistance value is within the upper- and lower-limit values, the unit stops outputting a voltage and switches to the PASS state. **PASS** lights up in the PASS state.

4.5.2 Screening in "PASS" State

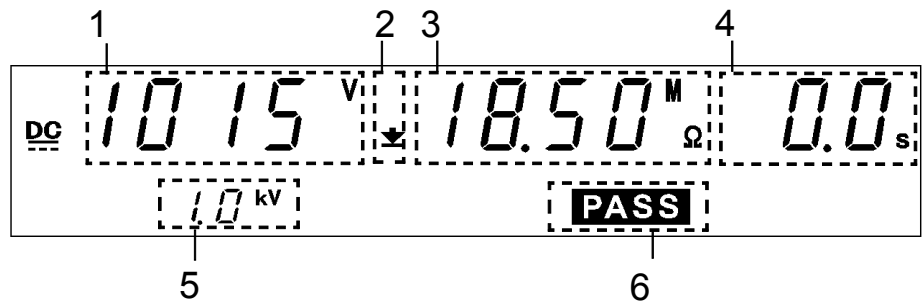

1	Measured voltage value	Indicates the voltage in the PASS state.
2	Upper limit value icon Lower limit value icon	The symbol \blacktriangle appears when the upper limit value is set, and the symbol \blacktriangledown appears when the lower limit value is set.
3	Measured resistance value	Indicates the measured resistance value in the PASS state.
4	Test time elapsed	"0.0s" is displayed.
5	Test voltage range	Indicates the test-voltage value.
6	PASS	Indicates that the unit is in the PASS state.

Danger lamp

Indicates that a voltage is being output. This lamp remains lit as long as a voltage is being applied to the output terminal.

Analog voltmeter

Does not move in insulation resistance mode.

External I/O

The PASS signal is turned ON when **PASS** on the fluorescent indicator is lit. As long as the PASS state is held, the PASS signal remains ON. The PASS signal is turned OFF when the **PASS** light on the fluorescent indicator goes out. If voltage remains in the output-voltage terminal following termination of a test, the H.V.ON signal remains ON. When the **DANGER** lamp goes out, the H.V.ON signal is immediately turned OFF.

4.5.3 "FAIL" State



Even when a test has been terminated, there may still be voltage in the output-voltage terminal. Before touching the output-voltage terminal, H.V. TEST LEAD, or tested object, confirm the following items.

- (1) The analog voltmeter reads 0 kV.
- (2) The **DANGER** lamp is OFF.
- (3) The **READY** lamp is lit (it is off in the Double Action mode).

When the preset test time has elapsed, the unit switches to the FAIL state and immediately stops outputting a voltage if the measured resistance value deviates from the upper or lower limit value during the test. The FAIL state can be divided into UPPER FAIL and LOWER FAIL states.

UPPER FAIL indicates that the measured resistance has exceeded the upperlimit value.

LOWER FAIL indicates that the measured resistance has dropped below the lower-limit value. (When the lower-limit value is set to OFF, LOWER FAIL is ineffective.) If the test time has not been set, PASS screening is not performed. To the test, press the STOP key, which will forcibly terminate the test.

Optional Functions

- The FAIL state is held using the FAIL Hold function. (See Section 6.2)
- If the test time is set, the test can be forcibly terminated when the measured resistance value enters the PASS range before the preset time has elapsed. This is convenient when testing objects that contains capacity loads. (See Section 6.11)

Flow of FAIL determination

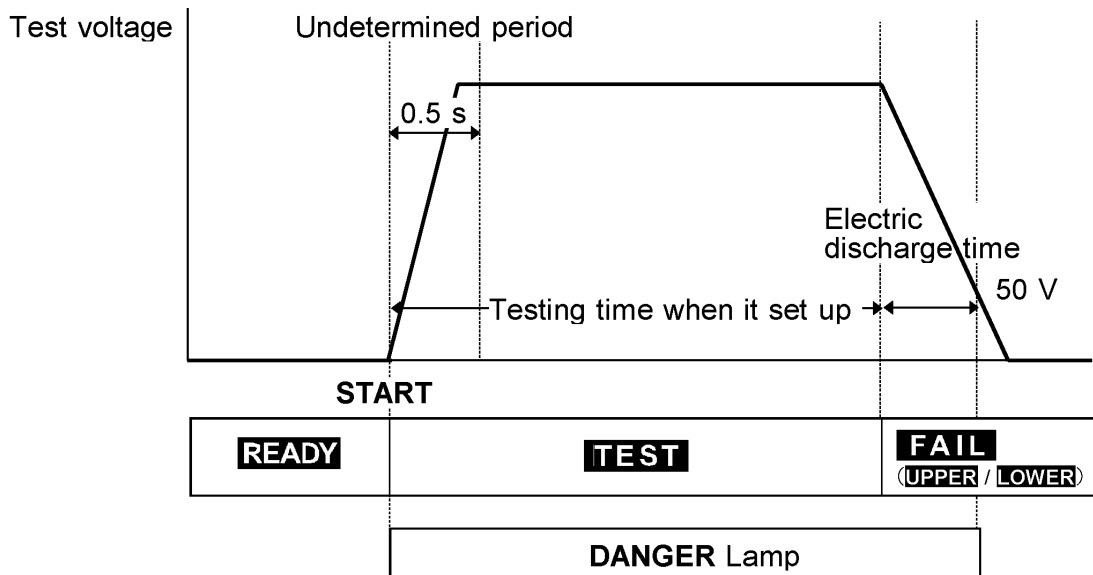

1. Press the **START** key to start a test.
2. A voltage continues to be output until the test time elapses and measure resistance.
3. When the preset test time has elapsed, and the measured resistance value deviates from the upper- or lower-limit value, the unit stops outputting a voltage and switches to the FAIL state. **FAIL** lights up in the FAIL state together with **LOWER** or **UPPER**.

NOTE

- When the optional "Insulation Resistance Measurement Range" function is set to "1: Auto Range", it takes up to 1.3 s to display the resistance value. When the test finishes before the preset test time, the test results in a **LOWER FAIL**.
- Setting an upper-limit value while using a fixed range restricts the range of resistance that can be measured. Therefore, even if a resistance value lower than the preset upper-limit value is measured, "O.F." is displayed resulting in an UPPER FAIL. (See Section 4.3.2)

4.5.4 Screening in "FAIL" State

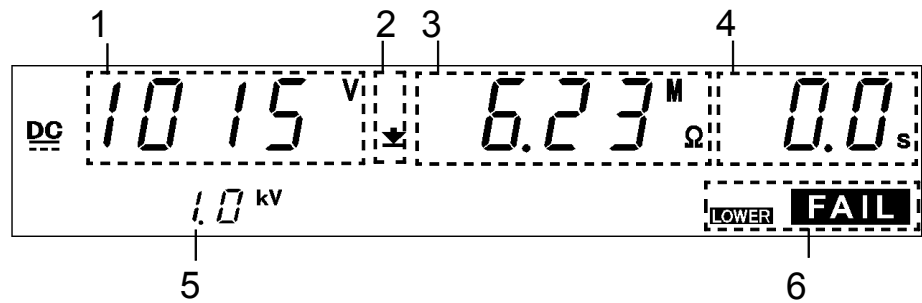

1	Measured voltage value	Indicates the voltage in the FAIL state.
2	Upper limit value icon Lower limit value icon	The symbol \uparrow appears when the upper limit value is set, and the \downarrow symbol appears when the lower limit value is set.
3	Measured resistance value	Indicates the measured resistance value in the FAIL state.
4	Test completion time	"0.0s" is displayed.
5	Test voltage range	Indicates the test-voltage value.
6	FAIL	Indicates that the unit is in the FAIL state. FAIL lights up with UPPER to indicate UPPER FAIL, and with LOWER to indicate LOWER FAIL.

Danger lamp

Indicates that a voltage is being output. This lamp remains lit as long as a voltage is being applied to the output terminal.

Analog voltmeter

Does not move in insulation resistance mode.

External I/O

The I-FAIL signal and either the U-FAIL or L-FAIL signal come on when **FAIL** lights on the fluorescent indicator.

Both the I-FAIL and U-FAIL signals, as well as the L-FAIL signal remain ON as long as the FAIL state is held. The I-FAIL, U-FAIL and L-FAIL signals are turned OFF when the FAIL light on the fluorescent indicator goes out.

If voltage remains in the output-voltage terminal following the termination of a test, the H.V.ON signal remains ON. When the **DANGER** lamp goes out, the H.V.ON signal is immediately turned OFF.

4.6 About the Auto Discharge Function

When measuring a test object that contains a capacity component, the load continues to discharge during insulation resistance measurement and this may cause electric shocks.

This unit is equipped with a function that discharges the remaining load upon termination of insulation resistance tests. (Discharge resistance: 0.8 M Ω)

The unit automatically switches to the internal discharge circuit upon termination of a test and the load is discharged. (When the **DANGER** lamp is lit:) If the voltage drops below 50 V, the **DANGER** lamp goes out. The larger the capacity, the longer it takes to discharge the test object.



The test is terminated and the unit does not shift to the READY state until the **DANGER** lamp goes out. Furthermore, all key operations are invalid until the unit returns to the READY state.

Chapter 5

Auto Test Mode Testing Method

This chapter describes how to set auto test mode test conditions and the proper testing procedure.

Read Chapter 2, and make the necessary preparations for testing.

This mode has two types:

(1) W→I mode

Tests for withstand voltage, then insulation resistance.

Flashing

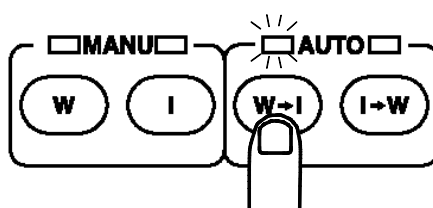

(2) I→W mode

Tests for insulation resistance, then withstand voltage.

Flashing

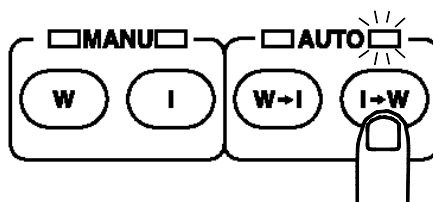

NOTE

- Note that the output waveform may be distorted when conducting an AC withstand voltage test for a voltage-dependent device or object (e.g., ceramic capacitor). Excessively large distortion may damage the device or tested object.
- When the device or tested object is a capacitive load, resonance may occur (when conducting an AC withstand voltage test) with the coil inductance of the output high-voltage transformer, depending on the capacitance value. This condition may generate several tens of volts at the voltage output terminal before the test is started. If the START key is disabled, reset the output voltage knob to zero, then set it back to the desired voltage after starting the test.

5.1 Withstand Voltage Mode Display

READY state

- The unit is ready for starting a test. The **READY** lamp is turned on.
- W→I (Withstand Voltage test→Insulation Resistance test) mode: the unit is in the READY state for withstand voltage testing.

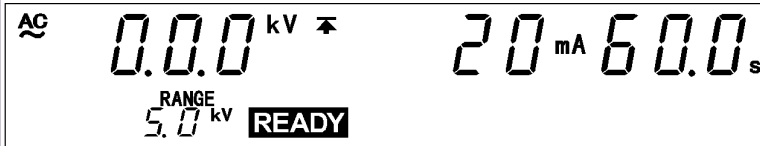

- I→W (Insulation Resistance test→Withstand voltage test) mode: the unit is in the READY state for insulation resistance testing.

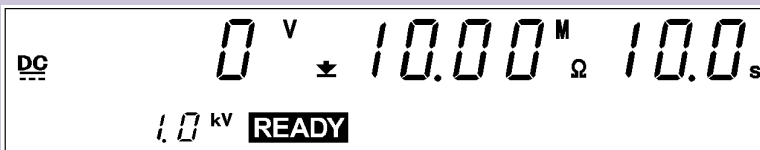

- Press the **START** key while in the READY state.
- Press **SHIFT + STOP** keys to display the Optional Function Setting screen.
- Key-lock Function can be used. (See Section 5.2.1)

W→I/I→W key

SHIFT + STOP key

Setting optional functions

Setting the optional functions allows testing under various conditions.
(See Chapter 6)

Withstand voltage mode READY state

- To make test settings, withstand voltage mode must be in the SETTING state.
- For details on settings, see Chapter 3, "Withstand Voltage Mode Testing Method."
- Make sure you set a test time.

Insulation resistance mode READY state

- To make test settings, insulation resistance mode must be in the SETTING state.
- For details on settings, see Chapter 4, "Insulation Resistance Mode Testing Method."
- Make sure you set a test time.

START key**TEST** state

See Section 5.4.2

- When the unit is in the TEST state, the **TEST** lamp is lit. This indicates that a test is in progress.
- When performing a withstand voltage test, compares the measured voltage value and the measured current value set in withstand voltage mode SETTING state. If the measured value deviates from either of these values, the unit terminates the test and switches to the FAIL state.
- When performing an insulation resistance test, compares the measured resistance value and the value set in the insulation resistance mode SETTING state. If the value deviates from either of these values once the test time has elapsed, the unit shifts to the FAIL state.
- If both the voltage and insulation resistance tests are passed, the unit switches to the PASS state.
- Press the **STOP** key to forcibly terminate the test.

Key operation in the TEST status

Forced ending

Press the **STOP** key.**5****PASS** state

See Section 5.5.1

- Indicates that both the voltage and insulation resistance tests were passed. **PASS** lights up.
- The **PASS** lamp is turned on. The PASS state screen is displayed for about 0.3 second before switching to the READY state.
- The PASS state can be maintained if the PASS Hold function is disabled in the optional settings. (See Section 6.1)

FAIL state

See Section 5.5.3

- Indicates that either the withstand voltage or insulation resistance test was failed.
- When performing a withstand voltage test, if the measured current value deviates from the upper-limit value, **UPPER** and **FAIL** light up. If the measured current value deviates from the lower-limit value, **LOWER** and **FAIL** light up.
- When performing a withstand voltage test, if the measured voltage value deviates from the set voltage value, **UPPER** and **LOWER** light up together with **FAIL**.
- When performing an insulation resistance test, if the measured resistance value deviates from the lower-limit value, **LOWER** and **FAIL** light up. If the resistance value deviates from the upper-limit value, **UPPER** and **FAIL** light up.
- The FAIL state can be maintained. To return to the READY state, press the **STOP** key, which will cancel the FAIL Hold function.
- FAIL Hold function can be disabled in the optional settings. The FAIL-state screen is displayed for 0.3 seconds, and the unit then switches to the READY state. (See Section 6.2)

5.2 Displaying the READY State

In the READY state, the unit is always ready to start a test. The unit can be shifted to the SETTING state only when it is in the READY state. You can make settings for each test type in a variety of modes.

(See Chapter 3 and Chapter 4)

The settings for W → I mode are the same as those for withstand voltage mode. (See Section 3.2)

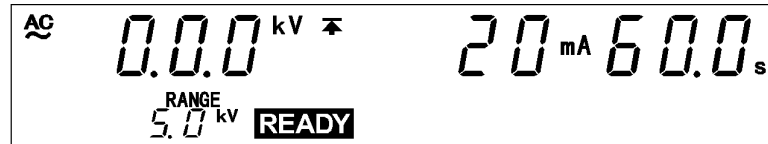

The settings for I → W mode are the same as those for insulation resistance mode. (See Section 4.2)

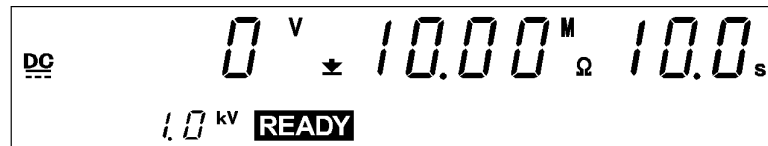

Danger lamp

Indicates that a voltage is being output. This lamp remains lit as long as a voltage is being applied to the output terminal. It does not light up in the READY state.

Analog voltmeter

Indicates the voltage value being output in withstand voltage test. In the READY state, the value remains at 0 kV. Does not move in insulation resistance mode.

External I/O

The READY signal is ON when **READY** is lit on the fluorescent indicator. The READY signal is turned OFF when **READY** is not lit.

Key Operations

SHIFT + STOP	Displays the Optional functions setting screen. (See Chapter 6)
START	Test Start (See Section 5.4)
LOCK	Key-lock function (See Section 5.2.1)

5.2.1 Key-lock Function

It inactivates all keys except the **START** key, **STOP** key, and the range switch. The **KEYLOCK** lamp is lit while the key-lock function is active.

Use this function when you do not want to change the test mode or test settings.

To switch to the KEY-LOCK state, press the **LOCK** key. The **KEYLOCK** lamp is lit.

To cancel the key-lock function, press the **LOCK** key in the Key-LOCK state while holding down the **SHIFT** key. The **KEYLOCK** lamp is not lit.

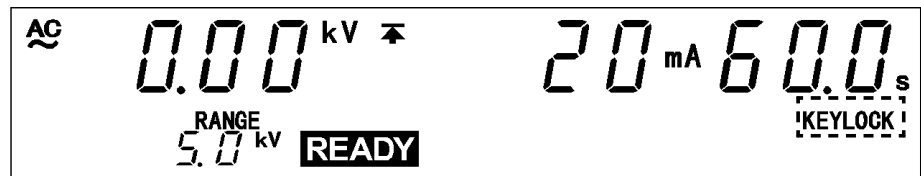

5

NOTE

Even when the key-lock function is activated, the **START** and **STOP** keys on the REMOTE CONTROL BOX and the start and stop signals on the external I/O terminal remain active.

5.3 "SETTING" State

In Auto test mode, test settings cannot be changed. To change test settings, the withstand voltage and insulation resistance modes must be in the SETTING state. (See Section 3.3 and 4.3)

After you have made the various test settings, select Auto test mode.

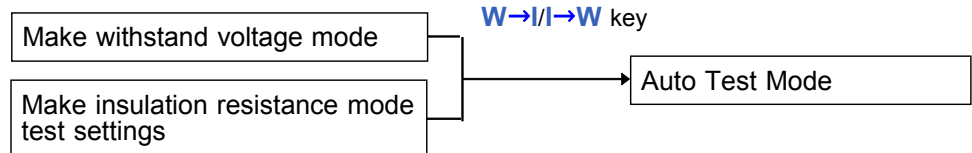

NOTE

When using withstand voltage or insulation resistance mode, if the test time is set to OFF and Auto test mode is selected, the test mode for which test time is switched OFF is displayed, and "OFF" flashes. In this case, the test cannot be started because the unit is not in the READY state (READY is not lit). Return to withstand voltage or insulation resistance mode, and set the test time to ON.

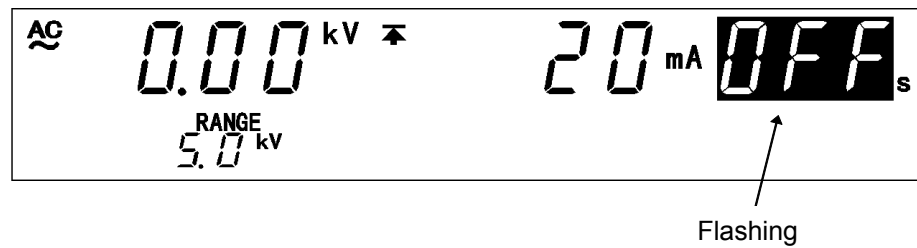

5.4 Starting a Test

The flowchart below explains how a test is carried out.

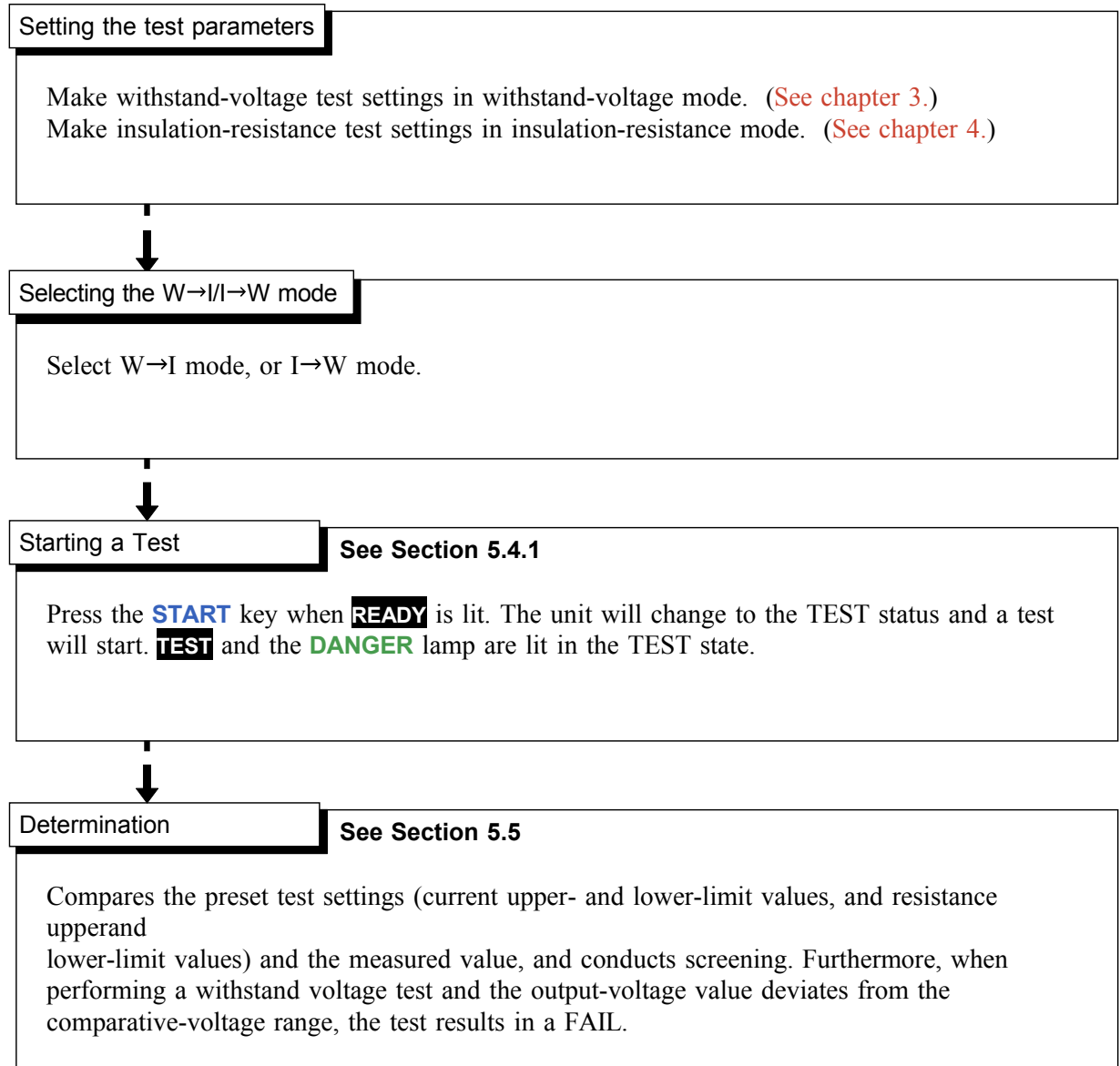

5.4.1 Executing a Test



To avoid electric shock, make sure that no high voltage is being applied to the output, confirm the following items, and output voltage.

- (1) The analog voltmeter reads 0 kV.
- (2) The **DANGER** lamp is OFF.
- (3) The **READY** lamp is lit (it is off in the Double Action mode).



Priority for control of the **START** key is in the following order: the **START** key on the REMOTE CONTROL BOX, the external I/O, and the front panel of the unit. Connecting the switch signal line plug on the REMOTE CONTROL BOX disables the **START** key on the front panel of the unit and the start signal for the external I/O.

1. Press the **START** key when **READY** is lit.
The unit will change to the **TEST** status and a test will start. **TEST** and the **DANGER** lamp are lit in the **TEST** state.
2. To terminate the test, press the **STOP** key. The unit will immediately stop outputting a voltage and switch to the **READY** state. In such a case, no screening is conducted.

Optional Functions

- The Hold function can be used to hold the value that was effective at the time of forced termination of the test. (See Section 6.3)
- If the **W** or **I** key is pressed when the Hold function is enabled, you can view the next test result.

5.4.2 Screening in "TEST State"

(1) When performing a withstand voltage test:

Similar to the withstand voltage mode TEST state. (See Section 3.4.3)

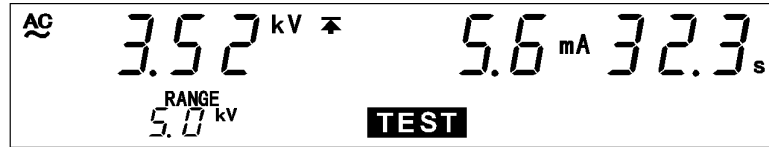

(2) When performing an insulation resistance test:

Similar to the insulation resistance mode TEST state. (See Section 4.4.2)

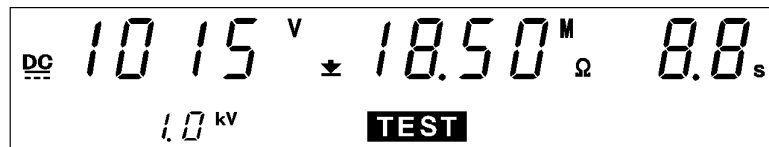

Danger lamp

Indicates that a voltage is being output. This lamp remains lit as long as a voltage of at least 0.03 kV is being applied to the output terminal in the withstand voltage test.

This lamp remains lit as long as a voltage of at least 50 V is being applied to the output terminal in the insulation resistance test.

Analog voltmeter

Indicates the voltage being output in withstand voltage test. The analog voltmeter is not held even if the PASS Hold function is disabled. Does not move in insulation resistance test.

External I/O

The TEST signal is turned ON when **TEST** on the fluorescent indicator lights up. The H.V.ON signal is turned on when the **DANGER** lamp lights up. The two signals are turned OFF at the same time. At the start of a test, the unit waits for up to five seconds for the output voltage to switch to the comparative-voltage range. During this period, **TEST** flickers but the TEST signal is ON. The U-FAIL and L-FAIL signals are turned ON when the output-voltage value deviates from the comparative-voltage value range when **UPPER**, **LOWER**, and **FAIL** are lit.

5.5 PASS or FAIL Determination

5.5.1 "PASS" State



Even when a test has been terminated, there may still be voltage in the output-voltage terminal. Before touching the output-voltage terminal, H.V. TEST LEAD, or tested object, confirm the following items.

- (1) The analog voltmeter reads 0 kV.
- (2) The **DANGER** lamp is OFF.
- (3) The **READY** lamp is lit (it is off in the Double Action mode).

When the preset test time has elapsed, the unit switches to the PASS state and immediately stops outputting a voltage.

To the test, press the **STOP** key, which will forcibly terminate the test.

Optional Functions

- The PASS state is held using the PASS Hold function. (See Section 6.1)
- If the **W** or **I** key is pressed when the Hold function is enabled, you can view the next test result.

Flow of PASS determination

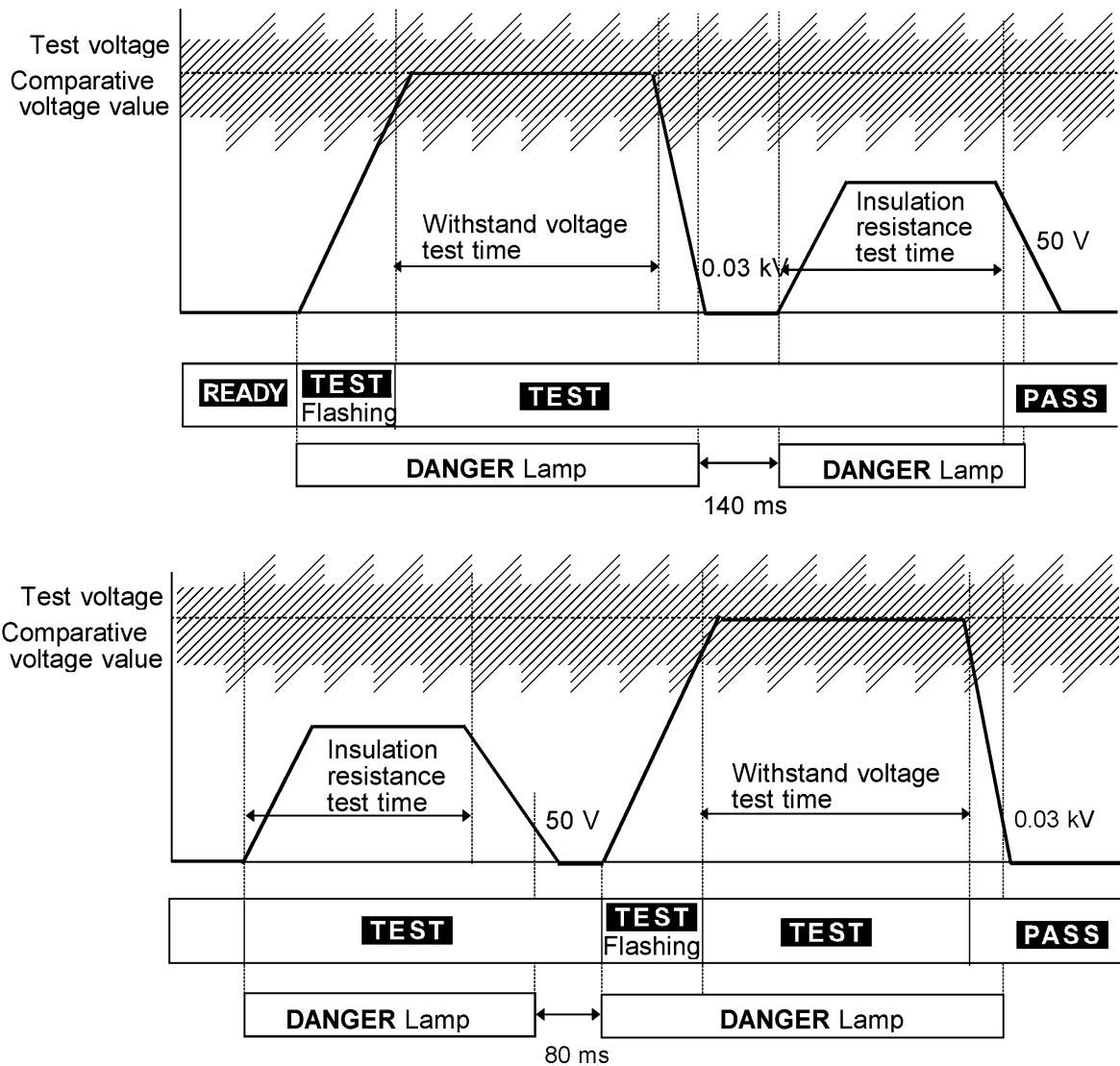

1. Press the **START** key to start a test.
2. In W→I mode, the test order is Withstand voltage test → Insulation Resistance; in I→W mode, the test order is Insulation Resistance test → Withstand voltage test.
3. If both tests clear the test settings, the unit stops outputting a voltage and switches to the PASS state. **PASS** lights up in the PASS state.

5.5.2 Screening in "PASS" State

(1) W→I mode

Similar to the insulation resistance mode TEST state. (See Section 4.5.2)

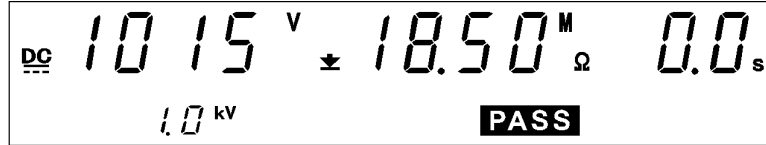

(2) I→W mode

Similar to the withstand voltage mode TEST state. (See Section 3.5.2)

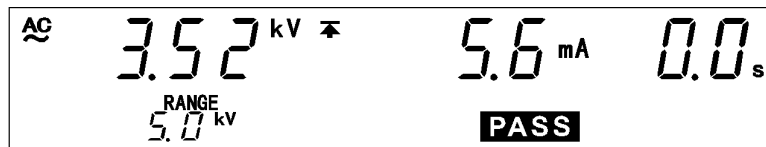

Danger lamp

Indicates that a voltage is being output. This lamp remains lit as long as a voltage is being applied to the output terminal.

Analog voltmeter

Indicates the voltage being output in withstand voltage test. The analog voltmeter is not held even if the PASS Hold function is disabled.

Does not move in insulation resistance mode.

External I/O

The PASS signal is turned ON when **PASS** on the fluorescent indicator is lit. As long as the PASS state is held, the PASS signal remains ON. The PASS signal is turned OFF when the **PASS** light on the fluorescent indicator goes out. If voltage remains in the output-voltage terminal following termination of a test, the H.V.ON signal remains ON. When the **DANGER** lamp goes out, the H.V.ON signal is immediately turned OFF. If the voltage drops below 0.03 kV when performing a withstand voltage test, or below 50 V when performing an insulation resistance test, the **DANGER** lamp goes out.

5.5.3 "FAIL" State



Even when a test has been terminated, there may still be voltage in the output-voltage terminal. Before touching the output-voltage terminal, H.V. TEST LEAD, or tested object, confirm the following items.

- (1) The analog voltmeter reads 0 kV.
- (2) The **DANGER** lamp is OFF.
- (3) The **READY** lamp is lit (it is off in the Double Action mode).

If the measured voltage deviates from the upper or lower value during the test, the unit switches to the FAIL state and immediately stops outputting a voltage. The FAIL state can be divided into UPPER FAIL and LOWER FAIL states.

UPPER FAIL indicates that the measured current or measured resistance has exceeded the upper-limit value.

LOWER FAIL indicates that the measured current or measured resistance has dropped below the lower-limit value.

With a comparative voltage value set, if the output voltage deviates from the comparative-voltage range, the unit switches to the FAIL state and **UPPER**, **LOWER**, and **FAIL** light up.

Optional Functions

- You can select whether you want to check the output-voltage when the test starts or ends. (When starting a test with default settings)
(See Section 6.9)
- The FAIL state is held using the FAIL Hold function. (See Section 6.2)
- If the **W** or **I** key is pressed when the Hold function is enabled, you can view the next test result.

Flow of FAIL determination

1. Press the **START** key to start a test.
2. Perform a withstand-voltage and insulation-resistance test.
3. When the measured current or measured resistance values deviate from the preset test settings, the unit stops outputting a voltage and switches to the FAIL state. **FAIL** lights up in the FAIL state together with **LOWER** or **UPPER**.

NOTE

- If a current double to the preset upper-limit value is detected while performing a withstand voltage test, the voltage is immediately blocked by the insulation circuit, resulting in an UPPER FAIL. In such cases, the measured current value is not displayed correctly.
- When the optional "Insulation Resistance Measurement Range" function is set to "1: Auto Range", it takes up to 1.3 s to display the resistance value. When the test finishes before the preset test time, the test results in a LOWER FAIL.
- Setting an upper-limit value while using a fixed range restricts the range of resistance that can be measured. Therefore, even if a resistance value lower than the preset upper-limit value is measured, O.F. is displayed resulting in an UPPER FAIL. (See Section 4.3.2)

5.5.4 Screening in "FAIL" State

(1) When performing a withstand voltage test:

Similar to the withstand voltage mode TEST state. (See Section 3.5.4)

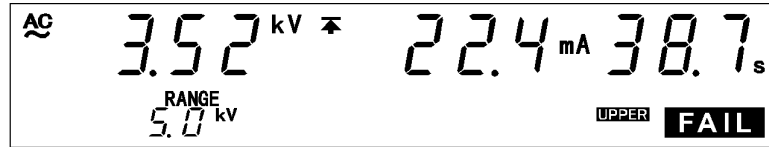

(2) When performing an insulation resistance test:

Similar to the insulation resistance mode TEST state. (See Section 4.5.4)

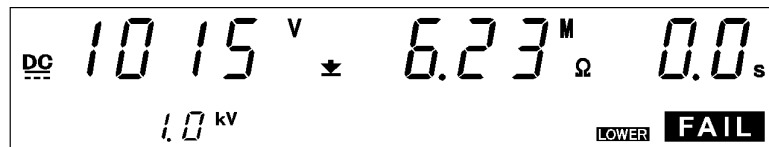

Danger lamp

Indicates that a voltage is being output. This lamp remains lit as long as a voltage is being applied to the output terminal.

Analog voltmeter

Indicates the voltage being output in withstand voltage test. The analog voltmeter is not held even if the FAIL Hold function is disabled. Does not move in insulation resistance test.

External I/O

The W-FAIL or I-FAIL signals are turned on when **FAIL** appears on the fluorescent indicator, and the U-FAIL or L-FAIL signals also.

The W-FAIL signal or both the L-FAIL and U-FAIL signals, as well as the L-FAIL signal remain ON as long as the FAIL state is held. The W-FAIL signal or the I-FAIL, U-FAIL, and L-FAIL signals are turned OFF when **FAIL** goes out on the fluorescent indicator.

If voltage remains in the output-voltage terminal following the termination of a test, the H.V.ON signal remains ON. When the **DANGER** lamp goes out, the H.V.ON signal is immediately turned OFF.

5.6 Auto Discharge Function for insulation resistance Tests

When measuring a test object that contains a capacity component, the load continues to discharge during insulation resistance measurement and this may cause electric shocks.

This unit is equipped with a function that discharges the remaining load upon termination of insulation resistance tests. (Discharge resistance: 0.8 M Ω) The unit automatically switches to the internal discharge circuit upon termination of a test and the load is discharged. (When the **DANGER** lamp is lit:) If the voltage drops below 50 V, the **DANGER** lamp goes out. The larger the capacity, the longer it takes to discharge the test object.

NOTE

- When using I \rightarrow W mode, if the voltage between the output terminals does not drop below 50 V when the unit terminates the insulation resistance test and switches to the withstand voltage test, the withstand voltage test does not start. If the test object contains a capacity component, it takes time for the unit to switch to the next test.
- The test is terminated and the unit does not shift to the READY state until the **DANGER** lamp goes out. Furthermore, all key operations are invalid until the unit returns to the READY state.

Chapter 6

Optional Functions

Setting the optional functions allows testing under various conditions. Settings can be made for the following eleven optional functions. One number is assigned to each function. Settings are made by changing the number by moving the cursor key.

(1) Accessing and Exiting the Optional Function Settings Screen

Press **SHIFT** + **STOP** keys while in READY state to display the Optional function setting screen. One number is assigned to each function. Modifying settings is achieved by moving the cursor key and changing the desired number.

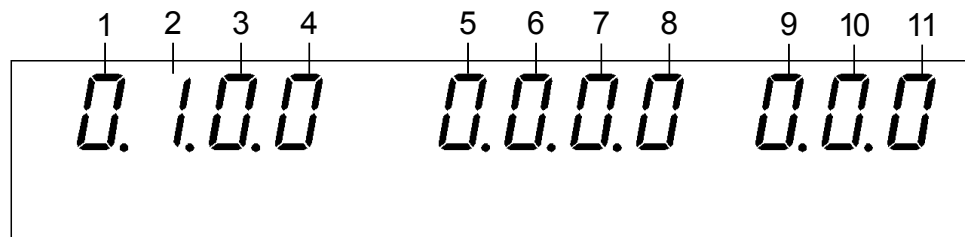

(2) Setting optional functions

1. Use the **◀▶** keys to move the flashing cursor to the target function.
2. Use the **▼▲** keys to set a value at the flashing cursor location.
3. To complete the optional settings, press **SHIFT** + **STOP** keys. The unit reverts to the READY state.

1	PASS hold function This function retains PASS state to help verify the value screened in the test.
Selection	0: Not held (initial setting) 1: Held
2	FAIL hold function This function retains FAIL state to help verify the value screened in the test.
Selection	0: Not held 1: Held (initial setting)
3	Hold function Enable this function to hold the current state when testing is interrupted by the STOP key.
Selection	0: Not held (initial setting) 1: Held

4	<p>Momentary-out</p> <p>The momentary OUT function allows current output only while the START key is held down. The START key on the remote control or the START signal via external I/O has the same effect.</p>
Selection	0: Not set (initial setting) 1: Set
5	<p>Double action</p> <p>Enable this function to allow testing to start only when the START key is pressed within about 0.5 seconds after the STOP key.</p>
Selection	0: Not set (initial setting) 1: Set
6	<p>FAIL mode</p> <p>Enable this function to restrict hold release to the STOP key on the main unit.</p>
Selection	0: Not set (initial setting) 1: Set
7	<p>RS Command [START]</p> <p>Turn this function on to enable the RS-232C START command.</p>
Selection	0: Not set (initial setting) 1: Set
8	<p>Inter-lock function</p> <p>Enable this function to activate the external I/O interlock terminals.</p>
Selection	0: Not set (initial setting) 1: Set
9	<p>Voltage Comparator Position</p> <p>When the voltage comparator is set to ON for a withstand voltage test, select whether you want to use the voltage comparator when starting and during the test, or only when terminating the test.</p>
Selection	0: Start test (initial setting) 1: End test
10	<p>Insulation Resistance Test measurement range</p> <p>Select whether you want to use a fixed or an automatic range as the insulation resistance test measurement range. The fixed ranges are automatically selected depending on the preset lower-limit value. Auto range switches between ranges depending on the measured value, but it takes time to display this value, since it is displayed after the range is switched. (This takes approximately 1.3 seconds.)</p>
Selection	0: Fixed range (initial setting) 1: Auto range
11	<p>Insulation Resistance Test Termination Mode</p> <p>When performing an insulation resistance test, set whether you want to conduct the test for the set test time regardless of the decision, terminate the test when PASS screening is performed, or terminate the test when FAIL screening is performed. This mode is effective when the test time is set.</p>
Selection	0: Test for set time (initial setting) 1: Terminate test at PASS screening 2: Terminate test at FAIL screening

6.1 PASS Hold Function

This function retains the value for the PASS state on test completion. To inactivate the hold function, press the **STOP** key. The unit reverts to the READY state.

If the PASS hold function is not selected, the test result is displayed for about 0.3 second before the unit reverts to the READY state.

1. Press **SHIFT** + **STOP** keys while in READY state to display the Optional function setting screen.

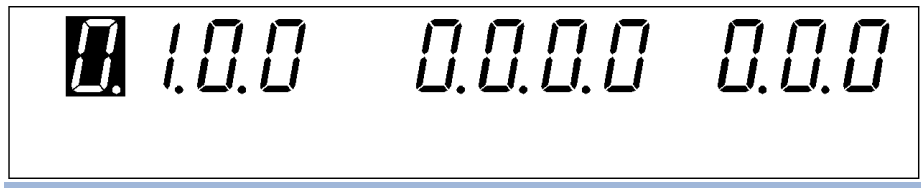

2. Use the ◀▶ keys to move the flashing cursor to the position shown in the figure.
3. Use the ▼▲ keys to set a value at the flashing cursor location.

0:	Not held (Initial setting)
1:	Held
4. To complete the optional settings, press **SHIFT** + **STOP** keys. The unit reverts to the READY state.

6.2 FAIL Hold Function

This function retains the value for the FAIL state on test completion. To inactivate the hold function, press the **STOP** key. The unit reverts to the READY state.

If the FAIL hold function is not selected, the test result is displayed for about 0.3 second before the unit reverts to the READY state.

1. Press **SHIFT** + **STOP** keys while in READY state to display the Optional function setting screen.

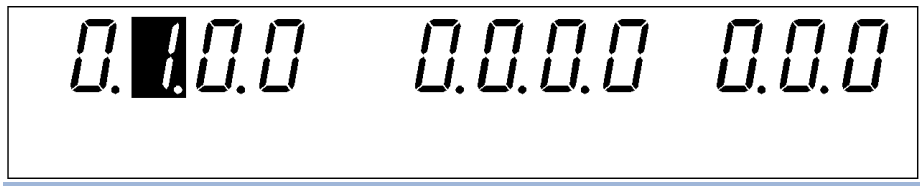

2. Use the ◀▶ keys to move the flashing cursor to the position shown in the figure.
3. Use the ▼/▲ keys to set a value at the flashing cursor location.

0:	Not held
1:	Held (Initial setting)
4. To complete the optional settings, press **SHIFT** + **STOP** keys. The unit reverts to the READY state.

6.3 Hold Function

Enable this function to hold the current state when testing is interrupted by the **STOP** key.

To inactivate the hold function, press the **STOP** key. The unit reverts to the READY state.

If the Hold function is not selected, the unit switches to the READY state upon forced termination of the test.

1. Press **SHIFT** + **STOP** keys while in READY state to display the Optional function setting screen.
2. Use the **◀▶** keys to move the flashing cursor to the position shown in the figure.

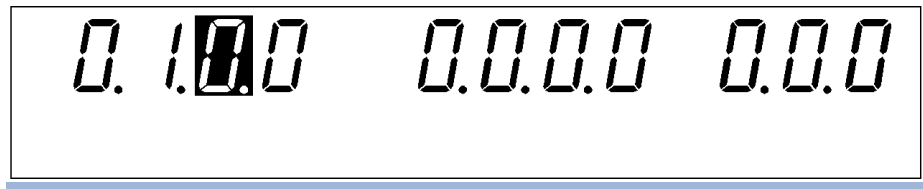

3. Use the **▼▲** keys to set a value at the flashing cursor location.

0: Not held (Initial setting)

1: Held

4. To complete the optional settings, press **SHIFT** + **STOP** keys. The unit reverts to the READY state.

Distinction between the PASS Hold Function, FAIL Hold Function, and Hold Function

- With a comparative-voltage value set in withstand voltage test, if the output voltage deviates from the comparative-voltage range, the unit switches to the FAIL state.
- If the test time is set to OFF in withstand voltage mode, PASS screening is not performed. In such a case, FAIL screening is performed or the test is terminated using the **STOP** key.
- In insulation resistance mode, if the test time is set to OFF, PASS screening is not performed. In such a case, the test is terminated using the **STOP** key.

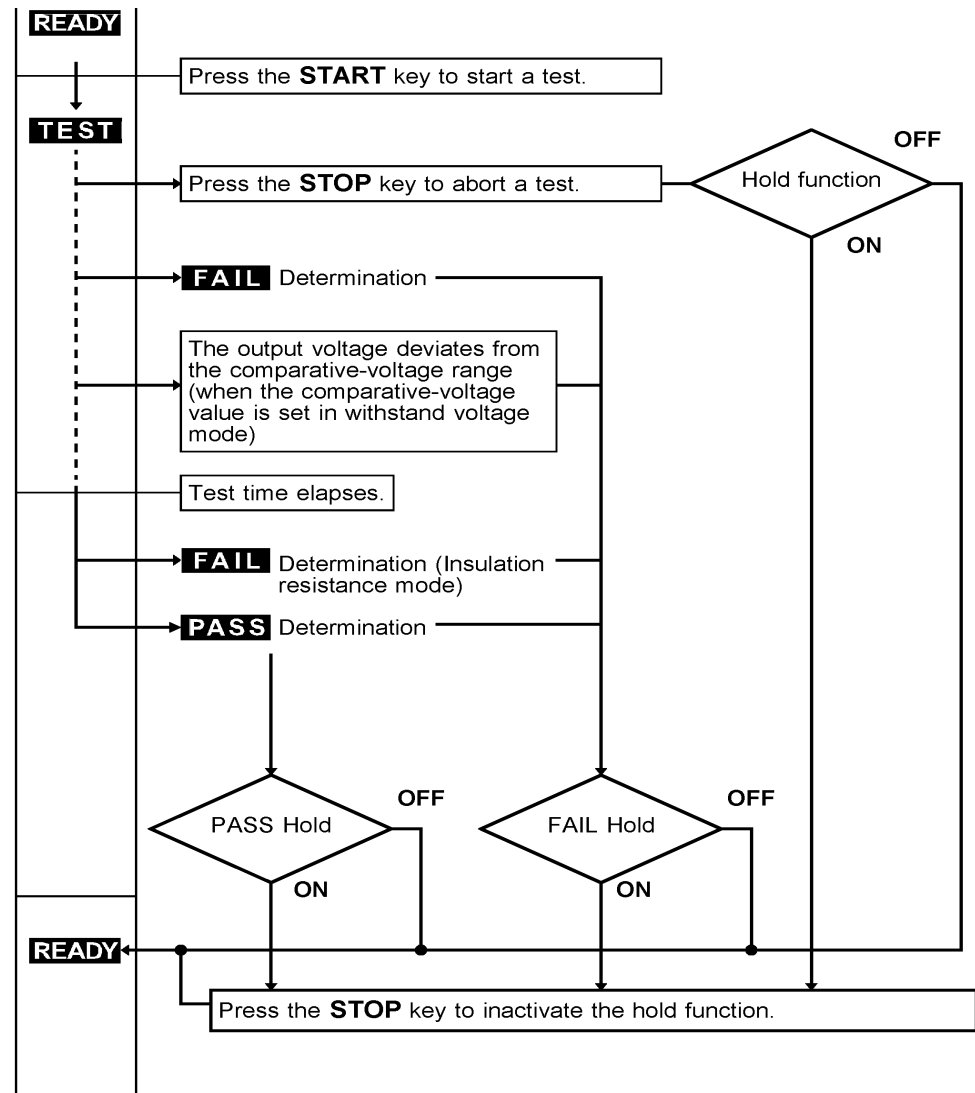

6.4 Momentary Out

The momentary out function allows current output only while the **START** key is held down. Releasing the **START** key is equivalent to pressing the **STOP** key and ends the test.

To perform PASS/FAIL screening, hold down the **START** key until the preset test time elapses.

The **START** key on the remote control or the **START** signal via external I/O has the same effect.

1. Press **SHIFT** + **STOP** keys while in **READY** state to display the Optional function setting screen.

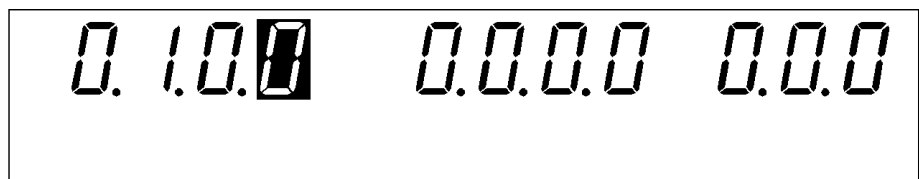

2. Use the **◀▶** keys to move the flashing cursor to the position shown in the figure.
3. Use the **▼▲** keys to set a value at the flashing cursor location.

0:	Not set (Initial setting)
1:	Set
4. To complete the optional settings, press **SHIFT** + **STOP** keys. The unit reverts to the **READY** state.



Priority for control of the **START** key is in the following order: the switch on the **REMOTE CONTROL BOX**, the external I/O, and the front panel of the unit.

6.5 Double Action

When using the Double Action function, the test starts if the **START** key is pressed within approximately 0.5 s of the **STOP** key being pressed. Normally, pressing the **START** key only starts the test. However, when using the Double Action function, the **STOP** key must be pressed before pressing the **START** key. This function increases testing safety by preventing operational errors.

Double Action function is set, **READY** only lights up for approximately 0.5 seconds after the **STOP** key is pressed.

1. Press **SHIFT** + **STOP** keys while in **READY** state to display the Optional function setting screen.

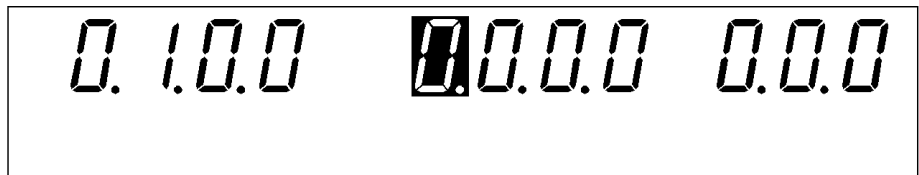

2. Use the **◀▶** keys to move the flashing cursor to the position shown in the figure.
3. Use the **▼▲** keys to set a value at the flashing cursor location.

0:	Not set (Initial setting)
1:	Set
4. To complete the optional settings, press **SHIFT** + **STOP** keys. The unit reverts to the **READY** state.

NOTE

The Double Action function can be set in combination with the Momentary-Out function. If settings are made in this way, press the **START** key within 0.5 seconds after the **STOP** key is pressed to start a test. Hold down the **START** key during the test.

6.6 FAIL Mode

Enable this function to restrict hold release to the **STOP** key on the main unit.

1. Press **SHIFT** + **STOP** keys while in READY state to display the Optional function setting screen.

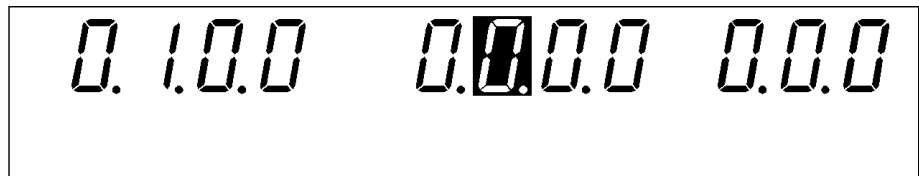

2. Use the ◀▶ keys to move the flashing cursor to the position shown in the figure.
3. Use the ▼▲ keys to set a value at the flashing cursor location.

0:	Not set (Initial setting)
1:	Set
4. To complete the optional settings, press **SHIFT** + **STOP** keys. The unit reverts to the READY state.

6.7 RS Command [START]

When RS-232C is used for control, settings can be made to specify whether to accept the test start command ":STAR."

If "1: Set" is selected, a test is started when the ":STAR" command is received.

If "0: Not set" is selected, this command is disregarded.

1. Press **SHIFT** + **STOP** keys while in READY state to display the Optional function setting screen.

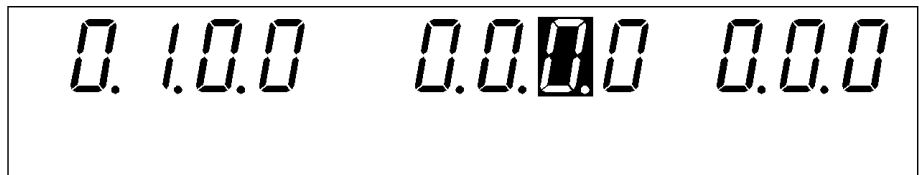

2. Use the ◀▶ keys to move the flashing cursor to the position shown in the figure.
3. Use the ▼/▲ keys to set a value at the flashing cursor location.

0:	Not set (Initial setting)
1:	Set
4. To complete the optional settings, press **SHIFT** + **STOP** keys. The unit reverts to the READY state.



Unless the control program on your PC is complete, select "0: Not set."

6.8 Inter-lock Function

Settings can be made to specify whether to use the Inter-lock function with the external I/O terminal.

If "0: Not set" is selected, the Inter-lock function is cancelled regardless of the state of Pin 10 on the external I/O terminal.

If "1: Set" is selected, the Inter-lock function may be disabled, depending on the state of Pin 10 of the external I/O terminal. For the Inter-lock function, see Section 8.1.4, "Inter-lock Function."

1. Press **SHIFT** + **STOP** keys while in READY state to display the Optional function setting screen.

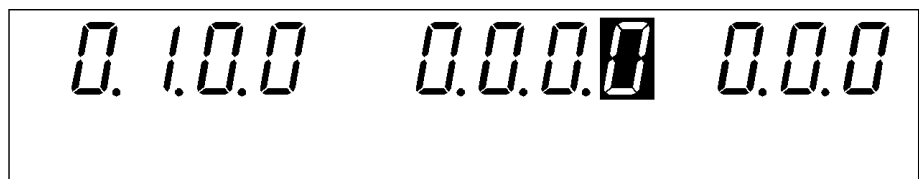

2. Use the **◀▶** keys to move the flashing cursor to the position shown in the figure.
3. Use the **▼▲** keys to set a value at the flashing cursor location.

0:	Not set (Initial setting)
1:	Set
4. To complete the optional settings, press **SHIFT** + **STOP** keys. The unit reverts to the READY state.



The Inter-lock function can be set only when INT.LOCK (Pin 10) of the external I/O terminal is set at LOW level. If the terminal is set at HIGH level, "0: Not set" remains effective even if the **▼▲** keys are pressed.

6.9 Voltage Comparator Position

When performing a withstand voltage test, you can select whether you want to view the output-voltage when the test starts, or when the test ends.

If "0: Start test" is selected, the Voltage Comparator function is active immediately before and during the withstand voltage test.

If "1: End test" is selected, the Voltage Comparator function is only active when the withstand voltage test ends.

1. Press **SHIFT** + **STOP** keys while in READY state to display the Optional function setting screen.

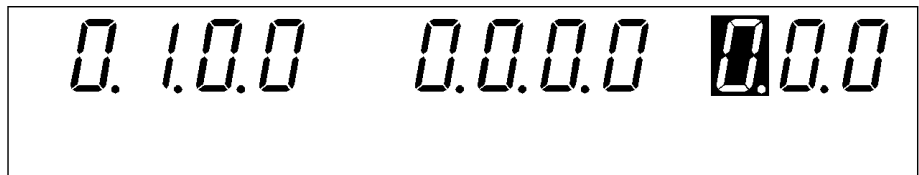

2. Use the ◀▶ keys to move the flashing cursor to the position shown in the figure.
3. Use the ▼/▲ keys to set a value at the flashing cursor location.

0:	Start test (Initial setting)
1:	End test
4. To complete the optional settings, press **SHIFT** + **STOP** keys. The unit reverts to the READY state.

NOTE

When the Voltage Comparator function is set to OFF or the Voltage Comparator function is set to ON but the timer is set to OFF, the Voltage Comparator function is disabled and optional settings are ineffective.

6.10 Insulation Resistance Test Measurement Range

Select whether you want to use a fixed or an automatic range as the insulation resistance test measurement range.

If "0: Fixed range" is selected, the range is automatically selected depending on the preset lower-limit value.

If "1: Auto range" is selected, the range is automatically switched according to the measured value.

1. Press **SHIFT** + **STOP** keys while in READY state to display the Optional function setting screen.

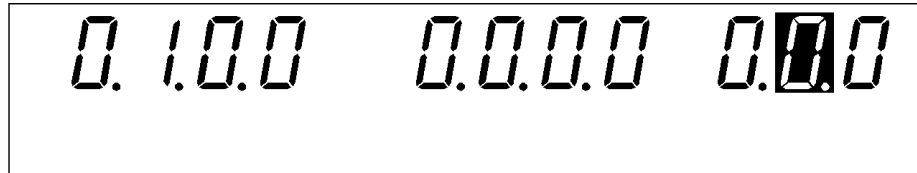

2. Use the **◀/▶** keys to move the flashing cursor to the position shown in the figure.
3. Use the **▼/▲** keys to set a value at the flashing cursor location.

0:	Fixed range (Initial setting)
1:	Auto range
4. To complete the optional settings, press **SHIFT** + **STOP** keys. The unit reverts to the READY state.

NOTE

- When using Auto range, it takes up to 1.3 s to display the measured value. This is because it takes time to switch the range automatically according to the measurement setting. When the test finishes before the preset test time, the test results in a LOWER FAIL. *The test voltage, lower-limit value range, and measurement range are shown below. *Values that drop below the measurement range appear on the "U.F." (underflow display) and values that exceed the measurement range appear on the "O.F." (overflow display).
- The test voltage, lower-limit value range, and measurement range are shown below.
- Values that drop below the measurement range appear on the "U.F." (underflow display) and values that exceed the measurement range appear on the "O.F." (overflow display).

Test voltage (V)	Lower limit value (MΩ)	Range (MΩ)	Measurement range (MΩ)
500	0.20 to 2.00	2	0.17 to 10.0 ^{*1}
	2.10 to 20.0	20	1.70 to 100
	21.0 to 200	200	17.0 to 1000
	210 to 2000	2000	170 to 2200 ^{*2}
1000	0.20 to 4.00	4	0.01 to 20.0 ^{*3}
	4.10 to 40.0	40	3.40 to 200
	41.0 to 400	400	34.0 to 2000
	410 to 2000	2000	340 to 2200 ^{*2}

*1 The range from 0.17 to 0.49 is outside the guaranteed range of accuracy.

*2 The range from 2001 to 2200 is outside the guaranteed range of accuracy.

*3 The range from 0.01 to 0.99 is outside the guaranteed range of accuracy.

6.11 Insulation Resistance Test Termination Mode Settings

When performing an insulation resistance test, set whether you want to conduct the test for the set test time regardless of the decision, terminate the test when PASS screening is performed, or terminate the test when FAIL screening is performed.

If "0: Test for set time" is selected, the test is only conducted for the set time, and the value is decided when the test is terminated.

If "1: Terminate test at PASS screening" is selected, the test is terminated when PASS screening is conducted within the set time. If PASS screening is not conducted within the set time, the test is terminated when FAIL screening is conducted after the set time.

If "2: Terminate test at FAIL screening" is selected, the test is terminated when FAIL screening is conducted within the set time. If FAIL screening is not conducted within the set time, the test is terminated when PASS screening is conducted after the set time.

1. Press **SHIFT** + **STOP** keys while in READY state to display the Optional function setting screen.

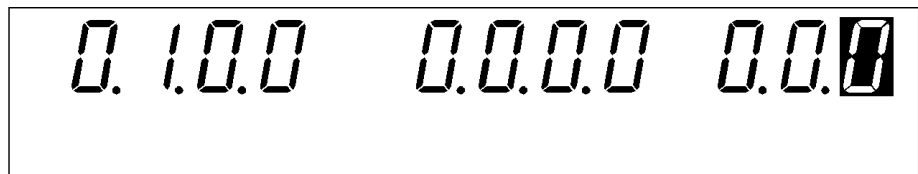

2. Use the **◀▶** keys to move the flashing cursor to the position shown in the figure.
3. Use the **▼▲** keys to set a value at the flashing cursor location.

0 : Test for set time (Initial setting)

1 : Terminate test at PASS screening

2 : Terminate test at FAIL screening

4. To complete the optional settings, press **SHIFT** + **STOP** keys. The unit reverts to the READY state.

NOTE

- When performing a test on a test object that contains a capacity component, you must select either "0: Test for set time" or "1: Terminate at PASS screening," and set a sufficient amount of time for discharge.
- If the test time is set to OFF, the settings for this mode are ineffective.

"0: Test for set time"

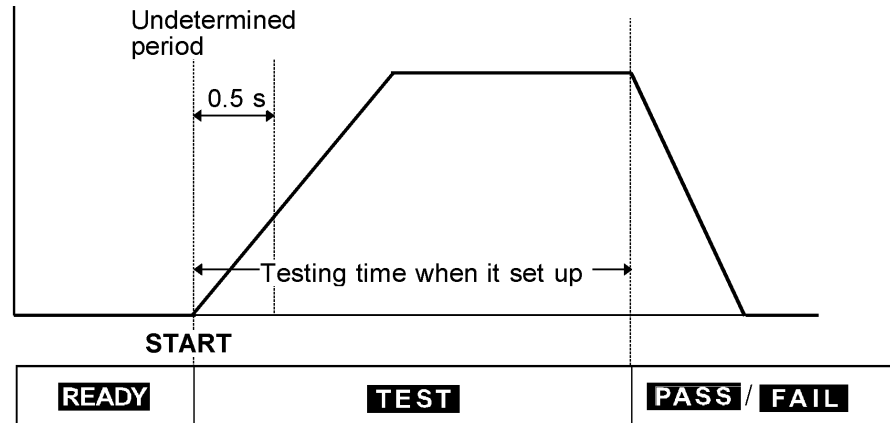

"1: Terminate test at PASS screening"

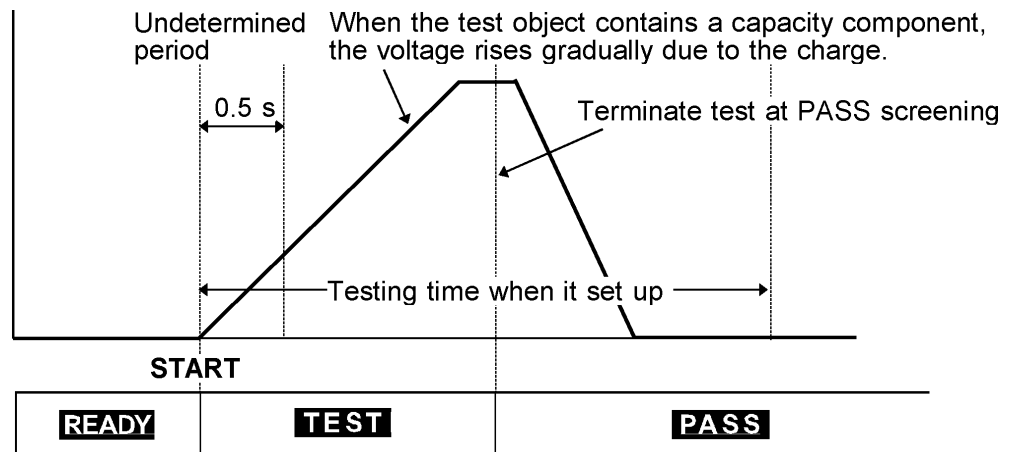

"2: Terminate test at FAIL screening"

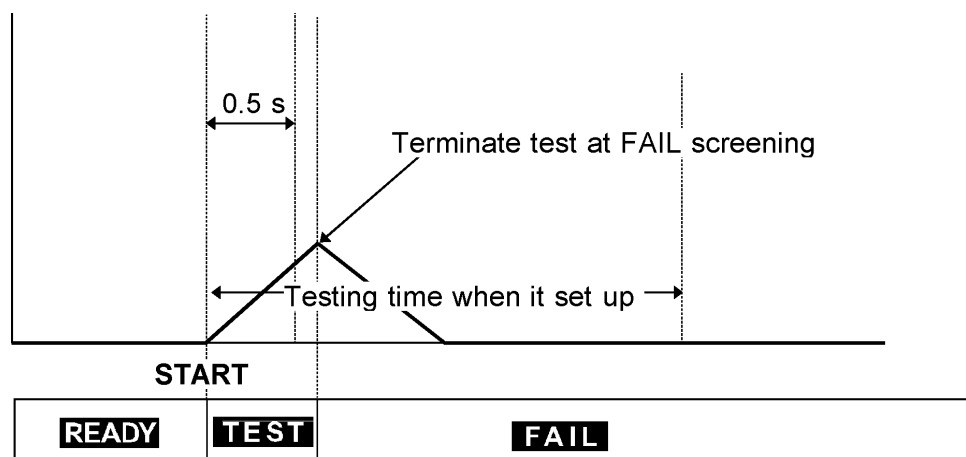

6.12 Example of Optional Functions Use

The following describes how 3159 optional functions are used for testing. Various combinations of optional functions are possible for testing.

(1) Testing to check test results

1. 1.0.0	0.0.0.0	0.0.0
<u>Optional function settings</u>		

Optional Functions	Selection
PASS Hold Function	1: Held
FAIL Hold Function	1: Held

Advantages of these settings

PASS or FAIL state is held, allowing inspection of test results.

(2) Safe testing by remote control

1. 1.0.1	0. 1.0.0	0.0.0
<u>Optional function settings</u>		

Optional Functions	Selection
FAIL Hold Function	1: Held
Momentary Out	1: Set
FAIL mode	1: Set

Advantages of these settings

- Hold down the **START** key during the test, as the Momentary-Out function is set. The 9614 REMOTE CONTROL BOX (DUAL) must be operated with both hands during the test. This prevents high-voltage devices such as the probe and tested device from coming into contact with the hands.
- The FAIL Hold function must be cancelled using the **STOP** key on the unit, as the FAIL mode is set. The use of the FAIL mode enables the FAIL state to be set.

Chapter 7

Saving/loading Preset Values

7.1 Saving Preset Values

The following describes a function used to save values set in the READY state. Up to twenty parameters may be saved. Up to 10 parameters may be saved in the each mode, such as the withstand voltage and insulation resistance modes. To retrieve saved data, follow the procedures described in Section 7.2.

The following parameters can be saved:

Withstand voltage mode	Comparative voltage value, Upper limit value, Lower limit value, Test time, Output voltage range
Insulation resistance mode	Test voltage value, Upper limit value, Lower limit value, Test time

NOTE

Optional function settings cannot be saved.

7.1.1 Procedure for Saving Data

You must make the settings first before they can be saved. Parameters cannot be changed on the Save screen.

(1) Selecting a test mode

Select the test mode where you want to save settings for the **W** or **I** key.

(2) Displaying the save screen

With the target preset value displayed in the READY state, press **SHIFT** + **▶** keys to shift to the save screen.

In the save screen, the saved data for the file number replaces the target value displayed in the READY state.

The first saved data displayed is the last data from the previous save screen.

Withstand-voltage mode

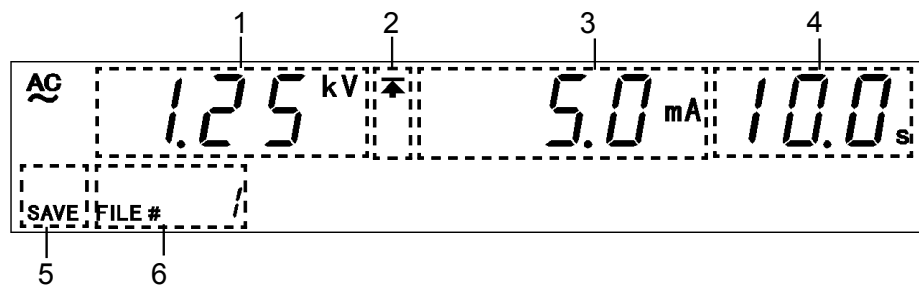

1	Comparative voltage value and Output voltage range	The comparative-voltage value and output-voltage range for saved data. Switch the display using the ◀ key. When an output-voltage range is set, "RENGE" lights up.
2	Upper limit value icon and Lower limit value icon	⬆ is displayed when the upper-limit value is shown, and ⬇ is displayed when the lower-limit value is shown.
3	Upper and Lower limit values	The upper- or lower-limit value of saved data. Switch the display using the ▶ key.
4	Test time	The test time for the saved data.
5	SAVE	Indicates a saved screen.
6	File number	Indicates the file number for the saved data.

Insulation-resistance mode

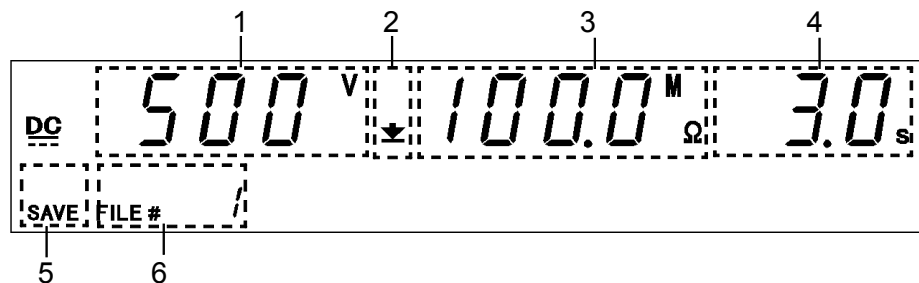

1	Test voltage value	The test voltage value for saved data.
2	Upper limit value icon and Lower limit value icon	⬆ is displayed when the upper-limit value is shown, and ⬇ is displayed when the lower-limit value is shown.
3	Upper and Lower limit values	The upper- or lower-limit value of saved data. Switch the display using the ▶ key.
4	Test time	The test time for the saved data.
5	SAVE	Indicates a saved screen.
6	SAVE	Indicates the file number for the saved data.

(3) Selecting a file to save

The new data overwrites the previous data. Look for the saved data to be deleted, using the ▼/▲ keys.

On the withstand voltage mode Save screen, the ◀ key switches between the comparative-voltage value and output-voltage value, and the ▶ key switches between the upper- and lower-limit values.

(4) Saving and canceling data

When the saved data to be deleted is displayed, press **SHIFT** + ▶ keys. This deletes the saved data and saves the value set in the READY state.

After the saving the data, the unit reverts to the READY state.

Press the **STOP** key to revert to the READY state without saving the target data.

NOTE

For comparative voltage(withstand voltage mode), the test lower limit(withstand voltage mode), the test upper limit(insulation resistance), and test time, both ON/OFF settings and set values used (when on) are saved.

7.1.2 Example of Saving

The following example shows how to save in File No.3. We assume that the 3159 is in the READY state.

1. Make the settings that you want to save in the SETTING state and the unit returns to the READY state.

For more information on making these settings, see Chapter 3.

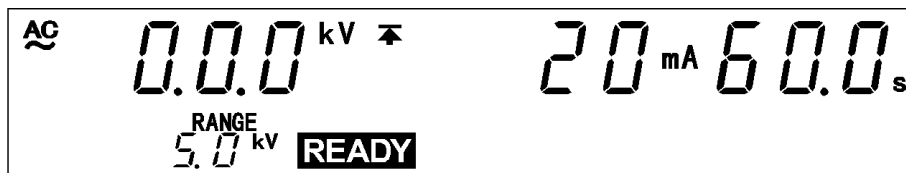

In this example, settings are made as follows:

Comparative voltage value: 2.00 kV
Upper limit value: 20 mA
Lower limit value: OFF
Test time: 60.0 s
Output voltage range: 2.5 kV

2. Press **SHIFT** + **▶** keys to bring up the save screen.

In the save screen, the value set in the READY state is replaced by the saved data being displayed. The first saved data displayed is the last data item from the previous save screen. This example shows "File No.1." The new data overwrites the previous data. Use the **▼/▲** keys to select the data to be overwritten. The new data in this example is to be saved in File No.3.

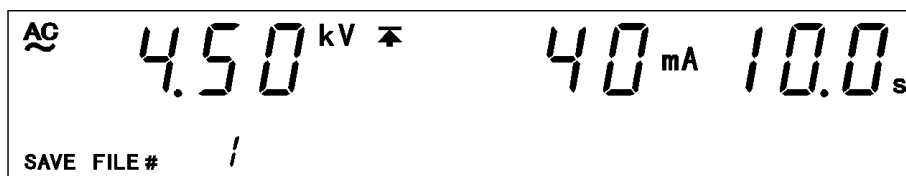

Use the **◀** key to confirm the output-voltage range, and the **▶** key to confirm the lower-limit value.

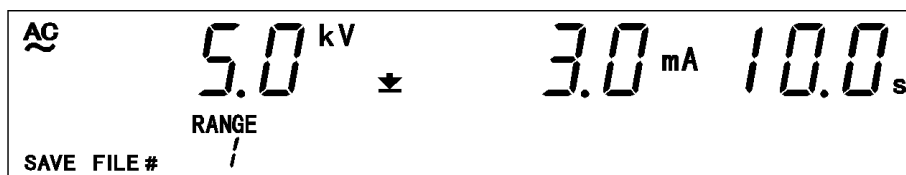

In this example, File No. 1 contains the following settings.

Comparative voltage value: 4.50 kV
Upper limit value: 40 mA
Lower limit value: 3 mA
Test time: 10.0 s
Output voltage range: 5.0 kV

3. Use the ▼/▲ keys to select File No.3.

This example shows File No. 1. Press the ▲ key twice to display File No.3.

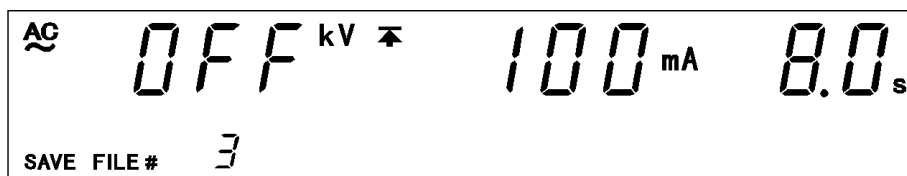

4. Use the ◀ key to confirm the comparative voltage value and output voltage range, and the ▶ key to confirm the upper- or lower-limit value.

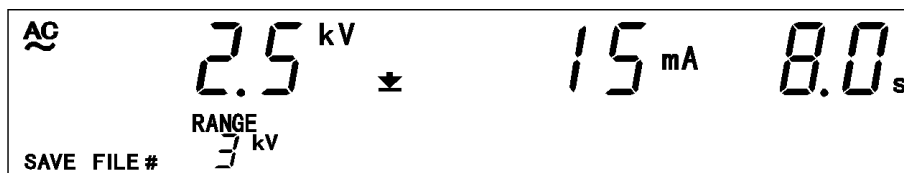

In this example, File No. 3 contains the following settings.

Comparative voltage value: OFF
 Upper limit value: 100 mA
 Lower limit value: 15 mA
 Test time: 8.0 s
 Output voltage range: 2.5 kV

7

5. To save the data, press **SHIFT** + ▶ keys. The unit reverts to the READY state. Once saved, the value set in the READY state is retained in File No.3.

Note that File No.3, shown in Step (4) above, is deleted.

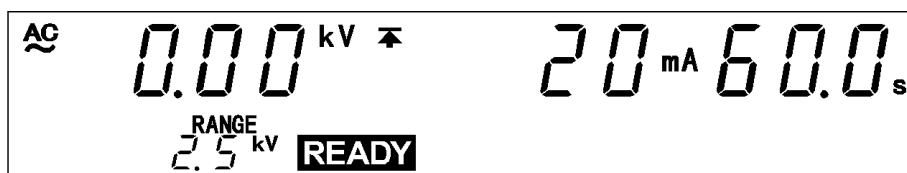

To abort the save procedure, press the **STOP** key at Step (4). The unit halts the save procedure and reverts to the READY state.

7.2 Loading Preset Values

The following describes how to load saved data.

Up to 10 data items may be saved in the each mode, such as the voltage and insulation resistance modes. Use this function to instantly change a preset value.

The following parameters can be saved:

Withstand-voltage mode	Comparative voltage value, Upper limit value, Lower limit value, Test time, Output voltage range
Insulation-resistance mode	Test voltage value, Upper limit value, Lower limit value, Test time

7.2.1 Procedure for Loading Data

(1) Selecting a test mode

Select the test mode where you want to save settings for the **W** or **I** key.

(2) Displaying the load screen

Press **SHIFT** + **◀** keys in the READY state to shift to the load screen.

In the load screen, a number for saved data equal to the file preset replaces the target value displayed in the READY state.

The first saved data displayed is the last data from the previous load screen.

Withstand-voltage mode

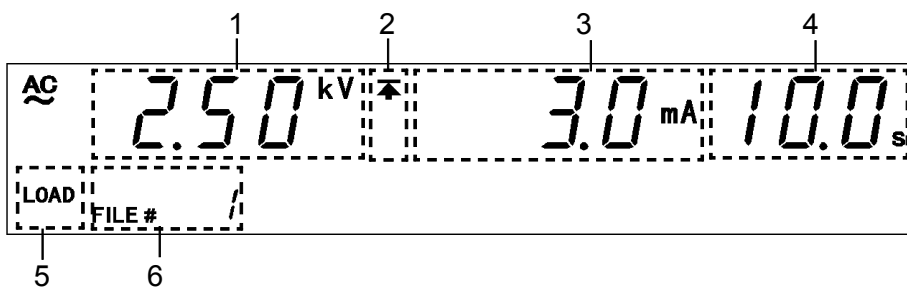

1	Comparative voltage value and Output voltage range	The comparative-voltage value and output-voltage range for saved data. Switch the display using the ◀ key. When an output-voltage range is set, "RENGE" lights up.
2	Upper limit value icon and Lower limit value icon	▲ is displayed when the upper-limit value is shown, and ▼ is displayed when the lower-limit value is shown.
3	Upper and Lower limit values	The upper- or lower-limit value of saved data. Switch the display using the ▶ key.
4	Test time	The test time for the saved data.
5	LOAD	Indicates a loaded screen.
6	File number	Indicates the file number for the saved data.

Insulation resistance mode

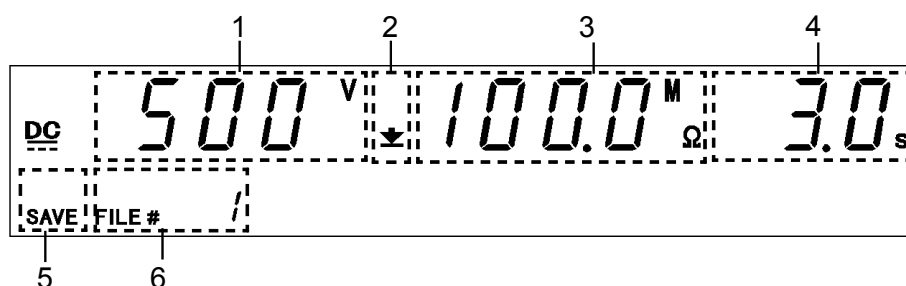

1	Test voltage value	The test voltage value for saved data.
2	Upper limit value icon and Lower limit value icon	▲ is displayed when the upper-limit value is shown, and ▼ is displayed when the lower-limit value is shown.
3	Upper and Lower limit values	The upper- or lower-limit value of saved data. Switch the display using the ► key.
4	Test time	The test time for the saved data.
5	LOAD	Indicates a loaded screen.
6	File number	Indicates the file number for the saved data.

CAUTION

The output-voltage nearly doubles when the output-voltage range is changed from 2.5 kV to 5.0 kV. To avoid damaging the unit, after changing the range, make sure that you adjust the output-voltage using the voltage adjustment knob.

(3) Selecting a file to load

Use the ▼/▲ keys to change the file number and confirm the saved data that you want to load.

On the withstand voltage mode Load screen, the ◀ key switches between the comparative-voltage value and output-voltage value, and the ▶ key switches between the upper- and lower-limit values.

(4) Loading and canceling data

When the saved data to be loaded is displayed, press **SHIFT** + ◀ keys. This loads the saved data and the unit reverts to the READY state.

Press the **STOP** key to revert to the READY state without loading the target data.

7.2.2 Example of Loading

The following example shows how to load File No.3. The 3159 is in the withstand voltage mode READY state.

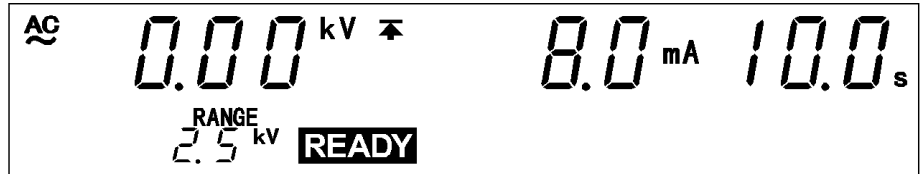

1. Press **SHIFT** + **◀** keys to bring up the load screen.

In the load screen, the value set in the READY state is replaced by the saved data being displayed. The first saved data displayed is the last data item from the previous load screen. This example shows "File No.1."

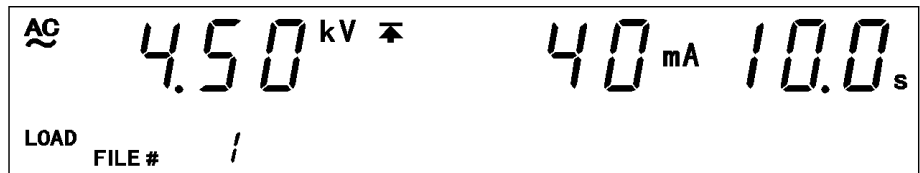

In this status, the preset lower limit value can be checked by using the **▶** keys.

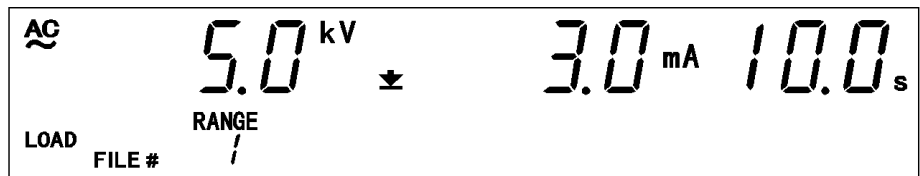

In this example, File No. 1 contains the following settings.

Comparative voltage value: 4.5 kV
 Upper limit value: 40 mA
 Lower limit value: 3 mA
 Test time: 10.0 s
 Output voltage range: 5.0 kV

2. Use the **▼/▲** keys to select File No.3.
 This example shows File No. 1. Press the **▲** key twice to display File No.3.

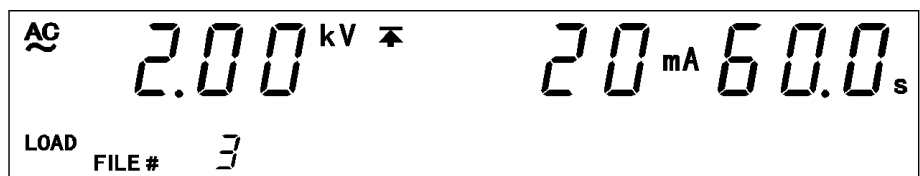

3. Use the ◀ key to confirm the comparative voltage value and outputvoltage range, and the ▶ key to confirm the upper- and lower-limit value.

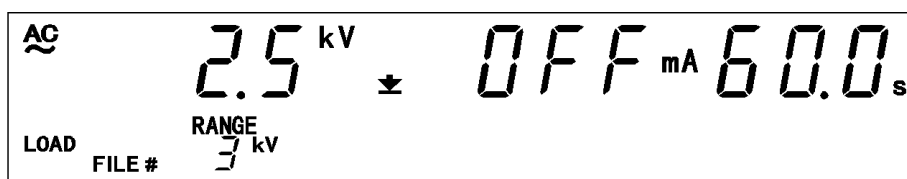

In this example, File No. 3 contains the following settings.

Comparative voltage value: 2.00 kV
 Upper limit value: 20 mA
 Lower limit value: OFF
 Test time: 60.0 s
 Output voltage range: 2.5 kV

4. Use the ◀ key to confirm the comparative voltage value and outputvoltage range, and the ▶ key to confirm the upper- or lower-limit value.

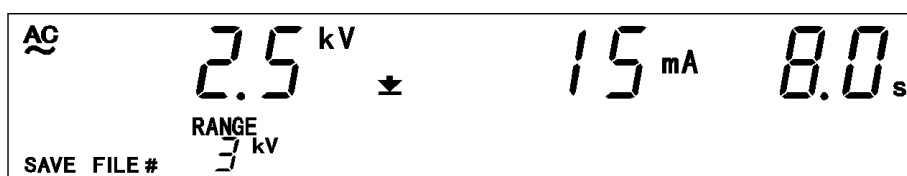

In this example, File No. 3 contains the following settings.

Comparative voltage value: OFF
 Upper limit value: 100 mA
 Lower limit value: 15 mA
 Test time: 8.0 s
 Output voltage range: 2.5 kV

5. To load the data, press **SHIFT** + ▶ keys. The unit reverts to the READY state. To abort the load procedure, press the **STOP** key.

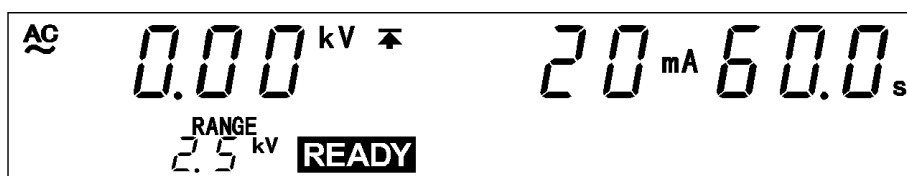

Chapter 8

External Interface

8.1 External I/O Terminal

The output, START, and STOP signals regarding the status (such as the TEST state) and decisions (such as FAIL) of the 3159 are controlled through the external I/O terminal, located at the back of the unit. An inter-lock terminal is provided to ensure safety. An inter-lock terminal is provided to ensure safety.

All signal lines are insulated internally with a photocoupler. A power voltage of 15 V (0.1 A), insulated from the internal supply, is output from the external I/O terminal. This voltage can be used as external power. If the unit power capacity is insufficient, add an external power supply.



When EXT-E of the external I/O terminal is at LOW level, EXT lights up when the REMOTE CONTROL BOX is active.

NOTE

There is a priority hierarchy for the **START** keys. When a **START** key with a higher priority is in use, lower-priority keys are disabled. (When EXT-E of the external I/O terminal is at LOW level (EXT lights up), the unit **START** key is disabled.) If you use the REMOTE CONTROL BOX, the START signal for the external I/O terminal is disabled.)

Priority: REMOTE CONTROL BOX > External I/O > Front panel of the unit.

8.1.1 Signal Line

Use the following external I/O connectors or their equivalents:

(1) Compatible connector

Compatible connector: XM8A-3621 and XM8K-3623-S
(OMRON Corporation)
RC30-36P (Hirose Electric)

(2) External I/O connector pin numbering

Connector of the 3159 main unit: XM8F-3622-12 (OMRON Corporation)

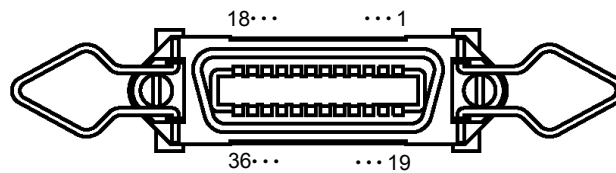

Pin number	I/O	Signal line name	Pin number	I/O	Signal line name
1	OUT	READY	19	OUT	NC
2	OUT	L-FAIL	20	OUT	NC
3	OUT	U-FAIL	21	OUT	NC
4	OUT	PASS	22	OUT	NC
5	OUT	TEST	23	OUT	NC
6	OUT	H.V.ON	24	OUT	NC
7	IN	EXT-E	25	OUT	NC
8	IN	START	26	OUT	NC
9	IN	STOP	27	OUT	NC
10	IN	INT.LOCK	28	OUT	NC
11	OUT	W-MODE	29	OUT	NC
12	OUT	I-MODE	30	OUT	NC
13	OUT	W-FAIL	31	OUT	NC
14	OUT	I-FAIL	32	OUT	NC
15	IN	ISO.COM	33	OUT	ISO.DCV
16	IN	ISO.COM	34	OUT	ISO.DCV
17	IN	ISO.COM	35	OUT	ISO.DCV
18	IN	ISO.COM	36	OUT	ISO.DCV

(3) Function of the signal line

Signal line name	I/O	Function
READY	OUT	LOW level in the READY state
L-FAIL	OUT	LOW level in the FAIL state at LOWER (minimum value)
U-FAIL	OUT	LOW level in the FAIL state at UPPER (maximum value)
PASS	OUT	LOW level in the PASS state
TEST	OUT	LOW level in the TEST state
H.V.ON	OUT	LOW level when a voltage is generated in the output terminal
EXT-E	IN	At LOW level, the external I/O input signal is active. INT.LOCK remains active regardless of this signal.
START	IN	LOW level is equivalent to pressing the unit START key and provides the same functions.
STOP	IN	LOW level is equivalent to pressing the unit STOP key and provides the same functions.
INT.LOCK	IN	Inter-lock function terminal. This signal is always active regardless of the status of the EXT-E terminal. When connected to ISO.COM, this terminal cancels the Interlock function, enabling the unit to function properly. When disconnected, the terminal disables all keys. To activate the Inter-lock function, set the optional Inter-lock function to "1: Set." Use this terminal for a protective device against electric shock that uses an area sensor or the like. See Section 8.1.4.
W-MODE	OUT	LOW level when performing a withstand voltage test in the Withstand Voltage Test screen.
I-MODE	OUT	LOW level when performing an insulation resistance test in the insulation resistance Test screen.
W-FAIL	OUT	LOW level in FAIL state during a withstand voltage test.
I-FAIL	OUT	LOW level in FAIL state during an insulation resistance test.
ISO.COM	IN	Generates an internal GND for the unit. Used temporarily to activate the external I/O function. Note that the signal line is not insulated.
ISO.DCV	OUT	Outputs a power voltage of 15 V (0.1 A), insulated from the internal power supply.

8.1.2 Example of Input Signal Connection

The unit can be controlled externally using the external I/O input signal. Provide a connector that conforms to the External I/O Specifications. To enable the external I/O signal, set the EXT-E signal (Pin 7) to LOW level. Connect the EXT-E signal to ISO.COM for the GND signal (Pins 15 to 18), which is insulated from the unit's internal power supply.

EXT I/O Input signals Specifications

Input signals	Active low input (photocoupler isolated)
Max. testing withstand voltage	30 VDC
HIGH level voltage	15 VDC or more, open
LOW level voltage	5 VDC or less (-6 mA typ)
Input signals	START, STOP, EXT-E, INTERLOCK

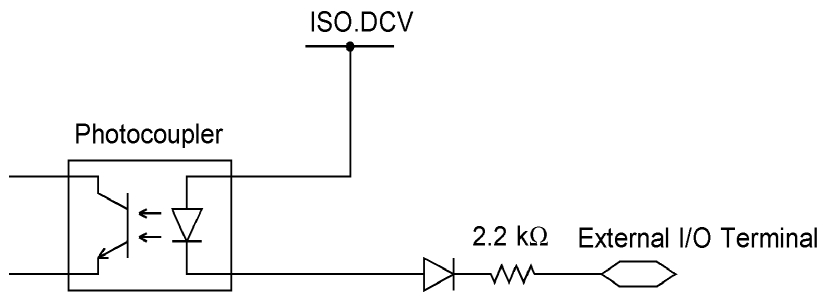

(1) Control using the external switch (example)

To control the START and STOP signals using a relay or switch, make connections as shown below:

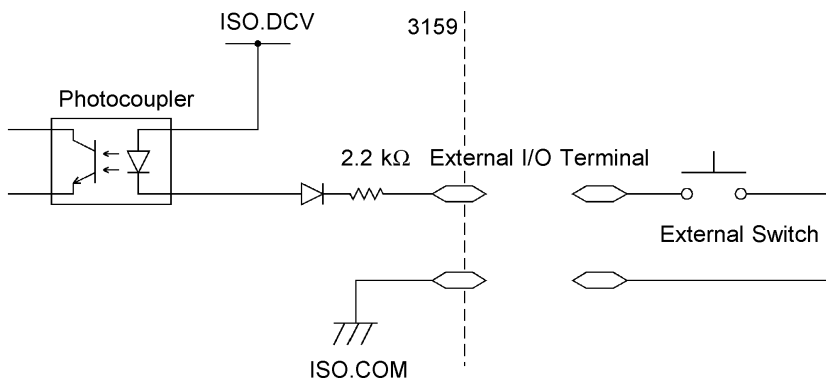

For connection to the input signal, provide a circuit that protects the relay and switch from chattering to prevent malfunctioning.

(2) Control using the transistor (example)

For control using a transistor or FET, make connections as shown below. Design the signals so that 6 mA is absorbed into each of the signals.

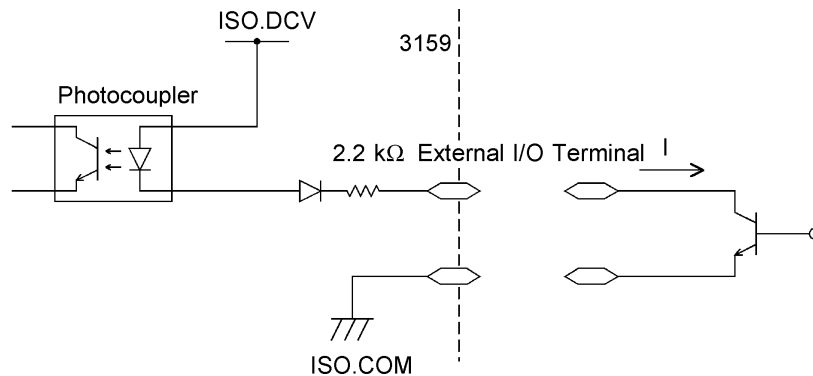

8.1.3 Example of Output Signal Connection

The output signal becomes Lo depending on the condition of the unit. Prepare a connector that conforms to the External I/O Specifications. To enable the external I/O-signal function, set the EXT-E signal (Pin 7) to LOW level. Connect the EXT-E signal to ISO.COM for the GND signal (Pins 15 to 18). An output example is presented in Section 8.1.5.

EXT I/O Output signals Specifications

Output signal	Open collector output
Max. load	30 VDC
Max. output current	100 mADC per signal
Output saturation voltage	1.5 VDC or less
Output signals	H.V.ON, TEST, PASS, U-FAIL, L-FAIL, READY, W-MODE, I-MODE, W-FAIL, I-FAIL

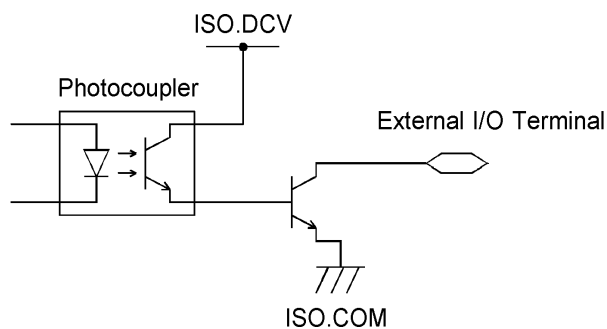

(1) Controlling the relay (example)

To link the relay to an external device, make connections as shown below. Use of the power supply ISO.DCV (Pins 33 to 36, 15 VDC 0.1 A) will facilitate the connections.

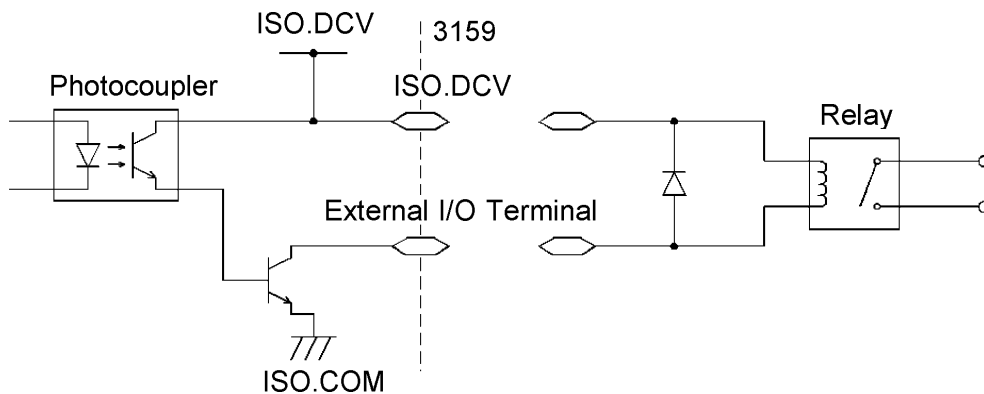

NOTE

- A signal can absorb up to 100 mA.
- When connecting an inductive load such as a relay, connect the diode in parallel with the coil.

(2) Obtaining a signal limit (example)

To obtain a signal limit, make connections as shown below. In addition, check the output current.

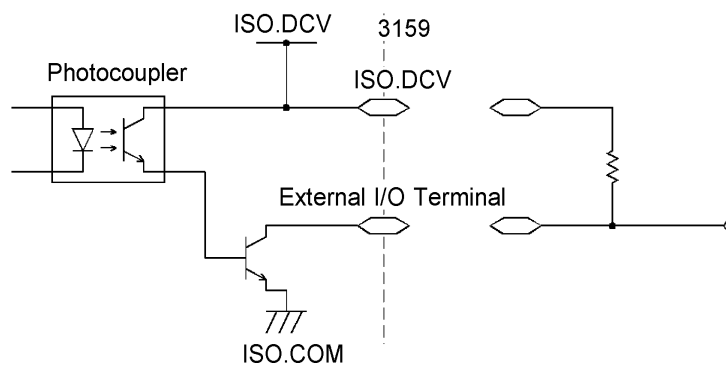

NOTE

The output signal status upon power-on may be undetermined. Care should be taken in the operation of equipment connected to the external I/O.

8.1.4 Inter-lock Function

The inter-lock function is used to cut off output from the 3159 in combination with other devices, including external equipment. This function cuts off output from the 3159, and disables all key operations.

(1) Setting the inter-lock function

1. Connect Pin 10 INT.LOCK on the external I/O terminal to ISO.COM (Pins 15 to 18), and set the pin to Lo.
2. In Optional Functions, set "Inter-lock" to "1: Set."

NOTE

- The INT.LOCK terminal is always active, regardless of the status of the EXT-E terminal.
- If "0: Not set" is selected for "Inter-lock" in Optional Functions, the inter-lock function is inactive, regardless of the status of the INT.LOCK terminal. The function is set at "0: Not set" by default. If the inter-lock function is to be used, be sure to select "1: Set."
- When the INT.LOCK terminal is not LOW level, the optional Inter-lock function cannot be set to "1: Set."

(2) Using the inter-lock function

The inter-lock function is active when the INT.LOCK terminal is open, with the following displayed:

To disable the function, connect the INT.LOCK terminal to ISO.COM and set it to LOW level. The unit changes to READY status once the inter-lock function is disabled.



Err0

(3) Connections for the inter-lock function (example)

For example, to ensure the safety of workers, the unit and the tested object are placed in a box so that they are not in contact with each other. The door of the box cover is also equipped with a switch that works in combination with the inter-lock function. If a connection is made to the switch, the interlock function is enabled when the box cover is opened. When the cover is closed, the function is disabled, making the unit ready for testing. All keys are inactive provided that the inter-lock function is active. As a result, once the unit is mounted in the box, the settings cannot be changed. In such a case, connect the setting adjustment switch the door switch such that these switches are arranged in parallel, as shown below:

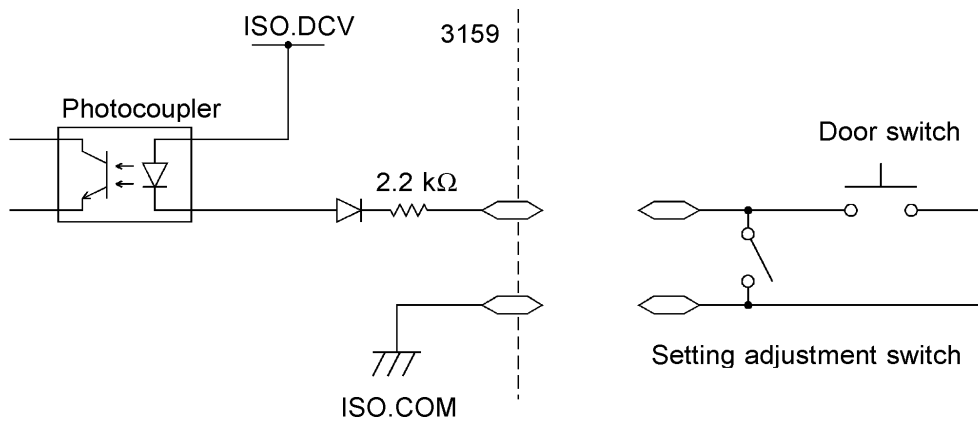

8.1.5 Timing Chart of External I/O Terminal

(1) Timing chart at time of start of testing

When a test begins, the READY signal becomes HIGH level, and the TEST signal and H.V.ON signal become LOW level.

The H.V.ON signal becomes LOW level with the voltage output.

The TEST signal changes at the same time **TEST** on the fluorescent indicator changes. If the comparative-voltage value has been set, the TEST signal becomes LOW level when **TEST** is flickering.

Withstand-voltage mode

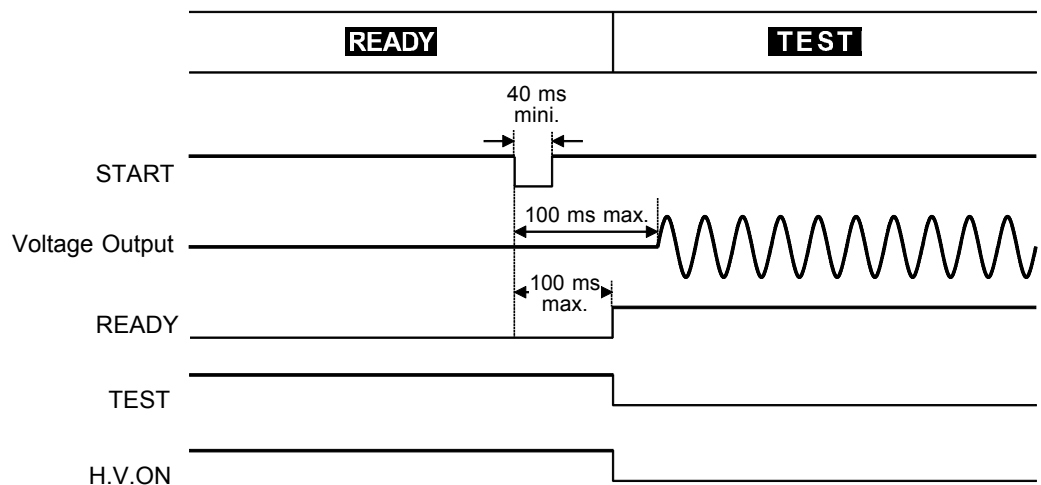

Insulation-resistance mode

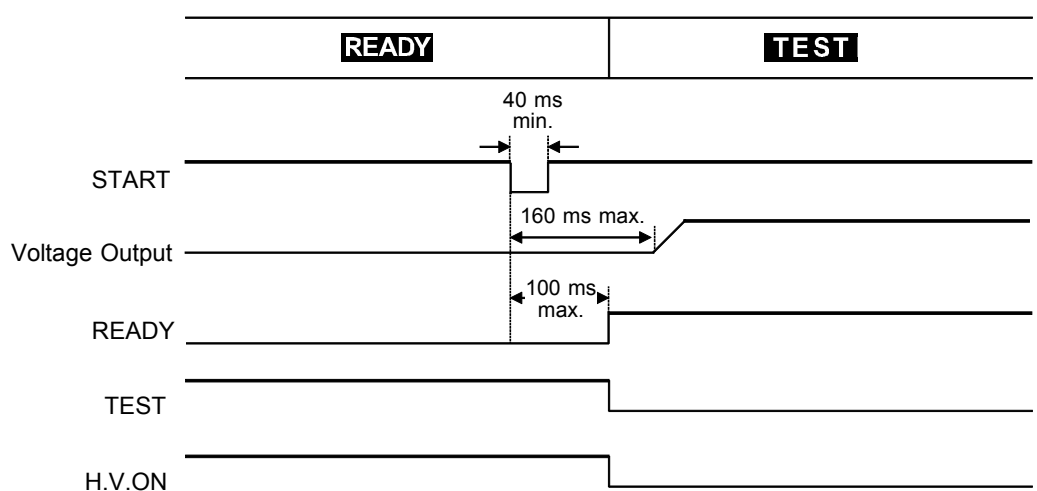

(2) Timing chart during a test decision

The figure shows the timing chart of the unit in PASS state after a test. In PASS state, the TEST signal indicates HIGH level.

The H.V.ON signal remains at LOW level provided that the voltage between the output terminals remains unchanged, as the signal is synchronized with the **DANGER** lamp. (Below 0.03 kV when performing a withstand voltage test, or below 50 V when performing an insulation resistance test) Once the voltage reaches 0, the signal changes to HIGH level.

The PASS signal changes according to the **PASS** indicator on the fluorescent display. If the PASS hold function is enabled, the PASS signal continues to indicate LOW level until the function is disabled.

When the Hold function is disabled or the unit automatically returns to the READY state, the PASS signal becomes HIGH level and the READY signal becomes LOW level.

Withstand voltage mode

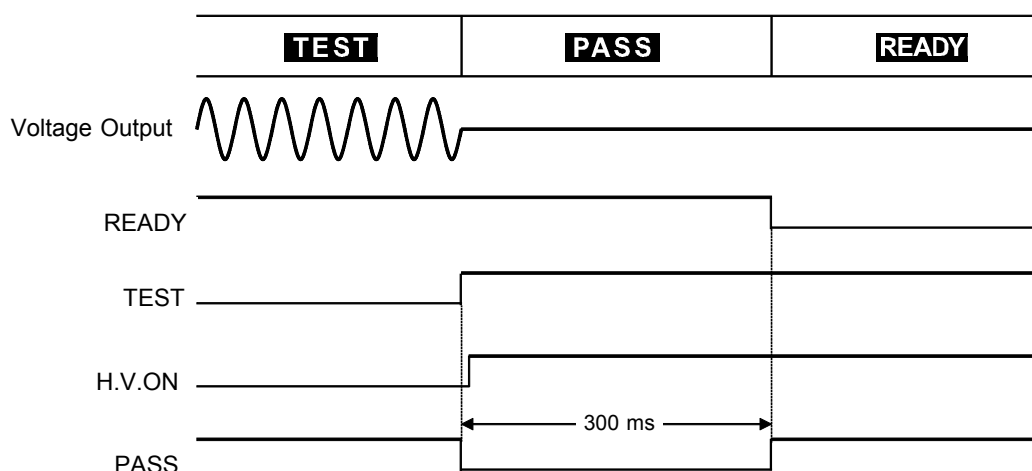

Insulation resistance mode

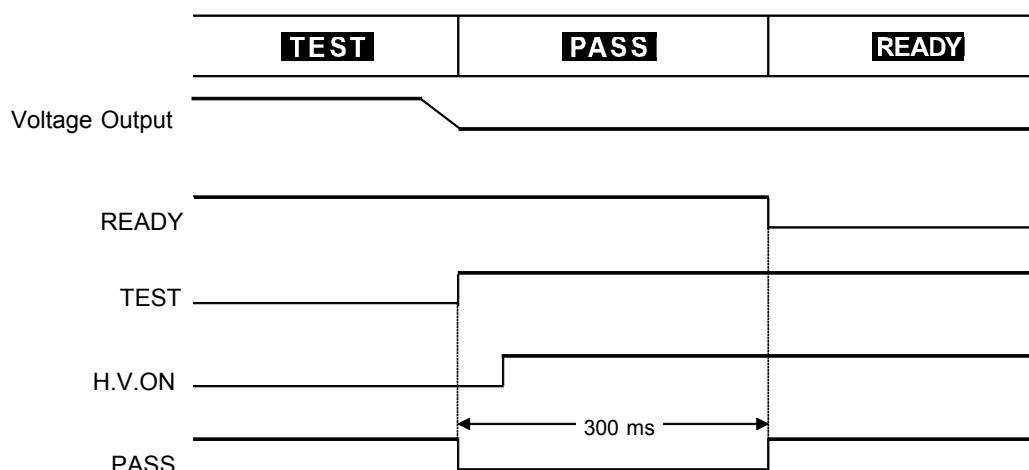

Even in the FAIL state, when UPPER FAIL is activated, the U-FAIL signal becomes LOW level. Similarly, with LOWER-FAIL, the L-FAIL signal becomes LOW level. When the FAIL Hold function is set, the signal remains at LOW level until the Hold function is disabled.

If a withstand voltage test fails, the W-FAIL signal becomes LOW level.

Similarly, if an insulation resistance test fails, the I-FAIL signal becomes LOW level. In the case of UPPER-LOWER FAIL, which is activated when the measured voltage value fails to reach the comparative-voltage value in voltage mode, the U-FAIL and L-FAIL signals are at LOW level simultaneously.

When the Hold function is disabled or the unit automatically returns to the READY state, the PASS signal becomes HIGH level and the READY signal becomes LOW level.

(3) Timing chart at forced termination

When the **STOP** key is pressed to forcibly terminate testing, the unit does not change to either PASS or FAIL status, as test screening is not performed. In this case, the signal becomes HIGH level. In the absence of status indicators (READY/TEST/FAIL/PASS) -- in the SETTING state, when set values are being saved or loaded, or when settings are being made for the optional functions -- all signals become HIGH level.

Withstand voltage mode

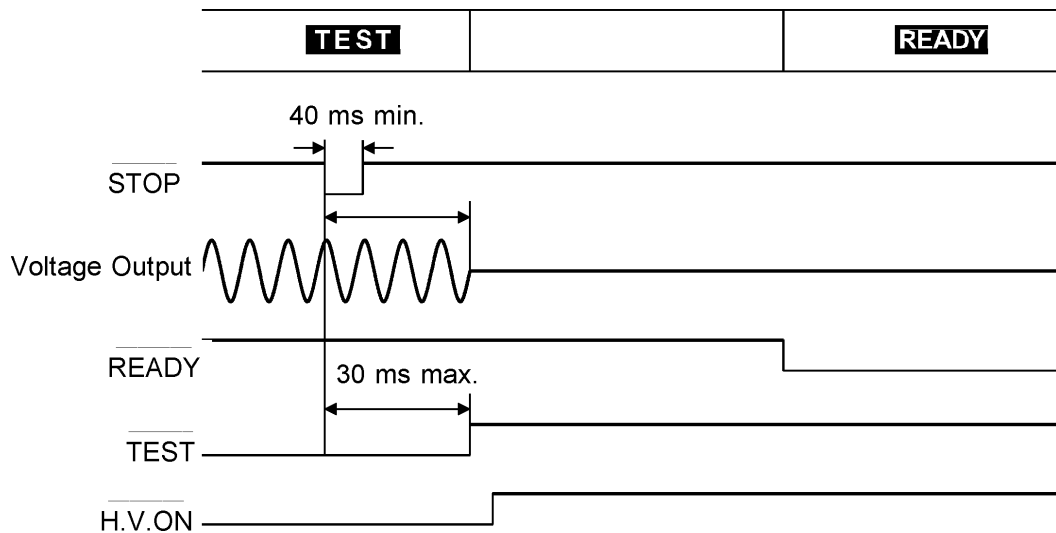

Insulation resistance mode

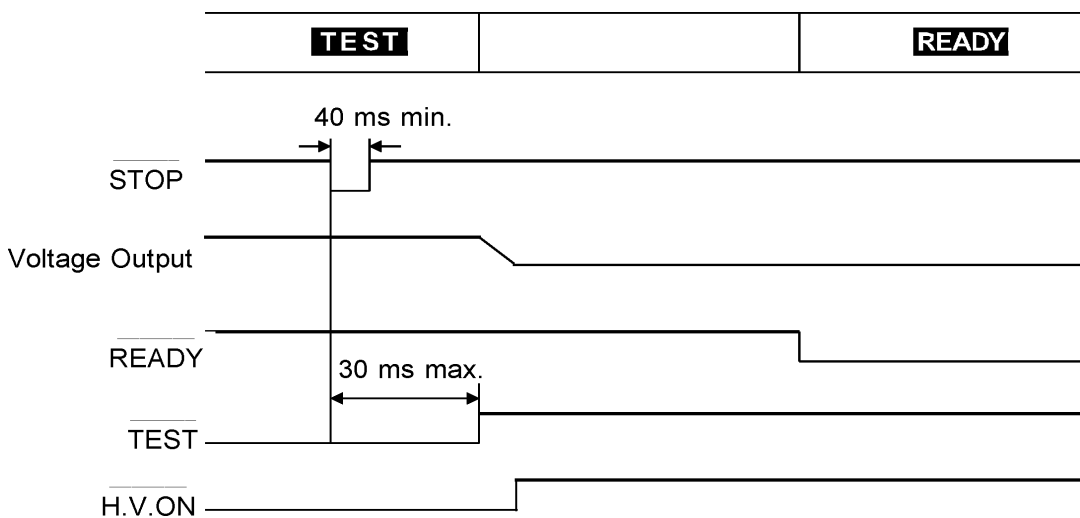

(4) Auto test mode switching Timing chart

This figure shows the timing chart of the unit when it is switched to Auto test mode which conducts voltage and insulation resistance tests successively. The unit does not switch to the next test until the measured voltage value drops sufficiently. The TEST signal remains LOW level until the series of tests is complete.

Withstand-voltage test → Insulation-resistance test

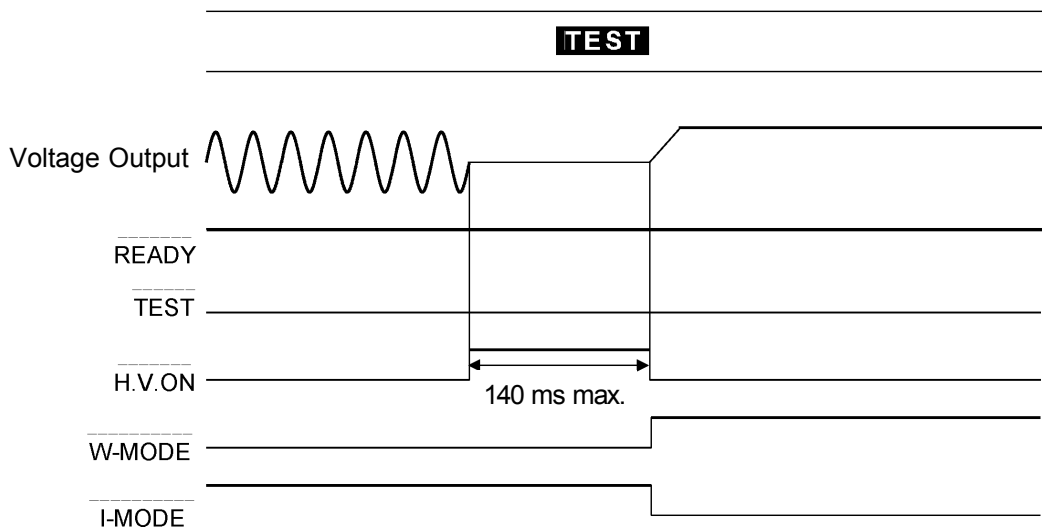

Insulation-resistance test → Withstand-voltage test

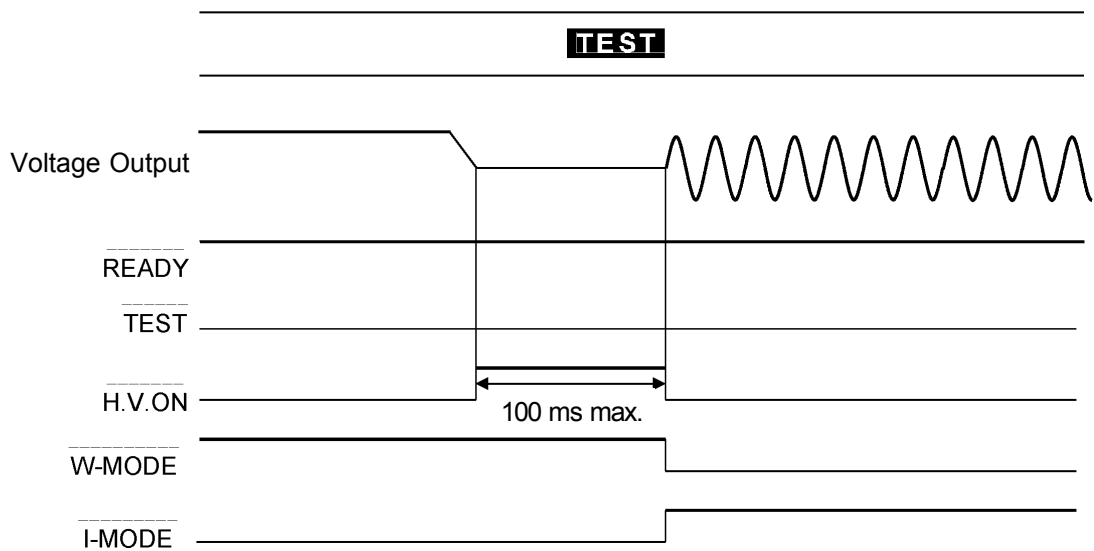

8.2 Status Out



Do not connect units that require a current of 0.5 A or higher to the STATUS OUT relay terminal. Doing so may damage the unit.

(1) Relay terminal

Maximum input voltage	250 VAC, 30 VDC
Maximum current point	0.5 A
Recommended wire	Single standard: 1.2 mm (AWG16) Multi-standard: 1.25 mm ² (AWG16) Standard diameter: Min. 0.18 mm
Usable limits	Single standard: 0.4 ~ 1.2 mm (AWG26 to 16) Multi-standard: 0.3 ~ 1.25 mm ² (AWG22 to 16), Standard diameter: Min. 0.18 mm
Standard insulation stripping length	11 mm

(2) Output settings

1. Make sure that the unit is OFF.
2. Make sure that the analog voltmeter reads 0 kV.
3. Make sure that the desired settings for the STATUS OUT dip switch have been made. When any one of the settings for the STATUS OUT dip switch is ON, the relay point for the STATUS OUT terminal is also ON.

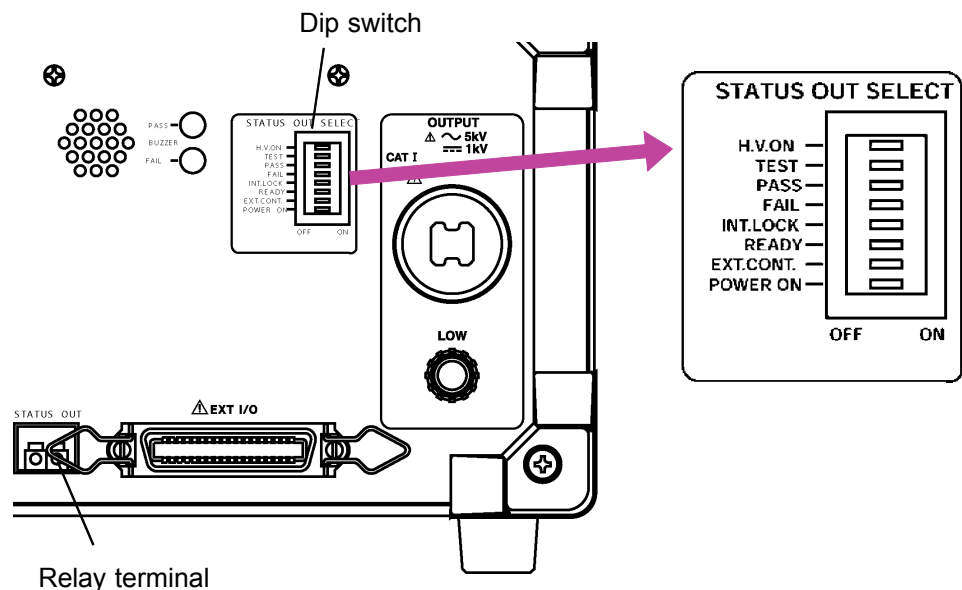

(3) Output settings that can be set with the STATUS OUT DIP switch

H.V. ON	When a voltage is output. Operates together with the DANGER lamp.
TEST	Testing in progress. When TEST lights up or flashes.
PASS	In the PASS state. When PASS lights up.
FAIL	In the FAIL state. When FAIL lights up.
INT.LOCK	In the INTERLOCK state.
READY	In the READY state. When READY lights up.
EXT.CONT.	When controlled externally. When controlled with the external I/O, REMOTE CONTROL BOX, or RS-232C interface. (When " EXT " lights up on the display screen.)
POWER-ON	When the unit is ON.

(4) Connection method

1. Make sure that the unit is OFF.
2. Make sure that the analog voltmeter reads 0 kV.
3. Prepare a 100 VAC power cord, remove the socket end as illustrated, and modify the inner lines into ring terminals. When you are using a grounded three-core power cord, wrap the ground line with insulated tape, as it is not used. In addition, expose the inner lines of the power cord at the center of the cord, and cut one of them. Expose the inner wire of the cut line by stripping the outer covering.

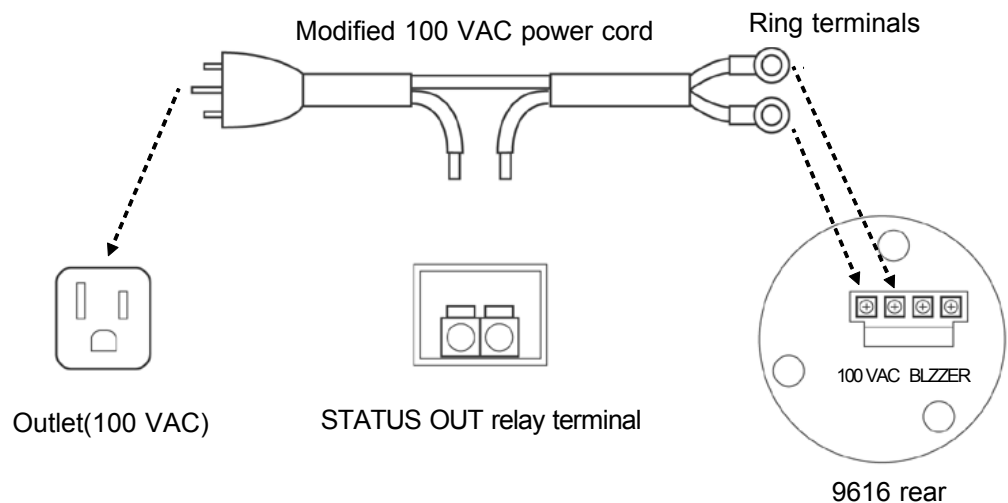

4. Connect the ring terminals to the 100 VAC terminals on the rear of the 9616. For details, refer to the instruction manual supplied with the 9616.
5. Connect the stripped wire to the STATUS OUT relay terminal on the rear panel of the 3159.

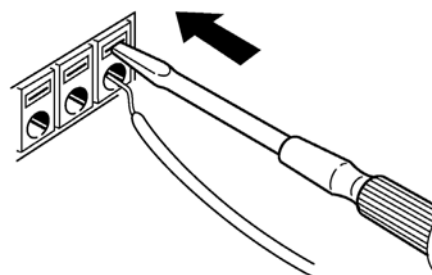

- (1) Push the tab with a flatblade screwdriver or similar.
- (2) While keeping the tab depressed, insert a stripped wire into the connector opening.
- (3) Release the tab to lock the wire.
6. Plug the modified power cord into the power outlet. Only 100 VAC electrical outlets can be used.

8.3 Buzzer

A buzzer sounds during PASS or FAIL screening and in the event of an error due to improper key operations. Two buzzer volume adjustment knobs are provided on the rear panel: one for PASS screening and one for FAIL screening. Volume adjustments can be made using the knobs.

1. Check the analog voltmeter and the **DANGER** lamp to make sure a voltage is not being output.
2. Using a No. 0 Phillips screwdriver or 3-mm slotted screwdriver, adjust the volume adjustment knob. To increase the volume, turn the knob clockwise. To decrease it, turn it counterclockwise.

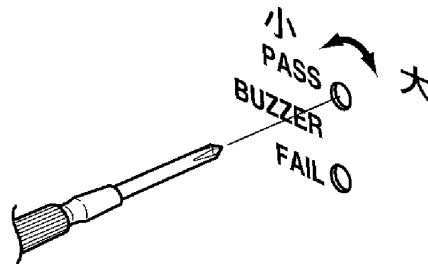

NOTE

- If an excessive force is placed on the volume adjustment knob, it may be fractured.
- The buzzer that sounds in the event of an error caused by improper key operations is at the same volume as the buzzer that sounds for FAIL screening.

Chapter 9

RS-232C Interface

9.1 Specifications

The RS-232C settings of 3159 are as follows. Since the 3159 settings are fixed and cannot be changed, these settings must be matched on the computer side.

RS-232C Settings

Transmission mode	Start-stop synchronization, full duplex
Transfer rate	9600 bps
Data length	8 bit
Parity	None
Stop bit	1 bit
Hand shake	No X flow, hardware flow control
Delimiter	CR, CR + LF for reception CR + LF for transmission

No hardware flow control. RTS is connected with CTS in the 3159.

Electrical Characteristics

Input voltage limit	+5 V to +15 V	: ON
	-15 V to -5 V	: OFF
Out put voltage (load resistance 3 to 7 k Ω)	+5 V to +9 V	: ON
	-9 V to -5 V	: OFF

Connector

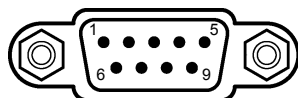

RS-232C

Pin arrangement of interface connector (D-sub 9Pin male)

The signal lines of the 3159's RS-232C connector are as follows.

Pin number	Signal	IN/OUT	Contents
2	RxD	IN	Incoming data
3	TxD	OUT	Outgoing data
5	GND	GND	Signal ground
Other pins are not used			

9.2 Connection Method

Use a cross cable for connection to the PC. If the hardware flow control signal (RTS and CTS) is not used, the 3159 will not perform hardware flow control.

RTS is connected with CTS in the 3159.

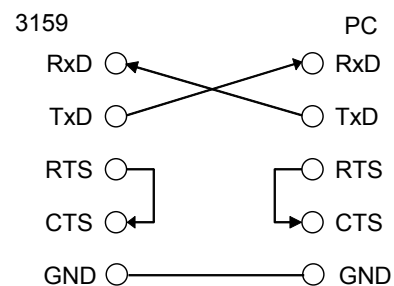
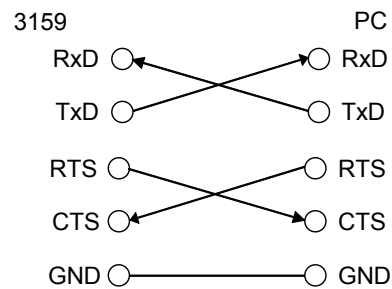

Connecting cable

Connector on cable side: D-Sub 9 Pin female

Connection: Reverse connection

Connection to Computer

1. Connect the 3159 to the computer using a cross cable.
2. Perform the RS-232C settings on the computer side. For details on how to make the settings, refer to the instruction manual for the computer.

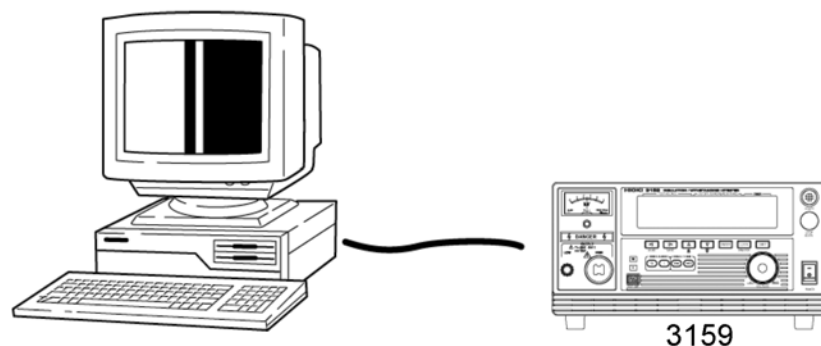

9.3 Command Transfer Methods

The command is issued from the computer.

When the 3159 receives the incoming command from the computer, it executes the processing specified by the command.

When 3159 has completed processing of the command, it always returns a response to the computer.

When the computer has confirmed the response, it sends the next command.

"RMT" lights up on the screen during interface communication.

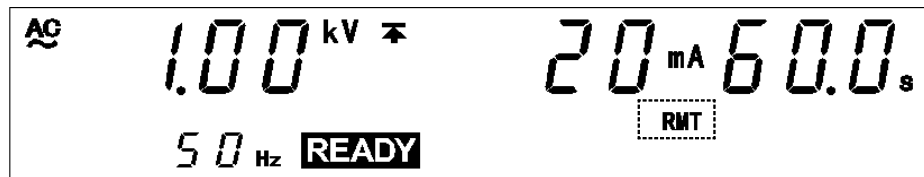

NOTE

Every time the computer has sent a command, a response is always returned. Make sure that the computer only sends the next command after it has received the response to the previous command issued from the 3159.

If multiple commands are sent consecutively, the 3159 may not execute the commands, or command errors may occur.

Command Format

Command Format

The 3159 commands have the following structure.

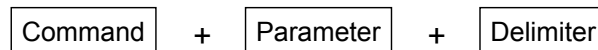

The command and the parameter are separated by " " (one character space)

If there is no parameter, send the delimiter after the command.

The command may consist of both upper and lower case letters.

Make sure to use one character space as the separator between the command and the parameter.

- (1) When the command contains a parameter
:CONF:WITH:CUPP 5.0 (+ delimiter)
the command format consists of the command :CONF:CUPP followed by the separator " ". Then follows the parameter"5.0". Following the parameter comes the delimiter.
- (2) When the command contains no parameter
:STOP (+ delimiter)
the command format consists of the command :STOP immediately followed by the delimiter.

NOTE

The meaning of the delimiter is to separate commands and data. When the 3159 receives the delimiter, it starts analysis of the command.

Response format

When a command is sent to 3159 processes the command. When processing is completed, 3159 always returns a response.

- (1) When there is no information from 3159
OK (+ delimiter)
- (2) When there is information from 3159 (measurement values, etc.),
Response character string related to the command (+delimiter)
- (3) When the command contained an error,
CMD ERR (+delimiter) : Command error
EXEC ERR (+delimiter) : Execution error
- (4) When the command contained an Transmission error,
TIME OUT ERR (+delimiter) : Time out error
(When the delimiter is not transmitted for approximately 10 seconds)
SIO ERR : Serial Transmission error

Parameters

The 3159 uses parameters composed of decimal numbers. There are three different formats for decimal data: NR1, NR2, and NR3. Each has two values: one with a code and one without it. A value without a code is regarded as a positive number. If a number exceeds the accuracy resolution of the 3159, the value is rounded up or down.

NR1 format: Integer data
+12, -23, 34

NR2 format: Fixed point numbers
+1.23, -23.45, 3.456

In the 3159, a format is specified for each command. (See Section 9.5)

Delimiter

Depending on transmission direction, the delimiter is as follows.

From computer to 3159: CR or CR + LF

From 3159 to computer: CR + LF

9.4 Command

Command

Explanation of Command Reference

Syntax	Describes the syntax of the command.
Response syntax	Explains the received data.
<data>	Explains the parameter data.
Function	Explains the actions specified by the command.
Example	Command execution examples. Transmission Denotes command from the computer. Response Denotes command from 3159.
Error	Describes errors that may occur when the command is executed.

9.4.1 Common Command Messages

*IDN?

Queries manufacturer's name, model name, and software version.

Syntax	*IDN?
Response syntax	<data>
<data>	Manufacturer's name, Model name, Serial number (Not used - always zero), Software version
Function	Queries manufacturer's name, model name, and software version.
Example	Queries manufacturer's name, model name, and software version.
Transmission	*IDN?
Response	HIOKI,3159,0,V01.00

*RST

Performs device initial setting.

Syntax	*RST																				
Response syntax	OK Resetting completion																				
Function	Resets the 3159. The items which are reset are listed below.																				
	<table> <tr> <td>Withstand voltage mode (initial setting)</td> <td>Insulation resistance mode (initial setting)</td> </tr> <tr> <td>Comparative voltage value setting: OFF</td> <td>Test time setting: ON</td> </tr> <tr> <td>Test time setting: ON</td> <td>Upper limit value setting: OFF</td> </tr> <tr> <td>Lower limit value setting: OFF</td> <td>Test voltage value: 500 V</td> </tr> <tr> <td>Comparative voltage value: 0.00 kV</td> <td>Upper limit value: 2000 mΩ</td> </tr> <tr> <td>Upper limit value: 0.2 mA</td> <td>Lower limit value: 1000 mΩ</td> </tr> <tr> <td>Lower limit value: 0.1 mA</td> <td>Test time: 0.5 s</td> </tr> <tr> <td>Test time: 0.5 s</td> <td></td> </tr> <tr> <td>Output voltage range: 2.5 kV</td> <td>Optional Functions</td> </tr> <tr> <td></td> <td>0.1.0.0 0.0.0.0 0.0.0 (ON: FAIL hold only)</td> </tr> </table>	Withstand voltage mode (initial setting)	Insulation resistance mode (initial setting)	Comparative voltage value setting: OFF	Test time setting: ON	Test time setting: ON	Upper limit value setting: OFF	Lower limit value setting: OFF	Test voltage value: 500 V	Comparative voltage value: 0.00 kV	Upper limit value: 2000 mΩ	Upper limit value: 0.2 mA	Lower limit value: 1000 mΩ	Lower limit value: 0.1 mA	Test time: 0.5 s	Test time: 0.5 s		Output voltage range: 2.5 kV	Optional Functions		0.1.0.0 0.0.0.0 0.0.0 (ON: FAIL hold only)
Withstand voltage mode (initial setting)	Insulation resistance mode (initial setting)																				
Comparative voltage value setting: OFF	Test time setting: ON																				
Test time setting: ON	Upper limit value setting: OFF																				
Lower limit value setting: OFF	Test voltage value: 500 V																				
Comparative voltage value: 0.00 kV	Upper limit value: 2000 mΩ																				
Upper limit value: 0.2 mA	Lower limit value: 1000 mΩ																				
Lower limit value: 0.1 mA	Test time: 0.5 s																				
Test time: 0.5 s																					
Output voltage range: 2.5 kV	Optional Functions																				
	0.1.0.0 0.0.0.0 0.0.0 (ON: FAIL hold only)																				
Example	Performs device initial setting.																				
Transmission	*RST																				
	Performs device initial setting.																				
Response	OK Resetting completion																				

9.4.2 Specific Command Messages

:WITH:VREF

Enables and disables the Voltage Comparator for withstand voltage tests.

Syntax :WITH:VREF <data>

<data> OFF/ON

Response syntax OK Voltage Comparator ON/OFF settings completion.

Function Enables and disables the Voltage Comparator for withstand voltage tests, in the READY state.

Example Enables the Voltage Comparator for a withstand voltage test.

Transmission :WITH:VREF ON
Voltage Comparator enablement is ON.
Response OK
Settings completion

Error The execution of this command in a state other than the READY state causes an execution error.

:WITH:VREF?

Queries the Voltage Comparator enablement for withstand voltage tests.

Syntax :WITH:VREF?

Response syntax <data>

<data> OFF/ON

Function Queries the Voltage Comparator enablement for withstand voltage tests.

Example Queries the Voltage Comparator enablement for withstand voltage tests.

Transmission :WITH:VREF?
Queries the Voltage Comparator enablement.
Response ON
The Voltage Comparator enablement is ON.

:WITH:CLOW

Enables and disables the lower-limit value for withstand voltage tests.

Syntax :WITH:CLOW <data>

<data> OFF/ON

Response syntax OK
Withstand voltage test lower-limit value ON/OFF settings completion

Function Enables and disables the lower-limit value for withstand voltage tests, in the READY state.

Example Enables the lower-limit value for a withstand voltage test.

Transmission :WITH:CLOW OFF
The withstand voltage test lower-limit value enablement is ON.
Response OK
Settings completion

Error The execution of this command in a state other than the READY and SETTING states causes an execution error.

Note that an execution error occurs when setting the test lower limit to on when the test lower limit is equal to or greater than the test upper limit.

:WITH:CLOW?

Queries the lower-limit value enablement for withstand voltage tests.

Syntax	:WITH:CLOW?
Response syntax	<data>
<data>	OFF/ON
Function	Queries the lower-limit value enablement for withstand voltage tests.
Example	Queries the lower-limit value enablement for withstand voltage tests.
Transmission	:WITH:CLOW?
	Queries the lower-limit value enablement for withstand voltage tests.
Response	OFF
	The lower-limit value enablement is OFF.

:WITH:TIM

Enables and disables the test time for withstand voltage tests.

Syntax	:WITH:TIM <data>
<data>	OFF/ON
Response syntax	OK Withstand voltage test time ON/OFF settings completion
Function	Enables and disables the test time for withstand voltage tests, in the READY state.
Example	Enables the test time for a withstand voltage test.
Transmission	:WITH:TIM ON
	The withstand voltage test time enablement is ON.
Response	OK Settings completion
Error	The execution of this command in a state other than the READY state causes an execution error.

:WITH:TIM?

Queries the test time enablement for withstand voltage tests.

Syntax	:WITH:TIM?
Response syntax	<data>
<data>	OFF/ON
Function	Queries the test time enablement for withstand voltage tests.
Example	Queries the test time enablement for withstand voltage tests.
Transmission	:WITH:TIM?
	Queries the withstand voltage test time enablement.
Response	ON
	The test time enablement is ON.

:INS:RUPP

Enables and disables the upper-limit value for insulation resistance tests.

Syntax :INS:RUPP <data>

<data> OFF/ON

Response OK

syntax Insulation resistance test upper-limit value ON/OFF settings completion

Function Enables and disables the upper-limit value for insulation resistance tests, in the READY state.

Example Enables the upper-limit value for an insulation resistance test.

Transmission :INS:RUPP OFF

The insulation resistance upper-limit value enablement is OFF.

Response OK

Settings completion

Error The execution of this command in a state other than the READY state causes an execution error. Note that an execution error occurs when setting the test upper limit to on when the test lower limit is greater than the test upper limit.

:INS:RUPP?

Queries the upper-limit value enablement for insulation resistance tests.

Syntax :INS:RUPP?

Response <data>

syntax

<data> OFF/ON

Function Queries the upper-limit value enablement for insulation resistance tests.

Example Queries the upper-limit value enablement for insulation resistance tests.

Transmission :INS:RUPP?

Queries the upper-limit value enablement for insulation resistance tests.

Response OFF

The upper-limit value enablement is OFF.

:INS:TIM

Enables and disables the test time for insulation resistance tests.

Syntax :INS:TIM <data>

<data> OFF/ON

Response OK

syntax Insulation resistance test time enablement settings completion

Function Enables and disables the test time for insulation resistance tests, in the READY state.

Example Enables the test time for an insulation resistance test.

Transmission :INS:TIM ON

The insulation resistance test time enablement is ON.

Response OK

Settings completion

Error The execution of this command in state other than the READY state causes an execution error.

:INS:TIM?

Queries the test time enablement for insulation resistance tests.

Syntax	:INS:TIM?
Response syntax	<data>
<data>	OFF/ON
Function	Queries the test time enablement for insulation resistance tests.
Example	Queries the test time enablement for insulation resistance tests.
Transmission	:INS:TIM?
	Queries the test time enablement for insulation resistance tests.
Response	ON
	The test time enablement is ON.

:CONF:WITH:VREF

Sets the comparative-voltage value for withstand voltage tests.

Syntax	:CONF:WITH:VREF <data>
<data>	0.00 to 5.00 (NR2)
Response syntax	OK
Function	Sets the comparative-voltage value for withstand voltage tests, in the READY state.
Example	Sets the comparative-voltage value for withstand voltage tests.
Transmission	:CONF:WITH:VREF 1.50
	The comparative-voltage value is set to 1.50 kV.
Response	OK
	Settings completion
Error	The execution of this command in a state other than the READY state causes an execution error.

:CONF:WITH:VREF?

Queries the comparative-voltage value for withstand voltage tests.

Syntax	:CONF:WITH:VREF?
Response syntax	<data>
<data>	0.00 to 5.00 (NR2)
Function	Queries the comparative-voltage value for withstand voltage tests.
Example	Queries the comparative-voltage value for withstand voltage tests.
Transmission	:CONF:WITH:VREF?
	Queries the comparativevoltage value.
Response	1.50
	The comparative-voltage value is 1.50 kV.

:CONF:WITH:CUPP

Sets the upper-limit value for withstand voltage tests.

Syntax :CONF:WITH:CUPP <data>

<data> 0.1 to 120 (NR1 or NR2)

Response syntax OK

Function Sets the upper-limit value for withstand voltage tests, in the READY state.

Example Sets the upper-limit value for withstand voltage tests.

Transmission :CONF:WITH:CUPP 5.0

The withstand voltage test upper-limit value is set to 5.0 mA.

Response OK

Settings completion

Error The execution of this command in a state other than the READY state causes an execution error. Note that an execution error occurs when setting the test upper limit to a value less than the test lower limit when the latter is on.

:CONF:WITH:CUPP?

Queries the upper-limit value for withstand voltage tests.

Syntax :CONF:WITH:CUPP?

Response syntax <data>

<data> 0.1 to 120 (NR1 or NR2)

Function Queries the upper-limit value for withstand voltage tests.

Example Queries the upper-limit value for withstand voltage tests.

Transmission :CONF:WITH:CUPP?

Queries the withstand voltage test upper-limit value.

Response 5.0

The upper-limit value is 5.0 mA.

:CONF:WITH:CLOW

Sets the lower-limit value for withstand voltage tests.

Syntax :CONF:WITH:CLOW <data>

<data> 0.1 to 120 (NR1 or NR2)

Response syntax OK

Function Sets the lower-limit value for withstand voltage tests, in the READY state.

Example Sets the lower-limit value for withstand voltage tests.

Transmission :CONF:WITH:CLOW 0.1

The withstand voltage test lower-limit value is set to 0.1 mA.

Response OK

Settings completion

Error The execution of this command in state other than the READY state causes an execution error. Note that an execution error occurs when setting the test lower limit to a value more than the test upper limit when the former is on.

:CONF:WITH:CLOW?

Queries the lower-limit value for withstand voltage tests.

Syntax	:CONF:WITH:CLOW?
Response syntax	<data>
<data>	0.1 to 120 (NR1 or NR2)
Function	Queries the lower-limit value for withstand voltage tests.
Example	Queries the lower-limit value for withstand voltage tests.
Transmission	:CONF:WITH:CLOW?
	Queries the withstand voltage test lower-limit value.
Response	0.1
	The lower-limit value is 0.1 mA.

:CONF:WITH:TIM

Sets the test time for withstand voltage tests.

Syntax	:CONF:WITH:TIM <data>
<data>	0.5 to 999 (NR1 or NR2)
Response syntax	OK
Function	Sets the test time for withstand voltage tests, in the READY state.
Example	Sets the test time for withstand voltage tests.
Transmission	:CONF:WITH:TIM 30.0
	The withstand voltage test time is set to 30.0 s.
Response	OK
	Settings completion
Error	The execution of this command in a state other than the READY state causes an execution error.

:CONF:WITH:TIM?

Queries the test time for withstand voltage tests.

Syntax	:CONF:WITH:TIM?
Response syntax	<data>
<data>	0.5 to 999 (NR1 or NR2)
Function	Queries the test time for withstand voltage tests.
Example	Queries the test time for withstand voltage tests.
Transmission	:CONF:WITH:TIM?
	Queries the withstand voltage test time.
Response	30.0
	The test time is set to 30.0 s.

:CONF:WITH:RANG

Sets the voltage range for withstand voltage tests.

Syntax :CONF:WITH:RANG <data>

<data> 2.5, 5.0 (NR2)

Response syntax OK

Function Sets the voltage range for withstand voltage tests, in the READY state.

Example Sets the voltage range for withstand voltage tests.

Transmission >:CONF:WITH:RANG 2.5

The withstand voltage test voltage range is set to 2.5 kV.

Response OK

Settings completion

Error The execution of this command in a state other than the READY state causes an execution error.

:CONF:WITH:RANG?

Queries the voltage range for withstand voltage tests.

Syntax :CONF:WITH:RANG?

Response syntax <data>

<data> 2.5, 5.0 (NR2)

Function Queries the voltage range for withstand voltage tests.

Example Queries the voltage range for withstand voltage tests.

Transmission :CONF:WITH:RANG?

Queries the withstand voltage test voltage range.

Response 2.5

The voltage range is 2.5 kV.

:CONF:WITH?

Queries the withstand voltage test settings.

Syntax :CONF:WITH?

Response syntax <data>

<data> Withstand voltage test comparativevoltage value: 0.00 to 5.00 (NR2)
Upper-limit value : 0.1 to 120 (NR1 or NR2)
Lower-limit value : 0.1 to 119 (NR1 or NR2)
Test time value : 0.5 to 999 (NR1 or NR2)
Voltage range : 2.5 or 5.0 (NR2)

Function Queries the withstand voltage test settings.

Example Queries the withstand voltage test settings.

Transmission :CONF:WITH?

Queries the withstand voltage test settings.

Response 1.50,5.0,0.1,30.0,2.5

Comparative voltage: 1.50 kV, Upper-limit value: 5 mA,

Lower-limit value: 0.1 mA, Test time value: 30.0 s, Voltage range: 2.5 kV

:CONF:INS:VOLT

Sets the test voltage value for insulation resistance tests.

Syntax :CONF:INS:VOLT <data>

<data> 500,1000 (NR1)

Response syntax OK

Function Sets the test voltage value for insulation resistance tests, in the READY state.

Example Sets the test voltage value for insulation resistance tests.

Transmission :CONF:INS:VOLT 500

The insulation resistance test voltage value is set to 500 V.

Response OK

Settings completion

Error The execution of this command in a state other than the READY state causes an execution error.

:CONF:INS:VOLT?

Queries the test voltage value for insulation resistance tests.

Syntax :CONF:INS:VOLT?

Response syntax <data>

<data> 500,1000 (NR1)

Function Queries the test voltage value for insulation resistance tests.

Example Queries the test voltage value for Insulation resistance tests.

Transmission :CONF:INS:VOLT?

Queries the insulation resistance test voltage value.

Response 500

The test voltage value is 500 V.

:CONF:INS:RUPP

Sets the upper-limit value for insulation resistance tests.

Syntax :CONF:INS:RUPP <data>

<data> 0.20 to 2000 (NR1 or NR2)

Response syntax OK

Function Sets the upper-limit value for insulation resistance tests, in the READY state.

Example Sets the upper-limit value for insulation resistance tests.

Transmission :CONF:INS:RUPP 2000

The insulation resistance test upper-limit value is set to 2000 MΩ.

Response OK

Settings completion

Error The execution of this command in a state other than the READY state causes an execution error. Note that an execution error occurs when setting the test upper limit to a value less than the test lower limit when the former is on.

:CONF:INS:RUPP?

Queries the upper-limit value for insulation resistance tests.

Syntax	:CONF:INS:RUPP?
Response syntax	<data>
<data>	0.20 to 2000 (NR1 or NR2)
Function	Queries the upper-limit value for insulation resistance tests.
Example	Queries the upper-limit value for insulation resistance tests.
Transmission	:CONF:INS:RUPP?
	Queries the insulation resistance upper-limit value.
Response	2000
	The upper-limit value is 2000 MΩ.

:CONF:INS:RLOW

Sets the lower-limit value for insulation resistance tests.

Syntax	:CONF:INS:RLOW <data>
<data>	0.20 to 2000 (NR1 or NR2)
Response syntax	OK
Function	Sets the lower-limit value for insulation resistance tests, in the READY state.
Example	Sets the lower-limit value for insulation resistance tests.
Transmission	:CONF:INS:RLOW 10.0
	The insulation resistance test lower-limit value is set to 10.0 MΩ.
Response	OK
	Settings completion
Error	The execution of this command in a state other than the READY state causes an execution error. Note that an execution error occurs when setting the test lower limit to a value more than the test upper limit when the latter is on.

:CONF:INS:RLOW?

Queries the lower-limit value for insulation resistance tests.

Syntax	:CONF:INS:RLOW?
Response syntax	<data>
<data>	0.20 to 2000 (NR1 or NR2)
Function	Queries the lower-limit value for insulation resistance tests.
Example	Queries the lower-limit value for insulation resistance tests.
Transmission	:CONF:INS:RLOW?
	Queries the insulation resistance lower-limit value.
Response	10.0
	The lower-limit value is 10.0 MΩ.

:CONF:INS:TIM

Sets the test time for insulation resistance tests.

Syntax :CONF:INS:TIM <data>

<data> 0.5 to 999 (NR1 or NR2)

Response syntax OK

Function Sets the test time for insulation resistance tests, in the READY state.

Example Sets the test time for insulation resistance tests.

Transmission :CONF:INS:TIM 10.0

The insulation resistance test time is set to 10.0 s.

Response OK

Settings completion

Error The execution of this command in a state other than the READY state causes an execution error.

:CONF:INS:TIM?

Queries the test time for insulation resistance tests.

Syntax :CONF:INS:TIM?

Response syntax <data>

<data> 0.5 to 999 (NR1 or NR2)

Function Queries the test time for insulation resistance tests.

Example Queries the test time for insulation resistance tests.

Transmission :CONF:INS:TIM?

Queries the insulation resistance test time.

Response 10.0

The test time is set to 10.0 s.

:CONF:INS?

Queries the insulation resistance test settings.

Syntax :CONF:INS?

Response syntax <data>

<data> Insulation resistance test voltage value: 500,1000 (NR1)

Upper-limit value : 0.2 to 2000 (NR1 or NR2)

Lower-limit value : 0.2 to 2000 (NR1 or NR2)

Test time value : 0.5 to 999 (NR1 or NR2)

Function Queries the insulation resistance test settings.

Example Queries the insulation resistance test settings.

Transmission :CONF:INS?

Queries the insulation resistance test settings.

Response 500,2000,10.0,10.0

Test voltage: 500 V; Upper-limit value: 2000 M Ω ;

Lower-limit value: 10.0 M Ω ; Test time value: 10.0 s

:STAR

Starting a test.

Syntax :STAR

Response syntax OK Starts a test in the READY state.

Function To start a test using this command, in the optional functions, set "START" for the RS command to "1: Set."

Example Starting a test
 Transmission :STAR
 Test Start
 Response OK
 Completion

Error The execution of this command in a state other than the READY state causes an execution error. In the optional functions, if the RS command START is set to "0: Not set," an execution error will occur.
 Note that an execution error occurs when double action is set to "1: ON" on the optional function setting screen.

:STOP

Forcibly ends a test and releases the hold state.

Syntax :STOP

<data> OK

Function In the TEST state, forcibly ends a test. Furthermore, releases the Hold function and returns to the READY state. However, in the optional functions, when "FAIL Mode Function" is set to ON, the Hold function cannot be disabled by this command.

Example Forcibly ends a test.
 Transmission :STOP
 Forcibly ends a test.
 Response OK
 Completion

Error In the optional functions, when "FAIL Mode Function" is set to ON, an execution error will occur if the unit is in the FAIL Hold Mode.

:STAT?

Queries the state.

Syntax	:STAT?	
Response syntax	<data>	
<data>	WPASS : Withstand voltage mode	PASS
	IPASS : Insulation resistance mode	PASS
	WUFAIL : Withstand voltage mode	UPPER FAIL
	IUFAIL : Insulation resistance mode	UPPER FAIL
	WLFAIL : Withstand voltage mode	LOWER FAIL
	ILFAIL : Insulation resistance mode	LOWER FAIL
	WREADY : Withstand voltage mode	READY
	IREADY : Insulation resistance mode	READY
	WTEST : Withstand voltage mode	TEST
	ITEST : Insulation resistance mode	TEST
	WULFAIL : Withstand voltage mode	FAIL
	NULL : Others	
Function	Queries the state.	
Example	Queries the state.	
	Transmission	:STAT?
		Queries the state.
	Response	WREADY
		In the withstand voltage mode READY state.

:MODE

Sets the test mode.

Syntax	:MODE <data>	
<data>	MWITH : Withstand voltage mode	
	MINS : Insulation resistance mode	
	AWI : Withstand voltage test → insulation resistance test	
	AIW : Insulation resistance test → withstand voltage test	
Response syntax	OK	
Function	In the READY state, sets the test mode.	
Example	Sets the test mode.	
	Transmission	:MODE AWI
		Sets the test mode: withstand voltage test → insulation resistance test.
	Response	OK
		Settings completion
Error	The execution of this command in a state other than the READY state causes an execution error. Note that an execution error occurs when auto test mode is selected with test time set off in withstand voltage mode or insulation resistance test mode.	

:MODE?

Queries the test mode.

Syntax	:MODE?
Response syntax	<data>
<data>	MWITH : Withstand voltage mode MINS : Insulation resistance mode AWI : Withstand voltage test → insulation resistance test AIW : Insulation resistance test → withstand voltage test
Function	Queries the test mode.
Example	Queries the test mode. Transmission :MODE? Queries the test mode. Response AWI Test mode: withstand voltage → test insulation resistance test

:MEAS:RES:WITH?

Queries the withstand voltage test result.

Syntax	:MEAS:RES:WITH?
Response syntax	<data>
<data>	Measured voltage value, measured current value, test time elapsed determination. Excluding determination : NR2 Determination : PASS, UFAIL, LFAIL, ULFAIL, OFF (See Section 9.5)
Function	Queries the results of the preceding test. Returns the screening results and valid values at termination of the preceding test. The test results are updated upon termination of a new test.
Example	Queries the measured value. Transmission :MEAS:RES:WITH? Queries the withstand voltage test results. Response 1.50,2.00,30.0,PASS Measured voltage value: 1.50 kV; Measured current value: 2.00 mA; Test time elapsed: 30.0 s; Determination: PASS

:MEAS:WITH:VOLT?

Queries the measured voltage value for withstand voltage tests.

Syntax	:MEAS:WITH:VOLT?
Response syntax	<data>
<data>	Withstand voltage test measured voltage value (NR2)
Function	Queries the measured voltage value for withstand voltage tests.
Example	Queries the measured voltage value for withstand voltage tests. Transmission :MEAS:WITH:VOLT? Queries the measured voltage value for withstand voltage tests. Response 1.50 The measured voltage value is 1.50 kV.

:MEAS:WITH:CURRE?

Queries the measured current value for withstand voltage tests.

Syntax	:MEAS:WITH:CURRE?
Response syntax	<data>
<data>	Withstand voltage test measured current value (NR1 or NR2)
Function	Queries the measured current value for withstand voltage tests.
Example	Queries the measured current value for withstand voltage tests.
Transmission	:MEAS:WITH:CURRE?
	Queries the measured current value for withstand voltage tests.
Response	2.00
	The measured current value is 2.00 mA.

:MEAS:WITH:TIM?

Queries the test time elapsed for withstand voltage tests.

Syntax	:MEAS:WITH:TIM?
Response syntax	<data>
<data>	Withstand voltage test time elapsed (NR1 or NR2)
Function	Queries the test time elapsed for withstand voltage tests.
Example	Queries the test time elapsed for withstand voltage tests.
Transmission	:MEAS:WITH:TIM?
	Queries the test time elapsed for withstand voltage tests.
Response	30.0
	The test time elapsed is 30.0 s.

:MEAS:RES:INS?

Queries the insulation resistance test result.

Syntax	:MEAS:RES:INS?
Response syntax	<data>
<data>	Measured voltage value, measured resistance value, test time elapsed determination. Excluding determination : NR1 or NR2 Determination : PASS, UFAIL, LFAIL, ULFAIL, OFF
Function	Queries the results of the preceding test. Returns the screening results and valid values at termination of the preceding test. The test results are updated upon termination of a new test.
Example	Queries the measured value.
Transmission	:MEAS:RES:INS?
	Queries the insulation resistance test result.
Response	510,100,10.0,PASS
	Measured voltage value: 510 V; Measured current value: 100 M Ω ; Test time elapsed: 10.0 s; Determination: PASS

:MEAS:INS:VOLT?

Queries the measured voltage value for insulation resistance tests.

Syntax	:MEAS:INS:VOLT?
Response syntax	<data>
<data>	Insulation resistance test measured voltage value (NR1)
Function	Queries the measured voltage value for insulation resistance tests.
Example	Queries the measured voltage value for insulation resistance tests.
Transmission	:MEAS:INS:VOLT?
Response	510 The measured voltage value for insulation resistance tests. The measured voltage value is 510 V.

:MEAS:INS:RES?

Queries the measured resistance value for insulation resistance tests.

Syntax	:MEAS:INS:RES?
Response syntax	<data>
<data>	Insulation resistance test measured resistance value (NR1)
Function	Queries the measured resistance value for insulation resistance tests.
Example	Queries the measured resistance value for insulation resistance tests.
Transmission	:MEAS:INS:RES?
Response	100 Queries the measured resistance value for insulation resistance tests. The measured resistance value is 100 MΩ.

:MEAS:INS:TIM?

Queries the test time elapsed for insulation resistance tests.

Syntax	:MEAS:INS:TIM?
Response syntax	<data>
<data>	Insulation resistance test time elapsed (NR1)
Function	Queries the test time elapsed for insulation resistance tests.
Example	Queries the test time elapsed for insulation resistance tests.
Transmission	:MEAS:INS:TIM?
Response	10.0 Queries the test time elapsed for insulation resistance tests. The test time elapsed is 10.0 s.

:MEM:WITH:FILE?

Queries the content of data saved for withstand voltage tests.

Syntax :MEM:WITH:FILE?

Response Comparative-voltage value
syntax 0.00 to 5.00 (NR2) Upper limit value 0.1 to 120 (NR1 or NR2)
 Lower limit value 0.1 to 119 (NR1 or NR2)
 Test time setting value 0.5 to 999 (NR1 or NR2)
 Output voltage range 2.5 or 5.0
 When each setting is set to off, "0" will be returned.

<data> 1 to 10 (NR1)

Function Queries the content of saved data for the withstand voltage test file numbers specified in <data>.

Example Queries the data saved for withstand voltage tests.

Transmission :MEM:WITH:FILE? 1

Queries the Memory File 1 Settings for withstand voltage tests.

Response 1.20,5.0,0,20.0,2.5

Comparative voltage value: 1.20 kV; Upper-limit value: 5.0 mA;
 Lower-limit value: OFF; Test time:20.0 s; Output voltage range: 2.5 kV

Error The execution of this command in a state other than the READY state causes an execution error.
 An execution error occurs when file numbers other than 1 to 10 are specified.

:MEM:WITH:LOAD

Loads withstand voltage tests saved data.

Syntax :MEM:WITH:LOAD <data>

<data> 1 to 10 (NR1)

Response OK
syntax Output voltage range: 2.5 kV (NR2)

Function Loads the data saved for the withstand voltage test file numbers specified in <data>.

Example Loads withstand voltage tests saved data.

Transmission :MEM:WITH:LOAD 1

Loads the withstand voltage test Memory File 1.

Response OK

Loading completion

Error The execution of this command in a state other than the READY state causes an execution error.
 An execution error occurs when file numbers other than 1 to 10 are specified.

:MEM:WITH:SAVE

Saves data for withstand voltage tests to memory files.

Syntax :MEM:WITH:SAVE <data>

<data> 1 to 10 (NR1)

Response syntax OK

Function Saves the current withstand voltage test settings in the memory file specified in <data>.

Example Saves data for withstand voltage tests to memory files.

Transmission :MEM:WITH:SAVE 2

Saves the withstand voltage test settings in Memory File 2.

Response OK

Save completion

Error The execution of this command in a state other than the READY state causes an execution error. An execution error occurs when file numbers other than 1 to 10 are specified.

:MEM:WITH:CLE

Clears the withstand voltage test data saved to memory files.

Syntax :MEM:WITH:CLE <data>

<data> 1 to 10 (NR1)

Response syntax OK

Function Clears and resets the data saved for the withstand voltage test specified in <data>.

Example Clears the withstand voltage test data saved to memory files.

Transmission :MEM:WITH:CLE 3

Clears and resets the content of withstand voltage test Memory File 3.

Response OK

Clear completion

Error The execution of this command in a state other than the READY state causes an execution error. An execution error occurs when file numbers other than 1 to 10 are specified.

:MEM:INS:FILE?

Queries the content of data saved for insulation resistance tests.

Syntax :MEM:INS:FILE? <data>

<data> 1 to 10 (NR1)

Response syntax Test voltage value 0.00 to 5.00 (NR2)
Upper limit value 0.2 to 2000 (NR1 or NR2)
Lower limit value 0.2 to 2000 (NR1 or NR2)
Test time setting value 0.5 to 999 (NR1 or NR2)
When each setting is set to off, "0" will be returned.

Function Queries the content of saved data for the insulation resistance file specified in <data>.

Example Queries the data saved for insulation resistance tests.

Transmission :MEM:INS:FILE? 1

Queries the insulation resistance test Memory File 1 settings.

Response 1000,0,100.0,5.0

Test voltage: 1000 V; Upper-limit value: OFF;

Lower-limit value: 100.0 M Ω ; Test time: 5.0 s

Error The execution of this command in a state other than the READY state causes an execution error.
An execution error occurs when file numbers other than 1 to 10 are specified.

:MEM:INS:LOAD

Loads data saved for insulation resistance tests.

Syntax :MEM:INS:LOAD <data>

<data> 1 to 10 (NR1)

Response syntax OK

Function Loads the data saved for the insulation resistance file specified in <data>.

Example Loads data saved for insulation resistance tests.

Transmission :MEM:INS:LOAD 1

Loads the insulation resistance test Memory File 1.

Response OK

Loading completion

Error The execution of this command in a state other than the READY state causes an execution error.
An execution error occurs when file numbers other than 1 to 10 are specified.

:MEM:INS:SAVE

Saves data for insulation resistance tests to memory files.

Syntax :MEM:INS:SAVE <data>

<data> 1 to 10 (NR1)

Response syntax OK

Function Saves the current insulation resistance test settings in the memory file specified in <data>.

Example Saves insulation resistance test data to memory files.

Transmission :MEM:INS:SAVE 2

Saves the insulation resistance test settings in Memory File 2.

Response OK

Save completion

Error The execution of this command in a state other than the READY state causes an execution error. An execution error occurs when file numbers other than 1 to 10 are specified.

:MEM:INS:CLE

Clears the insulation resistance test data saved to memory files.

Syntax MEM:INS:CLE <data>

<data> 1 to 10 (NR1)

Response syntax OK

Function Clears and resets the data saved for the insulation resistance test specified in <data>.

Example Clears the insulation resistance test data saved to memory files.

Transmission :MEM:INS:CLE 3

Clears and resets the content of insulation resistance test Memory File 3.

Response OK

Clear completion

Error The execution of this command in a state other than the READY state causes an execution error. An execution error occurs when file numbers other than 1 to 10 are specified.

:SYS:OPT

Sets the optional functions.

Syntax :SYS:OPT <data1><data2><data3><data4><data5><data6><data7><data8><data9><data10><data11>

<data>

- <data1> PASS hold function
0: Not held, 1: Held
- <data2> FAIL hold function
0: Not held, 1: Held
- <data3> Hold function
0: Not held, 1: Held
- <data4> Momentary out function
0: Not set, 1: Set
- <data5> Double Action
0: Not set, 1: Set
- <data6> FAIL mode
0: Not set, 1: Set
- <data7> RS command [START] setting
0: Not set, 1: Set
- <data8> Inter-lock function
0: Not set, 1: Set
- <data9> Voltage comparator position
0: Start test, 1: End test
- <data10> Insulation resistance test measurement range
0: Fixed range, 1: Auto range
- <data11> Insulation resistance test termination mode
0: Test for set time, 1: Terminate test at PASS screening
2: Terminate test at FAIL screening

Response syntax OK

Function Sets the optional functions.

Example Sets the optional functions.

Transmission :SYS:OPT 01000010001

Do not make settings other than the following: FAIL Hold function, RS [START] command settings, end the insulation resistance test at PASS screening.

Response OK
Settings completion

Error The execution of this command in a state other than the READY state causes an execution error. An execution error occurs when a value that is not set is specified.

:SYS:OPT?

Queries the optional function settings.

Syntax :SYS:OPT?

Response syntax <data1><data2><data3><data4><data5><data6><data7><data8><data9><data10><data11>

<data>

- <data1> PASS hold function
0: Not held, 1: Held
- <data2> FAIL hold function
0: Not held, 1: Held
- <data3> Hold function
0: Not held, 1: Held
- <data4> Momentary out function
0: Not set, 1: Set
- <data5> Double Action
0: Not set, 1: Set
- <data6> FAIL mode
0: Not set, 1: Set
- <data7> RS command [START] setting
0: Not set, 1: Set
- <data8> Inter-lock function
0: Not set, 1: Set
- <data9> Voltage comparator position
0: Start test, 1: End test
- <data10> Insulation resistance test measurement range
0: Fixed range, 1: Auto range
- <data11> Insulation resistance test termination mode
0: Test for set time, 1: Terminate test at PASS screening
2: Terminate test at FAIL screening

Function Queries the optional function settings.

Example Queries the optional function settings.

Transmission :SYS:OPT?

Queries the optional function settings.

Response 01000010001

You cannot make settings other than the following: FAIL Hold function, RS [START] command settings, end the insulation resistance test at PASS screening.

9.5 Response Formats

The transmission format is identical to the VFD display format, except that the former lacks spaces (" ").

The response format is identical to the VFD display format, except that the former lacks spaces (" ").

Comparative voltage value, Measured voltage value (Withstand voltage mode)

Transmission and response formats are as follows.

.

Two or three digits (in NR2 format)

Test voltage value, Measured voltage value (Insulation resistance mode)

Transmission and response formats are as follows.

One, two, three or four digits (in NR1 format)

Upper limit value, Lower limit value (Withstand voltage mode)

Transmission and response formats are as follows.

.

Two or three digits (in NR1 or NR2 format)

Upper limit value, Lower limit, Resistance value (Insulation resistance mode)

Transmission and response formats are as follows.

.

Three or four digits (in NR1 or NR2 format)

Measured current value (Withstand voltage mode)

Transmission and response formats are as follows.

.

One, two or three digits (in NR1 or NR2 format)

Output voltage range (Withstand voltage mode)

Transmission and response formats are as follows.

Two digits (NR2 format)

Test time

Transmission and response formats are as follows.

Two or three digits (in NR1 or NR2 format)

Test time elapsed

Response formats are as follows.

Two, three or four digits (in NR2 format)

Others

Transmission and response formats are as follows.

One digit (in NR1 format)

Chapter 10

Specifications

10.1 Basic Specifications

10.1.1 Withstand Voltage test portion

Test Voltage

Voltage	0 - 2.5 kVAC / 0 - 5.0 kVAC, dual-range configuration
Voltage testing method	Zero-toggle switch
Transformer capacity	500 VA (maximum 30 min)*
Voltage adjustment method	Manually adjusted
Voltage measurement	Average value rectified effective value display • Digital: 0.00 - 5.00 kVAC (full-scale) Accuracy: $\pm 1.5\%$ f.s. • Analog: 0 - 5 kVAC (full scale) Accuracy: $\pm 5\%$ f.s.
Waveform	Mains waveform
Frequency	Mains synchronous

* Rated time for output voltages (at an ambient temperature of 40°C) The transformer capacity of the unit is approximately half the rated output. Use the unit within the rated time. If the rated time is exceeded, the unit may overheat and thereby cause the thermal fuse for the internal circuit to blow out.

Current measurement range	Maximum test time	Pause
$I \leq 60 \text{ mA}$	Continuous	None
$60 \text{ mA} < I \leq 100 \text{ mA}$	30 minutes	30 minutes
$100 \text{ mA} < I \leq 120 \text{ mA}$	10 minutes	30 minutes

Current Detection Section

Current measurement range	0.01 to 120 mA
Designated value	Average value rectified effective value display (digital)
Resolution	0.01 mA (2 mA / 8 mA ranges) 0.1 mA (32 mA range) 1 mA (120 mA range)
Accuracy	$\pm 3\%f.s. \pm 20 \mu A$... for all ranges (power waveform distortion is less than 5%)

Decision Function

Decision method	Window comparator method (digital setting)
Decision contents	UPPER-FAIL : when measured current exceeds the upper limit setting PASS : when measured current remains between the upper / lower limit settings for set time LOWER-FAIL : when the measured current is below the lower limit setting
Decision process	Output to the display, beeper sound, signals to EXT I/O for each decision result
Setting range	0.1 to 120 mA (Upper limit value) 0.1 to 119 mA (Lower limit value)
Setting resolution	0.1 mA (0.1 - 9.9 mA)/ 1 mA (10 - 120 mA)

10.1.2 Insulation resistance test portion

Test Voltage

Rated voltage	500 VDC/1000 VDC
No-load voltage	1 to 1.2 times the rated voltage.
Rated measured current	1 to 1.2 mA
Short circuit current	4 to 5 mA (500 V), 2 to 3 mA (1000 V)
Measured area and accuracy	0.5 to 999 M Ω (500 V), 1 to 999 M Ω (1000 V)/ $\pm 4\%$ rdg., 1000 to 2000 M Ω / $\pm 8\%$ rdg.
Measurement resolution	0.01 M Ω (0.50 M Ω - 19.99 M Ω), 0.1 M Ω (20.0 M Ω - 199.9 M Ω), 1 M Ω (200 M Ω - 2000 M Ω)
Measured resistance range	2 M Ω , 20 M Ω , 200 M Ω , 2000 M Ω (500 V) 4 M Ω , 40 M Ω , 400 M Ω , 2000 M Ω (1000 V)

Decision Function

Decision method	Window comparator method (digital setting)
Decision contents	UPPER-FAIL : when measured current exceeds the upper limit setting PASS : when measured current remains between the upper / lower limit settings for set time LOWER-FAIL : when the measured current is below the lower limit setting
Decision process	Output to the display, beeper sound, signals to EXT I/O for each decision result
Setting range	0.2 to 2000 M Ω (both upper / lower limit value)
Setting resolution	0.01 M Ω (0.20 - 2.00 M Ω), 0.1 M Ω (2.10 - 20.0 M Ω), 1 M Ω (21.0 - 200 M Ω), 10 M Ω (210 - 2000 M Ω)

10.1.3 Timer Section

Setting ON	Counts down time from start to preset time
Setting OFF	Shows elapsed time from start
Setting range	0.5 s to 999 s
Setting resolution and accuracy	0.1 s (0.5 s - 99.9 s) ± 50 ms / 1 s (100 s - 999 s) ± 0.5 s
Undetermined period	0.5 s (Mask time until determination for insulation resistance test time starts.)

10.1.4 Interface

EXT I/O (Rear panel)

Output signals	Open collector output
Max. load	30 VDC
Max. output current	100 mADC per signal
Output saturation voltage	1.5 VDC or less
Signal names	H.V.ON : Generating voltage for output TEST : Test in progress PASS : When measured current remains between the upper / lower limit settings for set time U-FAIL : When measured current exceeds the upper limit setting L-FAIL : When the measured current is below the lower limit setting READY : Standby W-MODE : Withstand voltage test display I-MODE : Insulation resistance test display W-FAIL : Withstand voltage test FAIL determination I-FAIL : Insulation resistance test failed ISO.DCV : Internal support resistance current (15 VDC, 0.1 A)
Input signals	Active low input
Max. testing withstand voltage	30 VDC
HIGH limit voltage	15 VDC or more, open
LOW limit voltage	5 VDC or less (-6 mA typ)
Signal names	START : Measurement start STOP : Measurement stop EXT-E : External I/O effective INTERLOCK: Interlock function effective

EXT SW

Input signal (contact input)	START/STOP/SW.EN (front socket SW enable)
Output signal	LED light signal (40 mA max. load current)
START key priority order	RS-232C interface>REMOTE CONTROL BOX>External I/O>START key on this units panel (However, this is when START is enabled using the RS-232C interface.)

RS-232C

Transmission mode	Start-stop synchronization, full duplex
Transfer rate	9600 bps
Data length	8 bit
Parity	None
Stop bit	1 bit
Hand shake	No X flow, hardware flow control
Delimiter	CR, CR + LF for reception, CR + LF for transmission

Other Functions

Memory function	This function allows test conditions to be saved. Withstand voltage mode: the standard test voltage, current determination for upper- and lower-limit values, timer, and voltage range can be set. Insulation resistance mode: the measured voltage, resistance determination for upper- and lower-limit values, and timer can be set. Up to 10 test conditions can be saved or loaded for both voltage and insulation resistance mode.
Voltage comparator (Withstand voltage mode)	Testing begins only when voltage is within $\pm 5\%$ of the preset value. (± 50 V when the output-voltage ≤ 1 kV) The voltage comparator prevents inadvertent testing with incorrect voltage settings. (Can be changed to check voltage immediately prior to the end of a test, depending on optional settings.)
Hold function	Retains the measured value when the test is forcibly terminated.
Pass hold function	Enable this function to hold the Pass state when detected, to facilitate confirmation.
Fail hold function	Enable this function to hold the Fail state when detected, to facilitate confirmation.
Buzzer settings	Buzzer volume settings for test screening and errors (buzzer volume settings are to be performed for PASS and FAIL separately)
Momentary output	This function allows current output only when the START key is pressed. The START key on the remote control or the START signal via external I/O has the same effect.
Double action	Enable this function to allow testing to start only when the START key is pressed within about 0.5 seconds after the STOP key.
Fail mode	Enable this function to restrict hold release to the STOP key on the main unit.
RS command "START"	This function validates or invalidates START from a PC interface.
Test end mode (for insulation resistance tests)	Enable this mode to terminate an insulation resistance test when the set time of the timer has elapsed (unrelated to screening), or to terminate the test at PASS or FAIL screening (only when the timer is set).
Insulation-resistance range	Fixed range/ auto range
Status out	Use this function to enable output conditions set using the background dip switch (when the OR condition is satisfied), or to enable output for the relay point. Maximum input voltage: 250 VAC, 30 VDC Maximum current point : 0.5 A Insulation method: Mechanical contact relay Output condition : 1. H.V. ON 2. TEST 3. PASS 4. FAIL 5. INT.LOCK 6. READY 7. EXT.CONT 8. POWER-ON

10.2 General Specifications

Display	Fluorescent tube display (digital display)
Monitor function	Output voltage / Current / Measurement resistance
Monitor cycle	2 Hz or faster
Ambient operating conditions	0 to 40°C (32 to 104°F), 80%RH or less (no condensation)
Ambient storage conditions	-10 to 50°C (14 to 122°F), 90%RH or less (no condensation)
Ambient conditions for assured accuracy Accuracy assurance period	23 ±5°C (73 ±9°F), 80%RH or less (no condensation) after 5 minutes minimum warm-up 1 year
Operating Environment	Indoors. <2000 mASL (6562 feet)
Power supply	100 VAC (3159) 120 VAC (3159-01) 220 VAC (3159-02) 230 VAC (3159-03) 240 VAC (3159-04) (Voltage fluctuations of 10% from the rated supply voltage are taken into account.)
Rated power frequency	50/60 Hz
Dielectric strength	1.35 kVAC, 10 mA, 1 minute between power supply and frame
Maximum rated power	800 VA
Dimensions	Approx. 320W x 155H x 330D mm (12.60"W x 6.10"H x 12.99"D) (excluding projections)
Mass	Approx. 18 kg (634.9 oz.) (3159) Approx. 20.5 kg (88.2 oz.) (3159-01) Approx. 21.5 kg (758.4 oz.) (3159-02/-03/-04)
Fuse	250VT8AL (3159, 3159-01), 250VT4AL (3158-02/03/-04)
Accessories	9615 H.V. TEST LEAD (high voltage side and return, 1 each) Power cord Instruction manual Spare fuse
Options	9613 REMOTE CONTROL BOX (SINGLE) 9614 REMOTE CONTROL BOX (DUAL) 9267 SAFETY TEST DATA MANAGEMENT SOFTWARE 9637 RS-232C CABLE (9pin-9pin/ 1.8 m)* 9638 RS-232C CABLE (9pin-25pin/ 1.8 m)* * Doesn't comply with CE mark requirements when used with the 3159.
Standard Applying	EMC EN61326-1:1997+A1:1998 CLASS A EN61000-3-2:1995+A1:1998+A2:1998 EN61000-3-3:1995 Safety EN61010-1:1993+A2:1995 Power supply: Pollution Degree 2, overvoltage category II (anticipated transient overvoltage 2500 V) EN61010-2-031:1994

Chapter 11

Maintenance and Inspection

11.1 Maintenance and Service

To ensure the safe operation of this unit, perform maintenance regularly.

- Be sure to read assiduously the various items highlighted in this manual for attention, in order to use the unit correctly.
- If the unit is not functioning properly, check the Section 11.3 "Troubleshooting" list. If a problem is found, contact your dealer or HIOKI representative. Pack the unit carefully so that it will not be damaged during transport, and write a detailed description of the problem. HIOKI cannot bear any responsibility for damage that occurs during shipment.
- If the unit has been subject to moisture, or if oil and dust have accumulated in the unit interior, the danger of electrical shock or fires resulting from the deterioration of insulation increases greatly. If the unit is ever subject to excessive moisture, oil, or dust, cease use immediately, and return the unit to us for maintenance.
- Periodic calibration is necessary to verify and maintain accuracy. If calibration becomes necessary, return the unit to us for maintenance.
- This product uses a lithium battery to back up it's memory. As the battery power is consumed, it's ability to store measurement conditions diminishes. In the event that measurement conditions can no longer be stored, please contact the manufacturer for repair service.
- Replaceable Parts
Main parts to be replaced periodically, and their life times:(Useful life depends on the operating environment and frequency of use. Operation cannot be guaranteed beyond the following periods)

Part	Life
Start Switch	Approx. 500000 cycles
Stop Switch	Approx. 500000 cycles
High voltage relay	Approx. 50000000 cycles

Part(9613/9614)	Life
Operate Switch	Approx. 25000 cycles
Start Switch	Approx. 1000000 cycles
Stop Switch	Approx. 1000000 cycles

- Spare and replacement parts for this product are guaranteed to be available only until 7 years after manufacture of this model is terminated.

Cleaning

To clean the product, wipe it gently with a soft cloth moistened with water or mild detergent. Never use solvents such as benzene, alcohol, acetone, ether, ketones, thinners or gasoline, as they can deform and discolor the case.

11.2 Fuse Replacement



- To avoid electric shock, turn off the power switch and disconnect the H.V. TEST LEAD before replacing the fuse.
- Replace the fuse only with one of the specified characteristics and voltage and current ratings. Using a non-specified fuse or shorting the fuse holder may cause a life-threatening hazard.
Fuse type: 250VT8AL (3159, 3159-01), 250VT4AL (3159-02 to 3159-04)

1. Turn the power OFF, and disconnect the power cord.
2. Unlock the fastener on the fuse holder on the rear panel using a slotted screwdriver, and remove the fuse holder.

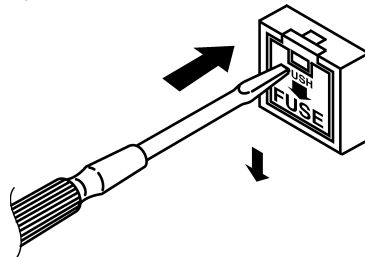

3. Replace the power fuse with a rated fuse.

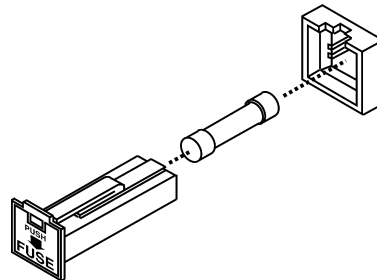

4. Reset the fuse holder.

Fuse holder

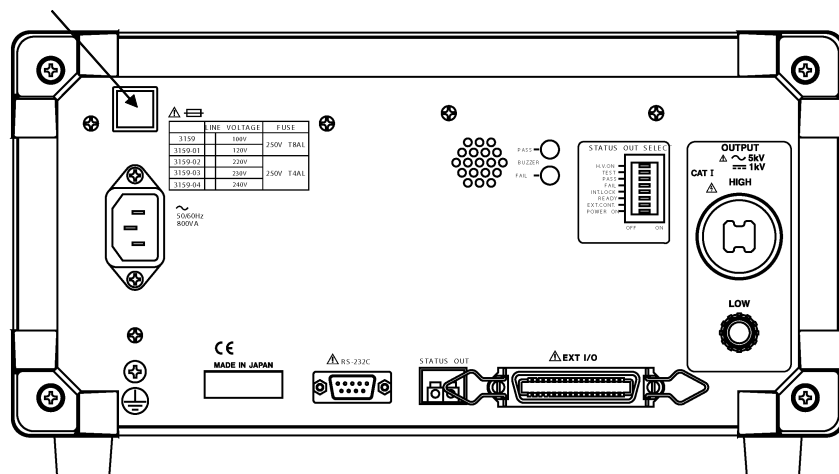

11.3 Troubleshooting

If damage is suspected, check the "Troubleshooting" section before contacting your dealer or Hioki representative.

Symptom	What to check and Solution
The screen does not illuminate when the power is turned on.	Is the power cord disconnected? →Connect the power cord.
	Has the fuse blown? →Replace the fuse.
The test will not begin even if the START key is pressed.	Is READY lit? Is EXT lit? →The external I/O and the REMOTE CONTROL BOX have priority over the unit's START key. Turn off the power to disable the external I/O and the REMOTE CONTROL BOX, then turn on the power.
	Is Double Action set in Optional Functions? →If Double Action is set, press the STOP key first and then press the START key.

If any of the following should occur, stop using the unit, disconnect the power cord and probe, and contact your dealer or HIOKI representative.

- If you are certain that the unit is damaged.
- If the measurement you wish to perform is inoperative.
- If the unit was stored for a long period of time in high temperatures and humidity, or other undesirable conditions.
- If the unit was damaged in transit.

11.4 Displaying Errors

If an error occurs, the 3159 displays the following on the screen.

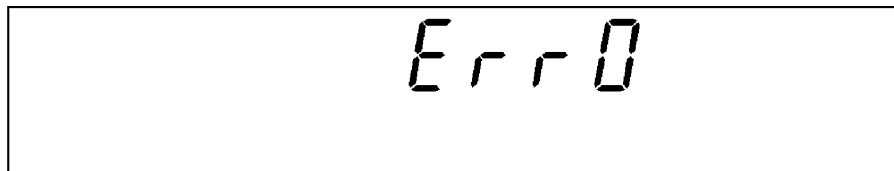

Err0	Interlock state. (See Section 8.1.4 "Inter-lock Function")
Err1	There is a problem with the external switch. A device other than a remote-control box (9613/9614) is connected. If this error appears when a proper remote-control box is connected, there may be a malfunction. Contact your sales agent or nearest sales office.
Err2	The EXT I/O may be malfunctioning. Contact your sales agent or nearest sales office.
Err3	The EEP-ROM may be malfunctioning. Contact your sales agent or nearest sales office.
Err4	The RAM or ROM may be malfunctioning. Contact your sales agent or nearest sales office.

11.5 Resetting the System

While pressing the SHIFT key, press the main power switch to turn on power.

Parameters after resetting the system

Once the system is reset, the following parameters are initialized together with the saved setting data. The optional settings are reset to default values (initial settings).

(1) Withstand-voltage mode

Comparative voltage value setting	OFF
Comparative voltage value	0.00 kV
Upper limit value	0.2 mA
Lower limit value setting	OFF
Lower limit value	0.1 mA
Test time setting	ON
Test time	0.5 s
Output voltage range	2.5 kV

(2) Insulation resistance mode

Test voltage value	500 V
Lower limit value	1000 M Ω
Upper limit value setting	OFF
Upper limit value	2000 M Ω
Test time setting	ON
Test time	0.5 s

Appendix

Appendix 1 9613 REMOTE CONTROL BOX (SINGLE)

The 9613 REMOTE CONTROL BOX (SINGLE) is equipped with a **START** key, a **STOP** key, and an OPERATE switch, which turns ON/OFF the REMOTE CONTROL BOX. The **STOP** key remains lit as long as a voltage is being output.

Ambient operating conditions	0 to 40°C (32 to 104°F), 80% RH or less (no condensation)
Ambient storage conditions	-10 to 50°C (14 to 122°F), 90% RH or less (no condensation)
Operating place	Indoors, max. 2000 m (6562 feet) height
Dimensions	Approx. 193W x 50H x 30D mm (7.60"W x 1.97"H x 1.18"D) (excluding projections)
Mass	Approx. 500 g (17.6 oz.)
Cord length	Approx. 1500 mm (59.06")

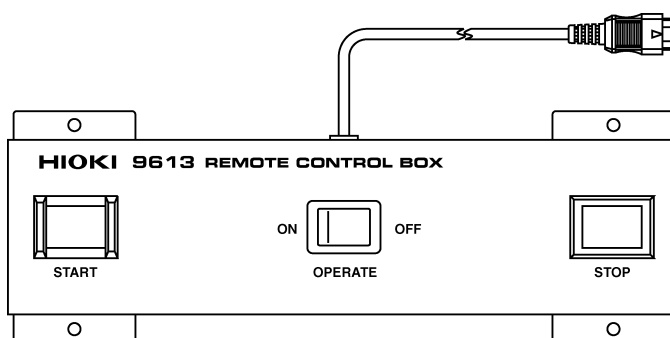

Appendix 2 9614 REMOTE CONTROL BOX (DUAL)

Unlike the 9613, the 9614 REMOTE CONTROL BOX (DUAL) has two **START** keys. Pressing both keys is equivalent to pressing the **START** key on the unit. By using the Momentary-OUT function in Optional Functions, the 9614 allows the REMOTE CONTROL BOX to be used with both hands, thus ensuring safer testing.

Ambient operating conditions	0 to 40°C (32 to 104°F), 80% RH or less (no condensation)
Ambient storage conditions	-10 to 50°C (14 to 122°F), 90% RH or less (no condensation)
Operating place	Indoors, max. 2000 m (6562 feet) height
Dimensions	Approx. 270W x 50H x 30D mm (10.63"W x 1.97"H x 1.18"D) (excluding projections)
Mass	Approx. 700 g (24.7 oz.)
Cord length	Approx. 1500 mm (59.06")

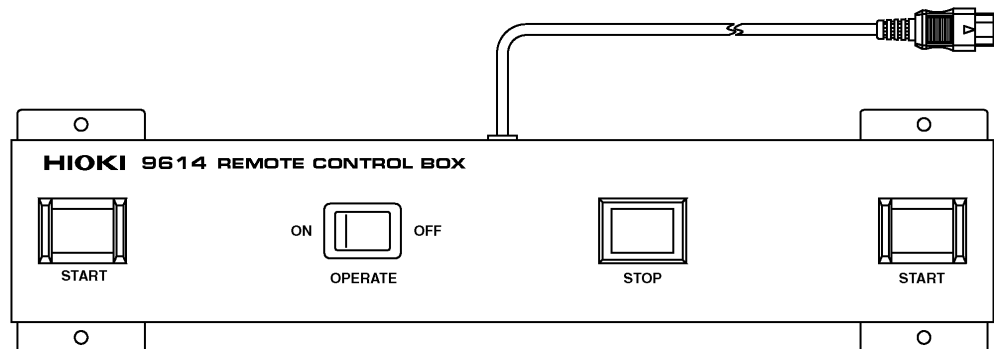

Appendix 3 9615 H.V. TEST LEAD (Standard Accessory)

Testing of the grounded lead should be avoided, unless absolutely necessary. If a part such as the lead must be tested, be sure to connect the low-side crocodile clip (black) to the grounded end of the lead. Connecting the highside crocodile clip (red) to the grounded end of the lead may result in electric shock or damage to the equipment.

Rated voltage	5 kVAC or 5 kVDC (High voltage side) 600 VAC or 600 VDC (Return side)
Rated current	150 mAAC or 150 mADC (High voltage side) 10 AAC or 10 ADC (Return side)
Dielectric strength	6.25 kVAC Sensitivity current 5 mA 1 minute (High voltage side) 1.35 kVAC Sensitivity current 5 mA 1 minute (Return side) Test point (between the core wire and the cable exterior)
Ambient operating conditions	0 to 40°C (32 to 104°F), 80% RH or less (no condensation)
Ambient storage conditions	-10 to 50°C (14 to 122°F), 90% RH or less (no condensation)
Operating place	Indoors, max. 2000 m (6562 feet) height
Dimensions	Approx. 1500 mm (59.06")
Mass	Approx. 100 g (3.5 oz.)
Standard Applying	EN 61010-2-031:1994 Pollution Degree 2, overvoltage category I

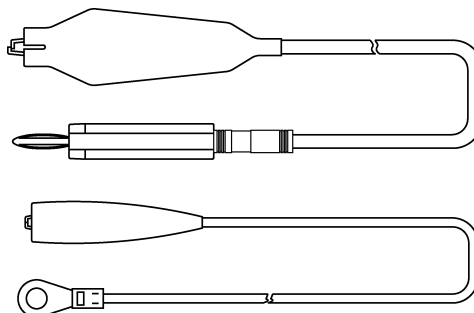

INDEX

- A -

Alligator clip	6
Analog voltmeter	3
Auto test mode	67

- B -

Buzzer	5,124,159
--------------	-----------

- C -

Command reference	129
Comparative voltage	25

- D -

DANGER lamp	3
Delimiter	125,158
Dimension	8
Displaying error	165
Double action	84,90

- E -

External I/O terminal	2,5,11,109
External interface	109
External switch	2,3,7,15

- F -

FAIL hold function	83,86
FAIL mode	84,91,159
File number	100
Flashing cursor	24,50
Forced ending	21,47,69
Fuse	v,160,163
Fuse holder	5,163

- H -

H.V. test lead	6,14,APPENDIX3
HIGH terminal	3,5
Hold function	83,87,159

- I -

Initial setting	83,130,166
Insulation resistance	45
Inter-lock function	84,93,115

- K -

Key-lock function	4,23,49,71
-------------------------	------------

- L -

LOW terminal	3,5
Load	23,49,104,146,148
Lower limit value	26,52

- M -

Measured current value 36,39,44
 Measured resistance 59,62,65
 Measured voltage value
 22,36,39,44,48,59,62,65,143,145
 Measurement range 53,95
 Memory function 2,159
 Momentary out 84,89,159

- O -

Operate switch 7,15
 Optional function 20,46,83

- P -

PASS HOLD function 83,85
 Parameter 127
 Power 5,12,160
 Power cord 12
 Priority for control 34,58,74,89
 Protective ground terminal v,10

- R -

RS command [START] 84,92
 RS-232C terminal 5
 Range selection swit 33
 Remote control box
 7,15,158,APPENDIX1,APPENDIX2

- S -

STATUS OUT dip switch 5,122
 STATUS OUT relay terminal 5,122
 Save 23,49,99,147,149
 Startup inspection 18
 Status out 2,5,122,159
 Switch signal line plug 15,34,58,74

- T -

Test time elapsed 36,59
 Timing chart 117

- U -

Upper limit value 26,52

- V -

Voltage comparator position 84,94

- W -

Withstand voltage mode 19

- Others -

"SETTING" state 20,24,46,50
 "PASS" state 21,37,47,60,69,76
 "FAIL" state 21,40,47,63,69,79

HIOKI

DECLARATION OF CONFORMITY

Manufacturer's Name: HIOKI E.E. CORPORATION
Manufacturer's Address: 81 Koizumi, Ueda, Nagano 386-1192, Japan
Product Name: INSULATION/WITHSTANDING HiTESTER
Model Number: 3159
Accessory: 9615 H.V.TEST LEAD
Options: 9613 REMOTE CONTROL BOX (SINGLE)
9614 REMOTE CONTROL BOX (DUAL)

The above mentioned products conform to the following product specifications:

Safety: EN61010-1:1993+A2:1995
EN61010-2-031:1994
EMC: EN61326-1:1997+A1:1998
Class A equipment
Minimum immunity test requirement
EN61000-3-2:1995+A1:1998+A2:1998
EN61000-3-3:1995

Supplementary Information:

The product herewith complies with the requirements of the Low Voltage Directive 73/23/EEC and the EMC Directive 89/336/EEC.

HIOKI E.E. CORPORATION

13 March 2001

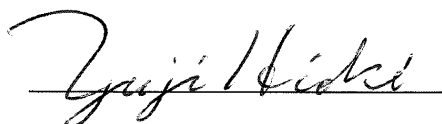

Yuji Hioki

President

3159A999-00

**HIOKI 3159 INSULATION/WITHSTANDING
HiTESTER**

Instruction Manual

Publication date: February 2006 Revised edition 5

Edited and published by HIOKI E.E. CORPORATION
Technical Support Section

All inquiries to International Sales and Marketing Department

81 Koizumi, Ueda, Nagano, 386-1192, Japan

TEL: +81-268-28-0562 / FAX: +81-268-28-0568

E-mail: os-com@hioki.co.jp

URL <http://www.hioki.co.jp/>

Printed in Japan 3159A981-05

-
-
- All reasonable care has been taken in the production of this manual, but if you find any points which are unclear or in error, please contact your supplier or the International Sales and Marketing Department at HIOKI headquarters.
 - In the interests of product development, the contents of this manual are subject to revision without prior notice.
 - Unauthorized reproduction or copying of this manual is prohibited.
-
-

HIOKI

HIOKI E. E. CORPORATION

HEAD OFFICE

81 Koizumi, Ueda, Nagano 386-1192, Japan
TEL +81-268-28-0562 / FAX +81-268-28-0568
E-mail: os-com@hioki.co.jp / URL <http://www.hioki.co.jp/>

HIOKI USA CORPORATION

6 Corporate Drive, Cranbury, NJ 08512, USA
TEL +1-609-409-9109 / FAX +1-609-409-9108

3159A981-05 06-02



Printed on recycled paper
