

HIOKI

QUICK START MANUAL

3196

POWER QUALITY ANALYZER



HIOKI E. E. CORPORATION

Contents

Introduction	1
Standard Accessories and Options	1
Safety Notes	4
Usage Notes	7
Reading the Operation Procedures	12
1 Overview	13
1.1 Product Overview	13
1.2 Features	14
2 Parts Names	19
2.1 Instrument Labels and Functions	20
2.2 Screen Names and Display Elements	24
2.2.1 Common Display Elements	25
3 Measurement Preparations	29
3.1 Connection Procedure	29
3.2 Attaching the Strap	30
3.3 Installing the Battery Pack	31
3.4 Connecting the AC Adapter	32
3.5 Connecting the Voltage Cords	33
3.6 Wiring Adapter Connection (Option)	35
3.7 Using a Clamp-On Sensor (Option)	37
3.7.1 Clamp-On Sensor Specifications	38
3.7.2 Connecting a Clamp-on Sensor	41
3.8 Turning the Power On/Off	42

1

2

3

4

5

6

7

8

9

APPX

IDX

Contents

4 Connecting to Lines to be Measured 45

4.1	Connection Procedure	45
4.2	Connection Methods	46
4.2.1	Single-Phase System Connections	47
4.2.2	Connecting to Multiple Systems	49

5 Quick Reference 51

5.1	Connection and System Settings	51
5.2	Data Display	52
5.3	Data Recording, Saving, Loading and Deleting	53
5.4	Event Analysis	54
5.5	Using Peripheral Devices	55

6 Measurement Method 57

6.1	Checking Three-phase Systems	57
6.2	Change in Power	64
6.3	Harmonic Fluctuation	70
6.4	Monitoring Interruptions	78
6.5	Detecting Transients and Waveform Distortion	88
6.6	ΔV_{10} Flicker	96
6.7	IEC Flicker	102

7 Peripheral Devices 109

7.1	Using a PC Card	109
7.2	Using a Printer (Option)	116
7.3	Using the Instrument with a Computer	121
7.3.1	RS-232C Connection	122
7.3.2	LAN Connection	123
7.4	Using the External Control Terminals	124

8 Specifications 125

9 Maintenance and Service 137

- 9.1 Cleaning and Storage 137
- 9.2 Repair and Servicing 138
- 9.3 Battery Pack Charging 139
- 9.4 Battery Pack Replacement and Disposal 140
- 9.5 Instrument Disposal 141

Appendix 143

- Troubleshooting 143
- FAQ 145
- Reference 146





Introduction

Thank you for purchasing the HIOKI "3196 POWER QUALITY ANALYZER". To obtain maximum performance from the product, please read this manual first, and keep it handy for future reference.

- Refer to the Instruction Manual (CD-R version) provided with this device.
- For current input with this device, a clamp-on sensor (optional) is required. For details, refer to the instruction manual for the clamp-on sensor you are using.
- For detailed information on the EN50160, see the Instruction Manual for EN50160.

Standard Accessories and Options

Checking the contents of the package

When you receive the product, inspect it carefully to ensure that no damage occurred during shipping. In particular, check the accessories, panel switches, and connectors. If damage is evident, or if it fails to operate according to the specifications, contact your dealer or Hioki representative.

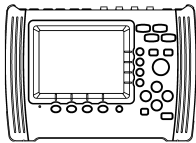

3196 POWER QUALITY ANALYZER

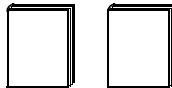

- Quick Start Manual
- Instruction Manual for EN50160



Software (CD-R)

- Instruction Manual
- Instruction Manual for EN50160
- "Down96" Data Download Application Software

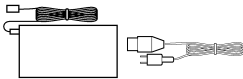

9458 AC ADAPTER
(power cord included)



9459 BATTERY PACK
(7.2 V, 2700 mAh)



9438-02 VOLTAGE CORD
1 set (8 cords)

(One each red, yellow, blue, and gray cord, and four black cords.)

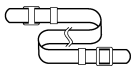

Strap



LAN Connector
Cover



Input Cord Label
(For distinguishing the voltage cord
and clamp-on sensor channels.)

Before using the 3196

- Before using the product the first time, verify that it operates normally to ensure that no damage occurred during storage or shipping. If you find any damage, contact your dealer or Hioki representative.
- Before using the product, make sure that the insulation on the 9438-02 VOLTAGE CORD is undamaged and that no bare conductors are improperly exposed. Using the product in such conditions could cause an electric shock, so contact your dealer or Hioki representative for repair.

Shipping precautions

Use the original packing materials when reshipping the product, if possible.

Options

- Clamps**
- 9660 CLAMP ON SENSOR (100 A rms rating)
 - 9661 CLAMP ON SENSOR (500 A rms rating)
 - 9667 FLEXIBLE CLAMP ON SENSOR (500 A rms, 5000 A rms rating)
 - 9669 CLAMP ON SENSOR (1000 A rms rating)
 - 9694 CLAMP ON SENSOR (5 A rms rating)
 - 9695-02 CLAMP ON SENSOR (50 A rms rating)
 - 9695-03 CLAMP ON SENSOR (100 A rms rating)
 - 9657-10 CLAMP ON LEAK SENSOR
 - 9675 CLAMP ON LEAK SENSOR
 - 9290 CLAMP ON ADAPTER
(continuous 1000 A, up to 1500 A, CT ratio 10:1)
 - 9219 CONNECTION CABLE (for Model 9695-02 and Model 9695-03)

- Power supply**
- 9459 BATTERY PACK (7.2 V, 2700 mAh)
 - 9458 AC ADAPTERx 1 (power cord included)

- Printers**
- 9670 PRINTER
(with 1 roll of thermally sensitized paper supplied)
 - 9671 AC ADAPTER (For the 9670 PRINTER)
 - 9237 RECORDING PAPER (for printers, thermally sensitized paper 80 mm x 25 m, 4 rolls)
 - 9638 RS-232C CABLE
(for printers, cross cable, 9-pin to 25-pin/1.5 m)

- Transport case**
- 9339 CARRYING CASE (soft type)
 - 9340 CARRYING CASE (hard type)

- Adapters**
- 9264-01 WIRING ADAPTER
(For three-phase 3-wire (3P3W3M) systems)
 - 9264-02 WIRING ADAPTER
(For three-phase 4-wire systems)

- Other peripherals**
- 9726 PC CARD 128M (128MB compact flash card + adapter)
 - 9727 PC CARD 256M (256MB compact flash card + adapter)
 - 9728 PC CARD 512M (512MB compact flash card + adapter)
 - 9642 LAN CABLE (5 m, straight-through cable, crossover adapter included)
 - 9444 CONNECTION CABLE (for RS-232C, Straight-through cable)
 - XD112 GPS BOX
- Software**
- 9624 PQA-HiVIEW (PC application software)
 - 9624-10 PQA-HiVIEW PRO (PC application software)











Safety Notes







This product is designed to conform to IEC 61010 Safety Standards, and has been thoroughly tested for safety prior to shipment. However, mishandling during use could result in injury or death, as well as damage to the product. Be certain that you understand the instructions and precautions in the manual before use. We disclaim any responsibility for accidents or injuries not resulting directly from product defects.

Safety Symbols



This manual contains information and warnings essential for safe operation of the product and for maintaining it in safe operating condition. Before using the product, be sure to carefully read the following safety notes.

	In the manual, the  symbol indicates particularly important information that the user should read before using the product.
	The  symbol printed on the product indicates that the user should refer to a corresponding topic in the manual (marked with the  symbol) before using the relevant function.
	Indicates a double-insulated device.
	Indicates AC (Alternating Current).
	Indicates DC (Direct Current).
	Indicates both DC (Direct Current) and AC (Alternating Current).
	Indicates a grounding terminal.
	Indicates the ON side of the power switch.
	Indicates the OFF side of the power switch.

The following symbols in this manual indicate the relative importance of cautions and warnings.

	Indicates that incorrect operation presents an extreme hazard that could result in serious injury or death to the user.
	Indicates that incorrect operation presents a significant hazard that could result in serious injury or death to the user.
	Indicates that incorrect operation presents a possibility of injury to the user or damage to the product.
	Advisory items related to performance or correct operation of the product.

Other Symbols

	Indicates the prohibited action.
	Indicates the reference.
	Indicates quick references for operation and remedies for troubleshooting.
*	Indicates terminology explained at the bottom of the page.

Accuracy

We define measurement tolerances in terms of f.s. (full scale) and rdg. (reading) with the following meanings:

f.s. (maximum display value or scale length)

The maximum displayable value or the full length of the scale.

This is usually the maximum value of the currently selected range.

rdg. (reading or displayed value)

The value currently being measured and indicated on the measuring product.

Measurement categories (Overvoltage categories)

This instrument complies with CAT III safety requirements. To ensure safe operation of measurement instruments, IEC 61010 establishes safety standards for various electrical environments, categorized as CAT I to CAT IV, and called measurement categories. These are defined as follows.

CAT I	Secondary electrical circuits connected to an AC electrical outlet through a transformer or similar device.
CAT II	Primary electrical circuits in equipment connected to an AC electrical outlet by a power cord (portable tools, household appliances, etc.)
CAT III	Primary electrical circuits of heavy equipment (fixed installations) connected directly to the distribution panel, and feeders from the distribution panel to outlets.
CAT IV	The circuit from the service drop to the service entrance, and to the power meter and primary over-current protection device (distribution panel).

Higher-numbered categories correspond to electrical environments with greater momentary energy. So a measurement device designed for CAT III environments can endure greater momentary energy than a device designed for CAT II.

Using a measurement instrument in an environment designated with a higher-numbered category than that for which the instrument is rated could result in a severe accident, and must be carefully avoided.

Never use a CAT I measuring instrument in CAT II, III, or IV environments.

The measurement categories comply with the Overvoltage Categories of the IEC60664 Standards.

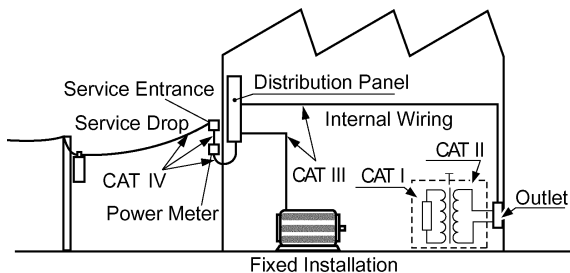

Usage Notes

Follow these precautions to ensure safe operation and to obtain the full benefits of the various functions.

WARNING

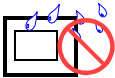

Do not get wet.



Do not touch with bare hands.



Check the voltage.

-  AC 100 V
-  to 240 V

Use the 9458 AC ADAPTER or 9459 BATTERY PACK.

To avoid electric shock

- To avoid electric shock, do not allow the product to get wet, and do not use it when your hands are wet.
- To avoid electric shock when measuring live lines, wear appropriate protective gear, such as insulated rubber gloves, boots and a safety helmet.
- Before turning the product on, make sure the source voltage matches that indicated on the product's power connector. Connection to an improper supply voltage may damage the product and present an electrical hazard.
- Use only the supplied Model 9458 AC ADAPTER. AC adapter input voltage range is 100 to 240 VAC (with $\pm 10\%$ stability) at 50/60 Hz. To avoid electrical hazards and damage to the product, do not apply voltage outside of this range.
- Turn the product off before connecting the AC adapter to the product and to AC power.
- For battery operation, use only the HIOKI Model 9459 BATTERY PACK. We cannot accept responsibility for accidents or damage related to the use of any other batteries.
- Do not use the product where it may be exposed to corrosive or combustible gases. The product may be damaged or cause an explosion.

Setting up the 3196

CAUTION

Avoid the following:

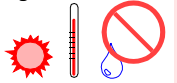

Direct sunlight
High temperature
High humidity

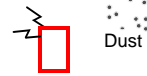

Electromagnetic radiation
Corrosive or explosive gases

- This product is designed for indoor use, and operates reliably from 0°C to 40°C. It can be used in the temperature range -10°C to 0°C, but LCD operation and accuracy are not assured. Further, 9459 BATTERY PACK and PC Card operation are not guaranteed.
- Do not store or use the product where it could be exposed to direct sunlight, high temperature or humidity, or condensation. Under such conditions, the product may be damaged and insulation may deteriorate so that it no longer meets specifications.
- The protection rating for the enclosure of this device (based on EN60529) is *IP30. This product is not designed to be entirely water- or dust-proof. To avoid damage, do not use it in a wet or dusty environment.
- Do not use the product near a device that generates a strong electromagnetic field or electrostatic charge, as these may cause erroneous measurements.

***IP30:**

This indicates the degree of protection provided by the enclosure of the device against use in hazardous locations, entry of solid foreign objects, and the ingress of water.

"3": Protected against access to hazardous parts with tools more than 2.5 mm in diameter. The equipment inside the enclosure is protected against entry by solid foreign objects larger than 2.5 mm in diameter.

"0": The equipment inside the enclosure is not protected against the harmful effects of water.

Handling this device

CAUTION

- To avoid damage to the product, protect it from vibration or shock during transport and handling, and be especially careful to avoid dropping.
- Be careful to avoid dropping the clamps or otherwise subjecting them to mechanical shock, which could damage the mating surfaces of the core and adversely affect measurement.

Using the clamp-on sensors and voltage



Connect the clamp-on sensors or voltage cords to the instrument first, and then to the active lines to be measured. Observe the following to avoid electric shock and short circuits.

- To avoid short circuits and potentially life-threatening hazards, never attach the clamp to a circuit that operates at more than the maximum rated voltage to earth (1000 VAC: 9667, 600 VAC: 9661, 9669, 300 VAC: 9660, 9694, 9695-02, 9695-03, 9657-10, 9675), or over bare conductors.
- Clamp sensor and voltage cable should only be connected to the secondary side of a breaker, so the breaker can prevent an accident if a short circuit occurs. Connections should never be made to the primary side of a breaker, because unrestricted current flow could cause a serious accident if a short circuit occurs.
- Do not allow the voltage cable clips to touch two wires at the same time. Never touch the edge of the metal clips.
- Use only the supplied 9438-02 VOLTAGE CORD to connect the product input terminals to the circuit to be tested.
- When the clamp sensor is opened, do not allow the metal part of the clamp to touch any exposed metal, or to short between two lines, and do not use over bare conductors.

Handling the cords



- Be careful when handling the cords, since the conductor being measured may become very hot.
- To avoid electrocution, turn off the power to all devices before plugging or unplugging any of the interface connectors.

 CAUTION

- To avoid damaging the power cord, grasp the plug, not the cord, when unplugging the cord or AC adapter from the power outlet.
- To avoid damaging the voltage cords or clamp sensor cables, do not bend or pull near their ends.
- Avoid stepping on or pinching the cable, which could damage the cable insulation.
- Keep the cables well away from heat sources, as bare conductors could be exposed if the insulation melts.
- When disconnecting the BNC connector, be sure to release the lock before pulling off the connector. Forcibly pulling the connector without releasing the lock, or pulling on the cable, can damage the connector.
- Failure to fasten the connectors properly may result in sub-specification performance or damage to the equipment.

Input** DANGER****Maximum input voltage and maximum rated voltage to earth.**

- The maximum input voltage of the product is 780 Vrms, 1103 V peak. Do not measure the voltage exceeding that. It causes the personal injury as well as damages the product.
- The maximum rated voltage to earth of the product is 600 Vrms. Do not measure the voltage to earth exceeding that. It causes the personal injury as well as damages the product.
- The maximum rated voltage to earth of clamp sensor depends on the type of clamp sensor used. To avoid electric shock, refer to the instruction manual of a clamp sensor used.

CAUTION

- To avoid damage to the product, do not short-circuit the output terminal and do not input voltage to the output terminal.
- The channels of voltage input terminals CH1, CH2, and CH3 are not isolated from one another. To avoid electric shock, do not touch the terminals. CH4 is isolated from the other channels.
- Note that the product may be damaged if current or voltage exceeding the selected measurement range is applied for a long time
- When the power is turned off, do not apply voltage or current to the voltage input terminals or clamp sensor. Doing so may damage the product.
- To prevent damage to the instrument and sensor, never connect or disconnect a sensor while the power is on, or while the sensor is clamped around a conductor.

Using Potential Transformer (PT or VT) and Current Transformer (CT)**NOTE**

- When the voltage or current for the power line being measured exceeds the maximum rated input for this device, use an external PT or CT.
- When using an external PT or CT, make sure you use a device with a minimal phase difference. By setting the PT or CT ratio, you can read measurement values directly.

Measurement values**NOTE**

- To ensure measurements are precise, warm up the device for at least 30 minutes after plugging it in.
- This device is designed to measure commercial power lines with a frequency of 50 or 60 Hz. It cannot measure power lines of other frequencies or power lines where the waveforms are controlled using an inverter.
- This device cannot measure power lines with superposed direct current.
- This device uses algorithms to measure values for input voltage and current waveforms using (see the specifications). On devices using different operation principles or algorithms differ, differences in measurement values may result.
- When the display value for voltage, current, active power, reactive power, apparent power, or the power factor is less than 0.1%, zero is displayed.

Reading the Operation Procedures

Indicates the operation keys.

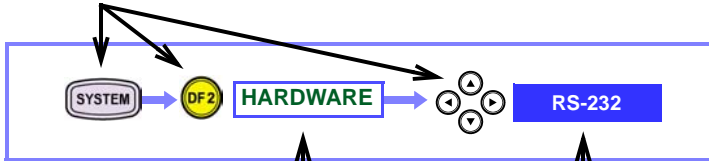

Indicates the screen name selected using the DF key.

Indicates a display item that can be moved using the cursor key or an item selection.

Overview

1

1

Overview

1.1 Product Overview

The 3196 POWER QUALITY ANALYZER detects power line anomalies and analyzes power line quality.

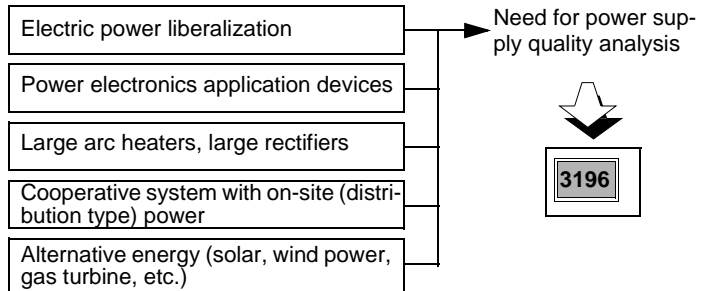

◆ Correctly analyze abnormal phenomena

Analysis can be performed by correlating measurement items with particular standard characteristics to ascertain the causes of power line anomalies.

◆ Continuous long-term monitoring and recording

Power line anomalies often occur intermittently, so they must be captured when an anomaly occurs, along with its type and intensity.

◆ Remote control

The type and time of occurrence of anomalies can be instantly determined through a variety of interfaces (RS-232C, LAN, printer and modem).

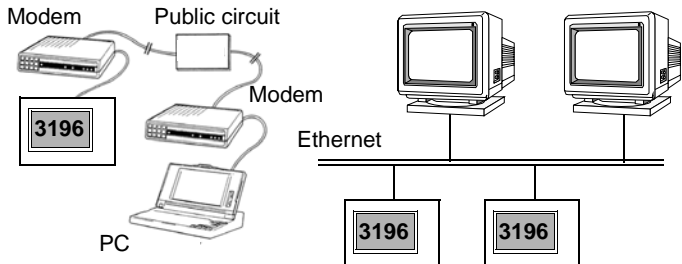

1.2 Features

- ◆ **Safe design**
Designed to comply with safety standard EN61010-1:2001.
- ◆ **Supports a variety of power lines**
Measures single-phase 2-wire, single-phase 3-wire, three-phase 3-wire and three-phase 4-wire systems.
An extra input channel is provided for uses such as measuring power lines of a second system, for DC voltage measurement or for measuring a neutral line.
- ◆ **Simultaneous measurement of multiple elements of power supply quality**
Multiple power supply quality parameters can be selected as desired for simultaneous measurement.
 1. High speed voltage quality parameter
Transient overvoltage (impulse)
 2. RMS voltage quality parameters
Voltage swell (surge), voltage dip (sag), voltage interruption
 3. Power quality parameters
Frequency, voltage, current, active power, apparent power, reactive power, power factor (displacement power factor)
 4. 3-Phase quality parameters
Voltage unbalance factor, current unbalance factor
 5. Harmonic quality parameters
Harmonic voltage, current and power; inter-harmonic voltage and current; harmonic voltage and current phase angle; total harmonic voltage and current distortion factors (THD-F, THD-R); total inter-harmonic voltage and current distortion factors (THD-F, THD-R)
 6. Other parameters
K factor, flicker
- ◆ **High-speed impulse detection and waveform display function**
Four voltage channels are sampled at 2 MS/s, so high-speed detection and waveform display can be performed at up to 0.5 μ s and high voltage (2000 Vpk transient overvoltage (impulse)).
- ◆ **Δ V10 Flicker, IEC flicker measurement**
Select either IEC flicker (Pst,Plt) regulated by international standards, or Δ V10 Flicker commonly used in Japan, and measure with power quality parameters.

- ◆ **Δ -Y and Y- Δ conversion functions provided**

Δ -Y conversion can be performed on three-phase 3-wire systems, and Y- Δ conversion can be performed on three-phase 4-wire systems. In either case, line-to-line voltage or phase-to-neutral voltage display is available.
- ◆ **Up to one month continuous measurement**

Data is saved to internal memory during the measurement period. Use of a PC card enables continuous measurement for one month at maximum.
- ◆ **Time plot graph display**

Fluctuations in various power quality parameters are displayed in time plot graphs. Calculated maximum, average and minimum values for each interval are displayed.
- ◆ **Event detection function**
 1. Event detection using preset threshold settings

Events exceeding thresholds are detected by setting thresholds for various power quality parameters.
Up to 100 events can be saved to internal memory.
Up to 1000 events can be saved on PC card.
Events that occur simultaneously are correlated and treated as a single event.
 2. Event Analysis

Confirm when and what kind of events have occurred from the Event List.
Each event can be analyzed using waveforms, vectors, harmonic bargraph and related parameter values.
 3. External input and output of events

A signal can be output when an event occurs. Also, an externally applied signal can be set to be recognized as an event.
- ◆ **Easy-to-see TFT color LCD**

The display is a 6.4-inch (640 x 480 dot) high-contrast, wide-viewing-angle TFT color liquid crystal display. The screen is easy to see in both bright and dark environments, and is capable of showing many power quality parameters at the same time.
- ◆ **RS-232C and LAN interfaces provided**

Connect a PC, printer or modem for remote control and data output.
- ◆ **PC Card interface provided**

Measurement and event data can be preserved by saving to a PC Card.
Setting conditions and measurement data can be stored and read back using a PC Card.
- ◆ **Seven selectable display languages**

Select the display language from English, German, French, Spanish, Italian, Chinese (Simplified) or Japanese.

1.2 Features

- ◆ **Nickel-Metal-Hydride battery pack supplied**
The Ni-MH battery backs up internal data when power is off. When fully charged, data is backed up for 30 minutes when power is turned off.
- ◆ **Compact and light weight**
The compact size and light weight allows installation even in limited space, such as in a cubicle.
- ◆ **Carrying case options for portability**
The optional cases allow measurements to be taken without removing the instrument. Choose from a light-weight soft case or water-resistant hard case.
- ◆ **A choice of optional clamp-on sensors**
Select either the 9660 CLAMP ON SENSOR (100 A rms rating), the 9661 CLAMP ON SENSOR (500 A rms rating), the 9667 FLEXIBLE CLAMP ON SENSOR (500/ 5000 A rms rating), 9669 CLAMP ON SENSOR (1000 A rms rating), or 9694 CLAMP ON SENSOR (5 A rms rating).
The 9657-10 CLAMP ON LEAK SENSOR and the 9675 CLAMP ON LEAK SENSOR also can be used.
- ◆ **Control instrument settings and data acquisition by Web browser**
HTTP server functions are built in.
Instrument settings and data acquisition can be controlled by common Internet Web browsers like Internet Explorer or Netscape Navigator.
- ◆ **PC application software (option) for analyzing a large volume of data**
By using the optional 9624 PQA-HiVIEW or 9624-10 PQA-HiVIEW PRO, a large volume of long-term measurement data recorded on a PC card can be analyzed.
- ◆ **Remotely downloaded application software provided**
By using the Down96 download application supplied with the product, data in the main unit can be downloaded from a distant location via LAN or RS-232C (modem).
- ◆ **EN50160-compliant evaluations**
Conforms to the European standard EN50160 (Voltage characteristics of electricity supplied by public distribution systems) and suitable for evaluation of the voltage quality of a power system.
- ◆ **Optional GPS BOX available for precisely timed measurements**
Using the XD112 GPS BOX, measurements can be precisely timed using communications satellites.

- ◆ **Measurement is possible on 400 Hz power lines**
Measure 400 Hz power such as that used for aircraft equipment and shipping tests.
Because the usual shipping tests do not include 400 Hz measurements, please advise when ordering if your application requires guaranteed accuracy at 400 Hz.

- **For details about low power supply quality anomalies and capturing phenomena, See the Instruction Manual (CD-R version).**
- **For detailed information on the EN50160, see the Instruction Manual for EN50160.**



Parts Names

2

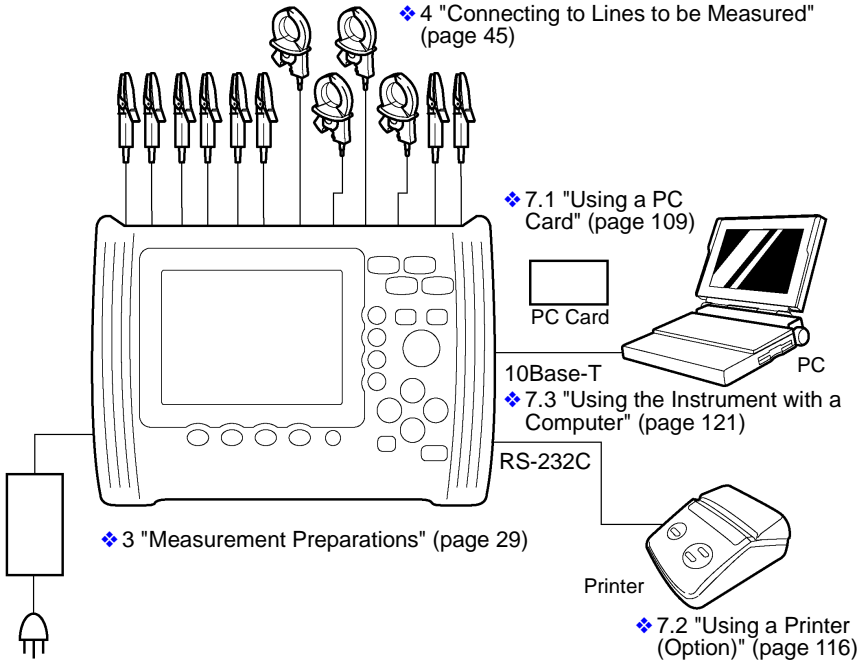

2.1 Instrument Labels and Functions

Front Panel

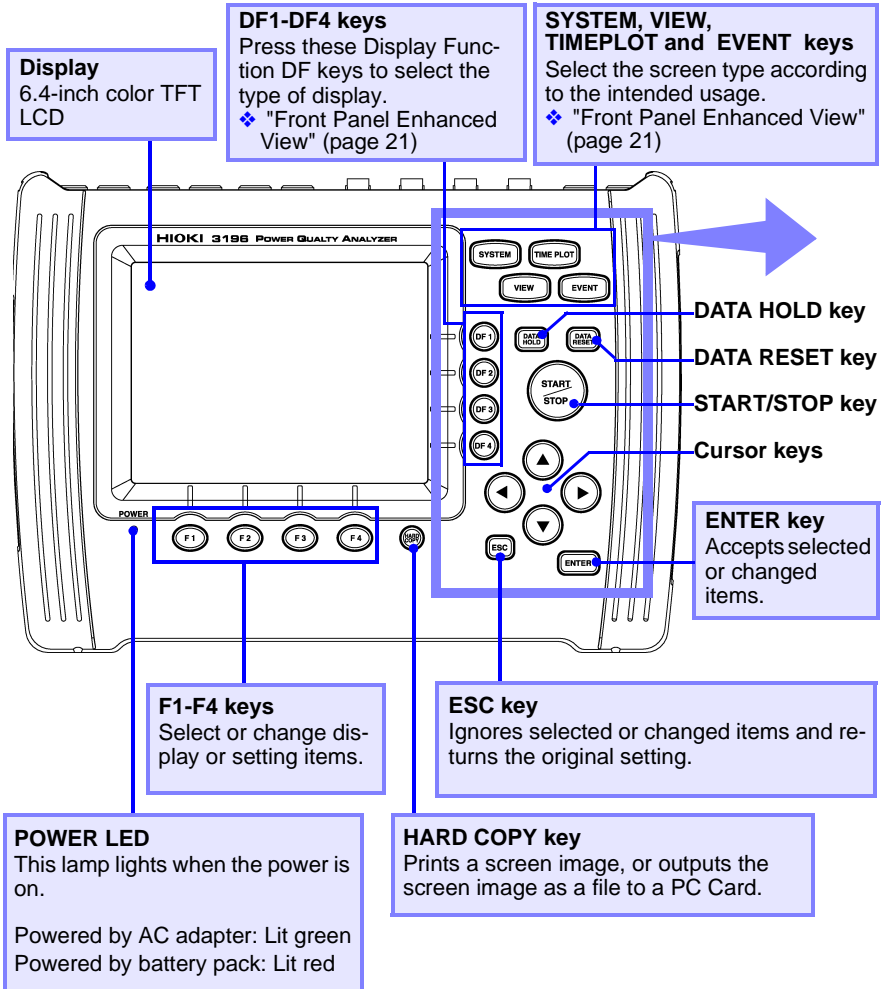

Front Panel Enhanced View

SYSTEM key

Displays the [SYSTEM] screen (for selecting display of system settings).

VIEW key

Displays the [VIEW] screen (for selecting an Analysis view).

TIME PLOT key

Displays the [TIME PLOT] screen (for selecting the time plot graph).

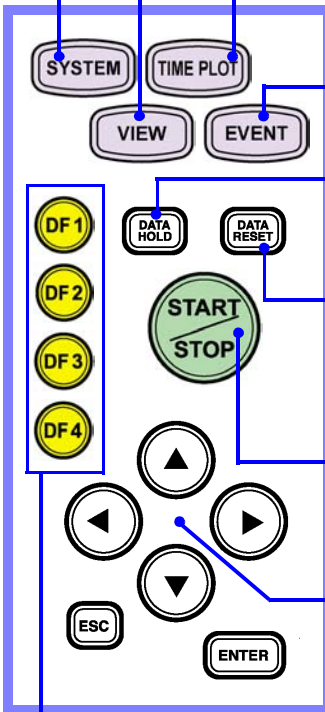

EVENT key

Displays the [EVENT] screen (for selecting events).

DATA HOLD key

Temporarily stops display of measured values. Press again to cancel. While recording, display of the measured value can be stopped for confirmation.

DATA RESET key

All measurement data is erased from internal memory. Press this key to reset before restarting recording.

START/STOP key

Starts and stops recording. To start recording, press the DATA RESET key to reset the data, then press this key.

Cursor keys

These keys move the cursor on the screen. Use to scroll the time series graph screen.

DF1-DF4 keys (Display Function)

Select a screen to display from the selected screen type: SYSTEM, VIEW, TIME PLOT or EVENT.

The screen selections are as follows:

[SYSTEM] Wiring diagram, Main settings, Event settings, Load/Save, etc.

[TIME PLOT] .. RMS fluctuations, Voltage fluctuations, Harmonic fluctuations, Flicker display, etc.

[VIEW] Waveforms, Vectors, DMM, Harmonic display, etc.

[EVENT] List, Monitor, etc.

2.1 Instrument Labels and Functions

Top Panel

Voltage Input terminals

Connect the supplied 9438-02 VOLTAGE CORD.

- ❖ 3.5 "Connecting the Voltage Cords" (page 33)

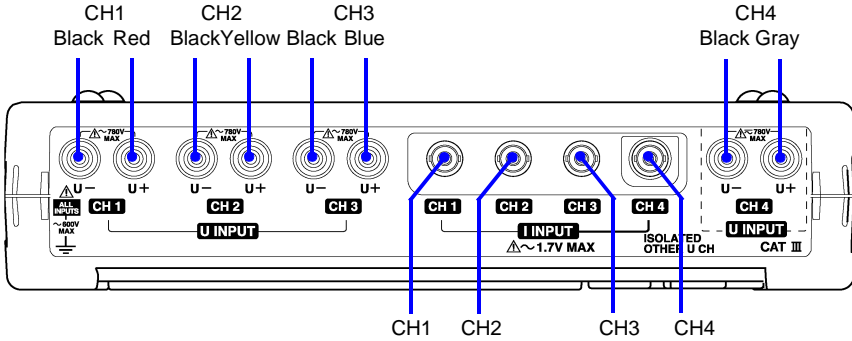

Current Input terminals

Connect an optional clamp-on sensor.

- ❖ 3.7 "Using a Clamp-On Sensor (Option)" (page 37)

Left Panel

External Event Input terminal (EVENT IN)

An external input signal can serve as an event trigger.

- ❖ 7.4 "Using the External Control Terminals" (page 124)

External Event Output terminal (EVENT OUT)

A signal is output each time the instrument detects an event.

GND terminal

This is the signal ground terminal for the Event Input/Output terminals.

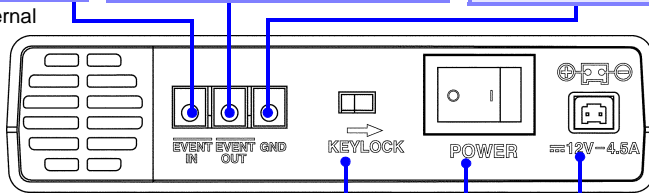

KEY LOCK switch

Sliding this switch in the direction of the arrow disables all key operation except the POWER switch.

POWER switch

Turns the instrument on and off.

- Power OFF
- | Power ON
- ❖ 3.8 "Turning the Power On/Off" (page 42)

AC Adapter socket

The supplied 9458 AC ADAPTER connects here.

- ❖ 3.4 "Connecting the AC Adapter" (page 32)

Right Panel

RS-232C Interface connector

Connects to a PC, modem or printer using an RS-232C cable.

- ❖ 7.2 "Using a Printer (Option)" (page 116)
- ❖ 7.3 "Using the Instrument with a Computer" (page 121)

PC Card slot

A PC Card can be inserted here.

- ❖ 7.1 "Using a PC Card" (page 109)

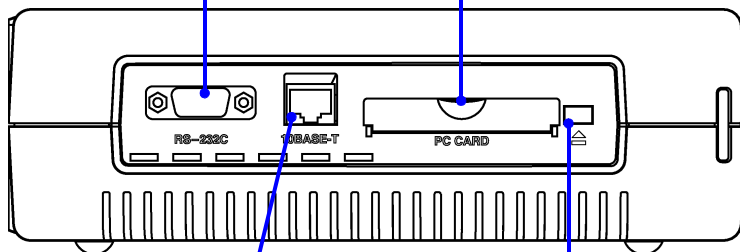

10Base-T Interface connector

Connects to a PC using a LAN cable.

- ❖ 7.3.2 "LAN Connection" (page 123)

Eject button

Press this button to eject a PC Card from the slot.

Rear Panel

Label

The label includes notices regarding Cautions, CE Mark, Double-Insulation, country of origin and manufacturer.

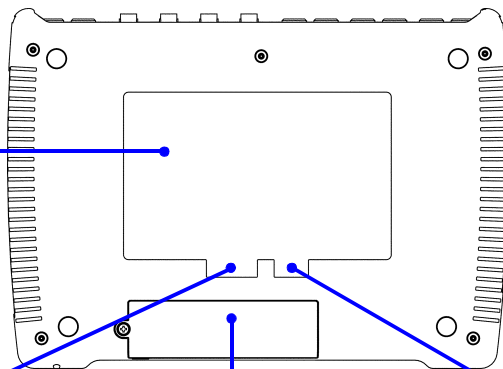

Number plate

Contains manufacturer's ID numbers. Please do not remove, as this information is required for product management.

Battery compartment

Install the supplied 9459 BATTERY PACK here.

- ❖ 3.3 "Installing the Battery Pack" (page 31)

MAC Address Label

This label indicates the unique MAC address assigned to each unit for LAN operation. Please do not remove, as this information is required for product management.

2.2 Screen Names and Display Elements

For details about each screen, refer to the See the Instruction Manual (CD-R version).

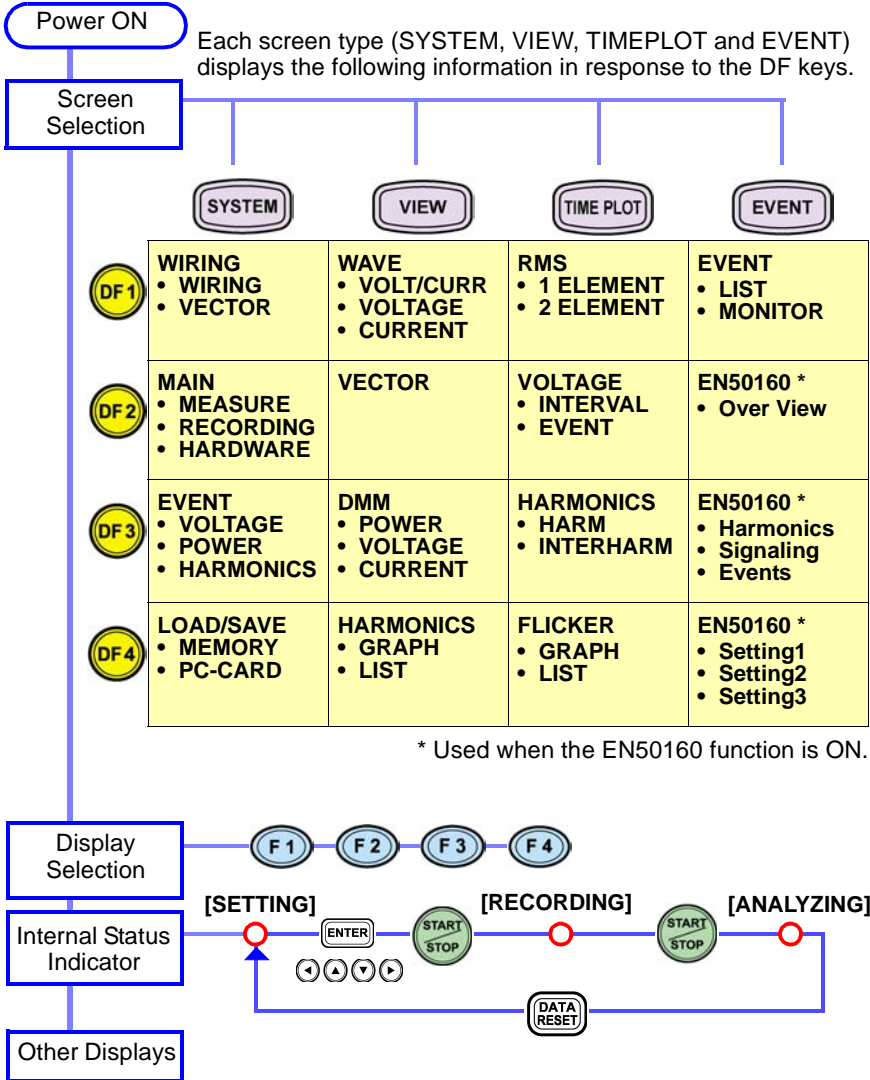

2.2.1 Common Display Elements

The display elements common to all screens on the 3196 are as follows.

Top of Screen

Interface & Hold/Lock Indicators^{*4}(page 27)
Indicates interface usage and HOLD/LOCK status.

Screen Selection^{*1}(page 26)
Indicates the screen type selected by the corresponding key.

Internal Status Indicator^{*2}(page 26)
Indicates the current internal operating status.

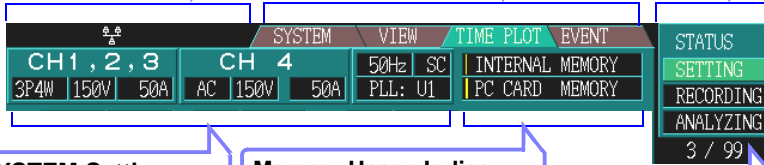

SYSTEM Settings Indicators^{*5}(page 28)
Displays the contents specified in **DF2 [MEASURE]**.

Memory Usage Indicators^{*3}(page 27)
Level meters indicate the usage status of internal memory and flash ATA card.

Number of repeated recording operations^{*6}(page 28)
The number of repeated recording operations currently set will be indicated.



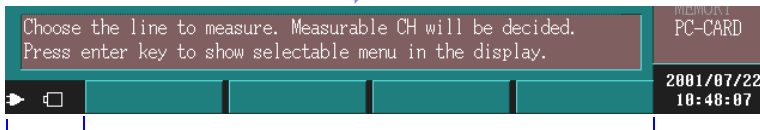

Bottom of Screen

Help Comment Display

Shows a brief description of the item at the cursor position on the SYSTEM screen.



Power Supply Indicator

Indication	Power supply status
 White/ Red	Powered by AC adapter Battery pack is charging
 White/ White	Powered by AC adapter Installed battery pack, charging completed
 White	Powered by battery pack
 White	Powered by battery pack, but charge is low.

Time Display

Shows the current time.

*1: Screen Selection Display



*2: Internal Operating Status Display

One of **[SETTING]**, **[RECORDING]**, **[WAITING]** (or **[WAITING]** until preset time to start measuring), or **[ANALYZING]** is displayed to indicate the internal status of the instrument.

The internal status is changed by pressing  to start/stop recording.

Indicator	Internal status description	Real-time measurement	Recording status
[SETTING]	When turned on, there is no recorded data in the instrument	Possible	Preparation for recording (not recording)
[WAITING]	Waiting until a preset start time to begin measuring	Possible	
[RECORDING]	Recording has started and measurement data is being saved to the instrument's internal memory (and perhaps to a PC Card)	Possible	Recording in progress
[ANALYZING]	Recording has finished and the instrument is ready for analysis of the measurement data in internal memory	Possible	Finished recording

Normal Measurement

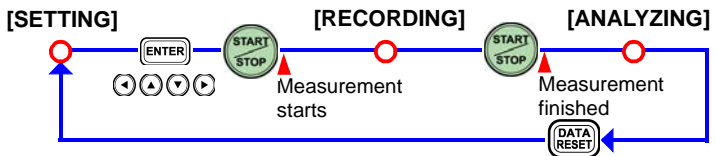

Measurement with Specified Time Settings

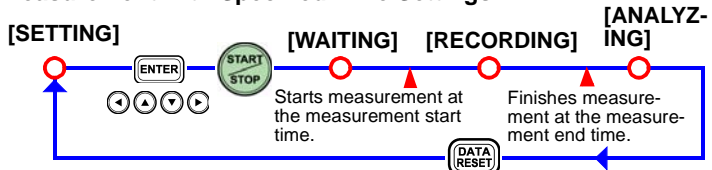

If the preset measurement start time has already passed, measurement starts immediately.

*3: Memory Usage Indicators

INTERNAL MEMORY PC CARD MEMORY

TIME PLOT related data capacity
Measurement stops when memory becomes full.
(Selectable Stop/Continuous)

INTERNAL MEMORY

Up to 100 EVENT data sets can be stored (when using internal memory)
After 100 events are stored, the earliest are overwritten.

*4: Status Icons

Interface usage status indicators



Indicates the printer is ready for use.



Indicates the modem is ready for use.



Indicates the LAN interface is ready for use.

HOLD/LOCK status indicators



Indicates the **DATA HOLD** key has been pressed to activate the Data Hold function.



Indicates the **KEY LOCK** switch has set to lock the keys.

PC Card Access status indicator



Indicates the PC Card is being accessed.

*5: SYSTEM Settings Indicators

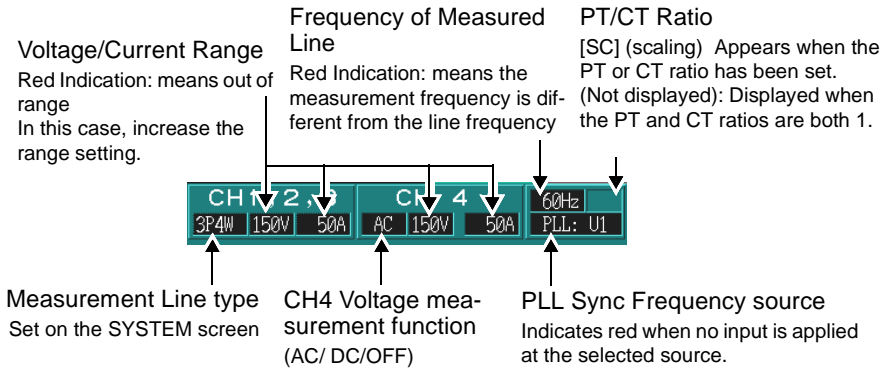

*6: Number of repeated recording operations



When the repeated recording function is set, the number of repeated recording operations currently set will be indicated. Repeated recording operations can be conducted up to 99 days at one-day measuring intervals, and up to 99 weeks at one-week measuring intervals.

The measured data file of repeated recording is saved as a separate binary file for each one-day or one-week period on the PC card.

Measurement Preparations

3

Please read the Usage Notes (page 7) before setting up this instrument.

3.1 Connection Procedure

Refer to the indicated reference items before installing and connecting.

1 Attach the Strap
Note: If not needed, proceed to step 2
❖(page 30)

2 Install the battery pack
❖(page 31)

3 Connect the AC Adapter and the power cord
❖(page 32)

4 Connect the Wiring Adapter (option)
Note: If no Wiring Adapter is used, proceed to step 5
❖(page 35)

5 Connecting the Voltage Cords
(Apply the input cord labels)
❖(page 33)

6 Connecting a Clamp-on Sensor
(Apply the input cord labels)
❖(page 37)

7 Turning the Instrument On
❖(page 42)

Connect to the lines to be measured
❖(page 45)

Before connecting to the lines to be measured, be sure steps 1 - 7 have been completed.

3

3.2 Attaching the Strap

Use the strap to carry the instrument, or to hang it up at the installation location.

CAUTION

Attach both ends of the Strap securely to the instrument. If insecurely attached, the instrument may fall and be damaged when carrying.

Attaching the strap to the instrument

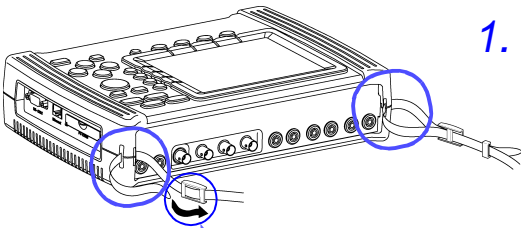

1. Insert each end of the Strap through an installation slot on the instrument.

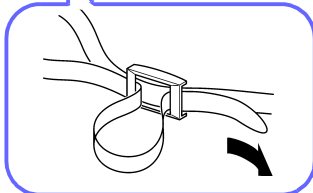

2. Feed each end of the Strap through its clasp.

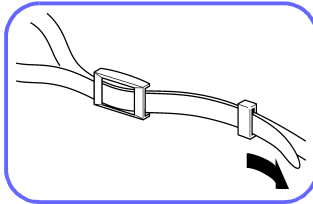

3. Feed each end through its stopper.

Tighten the Strap sufficiently to prevent loosening or twisting.

3.3 Installing the Battery Pack

The battery pack backs up instrument data when power is turned off. When completely charged, data recorded in the instrument is backed up for about 30 minutes. The battery charges during normal measurement operation, so it should be fully charged when power is turned off.

Be aware that if the battery pack is not installed, recorded data is erased when the instrument is turned off.



WARNING

Use only the HIOKI Model 9459 BATTERY PACK. We cannot accept responsibility for accidents or damage related to the use of any other batteries.

Before installing the Battery Pack, make sure the instrument is turned OFF.

NOTE

- The battery pack is subject to self-discharge. Be sure to charge the battery before initial use. If the battery capacity remains very low after correct recharging, the useful battery life is at an end.
 - ❖9.3 Battery Pack Charging (page 139)
- To avoid problems with battery operation, remove the battery pack from the instrument if it is to be stored for a long time.

Installing the Battery Pack

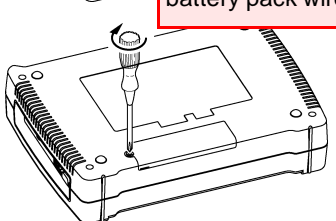
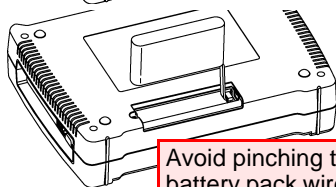
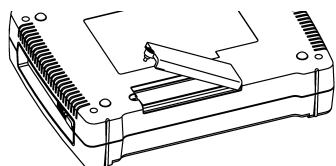

Tool required for installation:
One Phillips-head screwdriver

1. Turn the instrument off.
2. Turn the instrument over, remove the screw affixing the battery compartment cover, and remove the cover.
3. Connect the battery pack connector (the two projections on the sides should be face-up).
4. With the wired side of the battery pack facing downwards, insert the pack (fold the wires toward the right).
5. Replace the battery compartment cover, and its screw.

3.4 Connecting the AC Adapter



- Use only the supplied Model 9458 AC ADAPTER. AC adapter input voltage range is 100 to 240 VAC (with $\pm 10\%$ stability) at 50/60 Hz. To avoid electrical hazards and damage to the instrument, do not apply voltage outside of this range.
- Turn the instrument off before connecting the AC adapter to the instrument and to AC power.
- To avoid electric shock and ensure safe operation, connect the power cord to a grounded (3-contact) outlet.

NOTE

AC adapter operation with the 9459 BATTERY PACK installed protects against loss of data when power is turned off. Note that if the battery pack is not installed when operating with the 9458 AC ADAPTER, a power interruption longer than 0.5 cycle will abort measurement and cause the instrument to turn off. When the AC adapter and battery pack are used together, the AC adapter has priority.

Connecting the AC Adapter to the Instrument

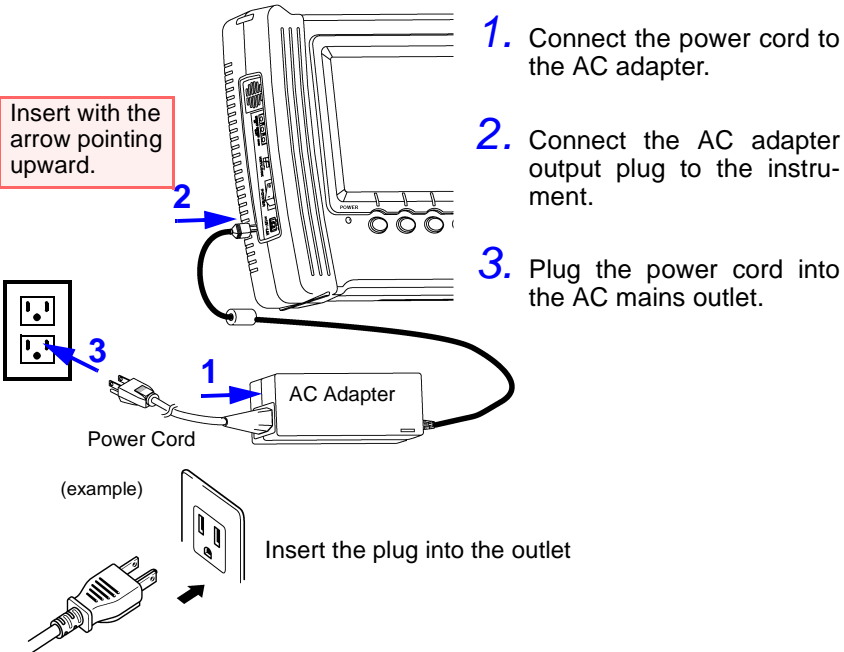

3.5 Connecting the Voltage Cords



! DANGER

Connect the voltage cords to the instrument first, and then to the active lines to be measured.

Observe the following to avoid electric shock and short circuits.

- Voltage cable should only be connected to the secondary side of a breaker, so the breaker can prevent an accident if a short circuit occurs. Connections should never be made to the primary side of a breaker, because unrestricted current flow could cause a serious accident if a short circuit occurs.
- Do not allow the voltage cable clips to touch two wires at the same time. Never touch the edge of the metal clips.

! CAUTION

- For safety reasons, when taking measurements, only use the 9438-02 VOLTAGE CORD provided with the product
- The supplied voltage cords consist of one each red, yellow, blue and gray cords, and four black cords. Connect only the cords actually needed for measurement. Cords not being used for measurement should be disconnected.

Connecting the voltage cords to the instrument

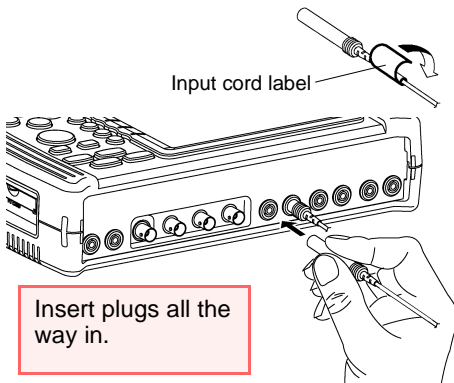

1. At each end of each cord, apply the labels that correspond to the (same-color) input terminal to which it is to be connected.
2. Insert each voltage cord into the input terminal of the same color.

Because the channel 4 input terminal is isolated from the other inputs, it can be used for the following types of measurement.

- Measuring voltage on the neutral line in the same system
- Measuring line voltage in another system
- Measuring DC power

3.5 Connecting the Voltage Cords

Voltage cords and measurement lines

<p>Single-phase 2-wire (1P2W)</p>	<p>Measurement Line type</p> <p>Voltage input terminals</p>
<p>Single-phase 3-wire (1P3W)</p>	<p>Measurement Line type</p> <p>Voltage input terminals</p>
<p>Three-phase 3-wire (3P3W2M)</p>	<p>Measurement Line type</p> <p>Voltage input terminals</p>
<p>Three-phase 3-wire (3P3W3M)</p>	<p>Measurement Line type</p> <p>Voltage input terminals</p>
<p>Three-phase 4-wire (3P4W)</p>	<p>Measurement Line type</p> <p>Voltage input terminals</p>

3.6 Wiring Adapter Connection (Option)



! DANGER

- To avoid electric shock, turn the instrument off when connecting a wiring adapter.
- The maximum rated working voltage is 780 Vrms, 1103 V peak. Attempting to measure voltage in excess of the maximum rating could destroy the product and result in personal injury or death.
- The maximum rated voltage between input terminals and ground is 600 Vrms. Attempting to measure voltages exceeding 600 Vrms with respect to ground could damage the product and result in personal injury.

The Wiring Adapter are specially designed to facilitate connections to three-phase 3- and 4-wire systems.

For three-phase 3-wire (3P3W3M):

Model 9264-01 WIRING ADAPTER

Only three voltage cords need to be connected to the circuit, instead of six.

For three-phase 4-wire:

Model 9264-02 WIRING ADAPTER

Only four voltage cords need to be connected to the circuit, instead of six.

The voltage cords required depends on the lines to be measured.

❖ Voltage cords and measurement lines (page 34)

Connecting a Wiring Adapter to the Instrument

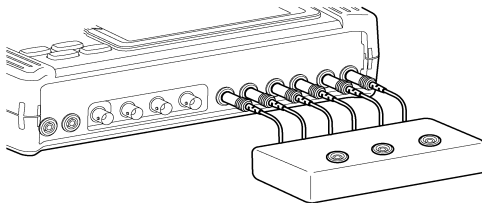

Connect all six output leads from the Wiring Adapter to the voltage input terminals with the corresponding colors on the instrument.

Insert plugs all the way in.

3.6 Wiring Adapter Connection (Option)

Three-phase 3-wire (3P3W3M)

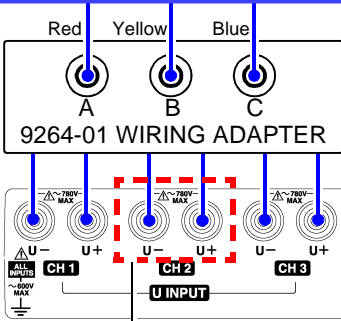

For 3P3W2M, cross these connections.

Three-phase 4-wire (3P4W)

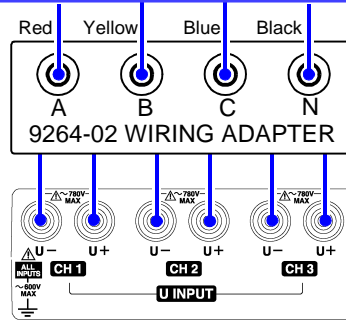

9264-01, 9264-02 WIRING ADAPTER Specifications

Operating environment	Indoors, altitude up to 2000 m (6562-ft.)
Storage temperature and humidity	-20 to 50°C (-4 to 122°F), 80% RH or less (non-condensating)
Operating temperature and humidity	0 to 40°C (32 to 104°F), 80% RH or less (non-condensating)
Maximum input voltage	780 Vrms, 1103 V peak (between A and B, B and C, C and A)
Maximum rated voltage to earth	600 Vrms (9264-02 WIRING ADAPTER: between A and N, B and N, C and N)
Dielectric strength (50/60 Hz)	5.55 kVrms for one minute (current sensitivity 1 mA) (Between voltage input terminals and case)
Applicable Standards	Safety EN61010-1:2001 Voltage Input: Pollution Degree 2, Measurement Category III (anticipated transient overvoltage 6000V)
Dimensions	Approx. 125W x 80H x 32D mm (4.92"W x 3.15"H x 1.26"D) (Cable length: 152 mm, 5.98")
Mass	Approx. 180 g (6.3 oz)

Internal connection diagram

9264-01 WIRING ADAPTER

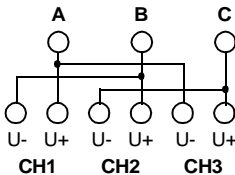

9264-02 WIRING ADAPTER

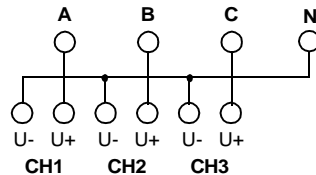

3.7 Using a Clamp-On Sensor (Option)



DANGER

Connect the clamp-on sensor to the instrument first, and then clamp around the line to be measured.

Observe the following to avoid electric shock and short circuits.

- The clamp sensor should only be connected to the secondary side of a breaker, so the breaker can prevent an accident if a short circuit occurs. Connections should never be made to the primary side of a breaker, because unrestricted current flow could cause a serious accident if a short circuit occurs.
- When the clamp sensor is opened, do not allow the metal part of the clamp to touch any exposed metal, or to short between two lines, and do not use over bare conductors.
- To prevent damage to the instrument and sensor, never connect or disconnect a sensor while the power is on, or while the sensor is clamped around a conductor.

This instrument supports voltage-output type clamp-on sensors. The clamp-on sensor should provide about 0.5V rms output for full-scale current measurement.

- To use Model 9661, 9660, 9694, 9669 and 9667 Clamp-On Sensors, select the model name displayed in the instrument's clamp sensor settings.
- To use the Model 9695-02 CLAMP ON SENSOR, set the clamp-on sensor setting to "10 mV/A".
- To use the Model 9695-03 CLAMP ON SENSOR, set the clamp-on sensor setting to "9660".
- The Model 9657-10 and 9675 CLAMP ON LEAK SENSOR can be used with this instrument. Set the clamp-on sensor setting to "100 mV/A".

3.7 Using a Clamp-On Sensor (Option)

3.7.1 Clamp-On Sensor Specifications

Refer to the Instruction Manual for the specific model for more details.

(Hioki recommendations)

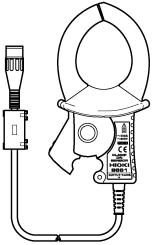
9661 CLAMP ON SENSOR

Primary current rating	500 A AC
Output voltage	1 mVAC/A
Maximum input current	550 A continuous (at 45 to 66 Hz, 50°C)
Amplitude accuracy	±0.3% rdg. ±0.01% f.s. (f.s.=500 A, 45 to 66 Hz)
Phase accuracy	±0.5° or less (45 Hz to 5 kHz)
Amplitude frequency characteristic	±1% accuracy or better from 40 Hz to 5 kHz
Maximum rated voltage to earth	600 Vrms
Measurable conductor diameter	46 mm max.
Operating temperature and humidity	0 to 50°C (32 to 122°F), 80% RH or less

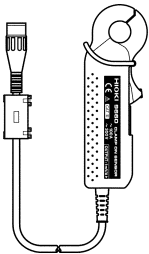
9660 CLAMP ON SENSOR

Primary current rating	100 A AC
Output voltage	1 mVAC/A
Maximum input current	130 A continuous (at 45 to 66 Hz, 50°C)
Amplitude accuracy	±0.3%rdg. ±0.02%f.s.(f.s.=100 A, 45 to 66 Hz)
Phase accuracy	±1° or less (45 Hz to 5 kHz)
Amplitude frequency characteristic	±1% accuracy or better from 40 Hz to 5 kHz
Maximum rated voltage to earth	300 Vrms
Measurable conductor diameter	15 mm max.
Operating temperature and humidity	0 to 50°C (32°F to 122°F), 80% RH or less

3.7 Using a Clamp-On Sensor (Option)

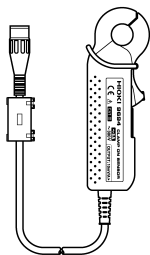
**9694 CLAMP ON SENSOR**

Primary current rating	5 A AC
Output voltage	10 mVAC/A
Maximum input current	50 A continuous (at 45 to 66 Hz , 50°C)
Amplitude accuracy	±0.3%rdg. ±0.02%f.s.(f.s.=5 A, 45 to 66 Hz)
Phase accuracy	±2° or less (45 Hz to 5 kHz)
Amplitude frequency characteristic	±1% accuracy or better from 40 Hz to 5 kHz
Maximum rated voltage to earth	300 Vrms
Measurable conductor diameter	15 mm max.
Operating temperature and humidity	0 to 50°C (32 to 122°F), 80% RH or less

Accuracy of the combination of the 9660/9661/9669/9694 and the 3196:

Example: Using the 9661, 50 A range setting (3196), when measuring 50 Arms

Error of 9661 + Error of 3196 = Total error

$$\begin{aligned} \text{Error of 9661} &= 50 \text{ A(measurement)} \times 0.3\% \text{ rdg.} + 500 \text{ A(rating)} \times 0.01\% \text{ f.s.} \\ &= (50 \times 0.3/100) + (500 \times 0.01/100) \\ &= 0.15 + 0.05 \\ &= \underline{0.20 \text{ A}} \end{aligned}$$

$$\begin{aligned} \text{Error of 3196} &= 50 \text{ A (measurement)} \times 0.2\% \text{ rdg.} + 50 \text{ A (range)} \times 0.1\% \text{ f.s.} \\ &= (50 \times 0.2/100) + (50 \times 0.1/100) \\ &= 0.1 + 0.05 \\ &= \underline{0.15 \text{ A}} \end{aligned}$$

$$\begin{aligned} \text{Total error} &= 0.20 \text{ A} + 0.15 \text{ A} \\ &= \underline{\pm 0.35 \text{ A}} \end{aligned}$$

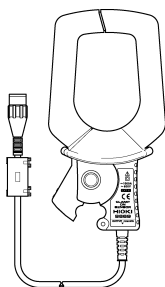
9669 CLAMP ON SENSOR

Primary current rating	1000 A AC
Output voltage	0.5 mV AC/A
Maximum input current	1000 A continuous (at 45 to 66 Hz , 50°C)
Amplitude accuracy	±1.0% rdg. ±0.01% f.s. (f.s.=1000 A , 45 to 66 Hz)
Phase accuracy	±1° or less (45 Hz to 5 kHz)
Amplitude frequency characteristic	±2% accuracy or better from 40 Hz to 5 kHz
Maximum rated voltage to earth	600 Vrms
Measurable conductor diameter	55 mm max.
Operating temperature and humidity	0 to 50°C (32 to 122°F), 80% RH or less

3.7 Using a Clamp-On Sensor (Option)

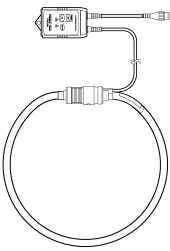
9667 FLEXIBLE CLAMP ON SENSOR

Primary current rating	50A to 500A AC 500A to 5000A AC
Output voltage	500 mV AC f.s. (1 mVAC/A) 500 mV AC f.s. (0.1 mVAC/A)
Maximum input current	10000 A continuous at 45 to 66 Hz
Amplitude accuracy	±2.0% rdg. ±1.5 mV (45 to 66 Hz)
Phase accuracy	±1° or less (45 to 66 Hz)
Amplitude frequency characteristic	Within ±3 dB, 10 Hz to 20 kHz
Maximum rated voltage to earth	1000 Vrms
Measurable conductor diameter	254 mm max.
Operating temperature and humidity	0 to 40°C (32 to 104°F), 80% RH or less humidity
Power supply	LR03 alkaline battery x 4 or 9445-02/03 AC ADAPTER

Accuracy of the combination of the 9667 and the 3196:

Example: Using the 9667 (500 A rating), 500 A range setting (3196), when measuring 500 Arms

Error of 9667 + Error of 3196 = Total error

$$\begin{aligned} \text{Error of 9667} &= 500\text{A}(\text{measurement}) \times 2.0\%\text{rdg.} + 500\text{A}(\text{rating}) \times 1.5\text{mV}/500\text{mV} \\ &= (500 \times 2/100) + (500 \times 1.5/500) \\ &= 10 + 1.5 \\ &= \underline{11.5\text{A}} \end{aligned}$$

$$\begin{aligned} \text{Error of 3196} &= 500\text{A}(\text{measurement}) \times 0.2\%\text{rdg.} + 500\text{A}(\text{range}) \times 0.1\%\text{f.s.} \\ &= (500 \times 0.2/100) + (500 \times 0.1/100) \\ &= 1 + 0.5 \\ &= \underline{1.5\text{A}} \end{aligned}$$

$$\begin{aligned} \text{Total error} &= 11.5\text{A} + 1.5\text{A} \\ &= \underline{\pm 13\text{A}} \end{aligned}$$

3.7.2 Connecting a Clamp-on Sensor

Connecting a Clamp Sensor to the Instrument

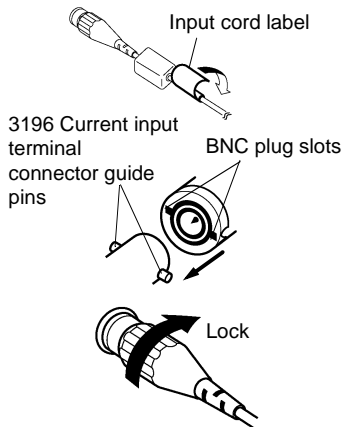

1. At each end of the cable, apply the labels having the same color as the current input terminal to which it is to be connected.
2. Align the slots in the BNC plug with the guide pins on the connector at the instrument side, then push and turn the plug clockwise.
(to unplug the connector, push the plug and turn it counterclockwise before pulling it apart.)

NOTE

When disconnecting the BNC connector, be sure to release the lock before pulling the connectors apart. Forcibly pulling the connector without releasing the lock, or pulling on the cable, can damage the connector.

Single-phase 2-wire (1P2W)

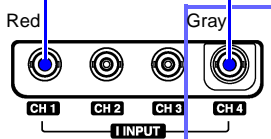

Single-phase 3-wire (1P3W)

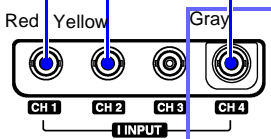

Measurement line type

Current Input terminals

Three-phase 3-wire (3P3W2M)

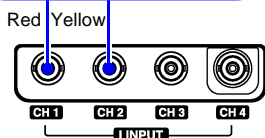

Three-phase 3-wire (3P3W3M)

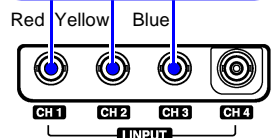

Three-phase 4-wire (3P4W)

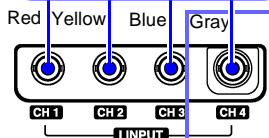

The current input terminal of channel 4 can be used in the following two ways.

- Measuring current on the neutral or ground line in the same system
- Measuring line current in a separate system

3.8 Turning the Power On/Off

! WARNING

- Before turning power on, verify that the instrument and peripheral devices are correctly installed and connected.
- When using the AC adapter: AC adapter input voltage range is 100 to 240 VAC (with $\pm 10\%$ stability) at 50/60 Hz. To avoid electrical hazards and damage to the product, do not apply voltage outside of this range.

Turning the Instrument On/Off

Powering On

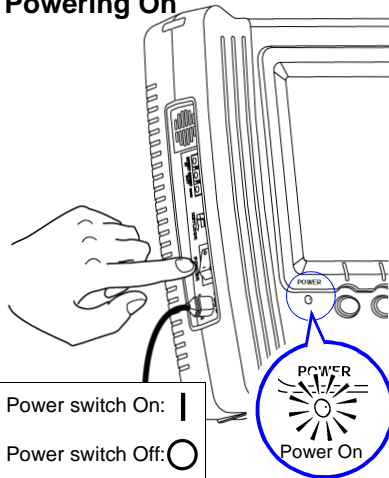

1. Turn the POWER switch ON (|).

2. The POWER LED lights

Green	Indicates the AC Adapter is in use
Red	Indicates operation from the battery pack without the AC Adapter*

3. Symbol on the screen at the lower left indicate the power status

Indication	Power supply status
White / Red	Powered by AC adapter Battery pack is charging
White / White	Powered by AC adapter Installed Battery Pack
White	Powered by battery pack*
White	Powered by battery pack, but charge is low.*

Powering Off

Turn the POWER switch OFF (O).*

*: See NOTE

NOTE

- When the POWER LED is red or the mark is not displayed, power is not being supplied from the mains. In this case, measurements can be taken using battery power for up to about 30 minutes. Make sure the AC Adapter is securely connected to the power outlet and to the instrument.
- Data in internal memory is erased whenever the instrument is turned off. Therefore, to preserve recorded data, be sure to save it to a PC Card.

Saving, Loading and Deleting (page 53)

Screen Display at Power On

HIOKI 3196 POWER QUALITY ANALYZER	Model Information
Ver 1.40	Version
MAIN Boot Complete!!!	Internal component test results
SUB Boot Complete!!!	
AMP Boot Complete!!!	
DRAM Check!!! Pass!	Internal memory test results
VRAM Check!!! Pass! !!!	
INIT RTC	Initialization information
INIT PC-CARD	
INIT WinSystem	
INIT AMP	

The initial screen appears when power is turned on and during self-testing.

When the self-test finishes, [SYSTEM] - DF1 [WIRING] screen appears.

NOTE

If an error occurs during self-testing, the instrument may be damaged. Contact your dealer or Hioki representative.

Before turning off the power

NOTE

Data in internal memory is erased whenever the instrument is turned off. Therefore, to preserve recorded data, be sure to save it to a PC Card.

- ❖ Saving, Loading and Deleting (page 53)
- ❖ Saving a Settings File to a PC Card (from [SETTING]/[ANALYZING] modes) (page 112)
- ❖ Automatically Saving Measurement Data to a PC Card (page 113)
- ❖ Storing data on a PC card after measurement (during [ANALYZING]) (page 114)

3.8 *Turning the Power On/Off*

Connecting to Lines to be Measured

4

Please read the Usage Notes (page 7) before making connections.

4.1 Connection Procedure

❖ Connecting the Voltage Cords (page 33)
 ❖ Using a Clamp-On Sensor (Option) (page 37)
 ❖ Turning the Power On/Off (page 42)

- 

Setting Details

1 Verify that the voltage cord or clamp-on sensor is properly connected to the input terminals.
- 2** Turn on (|) the 3196.
- 3** Set up the connection (wiring) configuration, nominal voltage and frequency.
- 

4 Connect the voltage cords and clamp-on sensor to the lines to be measured in accordance with the displayed connection diagram.

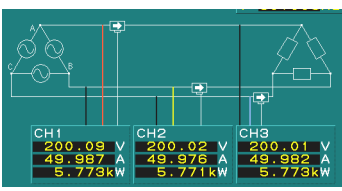
❖ (page 51)
- 

5 Verify the currently selected connection states (the voltage, power and active power selections for each channel).

❖ (page 51)
- 

6 Check the connection states and set the appropriate ranges (check the voltage and current amplitude and phase on the vector display).

❖ (page 51)

OK ↓ NG → Go to 4
- 7** Set up for recording or events as needed.

❖ Quick Reference (page 51)
 ❖ Peripheral Devices (page 109)
 ❖ Data Recording, Saving, Loading and Deleting (page 53)

Measurement

❖ Measurement Method (page 57)

4

Connecting to Lines to be Measured

4.2 Connection Methods

CAUTION

- To measure 3-phase lines, the instrument channels (CHs 1 to 3) should be connected in corresponding phase order.
- The instrument can measure from single-phase 2-wire to three-phase 4-wire circuits, but voltage measurement at three points in single-phase circuits is not supported.

NOTE

- For voltage and current measurements in which power values are not needed, the measurement mode can be set to three-phase 4-wire to enable the input terminals of all four channels for voltage or current measurements. However, be aware that channels 1 to 3 are not isolated from one another.
- To ensure correct measurement results, follow the instrument setup and connection instructions precisely.

Connecting the Voltage Cords to the Lines to be Measured

(Example)

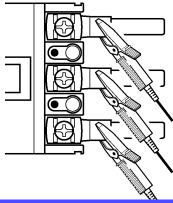

Clip securely to metal parts such as connection screws or bus bars at the power side.

Clamping a Sensor to a Line to be Measured

(Example: 9660)

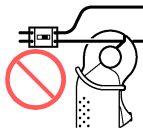

Clamp around only one conductor. Measurement is not possible if the clamp is placed around two lines in a single-phase circuit, or three lines in a three-phase circuit.

(Example: 9660)

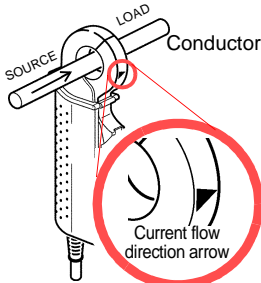

(Example: 9661)

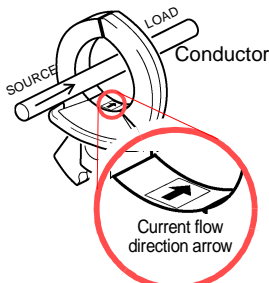

The arrows on the clamp indicating the direction of current flow should point toward the load side.

4.2.1 Single-Phase System Connections

Single-phase 2-wire (1P2W)

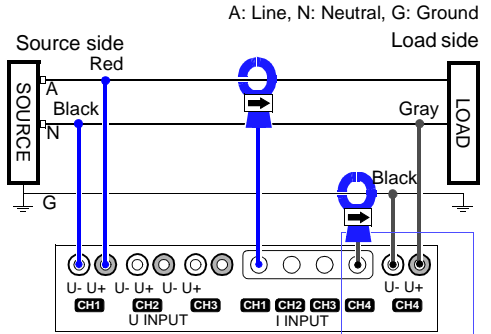
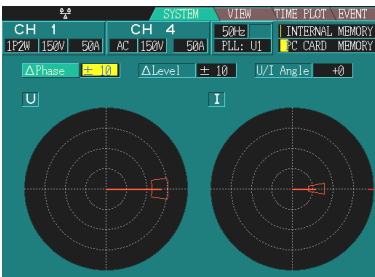
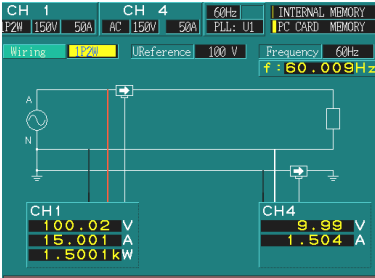

⇒ Face the arrow toward the Load Ground line measurement, etc.

U1=100 V
I1=15 A
U4=10 V
I4=1.5 A

Single-phase 3-wire (1P3W)

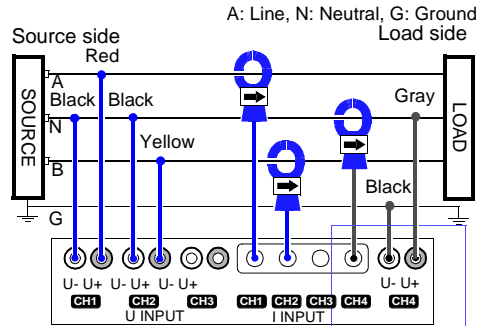
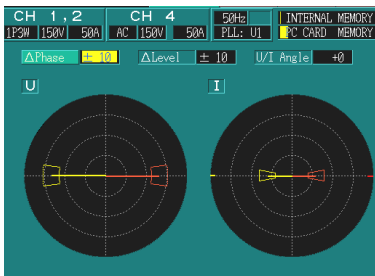
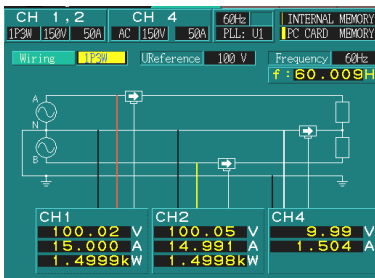

⇒ Face the arrow toward the Load Ground line measurement, etc.

U1=U2=100 V
I1=I2=15 A
U4=10 V
I4=1.5 A

4 Connecting to Lines to be Measured

Three-phase 4-wire (3P4W)

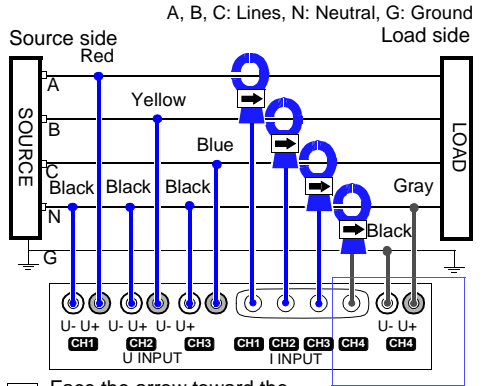
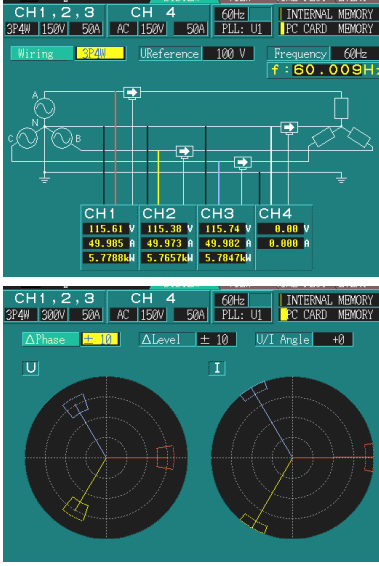

Face the arrow toward the Load

Ground line measurement, etc.

$U1=U2=U3=115.5 V$
 $I1=I2=I3=50 A$
 $U4=0 V$
 $I4=0 A$

4 Connecting to Lines to be Measured

4.2.2 Connecting to Multiple Systems

2 systems

1 system and DC power supply

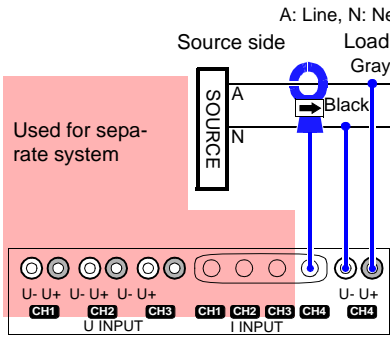

Face the arrow toward the

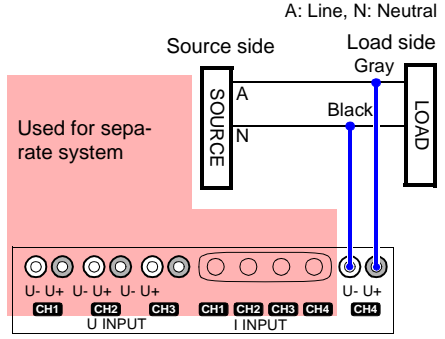



Quick Reference

5

This chapter describes the operating procedures for various applications. For instrument setting details, See the Instruction Manual (CD-R version).

5.1 Connection and System Settings

Connection Settings

Connection Methods(page 46), Checking Three-phase Systems(page 57)

Verify the connection diagram



Check the connections



Select the connection method



System Settings

Select measurement-related system settings



Select recording-related system settings



Select hardware-related system settings



Confirm the version of the instrument



System reset

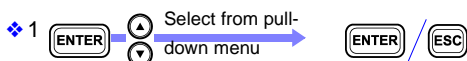

5.2 Data Display

Displaying Measurement Data

Waveform Display

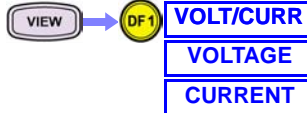

Vector Display



DMM (Digital Multi-Meter) Display

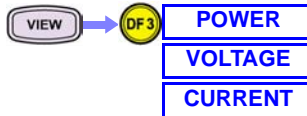

Harmonic Display



Displaying Recording Graphs

Displays the time series graph of RMS values

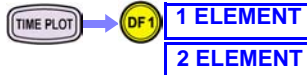

Displays the time series graph of voltage values



Displays the voltage fluctuation graph for the event occurrence



Displays the time series graph of harmonic values



Displays the time series graph of Flicker



5.3 Data Recording, Saving, Loading and Deleting

Recording

Manual Recording



Automatic Recording

Set the times to start and end recording

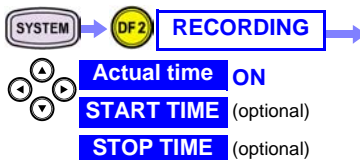

Saving, Loading and Deleting

Using a PC Card (page 109)

Saving, Loading and Deleting Internal Memory Data

Up to 10 setting status files can be saved.

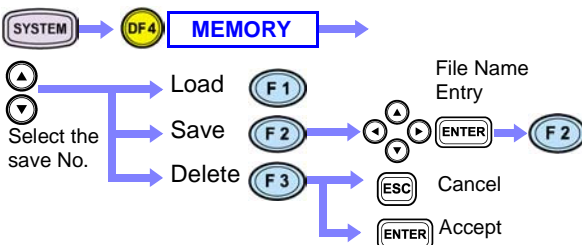

Saving, Loading and Deleting PC Card Data

Setting states and measurement data can be stored.

NOTE:
We recommend the use of automatic saving in binary format to save measurement data to a PC card. (page 113)

Insert a PC Card

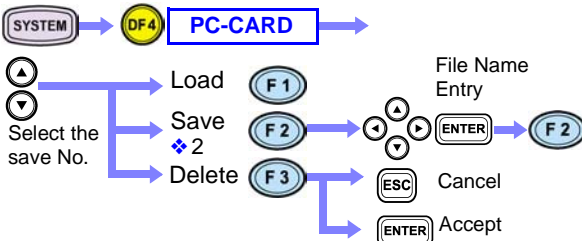

- ❖ 2: When setting, only the setting status stored.
When analyzing, select whether to save setting status or measurement data (binary or text format) and then save.

Hard Copy

Using a PC Card(page 109),Using a Printer (Option)(page 116)

Manual Hard Copy

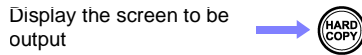

Auto Hard Copy

❖ Using a PC Card(page 109)

❖ Using a Printer (Option) (page 116)

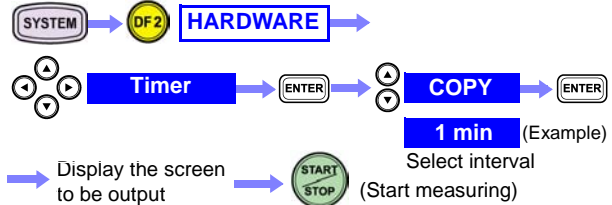

5.4 Event Analysis

Event Setting

To set an event

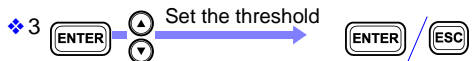
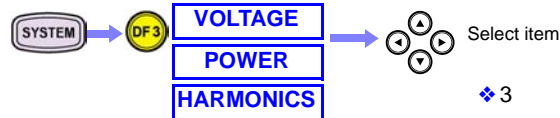

Analysis

To determine if an event occurs



To analyze waveforms for event occurrence



Manual Event

Manual event setting



5.5 Using Peripheral Devices

Setting a Connection Destination



Using a PC Card

❖ 7.1 Using a PC Card (page 109)

Using a Printer

❖ 7.2 Using a Printer (Option) (page 116)

Using a PC

❖ 7.3 Using the Instrument with a Computer (page 121)

Remote operation by
cellular telephone

Monitoring with a Web browser via LAN or modem.
❖ See the Instruction Manual (CD-R version).

HTTP Server function
(system setting, event list, remote operation)
❖ See the Instruction Manual (CD-R version).

Enabling External Event
Input

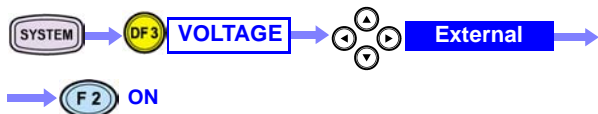

5

Quick Reference



Measurement Method

6

Before measuring, make sure you read the information on precautions for using this device and connection methods. For screen setting details, See the Instruction Manual (CD-R version).

6.1 Checking Three-phase Systems

Check that the power distribution board you are using has a 400 V three-phase 3-wire configuration.

Measurement location Three-phase 3-wire 400 V power line on a distribution board (50 Hz, 50 A load)

- Application**
- To connect the 3196 to the measured power line while viewing the connection diagram on the screen
 - To check whether the connection is correct on the vector screen
 - To check the three-phase voltage and three-phase current waveforms
 - To check the voltage unbalance factor and current unbalance factor

1. Measurement preparations

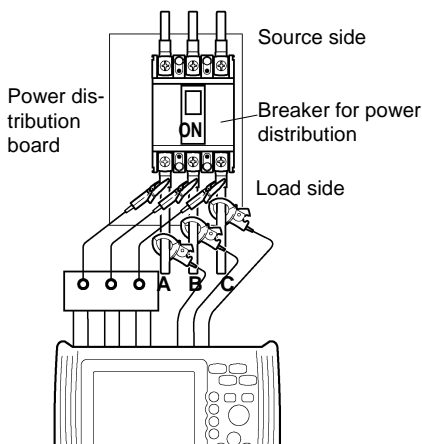

Required for connection:

- 3196 + 9458 AC ADAPTER + 9459 BATTERY PACK
- 9438-02 VOLTAGE CORD (One cord each of red, yellow, and blue, and three black cords.)
- 9661 CLAMP ON SENSOR, 3 each

When using the three-phase connection adapter

- 9264-01 WIRING ADAPTER(3P3W3M)
- 9438-02 VOLTAGE CORD (One cord each of red, yellow, and blue.)

2. Making 3196 settings

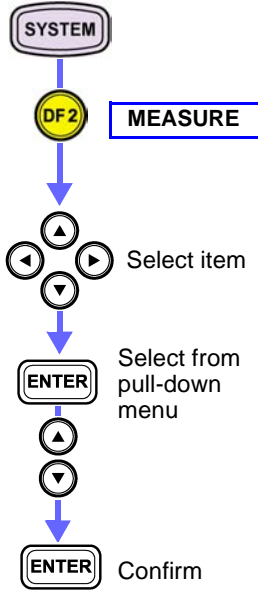

	123ch	4ch	UReference	400 V
Wiring	3P3W3M	AC	Frequency	50Hz
Clamp	1mV/A 9661	1mV/A 9661	PLL Source	U1
U Range	600V	600V	U CalcType	LINE-LINE
PT Ratio	1	1	Harm Calc	LEVEL
I Range	50A	50A	THD Calc	THD_F
CT Ratio	1	1	PF Type	PF
			Flicker	OFF
			EN50160	OFF

Make the following settings.

Setting Item	Selections
123ch/ Wiring	3P3W3M
123ch/Clamp	1 m V/A 9661
123ch/U Range	600 V
123ch/PT Ratio	1
123ch/I Range	50 A
123ch/CT Ratio	1
UReference	400 V
Frequency	50 Hz
PLL Source	U1
U CalcType	LINE-LINE
EN50160	OFF

3. Connecting to the lines to be measured

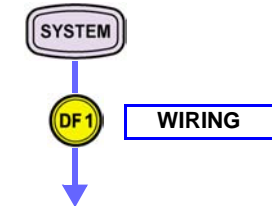

Connect the 3196 to the measured power line while viewing the connection diagram.

When using the 9264-01 WIRING ADAPTER, the black cords are not required.

Confirm the connection on the screen.

- Is the voltage displayed for CH1, CH2, and CH3 approximately 400 V?
- Is the current displayed for CH1, CH2, and CH3 approximately 50A?
- Is the active power displayed for CH1, CH2, and CH3 a positive value?

Remedy

When a negative value is displayed for active power

- Check that the voltage cord for the channel that is displaying the negative value is connected properly.
- Check that the clamp-on sensor for the channel that is displaying the negative value is clamped to the power line so that it points in the direction of the Load (current direction display).

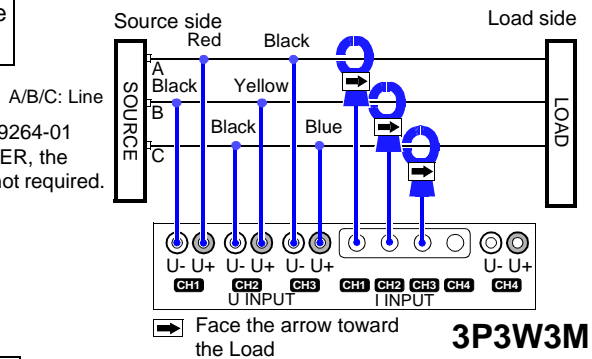
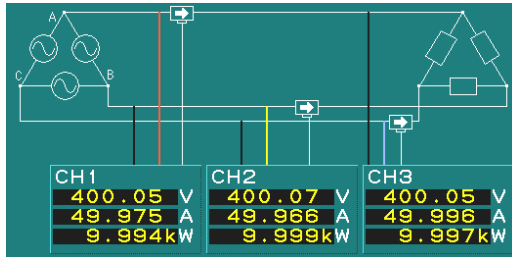

4. Checking the connections

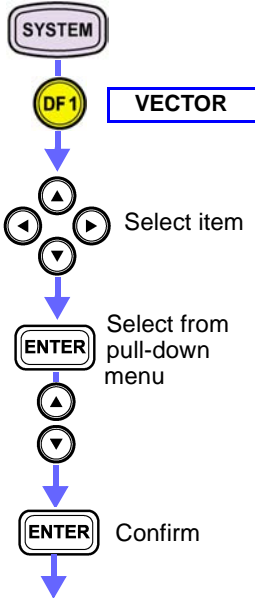

Confirm the connection on the screen.

- **Voltage vector diagram:**
Are the U1, U2, and U3 vectors within the same colored nominal ranges?
- **Current vector diagram:**
Are the I1, I2, and I3 vectors within the same colored nominal ranges?

Remedy
(Go to the next page)

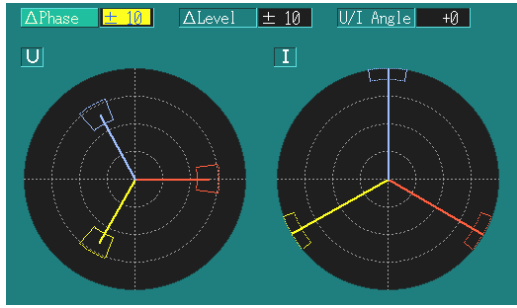

Make the following settings.

Setting Item	Selections	Checking the vector
ΔPhase (Phase range)	±10	Is the vector being measured within ±10° of the nominal phase range for the ideal vector of each phase?
ΔLevel (Amplitude range)	±10	Is the vector being measured within ±10% of the nominal level range for the ideal vector of each phase? (Voltage is set to a percentage of the nominal voltage, and current is set to a percentage of the range.)
U/I Angle (U/I phase difference)	-15	Is the vector being measured within -15° of the nominal range for the phase difference of the voltage vector and current vector for each phase? (Current is set to a LAG of 15 degrees for the voltage.)



Remedy

When they are not within the same colored nominal ranges

1. When the levels differ

- **Voltage:**

Check that the voltage cord has not become disconnected from the power line being measured. Check that the nominal voltage, voltage range, amplitude range, and voltage calculation method are set correctly.

- **Current:**

Check that the clamp-on sensor has not become disconnected from the power line being measured.
Check that the clamp-on sensor, current range, and amplitude range are set correctly.

2. When the phase differs

- **Voltage:**

Check that U+ and U- are not reversed for the CH1, CH2, or CH3 voltage cords.

- **Current:**

Set an appropriate U/I phase difference. (Depending on load conditions, the phase for the current vector differs greatly from the phase for the voltage vector.)

3. When the color differs

- **Voltage:**

Check that the CH1, CH2, and CH3 voltage cords are connected in the correct phase order.

- **Current:**

Check that the CH1, CH2, and CH3 clamp-on sensors are clamped in the correct phase order.

5. Viewing measured data

(1) Checking three-phase voltage and three-phase current waveforms

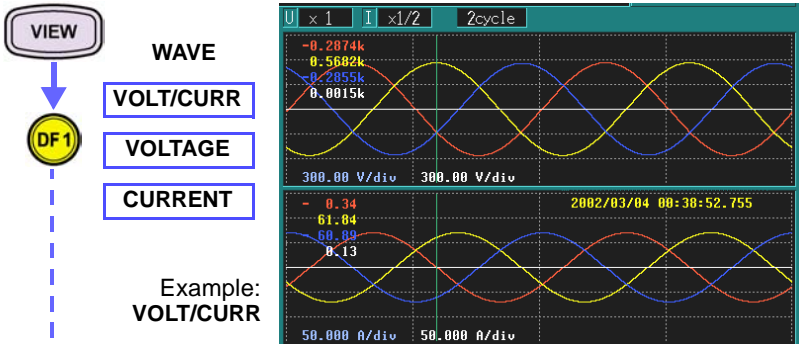

Example:
VOLT/CURR

VOLT/CURR When viewing the waveforms for CH1, CH2, and CH3, you can view CH2 with a 120 degree LAG for CH1, and CH3 with a 120 degree LAG for CH2 for both voltage and current waveforms.

VOLTAGE You can view the CH1, CH2, and CH3 voltage waveforms for each phase.

CURRENT You can view the CH1, CH2, and CH3 current waveforms for each phase.



To change the waveform's amplitude and its number of waves



Changing the voltage amplitude U: x1/3, x1/2, x1, x2, x5, x10

Changing the current amplitude I: x1/3, x1/2, x1, x2, x5, x10

Changing the number of waves: 2 cycles, 4 cycles, 10 cycles



To measure the cursor



Press this button to stop the waveform display.
The cursors can be aligned easily.



To scroll the waveform



(2) Checking the voltage unbalance factor and current unbalance factor

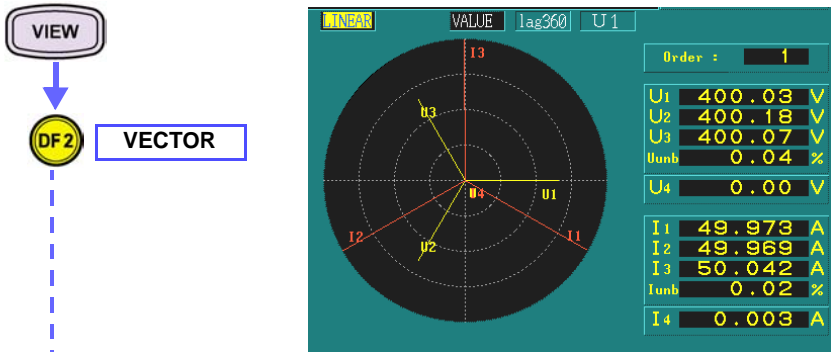

- Check the numerical value for the voltage unbalance factor U_{unb} . 0% The closer the value is to 0%, the more even three-phase voltage is. The larger the degree of unbalance, the larger the U_{unb} value.
- Check the numerical value for the current unbalance factor I_{unb} . The closer the value is to 0%, the more even three-phase current is. The larger the degree of unbalance, the larger the I_{unb} value.



To change the vector's display axis



To change the value displayed for the phase angle



6.2 Change in Power

You can view the active power, reactive power, frequency, and change in voltage for intervals up to 5 days.

Measurement location Three-phase 3-wire 400 V power line on a power distribution board (50 Hz, 50 A load)

- Application**
- To view the MAX, MIN, and AVE values for fluctuations in active power, reactive power, frequency, and voltage over a 5-day interval
 - To check recorded conditions using the fluctuation graph. Further, to view the voltage and current waveforms for that condition.

1. Measurement preparations

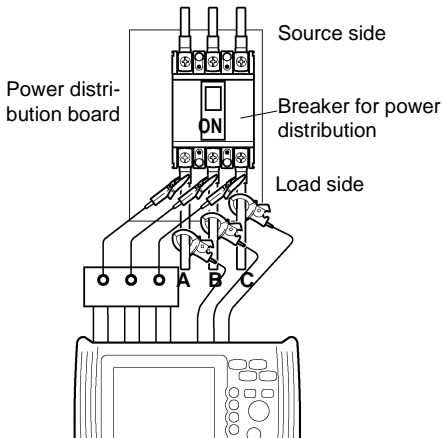

Required for connection:

- 3196 + 9458 AC ADAPTER + 9459 BATTERY PACK
- 9438-02 VOLTAGE CORD (One cord each of red, yellow, and blue, and three black cords.)
- 9661 CLAMP ON SENSOR, 3 each

When using the three-phase connection adapter

- 9264-01 WIRING ADAPTER(3P3W3M)
- 9438-02 VOLTAGE CORD (One cord each of red, yellow, and blue.)

2. Making 3196 settings (measurement settings)

Use the same method as three-phase checking. (page 58)

3. Connecting to the lines to be measured

Use the same method as three-phase checking. (page 59)

4. Checking the connections

Use the same method as three-phase checking. (page 60)

5. Making 3196 settings (recording settings)

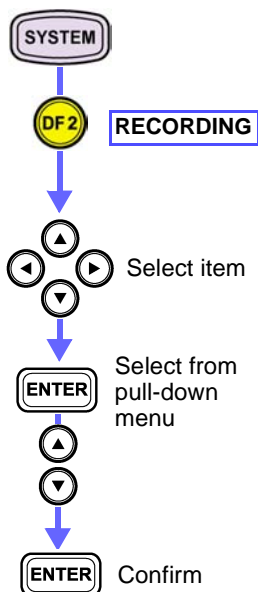

Rec. Data	Power	MAX/MIN/AVE
MemoryFull	STOP	
Interval	1 min	05 01:51:00
Auto Save	OFF	
Time Start	OFF	
RepeatSave	OFF	99 times
Start Time	2002 Y 9 M 5 D	0 h 0 m
Stop Time	2002 Y 9 M 11 D	23 h 59 m

Make the following settings.

Setting Item	Selections
Rec. Data	Power, MAX/MIN/AVE
Memory Full	STOP
Interval	1 min (5 days, 1 h, 51 m)

Shows the maximum interval that you can record for using the above settings.

When recording to a PC card:

Insert a Flash ATA card into the PC card slot. Recorded data is automatically saved to the internal memory at the same time.

Setting Item	Selections
Memory Full	LOOP
Auto Save	BINARY

You can increase the maximum recording interval by using an ATA Flash card.

Example: When using a 32-MB PC card, the recording capacity increases about 4 times. A recording interval of 20 days, 7 hours, and 24 minutes is possible.

6. Starting the recording interval

[SETTING]



When starting or ending recording manually:

Setting Item	Selections
Time Start (Actual time control)	OFF

Press this when you want to start recording.
(Recording starts regardless of the presently displayed screen.)

When recording using real-time control:

Setting Item	Selections
Time Start (Actual time control)	ON
Start Time	Make the desired setting.
Stop Time	Make the desired setting.

Press this after you have finished making settings.

[RECORDING]

7. Viewing measured data during recording

(1) Checking recorded conditions using the fluctuation graph

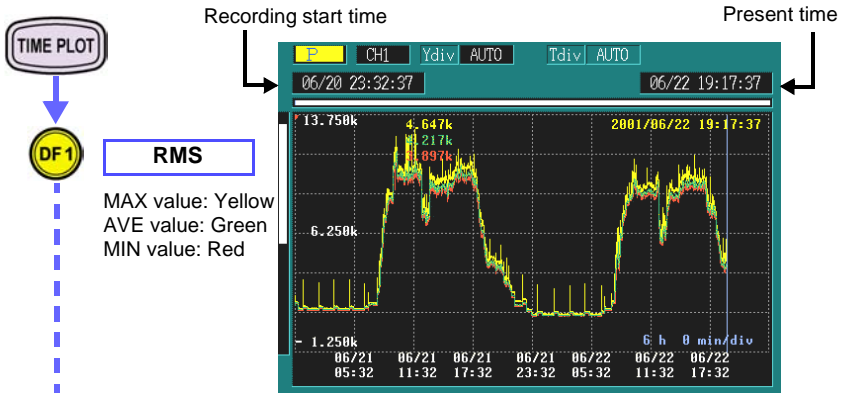

The vertical and horizontal scales for the fluctuation graph during recording are changed automatically.

If you want to change the vertical scale, you can do so while recording is in progress; however, you must first stop recording if you want to change the horizontal scale.

Use this to calculate all of the calculation items that can be displayed for a change in RMS every 200 ms without any gaps. (Every 10 cycles at 50 Hz or every 12 cycles at 60 Hz.)

MAX, MIN, and AVE values are recorded every 200 ms for the set interval.

Example: When the interval is set to 1 m:

The MAX, MIN, and AVE values are recorded for 300 points of data recorded every 200 ms.



To display the fluctuation graph for active power



Set to P.

(Select a channel from CH1, CH2, and CH3.)

(2) Confirming voltage and current waveforms during recording

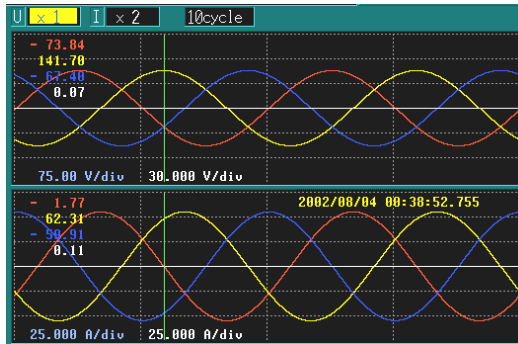
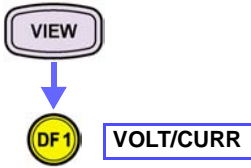

You can confirm the setting contents (SYSTEM-DF2) and waveform display (VIEW-DF1/2/3/4) during recording, but you cannot change the contents of setting.

When you want to change the setting contents, you must stop recording first.

8. Ending the recording interval

[RECORDING]

When recording was started manually:

Press this when you want to end recording.

(You can end recording regardless of the presently displayed screen.)



When set to record using real-time control:

Recording ends automatically when the recording end time is reached.

[ANALYZING]

If the internal memory becomes full (when the memory is full and "STOP" is selected) or the PC card memory becomes full (when the memory is full and "LOOP" is selected), recording ends automatically.



To end recording and start it again



In this case, recorded data is deleted. Therefore, to preserve data, be sure to save it to a PC Card.

Start recording

NOTE

Recorded data is erased whenever the instrument is turned off. Therefore, to preserve recorded data, be sure to save it to a PC Card.

❖ Data Recording, Saving, Loading and Deleting (page 53)

9. Viewing measured data that has been recorded

Viewing the change in MAX, MIN, and AVE values for RMS voltage over a 5-day interval

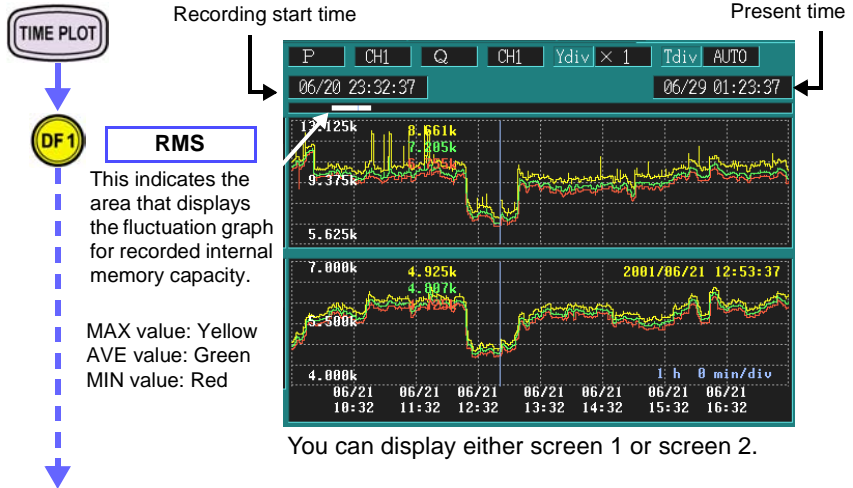

? To display the fluctuation graph for active power, reactive power, frequency, and voltage



Displayed items: P, Q, Freq, U, Uave,
Displayed channel: CH1, CH2, CH3, sum
(Shows 1, 2, 3: channel, sum: total value for three-phase,
and ave: average value for three-phase.)

? To change the scale for the Y- or X-axis



Y-axis Y div: x1, x2, x5, x10, x25, x50
X-axis T div: x1, x1/2, x1/4, x1/8, x1/16, x1/32, x1/64

? Use the same method as three-phase checking for cursor measurement and scrolling.

- ❖ To measure the cursor (page 62)
- ❖ To scroll the waveform (page 62)

6.3 Harmonic Fluctuation

Viewing the harmonic fluctuation for high-voltage three-phase systems over a 1-week period

Measurement location Secondary side of a 6.6 kV three-phase (3P3W3M) high-voltage system inside a cubicle
 Voltage: Primary side 6.6 kV, secondary side 110 V
 Current: Primary side 300 A, secondary side 5 A

Application • To check whether the total voltage distortion or harmonic current limit specified in the IEC Standards have been exceeded

1. Measurement preparations

High-voltage
power distribution
board

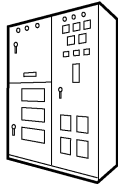

To CTT

To VTT

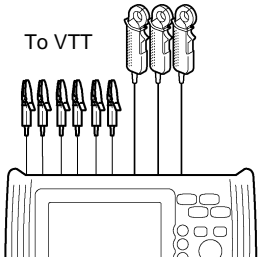

Required for connection:

- 3196 + 9458 AC ADAPTER + 9459 BATTERY PACK
- 9438-02 VOLTAGE CORD (One each red, yellow, and blue cord, and three black cords.)
- 9694 CLAMP ON SENSOR, 3 each

When using the three-phase connection adapter

- 9264-01 WIRING ADAPTER(3P3W3M)
- 9438-02 VOLTAGE CORD (One each red, yellow, and blue cord.)

2. Making 3196 settings (measurement settings)

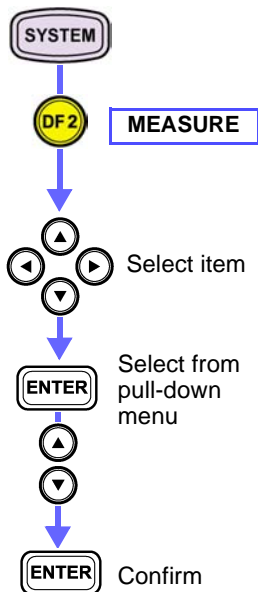

123ch	4ch	UReference	110 V
Wiring	3P3W3M	Frequency	50Hz
Clamp	10mV/A9694 10mV/A9694	PLL Source	U1
U Range	150V 150V	U CalcType	LINE-LINE
PT Ratio	60 60	Harm Calc	LEVEL
I Range	50A 50A	THD Calc	THD_F
CT Ratio	60 60	PF Type	PF
		Flicker	OFF
		TimePlot U	Urms
		EN50160	OFF

Make the following settings.

Setting Item	Selections
123ch/ Wiring	3P3W3M
123ch/ Clamp	10mV/A 9694
123ch/ U Range	150V
123ch/ PT Ratio	60
123ch/ I Range	50 A
123ch/ CT Ratio	60
UReference	110V
Frequency	50 Hz
PLL Source	U1
U CalcType	LINE-LINE
Harm Calc	LEVEL
THD Calc	THD_F
EN50160	OFF

3. Connecting to the lines to be measured

Use the same method as with three-phase checking. (page 59)

4. Checking the connections

Use the same method as with three-phase checking. (page 60)

5. Making 3196 settings (recording settings and event settings)

(1) Recording settings

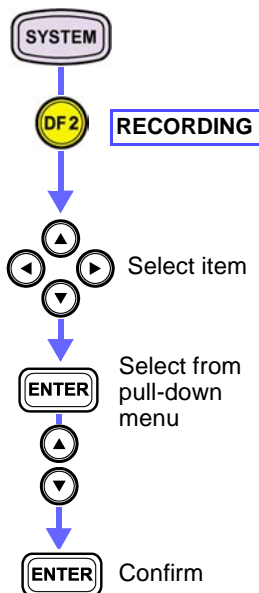

Rec. Data	P & Harm	MAX/MIN/AVE
MemoryFull	STOP	
Interval	30 min	10 14:30:00
Auto Save	OFF	
Time Start	ON	
RepeatSave	OFF	99 times
Start Time	2002 Y 9 M 5 D	0 h 0 m
Stop Time	2002 Y 9 M 11 D	23 h 59 m

Make the following settings.

Setting Item	Selections
Rec. Data	P&Harm, MAX/MIN/AVE
Memory Full	STOP
Interval	30 min (10 days, 14 h, 30 m)

The above settings indicate the maximum possible recording period.

(2) Event settings

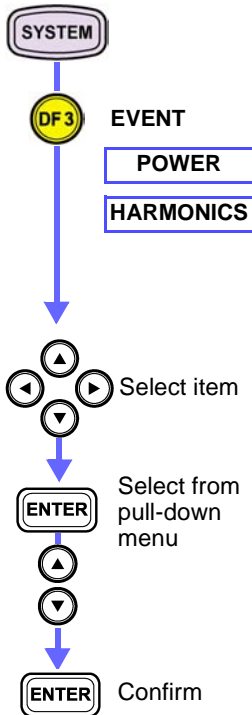

S	OFF	OFF
PF	OFF	OFF
KF	OFF	OFF
U THD	5.00 %	OFF
I THD	OFF	OFF
U unb	OFF	
I unb	OFF	

< 5.00
0.00

	123ch	4ch
U Harmonics	ON : 0	ON : 0
I Harmonics	ON : 21	ON : 0
P Harmonics	ON : 0	ON : 0
Angle	ON : 0	ON : 0

Make the following settings.

[POWER]

Setting Item	Selections
123ch/U THD (Voltage distortion factor)	5%

[HARMONICS]

Setting Item	Selections
123ch/I THD (Current harmonic)	Set the harmonic current limit specified in the IEC Standards

6. Starting the recording

Use the same method as when measuring power fluctuation. (page 66)

7. Viewing measured data during recording

Checking recording conditions with the fluctuation graph

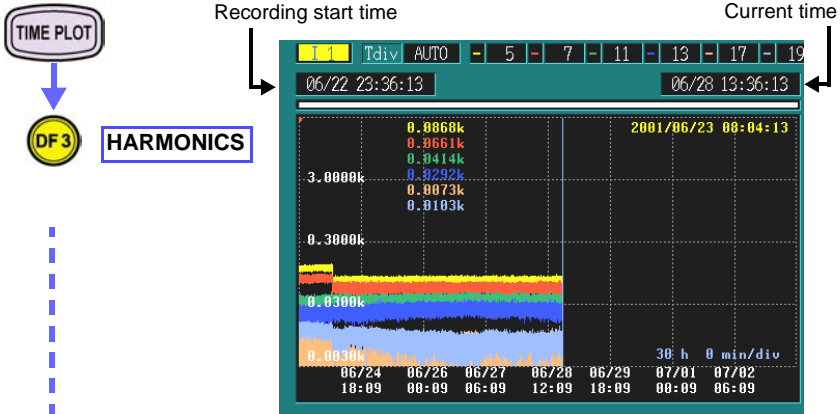

The horizontal scale of the fluctuation graph are changed automatically during recording.
If you want to change the scale, you must stop recording first.

All calculation items that can be displayed for harmonic fluctuation are calculated without gaps every 200 ms. (Every 10 cycles at 50 Hz or every 12 cycles at 60 Hz.)

MAX, MIN, and AVE values are recorded every 200 ms for the set interval. The graph displays values such the MAX, MIN, and AVE values as a single line.

Example: When the interval is set to 1 m:

The MAX, MIN, and AVE values are recorded for 300 points of data recorded every 200 ms.



To display the fluctuation graph for harmonic current I1



Set to I1.



To display the 5th, 7th, 11th, 13th, and 19th harmonic orders



Set to 5, 7, 11, 13, 17, 19.

8. Ending the recording interval

Use the same method as when measuring power fluctuation. (page 68)

9. Viewing recorded measurement data

Monitoring fluctuation in MAX, MIN, and AVE values for harmonic RMS voltage over a 1-week period

(1) Checking whether total voltage distortion specified in the IEC Standards has been exceeded.

Checking using the time series graph

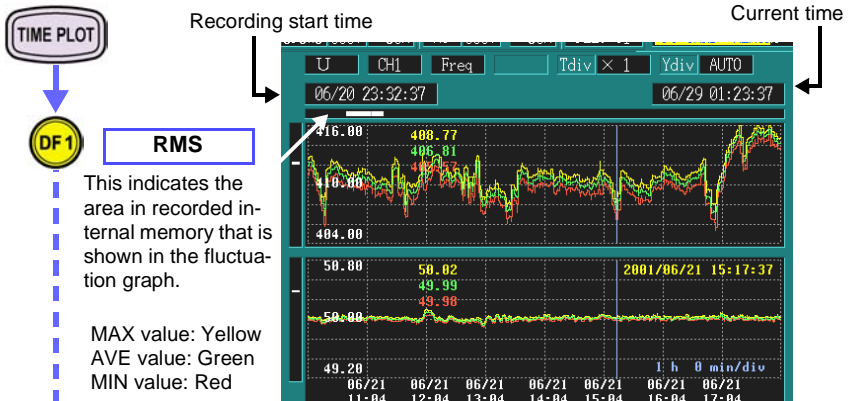

An event occurs when the total voltage distortion factor or harmonic current limit specified in the IEC Standards is exceeded.

If the ▼ mark is displayed in the time series graph, an event has occurred. However, an event occurs whenever recording starts and stops.

To display the fluctuation graph for the total voltage distortion factor



Total voltage distortion: U-THD (Select from CH1, CH2, and CH3.)

6.3 Harmonic Fluctuation

(2) Checking whether the harmonic current limit specified in the IEC Standards has been exceeded.

Checking using the time series graph

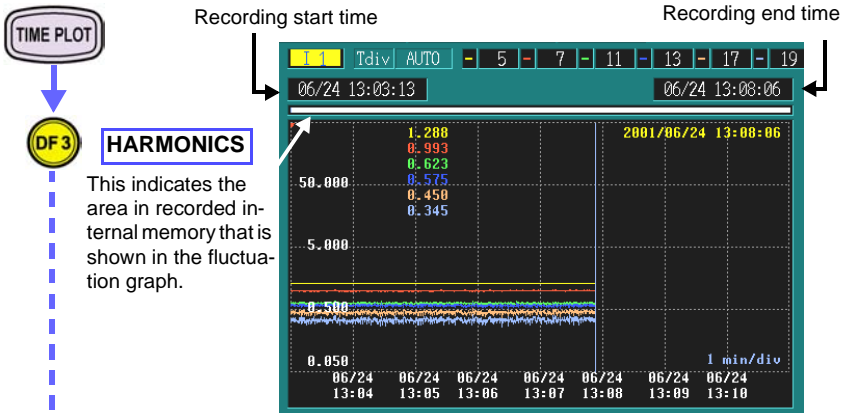

An event occurs when the total voltage distortion factor or harmonic current limit specified in the IEC Standards is exceeded.

If the ▼ mark is displayed in the time series graph, an event has occurred.

To display the fluctuation graph for harmonic current



Harmonic current: I (Select a channel from CH1, CH2, and CH3.)

Checking using the event list

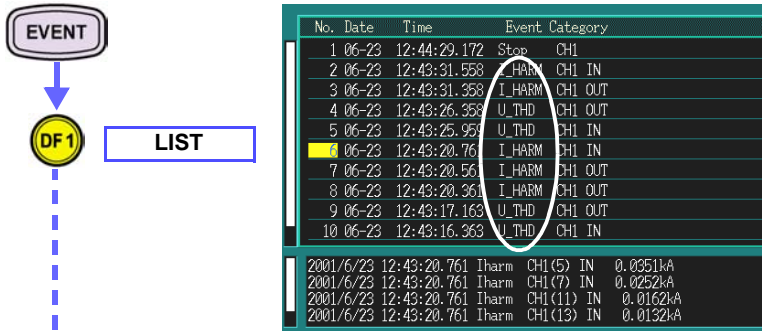

An event occurs when the total voltage distortion factor or harmonic current limit specified in the IEC Standards is exceeded. If **HARM** or **THD** is displayed in the event category area, an event has occurred.



To display waveforms for event occurrence



Select the number that you want to display from the event list.



VOLT/CURR

VIEW screen



Returns the screen to the event list.

6.4 Monitoring Interruptions

Monitoring momentary drops and interruptions in a 230 V DC factory power line over a one-month period

Measurement location Factory single-phase 2-wire 230 V power line (at 50 Hz)

- Application**
- To make connections to the power line to be monitored while viewing the connection diagram on the screen
 - To set the momentary drop threshold to 90% and the interruption threshold to 10%
 - To observe the change in MAX, MIN, and AVE values for RMS voltage over a 1-month period
 - To periodically print events (momentary drops and interruptions) from the monitor screen to the printer
 - To analyze voltage waveforms for event occurrence

NOTE

Use of a PC card enables continuous measurement for more than one month.

- ❖ "Making 3196 settings (recording settings)" (page 81)

1. Measurement preparations

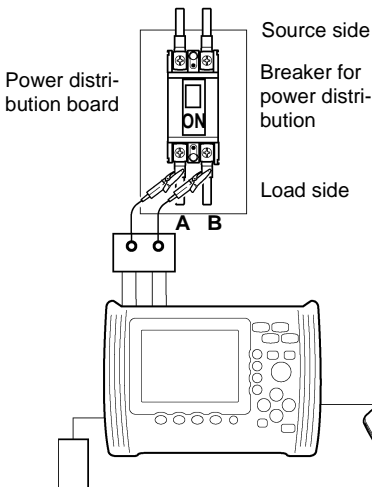

Required for measurement:

- 3196 + 9458 AC ADAPTER + 9459 BATTERY PACK
- 9438-02 VOLTAGE CORD (A single red cord and a single black cord.)
- 9670 PRINTER + 9671 AC ADAPTER
- 9638 RS-232C CABLE

2. Making 3196 settings (measurement settings)

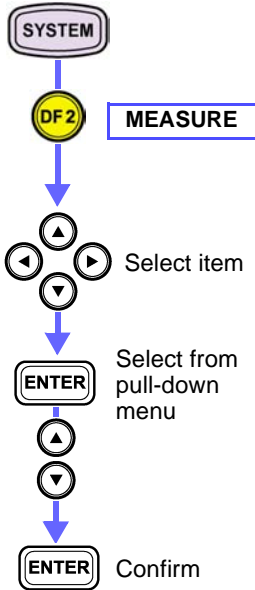

123ch	4ch	UReference	230 V
Wiring	1P2W	Frequency	50Hz
Clamp	1mV/A 9661 1mV/A 9661	PLL Source	U1
U Range	300V 300V	U CalcType	PHASE-N
PT Ratio	1 1	Harm Calc	LEVEL
I Range	50A 50A	THD Calc	THD_F
CT Ratio	1 1	PF Type	PF
		Flicker	OFF
		TimePlot U	Urms
		EN50160	OFF

Make the following settings.

Items	Settings
123ch/ Wiring	1P2W
123ch/ U Range	300 V
123ch/ PT Ratio	1
UReference	230 V
Frequency	50 Hz
PLL Source	U1
U CalcType	PHASE-N
TimePlot U	Urms
EN50160	OFF

3. Connecting to the lines to be measured



WIRING

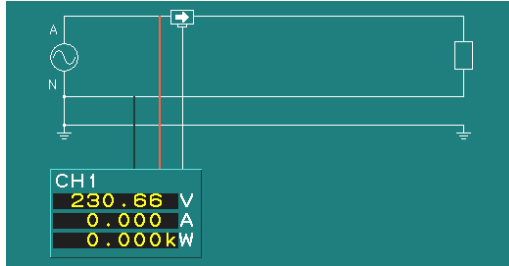

Connect the 3196 to the power line to be monitored while viewing the connection diagram.

Black voltage cord:
Power outlet N terminal
Red voltage cord:
Power outlet L terminal

L: Line, N: Neutral, E:

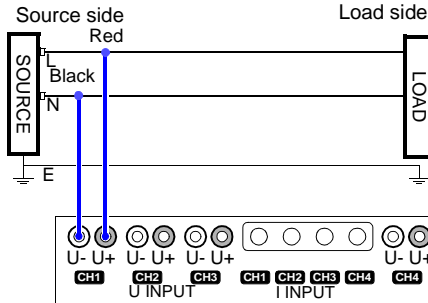

➡ Point the arrows toward the Load

1P2W

Confirm the connection on the screen.

- Is the voltage displayed for CH1 approximately 230 V?

4. Making 3196 settings (recording settings)

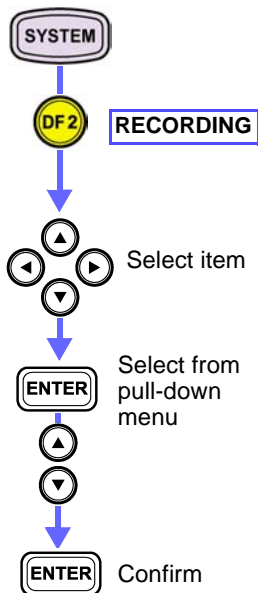

Rec. Data	Power	AVE
MemoryFull	STOP	
Interval	5 min	30 23:59:59
Auto Save	OFF	
Time Start	OFF	
RepeatSave	OFF	99 times
Start Time	2002 Y 9 M 5 D	0 h 0 m
Stop Time	2002 Y 9 M 11 D	23 h 59 m

Make the following settings.

Items	Settings
Rec. Data	Power, AVE (You can observe the MAX and MIN values on the voltage fluctuation graph even if only AVE settings are made.)
Memory Full	STOP
Interval	5 m (31 days)

The above settings indicate the maximum possible recording period.

When recording to a PC card:

Insert an ATA Flash card into the PC card slot. Recorded data is automatically saved to the internal memory at the same time.

Items	Settings
Memory Full	LOOP
Auto Save	BINARY

You can increase the maximum recording interval by using an ATA Flash card.

Example: When using a 64 MB PC card, the recording capacity is increased about 9 times. When measuring for an identical recording interval over one month, you can set the interval to 15 s.

NOTE

When recording data for more than one month: Make the same setting as described in "When recording to a PC card:" and turn on the setting for repeated recording (for which the number of repeated recording operations must be set). Data is recorded in files on a PC card, each containing the data of a one-month period. For details, See the Instruction Manual (CD-R version).

5. Making 3196 settings (hardware settings)

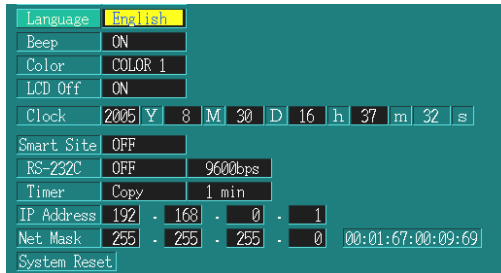
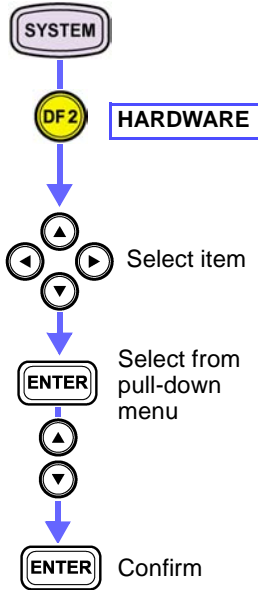

Make the following settings.

Items	Settings
RS-232C	PRINTER, 19200 bps
Timer	COPY, 2 hour

If you set the 3196 to print a hard copy to the printer every 2 hours, you can print 360 times in a single month.

If you connect the printer, the printer mark  appears in the upper left of the screen when hard copying becomes possible.

When manually printing hard copies as required:

Press .

6. Making 3196 settings (event settings)

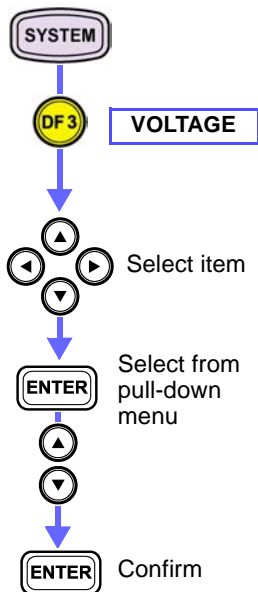

Make the following settings.

Items	Settings
Urms DIP (Voltage Dip)	90% (Voltage is 90% of nominal 230 V: 207 V)
U Interrupt (Voltage interruptions)	10% (Voltage is 10% of nominal 230 V: 23 V)

Dips and voltage interruptions are observed as RMS values.

When you want to detect partial dropouts in a waveform:

Items	Settings
U wave (Voltage waveform comparison)	(ON) Set the event level. You can detect partial waveform dropouts on the order of ms.
U Transient (Voltage Transient)	(ON) Set the event level. You can detect partial waveform dropouts on the order of μ s.

7. Changing to a screen for hard copy

Display the screen to be printed

Example: Event monitor screen

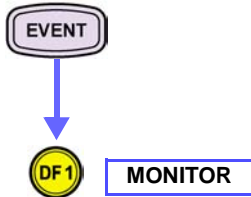

U Cycle Event						Other
Transient Swell	Dip	Interrupt	Wave			Ext
0	0	12	12	0		0
200ms Line Event						
Freq	U	I	P	PF	urb	
0	0	0	0	0	0	0
Harmonics Event						
U harm	I harm	P / θ	U THD	I THD	KF	
0	0	0	0	0	0	0

"0" is displayed when no event has occurred.

If an event occurs, the color changes to red and the count is incremented.

Starts and stops in recording are classed as events. Note that when recording starts, "Other (Ext)" changes to red and the value becomes "1."

When **TIMER** or **PRINTER** is set by **SYSTEM-DF2-HARDWARE**, a hard copy is printed to the printer at the set interval.

8. Starting the recording interval

Use the same method as when measuring power fluctuation. (page 66)

9. Viewing measurement data

(1) Checking recording conditions with the fluctuation graph

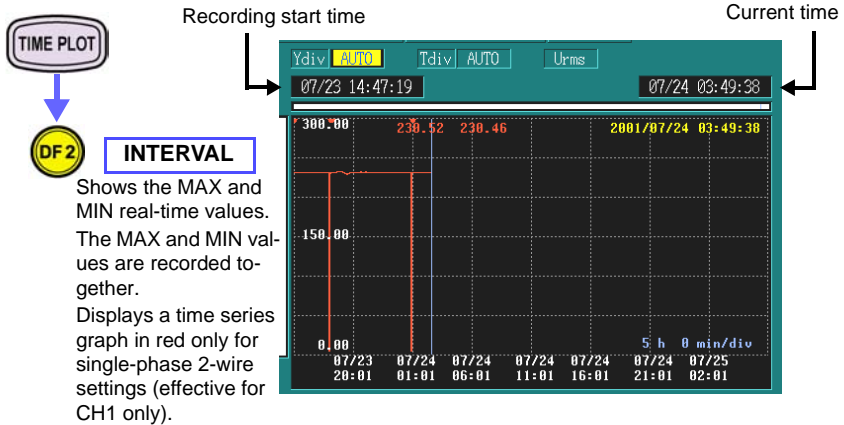

The vertical and horizontal scales of the fluctuation graph change automatically during recording.

If you want to change the vertical scale, you can do so while recording is in progress; however, you must first stop recording if you want to change the horizontal scale.

The change in voltage display settings are sampled at 256 points per cycle, and are calculated without any gaps for one wave shifted over half a wave. You can record MAX and MIN values from RMS voltage data every half wave over the set interval.

Example: When the interval is set to 1 s:

The MAX and MIN values are recorded from 100 points of half wave voltage data. (At 50 Hz.)

You can confirm the contents of settings (SYSTEM-DF2) and waveform display (VIEW-DF1/2/3/4) during recording, but you cannot change them.

When you want to change the settings, you must stop recording first.

6.4 Monitoring Interruptions

(2) View the voltage fluctuation graph for an event

When a voltage dip or voltage interruption occurs, display a graph of voltage fluctuation at the time of event occurrence.

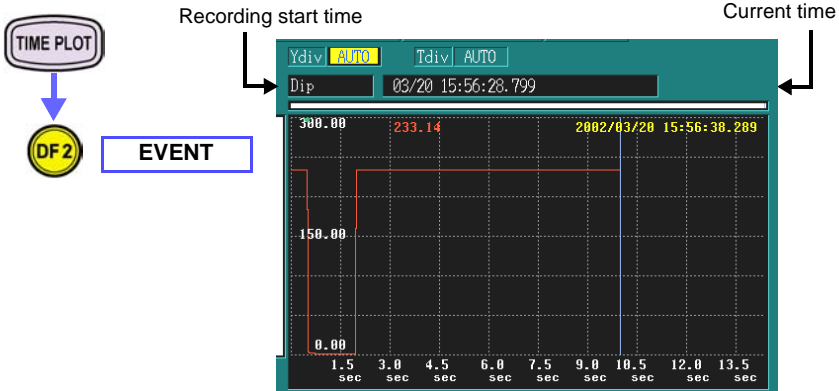

Voltage values calculated for a single waveform shifted by a half wave are displayed without alteration as a voltage fluctuation graph. With the single-phase 2-wire setting (measurement of CH1 only), only a red time series graph is displayed.

The vertical and horizontal scales of the fluctuation graph change automatically during recording. If you want to change the vertical scale, you can do so while recording is in progress; however, you must first stop recording if you want to change the horizontal scale.

The change in voltage display settings are sampled at 256 points per cycle, and are calculated without any gaps for one wave shifted over half a wave. Recording is preset for a pre-trigger of 0.5 second and a fixed recording length of 10 seconds.

Only one fluctuation graph is recorded in internal memory. You can read multiple fluctuation graphs by using a PC card. In [SYSTEM]-DF2 MAIN[RECORDING], set "Auto Save" to "BINARY".

10. Ending the recording interval

Use the same method as when measuring power fluctuation. (page 68)

11. Analyzing voltage waveforms upon event occurrence

EVENT

DF 1

LIST

Displays the waveform for the event occurrence.

No.	Date	Time	Event Category	
1	06-22	19:04:15.000	Stop	CH1
2	06-22	19:01:52.027	Inter	CH1 OUT
3	06-22	19:01:51.744	Dip	CH1 IN
4	06-22	19:01:45.300	Inter	CH1 OUT
5	06-22	19:01:45.110	Dip	CH1 IN
6	06-22	19:01:24.886	Inter	CH1 OUT
7	06-22	19:01:24.419	Dip	CH1 IN
8	06-22	19:01:02.892	Inter	CH1 OUT
9	06-22	19:01:01.010	Dip	CH1 IN
10	06-22	19:00:55.602	Inter	CH1 IN

2001/6/22	19:01:51.744	Dip	CH1 IN	90.00%
2001/6/22	19:01:51.786	Intrupt	CH1 IN	10.00%

Event occurrence display

For the start of voltage dip occurrences: DIP, CH1, IN
 For the end of voltage dip occurrences: DIP, CH1, OUT
 For the start of interruptions: Inter, CH1, IN
 For the end of interruptions: Inter, CH1, OUT



Select the number that you want to display from the event list.



ENTER

VIEW screen display upon event occurrence

- WAVE
- VECTOR
- DMM
- HARMONICS

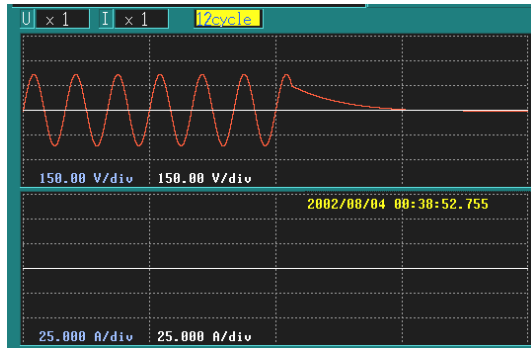

You can scroll to display the waveform at the point where the threshold was exceeded.



Methods for changing the amplitude and number of waveform cycles, measuring the cursor, and scrolling

Use the same method as with three-phase checking.

- ❖ To change the waveform's amplitude and its number of waves (page 62)
- ❖ To measure the cursor (page 62)
- ❖ To scroll the waveform (page 62)



Returning from the VIEW screen to the EVENT screen

ESC

6.5 Detecting Transients and Waveform Distortion

Detecting the intermittently occurring transients (impulse) and distortion in voltage waveforms of large electrical devices

Measurement location Power lead-in for large electrical devices that operate using a three-phase 3-wire 400 V system

- Application**
- To set the transient threshold
 - To set the waveform distortion threshold
 - To observe the change in MAX and MIN values for RMS voltage over a 1-month period
 - To confirm whether an event (transient or waveform distortion) has occurred
 - To display and analyze distorted waveforms that have been detected
 - To display and analyze transient waveforms that have been detected

1. Measurement preparations

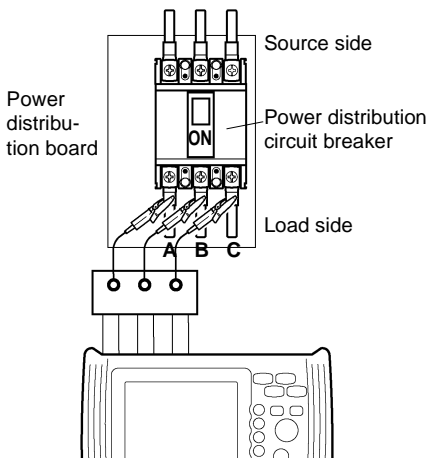

Required for measurement:

- 3196 + 9458 AC ADAPTER + 9459 BATTERY PACK
- 9438-02 VOLTAGE CORD (One each red, yellow, and blue cord, and three black cords.)

When using the three-phase connection adapter

- 9264-01 WIRING ADAPTER(3P3W3M)
- 9438-02 VOLTAGE CORD (One each red, yellow, and blue cord.)

2. Making 3196 settings

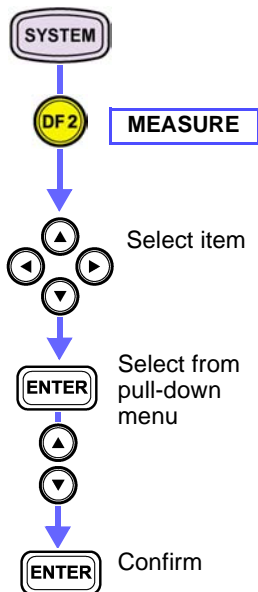

	123ch	4ch	UReference	400 V
Wiring	3P3W3M	AC	Frequency	50Hz
Clamp	1mV/A 9661	1mV/A 9661	PLL Source	U1
U Range	600V	600V	U CalcType	LINE-LINE
PT Ratio	1	1	Harm Calc	LEVEL
I Range	50A	50A	THD Calc	THD_F
CT Ratio	1	1	PF Type	PF
			Flicker	OFF
			EN50160	OFF

Make the following settings.

Items	Settings
123ch/ Wiring	3P3W3M
123ch/ U Range	600V
123ch/ PT Ratio	1
123ch/ I Range	50 A
UReference	400 V
Frequency	50 Hz
PLL Source	U1
U CalcType	LINE-LINE
TimePlot U	Urms
EN50160	OFF

3. Connecting to the lines to be measured

Use the same method as with three-phase checking. (page 59)

4. Checking the connections

Use the same method as with three-phase checking. (page 60)

5. Making 3196 settings (recording settings)

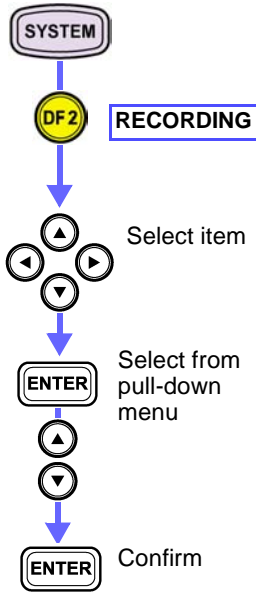

Rec. Data	Power	AVE
MemoryFull	STOP	
Interval	5 min	30 23:59:59
Auto Save	OFF	
Time Start	OFF	
RepeatSave	OFF	99 times
Start Time	2002 Y 9 M 5 D	0 h 0 m
Stop Time	2002 Y 9 M 11 D	23 h 59 m

Make the following settings.

Items	Settings
Rec. Data	Power, AVE (You can observe the MAX and MIN values on the voltage fluctuation graph when AVE is set.)
Memory Full	STOP
Interval	5 m (31 days)

Shows the maximum interval that you can record with the settings above.

When recording to a PC card:

Insert an ATA Flash card into the PC card slot. Recorded data is automatically saved to the internal memory at the same time.

Items	Settings
Memory Full	LOOP
Auto Save	BINARY

You can increase the maximum recording interval by using an ATA Flash card.

Example: When using a 64 MB PC card, the recording capacity is increased about 9 times. When measuring for an identical recording interval over one month, you can set the interval to 15 s.

6. Making 3196 settings (event settings)

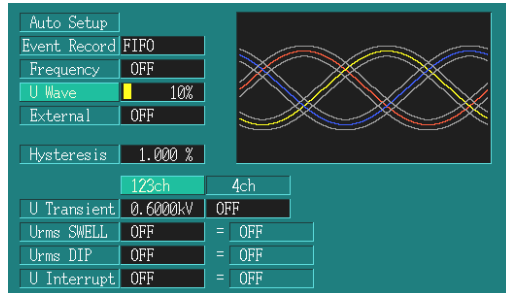
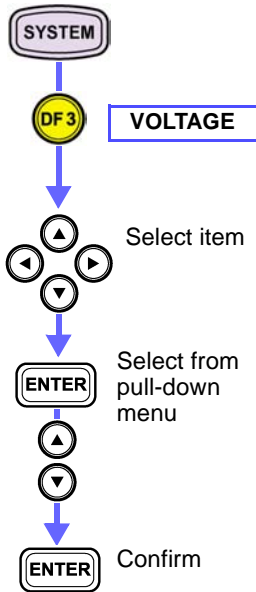

Make the following settings.

Items	Settings
U wave (Voltage waveform comparison)	10% The distortion component is detected by comparison with the immediately preceding waveform measurement, and is set as a percentage (%) of range. The upper and lower threshold levels are set.
U Transient (Voltage Transient)	0.0600 kV Specified as the noise level (in kV units) superposed on the normal voltage waveform. Upper and lower threshold levels are set. To find the superposition area, you can also detect extremely small amounts of noise included where the normal voltage waveform approaches the zero crossing.

7. Starting the recording

Use the same method as when measuring power fluctuation. (page 66)

8. Viewing measurement data

Checking recording conditions with the fluctuation graph

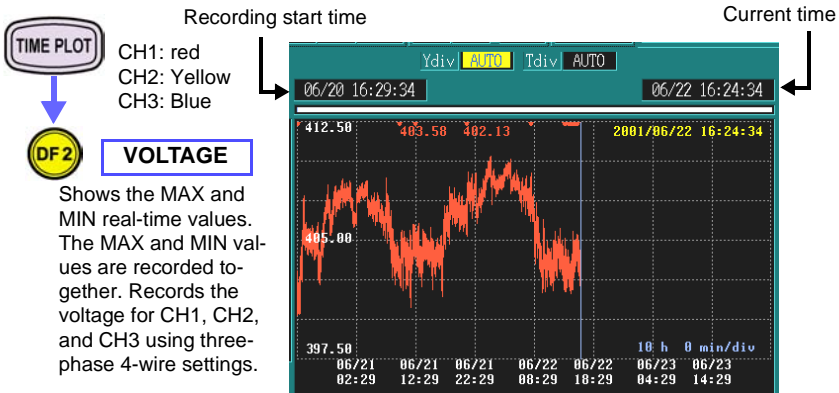

The vertical and horizontal scales of the fluctuation graph change automatically during recording.

If you want to change the vertical scale, you can do so while recording is in progress; however, you must first stop recording if you want to change the horizontal scale.

Voltage fluctuation display items are sampled at 256 points per cycle, and are calculated without any gaps for one wave shifted over half a wave. You can record MAX and MIN values calculated every 200 ms over the set interval (including RMS voltage data every half wave).

Example: When the interval is set to 1 s:

The MAX and MIN values are recorded from 100 points of half wave voltage data. (At 50 Hz.)

You can confirm the contents of settings (SYSTEM-DF2) and waveform display (VIEW-DF1/2/3/4) during recording, but you cannot change them.

When you want to change the settings, you must stop recording first.

9. To determine if an event occurs



"0" is displayed when no event has occurred.

If an event occurs, the color changes to red and the count is incremented.

Starts and stops in recording are classed as events. Note that when recording starts, "Other (Ext)" changes to red and the value becomes "1".

10. Ending the recording interval

Use the same method as when measuring power fluctuation. (page 68)

11. Analyzing waveforms in which events are detected

(1) Displays the event waveform



LIST

Displays the waveform for the event occurrence.



Select the number that you want to display from the event list.



VIEW screen display for an event occurrence Indicator

- WAVE
- VECTOR
- DMM
- HARMONICS

No.	Date	Time	Event Category		
41	06-22	14:42:36.230	Wave	CHI	
42	06-22	14:40:46.852	Wave	CHI	
43	06-22	14:37:07.243	Wave	CHI	
44	06-22	14:34:48.259	Wave	CHI	
45	06-22	14:33:30.406	Wave	CHI	
46	06-22	14:32:21.752	Wave	CHI	
47	06-22	14:24:47.067	Wave	CHI	
48	06-22	14:23:30.403	Wave	CHI	
49	06-22	14:18:55.074	Wave	CHI	
50	06-22	14:17:42.180	Wave	CHI	
2001/6/22	14:17:42.185	Tran	CHI	-0.0797kV	66.5us
2001/6/22	14:17:42.180	Wave	CHI		

Event occurrence display

For voltage waveform comparison event occurrences: Wave
(The channel that the event occurred on is displayed.)

For voltage transient event occurrences: Tran
(The channel that the event occurred on is displayed.)

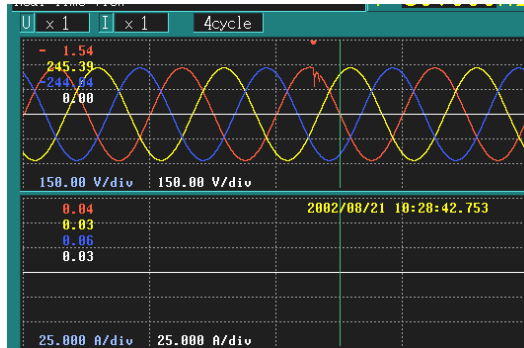

You can scroll to display the waveform at the point where the threshold was exceeded.



Methods for changing the amplitude and number of waveform cycles, measuring the cursor, and scrolling

Use the same method as with three-phase checking.

- ❖ To change the waveform's amplitude and its number of waves(page 62)
- ❖ To measure the cursor(page 62)
- ❖ To scroll the waveform(page 62)



Returning from the VIEW screen to the EVENT screen



(2) Displaying the transient waveform

↓ (VIEW voltage/current screen)

F 4 Transient waveform

You can switch to the current waveform display.

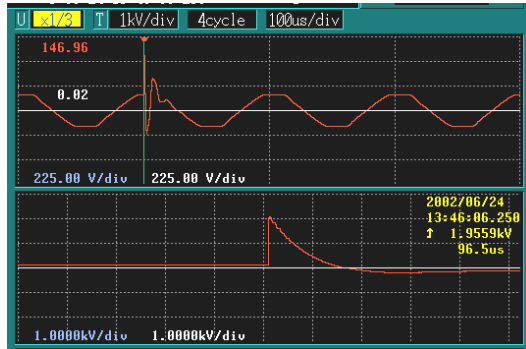

The screen is divided into two screens, and the lower one switches from current waveform display to transient waveform display. You cannot display the transient waveform display unless the voltage/current screen is displayed.



Selecting a specific transient from among multiple event categories



Selects a transient to be displayed in the voltage waveform. The ▼ mark is displayed where the transient occurred on the voltage waveform screen.



To change the transient waveform's amplitude and display interval



Changing the amplitude: x1/2, x1, x2, x4, x8, x16

Changing the display interval: 25, 50, 100, 200, 400 μs/div



Scrolling transient waveforms



Methods for changing the amplitude and number of waves for voltage waveforms, measuring the cursor, and scrolling

Use the same method as with three-phase checking.

- ❖ To change the waveform's amplitude and its number of waves (page 62)
- ❖ To measure the cursor (page 62) (Only for current waveform display.)
- ❖ To scroll the waveform (page 62) (Only for current waveform display.)



Returning from the VIEW screen to the EVENT screen



6.6 ΔV_{10} Flicker

Recording ΔV_{10} flicker in one phase of a high-voltage, three-phase system over a 5-day period

Measurement location RS interline voltage on the secondary side of a 6.6 kV three-phase (3P3W3M) high-voltage system inside a measurement cubicle: Primary side 6.6 kV, secondary side 110 V

- Application**
- To check whether ΔV_{10} flicker exceeds limits specified in the domestic guidelines
 - To check the deviation of voltage fluctuations with respect to a standard voltage

NOTE

Other measurements (such as harmonic measurements) can be performed simultaneously with ΔV_{10} flicker measurement. Here, we discuss the case in which only a voltage is connected.

1. Measurement preparations

High-voltage power distribution board

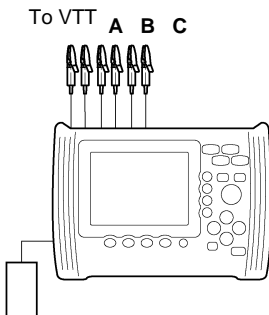
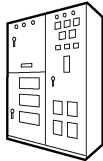

Required for measurement:

- 3196 + 9458 AC ADAPTER + 9459 BATTERY PACK
- 9438-02 VOLTAGE CORD (One each red, yellow, and blue cord, and three black cords.)

When using the three-phase connection adapter

- 9264-01 WIRING ADAPTER(3P3W3M)
- 9438-02 VOLTAGE CORD (One each red, yellow, and blue cord.)

2. Making 3196 settings (measurement settings)

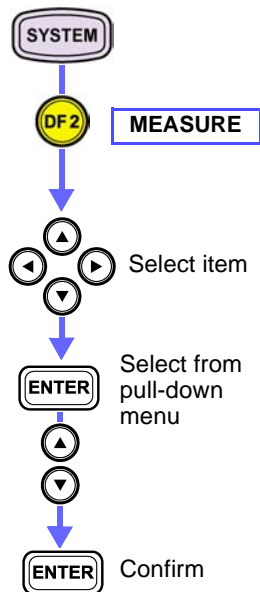

123ch	4ch	UReference	110 V
Wiring	3P3W3M	Frequency	50Hz
Clamp	1mV/A 9661	PLL Source	U1
U Range	150V	U CalcType	LINE-LINE
PT Ratio	60	Harm Calc	LEVEL
I Range	50A	THD Calc	THD_F
CT Ratio	60	PF Type	PF
		Flicker	$\Delta V10$
		TimePlot U	ΔU
		Flicker CH	U1
		EN50160	OFF

Make the following settings.

Setting Item	Selections
123ch/ Wiring	3P3W3M or 1P2W
123ch/ U Range	150V
123ch/ PT Ratio	60
UReference	110V
Frequency	50 Hz
PLL Source	U1
U CalcType	LINE-LINE (3P3W3M) or PHASE-N
Flicker	$\Delta V10$
TimePlot U	ΔU
Flicker CH	U1
EN50160	OFF

3. Connecting to the lines to be measured

Use the same method as with three-phase checking. (page 59)
With single phase 2-wire connection, connect only the CH1 voltage.

4. Checking the connections

Use the same method as with three-phase checking. (page 60)
With single phase 2-wire connection, connect only the CH1 voltage.

5. Making 3196 settings (recording settings)

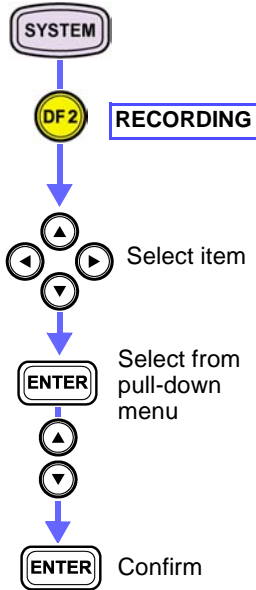

Rec. Data	Power	AVE
MemoryFull	STOP	
Interval	30 sec	06 22:10:30
Auto Save	OFF	
Time Start	OFF	
RepeatSave	OFF	99 times
Start Time	2002 Y 9 M 5 D	0 h 0 m
Stop Time	2002 Y 9 M 11 D	23 h 59 m

Make the following settings.

Items	Settings
Rec. Data	Power, AVE (You can observe the MAX and MIN values on the voltage fluctuation graph when AVE is set.)
Memory Full	STOP
Interval	30 sec (6 days 22 hours 10 minutes)

Shows the maximum interval that you can record with the settings above.

NOTE

Event detection is not possible using the $\Delta V10$ flicker value. Accordingly, event settings are not made.

6. Starting the recording

Use the same method as when measuring power fluctuation. (page 66)

NOTE

The $\Delta V10$ reference value is generated automatically using AGC (automatic gain control) generated over 1-minute with a low pass filter. BPF (bandpass filters) are used for flicker detection. Due to the effect of the HPF (highpass filter), the first and second $\Delta V10$ flicker values measured may be large if measurement is begun immediately after making settings. Therefore, after making connections and settings, we recommend waiting about 3 minutes before starting measurement.

7. Viewing measurement data

Checking recording conditions with the fluctuation graph

(1) Checking the deviation of voltage fluctuations with respect to a standard voltage

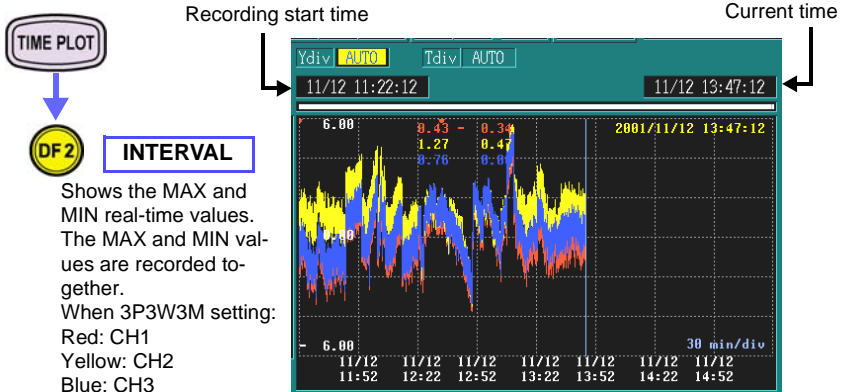

The vertical and horizontal scales of the fluctuation graph change automatically during recording.

If you want to change the vertical scale, you can do so while recording is in progress; however, you must first stop recording if you want to change the horizontal scale.

Voltage fluctuation value (ΔU) are sampled at 256 points per cycle, and are calculated without any gaps for one wave shifted over half a wave. You can record MAX and MIN values from RMS voltage data every half wave over the set interval.

Example: When the interval is set to 1 s:

The MAX and MIN values are recorded from 100 points of half wave voltage data. (At 50 Hz.)

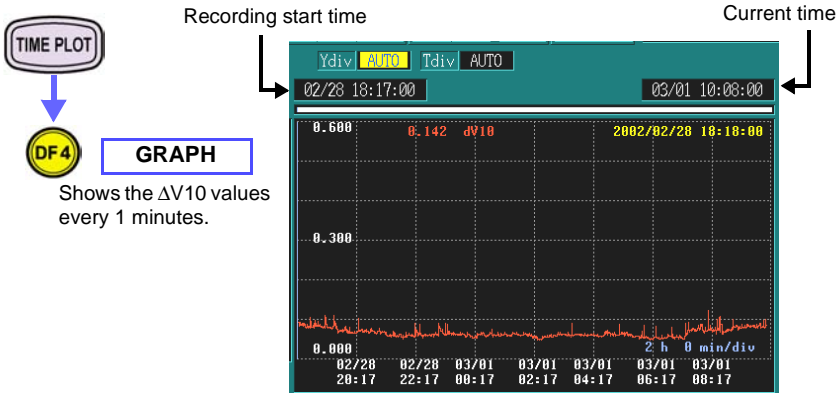
(2) To check how $\Delta V10$ flicker is varying

You can only record the channel that is selected as the flicker measurement channel.

The vertical and horizontal scales of the fluctuation graph change automatically during recording.

If you want to change the vertical scale, you can do so while recording is in progress; however, you must first stop recording if you want to change the horizontal scale.

The $\Delta V10$ flicker value is calculated once a minute without gaps, regardless of the set interval time.

You can confirm the contents of settings (SYSTEM-DF2) and waveform display (VIEW-DF1/2/3/4) during recording, but you cannot change them.

When you want to change the settings, you must stop recording first.

8. Ending the recording interval

Use the same method as when measuring power fluctuation. (page 68)

9. Checking recorded measurement data

To check whether $\Delta V10$ flicker has exceeded a threshold

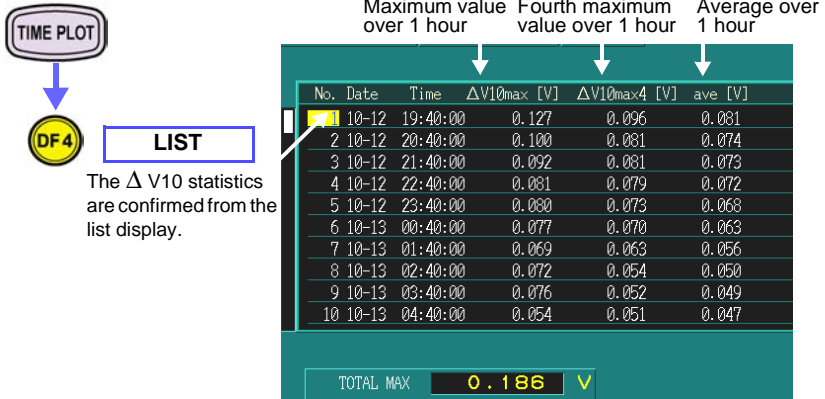

Values displayed as statistics are the average over one hour, the maximum value over one hour, the fourth maximum value over one hour, and the overall maximum (during the measurement period.)

Ordinarily, the $\Delta V10$ value must be taken as the threshold, the average prevented from exceeding 0.32, and the maximum prevented from exceeding 0.45.

The average over one hour value is used as the average.

One of the maximum value over one hour, the fourth maximum value over one hour, or the overall maximum (during the measurement period) is used for the maximum value.

6.7 IEC Flicker

Record IEC flicker for three phases on a 230V distribution board over a period of 5 days.

Measurement location 3-phase 4-wire 230 V distribution board line (50 Hz)

- Application**
- Check the degree of flicker (Pst, Plt) using the international IEC procedure.
 - Determine the degree of fluctuation in instantaneous flicker value $S(t)$, which is a measure of perceived instantaneous flickering.

NOTE

The IEC flicker function is based on international standard IEC61000-4-15, "Flickermeter - Functional and design specifications". Simultaneous measurement of IEC flicker and ΔV_{10} flicker is not possible. Select one or the other for measurement. Other measurements (such as harmonic measurements) can be performed simultaneously with IEC flicker measurement. Here, we discuss the case in which only a voltage is connected.

1. Measurement preparations

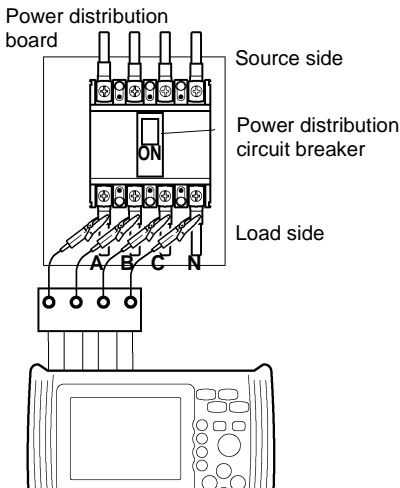

Required for measurement:

- 3196 + 9458 AC ADAPTER + 9459 BATTERY PACK
- 9438-02 VOLTAGE CORD (One each red, yellow, and blue cord, and three black cords.)

When using the three-phase connection adapter

- 9264-02 WIRING ADAPTER(3P4W)
- 9438-02 VOLTAGE CORD (One each red, yellow, blue, and black cord.)

2. Making 3196 settings (measurement settings)

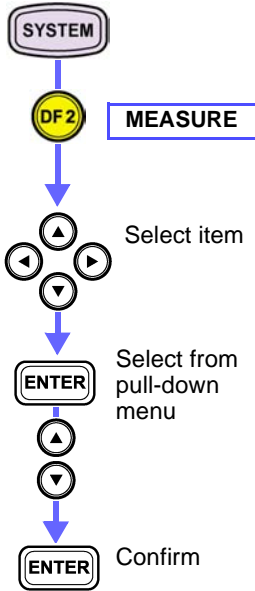

	123ch	4ch	UReference	230 V
Wiring	3P4W	AC	Frequency	50Hz
Clamp	1mV/A 9661	1mV/A 9661	PLL Source	U1
U Range	300V	300V	U CalcType	PHASE-N
PT Ratio	1	1	Harm Calc	LEVEL
I Range	50A	50A	THD Calc	THD_F
CT Ratio	1	1	PF Type	PF
			Flicker	Pst, Plt
			TimePlot U	S(t)
			Filter	230V lamp
			EN50160	OFF

Make the following settings.

Setting Item	Selections
123ch/ Wiring	3P4W
123ch/ U Range	300V
123ch/ PT Ratio	1
UReference	230V
Frequency	50 Hz
PLL Source	U1
U CalcType	PHASE-N
Flicker	Pst, Plt
TimePlot U	S(t)
Filter	230V lamp
EN50160	OFF

NOTE

Characteristics of weighting filters set forth in the IEC standards differ for 230 V lamp, 50 Hz systems and 120 V lamp, 60 Hz systems. Select the filter that matches the voltage of the point being measured.

3. Connecting to the lines to be measured

Use the same method as with three-phase checking. (page 59)
For three phase 4-wire connection; (page 49)

4. Checking the connections

Use the same method as with three-phase checking. (page 60)
For three phase 4-wire connection check, (page 49)

5. Making 3196 settings (recording settings)

Use the same method as ΔV_{10} Flicker (page 98)

NOTE

Event detection is not possible using the Pst, Plt, S(t) value. Accordingly, event settings are not made.

6. Starting the recording

Use the same method as when measuring power fluctuation. (page 66)

NOTE

The IEC reference value is generated automatically using AGC (automatic gain control) generated over 1-minute with a low pass filter.

7. Viewing measurement data

Checking recording conditions with the fluctuation graph

- (1) Investigate the degree of fluctuation in instantaneous flicker value $S(t)$, which is a measure of perceived instantaneous flicker.

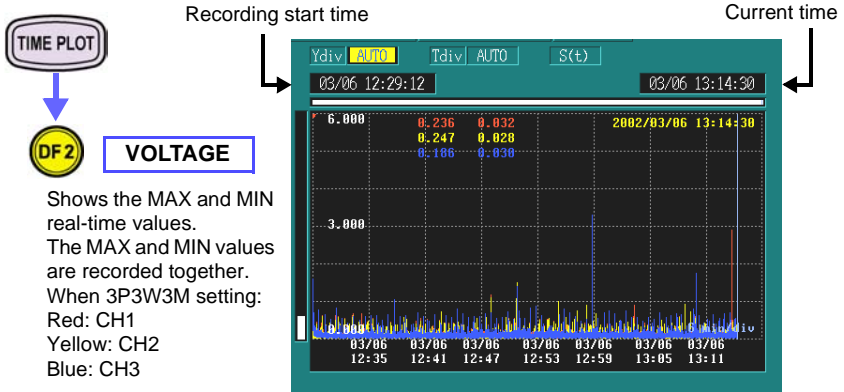

The vertical and horizontal scales of the fluctuation graph change automatically during recording.

If you want to change the vertical scale, you can do so while recording is in progress; however, you must first stop recording if you want to change the horizontal scale.

Instantaneous flicker values ($S(t)$) are sampled at 256 points per cycle, and are calculated without any gaps for one wave shifted over half a wave. You can record MAX and MIN values from RMS voltage data every half wave over the set interval.

Example: When the interval is set to 1 s:

The MAX and MIN values are recorded from 100 points of half wave voltage data. (At 50 Hz.)

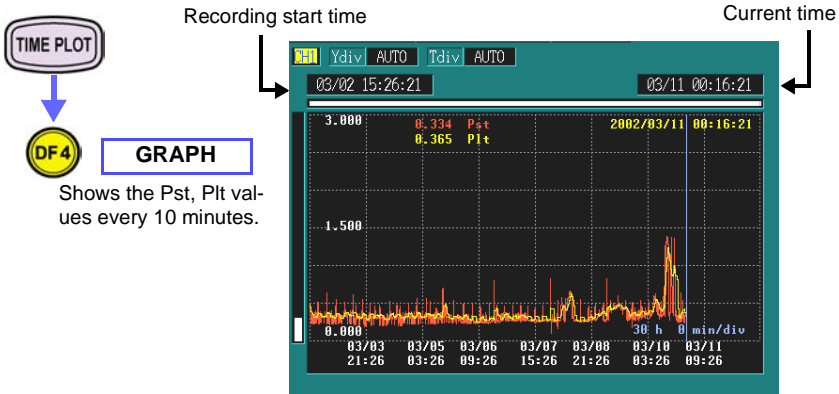
(2) Check the occurrence of IEC flicker (Pst, Plt).

Shows the Pst, Plt values every 10 minutes.

The vertical and horizontal scales of the fluctuation graph change automatically during recording.

If you want to change the vertical scale, you can do so while recording is in progress; however, you must first stop recording if you want to change the horizontal scale.

The short-term flicker indicator “Pst” indicates the degree of perceptibility (severity) of flicker measured over a 10-minute period.

The long-term flicker indicator “Plt” indicates the degree of perceptibility (severity) of flicker determined from successive Pst measurements over a 2-hour period.

Plt is calculated from moving averages of Pst.

The Pst, Plt flicker value is calculated once a minute without gaps, regardless of the set interval time.

You can confirm the contents of settings (SYSTEM-DF2) and waveform display (VIEW-DF1/2/3/4) during recording, but you cannot change them.

When you want to change the settings, you must stop recording first.

8. Ending the recording interval

Use the same method as when measuring power fluctuation. (page 68)

9. Checking recorded measurement data

Determine the maximum value of Pst and Plt during the measurement period.

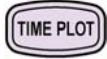

LIST

The Pst, Plt statistics are confirmed from the list display.

No.	Date	Time	P s t	P l t
1196	03-10	22:46:21	0 . 238	0 . 411
1197	03-10	22:56:21	0 . 302	0 . 409
1198	03-10	23:06:21	0 . 337	0 . 413
1199	03-10	23:16:21	0 . 229	0 . 410
1200	03-10	23:26:21	0 . 304	0 . 369
1201	03-10	23:36:21	0 . 331	0 . 369
1202	03-10	23:46:21	0 . 318	0 . 365
1203	03-10	23:56:21	0 . 356	0 . 370
1204	03-11	00:06:21	0 . 620	0 . 386
1205	03-11	00:16:21	0 . 334	0 . 365

Statistics on Pst and Plt are displayed every 10 minutes, along with the date and time.

- Pst: short interval flicker value
- Plt: long interval flicker value
- EN50160, "Voltage characteristics of electricity supplied by public distribution systems", specifies "In any period of one week the long term flicker severity caused by voltage fluctuation should be $Plt \leq 1$ for 95% of the time."



Peripheral Devices

7

7.1 Using a PC Card

Card type: Flash ATA Types I and II
Slot: One Type II
Format: MS-DOS
Storage capacity: Up to 528 MB

The PC Card interface of this instrument complies with PCMCIA (Personal Computer Memory Card International Association) and JEIDA (Japan Electric Industry Development Association) PC Card standards.

●: Possible/ ×: Not Possible

File and File Format			Directory Name	File Name	SYSTEM_DF4 [PC-CARD]		Files can be opened on a PC	Using with the 9624/9624-10	
					SAVE	LOAD			
Setting Files				#####.SET	●	●	●	×	
			B+Date+No.*8	3196SET.SET	●	●	×	●	
Measurement Data Files	Binary format	Time-series data*4		96INTVL.ITV	●	●	×	●	
		Event data*1, *3		96EVT000.EVT to 96EVT999.EVT	●	●	×	●	
		Transient waveform data *1		00000000.TRN to 99999999.TRN	●	●	×	●	
		ΔV10/ IEC Flicker data *1		96FLICK.FLC	●	●	×	●	
		Voltage fluctuation event data *3,*7		96DV000.WDU to 96DV999.WDU	●	●	×	●	
		Text format	Time-series data*1	T+Date+No.*8	96INTVL.CSV	●	×	●	×
	Event list data *1, *5			96EVENT.TXT	●	×	●	×	
	ΔV10/ IEC Flicker data*1			96FLICK.TXT	●	×	●	×	
	Voltage fluctuation event data *3,*7			HHMM000.CSV to HHMM999.CSV	●	×	●	×	
	Event waveform data *2, *6		TEXTWAVE	HHMM000.CSV to HHMM999.CSV *9	●*10	×	●	×	
Screen Hard Copy Files				H3196000.BMP to H3196999.BMP	●	×	●	×	

Storage method

*1: Files can be saved automatically every interval, or saved manually after measurement is finished (when analyzing).

*2: After measurement is finished (when analyzing), you can select an event number and save files manually.

*3: Data is saved automatically each time an event occurs.

Creating event files

*4: A file is created for each event (event data for all of the contents, including waveforms).

*5: All of the events in the list are created within a single file.

*6: A file is created for each event waveform.

*7: A file is created for each voltage fluctuation event graph.

Creating a directory and file name

*8: A number is appended to files each time measurement data is saved.

Binary format: B/ Text format: T(1-digit)+Date(5-digit: year,month,day) + Number(2-digit:01 to 99)

The year is indicated using the lowest digit. (Example: The year 2002 is represented as "2".)

3196SET.SET is also saved in the text format directory.

*9: HH indicates hours, and MM indicates minutes.

*10: EVENT_DF1[LIST] is used to save event waveform data in text format.

**WARNING**

Use only PC Cards sold by Hioki.
Compatibility and performance are not guaranteed for PC cards made by other manufacturers. You may be unable to read from or save data to such cards.

**CAUTION**

- Make sure that you format your PC card before using it. (Format the PC card using this device or the PC.)
- Do not use the device where oil permeates the air or in dusty places. Doing so can cause the deterioration of connector contacts.
- When formatting a PC card on a PC, use the FAT-16 format. Formatting a card in FAT-32 format may result in incompatibility problems.
- PC Cards should always be formatted before use (format the Card within the instrument.)
- Some PC Cards may not be usable.
- Do not handle Cards in dusty environments, or where caustic vapors may be present. The connector contacts can be fouled in such conditions.
- The PC Card or the instrument can be damaged if the card is inserted forcefully in the wrong direction.
- Keep the cover closed when a PC Card is not installed.
- Never eject a PC Card while it is being accessed by the instrument. Data on the PC Card may be lost.
- When the instrument is to be transported, remove the PC Card and close the cover.

PC Card Capacity

The instrument contains 13 MB of internal memory. So 13 MB is required on a PC Card to store all of the contents recorded in internal memory. Therefore, PC Cards used with the instrument should have at least 13 MB capacity.
The 1 GB Model 9729 PC CARD is not supported.

Hioki Options

- PC cards (includes adapter)
- 9726 PC CARD 128M
 - 9727 PC CARD 256M
 - 9728 PC CARD 512M

For more details about PC Cards, See the Instruction Manual (CD-R version).

Inserting and Removing a PC Card

Inserting a PC Card

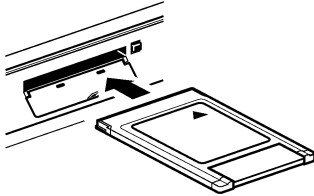

Open the cover and insert the PC Card with the arrow facing up and in the direction of the PC card slot, as far as it will go.

Removing a PC Card

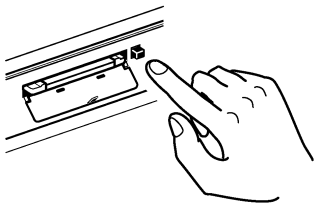

Press the Eject button and pull the PC Card out.

Initializing a PC Card

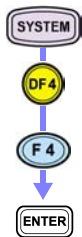

PC-CARD

FORMAT

"Now Formatting!" is displayed during formatting.
When this message disappears, formatting is finished.

NOTE

Bear in mind that formatting permanently erases all files on a PC Card.

Loading Files from a PC Card to the 3196

PC-CARD



1

(Example)
Select the No. to load

LOAD

No.	File Name	Size	Date
1	E1110901 <DIR>		01-11-09 12:04
2	T1110902 <DIR>		01-11-09 12:04
3	H3196006 BMP	41742	01-11-09 12:03
4	TBST SET	3904	01-11-09 12:03
5	TEXTWAVE <DIR>		01-11-09 12:03

Loading a settings file: select a file with .SET extension

Loading a measurement data file:

Select the binary format directory <DIR> (that for files whose names begin with "B").

NOTE

- Text, BMP and file formats not supported by this instrument cannot be loaded.
- When saving in binary format, saving can take up to 5 minutes.
- Files in binary format of up to 13 MB (including up to 5 MB of time-series data and up to 100 event data sets) can be loaded into the 3196. We recommend the use of the 9624 PQA-HiVIEW or 9624-10 PQA-HiVIEW PRO to analyze binary format files.

Saving a Settings File to a PC Card

(from [SETTING]/[ANALYZING] modes)

PC-CARD

SAVE

SETUP FILE



File Name Entry

SAVE

Only from [ANALYZING] mode
(no need to select from [SETTING] mode)

The .SET file name extension is appended automatically

Date and time information are recorded automatically.

Automatically Saving Measurement Data to a PC Card

SYSTEM

DF 2

RECORDING



Select item

ENTER

Select from pull-down menu



ENTER

F 1

Select

F 1

OFF (Deselect)

F 2

ON (Select)

F 4

RETURN

Data saved to internal memory is automatically saved to a PC Card simultaneously.

Setting Item	Selections
MemoryFull	Continue/Stop
Interval	(select from menu)
Auto Save	BINARY (save in binary format) TEXT (save in text format)*1

Select other settings as needed

When the **[RECORDING]** internal operating status is enabled, the screen image is copied automatically.

*1: When saving as text

Select the items to be saved

The currently selected items are indicated by number at the right side of the Auto Save display.

NOTE

- In binary format, all measurement data of the 3196 can be saved to a PC card.
- When data is automatically saved in text format, only time series data and event list data can be saved.

Storing data on a PC card after measurement (during [ANALYZING])

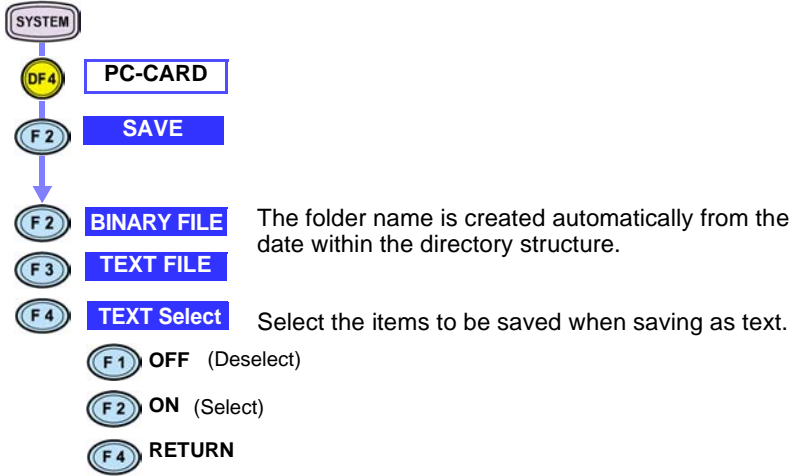

NOTE

- When saving in binary format, saving can take up to 4 minutes, 30 seconds.
- When data is saved in text format from the SYSTEM screen, only time series data and event list data can be saved.

Storing Event waveform data as text on a PC card after measurement (during [ANALYZING])

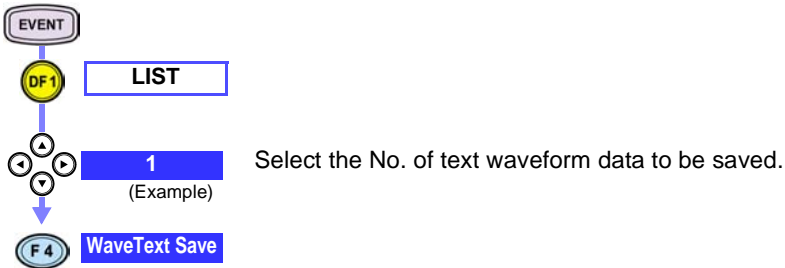

NOTE

Select the number (No.) of the event to be saved. The channel whose waveform is saved depends on the connection settings.

Deleting a PC Card File

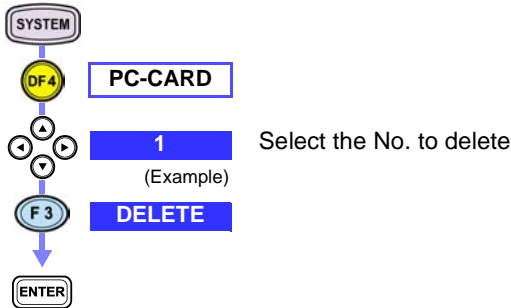

Automatically Copying a Screen Image to PC Card (Auto Copy)

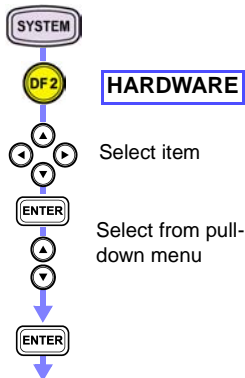

A bitmap image (BMP data) is automatically saved to the PC Card.

Setting Item	Selections
RS-232C	OFF/MODEM
Timer (interval setting)	COPY (select from menu)

Select other settings as needed

Display the screen to be printed

When the **[RECORDING]** internal operating status is enabled, the screen image is copied automatically.

Manually Copying a Screen Image to PC Card (Manual Copy)

Display the screen to be printed



Manually copy a bitmap image of the screen (BMP data) to a PC Card.
RS-232 connection setting is the same as for Auto Copy.

Press to copy an image of the displayed screen.

7.2 Using a Printer (Option)

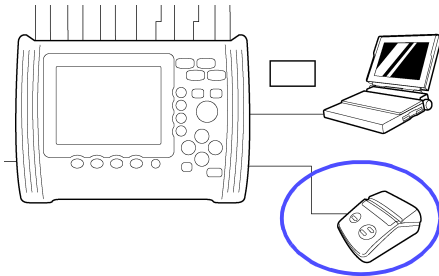

The instrument can produce hard copies of the screen on the Model 9670 PRINTER connected to the RS-232C interface.

9670 PRINTER (option)

The following items are required to use the 9670 PRINTER.

- 9670 PRINTER (BL-80RS II, made by SANEI ELECTRIC INC.) (with 1 roll of thermally sensitized paper supplied)
- 9671 AC ADAPTER (BL-100W, made by SANEI ELECTRIC INC.)
- 9237 RECORDING PAPER (thermally sensitized paper 80 x 25 m, 4 rolls)
- 9638 RS-232C CABLE

NOTE

- The 9670 PRINTER is automatically initialized by the instrument when connected.
- Note that printers other than the 9670 PRINTER will not work with this instrument, even if they are thermal printers with an RS-232C interface.
- Read the operating manuals supplied with the printer for the operating procedures.

CAUTION

- To avoid damaging the instrument and printer, do not connect and disconnect the connectors when the power is on.
- If using a cable other than the 9638 RS-232C CABLE, the connector at the instrument end should be a molded type. The metal type (with hooks on the connector preventing the surface from being flat) will not fit due to the instrument's design.
- As much as possible, avoid printing in hot and humid environments. Otherwise, printer life may be severely shortened.

Connecting the 9670 PRINTER to the 3196

Required for connection:
9638 RS-232C CABLE

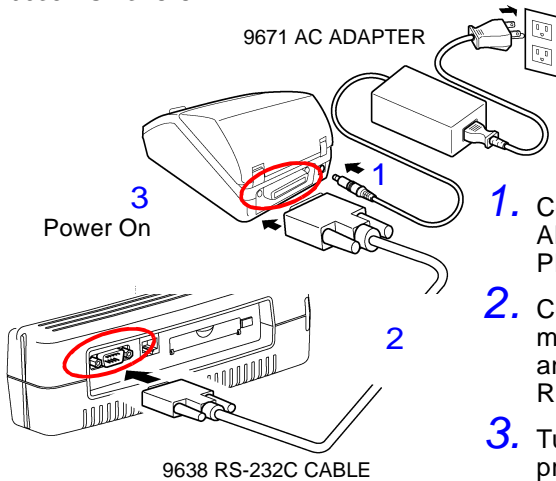

1. Connect the 9671 AC ADAPTER to the 9670 PRINTER.
2. Connect the RS-232C terminals of the instrument and printer using the 9638 RS-232C CABLE.
3. Turn the instrument and printer on.

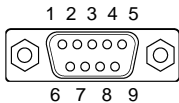

Connector pin assignments on the 3196 (9-pin)

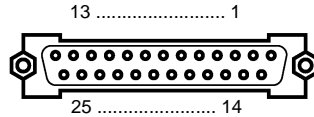

Connector pin assignments on the 9670 (25-pin)

Functions	Signal Name	Pin
Receive Data	RxD	2
Send Data	TxD	3
Signal Ground	GND	5
Request to Send	RTS	7
Clear to Send	CTS	8

Pin	Signal Name	Functions
2	TxD	Send Data
3	RxD	Receive Data
7	GND	Signal Ground
4	RTS	Request to Send
5	CTS	Clear to Send

7.2 Using a Printer (Option)

Loading Recording Paper

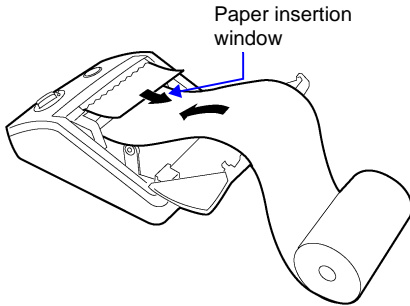

Load the recording paper into the 9670 PRINTER.

Observe paper direction!

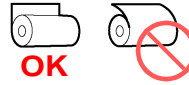

Cut the paper horizontally.



Handling and Storing Recording Paper

The recording paper is thermally and chemically sensitized. Observe the following precautions to avoid paper changing color or fading.

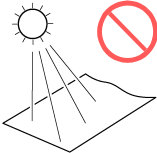

Avoid exposure to direct sunlight



Avoid exposure to volatile organic solvents like alcohol, ethers and ketones

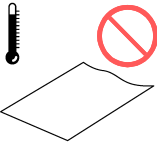

Avoid 40°C, 90%RH



Avoid contact with adhesive tapes like soft vinyl chloride and masking tape.

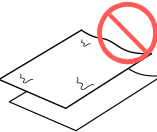

Avoid stacking with wet Diazo copy paper.

NOTE

- The internal settings for the 9670 PRINTER to be used with this instrument are as follows.

BL-80RS II/RSII [VX.XX] XXXX/XX/XX
SANEI ELECTRIC INC.

Data input = Serial
International char = Japan
Print mode = Graphic
Character set = 24Dot ANK Gothic type
Select switch = Available (ON)
Baud rate = 19200bps
Bit length = 8 bit
Parity= Non
Data control = SBUSY
Paper selection = Normal paper
Upright/inverted = Upright printing
Auto Power Off = Invalidity (OFF)
Battery mode= Invalidity (OFF)
Interface = RS232C
shr=0119 temp=026 shvp=718

- As shipped from the factory, the following settings are selected: Japanese (Language), 9600bps(baud rate) and Auto Power Off (90 minutes).
- The baud rate, language and auto power off selections are automatically set by this instrument. Perform Auto printer setting.
- Be aware that changing any other settings may disable hard copy operation.

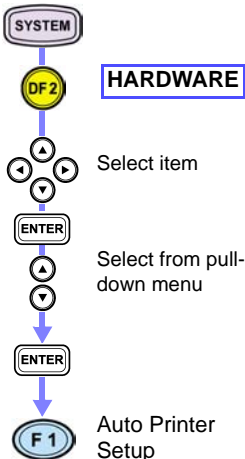
Printer Setup

The 9670 PRINTER is automatically set up for use by the instrument.

Setting Item	Selections
RS-232C (baud rate setting)	PRINTER 9600bps (slow printing) 19200bps (medium speed printing) 9600bps (fast printing) All of these are available

After Auto Printer Setup, turn the printer OFF and back on again.

Automatic Screen Hard Copy



DF 2

HARDWARE



Select item



Select from pull-down menu



Display the screen to be printed

A screen image is printed automatically at every preset interval.

Setting Item	Selections
Timer (interval setting)	COPY (select from menu)

Select other settings as needed

When the **[RECORDING]** internal operating status is enabled, printing occurs automatically.

Manual Hard Copy

Display the screen to be printed



Manually prints a copy of the screen.

Press to print a copy of the displayed screen.

7.3 Using the Instrument with a Computer

This instrument comes equipped with RS-232C and LAN interfaces.

This chapter describes use of the instrument with a personal computer (PC) or modem.

The instrument can be connected by RS-232C cable to a modem for remote control and monitoring from a modem-equipped PC at another location. (A cellular telephone can also be used.)

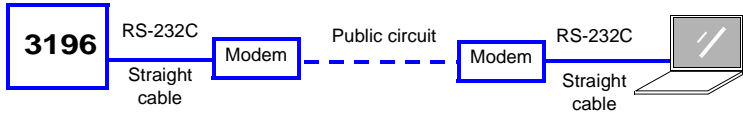

The instrument can be connected by LAN cable to a hub for remote control and monitoring from a PC at another location.

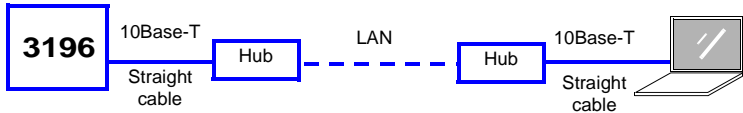

The instrument can be connected by LAN cable to a PC, for control and monitoring on the PC.

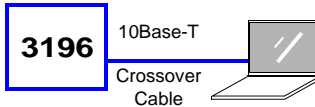

The HTTP Server function^{*1} within the instrument can be used with any of these connection methods. For details, See the Instruction Manual (CD-R version).

*1: The HTTP Server function provides setting, data acquisition and screen display using a common Web browser like Internet Explorer, without requiring special application software on the PC.

NOTE

- Both the RS-232C and LAN interfaces use the TCP/IP protocol. The TCP/IP connection over the RS-232C interface requires PPP (point-to-point protocol). Note that on the PC, Visual Basic cannot be used for programming, sending commands to or receiving data from the instrument.
- The instrument is not able to send data to a PC when connected through a modem. Some PCs produce unacceptable levels of noise. To minimize noise interference, we recommend using PCs with a built-in LAN (RJ-45) connector.

7.3.1 RS-232C Connection

!WARNING

- To avoid electric shock, always remove the power cord from the instrument and disconnect any test leads before connecting the RS-232C cable to the instrument.
- The instrument and modem should be turned off before connecting them.
- Do not connect or disconnect the cable with power on. Otherwise, the devices could be damaged.

!CAUTION

- Always tighten the screws when connecting the RS-232C cable.
- The instrument end of the connector should be a molded type plug. The metal type (with protrusions on the connector preventing the surface from being flat) will not fit due to the instrument's design.

Connecting a Modem to the Instrument

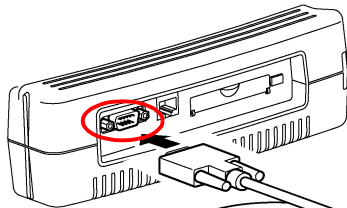

RS-232C cable
(Straight-through
cable)

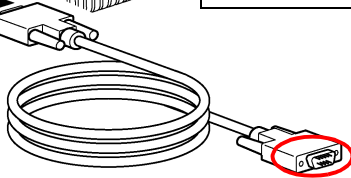

The RS-232C cable must have straight-through connections. Use a straight-through cable with a connector that mates with the modem connector. If the modem connector is a 9-pin D-sub type, the 9444 CONNECTION CABLE (option) can be used.

1. Turn the instrument and modem off.
2. Connect the RS-232C connectors on the instrument and modem together with a straight-through cable.

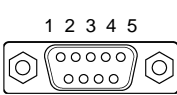

Connector pin
assignments on
the 3196 (9-pin)

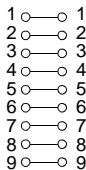

9444 CONNECTION CABLE
male side pinout (9-pin)

Pin	Functions	CCITT	EIA	JIS	Signal Name
		Circuit No.	Code Addr.	Code Addr.	
2	Receive Data	104	BB	RD	RxD
3	Send Data	103	BA	SD	TxD
5	Signal Ground	102	AB	SG	GND
7	Request to Send	105	CA	RS	RTS
8	Clear to Send	106	CB	CS	CTS

7.3.2 LAN Connection



WARNING

- To avoid electric shock, always remove the power cord from the instrument and disconnect any test leads before connecting the LAN cable to the instrument.
- The instrument and hub or PC should be turned off before connecting them.
- Do not connect or disconnect the cable with power on. Otherwise, the devices could be damaged.

Connecting a Hub to the Instrument

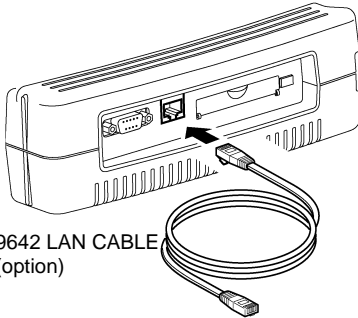

9642 LAN CABLE
(option)

Connect the instrument to the hub with the 9642 LAN CABLE (option).

1. Turn the instrument and hub off.
2. Connect the 10Base-T connectors on the instrument and the hub with a LAN cable (straight-through).

Connecting a PC to the Instrument

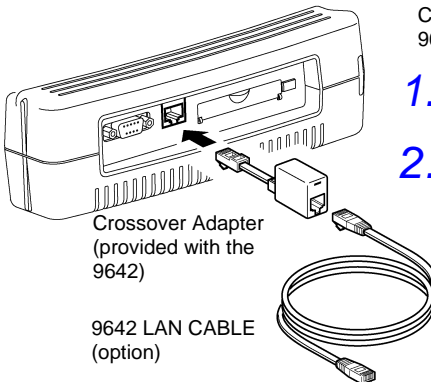

Crossover Adapter
(provided with the
9642)

9642 LAN CABLE
(option)

Connect the instrument to the PC with the 9642 LAN CABLE (option).

1. Turn the instrument and PC off.
2. Connect the 10Base-T connectors on the instrument and the PC with the 9642 LAN CABLE and supplied crossover adapter.

For details about this instrument's settings, See the Instruction Manual (CD-R version).

7.4 Using the External Control Terminals

The external control terminals can be used to signal the instrument of the occurrence of an event with an external input trigger signal, or to signal the detection of an event by the instrument with an output signal.

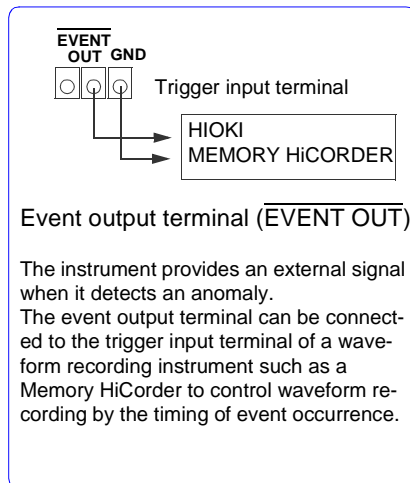
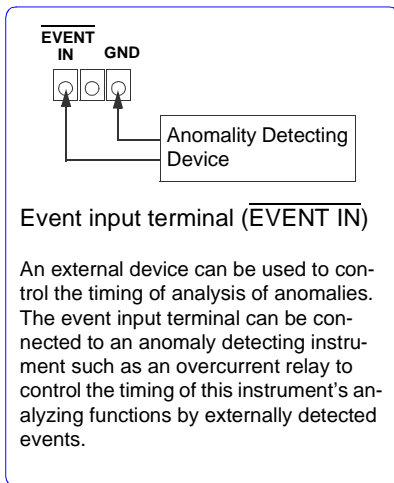
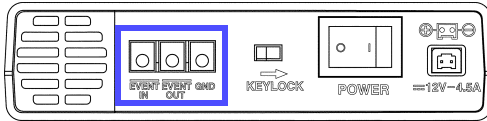

CAUTION

To avoid damage to the instrument, do not apply voltage outside the range of -5 V to +10 V (EVENT IN terminal), or 0 to +50 V (EVENT OUT terminal).

NOTE

External event inputs are recorded as EXT events. During a measurement startup, measurement stop, and manual event, signals are also recorded as EXT events. Pressing the [ESC] and [EVENT] keys simultaneously generates a manual event.

For more details, See the Instruction Manual (CD-R version).

Specifications

8

These specifications apply to the 3196 Power Quality Analyzer

Environmental & Safety Specifications

Operating environment	Indoors, altitude up to 2000 m (6562-ft.)
Storage temperature and humidity	-20°C to 50°C (-4°F to 122°F), 80% RH or less (non-condensating)
Operating temperature and humidity	0°C to 40°C (32°F to 104°F), 80% RH or less (non-condensating) (Battery pack and PC Card operation is not supported between -10°C and 0°C (14°F to 32°F), and LCD operation and accuracy are not guaranteed in this range)
Maximum input voltage (50/ 60 Hz)	Voltage inputs: 780 Vrms, 1103 V peak Current inputs: 1.7 Vrms, 2.4 V peak
Maximum rated voltage to earth	Voltage input terminals: 600 Vrms (50/60 Hz)
Dielectric strength (50/60 Hz for 1 min.)	5.55 kVrms for one minute (current sensitivity 1 mA) Between voltage and clamp input terminals, between voltage input terminals and instrument case, between voltage input terminals U1 to U3 and U4
Enclosure protection	IP30 (per EN60529)
Applicable Standards	<p>Safety EN61010-1:2001 Voltage Input: Pollution Degree 2, Measurement Category III (anticipated transient over-voltage 6000V)</p> <p>EMC EN61326:1997+A1:1998+A2:2001 Class A EN61000-3-2:2000 EN61000-3-3:1995+A1:2001</p>

Input Specifications

Measurement line type	One single-phase 2-wire (1P2W), single-phase 3-wire (1P3W), three-phase 3-wire (3P3W2M,3P3W3M) or three-phase 4-wire (3P4W) plus one extra input channel
Input channels	Voltage: Four channels U1 to U4 (extra channel U4 can measure AC or DC) Current: Four channels I1 to I4
Input methods	Voltage: Isolated inputs and differential operation Between U1, U2 and U3: these channels are not isolated from one another Between U1 to U3 and U4: channel U4 is isolated Current: input is isolated by the clamp-on sensor (voltage input)
Input resistance (50/60 Hz)	Voltage: $4\text{ M}\Omega \pm 10\%$ (differential input) Current: $200\text{ k}\Omega \pm 10\%$
Measurement method	Simultaneous digital sampling of voltage and current PLL synchronization (during instantaneous low period of PLL synchronization source, switches to a fixed clock, with no sampling gap during switching)
PLL synch channel source	One of voltages U1, U2 or U3
PLL synch frequency range	42.5 to 69 Hz
Sampling frequency	For calculations (including DC measurements): 256 per cycle (50, 60 Hz) 256 per 8 cycles (400 Hz) For harmonic and inter-harmonic analysis: 2048 per 10 cycles (50 Hz) 2048 per 12 cycles (60 Hz) 2048 per 80 cycles (400 Hz, high frequency only) For transient overvoltage (impulse): 2 MHz
A/D converter resolution	For calculations (including DC measurements): 16 bits For transient overvoltage (impulse): 12 bits
Compatible clamp sensors	0.5 Vrms output or more for full-scale current (0.5 Vrms recommended) Output-to-input ratios of 0.1, 1, 10 or 100 mV/A

Basic Specifications

Backup lithium battery life	Lithium battery to back up clock and settings, approx. 10 years (reference at 23°C, 73°F)
Clock functions	Auto calendar, auto leap year, 24-hour clock
Real-time clock accuracy	±0.3 s/day or better (instrument on), ±3 s/day or better (instrument off)
Internal memory data capacity	13 MB
Maximum recording period	1 month (when using internal memory)
Maximum recordable events	100 events (when using internal memory) (1000 events when using the PC card)
External Control terminals	External event input and output
Power supply	<ul style="list-style-type: none"> 9458 AC ADAPTER (SINO-AMERICAN SA 60-12V) (12 VDC ±5%, 4.5A) Rated voltage: 100 to 240 VAC (a change in voltage of ±10% taken into consideration), 50/60 Hz, maximum rated current: 1.2 A 9459 BATTERY PACK (Sanyo 6HR-AU Ni-MH) for backup during power off
Maximum rated power	40 VA
Continuous battery operation time	Approx. 30 minutes with the 9459 BATTERY PACK (fully charged, 23°C, 73°F)
Dimensions	Approx. 298W x 215H x 67D mm (not including protrusions) (11.73"W x 8.46"H x 2.64"D)
Mass	Approx. 2.0 kg (70.5 oz) (without the battery pack), (mass of battery pack: approx. 250 g (8.8 oz))
Power quality conforming standard	IEEE1159, EN50160:1999, IEC61000-4-30:2003

Display Specifications

Display language	English, German, French, Italian, Spanish, Chinese (Simplified), Japanese
Display device	6.4-inch TFT color LCD (640 x 480 dots)
Dot pitch	0.202(V) x 0.202(H) mm (0.01"V x 0.01"H)

External Interface Specifications

PC Card Interface

Slot	TYPE II conforming to the PCMCIA/JEIDA PC Card Standard x 1 base
Supported cards	Flash ATA cards (at least 13 MB)
Supported storage capacity	528 MB
Data format	MS-DOS
Recording contents	Binary, text and screen image data

RS-232C Interface

Compliant standards	RS-232C EIA RS-232C, CCITT V.24, JIS X5101
Connector	One 9-pin D-sub
Connection devices	Printer or modem

LAN Interface

Connector	One 10Base-T RJ-45 receptacle
Communication protocols	Ethernet, TCP/IP

Conditions of Guaranteed Accuracy

Conditions of guaranteed accuracy	After 30 min warm-up, when measuring AC voltage; sine-wave input, PF=1, synchronized PLL
Temperature and humidity for guaranteed accuracy	23 ±5°C (73±9°F), 80% RH or less (applies to all specifications unless otherwise noted)
Guaranteed accuracy period	6 months
Fundamental waveform range for guaranteed accuracy	42.5 to 69 Hz (360 to 440 Hz for 400 Hz measurements, although guaranteed accuracy is only for separately conducted shipping tests)
Display area for guaranteed accuracy	Effective measurement area

Indicator

Total display area	0.15 to 130% of selected range (RMS voltage and current; effective, apparent and reactive power; power factor) Display is suppressed to zero when less than 0.15%. 0.3 to 130% of selected range (DC voltage) Display is suppressed to zero when less than 0.3%. 0 to 130% of selected range (measurement items other than the above)
Effective measurement area	1 to 110% of selected range

Miscellaneous Measurement Items

(for all calculation items, there are no gaps of measurements)

RMS Voltage

Measurement method	True RMS method Waveform consists of 256 points/cycle, measured every 12 or 10 cycles at 50 or 60 Hz, respectively (approx. 200 ms) Waveform consists of 256 points/8cycles, measured every 80 cycles at 400 Hz (approx. 200 ms)
Display conversion function	Three-phase 3-wire (3P3W3M): Δ (line-to-line voltage) - Y (phase-to-neutral voltage) conversion (center point calculated by weighting) Three-phase 4-wire: Y (phase-to-neutral voltage) - Δ (line-to-line voltage) conversion
Range selection	Manual ranging (range for channels 1 to 3 selected in the same operation)
DC measurement	MEAN calculation
Measurement accuracy	AC: $\pm 0.2\%$ rdg. $\pm 0.1\%$ f.s. (50/ 60 Hz), $\pm 0.2\%$ rdg. $\pm 0.6\%$ f.s. (400 Hz) DC: $\pm 0.3\%$ rdg. $\pm 0.4\%$ f.s.

RMS Current

Measurement method	True RMS method Waveform consists of 256 points/cycle, measured every 12 or 10 cycles at 50 or 60 Hz, respectively (approx. 200 ms) Waveform consists of 256 points/8cycles, measured every 80 cycles at 400 Hz (approx. 200 ms)
Range selection	Manual ranging (range for channels 1 to 3 selected in the same operation)
Measurement accuracy	$\pm 0.2\%$ rdg. $\pm 0.1\%$ f.s. + clamp sensor accuracy (50/ 60 Hz) $\pm 0.2\%$ rdg. $\pm 0.6\%$ f.s. + clamp sensor accuracy (400 Hz)

Transient Overvoltage (impulse)

Measurement method	For detection, samples at 2 MHz are compared with calculation samples
Measurement range	2000 Vpk for channels 1 to 4
Displayed items	Peak voltage: Value between the threshold and the maximum value Period: Period threshold is exceeded (max. 4 ms)
Minimum detectable duration	0.5 μ sec
Measurement accuracy	$\pm 5.0\%$ rdg. ± 20 V (at 1000 VDC and 700 Vrms, 100 kHz)

RMS Voltage

Measurement method	<p>True RMS method</p> <p>Data samples of each half of one cycle (256 points) of the voltage waveform are overlapped, and the RMS voltage is obtained by calculating from one half cycle at 50 or 60 Hz measurement.</p> <p>When measuring 400 Hz, calculation is performed by averaging the squares of the sample data consisting of 256 points over 8 cycles of a waveform.</p> <p>(the line-to-line voltage is used for three-phase 3-wire (3P3W3M) systems, and the phase-to-neutral voltage is used for three-phase 4-wire systems)</p>
--------------------	--

Voltage Swell

Measurement method	Detected from RMS voltage (value calculated for one waveform shifted over half a wave) at 50 or 60 Hz measurement. For 400 Hz measurements, detection uses the value calculated over one cycle.
Displayed items	Swell amplitude and duration

Voltage Dip

Measurement method	Detected from RMS voltage (value calculated for one waveform shifted over half a wave) at 50 or 60 Hz measurement. For 400 Hz measurements, detection uses the value calculated over one cycle.
Displayed items	Dip depth and duration

Interruption

Measurement method	Detected from RMS voltage (value calculated for one waveform shifted over half a wave) at 50 or 60 Hz measurement. For 400 Hz measurements, detection uses the value calculated over one cycle.
Displayed items	Interruption depth and duration

Frequency

Measurement range	42.500 to 69.000 Hz, 360 Hz to 440 Hz
Measurement source	One of voltages U1, U2 or U3 (the same as the PLL synchronization source)
Measurement accuracy	±10 mHz with sine wave input of 10 to 110% of voltage range at 50 or 60 Hz measurement ±100 mHz with sine wave input of 30 to 110% of voltage range at 400 Hz measurement

Active Power

Measurement method	Waveform consists of 256 points/cycle, measured every 12 or 10 cycles at 50 or 60 Hz, respectively (approx. 200 ms) Waveform consists of 256 points/8 cycles, measured every 80 cycles at 400 Hz (approx. 200 ms) Calculated from sampled voltage and current waveform data
Measurement accuracy	±0.2% rdg. ±0.1% f.s. + clamp sensor accuracy at 50 or 60 Hz measurement. (with PF=1, the sum consisting of all channels used) ±0.4% rdg. ±0.6% f.s. + clamp sensor accuracy at 400 Hz measurement. (with PF=1, the sum consisting of all channels used)

Apparent Power

Measurement accuracy	±1 dgt. (±3 dgt. aggregated) of calculation from each measured value
----------------------	--

Reactive Power

Measurement accuracy	±1 dgt. (±3 dgt. aggregated) of calculation from each measured value
----------------------	--

Power Factor

Measurement range	-1.000 (leading) to 0.000 to +1.000 (lagging)
Measurement accuracy	±1 dgt. (±3 dgt. aggregated) of calculation from each measured value

Displacement Power Factor

Measurement method	Calculated from the phase difference between the fundamental waveforms of voltage and current
Measurement range	-1.000 (leading) to 0.000 to +1.000 (lagging)
Measurement accuracy	±0.5% rdg. ±0.2% f.s. ±1 dgt. at 50 or 60 Hz measurement (±3 dgt. aggregated) ±0.5% rdg. ±0.6% f.s. ±1 dgt. at 400 Hz measurement (±3 dgt. aggregated)

Voltage Unbalance Factor

Measurement method	For three-phase 3-wire (3P3W3M) and three-phase 4-wire systems, calculation is based on the three-phase voltage fundamental waveform (line-to-line voltage, refer to the calculation formula for details - Instruction Manual (CD-R version))
--------------------	---

Current Unbalance Factor

Measurement method	For three-phase 3-wire (3P3W3M) and three-phase 4-wire systems, calculation is based on the three-phase current fundamental waveform (line-to-line current, refer to the calculation formula for details - Instruction Manual (CD-R version))
--------------------	---

ΔU Voltage Fluctuation

Measurement method	Deviation in RMS voltage with respect to the standard voltage
Standard Voltage	Nominal voltage

S(t) Instantaneous Flicker value

Measurement method	Per IEC61000-4-15
Weighting filters	230 V lamp 50 Hz system, 120 V lamp 60 Hz system

ΔV_{10} Flicker

Measurement method	Calculated using the " ΔV_{10} perceived flicker curve".
Displayed items	ΔV_{10} measured at one minute intervals, average value for one hour, maximum value for one hour, fourth largest value for one hour, total (within the measurement interval) maximum value
Standard Voltage	Automatic (AGC)
Measurement accuracy	$\pm 4\%$ rdg. $\pm 0.01V$ (For 100 V RMS fundamental wave (50/60 Hz), 1 V RMS fluctuating voltage, and 10 Hz fluctuating frequency.)

IEC Flicker : short interval flicker value Pst and long interval flicker value Plt

Measurement method	Per IEC61000-4-15:1997+A1:2003 Pst and Plt are calculated from continuous measurement over 10 min. and 2 hours, respectively The 100 V lamp is per IEC SC77A National Committee, "IEC61000-4-15 Flickermeter Conformity Discussion Report for 100 Series Flicker Meter Ad-Hoc W/G"
Flicker filter	120V lamp, 230V lamp
Measurement accuracy	Pst: $\pm 5\%$ rdg. (as set forth for IEC61000-4-15 performance testing) Valid for input ranging from 50 to 100% of the voltage measurement range

Harmonic Voltage, Current and Power (including fundamental waveform content)

Measurement method	<p>Per IEC61000-4-7:2002</p> <ul style="list-style-type: none"> • Harmonic voltage/current: after harmonics are analyzed, inter-harmonic contents are added and displayed adjacent to harmonic content, according to harmonic order • Harmonic power: the value of harmonic power of each channel and aggregate value of multiple channels are displayed (refer to the calculation formula for details - Instruction Manual (CD-R version))
Harmonic analysis window width	10 or 12 cycles for 50 or 60 Hz, respectively 80 cycles for 400 Hz
Harmonic analysis window	Rectangular
Harmonic analysis frequencies	1st to 50th orders (of 42.5- to 69-Hz fundamental waveform)
Measurement accuracy	<p>(50/60 Hz)</p> <ul style="list-style-type: none"> • Harmonic voltage/ current: <ul style="list-style-type: none"> 1st to 20th order: $\pm 0.5\%$ rdg. $\pm 0.2\%$ f.s. 21st to 50th order: $\pm 1.0\%$ rdg. $\pm 0.3\%$ f.s. • Harmonic power: <ul style="list-style-type: none"> 1st to 20th order: $\pm 0.5\%$ rdg. $\pm 0.2\%$ f.s. 21st to 30th order: $\pm 1.0\%$ rdg. $\pm 0.3\%$ f.s. 31st to 40th order: $\pm 2.0\%$ rdg. $\pm 0.3\%$ f.s. 41st to 50th order: $\pm 3.0\%$ rdg. $\pm 0.3\%$ f.s. <p>(400 Hz)</p> <ul style="list-style-type: none"> • Harmonic voltage/ current: <ul style="list-style-type: none"> 1st to 2nd order: $\pm 0.5\%$ rdg. $\pm 0.2\%$ f.s. 3rd to 6th order: $\pm 1.0\%$ rdg. $\pm 0.3\%$ f.s. 7th to 10th order: $\pm 1.0\%$ rdg. $\pm 0.3\%$ f.s. $\pm 0.5 \times (k-6)\%$ rdg. (k:harmonic order) • Harmonic power: <ul style="list-style-type: none"> 1st to 2nd order: $\pm 0.5\%$ rdg. $\pm 0.2\%$ f.s. 3rd to 4th order: $\pm 1.0\%$ rdg. $\pm 0.3\%$ f.s. 5th to 10th order: $\pm 1.0\%$ rdg. $\pm 0.3\%$ f.s. $\pm 1.0 \times (k-4)\%$ rdg. (k:harmonic order) <p>However, for harmonic current and power, clamp sensor accuracy must be included</p>

Inter-Harmonic Voltage and Current

Measurement method	Per IEC61000-4-7:2002 After harmonic analysis, harmonic voltage and current are summed and displayed as inter-harmonic contents with the harmonic contents according to harmonic order
Harmonic analysis window width	10 or 12 cycles for 50 or 60 Hz, respectively
Harmonic analysis window	Rectangular
Harmonic analysis frequencies	0.5 to 49.5 orders (of 42.5- to 69-Hz fundamental waveform)
Measurement accuracy	unspecified

Harmonic Voltage/Current Phase Difference (including fundamental waveform content)

Measurement method	After harmonic analysis, the difference between harmonic voltage and current phase angles is displayed
Displayed items	Summed (total) value of harmonic voltage and current phase angles for each channel and multiple channels (refer to the calculation formula for details)
Measurement accuracy	(50/60 Hz) 1st to 3rd: $\pm 2^\circ$, 4th to 50th: $\pm(0.02^\circ \times k+2^\circ)$ (k:harmonic order) (400 Hz) 1st to 10th: $\pm(0.16^\circ \times k+2^\circ)$ (k:harmonic order) However, clamp sensor accuracy must be included
Range of guaranteed accuracy	Harmonic voltage and current level at each order are at least 1% of the range

Other Characteristics

Frequency characteristic	69Hz to 1kHz: $\pm 3\%$ f.s. 1kHz to 3kHz: $\pm 10\%$ f.s. (RMS voltage and current), $\pm 15\%$ f.s. (active power)
Temperature characteristic	AC: Within $\pm 0.03\%$ f.s./ $^\circ\text{C}$ at 50 or 60 Hz measurement, Within $\pm 0.05\%$ f.s./ $^\circ\text{C}$ at 400 Hz measurement (from 0 to 18 $^\circ\text{C}$ and from 28 to 40 $^\circ\text{C}$) DC: Within $\pm 0.1\%$ f.s./ $^\circ\text{C}$ (from 0 to 18 $^\circ\text{C}$ and from 28 to 40 $^\circ\text{C}$)
Effect of common mode voltage	$\pm 0.2\%$ f.s. or less (600 Vrms, 50/60 Hz, between voltage input terminal and instrument case) $\pm 2\%$ f.s. or less (600 Vrms, 400 Hz, between voltage input terminal and instrument case)
Effect of external magnetic field	$\pm 1.5\%$ f.s. or less (in a magnetic field of 400 A/m rms AC, 50/60 Hz)

Time Series Graph Recording Time

(When Internal memory only)

With Power selected, THD data is saved, but harmonic order data is not.

Interval	ALL DATA (Save All)		P&Harm (RMS and Harmonic Save)		Power (Save RMS only)	
	MAX/MIN/AVG	AVG	MAX/MIN/AVG	AVG	MAX/MIN/AVG	AVG
1 s	5 min 45 s	17 min 12 s	8 min 29 s	25 min 18 s	2 h 1 min 51 s	5 h 32 min 21 s
3 s	17 min 15 s	51 min 36 s	25 min 27 s	1 h 15 min 54 s	6 h 5 min 33 s	16 h 37 min 3 s
15 s	1 h 26 min 15 s	4 h 18 min	2 h 7 min 15 s	6 h 19 min 30 s	1 days 6 h 27 min 45 s	3 days 11 h 5 min 15 s
30 s	2 h 52 min 30 s	8 h 36 min	4 h 14 min 30 s	12 h 39 min	2 days 12 h 55 min 30 s	6 days 22 h 10 min 30 s
1 min	5 h 45 min	17 h 12 min	8 h 29 min	1 days 1 h 18 min	5 days 1 h 51 min	13 days 20 h 21 min
5 min	1 days 4 h 45 min	3 days 14 h	1 days 18 h 25 min	5 days 6 h 30 min	25 days 9 h 15 min	31 days
10 min	2 days 9 h 30 min	7 days 4 h	3 days 12 h 50 min	10 days 13 h	31 days	31 days
30 min	7 days 4 h 30 min	21 days 12 h	10 days 14 h 30 min	31 days	31 days	31 days
1 h	14 days 9 h	31 days	21 days 5 h	31 days	31 days	31 days
2 h	28 days 18 h	31 days	31 days	31 days	31 days	31 days

For other specifications and details: See the Instruction Manual (CD-R version).

For the product specifications of the EN50160, see the Instruction Manual for EN50160.



Maintenance and Service

9

9.1 Cleaning and Storage

Cleaning



- To clean the product, wipe it gently with a soft cloth moistened with water or mild detergent. Never use solvents such as benzene, alcohol, acetone, ether, ketones, thinners or gasoline, as they can deform and discolor the case.
- Wipe the LCD gently with a soft, dry cloth.
- Measurements are degraded by dirt on the mating surfaces of the clamp-on sensor, so keep the surfaces clean by gently wiping with a soft cloth.

Storage

- Storage temperature and humidity should be kept between -20 and 50°C, at less than 80% RH.
- Do not store or use the product where it could be exposed to direct sunlight, high temperature or humidity, or condensation. Under such conditions, the product may be damaged and insulation may deteriorate so that it no longer meets specifications.
- We recommend removing the battery pack when storing the instrument. However, the battery pack is subject to self-discharge. So when storing the battery pack for a long time, charge the battery at least once every two months.
- When storing the instrument for a long time (six months or more), the specifications are no longer guaranteed. Therefore, before use, have the instrument recalibrated.

9.2 Repair and Servicing



- Adjustments and repairs should be made only by technically qualified personnel.
- If damage is suspected, check the "Troubleshooting" section before contacting your dealer or Hioki representative.
- Pack the product carefully so that it will not be damaged during shipment, and include a detailed written description of the problem. Hioki cannot be responsible for damage that occurs during shipment.

Troubleshooting

If problems are encountered with operation, check the appropriate items below.

Symptom	Check Items
The POWER LED lights, but the screen is blank.	<ul style="list-style-type: none"> • Is the Power switch turned on? • Are the AC Adapter and power cord securely connected? • Is the battery pack installed properly? • Is the LCD Auto Off setting enabled?
Keys do not operate.	<ul style="list-style-type: none"> • Is a key stuck? • Is the Key Lock switch on?
Measurements are unstable	<ul style="list-style-type: none"> • Is the line frequency 50 or 60 Hz? 400-Hz line measurements are not supported.
Measurement data cannot be acquired as intended.	<ul style="list-style-type: none"> • Are the voltage cords and clamp sensors connected properly? • Do the actual measurement lines match the measurement line settings?
Data cannot be saved to a PC Card.	<ul style="list-style-type: none"> • Is the PC Card firmly inserted? • Is the PC Card initialized (formatted)? • Is the PC Card already full?
Operation is incorrect when connected to a PC.	<ul style="list-style-type: none"> • Is the instrument turned on? • Is the interface cable connected properly? • Are the interface settings correct?
Unable to print.	<ul style="list-style-type: none"> • Is the printer turned on? • Is the interface cable connected properly? • Are the interface settings correct? • Is the recording paper loaded properly (front and back)? • Is the print head lever up?
Power does not turn on.	<ul style="list-style-type: none"> • The power protection circuitry may be damaged. As this cannot be replaced or repaired by the user, please contact your supplier or nearest Hioki representative.

If the cause of the problem still cannot be found, try resetting the system. This returns most of the system settings to their factory defaults.

- ❖ System reset(page 51)

9.3 Battery Pack Charging

When first purchased, the 9459 BATTERY PACK may not be fully charged due to self-discharge. Before using the pack the first time, be sure to charge it completely.

When completely charged, recorded data is backed up for about 30 minutes when the instrument is turned off.

When using the 9459 BATTERY PACK without the 9458 AC ADAPTER, when the battery charge is depleted, the low-battery symbol () appears.

When this mark appears, connect the 9458 AC ADAPTER to recharge the 9459 BATTERY PACK.

Charging the Battery Pack

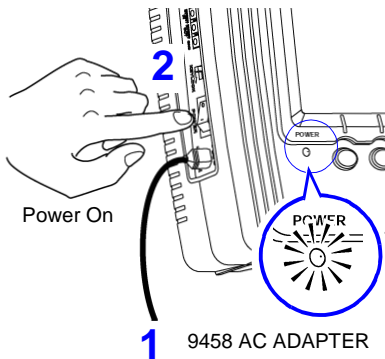

1. Connect the 9458 AC ADAPTER.

2. Turn the POWER switch On.
The POWER LED should light green to indicate charging.

 (Battery indicator lights red)
Charging should finish within about two hours.

When the battery indicator turns white, charging is finished.



3. When charging is finished, start measuring or turn the Power switch Off.

Charging is disabled when the Power switch is Off.
Verify that the battery is properly charged before using it.

If the battery is properly charged, the  indicator appears when the AC Adapter is unplugged.

NOTE

- This instrument is designed to charge the 9459 BATTERY PACK during normal operation. When the 9458 AC ADAPTER is used, the charging indicator is displayed while measuring, but measurements are not affected.

9.4 Battery Pack Replacement and Disposal

!WARNING

- To avoid electric shock, turn off the power switch and disconnect the voltage cords, clamp-on sensors and power cord before replacing the battery pack.
- To avoid the possibility of explosion, do not short circuit, disassemble or incinerate the battery pack. Handle and dispose of batteries in accordance with local regulations.

NOTE

- The battery pack can be expected to be recharged about 500 times, or for about one year before replacement. Replace the pack only with the HIOKI Model 9459 BATTERY PACK.
- The battery pack is subject to self-discharge. Be sure to charge the battery before initial use. If the battery capacity remains very low after correct recharging, the useful battery life is at an end.

Replacing the battery pack

Required tools: Phillips screwdriver

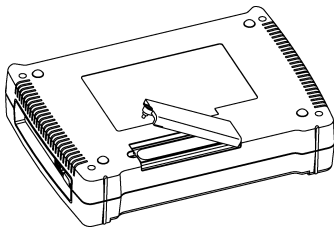

1. Turn the instrument over, remove the screw affixing the battery compartment cover, and remove the cover.

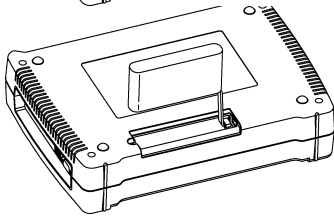

2. Remove the battery pack and disconnect the plug from the connector.
(This is easy to do when the instrument is upside down.)

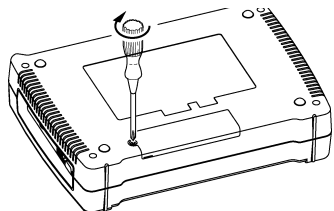

3. Connect the plug from the new battery pack, and insert it and its wiring.

4. Replace the battery compartment cover, and its screw. Avoid pinching the battery pack wires.

9.5 Instrument Disposal

The instrument contains a lithium battery for system backup.



To avoid electrocution, turn off the power switch and disconnect the power cord before removing the lithium battery.



- If the protective functions of the instrument are damaged, either remove it from service or mark it clearly so that others do not use it inadvertently.
- When disposing of this instrument, remove the lithium battery and dispose of battery and instrument in accordance with local regulations.

Lithium Battery Removal

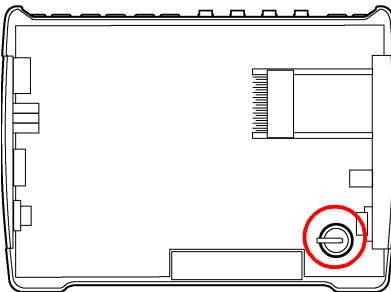
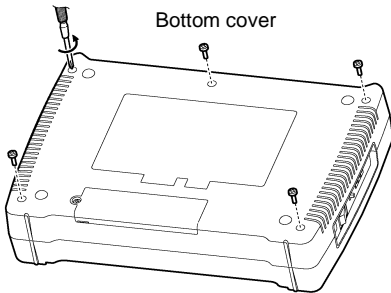

Required tools:

- Phillips screwdriver
- Wire cutter

1. Turn the instrument upside down and remove the five screws affixing the bottom cover.
2. Turn the instrument right side up and remove the top cover.
3. Cut the two leads of the button-type lithium battery near the corner of the circuit boards.

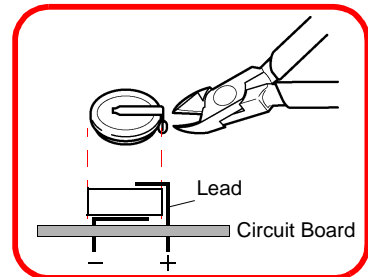



Appendix

Troubleshooting



Setting problems

Changing settings while [RECORDING] or [ANALYZING] is displayed?

During [RECORDING] operation:



[SETTING]

During [ANALYZING] operation:



[SETTING]

In either case, data stored in internal memory is erased.



Measurement problems

The Start key does not start recording during [ANALYZING] operation!



Return to the setting mode from analysis



Start recording

[RECORDING]

CAUTION! Pressing  erases all data stored in internal memory.

The measurement period is unknown.

Refer to the recording time table for time series graphs.
❖ (page 135)

To measure over a long period

Install a Flash ATA Card.
If a 128-MB card is installed: the recording period is about 10 times that listed.
(However, the maximum recording period in all cases is limited to 31 days.)

The Real-Time View is not available on the VIEW screen

The previous event selection is being retained.

Press  once to revert to the EVENT screen, then return to the VIEW screen.

Changes on the Harmonic screen do not appear on the TIME PLOT screen.

The operating settings do not record harmonics.

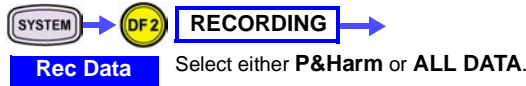

The unbalance factor does not appears in the TIME PLOT Change in RMS Value screen.

The wiring setting is 1P2W, 1P3W or 3P3W2M.

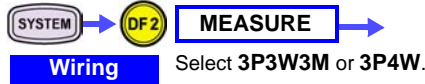

Data Analysis problems

What is the displayable period for analysis?

14 cycles can be displayed at 50 Hz, or 16 cycles at 60 Hz.

None of the data that was supposed to be saved to the PC card was saved.

Text save options must be selected.

Save the data to the PC card again ([ANALYZING] appears while the data is being saved).

Or, the intended data was not saved.



Pre-measurement settings (condition in which [SETTING] appears)

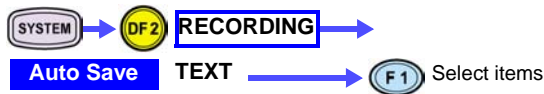

The error message "File not loaded completely." appears when you try to open text data with Excel.

Copy the data into a text editor, then split it into two files and use the two parts separately.

We recommend that the number of text save options selected in the 3196 SYSTEM screen be limited to no more than 250 items.

FAQ



How can I measure for a period of more than one month?

Answer: By using a PC card and setting SYSTEM-DF2 [RECORDING] for repeated recording, it is possible to record measurement data for up to 99 weeks.



How can the threshold be changed during recording? I need to change the threshold to suit conditions while measuring.

Answer: Event settings cannot be changed while recording. However, from the setting mode ([SETTING]) the Event monitor can be used to observe occurrences while changing the threshold, but without switching to the recording mode ([RECORDING]).



How can I monitor several locations (such as multiple channels on a distribution panel or multiple outlets in a building) in a single-phase system?

Answer: Ignore power measurement values, and use the 3P4W measurement mode.



How can I measure in-rush current (about 3-kHz frequency range).

Answer: Monitor peak current on the :TIME PLOT screen.



How can I observe an interruption (several ms) that cuts part of the waveform?

Answer: Use a waveform comparison event.



How can I observe an interruption (several μ s) that cuts part of the waveform?

Answer: Use the transient method.



I want a bound instruction manual.

Answer: Bound manuals are available. Contact your nearest dealer or distributor for information.

Reference

List of PC cards certified for use

Hioki options only (includes adapter)

- 9726 PC CARD 128M
- 9727 PC CARD 256M
- 9728 PC CARD 512M

Index

Numerics

3-Phase quality parameters (three-phase) 14

A

AC Adapter 32

 Connection 32

Accuracy

 Clamp on sensor 38, 39, 40

 Measurement accuracy 129, 130, 131, 132, 133, 134

 Real-time clock accuracy 127

Auto Printer Setup 119

B

Battery pack 31

 Charging 139

 Installation 31

 Replacement and disposal 140

C

Change in power 64

Checking three-phase systems 57

Clamp-On Sensor 37

 Connections 41, 46

Connecting to lines 45

 Connection check 60

 Connection method 47, 51

 Three-phase 3-wire 400 V 57

Connections

 Connection check 60

Current Unbalance Factor 63

Cursor measurement 62

D

Δ V10 Flicker 96, 100

DATA HOLD 21, 27

Disposal

 Battery pack 140

 Instrument 141

E

Event

 Event detection 94

 Event occurrence 86, 87

Event list 77, 87, 94

Event monitor 84, 93

Event setting 73

Event voltage fluctuation graph .. 52, 86

Event waveform 94

External Control terminals 124

F

Fluctuation graph 92, 99, 100, 105, 106

H

Hard copy 54, 84

Harmonic fluctuation 70

 Fluctuation graph 74

 Measurement Data 75, 101, 107

Harmonic quality parameters 14

I

IEC Flicker 102

Impulse 88

Interruption 78

 Fluctuation graph 85

 Measurement Data 85

Observation 145

K

Key operations

Troubleshooting 138

L

LAN 121

Connection 123

M

Manual event 124

Modem 121

P

PC Card 109

Auto Save 113

Delete 115

Hard Copy 115

Initialization 111

Inserting and removing 111

Loading 112

Save 112

Saving after measurement 114

Troubleshooting 138

Power quality parameters 14

Power supply

Troubleshooting 138

Power supply quality

Harmonic voltage quality 14

Power supply quality parameters 14

Printer 116

Connection 117

Hard Copy 120

Loading paper 118

Setup 119

Troubleshooting 138

R

Recording

Finished recording 68

Start 66

RMS Voltage 69

RMS voltage quality parameters 14

RS-232C

Connection 122

Interface 121

S

Self-test 43

System reset 51

T

Three-phase current 62

Three-phase voltage 62

Time series graph 52

Transient 88, 91

Transient waveform 95

Troubleshooting 138, 143

V

Version 43, 51

Voltage cord 33

Connections 33, 34, 46

Voltage fluctuation 85, 86

Voltage Unbalance Factor 63

W

Waveform distortion 88

Waveform scrolling 62

Wiring Adapter 35

Connection 35

DECLARATION OF CONFORMITY

Manufacturer's Name: HIOKI E.E. CORPORATION
Manufacturer's Address: 81 Koizumi, Ueda, Nagano 386-1192, Japan
Product Name: POWER QUALITY ANALYZER
Model Number: 3196
Accessories: 9458 AC ADAPTER
(SINO-AMERICAN, SA60-12V)
9459 BATTERY PACK
9438-02 VOLTAGE CORD
Options: 9264-01 WIRING ADAPTER
9264-02 WIRING ADAPTER
9638 RS-232C CABLE
9642 LAN CABLE

The above mentioned products conform to the following product specifications:

Safety: EN61010-1:2001
EN61010-031:2002
EMC: EN61326:1997+A1:1998+A2:2001
ClassA equipment
Equipment intended for use in industrial location
EN61000-3-2:2000
EN61000-3-3:1995+A1:2001

Supplementary Information:

The products herewith comply with the requirements of the Low Voltage Directive 73/23/EEC and the EMC Directive 89/336/EEC.

HIOKI E.E. CORPORATION

7 March 2005

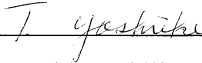

Tatsuyoshi Yoshiike
President

3196A999-02

HIOKI 3196 POWER QUALITY ANALYZER
Quick Start Manual

Publication date: October 2005 Revised edition 7

Edited and published by HIOKI E.E. CORPORATION
Technical Support Section

All inquiries to International Sales and Marketing Department
81 Koizumi, Ueda, Nagano, 386-1192, Japan

TEL: +81-268-28-0562 / FAX: +81-268-28-0568

E-mail: os-com@hioki.co.jp

URL <http://www.hioki.co.jp/>

Printed in Japan 3196A981-07

-
-
- All reasonable care has been taken in the production of this manual, but if you find any points which are unclear or in error, please contact your supplier or the International Sales and Marketing Department at HIOKI headquarters.
 - In the interests of product development, the contents of this manual are subject to revision without prior notice.
 - Unauthorized reproduction or copying of this manual is prohibited.
-
-

HIOKI

HIOKI E. E. CORPORATION

HEAD OFFICE

81 Koizumi, Ueda, Nagano 386-1192, Japan

TEL +81-268-28-0562 / FAX +81-268-28-0568

E-mail: os-com@hioki.co.jp / URL <http://www.hioki.co.jp/>

HIOKI USA CORPORATION

6 Corporate Drive, Cranbury, NJ 08512, USA

TEL +1-609-409-9109 / FAX +1-609-409-9108

3196A981-07 05-10H



Printed on recycled paper