



## 3522-50/3532-50 LCR HiTESTER

Component measuring instruments



Shorten line tact time via high speed measuring power

## Versatile LCR meters with 5ms measurement capabilities



ISO 9001  
 JMI-0216



ISO 14001  
 JQA-E-90091

With variable frequency measurements, the highly acclaimed 3522/3532 LCR HiTESTER has been improved with the power for maximum high speed measurements of 5 ms (4 times that of current models). This means that line tact times can be further shortened, promising you increased line efficiency.

The 3522-50 offers DC and a range from 1 mHz to 100 kHz, and the 3532-50 covers the range from 42 Hz to 5 MHz. Test conditions can now come closer to a component's operating conditions. The high basic accuracy of  $\pm 0.08\%$ , combined with ease of use and low price give these impedance meters outstanding cost-performance characteristics.

These will find a wide range of applications, whether for laboratory use for evaluation of operating characteristics, or for production line use, exploiting the full-function interface and comparator functions and rapid response.

# Two Models Cover Wide Frequency Range :



## 3522-50/3532-50 Features

### Higher frequency range

The measurement frequency can be freely set to DC or any value in the 1 mHz to 100 kHz range (3522-50) and any value in the 42 Hz to 5 MHz range (3532-50). In particular this makes it easy to test sample characteristics in the high frequency range.

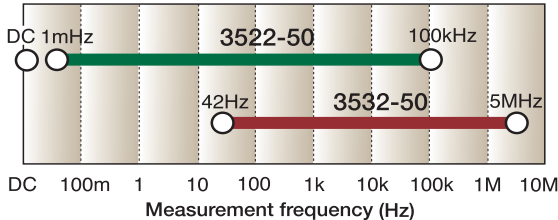

### High resolution and high accuracy

The measurement resolution provides a full five digits, with a basic measurement accuracy is  $\pm 0.08\%$ .

### Fastest measurement time 5 ms

Four sampling rates can be selected: FAST, NORMAL, SLOW, and SLOW2. The most rapid measurement time of 5 ms (displaying |Z|) gives rapid sampling for improved production line efficiency.

(The measurement frequency range varies from one parameter to another.)

### Fourteen parameters measured

The following parameters can be measured, and selected parameters can be captured by a computer: |Z|, |Y|,  $\theta$ , Rp (DCR\*), Rs (ESR, DCR\*), G, X, B, Lp, Ls, Cp, Cs, D (tan  $\delta$ ), and Q. \*3522-50 only

### \*DC resistance measurement \*3522-50 only

DC resistance measurement is another feature of the 3522-50. A single unit, the 3522-50 can provide the crucial parameters of inductance (L) and DC resistance (DCR) for a transformer or coil.

### Wide setting range for measurement voltage and current

In addition to normal open-loop signal generation, these units provide for voltage/current dependent evaluation, in constant voltage and constant current modes. The signal levels can be set over wide ranges, from 10 mV to 5 Vrms, and from 10  $\mu$ A to 100 mA (up to 1 MHz).

### Simultaneous setting and measurement

Measurement frequency, measurement signal level, and other measurement conditions can be changed while monitoring the measurement results, enabling effective trial measurements and setting of evaluation conditions.

### Interactive touch panel operation

Operation is extremely simple: touch the item on the screen to be changed, and the possible settings appear in sequence. The neat and simple front panel eliminates all key switches, for a clutter-free design.

### Memory for thirty sets of measurement conditions

Up to thirty sets of measurement conditions, including comparator values, provide rapid response to constantly changing components on flexible production lines. With multiple measurement conditions in memory, up to five different measurements can be made sequentially. The comparator function lets a single unit provide the logical AND result for this sequence of tests.

### Four simultaneous measurement items

Any four of the fourteen parameters can be chosen for simultaneous measurement and display.

### Enlarged display function

Up to four parameters can be displayed enlarged, for easy observation of the measurement values in production line and other situations where the unit is read at a distance.

### Correlation correction function

The constants a and b can be set in the following correction function expression:

$$\text{Corrected value} = a \times \text{measurement value} + b$$

### Printer output

With the optional 9442 PRINTER, measurement values, comparator results, and screen printouts can be obtained.

### DC bias measurement

Using the optional 9268/9269 DC BIAS UNIT, voltage and current bias measurements are simple. The maximum applied bias is  $\pm 40$  V DC, but depends on the measurement conditions.

# DC, 1 mHz to 100 kHz, and 42 Hz to 5 MHz

## External I/O interface

The EXT. I/O connector can input trigger signals, and provides a key lock on/off function, and remote control of the measurement condition loading. Output signals include comparator results and measurement completed signals, for complete line automation.

### Timing chart for EXT. I/O sequencing

The following chart shows the timing sequence of the trigger (TRIG), analog measurement completion (INDEX), and end-of-measurement (EOM) signals from the EXT. I/O connector.

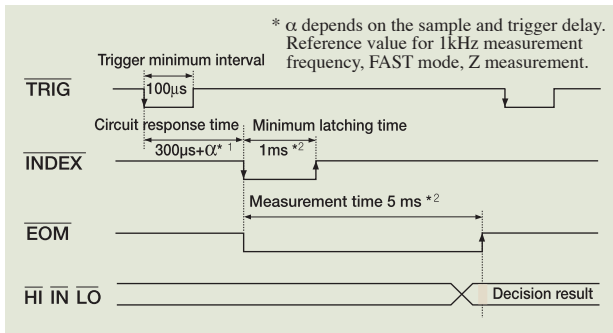

### EXT. I/O signals

#### ● Outputs

- Internal DC power (+5 V output)
- Comparator result
- Analog measurement completion
- End-of-measurement

#### ● Inputs

- External DC power supply (+5 V to +24 V can be supplied by external device)
- External trigger signal
- Key lock on/off function (3532-50 only)
- Memory setting selection

Either a GP-IB or RS-232C interface can be fitted (options).

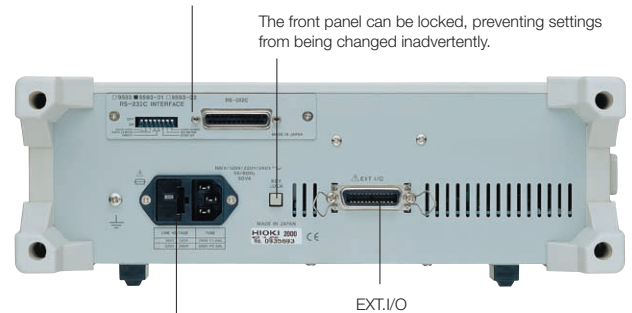

The AC power supply voltage is selectable: 100 V, 120 V, 220 V or 240 V AC.

Rear view of 3532-50

## 3522-50 / 3532-50 specifications

	3522-50	3532-50
Measurement parameters	Z ,  Y , $\theta$ , Rp (DCR), Rs (ESR, DCR), G, X, B, Cp, Cs, Lp, Ls, D (tan $\delta$ ), Q	Z ,  Y , $\theta$ , Rp, Rs (ESR), G, X, B, Cp, Cs, Lp, Ls, D (tan $\delta$ ), Q
Measurement ranges  Z , R, X	10.00 m $\Omega$ to 200.00 M $\Omega$ (depending on measurement frequency and signal levels)	
$\theta$	-180.00° to +180.00°	
C	0.3200 pF to 1.0000 F	0.3200 pF to 370.00 mF
L	16.000 nH to 750.00 kH	
D	0.00001 to 9.99999	
Q	0.01 to 999.99	
Y , G, B	5.0000 nS to 99.999 S	
Basic accuracy	Z : $\pm 0.08\%$ rdg. $\theta$ : $\pm 0.05^\circ$	
Measurement frequency	DC, 1 mHz to 100 kHz	42 Hz to 5 MHz
Measurement signal levels	10 mV to 5 V rms / 10 $\mu$ A to 100 mA rms	
Output impedance	50 $\Omega$	
Display screen	LCD with backlight / 99999 (full 5 digits)	
Measurement time (typical values for displaying  Z )	FAST : 5 ms, NORMAL : 16 ms, SLOW 1 / 2 : 88 ms / 828 ms	FAST : 5 ms, NORMAL : 21 ms, SLOW 1 / 2 : 72 ms / 140 ms
Settings in memory	Maximum 30 sets	
Comparator functions	HI/IN/LO settings for two measurement parameters; percentage, $\Delta\%$ , or absolute value settings	
DC bias	External DC bias $\pm 40$ V max.(option) (3522-50 used alone $\pm 10$ V max./ using 9268 $\pm 40$ V max.)	
External printer	9442 PRINTER (option)	
External interfaces	GP-IB or RS-232C (selectable options), external I/O for sequencer use	
Power source	100, 120, 220 or 240 V( $\pm 10\%$ ) AC (selectable), 50/60 Hz	
Maximum rated power	40 VA approx.	50 VA approx.

**Measurement ranges** : All parameter ranges are determined by the |Z| range.  
100 m $\Omega$ , 1  $\Omega$ , 10  $\Omega$ , 100  $\Omega$ , 1 k $\Omega$ , 10 k $\Omega$ , 100 k $\Omega$ , 1 M $\Omega$ , 10 M $\Omega$ , 100 M $\Omega$

#### Measurement frequency :

- [ 3522-50 ] : DC, 1 mHz to 100 kHz ( $\pm 0.005\%$ )  
Up to 10 Hz (1 mHz steps); 10 Hz to 100 Hz (10 mHz); 100 Hz to 1 kHz (100 mHz); 1 kHz to 10 kHz (1 Hz); 10 kHz to 100 kHz (10 Hz)
- [ 3532-50 ] : 42 Hz to 5 MHz ( $\pm 0.005\%$ )  
Up to 1 kHz (0.1 Hz steps); 1 kHz to 10 kHz (1 Hz); 10 kHz to 100 kHz (10 Hz); 100 kHz to 1 MHz (100 Hz); 1 MHz to 5 MHz (1 kHz)

#### Measurement levels :

##### [ Voltage and constant voltage ]

- 10 mV to 5 V rms (DC to 1 MHz)
- 50 mV to 1 V rms (1 MHz to 5 MHz)
- Maximum short-circuit current 100 mA rms
- 1 mV steps

##### [ Constant current ]

- 10  $\mu$ A to 100 mA rms (DC to 1 MHz)
- 50  $\mu$ A to 20 mA rms (1 MHz to 5 MHz)
- Maximum voltage 5 V rms
- 10  $\mu$ A rms steps

#### Dimensions and mass :

- 3522-50** : 313W  $\times$  125H  $\times$  290D mm; 4.5 kg approx.  
(12.32"W  $\times$  4.92"H  $\times$  11.41"D ; 159 oz. approx.)
- 3532-50** : 352W  $\times$  124H  $\times$  323D mm; 6.5 kg approx.  
(13.86"W  $\times$  4.88"H  $\times$  12.72"D ; 229.68 oz. approx.)

#### Conforming standards :

- EMC EN61326-1:1997+A1:1998
- EN61000-3-2:1995+A1:1998+A2:1998
- EN61000-3-3:1995
- Safety EN61010-1:1993+A2:1995
- Power supply: Pollution degree 2 Overvoltage Category II (anticipated transient overvoltage 2500 V)
- Test terminals: Pollution degree 2 Overvoltage Category I (anticipated transient overvoltage 330 V)



# Changing Settings During Measurement

## Test conditions can now come closer to a component's operating conditions

### Simple touch panel operation

Setting and changing the test conditions have never been simpler with this intuitive touch panel. The keys which are active appear in reverse video, and a touch of the item or value to be changed is enough. Moreover, the setting screens also show the measurement values in real time, allowing flexible monitoring while changing test signal settings. The screen also provides an enlarged display for any four parameters, for increased visibility at a distance on production lines.

\* The screens show typical examples on the 3522-50.

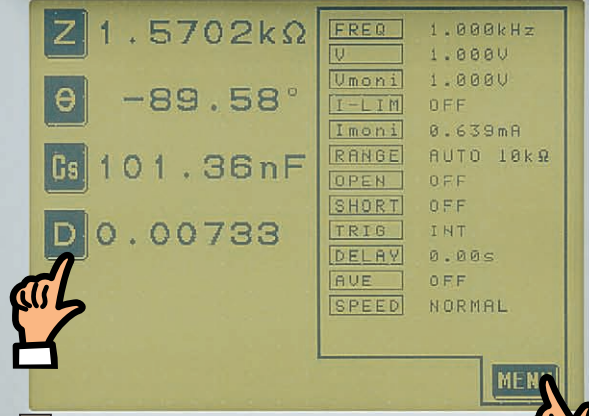

#### Initial screen

Shows measurement values for any selected four parameters, and current settings of conditions.

#### Parameter setting screen

Select any four of the parameters for display.

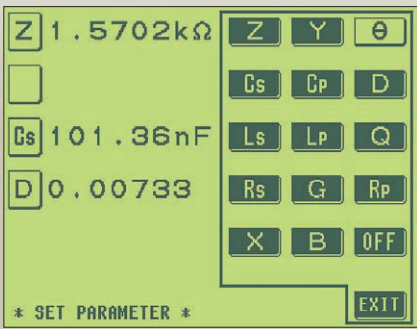

#### Menu screen

Select an item, and switch to the corresponding setting screen.

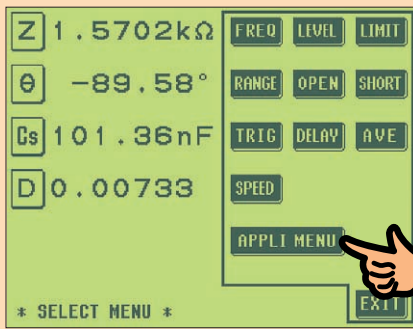

#### Application menu

Save and load measurement conditions, and set comparator execution, enlarged display, and so on.

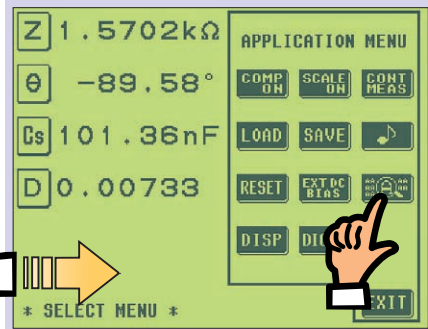

#### Measurement frequency

Use the numeric keypad or digit keys to enter the setting values, changing the test frequency or level while monitoring the measurement. The level setting can be open-circuit voltage, constant voltage, or constant current.

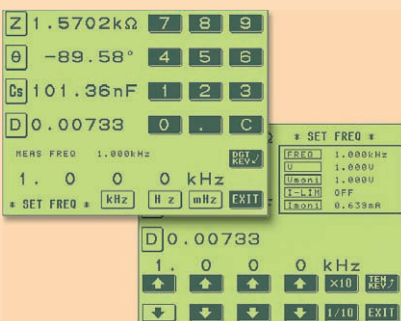

#### Level setting screens



#### Enlarged display and comparator setting screens

Set the enlarged display or select the settings saved in memory to execute continuous measurement.

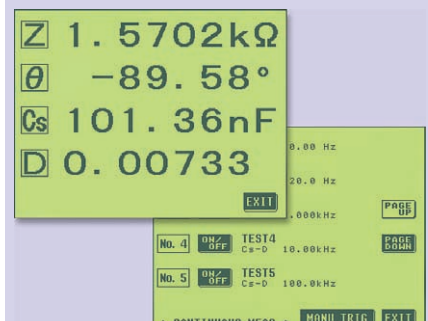

3522-50/3532-50 ICR HITESTER

## Personal computer link

# Effective Analysis and Processing of Measurement Data

### External control by computer

By installing the optional 9593-01, RS-232C INTERFACE or 9518-01 GP-IB INTERFACE, all of the 3522-50/3532-50 functions other than power on/off can be controlled from a computer.

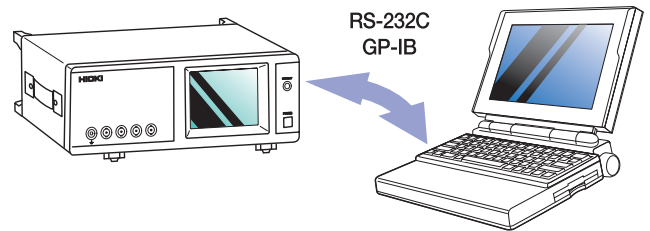

### Graphing with a spreadsheet program

Measurement data captured by a personal computer can be displayed graphically by using standard spreadsheet software. The example below uses the provision for continuously varying frequency to capture the frequency characteristics for a 1 MHz quartz oscillator measured with the 3532-50 into Excel, then presents the results graphically. The four-digit resolution for the frequency allows the characteristics of the steep resonance peak to be shown on the graph.

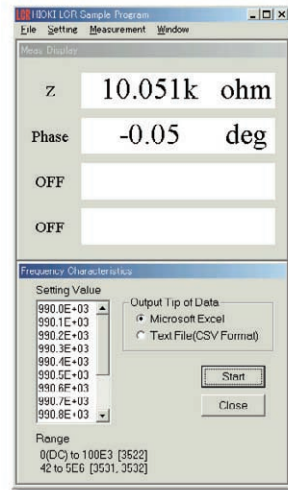
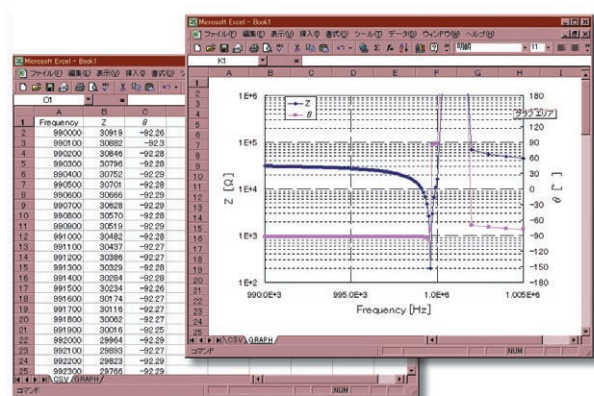

Similar to the main unit, you can also select up to 4 items to monitor. Data for the selected items will be filed.

Items such as the sweep frequency and data output directory can be set. In addition, the unit can also be set to output data whenever the return key is hit.

By utilizing the RS-232C interface, sample freeware that will enable measurement data to be output onto an Excel spreadsheet while the measured frequency is being swept is also available. Please inquire with your local HIOKI distributor.

### ■ 9593-01 RS-232C INTERFACE specification

Transmission method : Start-stop asynchronous  
 Transmission rates : 2,400/4,800/9,600 and 19,200 baud  
 Data bits : 7 or 8  
 Parity : Odd, even or none  
 Stop bits : 1 or 2

Delimiter : CR+LF, CR  
 Flow control : Hardware (According to DIP switch setting)  
 Connection : D-sub 25-pin, male/male connector, reverse connection

### ■ 9442 PRINTER



The optional 9442 PRINTER allows measurement results and screen copies to be printed. This is convenient for permanent records of inspections and so forth.  
 (Connection requires the optional 9593-01 RS-232C INTERFACE, 9446 CONNECTION CABLE, and AC ADAPTER.)

Resulting measurement data can be output not only to a printer, but also other media such as a PC or sequencer. Using the RS-232C interface makes transferring the inspection data simple and convenient.

Example Print-out					
Cs	984.16n F	D	0.00017		
Cs	984.14n F	D	0.00017		
Cs	984.10n F	D	0.00017		
Cs	984.20n F	D	0.00034		
Cs	983.91n F	LO	D	0.00052	HI
Cs	983.89n F	LO	D	0.00034	IN
Cs	984.03n F	IN	D	0.00017	LO
Cs	983.89n F	LO	D	0.00052	HI
Cs	983.95n F	LO	D	0.00034	IN
Cs	983.95n F	LO	D	0.00052	HI





# Flexible Measurement Signals Widen Scope for Application

## Applications

### ■ Evaluation of signal-dependent components

Since any test signal can be selected, it is possible to measure the inductance of winding, floating capacitance, characteristics at operating frequency, and low frequency resistance components. The 3522-50 further allows inductance (L) and DC resistance (DCR) to be measured by the same unit.

### Example of measuring signal dependence of coils

For chokes, transformers, and other components with an inductive core, the values depend on the measurement signal. By varying the measurement current, measurements showing the signal dependence of the coil can be shown as a graph.

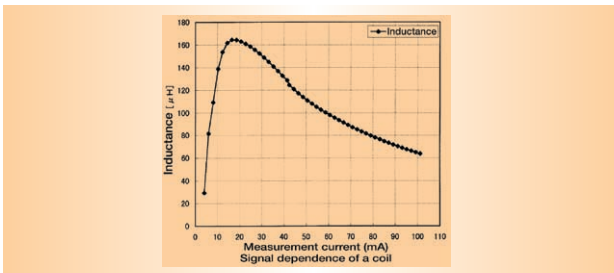

The 3522-50 and 3532-50 provide three modes for selecting the measurement signal according to the component characteristics: open-circuit voltage (V), constant voltage (CV), or constant current (CC).

- V mode : set  $V_0$
- CV mode : set  $V_0$  so that the voltage across the component is the CV value ( $V_{cv}$ )
- CC mode : set  $V_0$  so that the current through the component is the CC value ( $I_{cc}$ )
- $V_m$  : voltage monitor value
- $I_m$  : current monitor value
- $R_0$  : output impedance (50 Ω constant)

### Evaluating battery characteristics by measuring the internal resistance

By measuring the internal resistance of lead-acid or compact storage batteries, the state of deterioration of the battery, and its lifetime and characteristics can be determined.

In particular, the 3522-50 provides low-frequency measurement from 1 mHz, allowing low frequency electrochemical impedance measurement, and other applications in basic chemical research.



- Measurement values:  
 $R_s$  (DCR),  $R_s$ ,  $|Z|$ ,  $\theta$ , etc.
- Measurement frequency:  
DC, 1 kHz fixed, and variable frequency
- Measurement signal:  
constant current (CC) mode



### Comparator setting screen with additional Δ% display

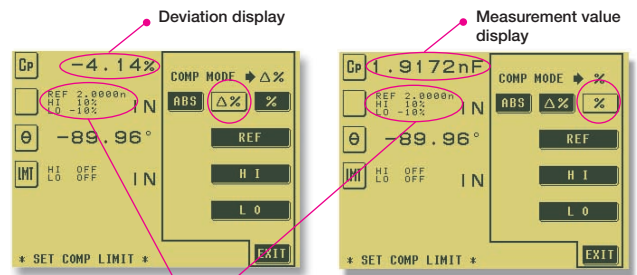

The screen at left shows an example of the Δ% setting; The screen at right shows an example of the % setting from current models. In either, the judgement range is a percentage of the reference values. The Δ% display is easy to interpret because the measurement value is displayed as a deviation.

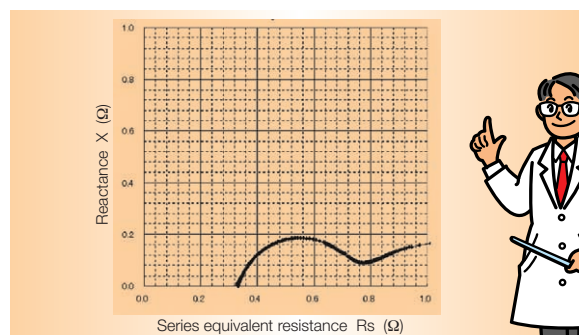
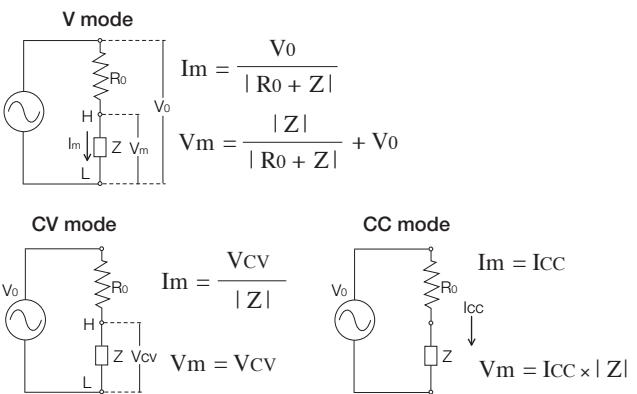

Frequency characteristics of a manganese battery  
(1 mHz to 100 kHz) [ cole-cole plot ]



## Measurement accuracy and ranges \*

**Conditions :** temperature range 23 °C ±5 °C (73 °F ±9 °F), 80% rh or less (no condensation)

After a 60-minute warm-up period, and open-circuit and short-circuit corrections are made.

Using the 9262 TEST FIXTURE, and measurement signal levels 1 V to 5 V (3522-50), 0.501 V to 1.000 V (3532-50); measurement speed SLOW2.

\* Measurement ranges and accuracy depend on the test fixture used, the measurement signal levels, and the measurement speed.

### 3522-50 Accuracy

Range	Impedance	DC	1m to 99.99Hz	100.0 to 999.9Hz	1.000 to 10.00kHz	10.01 to 100.0kHz
100MΩ	200MΩ 10MΩ	A=1 B=1	A=7 B=5 A=4 B=3	A=4.5 B=1 A=3 B=1.5	A=4.5 B=1 A=2.5 B=1.5	
10MΩ	10MΩ 1MΩ	A=0.5 B=0.3	A=2 B=0.5 A=1 B=0.2	A=0.7 B=0.4 A=0.7 B=0.2	A=0.7 B=0.4 A=0.5 B=0.2	A=1.5 B=0.5 A=2 B=0.3
1MΩ	1MΩ 100kΩ	A=0.2 B=0.05	A=0.7 B=0.03 A=0.35 B=0.02	A=0.25 B=0.03 A=0.15 B=0.02	A=0.2 B=0.03 A=0.1 B=0.02	A=0.7 B=0.03 A=0.5 B=0.1
100kΩ	100kΩ 10kΩ	A=0.1 B=0.01	A=0.4 B=0.01 A=0.28 B=0.002	A=0.2 B=0.002 A=0.12 B=0.002	A=0.15 B=0.002 A=0.08 B=0.002	A=0.35 B=0.01 A=0.1 B=0.02
10kΩ	10kΩ 1kΩ		A=0.38 B=0.002 A=0.25 B=0.001	A=0.15 B=0.002 A=0.1 B=0.001	A=0.1 B=0.002 A=0.05 B=0.001	A=0.2 B=0.002 A=0.08 B=0.002
1kΩ	1kΩ 100Ω		A=0.36 B=0.001 A=0.25 B=0.001	A=0.12 B=0.001 A=0.1 B=0.001	A=0.08 B=0.001 A=0.05 B=0.001	A=0.15 B=0.001 A=0.08 B=0.002
100Ω	100Ω 10Ω	A=0.1 B=0.02	A=0.36 B=0.01 A=0.25 B=0.005	A=0.15 B=0.01 A=0.1 B=0.005	A=0.15 B=0.01 A=0.05 B=0.005	A=0.15 B=0.02 A=0.08 B=0.01
10Ω	10Ω 1Ω	A=0.2 B=0.05	A=0.5 B=0.04 A=0.35 B=0.02	A=0.25 B=0.02 A=0.2 B=0.01	A=0.25 B=0.01 A=0.15 B=0.01	A=0.35 B=0.02 A=0.2 B=0.02
1Ω	1Ω 100mΩ	A=0.3 B=0.3	A=1 B=0.6 A=0.6 B=0.4	A=0.5 B=0.3 A=0.35 B=0.2	A=0.35 B=0.2 A=0.3 B=0.1	A=0.7 B=0.3 A=0.45 B=0.1
100mΩ	100mΩ 10mΩ	A=1 B=0.5	A=7 B=4 A=5 B=2	A=3.5 B=1.5 A=2.5 B=1	A=2.5 B=1.5 A=1.5 B=1	A=3.5 B=1.5 A=2 B=1

Upper figure A .. basic accuracy for |Z| (± % rdg.)  
B is coefficient for sample impedance

Lower figure A .. basic accuracy for θ (± deg.)  
B is coefficient for sample impedance

When DC resistance measurement,  
A is accuracy for R (± % rdg.)  
B is coefficient for sample resistance

The expression for calculating accuracy is different in the ranges above 1 kΩ and below 100 Ω.  
For details refer to the following expressions.

Range 1 kΩ and above...

$$\text{Accuracy} = A + \frac{B \times 10 \times Z_x - \text{range}}{\text{Range}}$$

Range 100 Ω and below...

$$\text{Accuracy} = A + \frac{B \times \text{range} - Z_x \times 10}{\text{Range}}$$

Z<sub>x</sub> is the measured impedance of the sample (|Z|).

### 3532-50 Accuracy

Range	Impedance	42 to 99.99 Hz	100.0 Hz to 1.000 kHz	1.001 to 10.00 kHz	10.01 to 100.0 kHz	100.1 k to 1.000 MHz	1.001 to 5 MHz
100 MΩ	200 MΩ 10 MΩ	A=4 B=4 A=2.5 B=2	A=2 B=2 A=1 B=1.5				
10 MΩ	10 MΩ 1 MΩ	A=0.8 B=0.4 A=1 B=0.2	A=0.4 B=0.2 A=0.25 B=0.1		A=1 B=0.5 A=1 B=0.5		
1 MΩ	1 MΩ 100 kΩ	A=0.4 B=0.05 A=0.3 B=0.1	A=0.15 B=0.05 A=0.15 B=0.02		A=0.3 B=0.08 A=0.3 B=0.08	A=3 B=1 A=3 B=0.5	
100 kΩ	100 kΩ 10 kΩ	A=0.35 B=0.01 A=0.25 B=0.01	A=0.08 B=0.01 A=0.05 B=0.01	A=0.15 B=0.01 A=0.08 B=0.01	A=0.25 B=0.04 A=0.15 B=0.02	A=0.4 B=0.3 A=0.3 B=0.3	* A=2 B=0.5 A=2 B=0.3
10 kΩ	10 kΩ 1 kΩ	A=0.35 B=0.01 A=0.25 B=0.005	A=0.08 B=0.01 A=0.05 B=0.005		A=0.2 B=0.02 A=0.08 B=0.02	A=0.3 B=0.03 A=0.15 B=0.02	* A=1.5 B=0.2 A=1 B=0.2
100 Ω	100 Ω 10 Ω	A=0.35 B=0.02 A=0.25 B=0.01	A=0.08 B=0.02 A=0.05 B=0.01		A=0.2 B=0.02 A=0.08 B=0.02	A=0.3 B=0.03 A=0.15 B=0.02	* A=1.5 B=0.2 A=1 B=0.2
10 Ω	10 Ω 1 Ω	A=0.4 B=0.04 A=0.3 B=0.1	A=0.2 B=0.03 A=0.1 B=0.02		A=0.2 B=0.03 A=0.15 B=0.02	A=0.4 B=0.1 A=0.3 B=0.05	* A=2 B=1 A=2 B=0.5
1 Ω	1 Ω 100 mΩ	A=0.7 B=0.4 A=1 B=0.2	A=0.4 B=0.3 A=0.25 B=0.2			A=1 B=1 A=0.7 B=0.5	*1.001 MHz and above accuracy × $\frac{(f [\text{MHz}]+3)}{4}$
100 mΩ	100 mΩ 10 mΩ	A=4 B=4 A=2.5 B=2	A=3 B=2 A=2 B=1				

#### Method of determining accuracy

- The measurement accuracy can be calculated from the impedance of the sample, the measurement range, the measurement frequency, and the basic accuracy A and coefficient B from the above tables.
- The expression for calculating accuracy is different in the ranges above 1 kΩ and below 100 Ω.
- For C and L, find the basic accuracy A and coefficient B either by direct measurement of the impedance or by approximate calculation as follows.

$$|Z_x (\Omega)| \cong \omega L (H) (\theta \cong 90^\circ)$$

$$\cong \frac{1}{\omega C (F)} (\theta \cong -90^\circ)$$

$$\cong R (\Omega) (\theta \cong 0^\circ)$$

#### Example calculation (The value A and B for the 3522-50)

Sample impedance Z<sub>x</sub>: 500 Ω (measured)  
Measurement conditions: frequency 10 kHz, signal level 2 V, range 1 kΩ  
From table above, basic Z accuracy A = 0.08, coefficient B = 0.001.  
Inserting these in the calculation expression yields:

$$Z \text{ accuracy} = 0.08 + \frac{0.001 \times 10 \times 5 \times 10^2 - 10^3}{10^3} = 0.084 (\pm \% \text{rdg.})$$

Similarly for θ basic accuracy A = 0.05, coefficient B = 0.001, and thus:

$$\theta \text{ accuracy} = 0.05 + \frac{0.001 \times 10 \times 5 \times 10^2 - 10^3}{10^3} = 0.054 (\pm \% \text{rdg.})$$

## Options for a wide range of applications



**9140 FOUR-TERMINAL PROBE**  
DC to 100 kHz



**9143 PINCHER PROBE**  
DC to 5 MHz



**9261 TEST FIXTURE**  
DC to 5 MHz



**9262 TEST FIXTURE**  
DC to 5 MHz

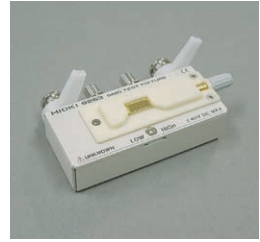

**9263 SMD TEST FIXTURE**  
DC to 5 MHz

\* All cable lengths are 1 m (39.37").

Measurable object size: 1.0 to 10 mm



**9268 DC BIAS VOLTAGE UNIT**  
Maximum applied voltage:  $\pm 40$  V DC  
42 Hz to 5 MHz

**9268-01 DC BIAS VOLTAGE UNIT**  
for HDMI  
Maximum applied voltage:  $\pm 4$  V DC  
42 Hz to 5 MHz

**9269 DC BIAS CURRENT UNIT**  
Maximum applied current:  $\pm 2$  A DC  
42 Hz to 100 kHz

Bias unit attached



### 9442 PRINTER



- **Printing method** Recording width: Thermal serial dot printer/112 mm (4.41")
- **Printing speed:** 52.5 cps
- **Power supply:** 9443 AC ADAPTER or supplied nickel-hydrogen battery pack (prints 3000 lines on full charge from 9443)
- **Dimensions and masst:** 160W x 66.5H x 170D mm; 580 g apprx. (6.30"W x 2.62"H x 6.70"D; 20.46 oz. apprx. )

\* Connecting the 9442 PRINTER requires the optional 9593-01 RS-232C INTERFACE, 9446 CONNECTION CABLE, and AC ADAPTER.

### Compact & Powerful dedicated LCR measurement in 5ms timeframes



*Improved with Faster Measurement !*

### 3511-50 LCR HiTESTER

- **Measurement times :** Fast ;5ms to Slow ;300ms (at 1kHz), Fast ;13ms to Slow ;400ms (at 120Hz)
- **Basic accuracy :**  $|Z|$ ;  $\pm 0.08\%$ ,  $\theta$ ;  $\pm 0.05^\circ$
- **Measurement parameters :**  $|Z|$ ,  $\theta$ , C, L, D, Q, R
- **Built-in comparator :** Upper and lower limit, absolute value
- **Dimensions, mass :** 210W x 100H x 168D mm, 2.5 kg (8.27"W x 3.94"H x 6.61"D, 88.34 oz. approx.)

### 3522-50 LCR HiTESTER

### 3532-50 LCR HiTESTER

(Standard accessories: power cord, spare power fuse (1 A for 100/120 V rating, 0.5 A for 220/240 V rating))

Test fixtures are not supplied with the unit.  
Select an optional test fixture when ordering.

#### Optional accessories

- 9140 FOUR-TERMINAL PROBE
- 9143 PINCHER PROBE
- 9261 TEST FIXTURE
- 9262 TEST FIXTURE (direct connection type)
- 9263 SMD TEST FIXTURE (direct connection type)
- 9268 DC BIAS VOLTAGE UNIT
- 9268-01 DC BIAS VOLTAGE UNIT (for HDMI)
- 9269 DC BIAS CURRENT UNIT

- 9165 CONNECTION CORD (for 9268/9269; BNC to BNC; 1.5 m/59.06")
- 9166 CONNECTION CORD (for 9268/9269; BNC to clips; 1.5 m/59.06")
- 9593-01 RS-232C INTERFACE
- 9518-01 GP-IB INTERFACE
- 9151-02 GP-IB CONNECTION CABLE (2 m/78.74")
- 9151-04 GP-IB CONNECTION CABLE (4 m/157.48")
- 9442 PRINTER
- 9446 CONNECTION CABLE (for 9442)
- 1196 RECORDING PAPER (for 9442 / 25 m/984.25", 10 rolls)
- 9443-01 AC ADAPTER (for 9442, Japan)
- 9443-02 AC ADAPTER (for 9442, EU)
- 9443-03 AC ADAPTER (for 9442, USA)



9443-02 (for EU) 9443-01 (for Japan)

**T**  
**Equipment**  
**.NET**



205 Westwood Ave  
Long Branch, NJ 07740  
1-877-742-TEST (8378)  
Fax: (732) 222-7088  
salesteam@Equipment.NET