

INSTRUCTION MANUAL

## 8835-01

# MEMORY HiCORDER

HIOKI E. E. CORPORATION

---

---



# Contents

Introduction .....	i
Inspection .....	i
Safety Notes .....	iii
Notes on Use .....	v
Chapter Summary .....	ix
<b>Chapter 1 Product Overview .....</b>	<b>1</b>
1.1 Major Features .....	1
1.2 Basic and Advanced Versions .....	4
1.2.1 Additional Features .....	4
1.3 Identification of Controls and Indicators .....	6
<b>Chapter 2 Installation and Preparation .....</b>	<b>11</b>
2.1 Installation of the Unit .....	12
2.2 Power Supply and Ground Connection .....	14
2.3 Power On/Off .....	18
2.4 Probe Connection .....	19
2.4.1 8936 ANALOG UNIT, 8938 FFT ANALOG UNIT and 8946 4 ch ANALOG UNIT .....	19
2.4.2 8937 VOLTAGE/TEMP UNIT .....	20
2.4.3 8939 STRAIN UNIT .....	22
2.4.4 8940 F/V UNIT .....	23
2.4.5 8947 CHARGE UNIT .....	25
2.5 Logic Probe Connection .....	26
2.6 9322 DIFFERENTIAL PROBE Connection .....	27
2.7 Loading Recoding Paper .....	27
2.8 Storage and Handling Precautions .....	30
2.9 Notes on Measurement .....	31
2.9.1 Using a Voltage Transformer .....	33
2.9.2 Maximum Input Voltage .....	33
<b>Chapter 3 Basic Operation and Measurement .....</b>	<b>35</b>
3.1 Basic Operation .....	35
3.1.1 Basic Display Operation .....	35
3.1.2 Setting Items .....	36

3.1.3	JOG/SHUTTLE Control and Select Key .....	37
3.1.4	Measurement Start and End .....	38
3.1.5	Basic Input Operation .....	38
3.1.6	Printer Key Operation .....	39
3.1.7	Other Keys Operation .....	39
3.1.8	On-line Help .....	41
3.2	Basic Measurement and Setting Procedures .....	42
3.2.1	Basic Operation Flow .....	42
3.2.2	Measuring and Recording a Voltage (Memory Recorder Function) .....	43
3.2.3	Measuring and Recording a Voltage (Recorder Function) .....	45
3.2.4	Measuring and Recording an RMS Value (RMS Recorder Function) .....	47
<b>Chapter 4</b>	<b>Memory Recorder Function .....</b>	<b>49</b>
4.1	Outline .....	49
4.1.1	Outline of the Memory Recorder Function .....	49
4.1.2	Operation Sequence .....	50
4.2	Making Settings .....	51
4.2.1	Setting the Function Mode .....	51
4.2.2	Setting the Time Axis Range .....	52
4.2.3	Setting the Recording Length .....	53
4.2.4	Setting the Format .....	55
4.2.5	Using the X-Y Waveform Plots .....	57
4.2.6	Setting the Printer Format .....	59
4.2.7	Setting the Roll Mode .....	61
4.2.8	Setting the Auto Print Function .....	61
4.2.9	Setting the Auto Save Function .....	62
4.2.10	Overlay .....	64
4.2.11	Setting the Trigger .....	65
4.2.12	Input Channel Settings .....	65
4.3	Settings on the Display Screen .....	66
4.3.1	Setting Magnification/Compression Along the Time Axis .....	66
4.3.2	Automatic Setting of Time Axis and Voltage Axis .....	67
4.4	Processing Functions (Waveform Parameter Processing) .....	68
4.4.1	Summary of the Processing Functions .....	68
4.4.2	Processing Method .....	69
4.4.3	Waveform Parameter Calculation Details .....	71

4.5	Start and Stop Measurement Operation	75
4.6	Print Examples	76
<b>Chapter 5 Recorder Function</b>		<b>79</b>
5.1	Outline	79
5.1.1	Outline of the Recorder Function	79
5.1.2	Operation Sequence	80
5.2	Making Settings	81
5.2.1	Setting the Function Mode	81
5.2.2	Setting the Time Axis Range and Sampling	82
5.2.3	Setting the Recording Length	84
5.2.4	Setting the Format	86
5.2.5	Setting the Printer Format	89
5.2.6	Setting the Additional Recording Function	91
5.2.7	Setting the Printer Function (Real Time Printing)	92
5.2.8	Setting the Auto Save Function	93
5.2.9	Setting the Trigger	94
5.2.10	Input Channel Settings	94
5.3	Settings on the Display Screen	95
5.3.1	Setting Compression Along the Time Axis	95
5.4	Start and Stop Measurement Operation	96
5.5	Print Examples	97
<b>Chapter 6 RMS Recorder Function</b>		<b>99</b>
6.1	Outline	99
6.1.1	Outline of the RMS Recorder Function	99
6.1.2	Operation Sequence	100
6.2	Making Settings	101
6.2.1	Setting the Function Mode	101
6.2.2	Setting the Time Axis Range	102
6.2.3	Setting the Frequency	103
6.2.4	Setting the Recording Length	104
6.2.5	Setting the Format	106
6.2.6	Setting the Printer Format	108
6.2.7	Setting the Additional Recording Function	110
6.2.8	Setting the Printer Function (Real Time Printing)	111
6.2.9	Setting the Auto Save Function	112
6.2.10	Setting the Trigger	113
6.2.11	Input Channel Settings	113

6.3	Settings on the Display Screen .....	114
6.3.1	Setting Compression Along the Time Axis .....	114
6.4	Start and Stop Measurement Operation .....	114
6.5	Print Examples .....	115
<b>Chapter 7</b>	<b>Input Channel Settings .....</b>	<b>117</b>
7.1	Overview .....	117
7.2	Selecting Channels (Memory Recorder Function Only) .....	117
7.3	Making the Settings of the 8936 ANALOG UNIT .....	118
7.3.1	Setting the Waveform Display Color .....	118
7.3.2	Setting the Waveform Display Graph Type .....	120
7.3.3	Setting the Voltage Axis Range .....	121
7.3.4	Setting the Input Coupling .....	122
7.3.5	Setting the Magnification/Compression Ratio Along the Voltage Axis .....	123
7.3.6	Setting the Zero Position .....	124
7.3.7	Zero Adjustment .....	126
7.3.8	Configuring Baseline Offset .....	127
7.3.9	Setting the Low-Pass Filter .....	129
7.4	Making the Settings of the 8937 VOLTAGE/TEMP UNIT .....	130
7.4.1	Setting Input for the VOLTAGE/TEMP UNIT .....	130
7.4.2	Making the Settings of Voltage Measurement .....	131
7.4.3	Making the Settings of Temperature Measurement .....	132
7.5	Making the Settings of the 8938 FFT ANALOG UNIT .....	135
7.5.1	Settings .....	135
7.5.2	Setting the Anti-aliasing Filter (Advanced Version) .....	135
7.6	Making the Settings of the 8939 STRAIN UNIT .....	137
7.6.1	Setting the Waveform Display Color .....	137
7.6.2	Setting the Waveform Display Graph Type .....	137
7.6.3	Setting the Measurement Range .....	137
7.6.4	Auto-balancing .....	138
7.6.5	Setting the Magnification/Compression Ratio Along the Measurement Range .....	139
7.6.6	Setting the Zero Position .....	140
7.6.7	Setting the Low-Pass Filter .....	140
7.7	Making the Settings of the 8940 F/V UNIT .....	141
7.7.1	Settings .....	141
7.7.2	Setting for Measuring Frequency .....	142

7.7.3	Setting Integral Measurement .....	146
7.7.4	Setting for Measuring Pulse Duty Ratio .....	148
7.7.5	Setting for Measuring Voltage .....	149
7.7.6	Setting for Measuring Current .....	150
7.8	Making the Settings of the 8946 4 ch ANALOG UNIT .....	152
7.8.1	Settings .....	152
7.8.2	Setting the Input Coupling .....	153
7.9	Making the Settings of the 8947 CHARGE UNIT .....	154
7.9.1	Settings .....	154
7.9.2	Setting for Measuring Acceleration .....	155
7.9.3	Setting for Measuring Voltage .....	159
7.10	Making Logic Input Settings .....	160
7.11	Copying Channels .....	162
7.12	Arbitrary Setting of Voltage Axis Magnification/ Compression and Display Range .....	163
7.13	Input Level Monitor Function .....	166
7.14	Channel Guide .....	168
<b>Chapter 8</b>	<b>Trigger Functions .....</b>	<b>169</b>
8.1	Overview .....	169
8.2	Setting the Trigger Mode .....	171
8.3	Setting the Pre-trigger (Memory Recorder and RMS Recorder Functions) .....	172
8.4	Trigger Timing (Recorder Function) .....	175
8.5	Setting Trigger Source AND/OR Linking .....	176
8.6	Using the Analog Trigger Function .....	177
8.6.1	Level Trigger (RMS Recorder Function Excluded) .....	178
8.6.2	Window-In, Window-Out Trigger (RMS Recorder Function Excluded) .....	182
8.6.3	Voltage Drop Trigger (Memory Recorder Function Only) .....	185
8.6.4	Period Trigger (RMS Recorder Function Excluded) .....	187
8.6.5	RMS Level Trigger (RMS Recorder Function Only) .....	191
8.7	Using the Logic Trigger Function .....	194
8.8	Using the Timer Trigger Function .....	196
8.9	Using the External Trigger Function .....	199
8.10	Manual Trigger .....	200
8.11	Trigger Output Connector .....	200

Chapter 9 SYSTEM Screen Settings .....	201
9.1 Overview .....	201
9.2 How to Use the SYSTEM Screen .....	202
9.3 Special Function Settings [ SETUP ] .....	203
9.3.1 Channel Selection (Memory Recorder Function) .....	204
9.3.2 Start Key Backup .....	204
9.3.3 Setting the Grid .....	205
9.3.4 Channel Marker Function .....	205
9.3.5 Displaying the Time from the Trigger Point (Time Display) .....	206
9.3.6 List and Gauge Functions .....	206
9.3.7 Setting the Printer Density .....	207
9.3.8 Setting Backlight Saver Function .....	207
9.3.9 Setting the Display Colors .....	208
9.3.10 Setting the Beep Sound .....	209
9.3.11 Setting the Language .....	209
9.3.12 Setting PRINT/EXT.SMPL .....	210
9.4 Scaling Function [ SCALING ] .....	211
9.4.1 Conversion Ratio Scaling .....	212
9.4.2 2-Point Scaling .....	215
9.4.3 Unit Entry Procedure .....	219
9.4.4 Copy Settings .....	220
9.4.5 Scaling Setting Example .....	221
9.5 Adding Comments to a Graph [ COMMENT ] .....	222
9.5.1 Title Comment Input .....	223
9.5.2 Analog Channel Comment Input .....	224
9.5.3 Moving to the Analog Channel Comment Input Screen or the Logic Channel Comment Input Screen .....	225
9.5.4 Logic Channel Comment Input .....	226
9.5.5 Character Entry Procedure .....	227
9.5.6 Description of Window Contents .....	228
9.6 Interface Settings (Media Settings) .....	229
9.6.1 Setting the Output Destination by the COPY Key .....	230
9.6.2 Setting the Output Destination by the PRINT Key .....	231
9.6.3 GP-IB Interface Settings .....	232
9.6.4 RS-232C Interface Settings .....	233
9.6.5 Setting the LAN Interface .....	235
9.7 Initialization [ INITIALIZE ] .....	239



9.7.1	Setting the Clock [ TIME SET ]	239
9.7.2	Clear Waveform Data [ WAVE DATA CLEAR ]	240
9.7.3	System Reset [ SYSTEM RESET ]	241
9.8	Self Check	242
9.8.1	ROM/RAM Check	242
9.8.2	Printer Check	243
9.8.3	Display Check	243
9.8.4	Key Check	244
9.8.5	PC Card Check	244
<b>Chapter 10</b>	<b>Printout of Waveform Data</b>	<b>245</b>
10.1	Overview	245
10.2	Selecting Waveform or Numeric Print	246
10.3	Using the Smooth Print Function (Memory Recorder Function Only)	248
10.4	Setting the Grid	250
10.5	Channel Marker Function	250
10.6	Adding Comment to Printout	251
10.7	Printing Procedure	252
10.7.1	Manual Print (All Functions)	252
10.7.2	Auto Print (Memory Recorder)	253
10.7.3	Real-Time Print (Recorder, RMS Recorder)	254
10.7.4	Partial Print (All Functions)	255
10.7.5	Screen Hard Copy (All Functions)	256
10.7.6	List Print (All Functions)	256
10.7.7	Report Print (All Functions)	257
10.7.8	External Printer (Color Print)	258
<b>Chapter 11</b>	<b>Using the A/B Cursors / Waveform Scrolling</b>	<b>259</b>
11.1	Overview	259
11.2	Using the A/B Cursors	260
11.2.1	Line Cursor (Vertical, Horizontal) (All Functions)	260
11.2.2	Trace Cursor	260
11.2.3	Using the Cursors	261
11.3	Scrolling the Waveform	264
11.4	Zoom Function	265
11.5	Vernier Function	267

Chapter 12 External Input/Output Connectors /	
Key Lock Function .....	269
12.1 Overview .....	269
12.2 External Start/Stop .....	270
12.3 External Printing/Sampling .....	272
12.4 Using the External Trigger Input (EXT TRIG) .....	273
12.5 Using the External Trigger Output (TRIG OUT) .....	274
12.6 Using the Evaluation Outputs (GO), (NG) .....	275
12.7 Using the Key Lock Function .....	276
Chapter 13 Storing, Retrieving and Deleting Waveform Data	
and Measurement Settings .....	277
13.1 Outline .....	277
13.2 Handling the Floppy Disk .....	278
13.2.1 Floppy Disk .....	278
13.2.2 Using the Floppy Disk Drive .....	279
13.2.3 Initializing (Formatting) the Floppy Disk .....	280
13.3 Handling the PC Card .....	281
13.3.1 PC Card .....	282
13.3.2 Using the PC Card Slot (PC Card with a Cable Only) .....	283
13.4 Storing, Retrieving and Deleting Data on the Floppy Disk	
or PC Card .....	286
13.4.1 Overview .....	286
13.4.2 FILE Screen .....	286
13.4.3 What Can Be Recorded and How Much .....	286
13.4.4 Selecting the Media Type .....	287
13.4.5 Detailed Explanation of the Commands .....	288
13.5 Using a PC Card on a Personal Computer .....	303
13.5.1 Windows 95 .....	303
13.5.2 Windows 3.1 and MS-DOS .....	303
Chapter 14 Specifications .....	305
14.1 General Specifications .....	305
14.1.1 Basic Specifications .....	305
14.1.2 Recorder .....	307
14.1.3 Display .....	307
14.1.4 External Data Storage .....	308
14.1.5 Interface .....	308

14.1.6 Others .....	309
14.2 Trigger Unit .....	310
14.3 Memory Recorder Function .....	311
14.4 Recorder Function .....	312
14.5 RMS Recorder Function .....	313
14.6 Recorder & Memory Function (Advanced Version) .....	314
14.7 FFT Function (Advanced Version) .....	315
14.8 Advanced Version .....	316
14.9 Auxiliary Function .....	316
14.10 Others .....	317
14.11 9439 DC POWER ADAPTER Specifications .....	318
14.12 System Operation .....	319
<b>Chapter 15 Logic and Analog Inputs .....</b>	<b>323</b>
15.1 Logic Inputs .....	323
15.1.1 Logic Probes .....	324
15.2 Analog Inputs .....	326
15.2.1 8936 ANALOG UNIT .....	326
15.2.2 8937 VOLTAGE/TEMP UNIT .....	327
15.2.3 8938 FFT ANALOG UNIT .....	329
15.2.4 8939 STRAIN UNIT .....	330
15.2.5 8940 F/V UNIT .....	331
15.2.6 8946 4 ch ANALOG UNIT .....	333
15.2.7 8947 CHARGE UNIT .....	334
15.3 Replacement Procedure .....	336
15.3.1 Replacement Procedure 1 .....	337
15.3.2 Replacement Procedure 2 .....	337
15.4 Input Cables .....	338
15.4.1 Connection Cable .....	338
15.4.2 9322 DIFFERENTIAL PROBE Connection .....	339
15.4.3 9018-10/9132-10 CLAMP-ON PROBE .....	340
15.5 Measurement Errors Caused by Signal Source Internal Resistance .....	341

Chapter 16 Maintenance .....	343
16.1 Printer Head Cleaning .....	344
16.2 Removing the Battery Before Discarding the 8835-01 .....	345
16.3 Troubleshooting .....	347
16.4 Cleaning the Unit .....	348
16.5 Service .....	348
Appendix .....	APPENDIX1
Appendix 1 Error and Warning Messages .....	APPENDIX1
Appendix 1.1 Error Messages .....	APPENDIX2
Appendix 1.2 Warning Messages .....	APPENDIX2
Appendix 2 Glossary .....	APPENDIX5
Appendix 3 Reference .....	APPENDIX7
Appendix 3.1 Sampling .....	APPENDIX7
Appendix 3.2 Aliasing .....	APPENDIX7
Appendix 3.3 Measurement Limit Frequency .....	APPENDIX8
Appendix 3.4 Recorder Function .....	APPENDIX9
Appendix 3.5 RMS Recorder Function .....	APPENDIX10
Appendix 4 Size of a Waveform File .....	APPENDIX11
Appendix 4.1 Binary Data .....	APPENDIX11
Appendix 4.2 Text File .....	APPENDIX15
Appendix 5 Waveform Viewer (Wv) .....	APPENDIX19
Appendix 5.1 Waveform Viewer Menus .....	APPENDIX21
Appendix 5.2 Using the Waveform Viewer .....	APPENDIX23
Appendix 5.3 Conversion to CSV Format .....	APPENDIX26
Appendix 5.4 Batch Conversion .....	APPENDIX28

---

## Introduction

Thank you for purchasing this HIOKI "8835-01 MEMORY HiCORDER."  
To get the maximum performance from the unit, please read this manual first,  
and keep this at hand.

---

## Inspection

- When the unit is delivered, check and make sure that it has not been damaged in transit. In particular, check the accessories, panel switches, and connectors.
- If the unit is damaged, or fails to operate according to the specifications, contact your dealer or HIOKI representative.

### Accessories

Grounded three-core power cord	1
Ground adapter	1
Recording paper	1
Protective cover	1
Roll paper attachment	2
PC card protector	1
Instruction Manual	1
Application Disk (CD-R)	1

**Options**

9540-01 FUNCTION UP DISK  
8936 ANALOG UNIT  
8937 VOLTAGE/TEMP UNIT  
8938 FFT ANALOG UNIT  
8939 STRAIN UNIT  
8940 F/V UNIT  
8946 4 ch ANALOG UNIT  
8947 CHARGE UNIT  
9439 DC POWER ADAPTER  
9221 RECORDING PAPER (10 rolls)  
9557 RS-232C CARD  
9558 GP-IB CARD  
9559 PRINTER CARD  
9333 LAN COMMUNICATOR  
9335 WAVE PROCESSOR  
9626 PC CARD 32 M  
9627 PC CARD 64 M  
9726 PC CARD 128 M  
9727 PC CARD 256 M  
9728 PC CARD 512 M  
9729 PC CARD 1 G  
9578 10BASE-T LAN CARD  
9388 CARRYING CASE  
9320 LOGIC PROBE  
9321 LOGIC PROBE  
9322 DIFFERENTIAL PROBE  
9324 POWER CORD (for logic connector)  
9325 POWER CORD (for the 8940 F/V UNIT sensor connector)  
9303 PT \*  
9197 CONNECTION CORD (for high voltage, maximum input voltage 500 V)  
9198 CONNECTION CORD (for low voltage, maximum input voltage 300 V)  
9199 CONVERSION ADAPTOR  
9217 CONNECTION CORD (insulated BNC to insulated BNC)  
9318 CONVERSION CABLE (for 9270, 9271, 9272, 9277, 9278 and 9279)  
9319 CONVERSION CABLE (for 3273)  
9305 TRIGGER CORD  
220H PAPER WINDER  
3273 CLAMP ON PROBE  
3273-50 CLAMP ON PROBE  
9018-10 CLAMP ON PROBE (10 to 500 A, 40 Hz to 3 kHz)  
9132-10 CLAMP ON PROBE \* (20 to 1000 A, 40 Hz to 1 kHz)  
9270 CLAMP ON SENSOR \* (20 A, 5 Hz to 50 kHz)  
9271 CLAMP ON SENSOR \* (200 A, 5 Hz to 50 kHz)  
9272 CLAMP ON SENSOR \* (20/200 A, 5 Hz to 10 kHz)  
9277 UNIVERSAL CLAMP ON CT (20 A, DC to 100 kHz)  
9278 UNIVERSAL CLAMP ON CT (200 A, DC to 100 kHz)  
9279 UNIVERSAL CLAMP ON CT \* (500 A, DC to 20 kHz)  
9555 SENSOR UNIT \* (used with the 9270 to 9272, and the 9277 to 9279)

\*: Not complied with the CE marking









## Safety Notes



This product is designed to conform to IEC 61010 Safety Standards, and has been thoroughly tested for safety prior to shipment. However, mishandling during use could result in injury or death, as well as damage to the product. Be certain that you understand the instructions and precautions in the manual before use. We disclaim any responsibility for accidents or injuries not resulting directly from product defects.

This manual contains information and warnings essential for safe operation of the product and for maintaining it in safe operating condition. Before using the product, be sure to carefully read the following safety notes.

### Safety symbols

	<ul style="list-style-type: none"> <li>• This symbol is affixed to locations on the equipment where the operator should consult corresponding topics in this manual (which are also marked with the  symbol) before using relevant functions of the equipment.</li> <li>• In the manual, this mark indicates explanations which it is particularly important that the user read before using the equipment.</li> </ul>
	Indicates a grounding terminal.
	Indicates AC (Alternating Current).
	Indicates DC (Direct Current).
	Indicates both DC (Direct Current) and AC (Alternating Current).
	Indicates the ON side of the power switch.
	Indicates the OFF side of the power switch.

### Accuracy



We define measurement tolerances in terms of f.s. (full scale), with the following meanings:

#### f.s. (maximum display value or scale length)

The maximum displayable value or scale length. This is usually the name of the currently selected range.

## Conventions used in this manual

The following symbols are used in this Instruction Manual to indicate the relative importance of cautions and warnings.

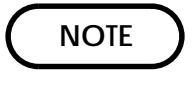
	<p>Indicates that incorrect operation presents extreme danger of accident resulting in death or serious injury to the user.</p>
	<p>Indicates that incorrect operation presents significant danger of accident resulting in death or serious injury to the user.</p>
	<p>Indicates that incorrect operation presents possibility of injury to the user or damage to the equipment.</p>
	<p>Denotes items of advice related to performance of the equipment or to its correct operation.</p>

### Measurement categories (Overvoltage categories)

This instrument complies with CAT II safety requirements.

To ensure safe operation of measurement instruments, IEC 61010 establishes safety standards for various electrical environments, categorized as CAT I to CAT IV, and called measurement categories. These are defined as follows.

**CAT I :** Secondary electrical circuits connected to an AC electrical outlet through a transformer or similar device.

**CAT II :** Primary electrical circuits in equipment connected to an AC electrical outlet by a power cord (portable tools, household appliances, etc.)

**CAT III :** Primary electrical circuits of heavy equipment (fixed installations) connected directly to the distribution panel, and feeders from the distribution panel to outlets.

**CAT IV :** The circuit from the service drop to the service entrance, and to the power meter and primary overcurrent protection device (distribution panel).

Higher-numbered categories correspond to electrical environments with greater momentary energy. So a measurement device designed for CAT III environments can endure greater momentary energy than a device designed for CAT II. Using a measurement instrument in an environment designated with a higher-numbered category than that for which the instrument is rated could result in a severe accident, and must be carefully avoided.

Never use a CAT I measuring instrument in CAT II, III, or IV environments.

The measurement categories comply with the Overvoltage Categories of the IEC60664 Standards.

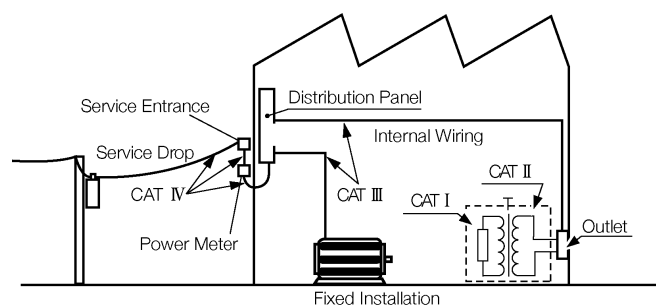



## Notes on Use

Follow these precautions to ensure safe operation and to obtain the full benefits of the various functions.

### (1) Installation environment



**Do not use the product where it may be exposed to corrosive or combustible gases. The product may be damaged or cause an explosion.**



- This product should be installed and operated indoors only, between 5 and 40 °C and 35 to 80% RH.
- Do not store or use the product where it could be exposed to direct sunlight, high temperature or humidity, or condensation. Under such conditions, the product may be damaged and insulation may deteriorate so that it no longer meets specifications.
- This product is not designed to be entirely water- or dust-proof. To avoid damage, do not use it in a wet or dusty environment.

### (2) Power supply connections



- **Before turning the product on, make sure the source voltage matches that indicated on the product's power connector. Connection to an improper supply voltage may damage the product and present an electrical hazard.**
- **Before making connections, make sure the 9439 DC POWER ADAPTER is turned off. The 8835-01 could be damaged by a spark if it is connected to a voltage source while its power supply is on.**

- Check that the power supply is correct for the rating of the unit. (The AC fuse is integrated in the unit.)
- The AC power switch on 8835-01 is for AC power. If DC power is being supplied and the switch on DC power adapter is set to ON, the 8835-01 will operate also if the power switch is set to OFF.

### (3) Grounding the unit



**To avoid electric shock and ensure safe operation, connect the power cable to a grounded (3-contact) outlet.**



#### (4) Probe Connection, Measurement Voltage Input

##### **⚠ DANGER**

- Maximum input voltage ratings for the 8936 ANALOG UNIT, 8937 VOLTAGE/TEMP UNIT, 8938 FFT ANALOG UNIT, 8939 STRAIN UNIT 8940 F/V UNIT, 8946 4ch ANALOG UNIT, 8947 CHARGE UNIT and input terminals of the 8835-01 are shown below. To avoid the risk of electric shock and damage to the unit, take care not to exceed these ratings.
- The maximum rated voltage to earth of the 8936, 8937, 8938, 8939, 8940, 8946 and 8947 (voltage between input terminals and 8835-01 frame ground, and between inputs of other input units) is shown below. To avoid the risk of electric shock and damage to the unit, take care that voltage between channels and between a channel and ground does not exceed these ratings.
- The maximum rated voltage to earth rating applies also if an input attenuator or similar is used. Ensure that voltage does not exceed these ratings.
- When measuring power line voltages, 8936 or 8938 should only be connected to the secondary side of a breaker, so the breaker can prevent an accident if a short circuit occurs. Connections should never be made to the primary side of a breaker, because unrestricted current flow could cause a serious accident if a short circuit occurs.
- Always use the optional connection cables. Any exposed metal sections in a connection cable consist a risk of electric shock.

Input/output terminal	Maximum input voltage	Maximum rated voltage to earth
8936 inputs	400 VDC max.	370 V AC/DC
8937 inputs	30 V rms or 60 VDC	30 V rms or 60 VDC
8938 inputs	400 VDC max.	370 V AC/DC
8939 inputs	10 VDC max.	30 Vrms or 60 VDC
8940 inputs	30 V rms or 60 VDC (BNC and sensor connector terminals)	30 V rms or 60 VDC (BNC terminal) Not insulated (Sensor connector terminal)
8946 inputs	30 V rms or 60 VDC	30 V rms or 60 VDC
8947 inputs	30 V rms or 60 VDC	30 V rms or 60 VDC
EXT TRIG	-5 to +10 VDC	Not insulated
START/STOP		
PRINT/EXT SMPL		
TRIG OUT	-20 V to +30 VDC 100 mA max. 200 mW max.	
GO		
NG		

- The external I/O terminal and the 8835-01 have a common GND.

**⚠ DANGER**

- Logic probe input and 8835-01 share the same GND. Separate power supply sources applied to the testing device and 8835-01 may result in risk of electric shock and damage to the unit. Even with the same power supply source, certain ways of wiring may cause a variance in electric potential sending current that may damage testing device and 8835-01. The following shows proper wiring to avoid damage. For details, see Section 2.5.
  - (1) Before connecting logic probe to testing device, connect grounded three-core power cord (attachment) to the device to be tested and 8835-01 and supply power from the same outlet.
  - (2) Before connecting logic probe to device to be tested, connect GND of device to be tested with 8835-01 functional ground terminal. Make sure that power is supplied from the same outlet.
- When using grabber clips, the 9322's maximum rated voltage to earth is 1500 V AC/DC; when using alligator clips, it is 1000 VAC/DC. To avoid electrical shock and possible damage to the unit, never apply voltages greater than these limits between the input channel terminals and chassis, or across the inputs of two 9322s.
- Maximum input voltage is 1000 VAC/2000 VDC. Do not measure voltage in excess of these limitations, as doing so may damage the unit or cause an accident that might result in injury or death.

**⚠ CAUTION**

- Use designated connection cables only. Other cables may interfere with proper connection and measurement accuracy.
- Maximum charge input for miniature connector terminal in 8947 CHARGE UNIT is +, - 500 pC (at range 6 high sensitivity) and +, - 50000 pC (at range 6 low sensitivity).

**NOTE**

Use only the specified connection cord. Using a non-specified cable may result in incorrect measurements due to poor connection or other reasons.

**(5) Replacing the input units (see Section 15.3)****⚠ WARNING**

- To avoid electric shock accident, before removing or replacing an input module, confirm that the instrument is turned off and that the input cords and power cords are disconnected.
- To avoid the danger of electric shock, never operate the product with an input module removed. To use the product after removing an input module, install a blank panel over the opening of the removed module.

**(6) Recording paper****NOTE**

- This unit uses a thermal printer. The recording paper supplied has characteristics finely tuned for use with the printer. Using recording paper of a different specification may not only result in impaired printing quality, but even prevent the printer from operating. Always use the HIOKI specified product.
- Insert the paper with correct orientation (see Section 2.7).

**(7) Using a printer****NOTE**

Avoid using the printer in hot, humid environments, as this can greatly reduce printer life.

**(8) Storing****CAUTION**

For shipping or long-term storage, be certain that the recording head is in the raised position. Otherwise the rollers could be deformed and cause uneven printing.

**(9) Shipping****CAUTION**

- Remove the printer paper from the unit. If the paper is left in the unit, paper support parts may be damaged due to vibrations.
- To avoid damage to the product, be sure to remove the PC card and floppy disk before shipping.
- Use the original packing materials when reshipping the product, if possible.

**(10) Others****NOTE**

- In the event of problems with operation, first refer to Section 16.3, "Troubleshooting."
- Carefully read and observe all precautions in this manual.

**Preliminary Checks**

Before using the product the first time, verify that it operates normally to ensure that no damage occurred during storage or shipping. If you find any damage, contact your dealer or HIOKI representative.

**WARNING**

**Before using the product, make sure that the insulation on the cords and probes is undamaged and that no bare conductors are improperly exposed. Using the product under such conditions could result in electrocution. Replace the cords and probes specified by HIOKI.**

---

## Chapter Summary

- Chapter 1 Product Overview**  
Contains an overview of the unit and its features.
- Chapter 2 Setup and Preparations**  
Explains how to set the unit up for measurement.
- Chapter 3 Operation Steps for Basic Measurement**  
Explains how to operate the keys and JOG/SHUTTLE control for carrying out basic measurement functions.
- Chapter 4 Memory Recorder Function Settings**  
Explains how to use the memory recorder functions of the unit.
- Chapter 5 Recorder Function Settings**  
Explains how to use the recorder functions of the unit.
- Chapter 6 RMS Recorder Function Settings**  
Explains how to use the RMS recorder functions of the unit.
- Chapter 7 Input Channel Settings (For all functions)**  
Explains how to make settings using the channel setting screen.
- Chapter 8 Trigger Functions**  
Explains how to use the trigger functions of the unit.
- Chapter 9 System Screen Settings**  
Explains how to make settings using the system setting screen.
- Chapter 10 Printout of Waveform Data**  
Explains how to print out waveform data and how to read printed charts.
- Chapter 11 Using the A/B Cursors / Waveform Scrolling**  
Explains how to use the A/B cursors and how to perform waveform scrolling.
- Chapter 12 External Input/Output Connectors / Key Lock Function**  
Gives specifications and usage details of the external input/output connectors, and explains how to use the key lock function.

**Chapter 13 Storing, Recalling and Deleting Waveform Data and Measurement Settings**

Explains how to store, recall, and delete waveform data and measurement settings.

**Chapter 14 Specifications**

Contains general specifications and detailed function specifications.

**Chapter 15 Logic Input Section and Analog Input Unit**

Contains specifications and precautions for logic input section and input amplifier units.

**Chapter 16 Maintenance**

Describes maintenance procedures.

**Appendix**

Contains information that is necessary for using this unit, including a description of error messages and a glossary.

# Chapter 1

## Product Overview

### 1.1 Major Features

- (1) Easy to read, TFT color display  
The 6.4-inch TFT color screen with a resolution of 640 × 480 dots shows all information at a glance.
- (2) Three functions to meet a huge range of applications
  - Memory recorder with up to 1 μs (all channels simultaneously) (1 MS/s)
  - Real-time recording capability to paper in recorder function
  - RMS recorder function for recording rms values of AC power supply lines and DC sources.
- (3) Flexible trigger function
  - Digital trigger circuit
  - Trigger types: level trigger, window-in trigger, window-out trigger, voltage drop trigger, RMS level trigger, logic trigger
- (4) Built-in thermal printer
  - Thermal line head
  - The built-in printer delivers waveform printouts on the spot.
  - The printer can also be used to print screen shots and parameter information.
- (5) 1 μs (1 MS/s) recording capability  
Using the 8946 4 ch ANALOG UNIT (unbalanced), waveform recording can be performed in up to 8 channels with 12-bit resolution.
- (6) Simple function key interface (GUI)  
Thanks to its GUI-inspired design using large function key graphics, the unit is easy to set up and operate.

- (7) On-line help  
On-line help guides the user through operation steps and various functions.
- (8) Scaling function  
By setting the physical amount and the unit to be used for 1 V input, the measurement result can be converted into any desired scale.
- (9) Additional recording function  
When enabled, the memory is regarded as printer paper.  
New data is recorded without erasing the previous data.
- (10) Floating input units  
The analog inputs are floating, and so each input can be connected to its own independent potentials.
- (11) Portable  
The 8835-01 weighs only 4.5 kg and has an A4-size form factor, making it extremely portable.
- (12) Floppy disk, PC card (external storage)  
Waveform data and measurement settings can be stored on floppy disk or PC card.
- (13) Easy-to-use control panel  
Measurement conditions can be easily set while looking at the color display.  
Operation keys are few, making setting easy.
- (14) External interface  
The PC card slot is compatible with GP-IB, RS-232C and 10BASE-T LAN cards. Remote control is possible.
- (15) Dual-language capability  
Display language is switchable between Japanese and English.



## Enhancements over the 8835

- (1) Supports the 8946 4ch ANALOG UNIT

The 8946 4ch ANALOG UNIT, which is not compatible with the Model 8835, can be used to provide up to eight analog measurement channels with the 8835-01.

8835	Max 4 analog channels and 16 logic channels
8835-01	Max 8 analog channels and 16 logic channels

- (2) Supports the current measurement mode of the 8940 F/V UNIT

Current measurement modes not available with the 8835 can be used. The available 8940 measurement modes are as follows.

8835	(1) Frequency, (2) Count, (3) Pulse duty ratio, (4) Voltage
8835-01	(1) Frequency, (2) Count, (3) Pulse duty ratio, (4) Voltage (5) Current

- (3) Eight times the memory capacity of the 8835

The installed memory capacity of the 8835-01 is eight times that of the 8835.

8835	Installed Memory: 500K words (expandable to 2M words)
8835-01	Installed Memory: 4M words (not expandable)

- (4) External sampling provided as standard

The external sampling function is provided as standard with the 8835-01. Specification Changes from the 8835

## Specification Changes from the 8835

Waveform backup time for the 8835-01 is shorter than for the 8835. When power is turned off after being on for more than two minutes, the waveforms are backed up for about one hour.

8835	Waveform: Approx. 10 years, Settings: Approx. 10 years (at 25 °C)
8835-01	Waveform: Approx. 1 hour, Settings: Approx. 10 years (at 25 °C)

---

## 1.2 Basic and Advanced Versions

This section explains the features of the basic version and the advanced version. It is possible to upgrade the basic version to the advanced version, using the feature upgrade disk available as an option.

---

### 1.2.1 Additional Features

The following features and functions can be added to the basic version.

#### Measurement functions

Measurement functions are listed in the table below.

Measurement function	Feature	Version
Memory recorder	High-speed data saving	Basic version
Recorder	Real time recording	
RMS recorder	For commercial power supplies	
Recorder & Memory	Real time recording & High-speed data saving	Advanced version (incorporates the basic version)
FFT	Frequency analysis	

The basic version incorporates the "memory recorder function", "recorder function", and "RMS recorder function". In addition to these functions, the advanced version incorporates "recorder & memory" and the "FFT function".

#### Computation functions

Waveform processing calculation:

Arithmetic operations, absolute value, exponents, common logarithms, moving average, 1st and 2nd derivatives, 1st and 2nd integrals, time axis parallel shift

Averaging function:

Additive averaging, exponential averaging (2, 4, 8 to 256 samples) (memory recorder)

Simple averaging, exponential averaging, peak hold (2, 4, 8 to 4096 samples) (FFT)

#### Waveform decision function

Waveform area decision:

Waveform decision based on reference area for Y-T waveform, X-Y waveform, or FFT results

Waveform parameter decision:

Decision based on setting minimum and maximum values for waveform parameter calculation results

## **Memory segmentation function**

Memory can be segmented among channels. (255 segments)

Sequential save function

This function does not update the display indication or record data on the printer or external storage. Input signal capture is carried out continuously using the trigger.

Multi-block function

Waveform data can be stored in a selected block.

Waveform data in specified blocks can be superimposed.

## 1.3 Identification of Controls and Indicators

Controls and indicators of the unit are listed on the following pages, along with a simple explanation of their function.

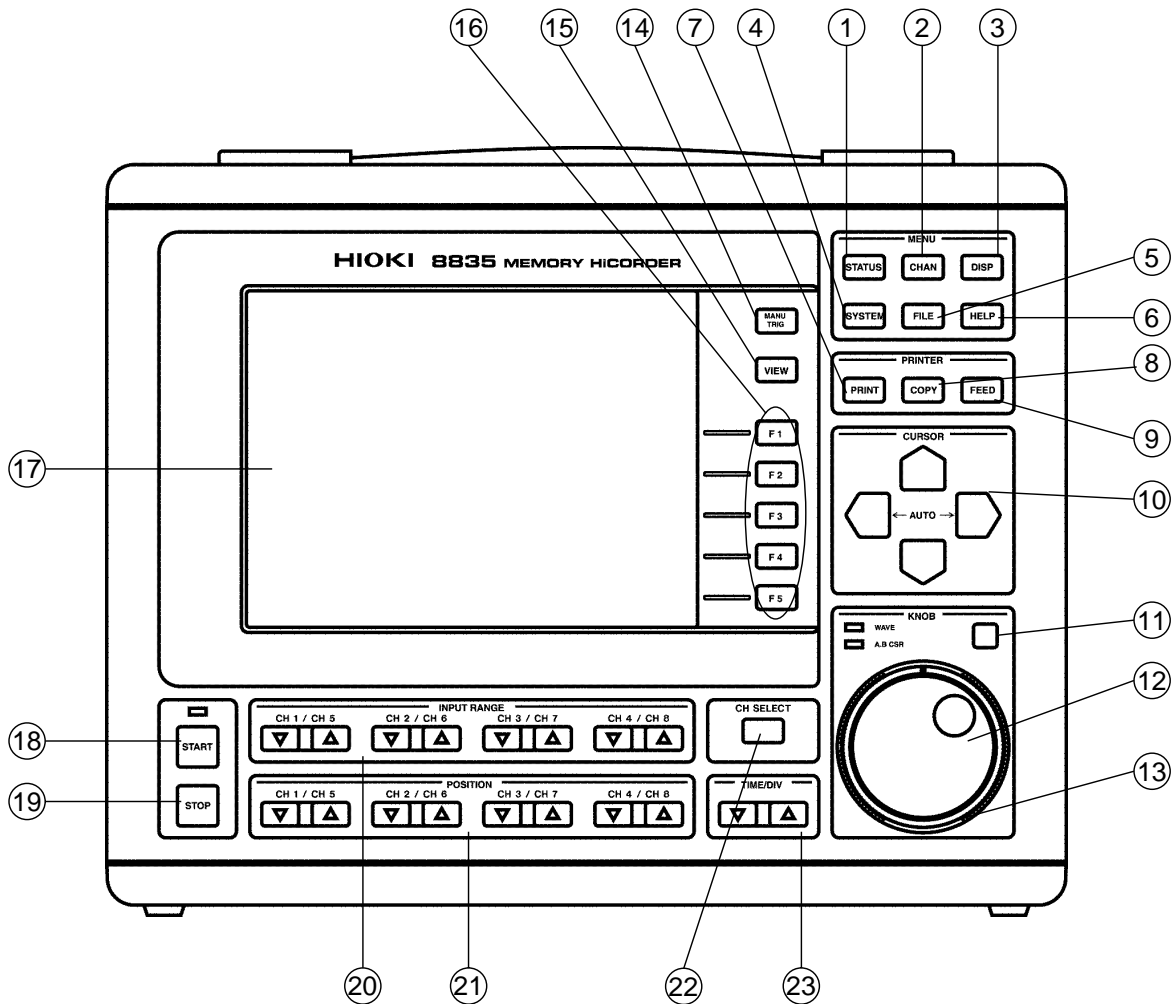

Front panel

- |   |        |     |   |
|---|--------|-----|---|
| ① | STATUS | key | Causes the display to show the STATUS screen which serves for setting most measurement parameters.                          |
| ② | CHAN   | key | Causes the display to show the CHANNEL screen which serves for making input channel settings.                               |
| ③ | DISP   | key | Causes the display to show measurement and analysis results.  |
| ④ | SYSTEM | key | Causes the display to show the SYSTEM screen which serves for making system-wide settings such as for the scaling function. |
| ⑤ | FILE   | key | Causes the display to show the FILE screen which serves for reading, storing, etc. the waveform data etc.                   |

- |   |                 |      |  |                                |
|---|-----------------|------|--|--------------------------------|
| ⑥ | HELP            | key  | Provides on-line help.   |                                |
| ⑦ | PRINT           | key  | Serves to print out stored waveforms.  |                                |
| ⑧ | COPY            | key  | Serves to print out a hard copy of the current screen display.   |                                |
| ⑨ | FEED            | key  | Causes the printer paper to advance for as long as the key is pressed.   |                                |
| ⑩ | CURSOR keys     |      | These keys serve to move the flashing cursor in the four directions.<br>Open auto range function.  |                                |
| ⑪ | Select key      |      | Selects the function that is controlled by the JOG/SHUTTLE knob. With each push of the key, the functions is toggled between WAVE and A.B CSR. The respective LED lights up. |                                |
| ⑫ | JOG key         |      | Rotary control knob that serves to change values, move the A/B cursors, and scroll the waveform.   |                                |
| ⑬ | SHUTTLE key     |      | Concentric ring that serves to move the A/B cursors, and to scroll the waveform. The speed of movement is proportional to the rotation angle.                                |                                |
| ⑭ | MANU TRIG       | key  | Serves to cause manual triggering.   |                                |
| ⑮ | VIEW            | key  | Serves to indicate the position of the currently displayed screen information in relation to the entire recording length.  |                                |
| ⑯ | F1              | - F5 | keys   | Serve to select setting items. |
| ⑰ | LCD screen      |      |  |                                |
| ⑱ | START           | key  | Initiates the measurement and analysis. During measurement, the LED above the key is lit.  |                                |
| ⑲ | STOP            | key  | Stops measurement and analysis.  |                                |
| ⑳ | INPUT RANGE key |      | Serves to set the voltage axis range for each channel.   |                                |
| ㉑ | POSITION key    |      | Serves to set the zero position for each channel.  |                                |
| ㉒ | CH SELECT key   |      | Switches selected channel window.  |                                |
| ㉓ | TIME/DIV key    |      | Serves to set the speed for inputting and storing the input signal.  |                                |

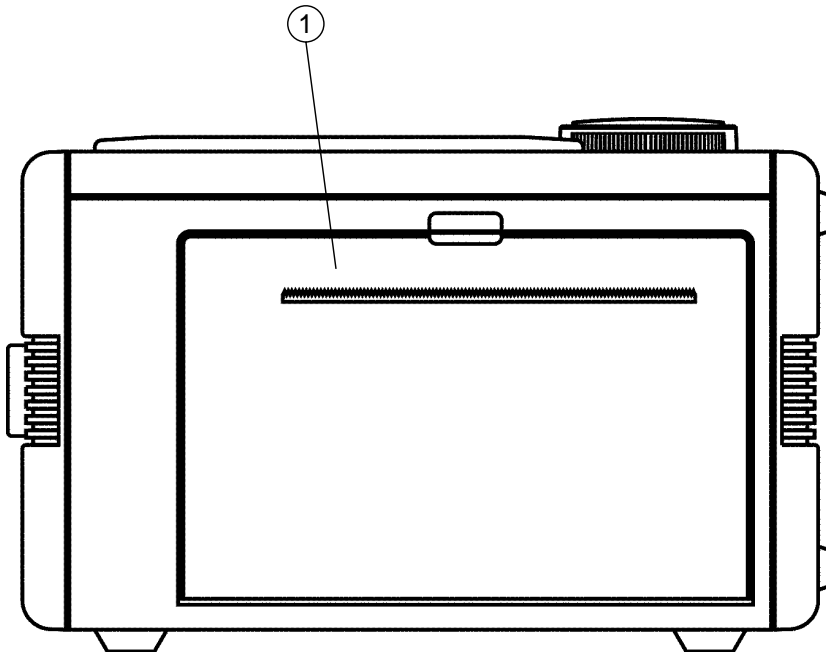

Left side view

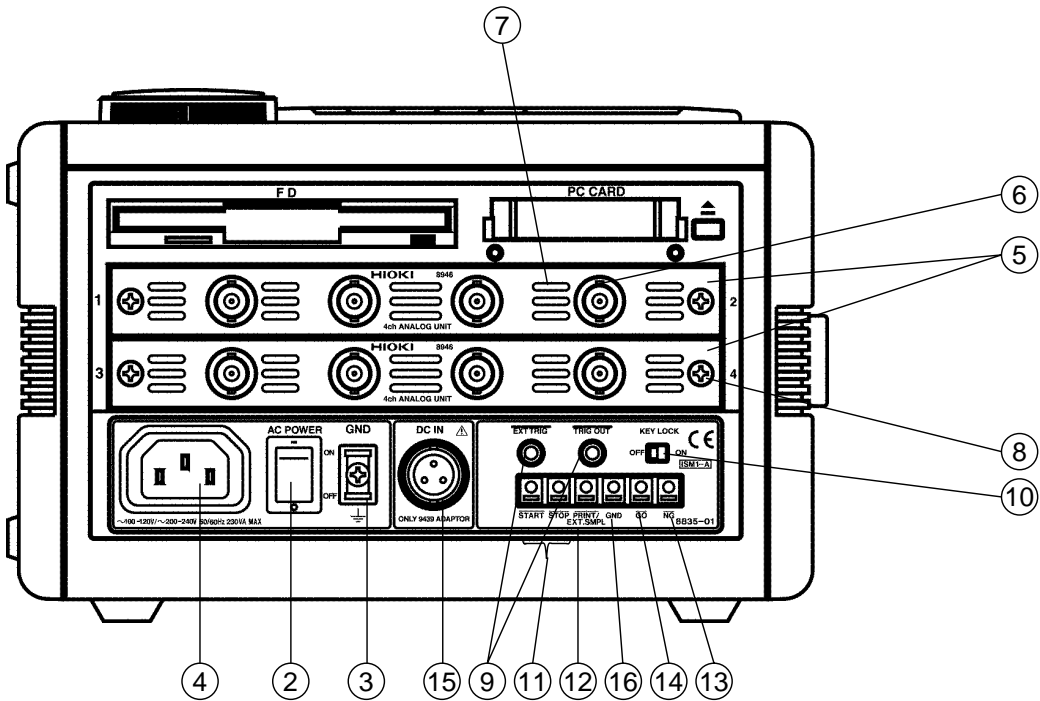

Right side view

1.3 Identification of Controls and Indicators

- ① Printer
- ② AC POWER switch      Serves to turn the unit on and off.
- ③ Functional ground terminal (GND)      Connects to the earth.
- ④ AC connector      The supplied power cord must be plugged in here.
- ⑤ Input unit slots      These slots accept input units.
- ⑥ Analog input connector (on ANALOG UNIT) Unbalanced analog input
- ⑦ Ventilation slots
- ⑧ Fastening screw      Secures the plug-in unit.
- ⑨ Trigger connectors      Can be used to synchronize multiple units, using the EXT TRIG input and TRIG OUT output.
- ⑩ KEY LOCK switch      When this switch is set to ON, all keys of the 8835-01 are inactive. The key lock condition is maintained also when the power is switched off and on again.
- ⑪ External start/stop terminals      Start and stop operation can be controlled via external signals.
- ⑫ External print/sampling terminal      Controls printing or sampling via external signals. Switches automatically with time axis range settings.
- ⑬ NG evaluation output terminal      When the waveform evaluation based on waveform parameters has resulted in NG, a signal is output from this terminal.
- ⑭ GO evaluation output terminal      When the waveform evaluation based on waveform parameters has resulted in GO, a signal is output from this terminal.
- ⑮ DC power supply connector      Allows use of an external DC source to power the unit (with dedicated DC POWER ADAPTER).
- ⑯ Ground terminal (GND)      Common GND (③ Function ground terminal) with the 8835-01. Use with ⑪ to ⑭ terminals.

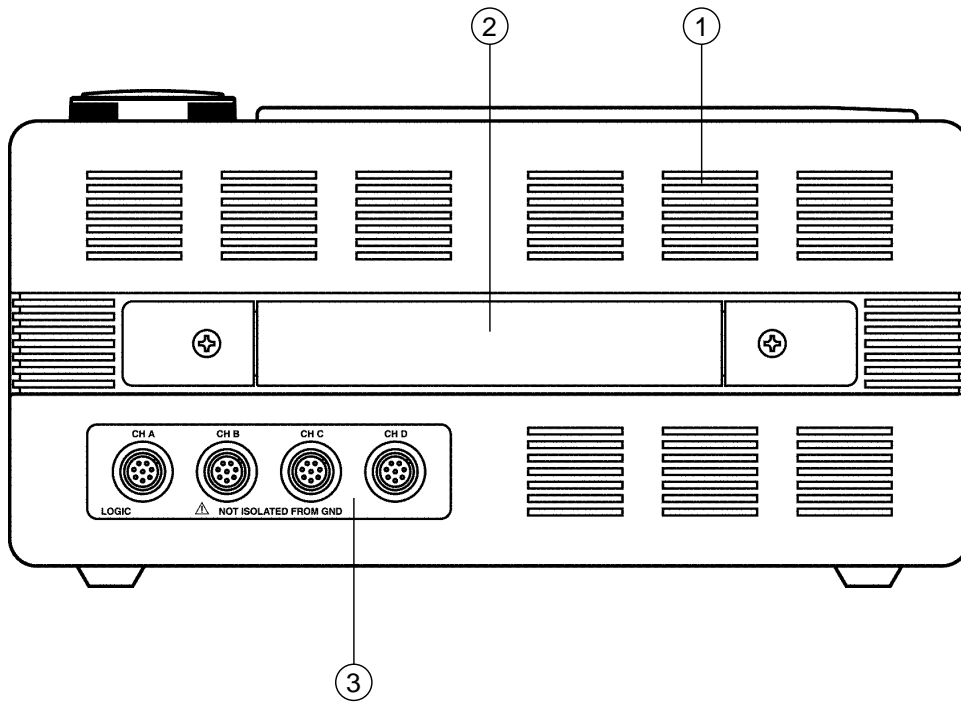

Top view

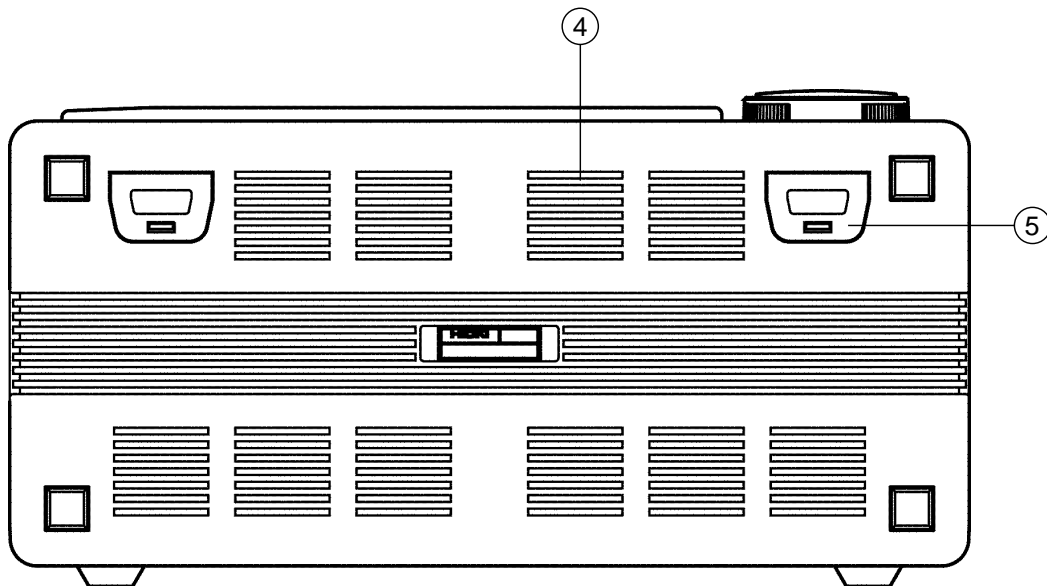

Bottom view

- ① Ventilation slots
- ② Handle Serves for transporting the 8835-01.
- ③ Logic probe connectors Input connector for the logic input section, designed for the dedicate logic probes (CH A, CH B, CH C, CH D).
- ④ Ventilation slots
- ⑤ Tilt support

### 1.3 Identification of Controls and Indicators



---

# Chapter 2

## Installation and Preparation

---

2

## 2.1 Installation of the Unit

### Installation orientation

Install the unit on a flat, level surface.

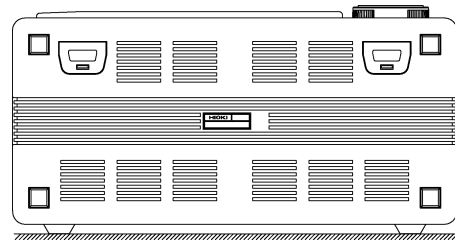
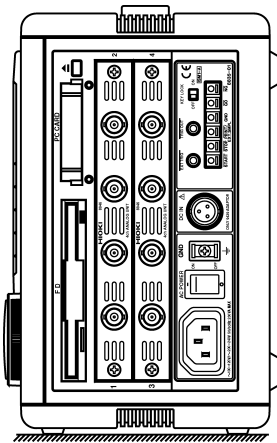
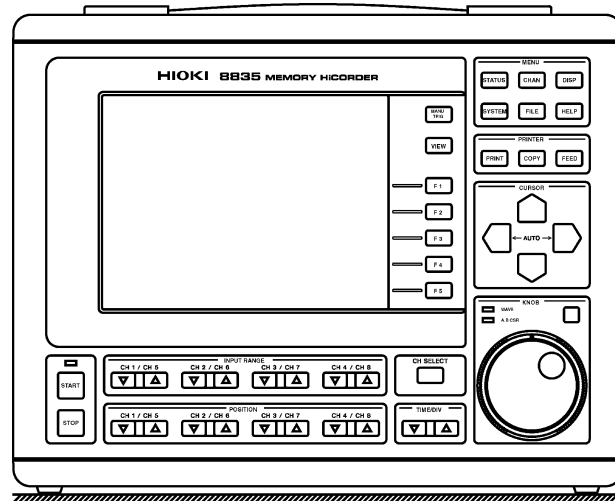

The unit can also be propped up at an angle, using the stand.

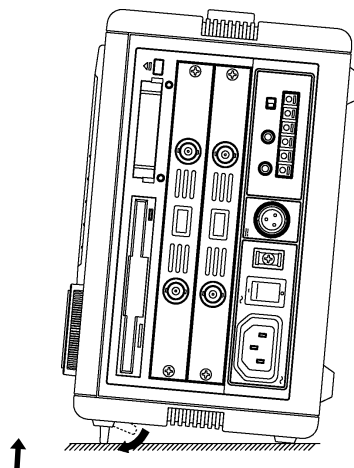

## Ambient conditions

Temperature	5 to 40 , 23 ± 5 recommended for high-precision measurements
Humidity	35 to 80%RH (no condensation); 50 ± 10%RH (no condensation) recommended for high-precision measurements
Ventilation	Take care not to block the ventilation openings and assure proper ventilation. When using the unit in an upright position, take care not to block the openings on the bottom, as it could overheat and be damaged, or cause a fire.

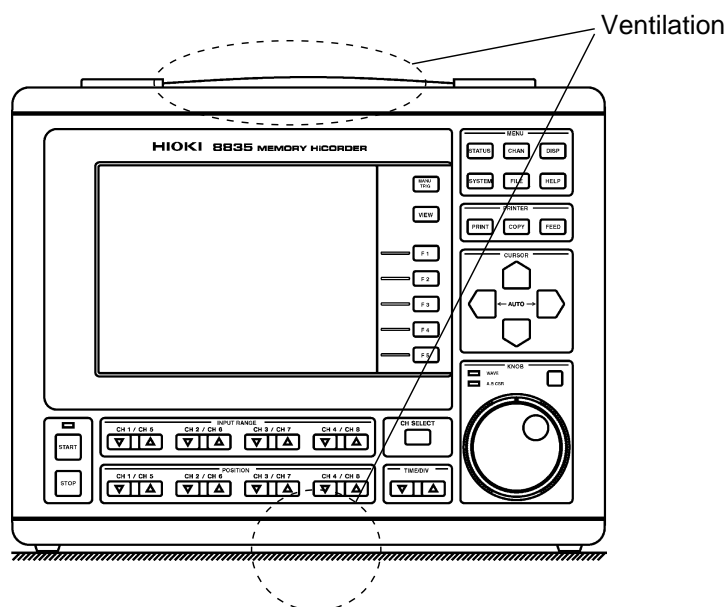

### NOTE

Avoid the following locations:

- Subject to direct sunlight
- Subject to high levels of dust, steam, or corrosive gases  
(Avoid using the equipment in an environment containing corrosive gases (e.g., H<sub>2</sub>S, SO<sub>2</sub>, NI<sub>2</sub>, and Cl<sub>2</sub>) or substances that generate harmful gasses (e.g., organic silicones, cyanides, and formalins)).
- Subject to vibrations
- In the vicinity of equipment generating strong electromagnetic fields

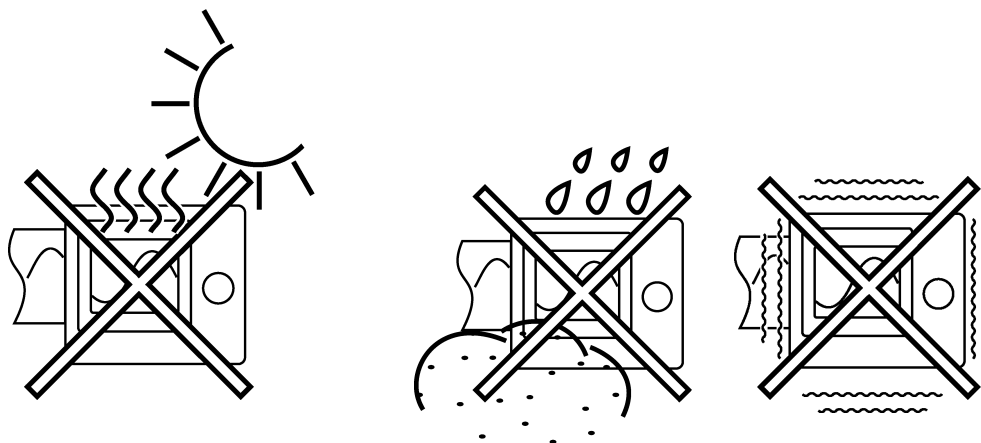

## 2.2 Power Supply and Ground Connection

**WARNING**

Take care never to exceed the power supply ratings given below, to avoid the risk of electric shock and damage to the unit.

**NOTE**

The fuse is incorporated in power supply. It is not user-replaceable. If a problem is found, contact your dealer or HIOKI representative.

### Power supply, fuse

Rated power supply voltage	100 to 120 V AC / 200 to 240 V AC (auto-switching) (Voltage fluctuations of 10% from the rated supply voltage are taken into account.)
Rated AC power supply frequency	50/60 Hz
Fuses	AC incorporated in power supply (not user-replaceable)

### Grounding

**WARNING**

The 8835-01 has no protective ground terminal, but is intended to be connected to a ground wire via the grounded three-core power cord supplied. To avoid electric shock and ensure safe operation, connect the power cable to a grounded (3-contact) outlet.

- When the AC outlet is of the grounded three-pin type:  
Use the grounded three-core power cord supplied. The unit will be grounded automatically.
- When the AC outlet is not of the grounded three-pin type:  
Use the ground adapter supplied. In this case, be absolutely sure to connect the green ground wire which protrudes from the adapter to a ground line, and connect the power cord supplied.

### Check the following points before connecting the unit to a power supply:

- The power supply matches the ratings shown above.
- The AC power switch of the 8835-01 and the switch of the 9439 DC POWER ADAPTER are set to OFF.
- Use only the supplied AC power cord.

## Connecting the unit to a power supply and grounding it:

(1) AC power supply

**2**

**WARNING**

**Make sure that the AC power switch of the 8835-01 is set to OFF.**

1. Verify that the AC power switch of the 8845 is set to OFF.
2. Plug the grounded three-core power cord supplied into the AC power connector on the right side of the 8835-01.
3. Plug the power cord into an AC outlet corresponding to the rating of the 8835-01.

Rated voltage:

100 - 120 V AC / 200 - 240 V AC

Rated line frequency:

50/60 Hz

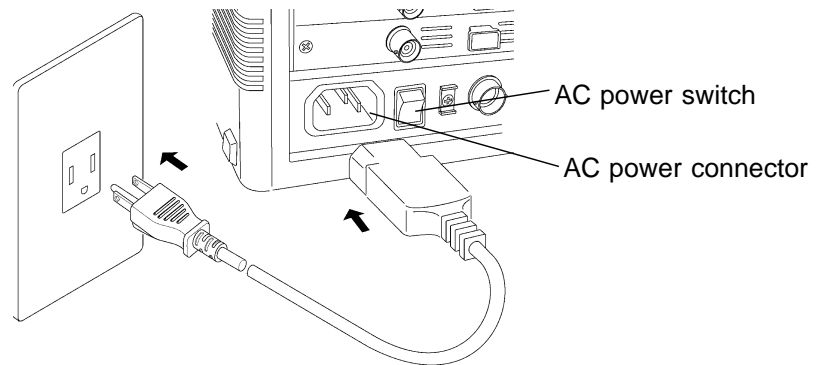



## (2) DC power supply

**⚠ DANGER**

Before connecting the unit to a battery or other DC source, make sure that the switch of the 9439 DC POWER ADAPTER is set to OFF. If the switch is ON, there is a risk of sparks, and the unit may be damaged.

**⚠ WARNING**

- Before making connections, make sure the 9439 DC POWER ADAPTER is turned off. The 8835-01 could be damaged by a spark if it is connected to a voltage source while its power supply is on.
- The rated supply voltage of the 9439 DC POWER ADAPTER is 10 to 28 VDC. If an attempt is made to use an improper supply voltage, there is danger of damage to this unit and of life-threatening risk to the operator.
- The 9439 DC POWER ADAPTER is a power supply and therefore generates heat. Do not place any object on this equipment nor force it in to a narrow area for operation.
- When connecting the input cable of the 9439 DC POWER ADAPTER, take care not to mix up the red (+) and black (-) leads. If polarity is reversed, the 9439 may be damaged.
- When wishing to extend DC cable, use a cable of identical or better rating as the input cable.
- The 9439 DC POWER ADAPTER is an option specifically designed for the MEMORY HiCORDER 8835-01. Do not connect this adapter to any other products.
- The switch on the 9439 DC POWER ADAPTER doubles as the breaker. Accordingly, ensure that there is ample space to operate the switch.

1. Verify that the switch of the 9439 DC POWER ADAPTER is set to OFF.
2. Align the ridge of the connector on the unit with the groove in the plug, insert the plug fully and rotate it to fix it firmly.
3. Connect the red input cable to the positive side (+) and the black input cable to the negative side (-) of the power supply.
4. The red LED lights while the unit is operating (outputting).
5. To remove the plug of the DC cable, rotate it as shown in the illustration.

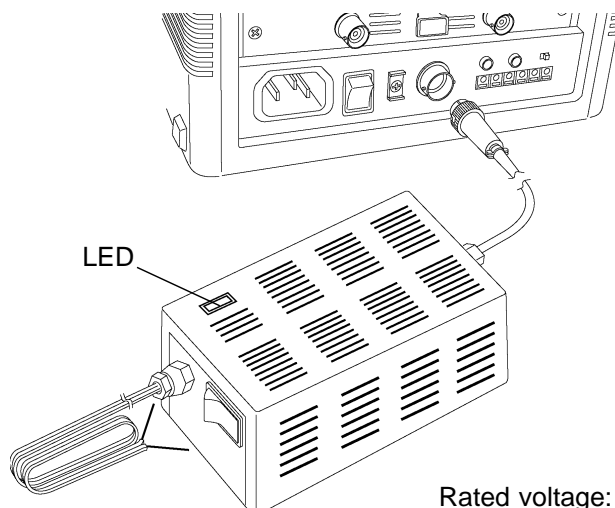

Rated voltage: 10 to 28 V DC

**NOTE**

- This unit is not equipped to charge an external battery.
- When using a battery, take care not to deplete it completely.
- When an overcurrent or overvoltage is detected in the output, this equipment cuts off the output. In such an event, turn off the 9439 DC POWER ADAPTER, wait for approximately one minute, and then turn the adapter on again.
- If an overcurrent flows through the input cord for any reason, this equipment is automatically turned off to stop operation.
- Estimated battery operation hours (at room temperature)  
Battery type: 12 V, 38 Ah, fully charged  
PC card not installed

Operation condition	8936 installed in 4 channels	8940 installed in 4 channels	8940 2 ch current testing
Printer not used (trigger waiting)	Approx. 12 h	Approx. 6 h	Approx. 8 h
Printer used Recorder function 500 ms/DIV, all store	Approx. 5 h	—	Approx. 4 h

Actual running time may differ, depending on battery age, charge condition, ambient temperature, and other factors.

- Input cable specifications  
Permissible current: 15 A

### Functional ground terminal

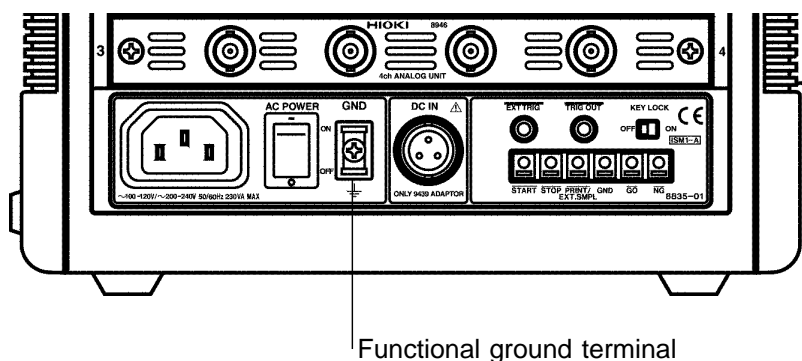

When measuring in a "noisy" environment, noiseproofing can be improved by grounding the functional ground terminal.

## 2.3 Power On/Off

(1) Check before power-on

- Unit is correctly installed ( [☞](#) Section 2.1).
- Power cord is correctly connected and unit is properly grounded ( [☞](#) Section 2.2).

(2) Power switch on/off

- There is no need for the user to manually select AC or DC power.
- When both AC and DC power are connected, AC power has priority.
- When AC power is disconnected (or falls under 90 V), the 8835-01 automatically switches to DC. (If the switch of the 9439 is set to ON, the 8835-01 automatically switches to DC even if AC power is disconnected.)

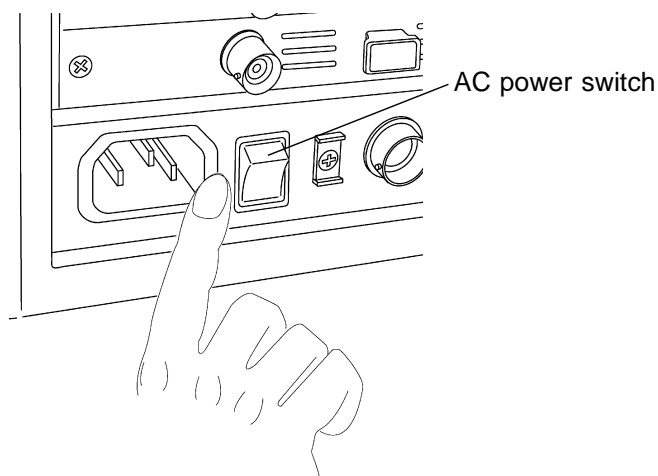

(3) To assure high measurement precision

Turn the unit on and let it warm up for about 30 minutes, to allow internal temperature to fully stabilize. Then carry out zero adjustment (see Section 7.3.7) and start the measurement.

(4) Power-off

When the unit is turned off, it memorizes the currently used settings and reestablishes the same settings the next time the unit is turned on again.



## 2.4 Probe Connection

### 2.4.1 8936 ANALOG UNIT, 8938 FFT ANALOG UNIT and 8946 4 ch ANALOG UNIT

#### ⚠ WARNING

- Never connect the probe to the 8835-01 while the probe is already connected to the measurement object. Otherwise there is a risk of electric shock.
- Use only the specified connection cables. An insulated BNC connector is used for the specified connection cables to prevent electric shock. If a metal BNC connector is used, electric shock may result, as the input L-terminal and the metal part of the BNC connector will have the same potential.

#### ⚠ CAUTION

When disconnecting the BNC connector, be sure to release the lock before pulling off the connector. Forcibly pulling the connector without releasing the lock, or pulling on the cable, can damage the connector.

#### NOTE

Use only the specified connection cables. Using a non-specified cable may result in incorrect measurements due to poor connection or other reasons. In addition, the BNC connector may be damaged.

For analog input connection, use optional 9197, 9198 CONNECTION CORDs. Use of any other cables may result in risk of electric shock.

For connecting 8946, use 9198 CONNECTION CORD.

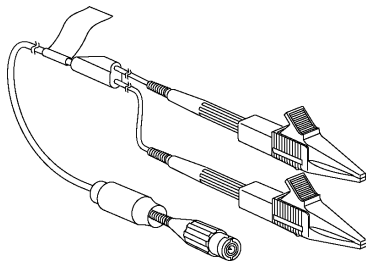

9197 CONNECTION CORD  
(Maximum input voltage: 500 V)

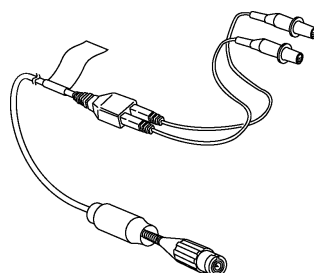

9198 CONNECTION CORD  
(Maximum input voltage: 300 V)

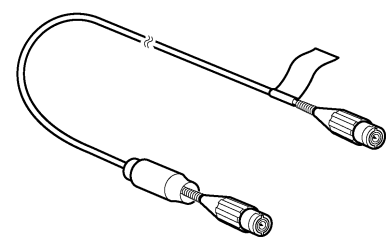

9217 CONNECTION CORD  
(Maximum input voltage: 300 V)

#### Connecting to the main unit

1. Align the BNC connector with the guide groove of the unit input connector, and turn clockwise while pressing in to lock the connector.
2. To remove from the unit, turn the BNC connector counterclockwise to release the lock, then pull it.

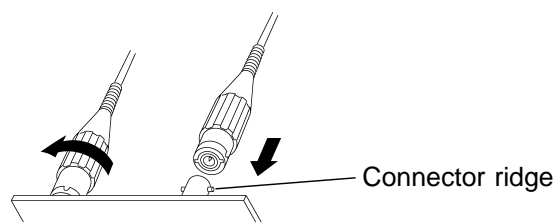

## Setting Channels in 8946 4 ch ANALOG UNIT

When using 8946 4 ch ANALOG UNIT, input channels are not numbered in numeric order as 1,2,3,4. Channel number is determined by connection to units. (See below.) To verify position of channels, see Channel Guide.

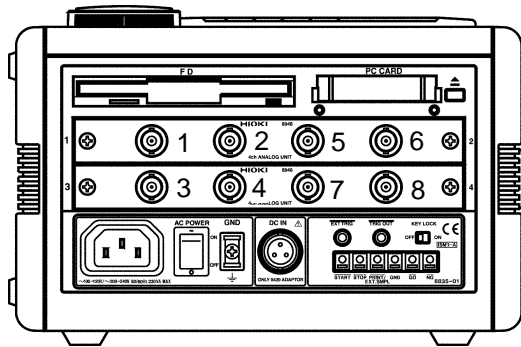

## 2.4.2 8937 VOLTAGE/TEMP UNIT

### WARNING

- Never connect the connection cable to the 8835-01 while the connection cable is already connected to the measurement object. Otherwise there is a risk of electric shock.
- A common GND is used for voltage and temperature input on all channels. Never input voltage and temperature simultaneously, since doing so could result in damage to the sample being tested.
- When an uninsulated thermocouple is used to measure temperature at a point carrying electric potential, take care not to touch the terminals. Otherwise there is a risk of electric shock.
- The voltage and temperature input and the 8835-01 frame are insulated.

### CAUTION

- When disconnecting the BNC connector, be sure to release the lock before pulling off the connector. Forcibly pulling the connector without releasing the lock, or pulling on the cable, can damage the connector.
- Use a screwdriver or similar to attach and remove the thermocouple.

### Connection cable connection (Voltage measurement)

For measuring voltage with 8937, use 9198 CONNECTION CORD.

1. Align the BNC connector with the guide groove of the unit input connector, and turn clockwise while pressing in to lock the connector.
2. To remove from the unit, turn the BNC connector counterclockwise to release the lock, then pull it.

## Thermocouple connection (Temperature measurement)

1. Strip off the insulation as shown in the illustration.

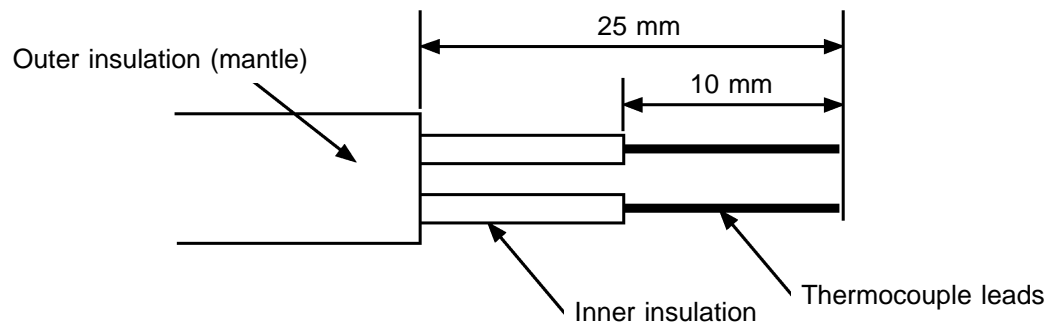

2. Push the tab with a screwdriver or similar.
3. While keeping the tab depressed, insert a stripped thermocouple into the connector openings.
4. Release the tab to lock the thermocouple.
5. While keeping the tab depressed, remove the thermocouple.

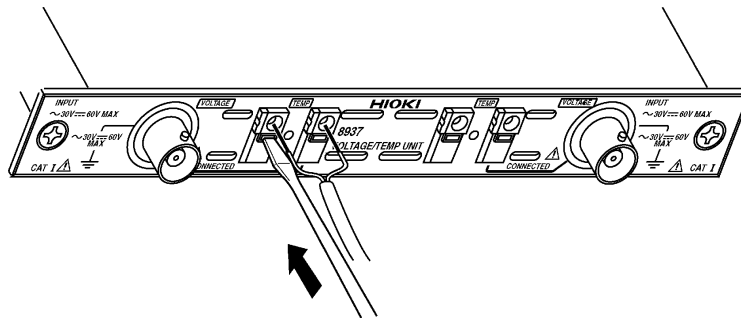

### NOTE

- The press-button type terminal board of the 8937 VOLTAGE/TEMP UNIT is only for connection to a thermocouple. Do not use thermocouples other than the specified types (K, J, E, T, N, R, S, B).
- If the thermocouple is connected in reverse, the temperature reading will not be correct.
- If the temperature input terminal is exposed to a strong draft, loss of thermal equilibrium at the input may result in measurement error. When taking measurements under such conditions, arrange the unit in such a manner that the input terminal is protected for direct exposure to drafts.
- If ambient temperature changes suddenly, loss of thermal equilibrium can result in measurement error. When this occurs, allow the unit to acclimate to the new temperature for about one hour, then take measurements after thermal equilibrium is reached.

### 2.4.3 8939 STRAIN UNIT

#### CAUTION

- Connect only the sensor to the conversion cable supplied with the 8939 STRAIN UNIT.
- To disconnect the conversion cable, always unlock the plug and pull out the cable.

#### Connecting to the main unit

1. Align the projection on the unit connector with the cutout on the conversion cable, and insert the plug into the connector.
2. Turn the fixing guide (the colored area in the figure below) so that it engages with the connector guides on the unit, fully insert the fixing guide, and turn it clockwise to lock the plug.
3. To remove the conversion cable from the unit, turn the fixing guide (the colored area in the figure below) counterclockwise to unlock the plug, and pull out the plug.

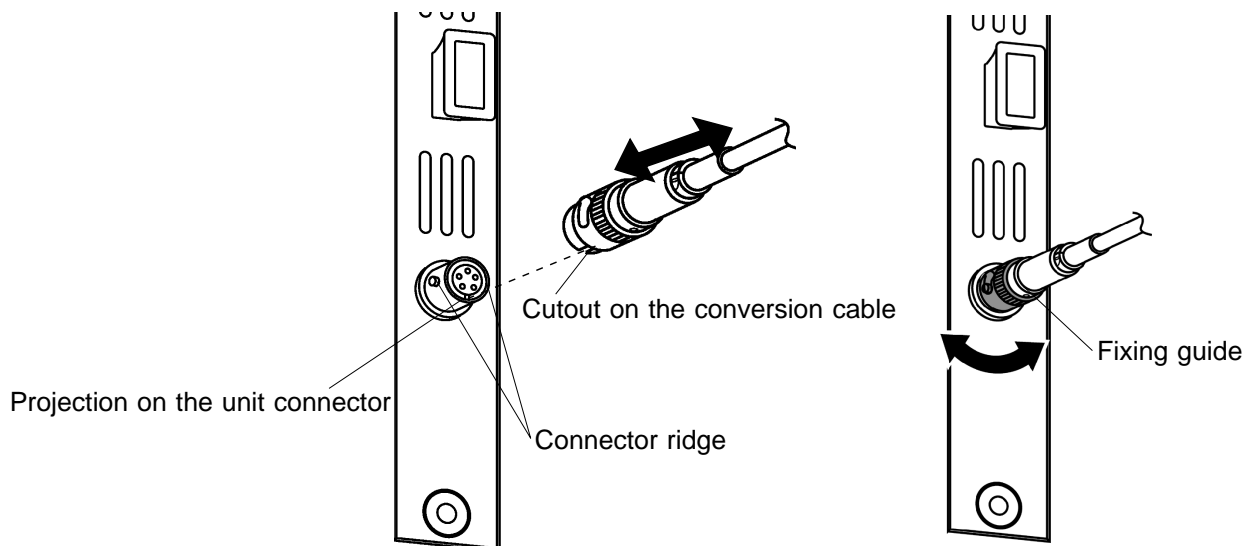

#### Connector

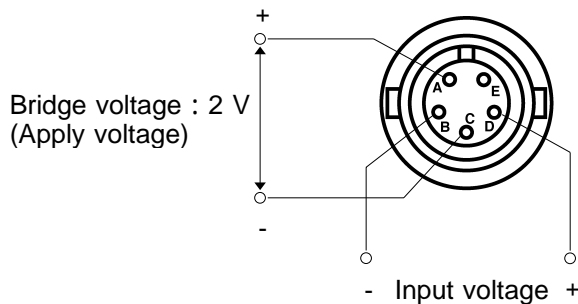

## 2.4.4 8940 F/V UNIT

### **⚠ DANGER**

- To avoid electrical accidents, make sure that the MEMORY HiCORDER and the equipment being measured are powered off before making connections. Do not make connections with the power turned on.
- When using the 9318 or 9319 CONVERSION CABLE, there is no isolation between GND the MEMORY HiCORDER and GND of the clamp on sensor/probe. Exercise extreme care in connection to avoid possible damage to the equipment or personal injury.
- When connecting 8940 F/V UNIT to 3273 or 3273-50, and conductors being measured carry in excess of the safe voltage level (SELV-E) and not more than 300 V, to prevent short circuits and electric shock while the core section is open, make sure that conductors to be measured are insulated with material conforming to (1) Overvoltage Category I, (2) Double Insulation (Reinforced insulation) Requirements for Working Voltage of 300 V, and (3) Pollution Degree 2. For safeties sake, never use this sensor on bare conductors. The core and shield case are not insulated.
- When connecting 8940 F/V UNIT to 3273 or 3273-50, do not damage insulation sheathing on testing device.
- Refer to the following standards regarding the meanings of underlined terms. IEC 61010-1, IEC 61010-2-031, IEC 61010-2-032

### **⚠ WARNING**

When using the clamp-on sensor or clamp-on probe, be sure to use the optional 9318 or 9319 CONVERSION CABLE.

### **⚠ CAUTION**

- When disconnecting the BNC connector, be sure to release the lock before pulling off the connector. Forcibly pulling the connector without releasing the lock, or pulling on the cable, can damage the connector.
- When using the Model 3273-50 with the 8940, bear in mind that the maximum input of the 3273-50 is 15 Arms. Exceeding this measurement level could damage the instrument.

### Connection cable connection (Frequency, count, pulse duty ratio and voltage measurement)

Groove of the BNC

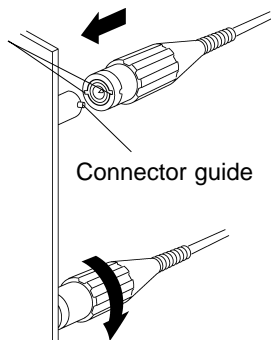

Use the optional 9198 CONNECTION CORD for connection to the F/V UNIT.

1. Align the BNC connector with the guide groove of the 8826 input connector, and turn clockwise while pressing in to lock the connector.
2. To remove from the unit, turn the BNC connector counterclockwise to release the lock, then pull it.

### Clamp connection (Current measurement)

The following clamp-on sensors and clamp-on probes can be connected using the 9318 and 9319 CONVERSION CORDs.

9318 : 9270, 9271, 9272, 9277, 9278, 9279, 9319 : 3273

## Connecting to 9318 CONVERSION CABLE

1. Align the groove on the conversion cable plug with the sensor connector on the F/V unit and push inward until the connector locks into place.
2. Align the groove on the conversion cable connector with the adapted clamp on sensor plug and push inward until the connector locks into place.
3. To unplug the cables, slide the lock ring on each plug outward to unlock it, then pull out the plug. When disconnecting the connector and the plug, hold the connector or the plug, and pull carefully. Pulling on the cable instead of the connector or the plug may damage the connector and cable.

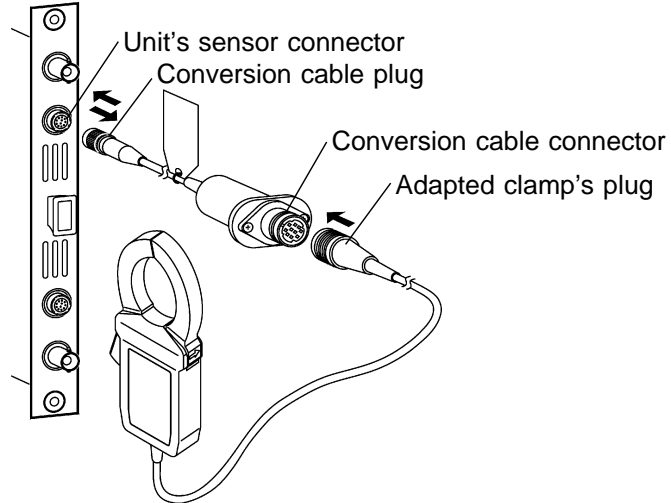

## Connecting to 9319 CONVERSION CABLE

1. Align the groove on the 3273 or 3273-50<sup>\*1</sup> CLAMP ON PROBE's termination connector with the pin on the BNC connector on the F/V unit, then slide the termination connector over the BNC connector and turn to lock it in place.
2. Align the groove on the conversion cable plug with the sensor connector on the F/V unit and push inward until the connector locks into place.
3. To unplug the cables, unlock the conversion cable connector and the power plug on the 3273 or 3273-50<sup>\*1</sup> before unplugging the cable.
4. Slide the lock ring on each plug outward to unlock it, then pull out the plug. When disconnecting the connector and the plug, hold the connector or the plug, and pull carefully. Pulling on the cable instead of the connector or the plug may damage the connector and cable.

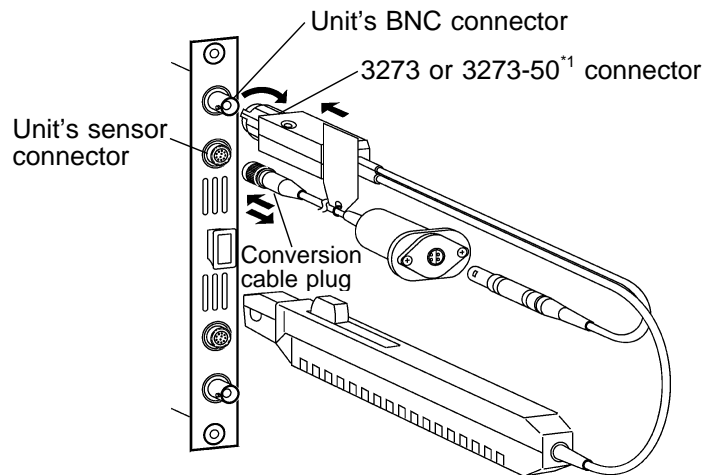

\*1: When using the Model 3273-50 with the 8940, bear in mind that the maximum input of the 3273-50 is 15 Arms.

## 2.4.5 8947 CHARGE UNIT

### ⚠ WARNING

- **DO NOT** connect connection cable to the 8947 CHARGE UNIT when connected to measuring unit to avoid risk of electric shock.
- BNC terminal and miniature connector terminal of each channel share same GND. Do not connect both at once.
- During measuring with measurement mode set to PREAMP or when level monitor function is in use, electric current (2 mA, +15 V) output is active. In order to avoid risk of electric shock and damage to testing device, examine channel mode for connecting sensor and probe to BNC terminal and either cancel PREAMP or shut down power.
- Voltage measurement and internal acceleration pick up sensor share same terminal. Make sure to check measurement mode before measuring.
- Before using internal acceleration pickup sensor, verify that sensor ratings is compatible with 8947 CHARGE UNIT rated output (2 mA, +15 V). Use of Non compatible sensor may cause damage to sensor.

### Connection cable connection (Preamp and voltage measurement)

In preamp mode when connecting unit with pick-up sensor, match BNC cable to BNC connector.

1. Align the BNC connector with the guide groove of the unit input connector, and turn clockwise while pressing in to lock the connector. (For connecting 8947, use 9198 CONNECTION CORD.)
2. To remove from the unit, turn the BNC connector counterclockwise to release the lock, then pull it.

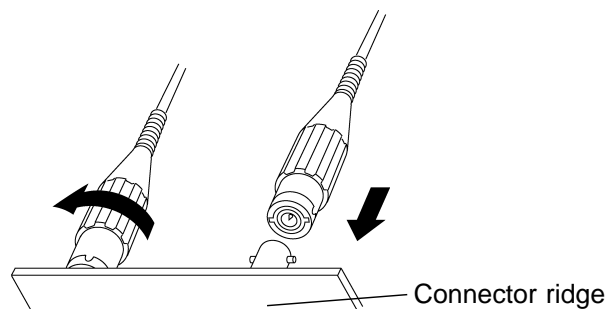

### Miniature connector connection (Charge mode)

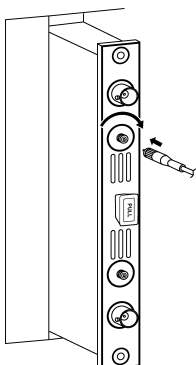

For charge testing when connecting unit with pick-up sensor, match cable connector to miniature connector. (miniature connector terminal 10-32)

1. Plug miniature connector cable into the cable connector on the unit.  
Tighten the connector by turning clockwise.
2. To remove connector, turn the connector counterclockwise.

## 2.5 Logic Probe Connection

### **⚠ DANGER**

- Logic probe input and 8835-01 share the same GND. Separate power supply sources applied to the testing device and 8835-01 may result in risk of electric shock and damage to the unit.

Even with the same power supply source, certain ways of wiring may cause a variance in electric potential sending current that may damage testing device and 8835-01. The following shows proper wiring to avoid damage.

- (1) Before connecting logic probe to testing device, connect grounded three-core power cord (attachment) to the device to be tested and 8835-01 and supply power from the same outlet (see fig. 1).
- (2) Before connecting logic probe to device to be tested, connect GND of device to be tested with 8835-01 functional ground terminal (see fig. 2). Make sure that power is supplied from the same outlet. For the functional ground terminal, see Section 2.2.

Fig. 1

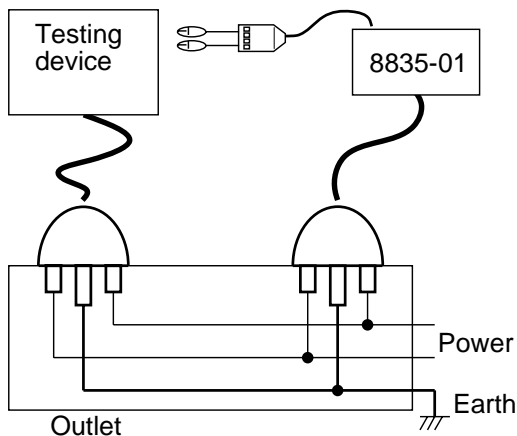
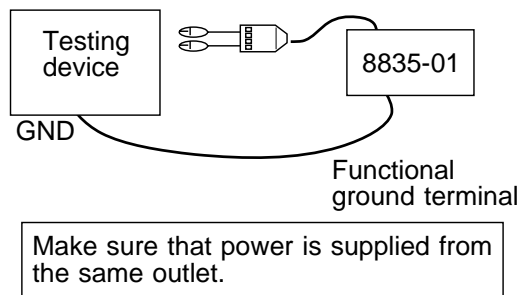
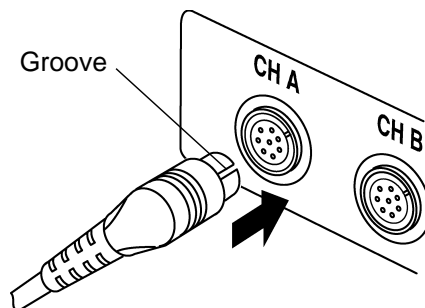

Fig. 2



### Connecting to the main unit

Connect the probe by aligning the groove on the plug with the ridge on the connector.



#### NOTE

- If no logic probe is connected, the corresponding logic waveform is displayed on the screen at high level.
- For the 9320 and 9321 LOGIC PROBES, carefully read the documentations supplied with them.
- Do not connect logic probes other than supplied by HIOKI to the logic inputs.



## 2.6 9322 DIFFERENTIAL PROBE Connection

### **⚠ DANGER**

- When using grabber clips, the 9322's maximum rated voltage to earth is 1500 VAC/DC; when using alligator clips, it is 1000 V AC/DC. To avoid electrical shock and possible damage to the unit, never apply voltages greater than these limits between the input channel terminals and chassis, or across the inputs of two 9322s.
- Maximum input voltage is 1000 VAC/2000 VDC. Do not measure voltage in excess of these limitations, as doing so may damage the unit or cause an accident that might result in injury or death.

9322 is a differential probe that connects to input of 8835-01 MEMORY HiCORDER input unit. For more details, refer to its instruction manual.

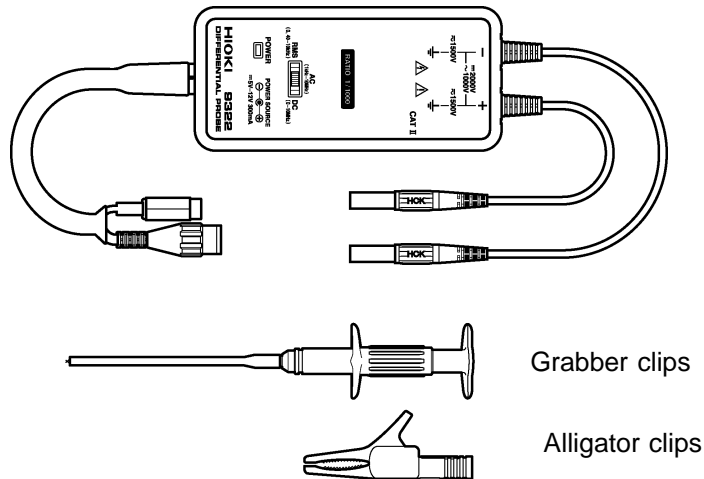

## 2.7 Loading Recoding Paper

1. Press the stock cover and open it.

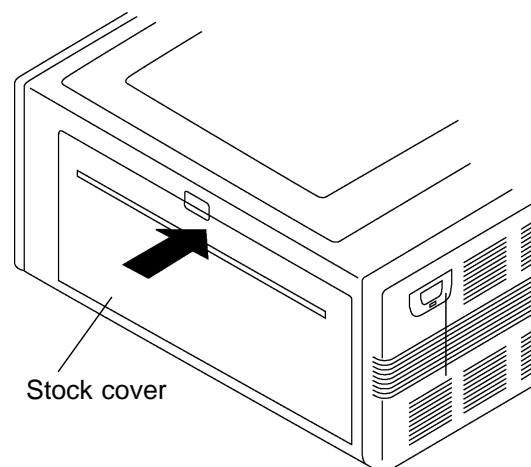

2. Raise the head up/down lever.

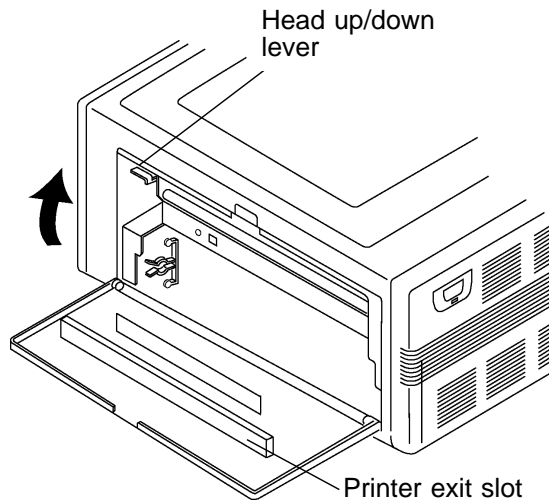

3. Insert the attachments into the ends of the roll of recording paper and set the paper into its holder.

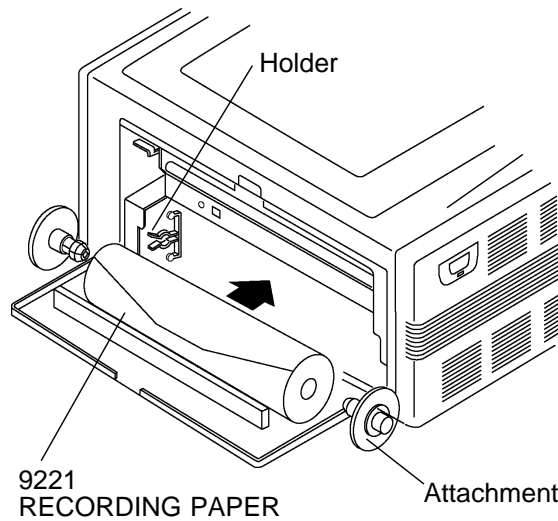

4. Insert the leading edge of the recording paper from above into the gap behind the printer roller, and pull it out to the other side.

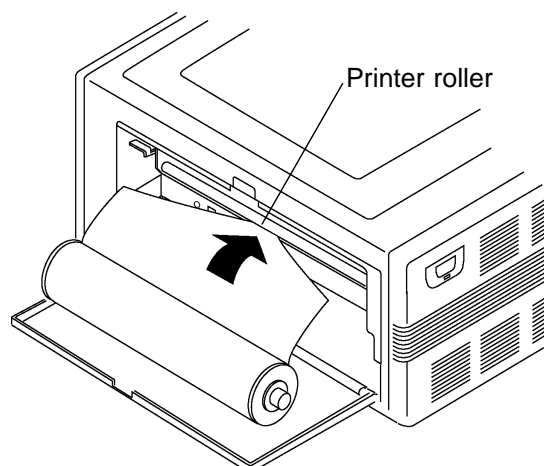

5. Pull the end of the recording paper out at least 10 cm, and make sure that it is positioned quite straight.  
6. Put down the head up/down lever.

7. Pull the recording paper to the outside through the printer exit slot in the stock cover.

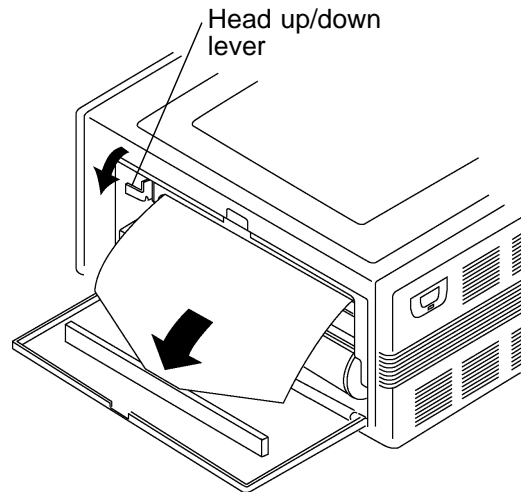

8. Close the stock cover, and finish by tearing off the recording paper against the edge of the printer exit slot.

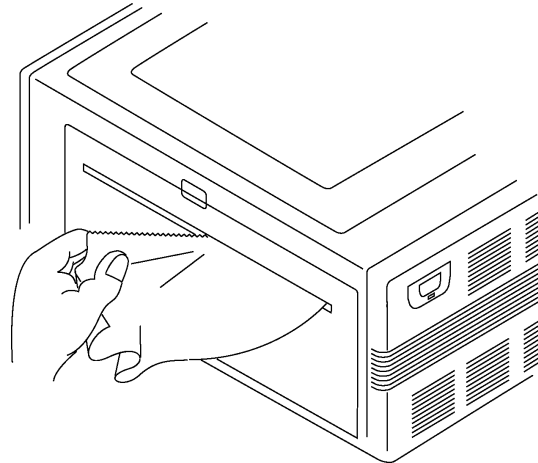

**NOTE**

- Always put the unit in the head up condition when it is to be transported or if it is to be stored for a long period of time. If the unit is left to lie in the state where the roller is being subjected to pressure by the head, then the roller may become deformed or the characters may become uneven.
- Particularly care should be taken not to put the recording paper in back to front by mistake, because if this happens the waveform cannot be drawn.
- Printing is not possible if the recording paper is loaded wrong-side up.
- Do not insert it into the gap between the roller and the black sheet metal portion.
- Refer to the illustration to make sure that the correct side of the recording paper is facing up.
- Do this very carefully, because if the recording paper is slanted with respect to the roller there is a danger that later a paper jam will occur.

---

## 2.8 Storage and Handling Precautions

Store rolls of thermal paper at no more than 40 °C.

The paper will change color if exposed to light over a long period, so do not unwrap a roll of paper until you are ready to use it.

### Storing data recordings

As the recording paper is thermally sensitive, be aware of the following points:

- To avoid paper discoloration, do not expose it to direct sunlight, and store at no more than 40 °C and 90% RH.
- For permanent storage of important recorded data, photocopy the recording paper.
- If the thermal paper is exposed to an organic solvent such as alcohol or ketone, it may no longer develop properly, and recorded data may fade.
- Also, the thermal recording paper is ruined by contact with wet Daizo copy paper.

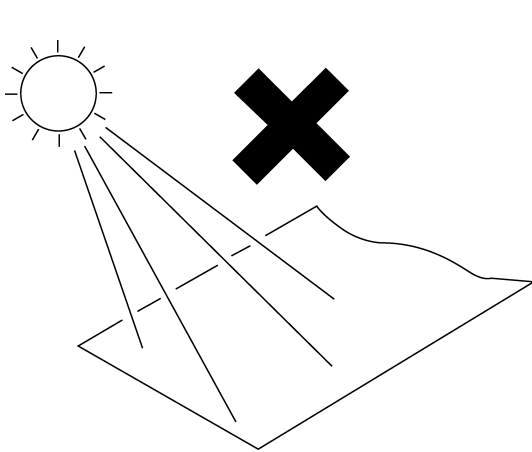

Direct sunlight

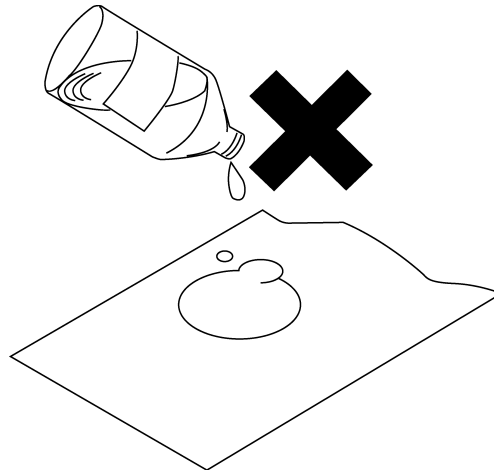

Organic solvent



## 2.9 Notes on Measurement

### **⚠ DANGER**

- Maximum input voltage ratings for the 8936 ANALOG UNIT, 8937 VOLTAGE/TEMP UNIT, 8938 FFT ANALOG UNIT, 8939 STRAIN UNIT 8940 F/V UNIT, 8946 4ch ANALOG UNIT, 8947 CHARGE UNIT and input terminals of the 8835-01 are shown below. To avoid the risk of electric shock and damage to the unit, take care not to exceed these ratings.
- The maximum rated voltage to earth of the 8936, 8937, 8938, 8939, 8940, 8946 and 8947 (voltage between input terminals and 8835-01 frame ground, and between inputs of other input units) is shown below. To avoid the risk of electric shock and damage to the unit, take care that voltage between channels and between a channel and ground does not exceed these ratings.
- The maximum rated voltage to earth rating applies also if an input attenuator or similar is used. Ensure that voltage does not exceed these ratings.
- When measuring power line voltages, 8936 or 8938 should only be connected to the secondary side of a breaker, so the breaker can prevent an accident if a short circuit occurs. Connections should never be made to the primary side of a breaker, because unrestricted current flow could cause a serious accident if a short circuit occurs.

Input/output terminal	Maximum input voltage	Maximum rated voltage to earth
8936 inputs	400 VDC max.	370 V AC/DC
8937 inputs	30 V rms or 60 VDC	30 V rms or 60 VDC
8938 inputs	400 VDC max.	370 V AC/DC
8939 inputs	10 VDC max.	30 Vrms or 60 VDC
8940 inputs	30 V rms or 60 VDC (BNC and sensor connector terminals)	30 V rms or 60 VDC (BNC terminal) Not insulated (Sensor connector terminal)
8946 inputs	30 V rms or 60 VDC	30 V rms or 60 VDC
8947 inputs	30 V rms or 60 VDC	30 V rms or 60 VDC
EXT TRIG	-5 to +10 VDC	Not insulated
START/STOP		
PRINT/EXT SMPL		
TRIG OUT	-20 V to +30 VDC 100 mA max. 200 mW max.	
GO		
NG		

- The external I/O terminal and the 8835-01 have a common GND.

**⚠ DANGER**

- In order to avoid accidents from electric shock, before removing or replacing an input unit, check that the connection cables are disconnected, turn off the power, and remove the power cable.
- Normally keep all input units installed permanently. If a unit is not fitted, it must be replaced by a blanking panel. If the unit is operated with an input unit not in place it poses a shock hazard.
- When using grabber clips, the 9322's maximum rated voltage to earth is 1500 V AC/DC; when using alligator clips, it is 1000 V AC/DC. To avoid electrical shock and possible damage to the unit, never apply voltages greater than these limits between the input channel terminals and chassis, or across the inputs of two 9322s.
- Maximum input voltage is 1000 VAC/2000 VDC. Do not measure voltage in excess of these limitations, as doing so may damage the unit or cause an accident that might result in injury or death.

**⚠ WARNING**

Before using the product, make sure that the insulation on the connection cords is undamaged and that no bare conductors are improperly exposed. Using the product under such conditions could result in electrocution. Replace the connection cords with the specified HIOKI Model 9197 or 9198.

**⚠ CAUTION**

- When making measurements on an AC power line for example, using a voltage transformer, be sure to connect the voltage transformer ground terminal to ground.
- Maximum charge input for miniature connector terminal in 8947 CHARGE UNIT is +, - 500 pC (at range 6 high sensitivity) and +, - 50000 pC (at range 6 low sensitivity).

## 2.9.1 Using a Voltage Transformer

When making measurements on an AC power line for example, using a voltage transformer, be sure to connect the voltage transformer ground terminal to ground.

When the voltage transformer has a ground terminal

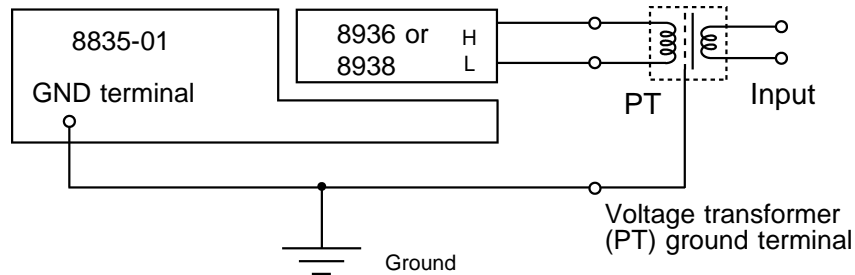

When the voltage transformer has no ground terminal

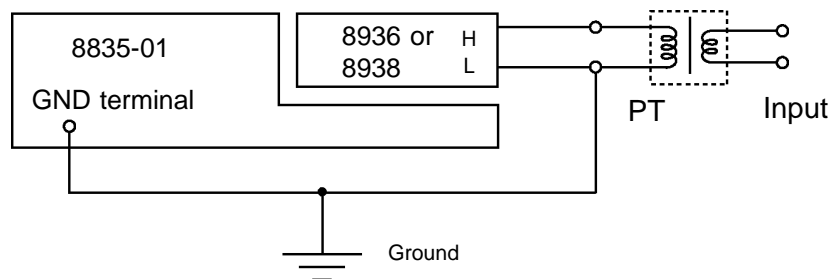

## 2.9.2 Maximum Input Voltage

8936 ANALOG UNIT, 8938 FFT ANALOG UNIT

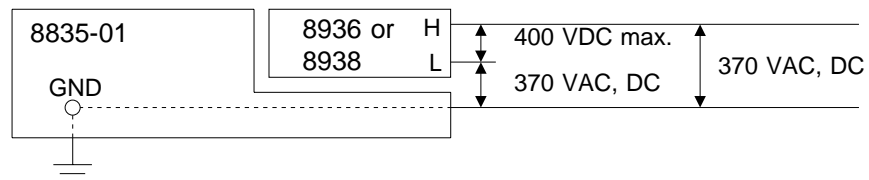

8937 VOLTAGE/TEMP UNIT, 8946 4 ch ANALOG UNIT

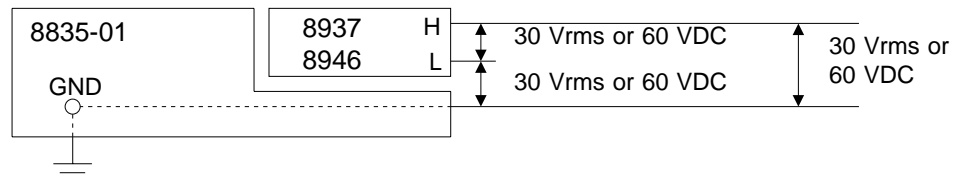

8939 STRAIN UNIT

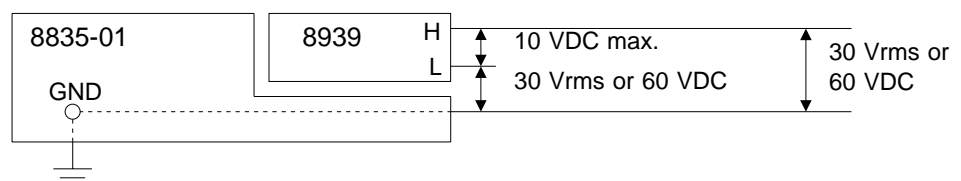

8940 F/V UNIT

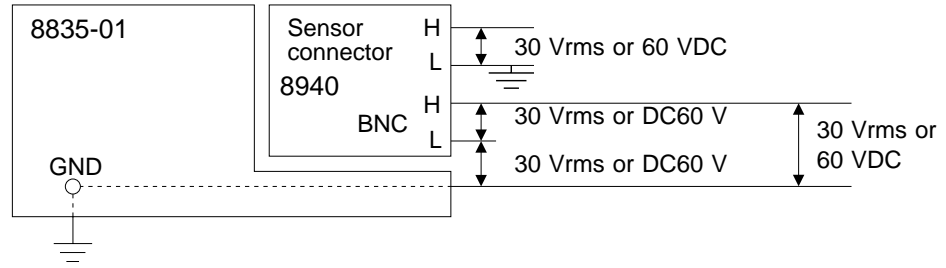

8947 CHARGE UNIT

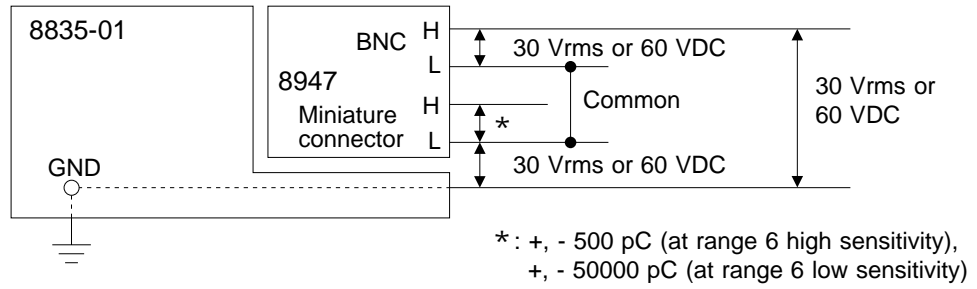

**Difference between "370 V AC, DC" and "400 V DC max." indication**

370 V AC, DC: Rms value is displayed.

400 V DC max.: Instantaneous value is displayed.

The maximum input voltage (400 V DC max.) is defined as the superposition of DC component and AC peak, as shown in the figure below.

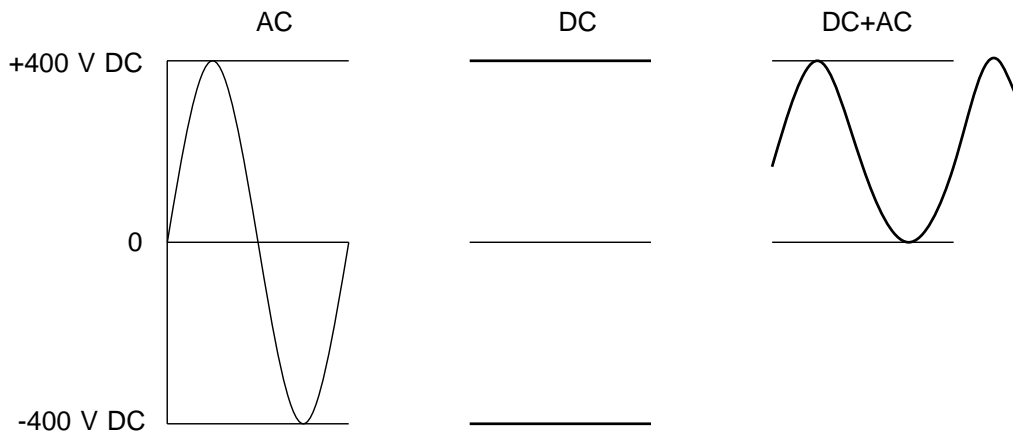



# Chapter 3

## Basic Operation and Measurement

### 3.1 Basic Operation

This section explains basic steps and settings for measurement.

#### 3.1.1 Basic Display Operation

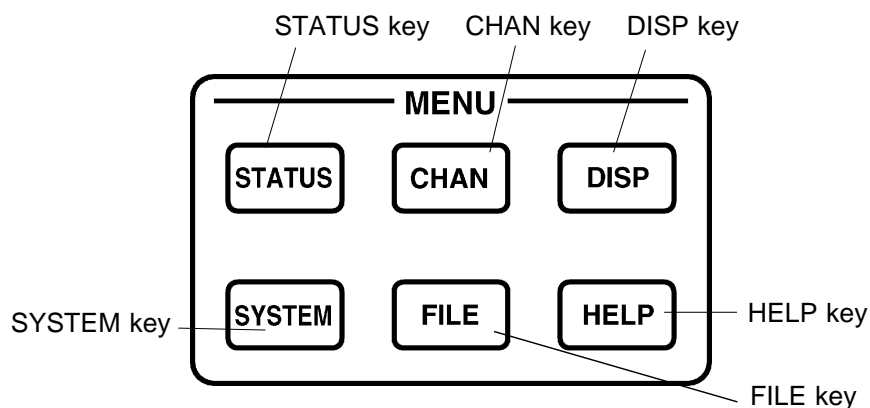

**STATUS** key    Calls up the STATUS screen.  
Serves to switch pages of the STATUS screen.  
Serves to make main settings for various functions on the STATUS screen.

**CHAN** key    Calls up the CHANNEL screen.  
Serves to set voltage axis range, zero position, etc. for input channels.  
Serves to switch pages of the CHANNEL screen.  
Using the variable function, you can adjust size and position of waveform display as desired, even without changing the range or position settings.

**DISP** key    Calls up the display screen.  
Serves to display and observe waveforms.

- SYSTEM** key      Calls up the SYSTEM screen.  
Serves to switch pages of the SYSTEM screen.  
Serves to make common settings for all functions (clock setting, comment input, etc.) on the SYSTEM screen.
- HELP** key      On-line help  
An explanation of the display screen or the item currently selected by the cursor appears.
- FILE** key      Calls up the FILE screen.  
Serves to read and store waveform data on the FILE screen.
- 

### 3.1.2 Setting Items

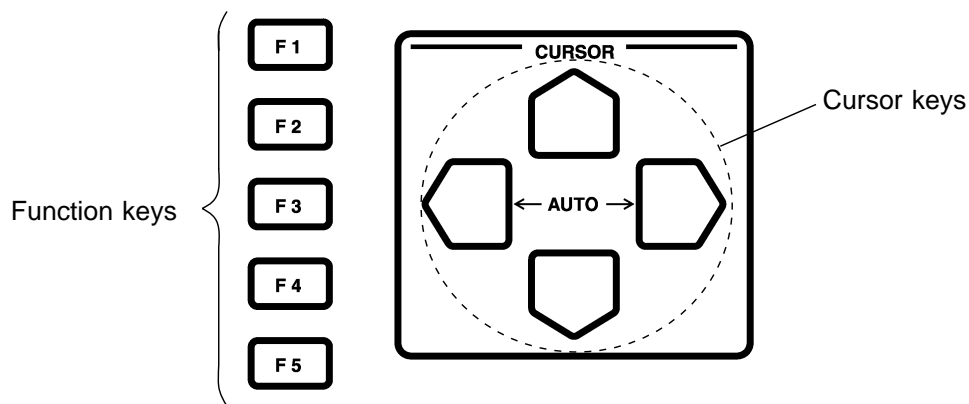

- CURSOR** keys      Serve to move the flashing cursor.  
Pressing the  $\leftarrow$  and  $\rightarrow$  keys simultaneously opens auto range function screen. (Memory recorder)
- F1** to **F5**  
(Function key)      Select items.  
The respective items are shown in the function key display.

### 3.1.3 JOG/SHUTTLE Control and Select Key

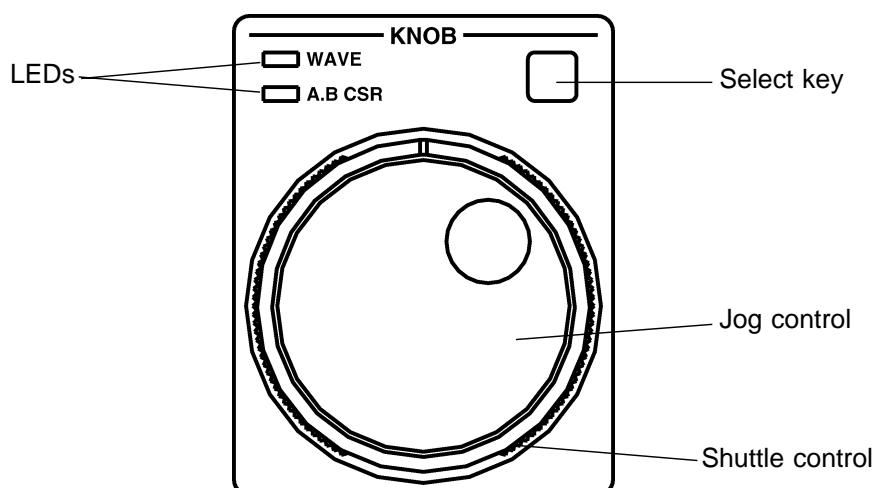

#### Entering numbers and setting items (except on the DISPLAY screen)

	Function key display ( GUI )		
1		Value up	Move the flashing item selection cursor up in the selection window.
		Value down	Move the flashing item selection cursor down in the selection window.
2		Value up, large step	Value up, 10-units
		Value up, small step	Value up, 1-units
		Value down, small step	Value down, 1-units
		Value down, large step	Value down, 10-units

#### Scroll waveform, move A/B cursors

JOG/SHUTTLE control can be used to scroll the waveform and to move the A and B cursors (for details, refer to Chapter 11).

#### Switch between waveform scroll and cursor movement

Use the select key when the screen is in measurement display mode.

Lit LED	JOG/SHUTTLE control function
<b>WAVE</b>	Waveform scrolling
<b>A.B CSR</b>	Movement of A/B cursors

### 3.1.4 Measurement Start and End

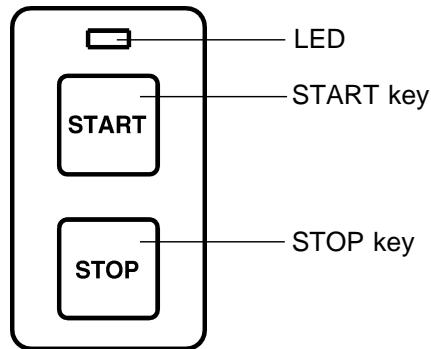

#### Measure

Press the  key and the LED lights.

#### Stop measurement

Press the  key and the LED goes out after measurement has finished.

### 3.1.5 Basic Input Operation

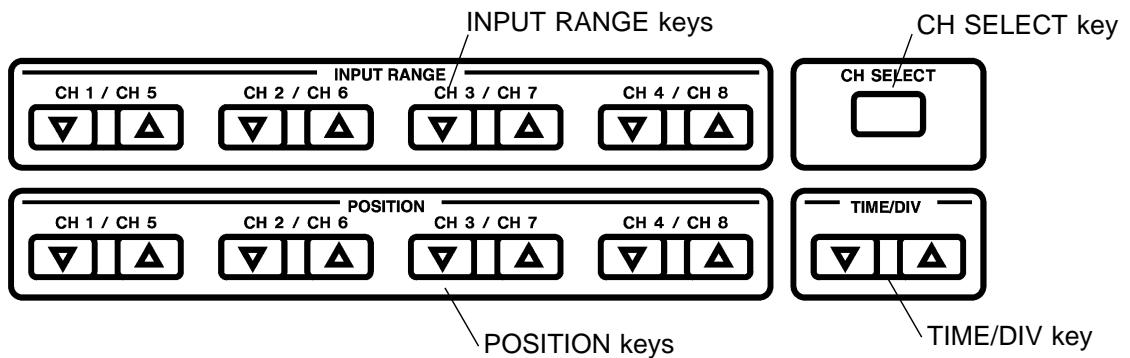

key

Serves to set the voltage axis range for each channel.

key

Serves to set the zero position for each channel.

key

Serves to set selected channel window.

key

Serves to set the input signal capture speed (how many seconds, minutes, hours for 1 DIV on the time axis).

### 3.1.6 Printer Key Operation

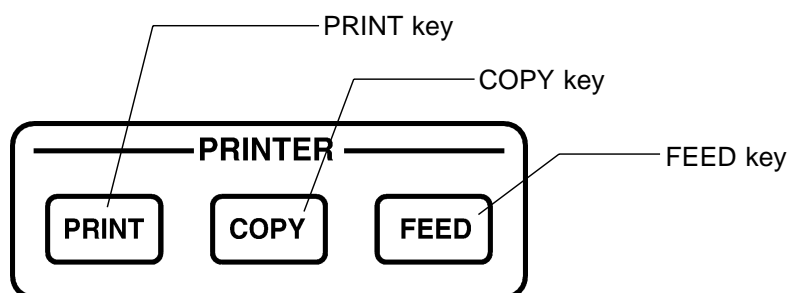

**PRINT** key

Serves to print the waveform. The output destination by this key can be selected.

**COPY** key

Produces a hard copy of the display content. The output destination by this key can be selected.

**FEED** key

Forwards the paper while the key is held down.

### 3.1.7 Other Keys Operation

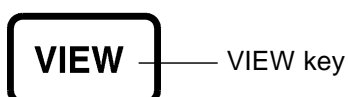
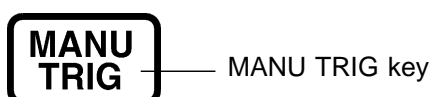

**MANU TRIG** key

When the unit is in trigger standby mode, pressing this key causes manual triggering.

Refer to Section 8.10.

**VIEW** key

#### 1. Horizontal scroll bar

Pressing this key on the display screen shows at the bottom of the screen the position with respect to the recording length of the displayed part of the waveform. The positions of the trigger and the A and B cursors (vertical or trace), if they are being used, are also shown.

[ When the recording length is 100 divisions ]

• Time axis magnification ratio:  $\times 1$

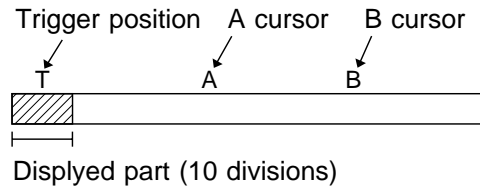

• Time axis magnification ratio:  $\times 2$

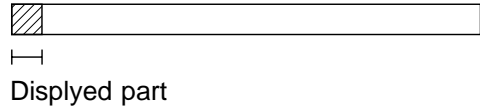

• Time axis magnification ratio:  $\times 1/2$

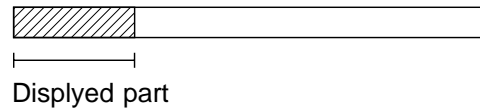

Shifting the display position

The new waveform display position can be specified, and the waveform can be shifted.

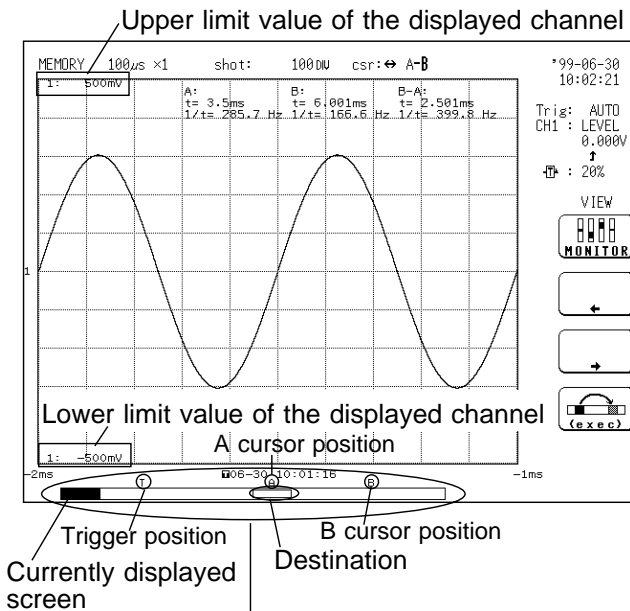

- : Displays the level monitor (see Section 7.11).
- : Shifts the destination to the left.
- : Shifts the destination to the right.
- : Executes the dislocation.

**NOTE**

- Dislocation can be specified for the following eight sections of the record.
  1. Front sections of four equally divided sections of the record
  2. End section of record
  3. A and B cursor positions
  4. Trigger position
- If the recording length is equal to or less than four times the width of the waveform display screen, the dislocation function is not enabled.
- You can escape from the position display or level monitor display by pressing the **VIEW** key. Since the last mode is stored in memory, the mode can be recalled by pressing the **VIEW** key again. (When you have escaped from the level monitor display by pressing the **VIEW** key, when the key is pressed again, the level monitor display reappears.)

## 2. Back Space

Back Space is used for backspacing when comments are input.

## 3. Channel guide

Indicates channels for specific position of input units (see Section 7.14).

## 4. List print

Prints file list displayed on the file screen to output destination designated by **PRINT** key (see Section 9.6.2).

## NOTE

- When using the memory segmentation function in the enhanced version (see Section 1.2), the **F5** key switches between the Position and Block displays.
- The Position display is not available with the FFT function (enhanced version).

3

## 3.1.8 On-line Help

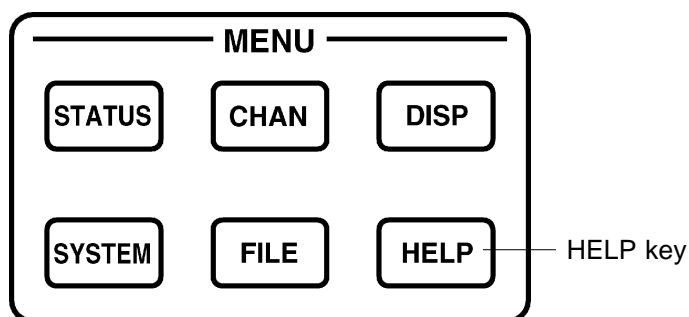

HELP display

A brief explanation of the item currently selected by the flashing cursor is displayed by pressing the **HELP** key

Turn off the HELP display

Press any key to cancel the help screen.

## Example

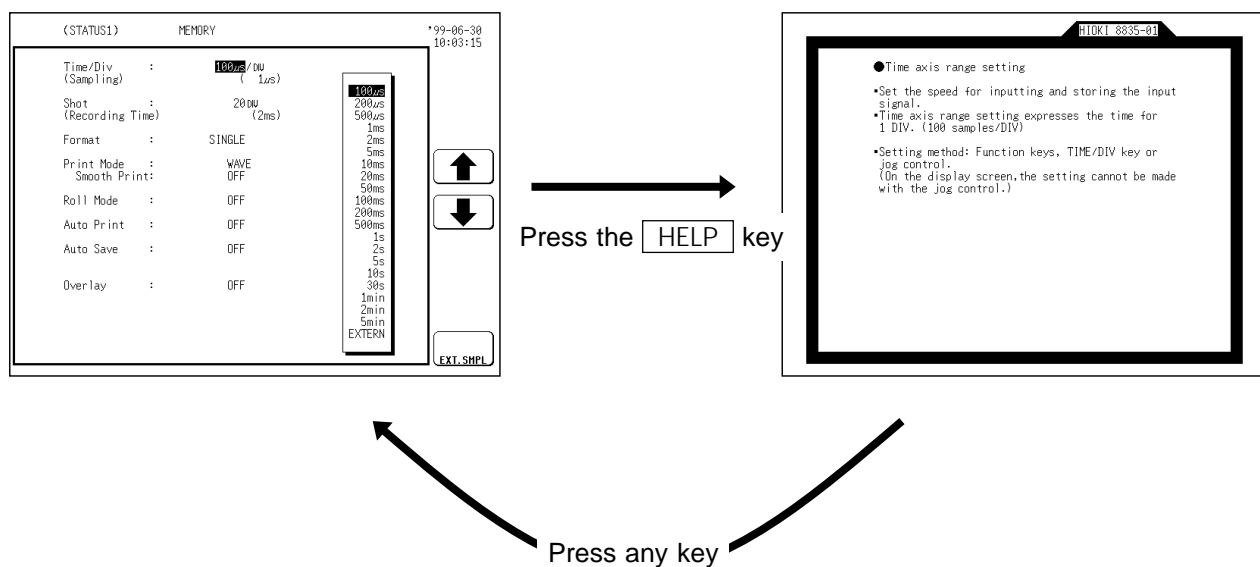

## 3.2 Basic Measurement and Setting Procedures

This section uses some representative examples to describe basic measurement steps and settings.

### 3.2.1 Basic Operation Flow

The basic operation flow is shown below.

Panel key	Setting screen	Setting item	Description	
STATUS	Status 1	Time axis Recording length Format Printer format etc.	Sets data capture conditions (see chapters on various functions).	Various settings
	Status 2	Trigger mode Pre-trigger Trigger source External trigger Analog trigger Logic trigger Timer trigger etc.	Sets the triggers (see Chapter 8).	
CHAN	Channel	Voltage axis range Input coupling Low pass filter etc.	Sets the voltage axis range, input coupling, and filter (see chapters on various functions).	

Panel key	Setting screen	Setting item	Description	
START			Starts data capture.	Waveform data capture

Panel key	Setting screen	Setting item	Description	
SELECT key	Display	Cursor type Cursor movement etc.	Uses the cursor to read measurement values (see Chapter 11).	Viewing/ storing waveform data
DISP	Display	Select waveform Magnification ratio along the vertical/ horizontal axis etc.	Sets the magnification ratio for waveform data (see chapters on various functions).	
FILE	FD, PC card	Store file type Store range Comment etc.	Stores waveform data (see Chapter 13).	



## 3.2.2 Measuring and Recording a Voltage (Memory Recorder Function)

**Example** A 2 V<sub>p-p</sub> 1 kHz sine wave input is measured.

(1) Input connection

Connect a signal generator to the 8835-01.

(2) Set the signal generator so that it outputs a 2 V<sub>p-p</sub> 1 kHz sine wave.

(3) Settings on the STATUS 1 screen

Make the following settings with the CURSOR keys and function keys.

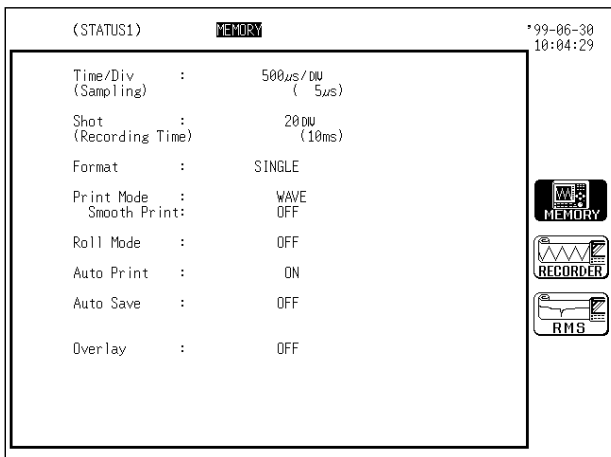

time/div: 500  $\mu$  s/DIV

shot: 20 DIV

format: SINGLE

print mode: WAVE

smooth print: OFF

roll mode: OFF

auto print: ON

auto save: OFF

overlay: OFF

(4) Settings on the STATUS 2 screen

Make the following settings with the CURSOR keys and function keys.

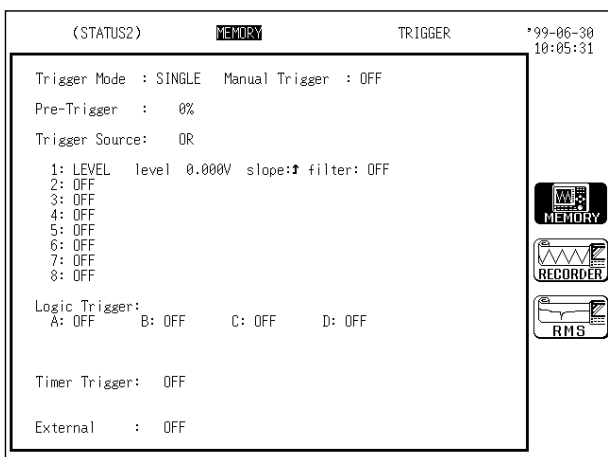

trigger mode: SINGLE

pre-trigger: 0%

trigger source: OR

manual trigger: OFF

analog trigger: level trigger

trigger level: 0.000 V

trigger direction (slope): rising

trigger filter: OFF

Logic Trigger: OFF

timer trigger: OFF

external trigger: OFF

(5) Settings on the CHANNEL 1 screen

Make the following settings with the CURSOR keys and function keys.

Ch	Draw	Unit	Range	Zoom (Lower ~ Upper)	Zero Pos. ~	Filter
1	■	ANALOG	500 mV 500mV/DIV	× 1 (-2.5 V ~ 2.5 V)	50%	OFF
2	--	ANALOG	20 mV 20mV/DIV	× 1 (-100mV ~ 100mV)	50%	OFF
3	--	ANALOG	20 mV 20mV/DIV	× 1 (-100mV ~ 100mV)	50%	OFF
4	--	ANALOG	20 mV 20mV/DIV	× 1 (-100mV ~ 100mV)	50%	OFF

  

chA	POS:1	chB	POS:2	chC	POS:3	chD	POS:4
1	--	1	--	1	--	1	--
2	--	2	--	2	--	2	--
3	--	3	--	3	--	3	--
4	--	4	--	4	--	4	--

range: 500 mV/DIV  
zoom: 1  
zero position: 50%  
low-pass filter: OFF

(6) Measurement

- Press the **START** key, and the LED above the **START** key lights. In this case the input is already present, so the trigger will take effect immediately.
- When the waveform has been captured for the specified recording length, the LED goes off, the unit enters the stop state, and the auto print function set in step (3) operates, and the waveform is printed. (The waveform below is printed, with the gauge function enabled on the SET UP (SYSTEM 1) screen.)

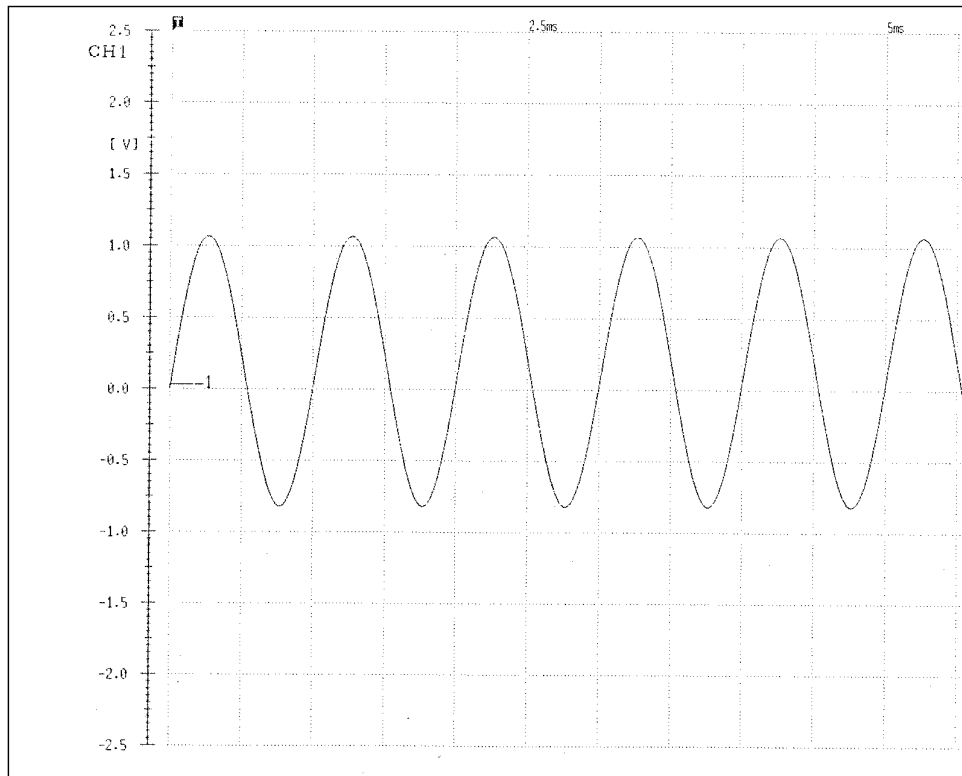

### 3.2.3 Measuring and Recording a Voltage (Recorder Function)

**Example** A 2 V<sub>p-p</sub> 1 Hz sine wave input is measured.

(1) Input connection

Connect a signal generator to the 8835-01.

(2) Set the signal generator so that it outputs a 2 V<sub>p-p</sub> 1 Hz sine wave.

(3) Settings on the STATUS 1 screen

Make the following settings with the CURSOR keys and function keys.

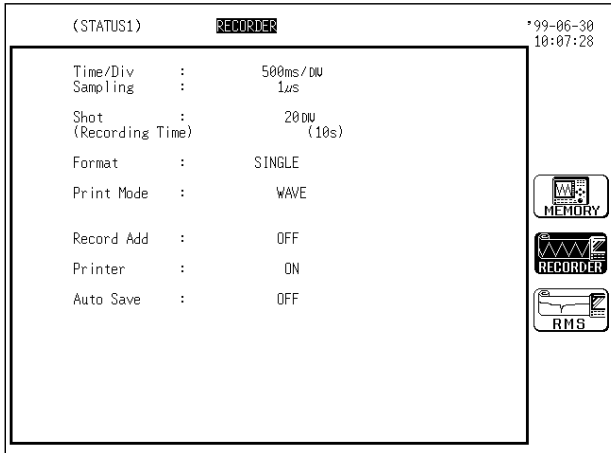

time/div: 500 ms/DIV

sampling: 1 μs

shot: 20 DIV

format: SINGLE

print mode: WAVE

additional recording: OFF

printer: ON

auto save: OFF

(4) Settings on the STATUS 2 screen

Make the following settings with the CURSOR keys and function keys.

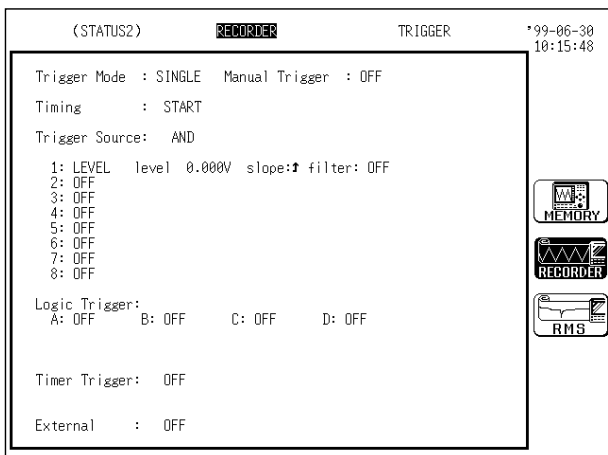

trigger mode: SINGLE

timing: START

trigger source: AND

manual trigger: OFF

analog trigger: level trigger

trigger level: 0.000 V

trigger direction (slope): rising

trigger filter: OFF

Logic Trigger: OFF

timer trigger: OFF

external trigger: OFF

(5) Settings on the CHANNEL 1 screen

Make the following settings with the CURSOR keys and function keys.

Ch	Draw	Unit	Range	Zoom (Lower ~ Upper)	Zero Pos. ~ Upper	Filter
1	■	ANALOG	500 mV 500mV/DIV	× 1 -2.5 V ~ 2.5 V	50%	HP: OFF
2	--	ANALOG	20 mV 20mV/DIV	× 1 -100mV ~ 100mV	50%	HP: OFF
3	--	ANALOG	20 mV 20mV/DIV	× 1 -100mV ~ 100mV	50%	HP: OFF
4	--	ANALOG	20 mV 20mV/DIV	× 1 -100mV ~ 100mV	50%	HP: OFF

  

chA	POS:1	chB	POS:2	chC	POS:3	chD	POS:4
1	--	1	--	1	--	1	--
2	--	2	--	2	--	2	--
3	--	3	--	3	--	3	--
4	--	4	--	4	--	4	--

range: 500 mV/DIV  
 zoom: 1  
 zero position: 50%  
 low-pass filter: OFF

(6) Measurement

- Press the **START** key, and the LED above the **START** key lights. In this case the input is already present, so the trigger will take effect immediately.
- The real-time print function set in step (3) operates, and the waveform is printed when it has been captured.
- When the waveform has been recorded for the specified recording length, the LED goes off, and the unit enters the stop state. (The waveform below is printed, with the gauge function enabled on the SET UP (SYSTEM 1) screen.)

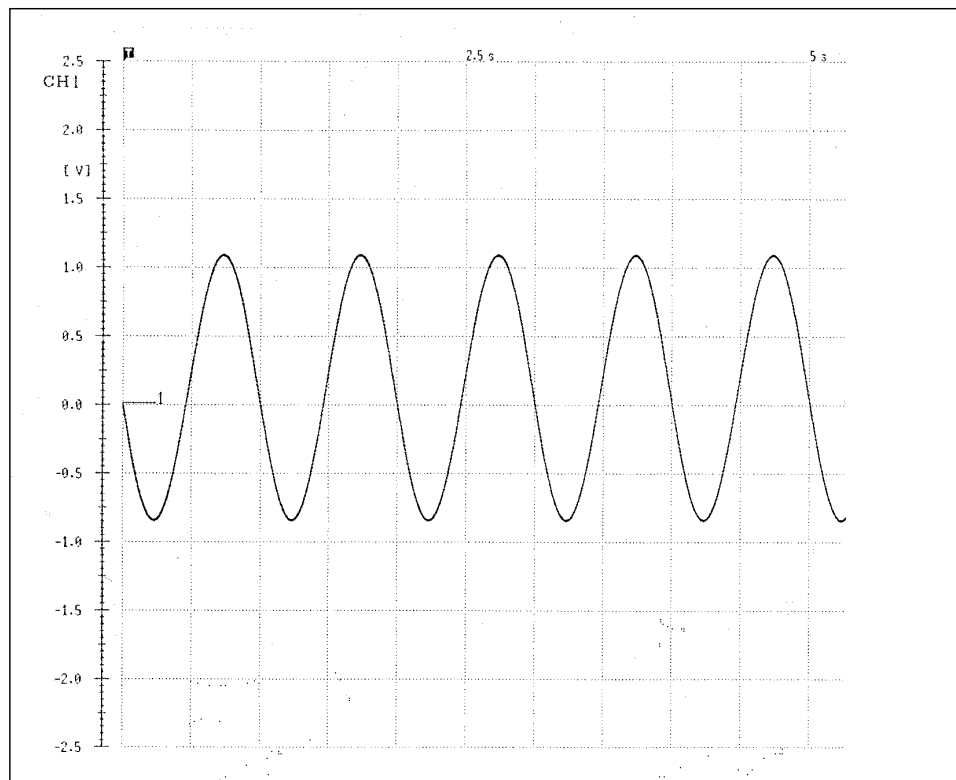

### 3.2.4 Measuring and Recording an RMS Value (RMS Recorder Function)

**Example** A signal going below 5 Vrms is captured.

(1) Input connection

Connect a signal generator to the 8835-01.

(2) Set the signal generator so that it outputs a sine wave of 50 Hz and 5 Vrms or more.

(3) Settings on the STATUS 1 screen

Make the following settings with the CURSOR keys and function keys.

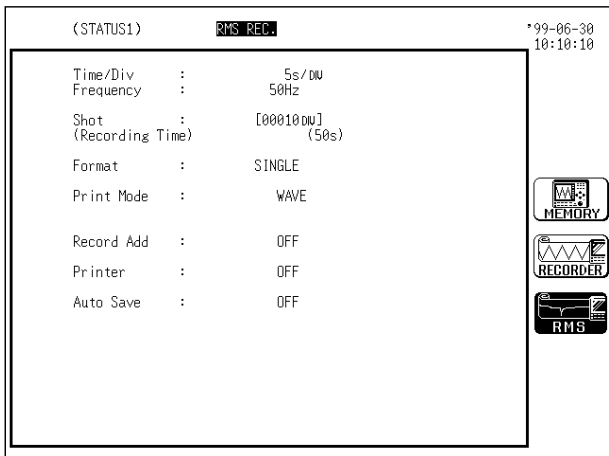

time/div: 5 s/DIV

frequency: 50 Hz

shot: 10 DIV

format: SINGLE

print mode: WAVE

additional recording: OFF

printer: OFF

auto save: OFF

(4) Settings on the STATUS 2 screen

Make the following settings with the CURSOR keys and function keys.

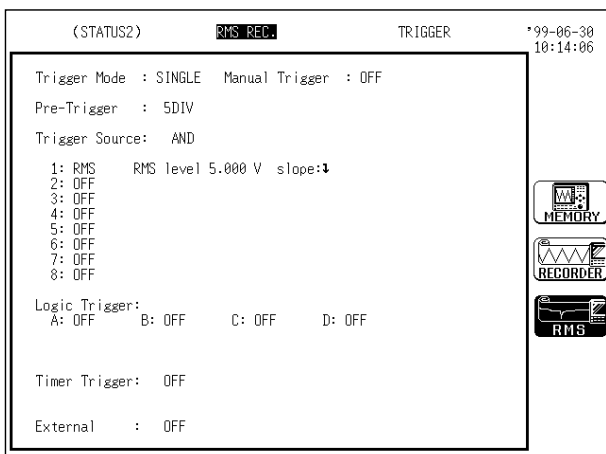

trigger mode: SINGLE

pre-trigger: 5 DIV

trigger source: AND

manual trigger: OFF

analog trigger: RMS level

trigger level: 5.00 V

trigger direction (slope): falling

Logic Trigger: OFF

timer trigger: OFF

external trigger: OFF

(5) Settings on the CHANNEL 1 screen

Make the following settings with the CURSOR keys and function keys.

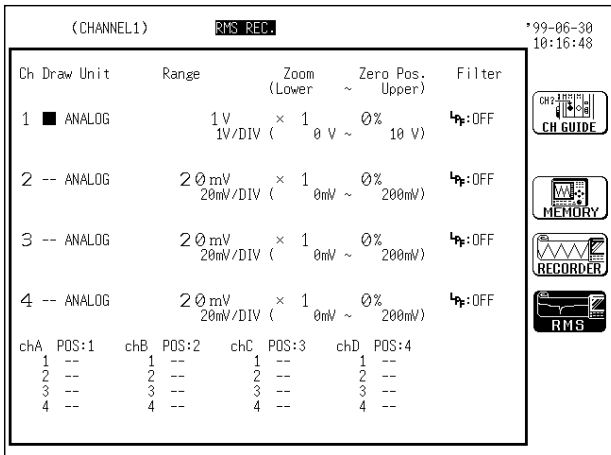

range: 1 V/DIV  
 zoom: 1  
 zero position: 0%  
 low-pass filter: OFF

(6) Measurement

- Press the **START** key, and the LED above the **START** key lights. Since triggering does not occur, waveforms are not displayed. Change the signal generator amplitude to reduce the RMS value to 5 V or less. Once the RMS value is set to the required level, triggering occurs immediately. (When the RMS recorder function is used, triggering occurs even before pretriggering is set. In the example shown below, waveforms equivalent to 2 DIV (approximately 10 s) counted from initiation of measurement are recorded prior to triggering.
- When the waveform has been recorded for the specified recording length, the LED goes off, and the unit enters the stop state. (The waveform below is printed, with the gauge function enabled on the SET UP (SYSTEM 1) screen.)

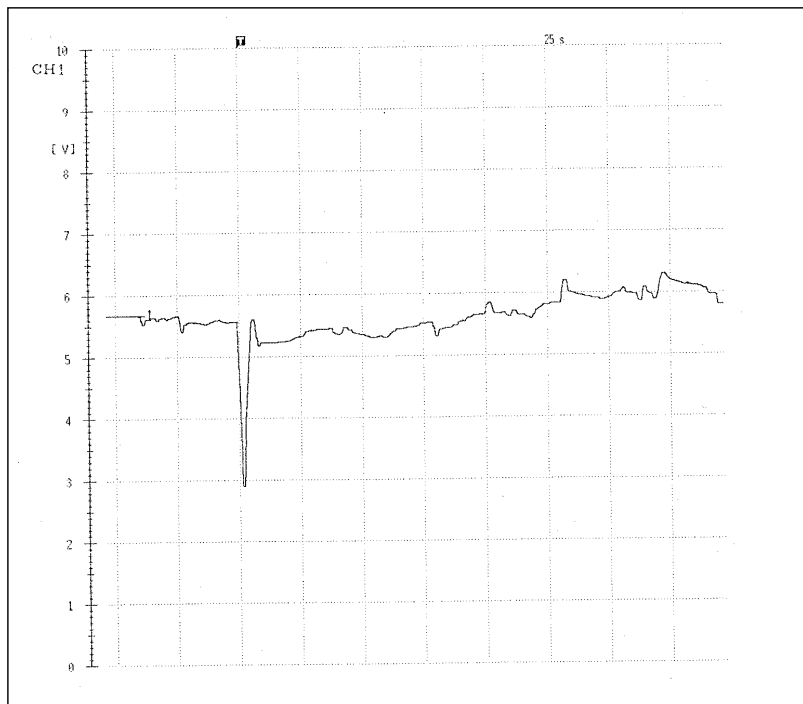

---

# Chapter 4

## Memory Recorder Function

---

---

### 4.1 Outline

---

#### 4.1.1 Outline of the Memory Recorder Function

The memory recorder function has the following features.

- (1) After being stored in the internal memory, input signal data can be displayed and printed.
- (2) All input channel data are recorded on the same time axis.  
Since data for all channels can be superimposed, the relative relationship between input signals can be observed visually.
- (3) Time axis setting  
100  $\mu$ s/DIV to 5 min/DIV
- (4) Time axis resolution 100 points/DIV
- (5) Storage capacity  
40,000 DIV
- (6) Waveform magnification/compression display and print
  - Time axis direction:  $\times 10$  to  $\times 1/5000$
  - Voltage axis direction:  $\times 10$  to  $\times 1/2$With the variable function
- (7) Display format
  - Time axis waveform: single, dual, quad screen display
  - X-Y waveform: dot, line
- (8) Printing
  - Manual print, partial print, screen hard copy.
  - Multiple printing possible.
- (9) High-quality print  
Smooth print function approximates analog waveform.
- (10) Logging function  
Numeric printout of waveform data
- (11) Pre-trigger function  
Allows monitoring of signal also before triggering.

## 4.1.2 Operation Sequence

The flowchart below illustrates the sequence of operations involved in using the memory recorder function.

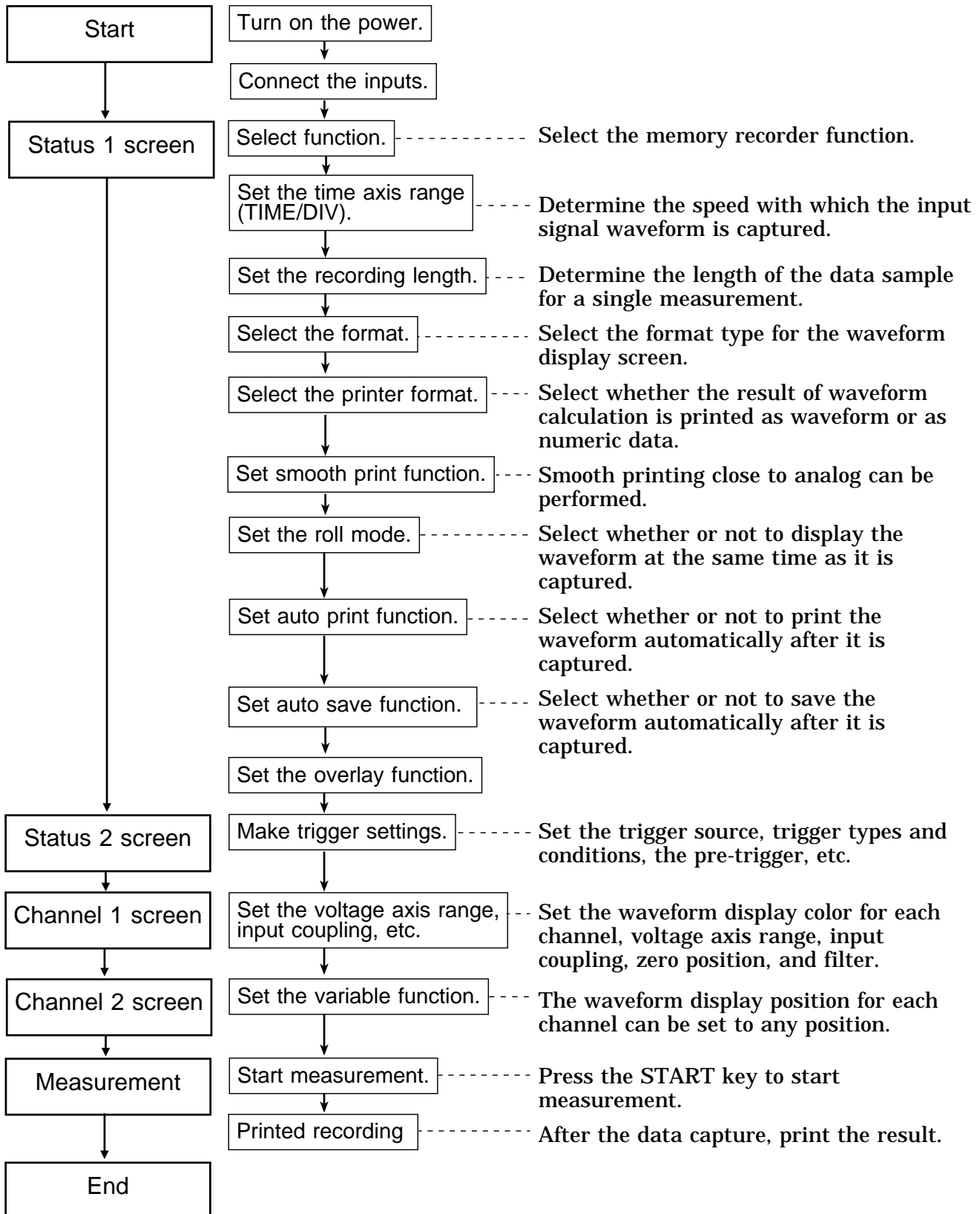



## 4.2 Making Settings

### 4.2.1 Setting the Function Mode

The 8835-01 has three function modes: the memory recorder function mode, the recorder function mode, and the RMS recorder function mode. Select the memory recorder function.

**Method** Screen: STATUS 1, 2, CHANNEL, DISPLAY

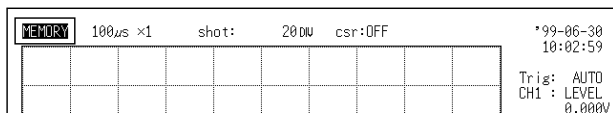
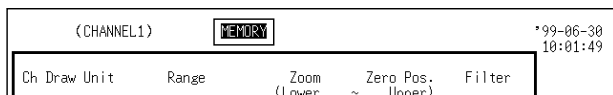

1. Call up the STATUS 1, 2, CHANNEL or DISPLAY screen.

2. Move the flashing cursor to the position shown in the figure on the left.

3. Press **F1** [ MEMORY ].



: Memory recorder function



: Recorder function



: RMS recorder function

## 4.2.2 Setting the Time Axis Range

- Set the speed for inputting and storing the waveform of the input signal.
- Time axis range setting expresses the time for 1 DIV.
- The sampling period is 1/100th of the set value for the time axis range. (100 samples/DIV)
- When external sampling is set, sampling is performed in synchronization with an external signal. (see Section 12.4)

### Method 1 Screen: STATUS 1, DISPLAY

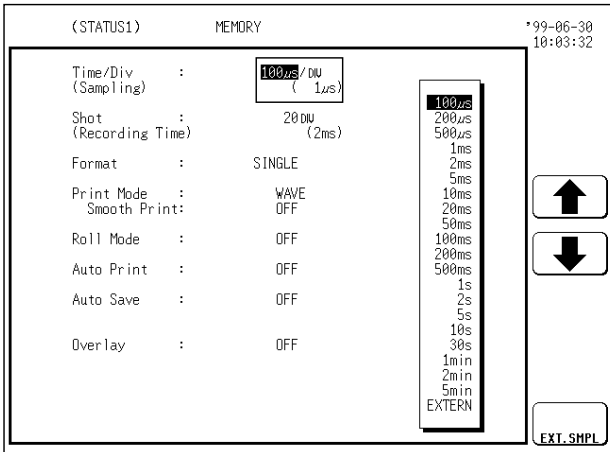

1. Call up the STATUS 1 or DISPLAY screen.
2. Move the flashing cursor to the time/div item, as shown in the figure on the left.
3. Use the JOG control or the function keys to make the selection.



: Move the cursor up in the selection window.



: Move the cursor down in the selection window.



: Set external sampling.

#### NOTE

On the DISPLAY screen, the setting cannot be made with the JOG control.

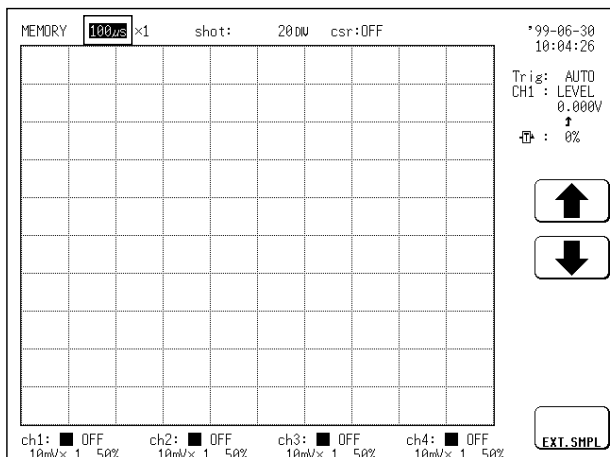

### Method 2 Screen: STATUS 1, DISPLAY

1. Call up the STATUS 1 or DISPLAY screen.
2. Use the **TIME/DIV** key to make the selection.

#### NOTE

The **TIME/DIV** key can be used regardless of where the flashing cursor is located, if the STATUS 1 or DISPLAY screen is displayed.

Data points per division are set when external sampling is selected.

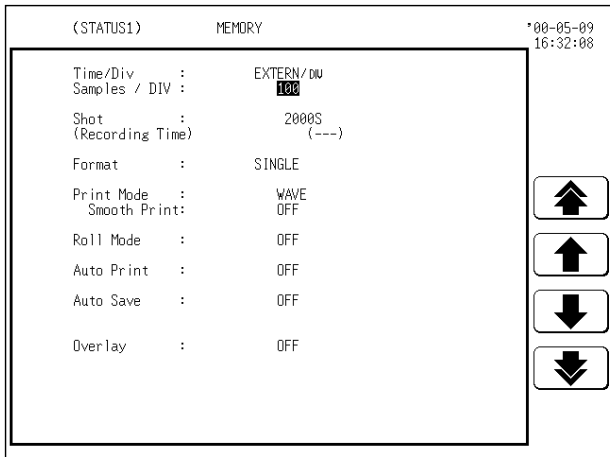

1. Move the flashing cursor to the samples/DIV item, as shown in the figure on the left.
2. Use the JOG/SHUTTLE control or the function keys to make the selection. Setting range is 10 to 1000.

### 4.2.3 Setting the Recording Length

- The length of recording for one measurement operation (number of DIV) can be set.
- Two types of recording length can be set.
  - Fixed recording length mode: Select the desired recording length from among types 1, 2, and 5.
  - Any recording length mode: Any recording length can be selected by the user. The recording length can be changed in intervals of 1 DIV.

#### Method 1 (Fixed recording length mode)

Screen: STATUS 1, DISPLAY

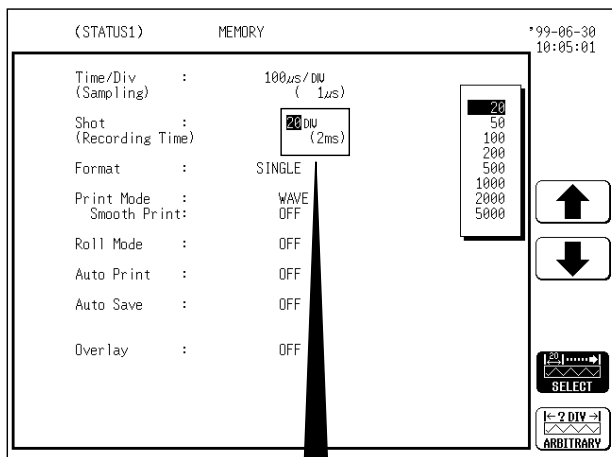

1. Call up the STATUS 1 or DISPLAY screen.
2. Move the flashing cursor to the shot item, as shown in the figure on the left.
3. Use the JOG control or the function keys to make the selection.



: Move the cursor up in the selection window.



: Move the cursor down in the selection window.



: Set the fixed recording length mode.



: Set the any recording length mode.

Shows the measurement time in the set time axis range and recording length.

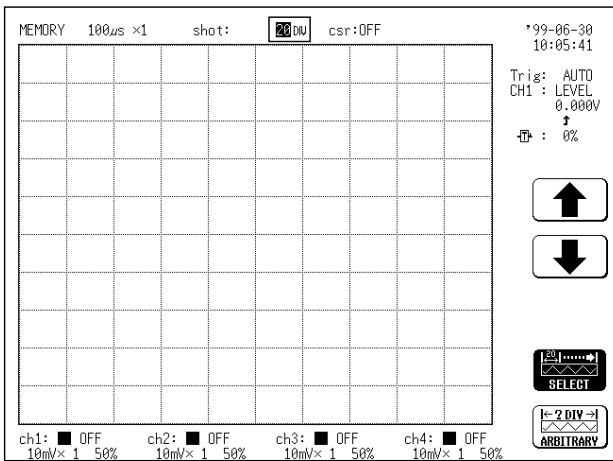

**NOTE**

- Depending on the number of channels, the recording length is limited (see Section 14.3). (For setting the number of channels, see Section 9.3.1.)
- On the DISPLAY screen, the selection window is not displayed.

**Method 2 (Any recording length mode)**  
Screen: STATUS 1, DISPLAY

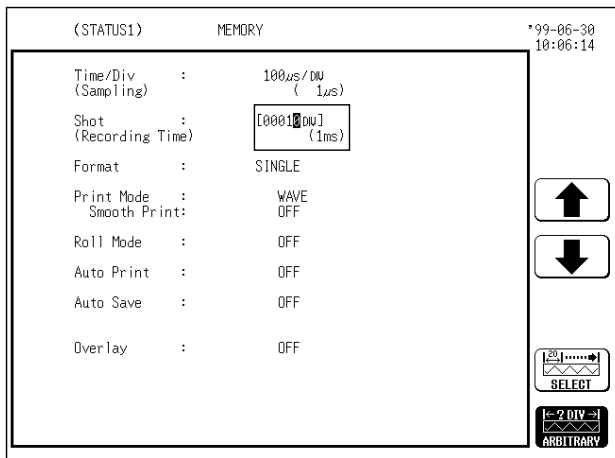

1. Call up the STATUS 1 or DISPLAY screen.
2. Move the flashing cursor to the shot item, as shown in the figure on the left.
3. Set the any recording length mode.
4. Use the JOG control or the function keys to make the selection. Use the cursor keys to change the column.



: Value up



: Value down



: Set the fixed recording length mode.



: Set the any recording length mode.

**NOTE**

On the DISPLAY screen, the setting cannot be made with the JOG control.

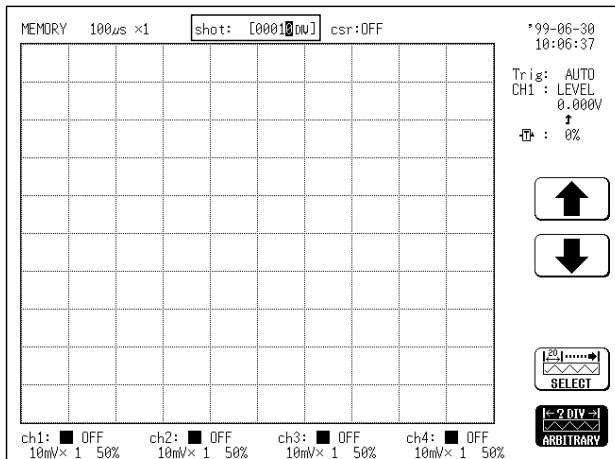

## 4.2.4 Setting the Format

- The style can be set for showing input signals on the screen display and recording them on the printer.
- The styles single, dual, quad, X-Y (dot), and X-Y (line) are available.

### (1) Single

Display and record as one graph. (At the most, 8 analog + 16 logic signals)

Input waveform

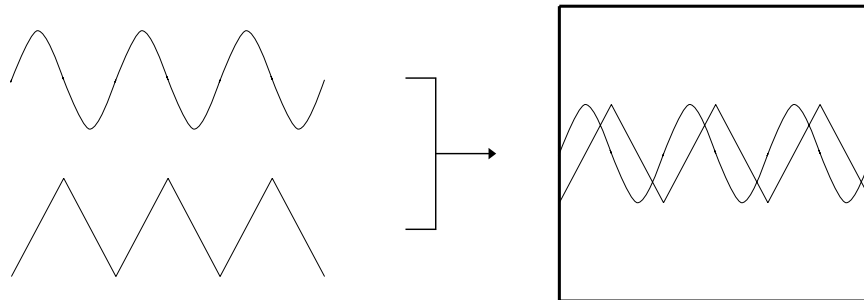

### (2) Dual

- Display and record as two graphs. (At the most, 8 analog + 16 logic signals)
- Specify which input channel to use for waveform graph display and recording.

Input waveform

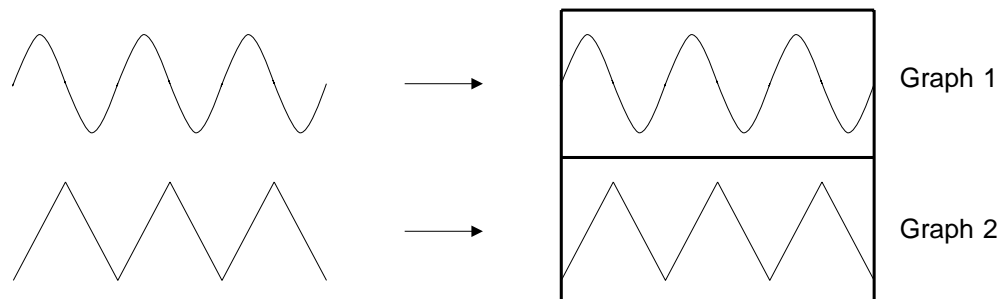

### (3) Quad

- Display and record as four graphs. (At the most, 8 analog + 16 logic signals)
- Specify which input channel to use for waveform graph display and recording.



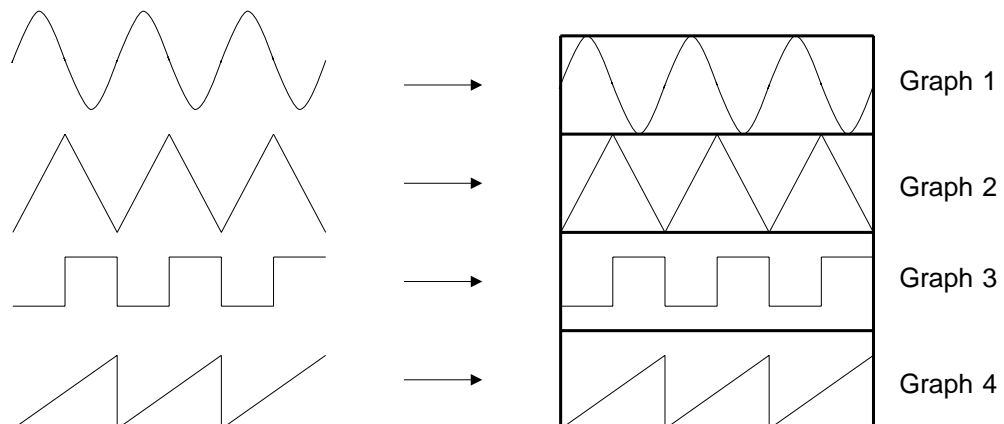

Input waveform

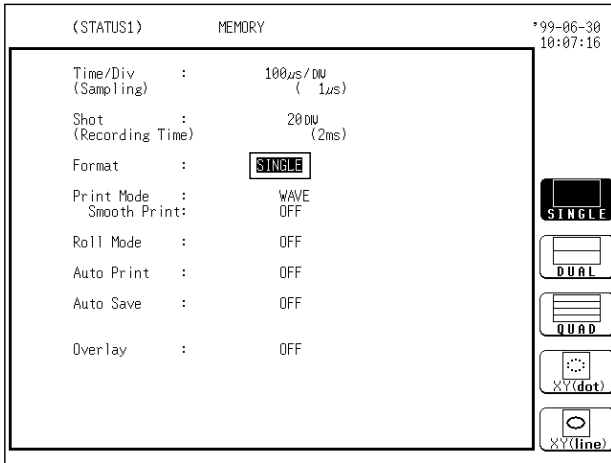

## (4) X-Y (dot), (line)

Assign any analog channel to the X axis and the other seven channels to the Y axis to form the combined plot.

**Method** Screen: STATUS 1

1. Call up the STATUS 1 screen.
2. Move the flashing cursor to the format item, as shown in the figure on the left.
3. Use the function keys to select the display format.
  -  : Single
  -  : Dual
  -  : Quad
  -  : X-Y (dot)
  -  : X-Y (line)
4. Set the graph display position and the X-Y plot. See Section 7.7.2.

## 4.2.5 Using the X-Y Waveform Plots

- Setting the display format to X-Y in Section 4.2.4 allows X-Y waveforms to be combined.
- Assign any analog channel to the X axis and the other seven channels to the Y axis to form the combined plot.
- Voltage axis magnification/compression is active also when using X-Y combined plotting.
- Using the A/B cursors, it is possible to specify the data between the cursors for partial plotting.

### (1) X-Y (dot)

- The sampled data is displayed and recorded just as it comes.
- Linear interpolation is not performed.

Input waveform

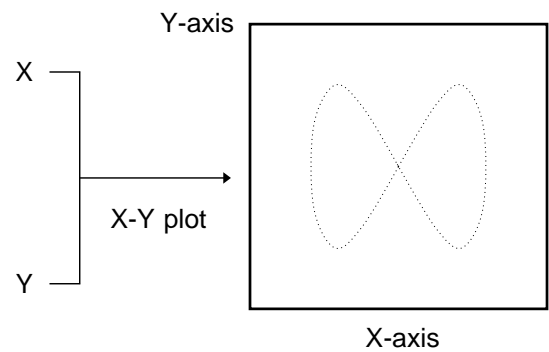
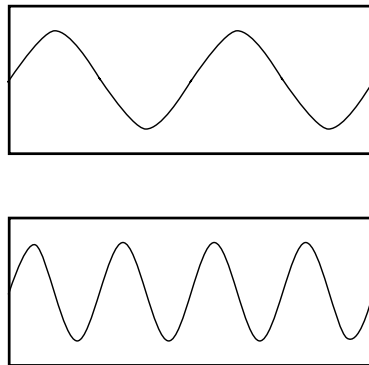

### (2) X-Y (line)

- Linear interpolation is performed.
- The display becomes easier to read, but display speed is slower compared to dot display.

Input waveform

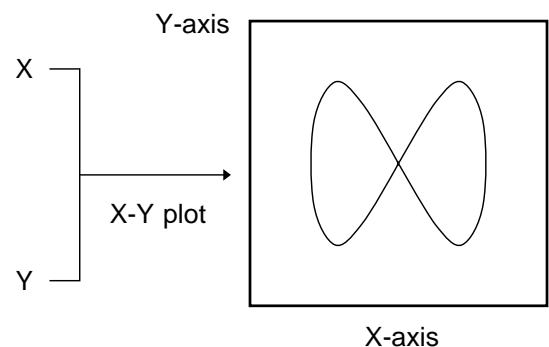
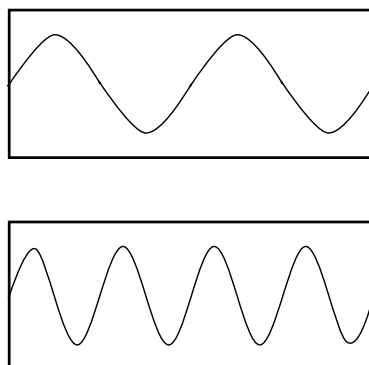

## Method

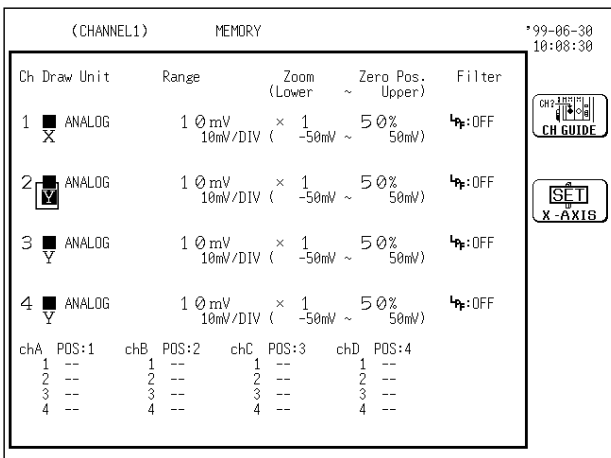
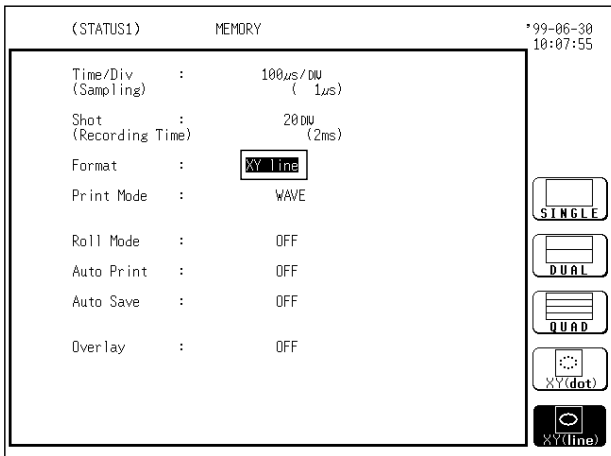

1. Call up the STATUS 1 screen.
2. Move the flashing cursor to the format item.
3. Use the function keys to select X-Y (dot) or X-Y (line).
4. Press the **CHAN** key to call up the CHANNEL 1 screen.
5. Use the **CH SELECT** key to open selected channel screen.
6. Specify waveform color (see Section 7.3.1).
7. Specify the X-axis channel.
  - ① Move the cursor to the channel to be used as X axis, as shown at left.
  - ② Use the function keys to select X axis.
8. The channels other than the channel assigned to the X axis are automatically assigned to the Y axis.

### Partial X-Y plot

Using the A/B cursors, it is possible to specify a range for partial X-Y plotting. (Normal X-Y plotting covers all data of the recording length.)

## Method

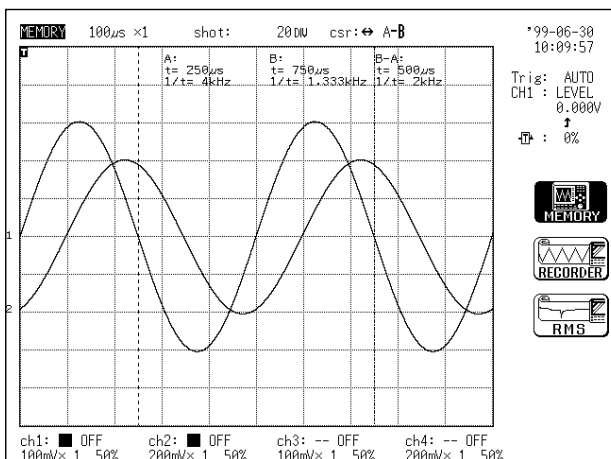

1. Display the captured waveform data, using a format other than X-Y.
2. Use the A/B cursors to specify the desired portion for plotting, as shown in the figure on the left (see Section 11.2).
3. Press the **STATUS** key to call up the STATUS 1 screen.
4. Carry out combined plotting as described above.

### NOTE

When the horizontal cursor is used, partial X-Y plotting is not implemented.



## 4.2.6 Setting the Printer Format

- Selects whether waveform data are printed as waveform or as numeric data.
- When numeric data are selected, the print interval also must be set.

### Printing as a waveform

#### Method

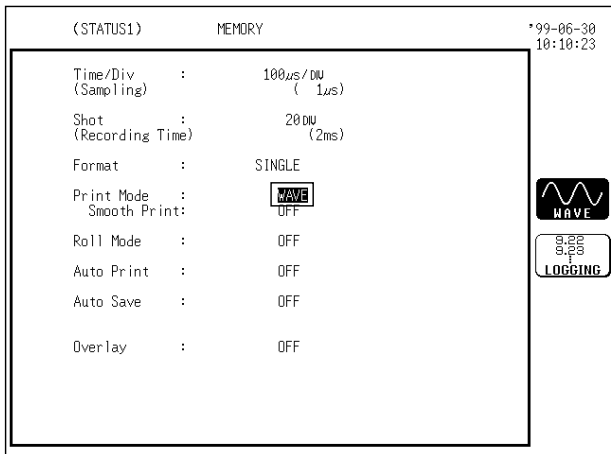

1. Press the **STATUS** key to call up the STATUS 1 screen.
2. Move the flashing cursor to the print mode item, as shown in the figure on the left.
3. Use the function keys to select waveform.



: Waveform data and the result of calculation are printed as a waveform.



: Waveform data and the result of calculation are printed as numeric data.

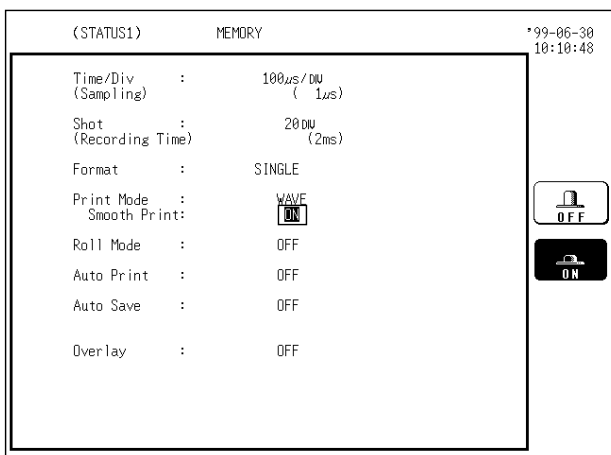

4. Move the flashing cursor to the smooth print item.



: Normal printing is carried out.



: Smooth printing is enabled.

(For details, see Section 10.3.)

## Printing as numeric data

### Method

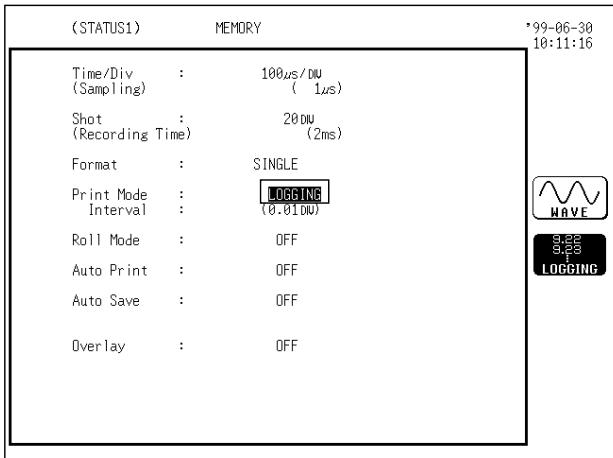

1. Press the **STATUS** key to call up the STATUS 1 screen.
2. Move the flashing cursor to the print mode item, as shown in the figure on the left.
3. Use the function keys to select numeric data.



: Waveform data and the result of calculation are printed as a waveform.



: Waveform data and the result of calculation are printed as numeric data.

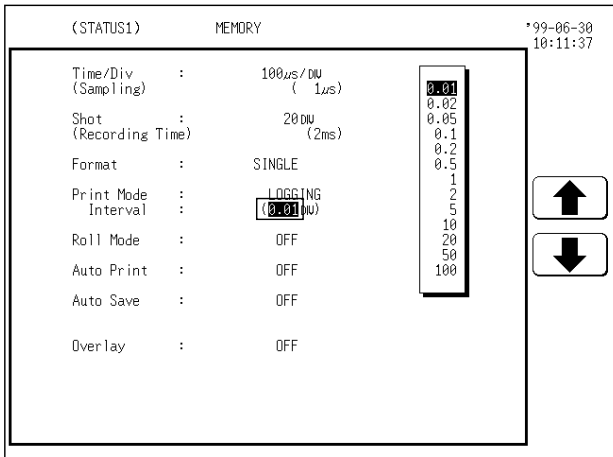

4. Move the flashing cursor to the print interval item.
5. Use the JOG control or the function keys to select the print interval.



: Move the cursor up in the selection window.



: Move the cursor down in the selection window.

**NOTE**

When the print interval longer than the recording length is set, only the first dot is printed.

## 4.2.7 Setting the Roll Mode

- This mode can be used at a time axis range setting of 10 ms/DIV or slower.
- When roll mode is set to ON, the waveform is displayed immediately at the start of recording (the screen scrolls).

### Method

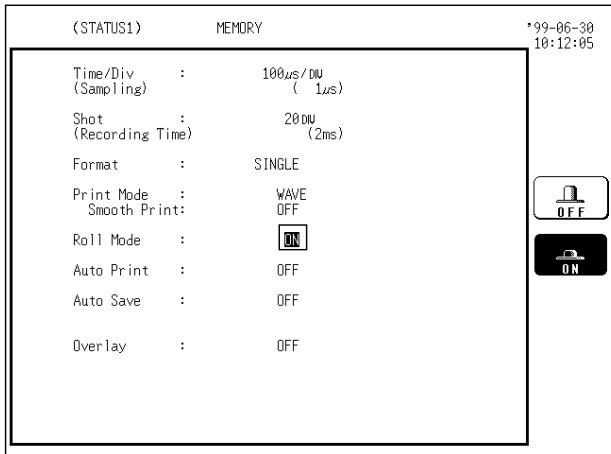

1. Press the **STATUS** key to call up the STATUS 1 screen.
2. Move the flashing cursor to the roll mode item, as shown in the figure on the left.
3. Use the function keys to make the selection.



: Normal recording is carried out.



: The waveform is displayed immediately at the start of recording.

### NOTE

- When the time axis range of 10 ms/DIV or faster is set, normal recording is carried out even if roll mode is set to ON.
- Roll mode cannot be set together with the overlay function. (When the display format is set to "X-Y," you can turn ON Overlay with Roll Mode ON.)

## 4.2.8 Setting the Auto Print Function

When the function is enabled, print is carried out automatically after a waveform is captured.

### Method

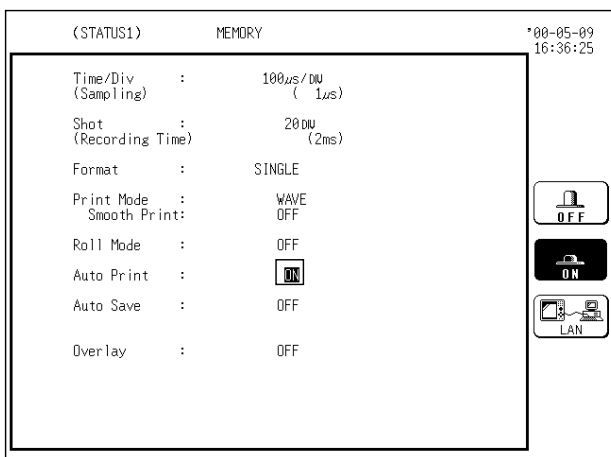

1. Press the **STATUS** key to call up the STATUS 1 screen.
2. Move the flashing cursor to the auto print item, as shown in the figure on the left.
3. Use the function keys to make the selection.



: Auto print is disabled.



: Auto print is enabled.



: Print data is automatically transferred to the data collection server on the LAN (when connected to a LAN).

### NOTE

If the A/B cursors are used, partial save is applied (see Section 10.7.4).

## 4.2.9 Setting the Auto Save Function

When the function is enabled, waveform data are automatically stored on a floppy disk or PC card after they are captured.

### Method

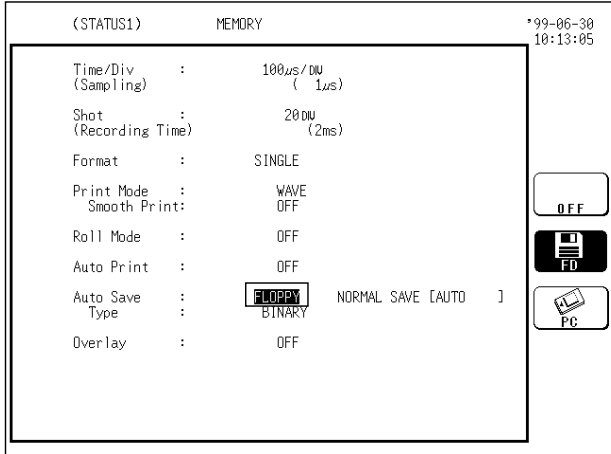

1. Press the **STATUS** key to call up the STATUS 1 screen.
2. Move the flashing cursor to the auto save item, as shown in the figure on the left.
3. Use the function keys to select the media.



: Auto save is disabled.



: Waveform data are automatically stored on floppy disk



: Waveform data are automatically stored on PC card.

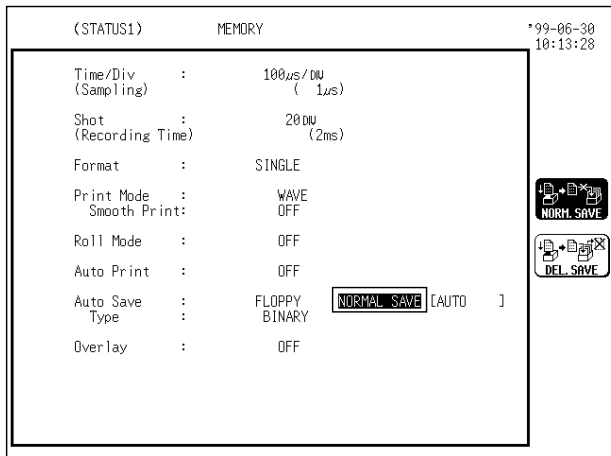

4. Selecting Media displays saving data options.



: Cancels automatic save when media is full.



: Deletes old files and automatically saves when media is full.

#### NOTE

In delete save, file is saved as MEM. extension file in binary format and TXT. extension file in text format.

5. File naming

See Section 9.5.5 for entry options.

In automatic save, file is titled with a number following the file name.

When file is left untitled during processing, AUTO automatically executes.

#### NOTE

- File name contains eight alphanumeric characters. In automatic save the last character may be replaced with a number to designate the file.
- When the characters below are used in a file, the file cannot be handled on a PC running Windows 2000 or XP. Do not use these characters when handling a file on your PC.  
+, =, [, ]

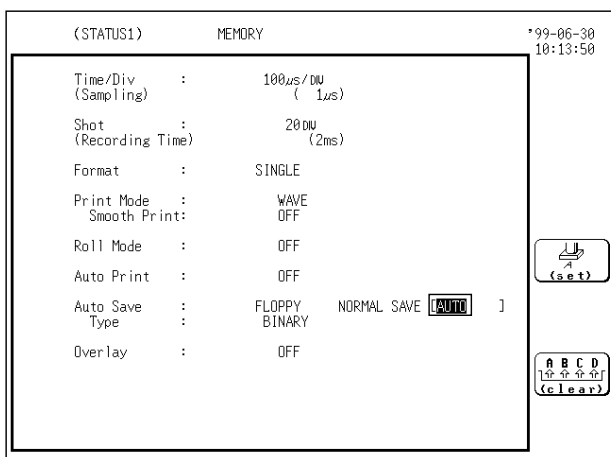

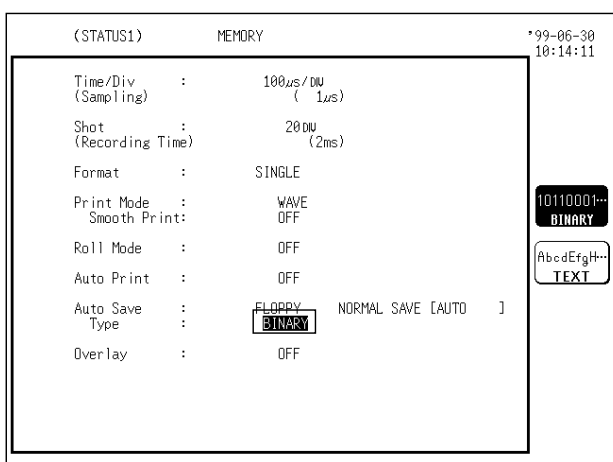

6. Use the function keys to select the data store principle.

10110001... BINARY : Data are stored as binary data.

AbcdEfgH... TEXT : Data are stored as text data.

**NOTE**

The TEXT format is intended for reading by a PC. Select BINARY for reading by the 8835-01.

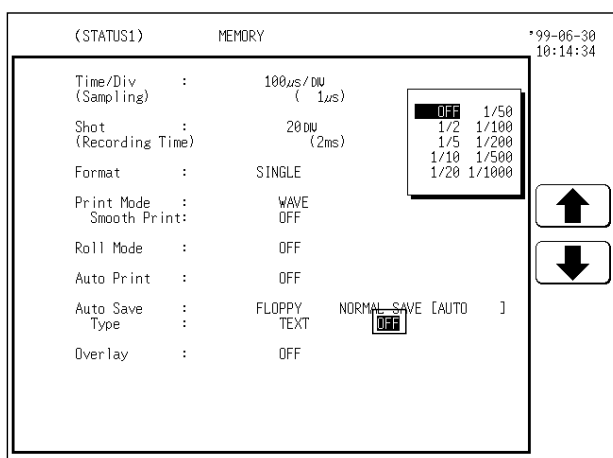

7. Selected TEXT in save options opens Thinning.

Use the JOG control or the function keys to make the selection.

↑ : Move the cursor up in the selection window.

↓ : Move the cursor down in the selection window.

**NOTE**

- In automatic save channels cannot be selected. Only current channel displaying waveform is saved.
- A file is stored in the directory currently selected on the file screen.
- Only a limited number of directories and files can be stored in the directory. Use Report Print to print overlaid waveforms. (see Section 10.7.7)
- If the A/B cursors are used, partial save is applied (see Section 13.4.5 Detailed Explanation of the Commands 1. SAVE).
- If the data quantity is too large, it may not fit on a floppy diskette or PC Card. For the size of a file, see Section Appendix 4. (When the display format is set to "X-Y," you can turn ON Overlay with Roll Mode ON.)

## 4.2.10 Overlay

- Overlay is performed without clearing the currently displayed waveform (if trigger mode is REPEAT or AUTO).
- This allows comparison to the immediately preceding waveform.

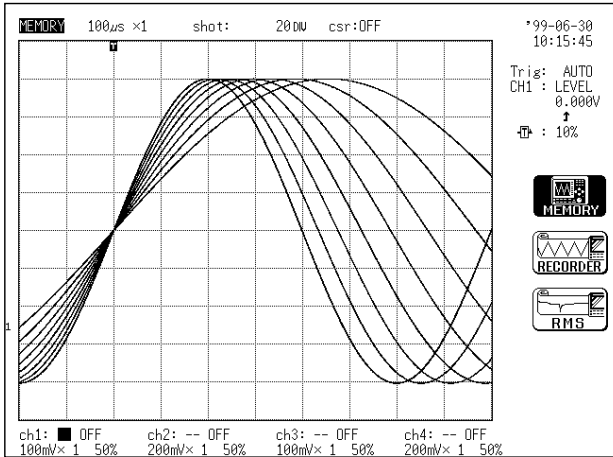

### Method Screen: STATUS 1

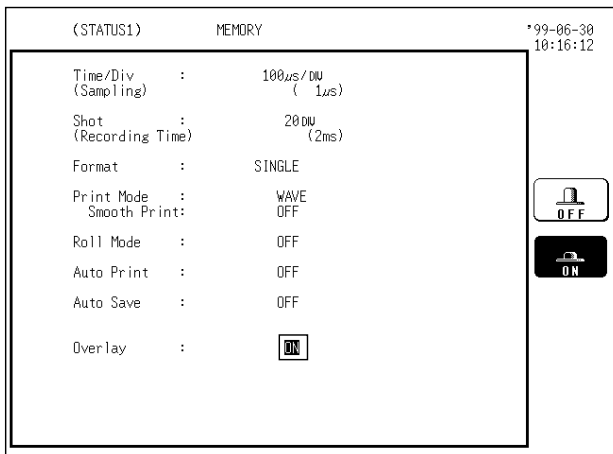

1. Move the flashing cursor to the overlay item.
2. Use the function keys to make the selection.

 : Overlay is not performed.

 : Overlay is performed.

**NOTE**

- If trigger mode is SINGLE, measurement terminates after one set of data has been collected. Therefore overlay is impossible.
- While the overlay function is being used, waveform scrolling cannot be carried out.
- When manual printing (see Section 10.7.1) is carried out, only the last waveform will be printed. Use Report Print to print overlaid waveforms. (see Section 10.7.7)
- If one of the following settings is changed, the overlay waveform display terminates and only the last waveform is shown (the settings cannot be changed on the DISPLAY screen):
  - ① Screen zoom ratio (along time axis or voltage axis)
  - ② Display format
  - ③ Waveform display or store channel
  - ④ X axis or Y axis during X-Y display
- For dark waveform colors (the six lower-half colors), the most recently used colors are indistinguishable from previous ones.
- The overlay function cannot be set together with roll mode. (When the display format is set to "X-Y," you can turn ON Overlay with Roll Mode ON.)

---

### 4.2.11 Setting the Trigger

Select the trigger that is suitable for the signal to be captured.  
For details, see Chapter 8.

---

### 4.2.12 Input Channel Settings

The settings differ for each unit.  
See the settings for each unit in Chapter 7.

## 4.3 Settings on the Display Screen

Explains the setting items on the Display screen and the setting of the voltage axis and time axis.

### 4.3.1 Setting Magnification/Compression Along the Time Axis

- The magnification/compression ratio along the time axis can be set.
- By magnifying the waveform, detailed observations can be made. By compressing the waveform, an entire change can be promptly apprehended.
- Magnification/compression of the screen uses the left edge as reference, regardless of the status of the A/B cursor.

#### Method

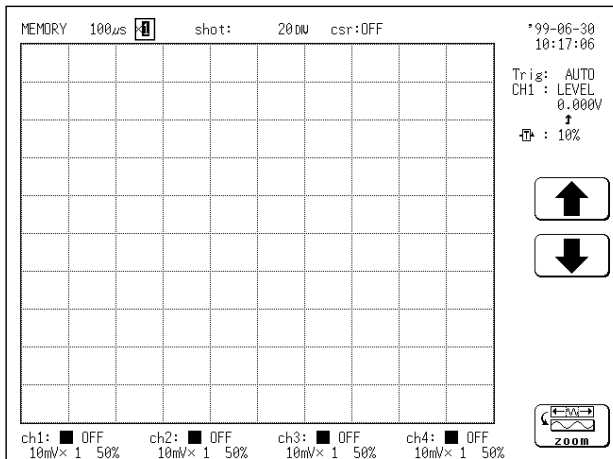

1. Move the flashing cursor to the position shown in the figure on the left.
2. Use the function keys to select the magnification/compression ratio.

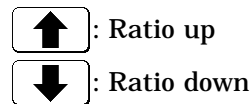

#### NOTE

The magnification/compression factor can be changed also after measurement is completed.

#### Reference

- The **HELP** key can be used to check which position within the entire recording length is occupied by the currently shown waveform (see **VIEW** key in Section 3.1.7).
- It is possible to divide the display screen into two screens (upper and lower), and magnify the waveform on the upper screen along the time axis and display it on the lower screen (see Section 11.4).



## 4.3.2 Automatic Setting of Time Axis and Voltage Axis (Auto Range Function)

This function automatically selects the time axis range, voltage axis range and zero position.

**Method** Screen: DISPLAY

1. Press the  $\leftarrow$  and  $\rightarrow$  cursor keys simultaneously.
2. Use the function keys to execute or cancel the function.

**NOTE**

- Because the auto-range function performs automatic setting for the input signal present at the time the function is executed, input a signal before executing the function.
- Taking the lowest numbered channel among the channels for which waveform display is on, 1 to 2.5 cycles are automatically set to be recorded as 10 DIV.
- If for the input signal for this channel there is only a small difference between the maximum value and the minimum value in the range of highest sensitivity (10 mV/DIV), the setting is made by taking the next higher channel.
- If the range cannot be determined, for all channels for which the waveform display is on, a warning message appears, and measurement is abandoned.
- If measurement has started using the auto-range function:
  - a. Conditions related to the input units:
    - Voltage axis range, zero position: value set automatically
    - Low-pass filter: OFF
    - Input coupling: DC
 (8 channels)
  - b. Trigger conditions:
    - AND/OR for internal trigger and external trigger...OR
    - Internal trigger..... only ON for the lowest numbered one of the channels for which waveform display is on. OFF for the other seven channels. (However, only in the case that the difference between the maximum and minimum values is significant.)
    - Trigger type: Level... • Slope:  $\uparrow$  (rising)
      - Trigger level: value set automatically
      - Filter: OFF
 (For one channel only)
    - Trigger mode: AUTO
    - Pre-trigger: 20%
    - External trigger: OFF
    - Timer trigger: OFF
  - c. Status conditions:
    - Time axis range (time/div): value set automatically
    - Magnification/compression ratio along the voltage axis:  $\times 1$
    - Magnification/compression ratio along the time axis:  $\times 1$

---

## 4.4 Processing Functions (Waveform Parameter Processing)

---

### 4.4.1 Summary of the Processing Functions

- The function is available only when using the memory recorder function.
- The following 14 processing functions are available for the captured waveform data.
- Processing results are shown in numerical form.
- If the A/B cursors are turned off, processing is carried out for all data.
- If the A/B cursors are used, processing is carried out for data between the A/B cursors.
- If only the A cursor is used, processing is carried out for data after the A cursor.

- |                         |                      |
|-------------------------|----------------------|
| ① Average value         | ⑧ Period             |
| ② Effective value (RMS) | ⑨ Frequency          |
| ③ Peak to peak value    | ⑩ Rise time          |
| ④ Maximum value         | ⑪ Fall time          |
| ⑤ Time to maximum value | ⑫ Standard deviation |
| ⑥ Minimum value         | ⑬ Area value         |
| ⑦ Time to minimum value | ⑭ XY area            |

## 4.4.2 Processing Method

Settings for the processing method are made with the status 3 screen.

### Method Screen: STATUS 3

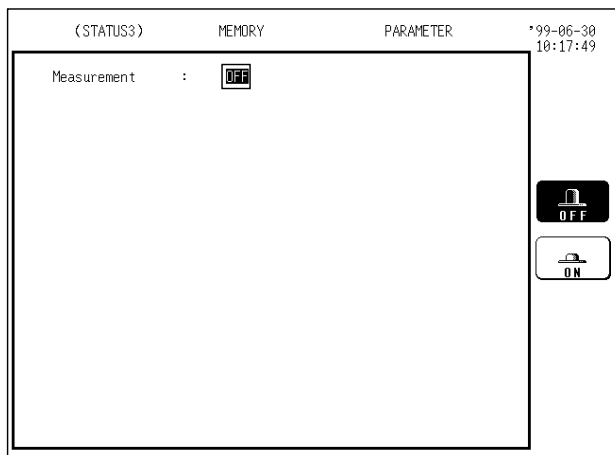

1. Call up the STATUS 3 screen.
2. Move the flashing cursor to the point shown in the figure on the left.
3. Use the function keys to make the selection.



: Parameter processing is disabled.



: Parameter processing is enabled.



: Processing is performed for the already captured waveform. Processing can be stopped with the **STOP** key.

#### NOTE

When parameter processing is disabled, the other setting items are not displayed at all.

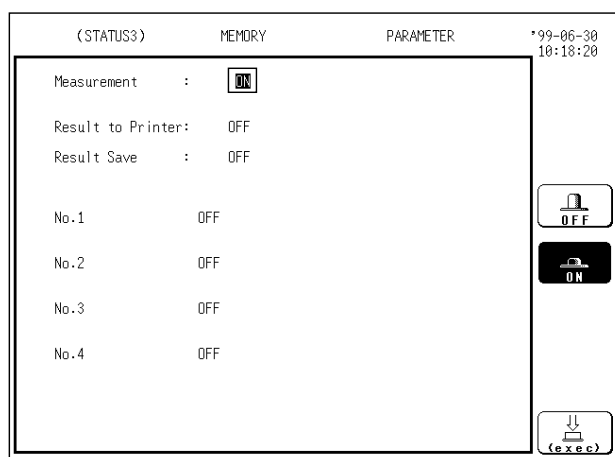

4. If parameter processing is set to ON, the various setting items are displayed.

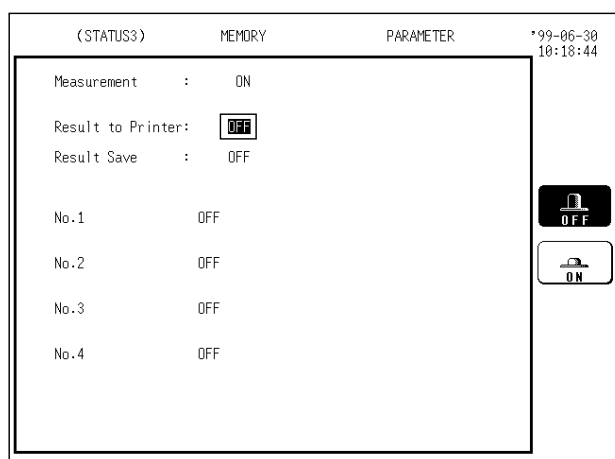

5. Move the flashing cursor to the point shown in the figure on the left, and enable or disable printout of parameter processing results. Use the function keys to make the selection



: Processing results are not printed.



: Processing results are printed.

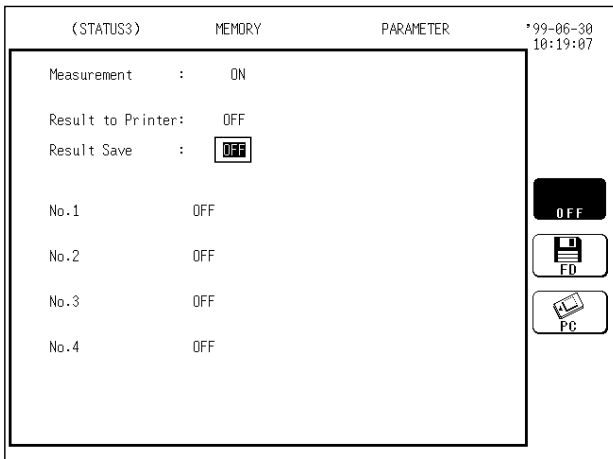

6. Move the flashing cursor to the point shown in the figure on the left, and enable or disable storing of parameter processing results. Use the function keys to make the selection.



: Processing results are not stored.



: Processing results are stored on floppy disk.



: Processing results are stored on PC card.

**NOTE**

- Processing results are stored as text data.
- A file is stored in the directory currently selected on the file screen.
- The LAN selection is available only when a LAN is connected.

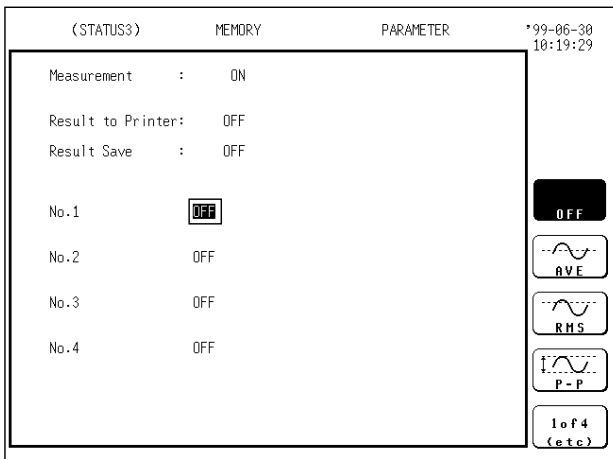

7. Select processing functions and set the channel for processing. Four processing functions can be performed simultaneously.

(1) Move the flashing cursor to the point shown in the figure.

Use the function keys to select processing functions.

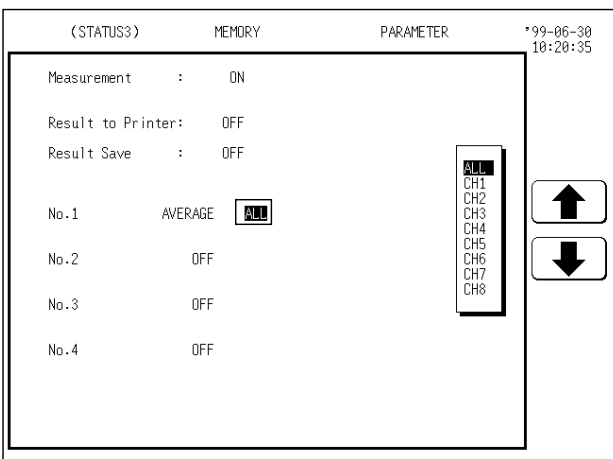

(2) Move the flashing cursor to the point shown in the figure, and set the channel.

Use the function keys to make the selection.



: Move the cursor up in the selection window.



: Move the cursor down in the selection window.

### 4.4.3 Waveform Parameter Calculation Details

(1) Average value

- Calculates the average value (V) of the waveform data.

- Equation:

$$AVE = \frac{1}{n} \sum_{i=1}^n di$$

AVE: average value

n: number of data samples

$d_i$  : i-th data of the source channel

(2) RMS value

- Calculates the RMS (effective) value (V) of the waveform data.

- When scaling is used, the value is calculated after scaling.

- Equation:

$$RMS = \sqrt{\frac{\sum_{i=1}^n di^2}{n}}$$

RMS: effective value

n: number of data samples

$d_i$ : i-th data of the source channel

(3) Peak-to-peak value

Calculates the peak-to-peak (maximum-minimum) value of the waveform data.

(4) Maximum value

Calculates the maximum value of the waveform.

(5) Time to maximum value

- Calculates the time interval from the triggering point to the maximum value of the waveform (in seconds).

- If there are two maximum value points, the time to the first point is calculated.

(6) Minimum value

Calculates the minimum value of the waveform.

(7) Time to minimum value

- Calculates the time interval from the triggering point to the minimum value of the waveform (in seconds).
- If there are two minimum value points, the time to the first point is calculated.

(8) Period

(9) Frequency

- Displays the period (s) and frequency (Hz) of the signal waveform.
- The calculation is performed by determining the middle point of the signal amplitude and then measuring the interval from the point when that level is crossed (in rising or falling direction) to the point when it is next crossed.

(10) Rise time

(11) Fall time

- From the captured waveform data, the 0% and 100% level is determined using the histogram, and the rise time (s) is taken as the time required to go from 10% to 90% (fall time: from 90% to 10%).
- In the captured waveform data, the first rising slope (or falling slope) is used to make the calculation.
- If the A/B cursors (vertical, trace) are used, the first rising slope (or falling slope) within the range defined by the cursors is used.

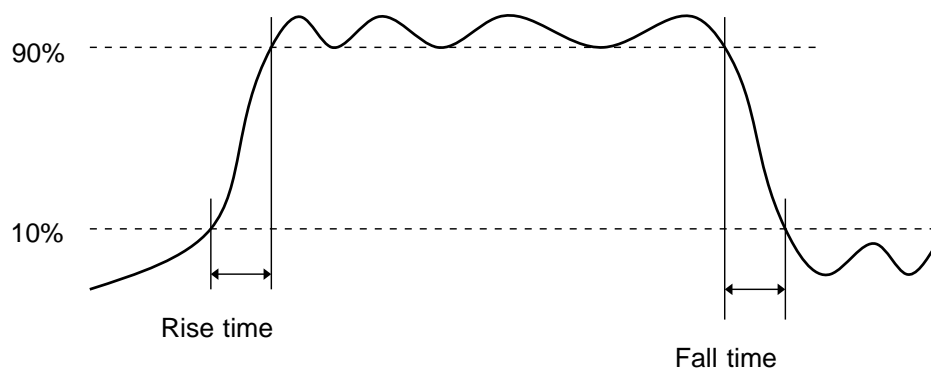

## (12) Standard deviation

- Calculates the standard deviation (V) of the waveform data.
- Equation:

$$\sigma = \sqrt{\frac{\sum_{i=1}^n (d_i - AVE)^2}{n}}$$

$\sigma$  : standard deviation

AVE: average value

n: number of data samples

$d_i$ : i-th data of the source channel

## (13) Area value

- Calculates the area bordered by the signal waveform and the zero position (potential 0 V).
- If the A/B cursors (vertical, trace) are used, the area between the cursors is calculated.
- Equation:

$$S = \sum_{i=1}^n |d_i| \cdot h$$

S: Area value

n: number of data samples

$d_i$ : i-th data of the source channel

$h = t$ : sampling period

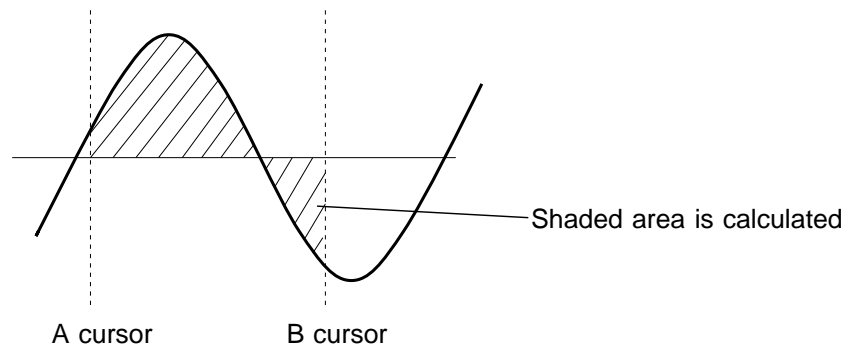

## (14) X-Y area value

- Calculates the area ( $V^2$ ) after X-Y plotting.
- The waveform is plotted on the X-Y screen, and the area enclosed by the plot lines is calculated.
- In single, dual, or quad screen, the A/B cursors (vertical, trace) can be used to specify the range for X-Y plotting and area calculation.
- On the X-Y screen of the memory recorder function, it is not possible to specify the range with the A/B cursors.
- Refer to Section 11.2 Using the A/B Cursors, for more information on cursor operation.

X-Y waveform

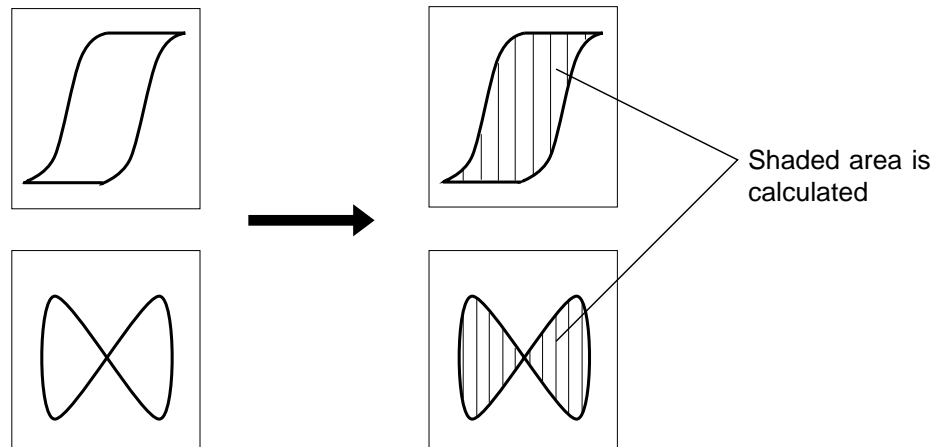

X-Y waveform (no enclosed range)

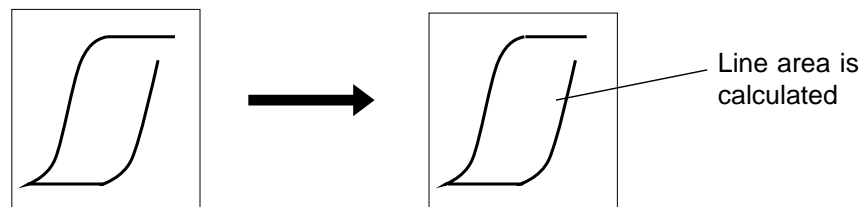
**NOTE**

- Depending on the signal waveform, values for parameters (8), (9), (10), and (11) may not be displayed.
- When the scaling function is used, scaling is first applied to waveform data, and then the parameters are calculated. The parameter unit is determined by the scaling unit (  Section 9.4).



---

## 4.5 Start and Stop Measurement Operation

### Method

1. Press the **START** key to initiate measurement or set the unit to trigger standby.
2. Press the **STOP** key during measurement to stop the measurement. (see Section 3.1.4.)

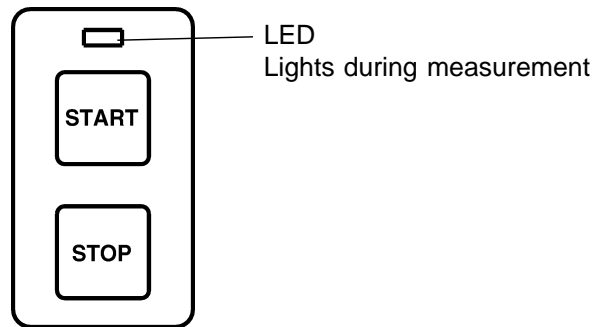

When the **STOP** key is pressed once, triggering occurs, waveforms are displayed and printed out, and measurement is stopped.

When the **STOP** key is pressed twice, the 8835-01 is forcibly stopped.

- When measurement is forcibly stopped following trigger generation, waveform data collected up to the point of termination remains after measurement is stopped.
- There will be no waveform data if measurement is forcibly stopped prior to trigger generation. However, during continuous measurement, any waveform data remaining from a prior trigger will be displayed.
- When the auto save function is ON, waveform data collected up to the point of termination is automatically stored.

# 4.6 Print Examples

Single screen (The list and gauge functions are enabled.)

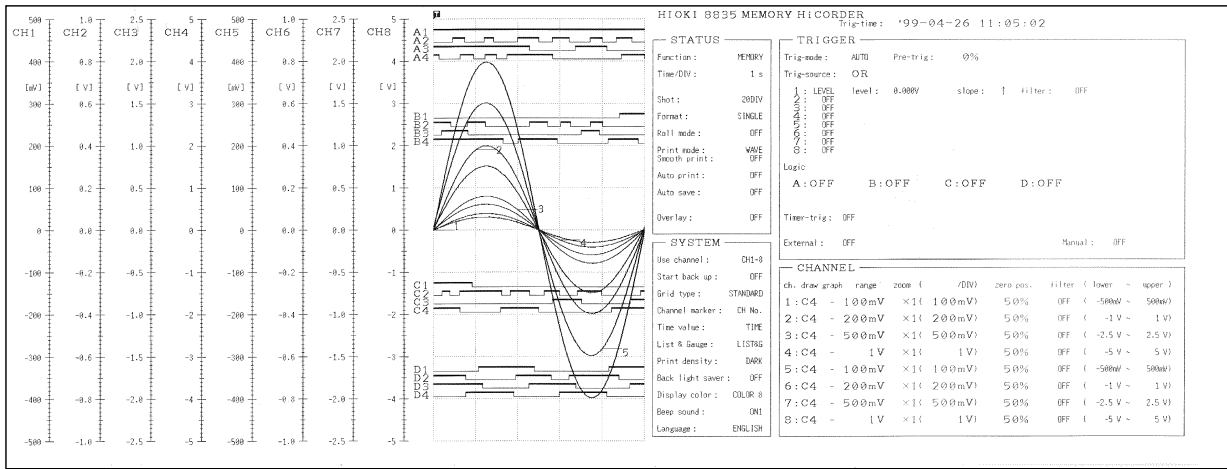

Dual screen (The gauge function is enabled.)

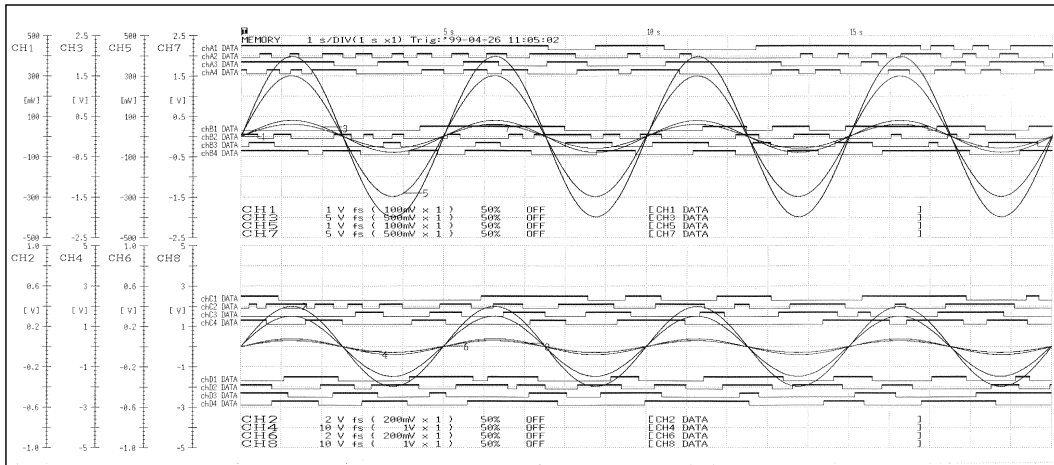

Quad screen (The gauge function is enabled.)

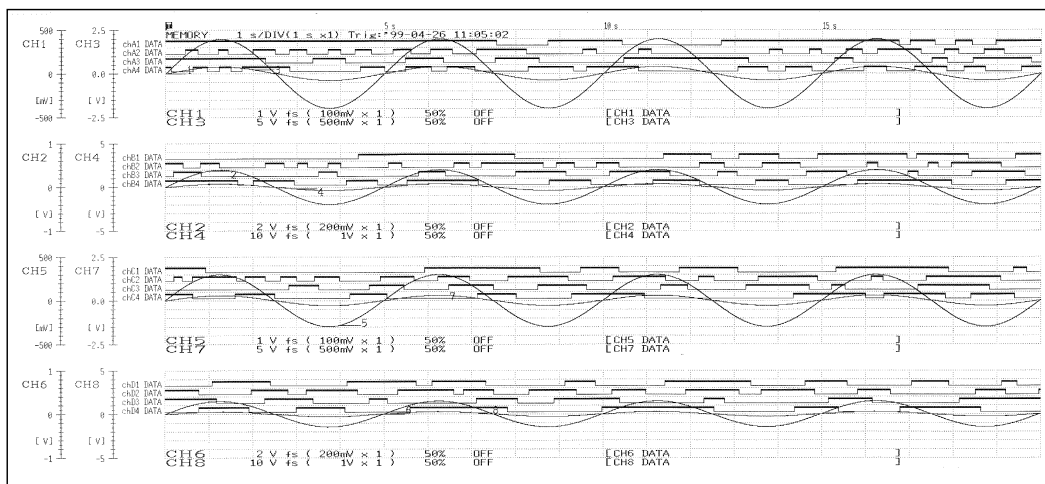

Report

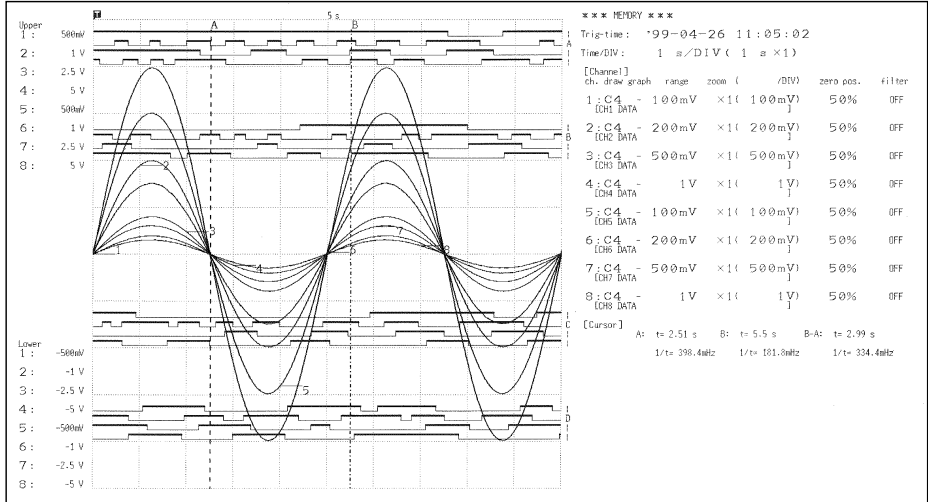

List

HIOKI 8835 MEMORY HiCORDER  
Trig-time: '99-04-26 11:05:02

STATUS		TRIGGER	
Function: MEMORY	Trig-mode: AUTO	Pre-trig: 0%	
Time/Div: 1 s	Trig-source: OR		
Shot: 20DIV	1: LEVEL level: 0.00W	slope: ↑	filter: OFF
Format: SINGLE	OFF		
Roll mode: OFF	OFF		
Print mode: WAVE	OFF		
Smooth print: OFF	OFF		
Auto print: OFF	OFF		
Auto save: OFF	OFF		
Overlay: OFF	OFF		
SYSTEM		Logic	
Use channel: CH1-8	A: OFF	B: OFF	C: OFF
Start back up: OFF	D: OFF		
Grid type: STANDARD	Timer-trig: OFF		
Channel marker: CH No.	External: OFF		Manual: OFF
Time value: TIME	CHANNEL		
List & Gauge: GAUGE	ch. draw graph	range	zoom ( /Div) zero pos. filter ( lower ~ upper )
Print density: DARK	1: C4 - 100mV	x1( 100mV)	50% OFF ( -500mV ~ 500mV)
Back light saver: OFF	2: C4 - 200mV	x1( 200mV)	50% OFF ( -1V ~ 1V)
Display color: COLOR 8	3: C4 - 500mV	x1( 500mV)	50% OFF ( -2.5V ~ 2.5V)
Beep sound: ON1	4: C4 - 1V	x1( 1V)	50% OFF ( -5V ~ 5V)
Language: ENGLISH	5: C4 - 100mV	x1( 100mV)	50% OFF ( -500mV ~ 500mV)
	6: C4 - 200mV	x1( 200mV)	50% OFF ( -1V ~ 1V)
	7: C4 - 500mV	x1( 500mV)	50% OFF ( -2.5V ~ 2.5V)
	8: C4 - 1V	x1( 1V)	50% OFF ( -5V ~ 5V)

Numeric data

Trig-time: '99-04-26 11:05:02  
Comment

(time)	CH1	CH2	CH3	CH4	A	B	C	D
	CH5	CH6	CH7	CH8	1234	1234	1234	1234
0 s	625mV	1.25mV	3.125mV	-6.25mV	1011	0101	1001	0110
1.00 s	377.5mV	380mV	381.25mV	382.75mV	0101	0101	0100	0011
2.00 s	233.13mV	236.25mV	237.5mV	231.25mV	0111	0000	0101	1100
3.00 s	-233.75mV	-230mV	-228.13mV	-231.25mV	1100	0000	0010	0011
4.00 s	-378.12mV	-376.25mV	-375mV	-387.5mV	0101	0100	0000	0101
5.00 s	0 V	1.25mV	3.125mV	0 V	1000	1000	0111	1010
6.00 s	377.5mV	380mV	378.13mV	375mV	1011	1011	1000	0101
7.00 s	233.13mV	236.25mV	237.5mV	231.25mV	1001	1001	1010	1101
8.00 s	-233.75mV	-230mV	-228.13mV	-237.5mV	0110	0110	0110	0010
9.00 s	-378.12mV	-376.25mV	-375mV	-381.25mV	1001	0111	0110	0110
10.00 s	0 V	1.25mV	3.125mV	-6.25mV	1001	0100	1001	0011
11.00 s	377.5mV	380mV	381.25mV	375mV	0110	0010	0100	0001
12.00 s	233.13mV	236.25mV	237.5mV	231.25mV	0001	1001	1000	1101
13.00 s	-233.75mV	-230mV	-228.13mV	-237.5mV	1010	0010	1000	1100
14.00 s	-378.12mV	-376.25mV	-375mV	-387.5mV	1100	1101	0110	0100
15.00 s	-625mV	1.25mV	3.125mV	-6.25mV	1000	1000	1001	0001
16.00 s	377.5mV	380mV	381.25mV	375mV	1001	1001	1000	0110
17.00 s	233.13mV	236.25mV	237.5mV	231.25mV	1100	0011	1001	0001
18.00 s	-233.75mV	-230mV	-228.13mV	-237.5mV	0100	0100	0110	0001
19.00 s	-378.12mV	-376.25mV	-375mV	-375mV	1110	0110	0101	0110
20.00 s	0 V	1.25mV	3.125mV	0 V	1001	1001	0000	0110

X-Y (The gauge function is enabled.)

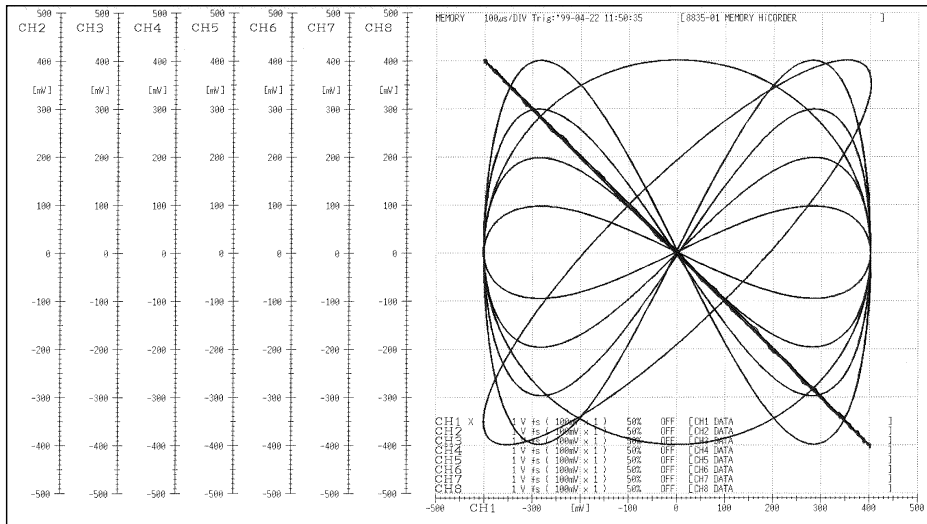

# Chapter 5

## Recorder Function

### 5.1 Outline

#### 5.1.1 Outline of the Recorder Function

The recorder function has the following features.

- (1) Real time display and printing of the input signal
- (2) Real time continuous recording of the input signal
- (3) All input channel data are recorded on the same time axis.  
Since data for all channels can be superimposed, the relative relationship between input signals can be observed visually.
- (4) Time axis setting  
10 ms//DIV to 1 h/DIV
- (5) Time axis resolution 100 points/DIV (printer)
- (6) High-speed sampling  
The setting range is max. 1 MS/s. The available range depends on the selected time axis range (input signal waveform capture rate).
- (7) Waveform magnification/compression display and printout
  - Time axis direction:  $\times 1$  to  $\times 1/200$
  - Voltage axis direction:  $\times 10$  to  $\times 1/2$With the variable function
- (8) Display format
  - Time axis waveform: single, dual, quad screen display
  - X-Y waveform: dot, line
- (9) Scrollable display
  - The most recent 2000 divisions<sup>(\*1)</sup> of the data are stored in memory.
  - It is possible to scroll back for easy review.
- (10) Additional recording function
- (11) Logging function  
Numeric printout of waveform data
- (12) Reprint function  
The most recent 2000 divisions<sup>(\*1)</sup> of the data stored in memory can be printed as many times as required.

\*1: See "Waveform storage" in Section 14.4.

## 5.1.2 Operation Sequence

The flowchart below illustrates the sequence of operations involved in using the recorder function.

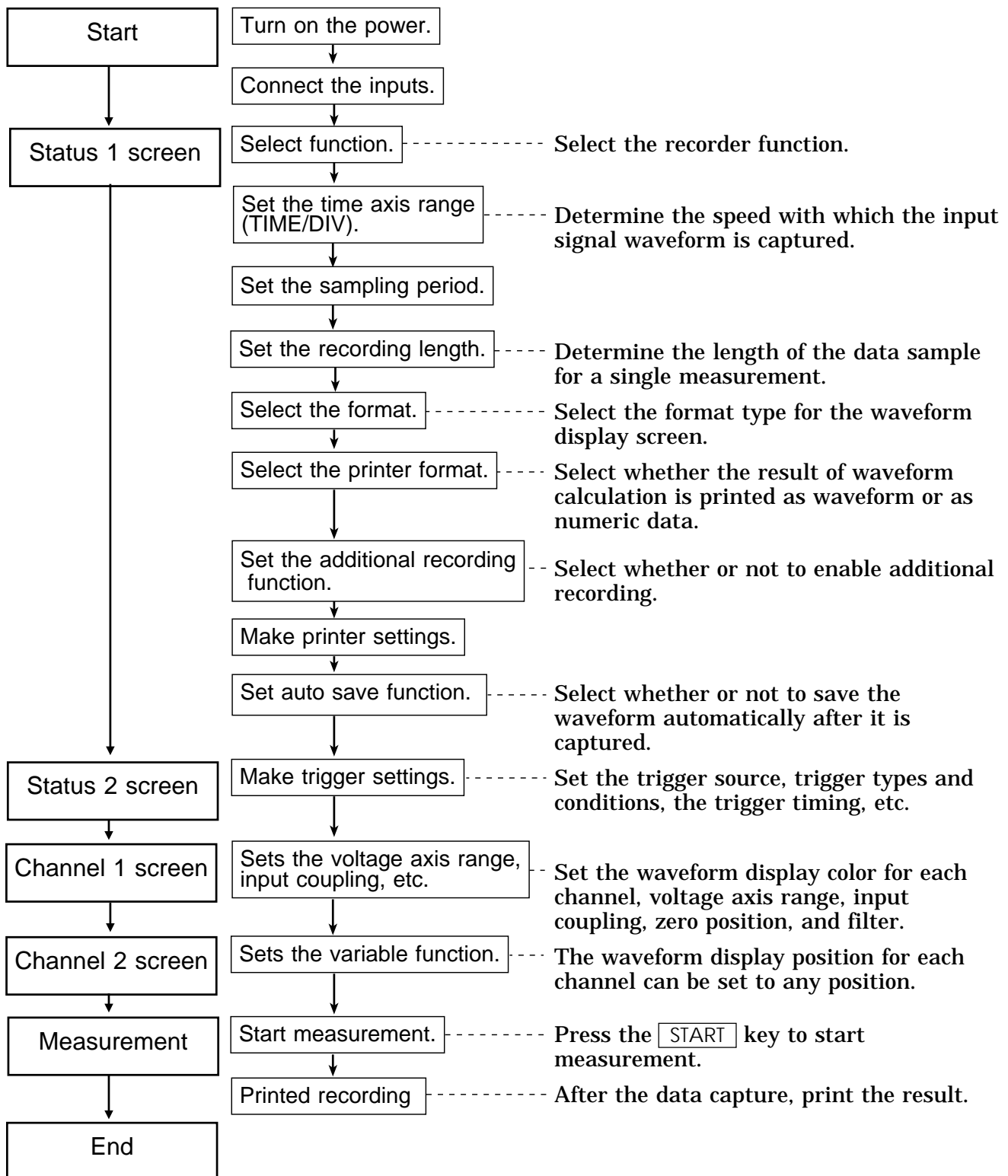

## 5.2 Making Settings

### 5.2.1 Setting the Function Mode

The 8835-01 has three function modes: the memory recorder function mode, the recorder function mode, and the RMS recorder function mode. Select the recorder function.

**Method** Screen: STATUS 1, 2, CHANNEL, DISPLAY

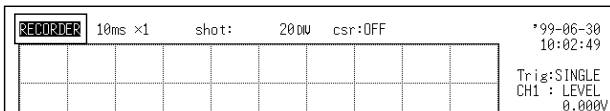
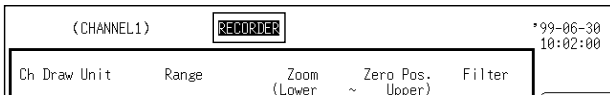
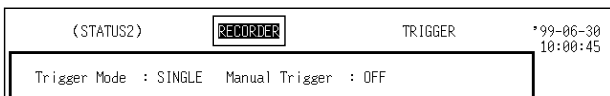

1. Call up the STATUS 1, 2, CHANNEL or DISPLAY screen.

2. Move the flashing cursor to the position shown in the figure on the left.

3. Press **F2** [ RECORDER ].



: Memory recorder function



: Recorder function



: RMS recorder function

## 5.2.2 Setting the Time Axis Range and Sampling

- Set the speed for inputting and storing the waveform of the input signal.
- Time axis range setting expresses the time for 1 DIV.
- Sampling period settings start at 1  $\mu$ s (and range up to a maximum of 1 MS/s). The available range depends on the selected time axis range (input signal waveform capture rate).

### Method 1 Screen: STATUS 1, DISPLAY

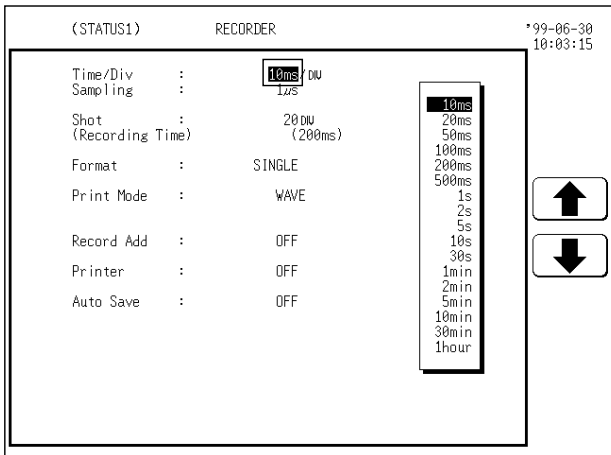

1. Call up the STATUS 1 or DISPLAY screen.
2. Move the flashing cursor to the time/div item, as shown in the figure on the left.
3. Use the JOG control or the function keys to make the selection.



: Move the cursor up in the selection window.



: Move the cursor down in the selection window.

#### NOTE

On the DISPLAY screen, the setting cannot be made with the JOG control.

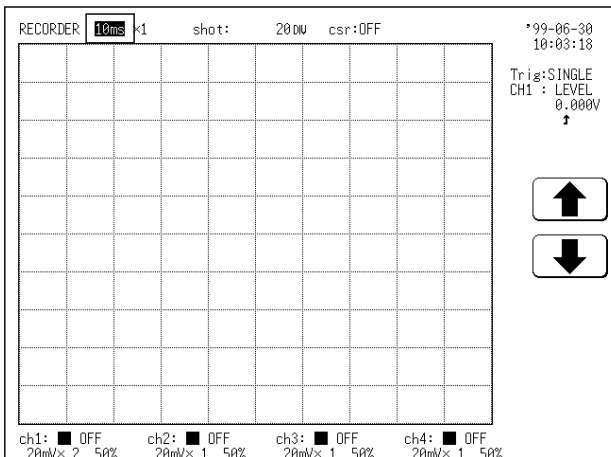

4. Set the sampling period (STATUS 1 screen only).

(Move the flashing cursor to the position shown in the figure on the left. Use the JOG control or the function keys to make the selection.)



: Move the cursor up in the selection window.



: Move the cursor down in the selection window.

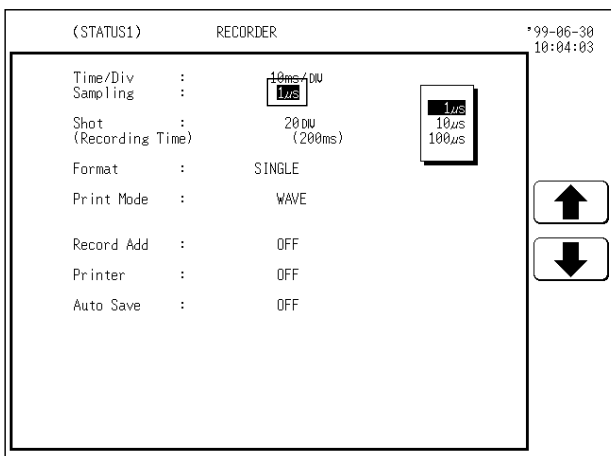



**Method 2** Screen: STATUS 1, DISPLAY

1. Call up the STATUS 1 or DISPLAY screen.
2. Use the TIME/DIV key to set the time axis range.

**NOTE**

- The TIME/DIV key can be used regardless of where the flashing cursor is located, if the STATUS 1 or DISPLAY screen is displayed.
- The sampling period cannot be changed on the DISPLAY screen.
- While the printer always outputs the data at the measurement magnification in recording mode, the waveform on the screen is reduced in size at the ratio shown in the table below, depending on the time-axis range.

Range	Compression ratio
50 ms/DIV	× 1/2
20 ms/DIV	× 1/10
10 ms/DIV	× 1/20

- When the printer is ON, the recording length, "continuous" cannot be set at a time axis range setting of 10 ms to 200 ms/DIV.

**Setting value of the sampling period**

Time axis range ( /DIV )	Sampling period					
	1 $\mu$ s	10 $\mu$ s	100 $\mu$ s	1 ms	10 ms	100 ms
10 ms				—	—	—
20 ms				—	—	—
50 ms				—	—	—
100 ms					—	—
200 ms					—	—
500 ms					—	—
1 s						—
2 s						—
5 s						—
10 s						
30 s						
1 min						
2 min						
5 min						
10 min						
30 min						
1 hour						

: can be set, —: can not be set

### 5.2.3 Setting the Recording Length

- The length of recording for one measurement operation (number of DIV) can be set.
- Two types of recording length can be set.  
 Fixed recording length mode:  
 Any recording length mode: Any recording length can be selected by the user.

**Method 1** (Fixed recording length mode)

Screen: STATUS 1, DISPLAY

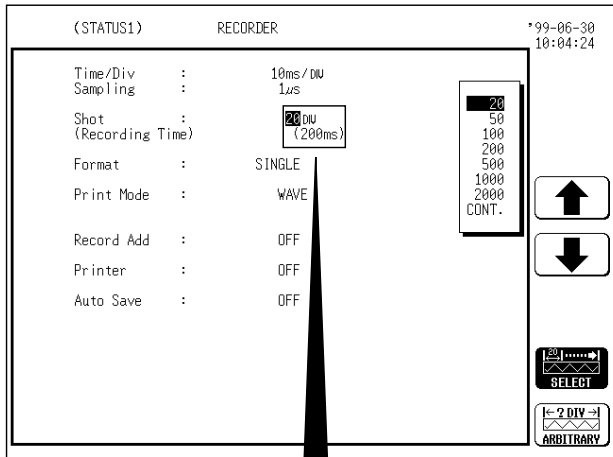

Shows the measurement time in the set time axis range and recording length.

1. Call up the STATUS 1 or DISPLAY screen.
2. Move the flashing cursor to the shot item, as shown in the figure on the left.
3. Use the JOG control or the function keys to make the selection.



: Move the cursor up in the selection window.



: Move the cursor down in the selection window.



: Set the fixed recording length mode.



: Set the any recording length mode.

**NOTE**

On the DISPLAY screen, the selection window is not displayed.

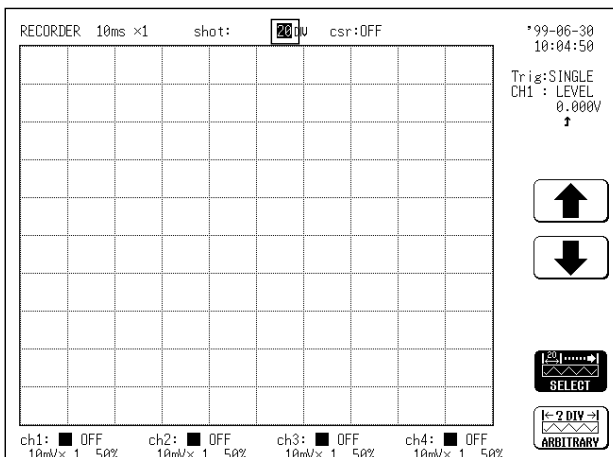

**Method 2 (Any recording length mode)**

Screen: STATUS 1, DISPLAY

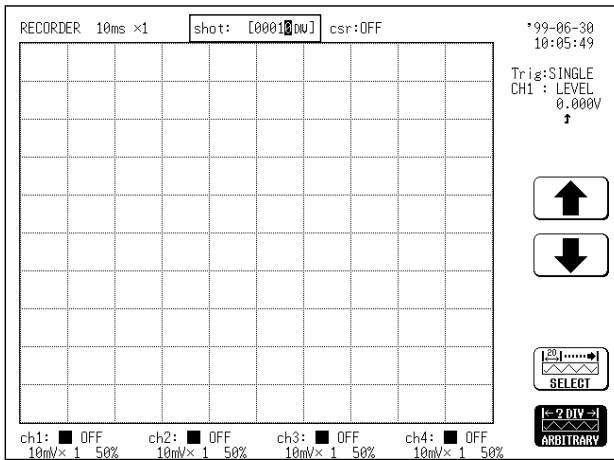
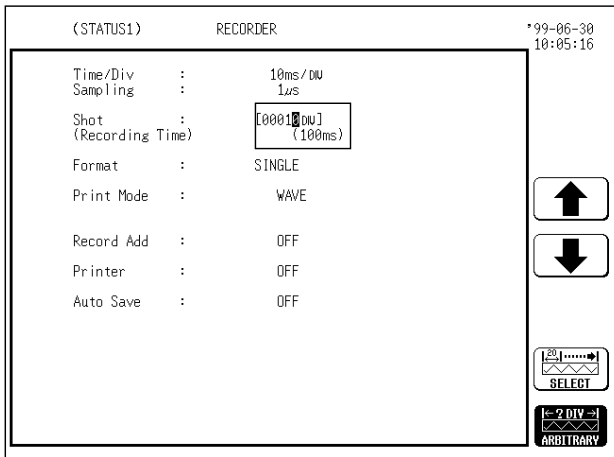

1. Call up the STATUS 1 or DISPLAY screen.
2. Move the flashing cursor to the shot item, as shown in the figure on the left.
3. Set the any recording length mode.
4. Use the JOG control or the function keys to make the selection. Use the cursor keys to change the column.



: Value up



: Value down



: Set the fixed recording length mode.



: Set the any recording length mode.

**NOTE**

- On the DISPLAY screen, the setting cannot be made with the JOG control.
- When time axis range is between 10 ms - 200 ms/DIV and recording length is set to CONTINUOUS, printer defaults to OFF.

## 5.2.4 Setting the Format

- The style can be set for showing input signals on the screen display and recording them on the printer.
- The styles single, dual, and quad are available.

### (1) Single

Display and record as one graph. (At the most, 8 analog + 16 logic signals)

Input waveform

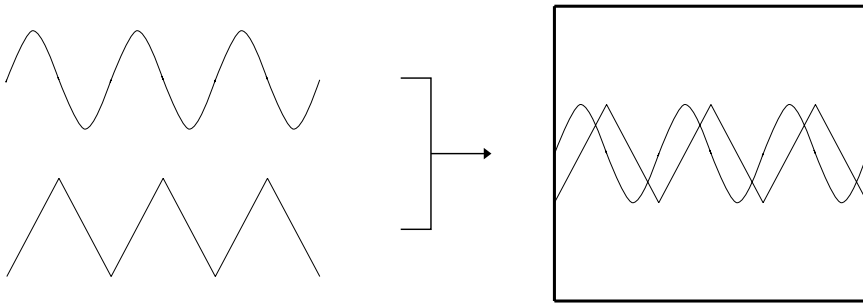

### (2) Dual

- Display and record as two graphs. (At the most, 8 analog + 16 logic signals)
- Specify which input channel to use for waveform graph display and recording.

Input waveform

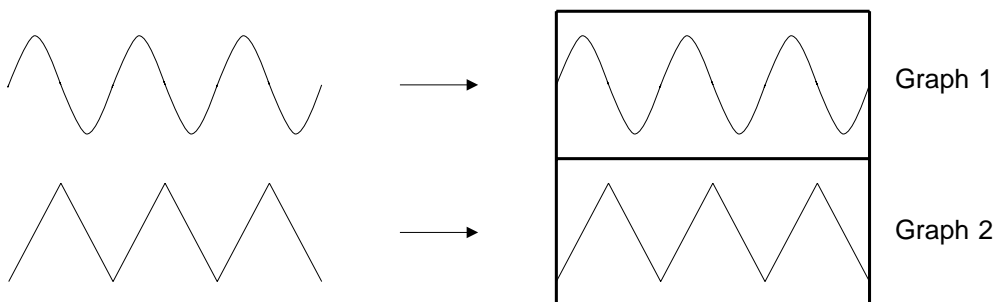

### (3) Quad

- Display and record as four graphs. (At the most, 8 analog + 16 logic signals)
- Specify which input channel to use for waveform graph display and recording.

Input waveform

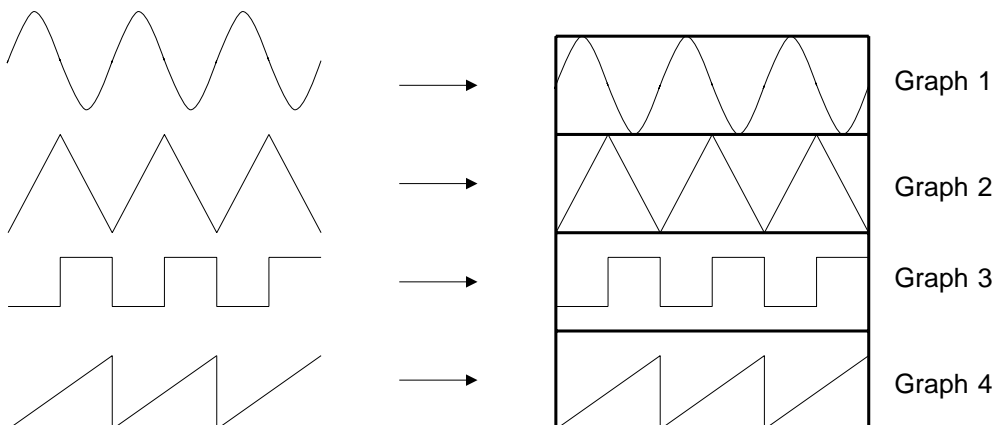

## Method Screen: STATUS 1

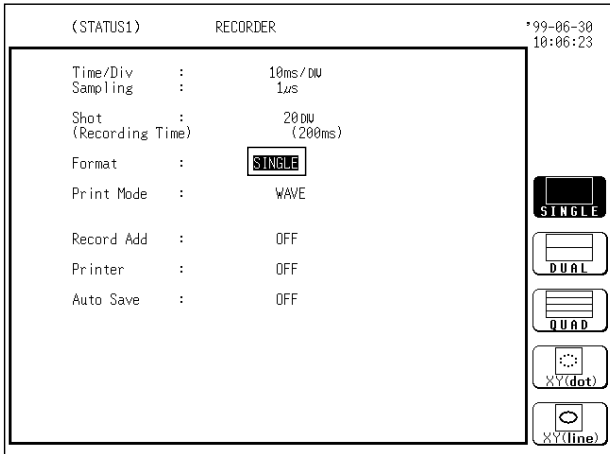

1. Press the **STATUS** key to call up the STATUS 1 screen.
2. Move the flashing cursor to the format item, as shown in the figure on the left.
3. Use the function keys to select the display format.

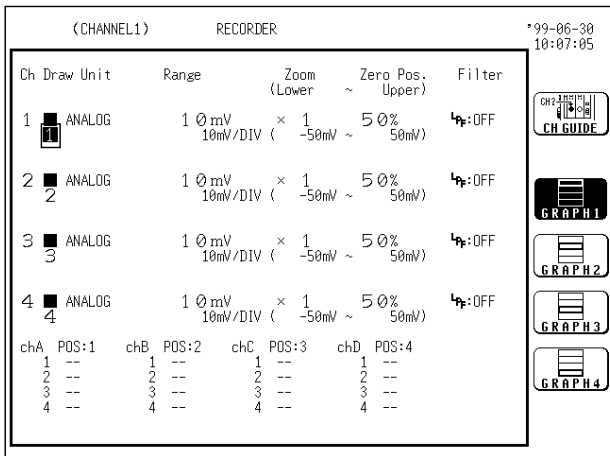
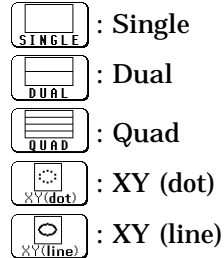

4. If dual or quad screen display was chosen in step 3, determine which input channel to display on which graph. This setting is made with the CHANNEL 1 screen.

- ① Press the **CHAN** key to call up the CHANNEL 1 screen.
- ② Use the **CH SELECT** key to open selected channel screen.
- ③ Move the flashing cursor to the point shown in the illustration at left.
  - The illustration shows the setting for CH1.
  - Settings for CH2 - CH8 should be made in the same way.

- ④ Use the function keys to select the graph.

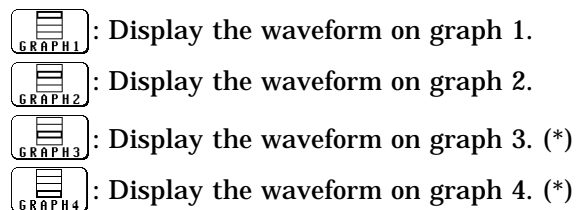

\*: when the quad screen display is selected

### Continuous X-Y plot

- Setting the display format to X-Y allows X-Y waveforms to be combined continuously.
- Selecting the X-Y display format changes the setting screen as shown in the figure below.

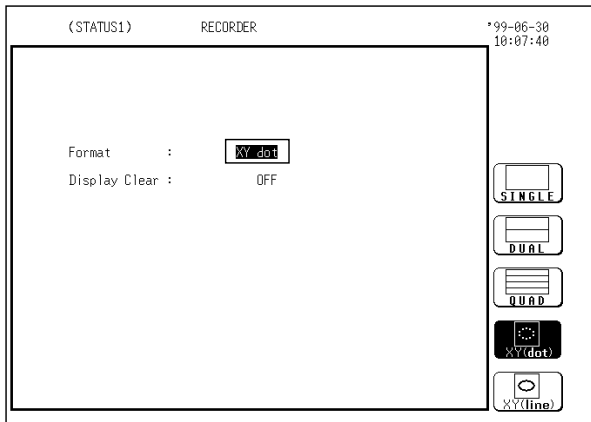

1. Use the function keys to select the display format.

- : Single
- : Dual
- : Quad
- : XY (dot)
- : XY (line)

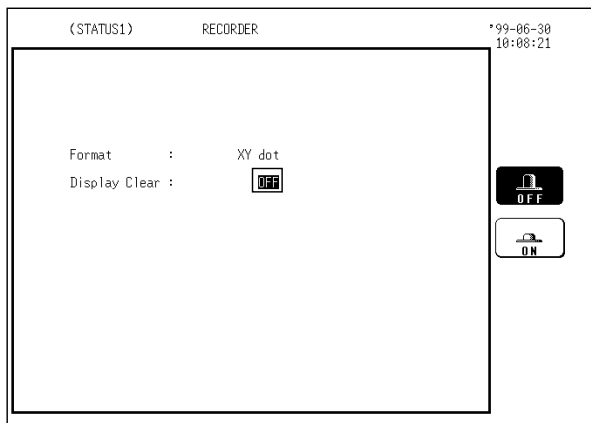

2. Select whether or not to clear any existing X-Y plot.

- : Do not clear the display window. The new recording is overlaid the existing one.
- : Clear the display window.

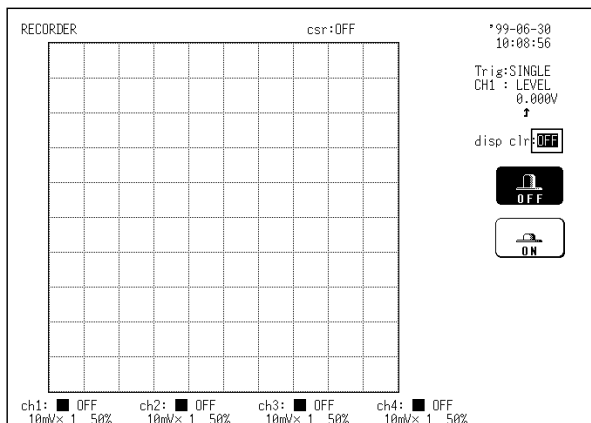

3. Press the **CHAN** key to call up the CHANNEL 1 screen.

4. Specify the X-axis channel.

- ① Move the cursor to the channel to be used as X axis, as shown at left.
- ② Use the function keys to select X axis.  
The remaining channel automatically becomes the Y-axis input.

**NOTE**

X-Y waveforms in the recorder function cannot be saved in TEXT format. Also, the waveforms cannot be saved automatically.

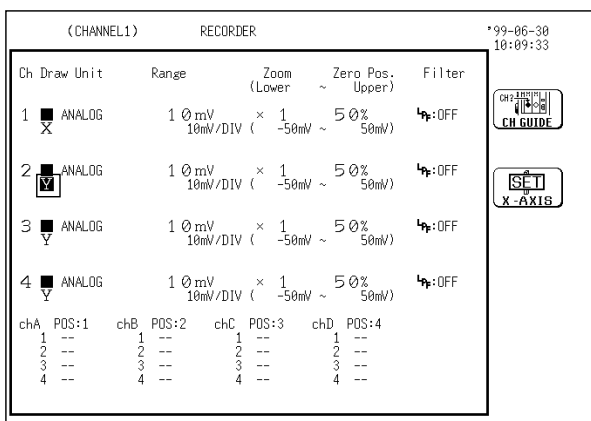

## 5.2.5 Setting the Printer Format

- Selects whether waveform data are printed as waveform or as numeric data.
- When numeric data are selected, the print interval also must be set.

### Printing as a waveform

#### Method

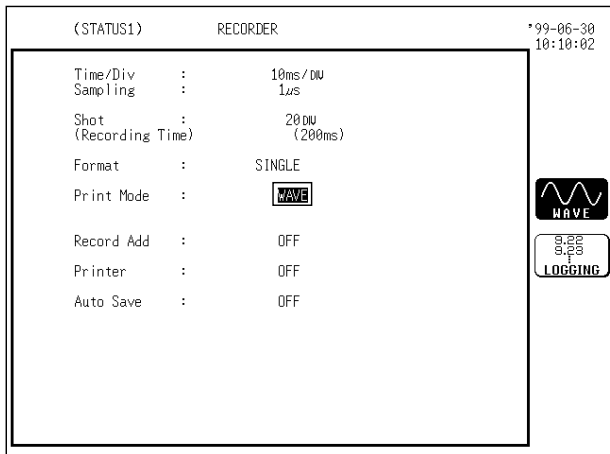

1. Press the **STATUS** key to call up the STATUS 1 screen.
2. Move the flashing cursor to the print mode item, as shown in the figure on the left
3. Use the function keys to select waveform.



: Waveform data are printed as a waveform.



: Waveform data are printed as numeric data.

#### NOTE

In the recorder, the trigger mark is written as the start position mark. In an additional recording (see Section 5.2.6), the trigger mark is displayed in front of the most recently entered data.

## Printing as numeric data

### Method

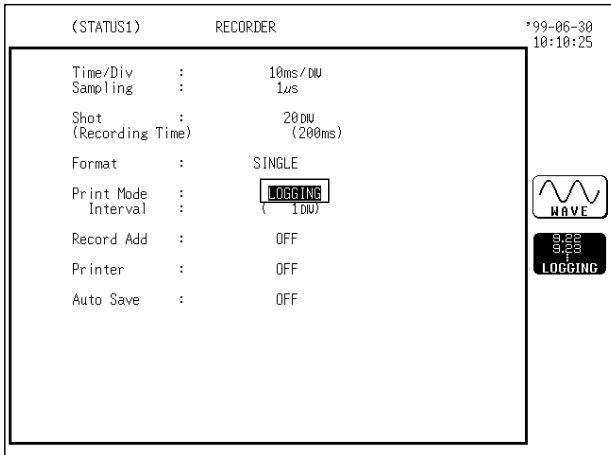

1. Press the **STATUS** key to call up the STATUS 1 screen.
2. Move the flashing cursor to the print mode item, as shown in the figure on the left
3. Use the function keys to select numeric data.



**WAVE**: Waveform data are printed as a waveform.

**LOGGING**: Waveform data are printed as numeric data.

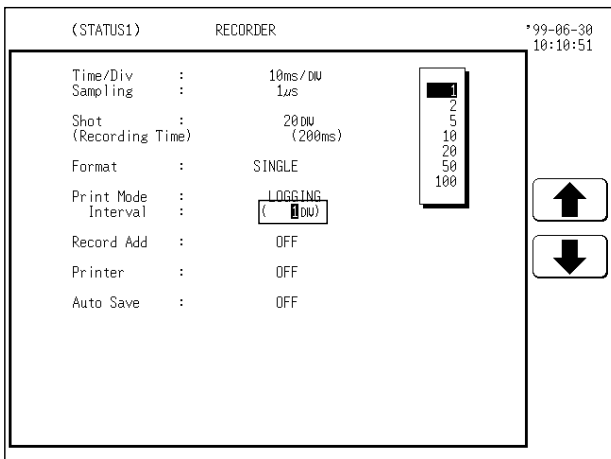

4. Move the flashing cursor to the print interval item.
5. Use the JOG control or the function keys to select the print interval.



**↑**: Move the cursor up in the selection window.

**↓**: Move the cursor down in the selection window.

**NOTE**

- When the print interval longer than the recording length is set, only the first dot is printed.
- The maximum and minimum values are printed (see Section Appendix 3.4).
- The print intervals of 0.01 to 0.5 DIV can be selected, only when there are waveform data present.



## 5.2.6 Setting the Additional Recording Function

- This records, regarding the memory as though it were recording paper.
- The last 2000 divisions of waveform can be held in memory.
- The waveform can be scrolled and printed.

Switching the additional recording on and off affects the use of memory as shown below.

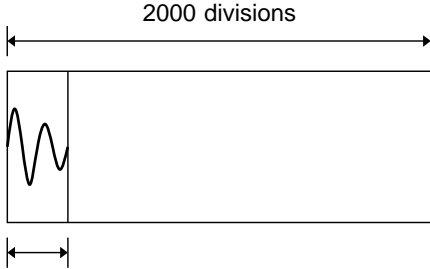
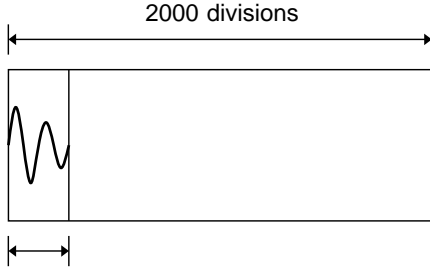
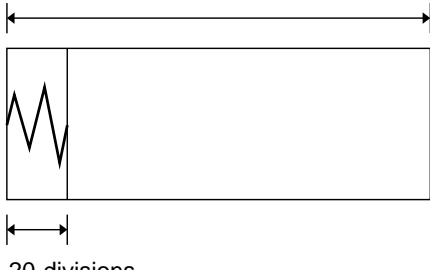
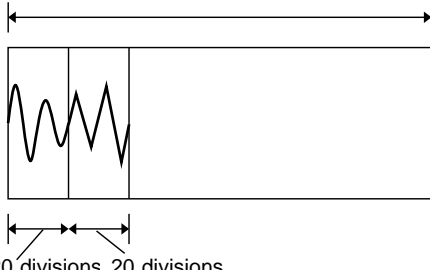
Additional recording OFF	Additional recording ON
<p>1. Recording 20 divisions of waveform</p>  <p>2000 divisions</p> <p>20 divisions</p>	<p>1. Recording 20 divisions of waveform</p>  <p>2000 divisions</p> <p>20 divisions</p>
<p>2. Recording another 20 divisions of waveform</p> <p>The first set of measurement data is discarded, and recording of the second set of measurement data starts again from the beginning of memory.</p>  <p>2000 divisions</p> <p>20 divisions</p>	<p>2. Recording another 20 divisions of waveform</p> <p>The first set of measurement data is preserved, and recording of the second set of measurement data starts after the first set.</p>  <p>2000 divisions</p> <p>20 divisions 20 divisions</p> <p>The first and second sets of waveforms can be observed by scrolling or printing the waveform.</p>

## Method

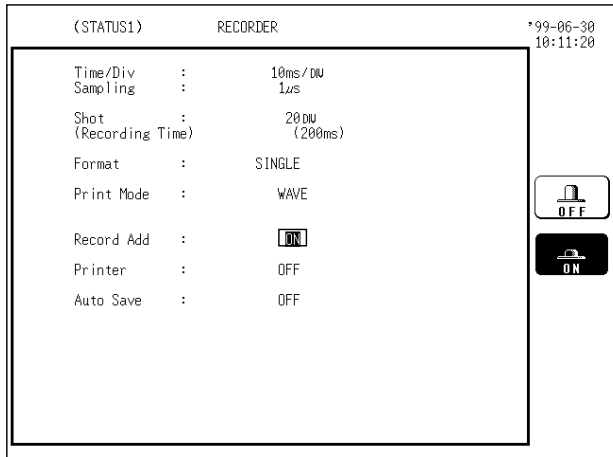

1. Press the **STATUS** key to call up the STATUS 1 screen.
2. Move the flashing cursor to the additional recording item, as shown in the figure on the left
3. Use the function keys to make the selection.

 : Additional recording is disabled.

 : Additional recording is enabled.

### NOTE

- Time values output to the printer and displayed on the screen with the additional recording function enabled are equal to those of the most recently acquired waveforms. Therefore, when measuring waveforms in a different time axis range, always take that difference into consideration.
- The voltage axis range is determined by the most recently acquired waveforms.

## 5.2.7 Setting the Printer Function (Real Time Printing)

The input waveform is continuously printed in real time.

### Method

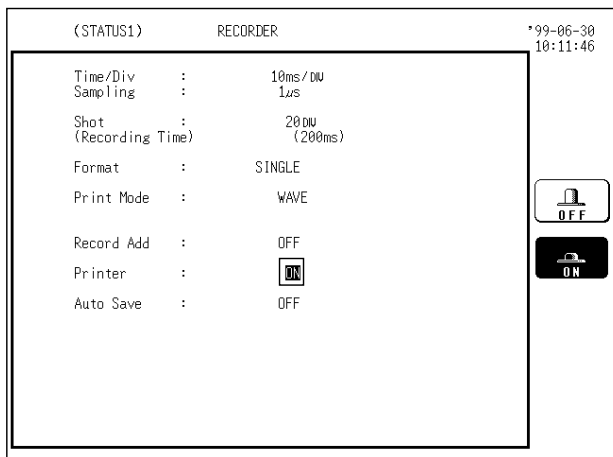

1. Press the **STATUS** key to call up the STATUS 1 screen.
2. Move the flashing cursor to the printer item, as shown in the figure on the left
3. Use the function keys to make the selection.

 : Printing is disabled.

 : Printing is enabled.

### NOTE

See Section 10.7.3.

## 5.2.8 Setting the Auto Save Function

When the function is enabled, waveform data are automatically stored on a floppy disk or PC card after they are captured.

### Method

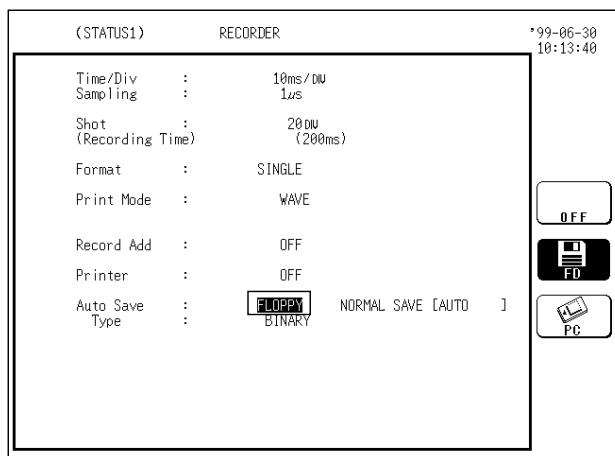

1. Press the **STATUS** key to call up the STATUS 1 screen.
2. Move the flashing cursor to the auto save item, as shown in the figure on the left.
3. Use the function keys to select the media.



**OFF** : Auto save is disabled.



**FLOPPY** : Waveform data are automatically stored on floppy disk



**PC** : Waveform data are automatically stored on PC card.

#### NOTE

The LAN selection is available only when a LAN is connected.

4. Selecting Media displays saving data options.



**NORMAL SAVE** : Cancels automatic save when media is full.



**DEL. SAVE** : Deletes old files and automatically saves when media is full.

#### NOTE

In delete save, file is saved as REC. extension file in binary format and TXT. extension file in text format.

5. File naming

See Section 9.5.5 for entry options.

In automatic save, file is titled with a number following the file name.

When file is left untitled during processing, AUTO automatically executes.

#### NOTE

- File name contains eight alphanumeric characters. In automatic save the last character may be replaced with a number to designate the file.
- If the A/B cursors are used, partial save is applied (see Section 13.4.5). However, when additional recording is enabled, partial save cannot be performed. A/B cursors are disabled automatically.

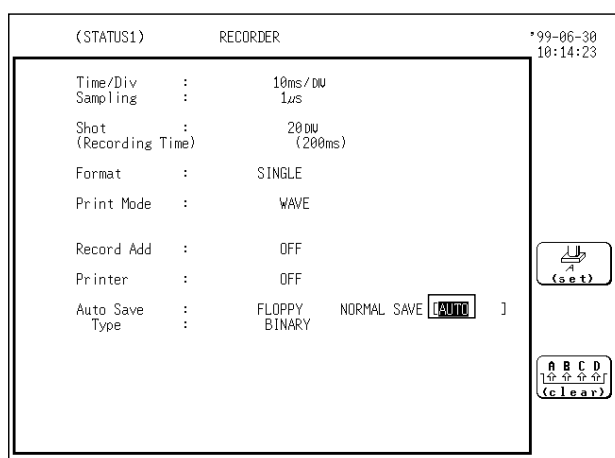
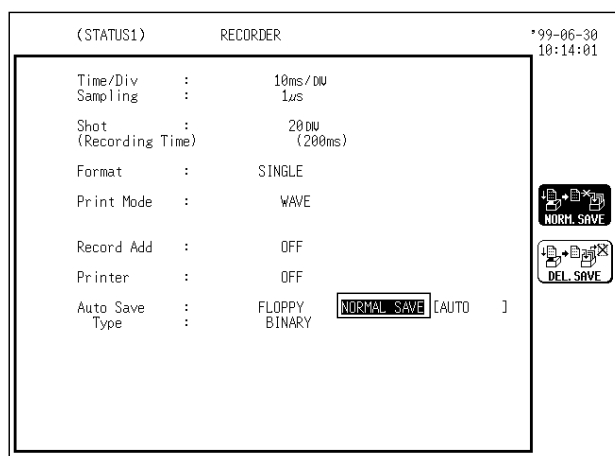

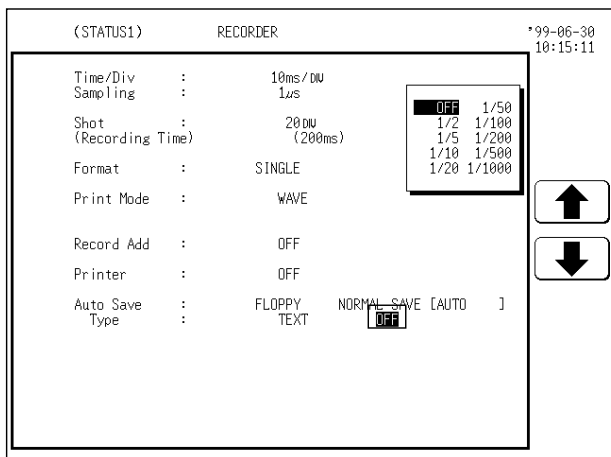
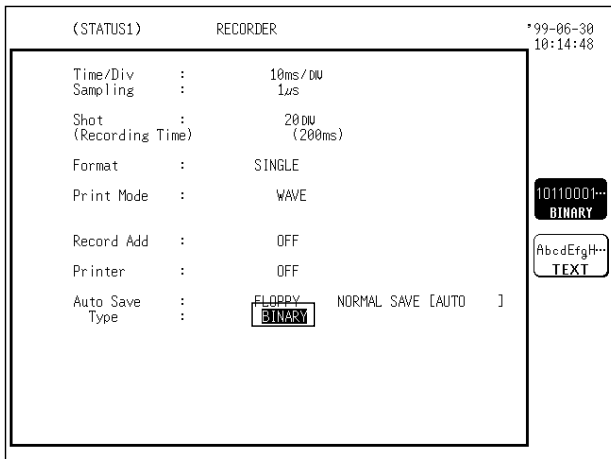
**NOTE**

- In automatic save channels cannot be selected. Only current channel displaying waveform is saved.
- A file is stored in the directory currently selected on the file screen.
- Only a limited number of directories and files can be stored in the directory.
- When the recording length is "continuous", the auto save function is disabled.
- When the auto save function is used while the additional recording function is ON, only newly acquired waveform data is stored. (In this case, the A/B cursors are set OFF.)
- X-Y combined waveforms cannot be stored automatically.
- If the data quantity is too large, it may not fit on a floppy diskette or PC Card. For the size of a file, see Section Appendix 4.

6. Use the function keys to select the data store principle.

10110001...  
BINARY : Data are stored as binary data.

AbcdEfgH...  
TEXT : Data are stored as text data.

**NOTE**

- Data stored in the text format is not readable by the 8835-01.
- When the characters below are used in a file, the file cannot be handled on a PC running Windows 2000 or XP. Do not use these characters when handling a file on your PC.  
+, =, [, ]

7. Selected TEXT in save options opens Thinning.

Use the JOG control or the function keys to make the selection.

## 5.2.9 Setting the Trigger

Select the trigger that is suitable for the signal to be captured.  
For details, see Chapter 8.

## 5.2.10 Input Channel Settings

The settings differ for each unit.  
See the settings for each unit in Chapter 7.

## 5.3 Settings on the Display Screen

Explains the setting items on the Display screen.

### 5.3.1 Setting Compression Along the Time Axis

- The compression ratio along the time axis can be set.
- By compressing the waveform, an entire change can be promptly apprehended.

#### Method

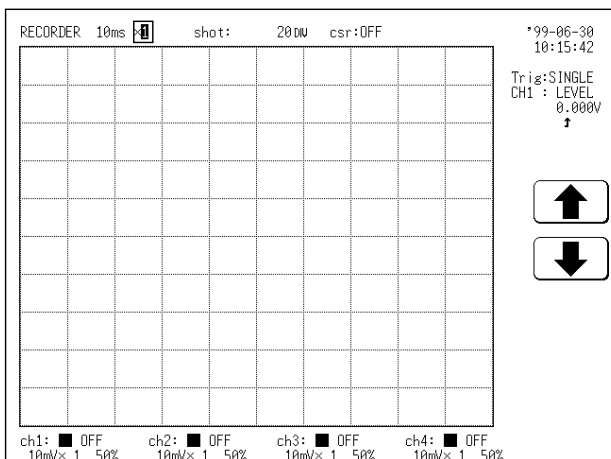

1. Move the flashing cursor to the position shown in the figure on the left.

2. Use the function keys to select the compression ratio.

 : Ratio up

 : Ratio down

#### NOTE

- The compression factor can be changed also after measurement is completed.
- While the printer always outputs the data at the measurement magnification in recording mode, the waveform on the screen is reduced in size at the ratio shown in the table below, depending on the time-axis range.

Range	Compression ratio
50 ms/DIV	× 1/2
20 ms/DIV	× 1/10
10 ms/DIV	× 1/20

**Reference** The  key can be used to check which position within the entire recording length is occupied by the currently shown waveform (see Section 3.1.7).

---

## 5.4 Start and Stop Measurement Operation

### Method

1. Press the **START** key to initiate measurement or set the unit to trigger standby.
2. Press the **STOP** key during measurement to stop the measurement.  
(see Section 3.1.4.)

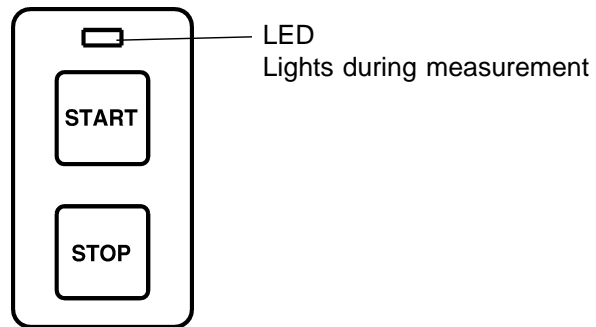

# 5.5 Print Examples

Single screen (The list and gauge functions are enabled.)

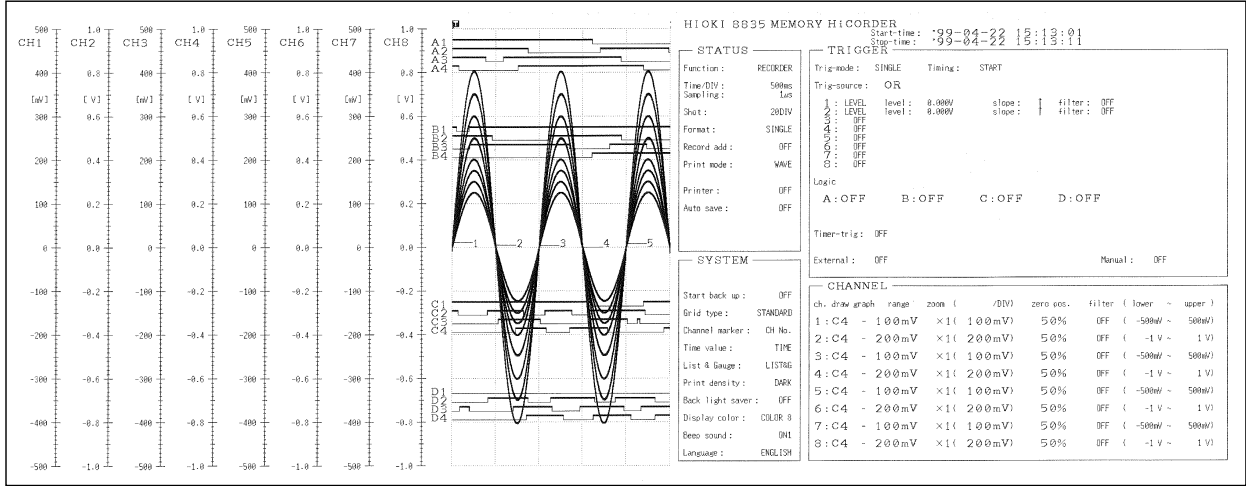

Dual screen (The gauge function is enabled.)

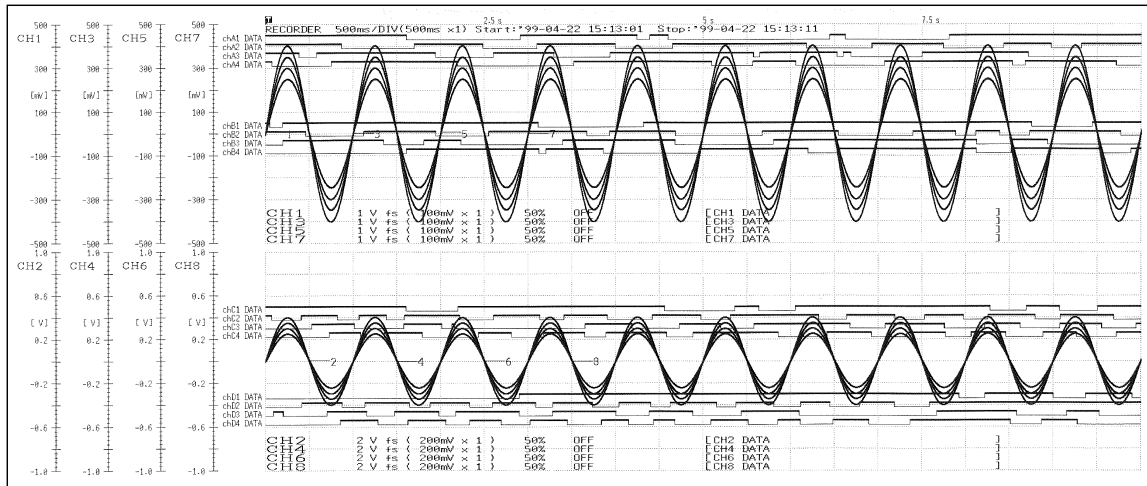

Quad screen (The gauge function is enabled.)

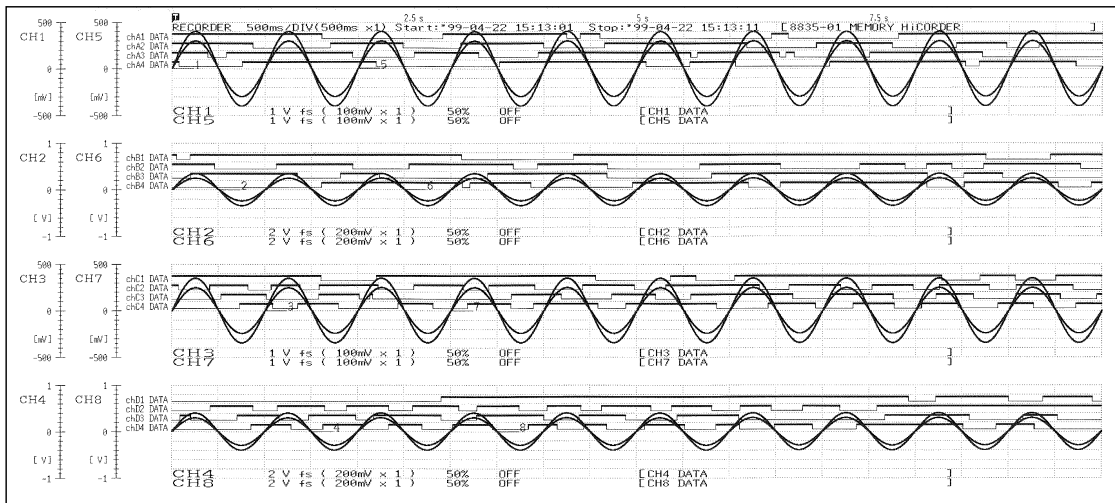

# Report

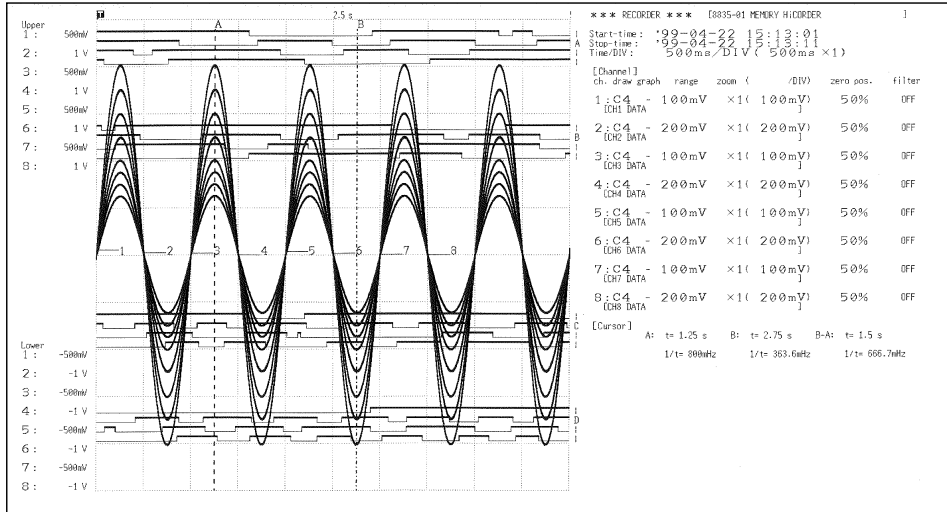

# List

STATUS		TRIGGER	
Function:	RECORDER	Trig-mode:	SINGLE
Time/DIV:	500ms	Trig-source:	OR
Sampling:	1us	1: LEVEL level: 0.000V slope:   filter: OFF	
Shot:	200DIV	2: LEVEL level: 0.000V slope:   filter: OFF	
Format:	SINGLE	3: LEVEL level: 0.000V slope:   filter: OFF	
Record add:	OFF	4: LEVEL level: 0.000V slope:   filter: OFF	
Print mode:	WAVE	5: LEVEL level: 0.000V slope:   filter: OFF	
Printer:	OFF	6: LEVEL level: 0.000V slope:   filter: OFF	
Auto save:	OFF	7: LEVEL level: 0.000V slope:   filter: OFF	
		8: LEVEL level: 0.000V slope:   filter: OFF	
		Logic	
		A: OFF B: OFF C: OFF D: OFF	
		Timer-trig: OFF	
		External: OFF Manual: OFF	
SYSTEM		CHANNEL	
Start back up:	OFF	ch. draw graph range zoom ( /DIV) zero pos. filter ( lower ~ upper )	
Grid type:	STANDARD	1: C4 - 1.00mV x1( 1.00mV) 50% OFF ( -500mV ~ 500mV)	
Channel marker:	CH No.	2: C4 - 2.00mV x1( 2.00mV) 50% OFF ( -1V ~ 1V)	
Time value:	TIME	3: C4 - 1.00mV x1( 1.00mV) 50% OFF ( -500mV ~ 500mV)	
List & Gauge:	GAUGE	4: C4 - 2.00mV x1( 2.00mV) 50% OFF ( -1V ~ 1V)	
Print density:	DNK	5: C4 - 1.00mV x1( 1.00mV) 50% OFF ( -500mV ~ 500mV)	
Back light saver:	OFF	6: C4 - 2.00mV x1( 2.00mV) 50% OFF ( -1V ~ 1V)	
Display color:	COLOR 8	7: C4 - 1.00mV x1( 1.00mV) 50% OFF ( -500mV ~ 500mV)	
Beep sound:	ONI	8: C4 - 2.00mV x1( 2.00mV) 50% OFF ( -1V ~ 1V)	
Language:	ENGLISH		

# Numeric data

Start-time: \*99-04-22 15:11:08 Stop-time: \*99-04-22 15:11:11  
 Title: 8835-01 MEMORY RECORDER  
 Comment:

(time)	CH1	CH2	CH3	CH4	A	B	C	D
	CH5	CH6	CH7	CH8	1234	1234	1234	1234
0 s	11.075mV	5mV	4.375mV	12.5mV	1111	1100	1100	0000
	-1.25mV	-8.75mV	-7.5mV	-2.5mV				
	0.75mV	10mV	9.375mV	1.25mV				
	-3.125mV	-7.5mV	-7.5mV	-3.75mV				
500ms	0 V	10mV	9.375mV	1.25mV	0 V	1100	1010	0100
	-13.75mV	-3.75mV	-1.125mV	-13.75mV				
	0.75mV	10mV	9.375mV	1.25mV				
	-9.375mV	-1.25mV	-1.25mV	-10mV				
1.000 s	11.075mV	5mV	4.375mV	12.5mV	1011	1010	1011	0011
	-1.25mV	-8.75mV	-7.5mV	-2.5mV				
	0.75mV	10mV	9.375mV	1.25mV				
	-3.125mV	-7.5mV	-7.5mV	-3.75mV				
1.500 s	0 V	10mV	9.375mV	1.25mV	0 V	1100	1011	0110
	-13.75mV	-3.75mV	-1.125mV	-13.75mV				
	0.75mV	10mV	9.375mV	1.25mV				
	-9.375mV	-1.25mV	-1.25mV	-10mV				
2.000 s	11.075mV	5mV	4.375mV	12.5mV	0101	1011	0110	0101
	-1.25mV	-8.75mV	-7.5mV	-2.5mV				
	0.75mV	10mV	9.375mV	1.25mV				
	-3.125mV	-7.5mV	-7.5mV	-3.75mV				
2.500 s	0 V	10mV	9.375mV	1.25mV	0 V	0000	1001	1001
	-13.75mV	-3.75mV	-1.125mV	-13.75mV				
	0.75mV	10mV	9.375mV	1.25mV				
	-9.375mV	-1.25mV	-1.25mV	-10mV				
3.000 s	11.075mV	5mV	4.375mV	12.5mV	1010	1101	1100	1100
	-1.25mV	-8.75mV	-7.5mV	-2.5mV				
	0.75mV	10mV	9.375mV	1.25mV				
	-3.125mV	-7.5mV	-7.5mV	-3.75mV				
3.500 s	0 V	10mV	9.375mV	1.25mV	0 V	1100	0111	1101
	-13.75mV	-3.75mV	-1.125mV	-13.75mV				
	0.75mV	10mV	9.375mV	1.25mV				
	-9.375mV	-1.25mV	-1.25mV	-10mV				
4.000 s	12.5mV	5mV	4.375mV	12.5mV	1011	0110	1011	1011
	-1.25mV	-8.75mV	-7.5mV	-2.5mV				
	0.75mV	10mV	9.375mV	1.25mV				
	-3.125mV	-7.5mV	-7.5mV	-3.75mV				
4.500 s	0 V	10mV	9.375mV	1.25mV	0 V	1111	1101	1011
	-13.75mV	-3.75mV	-1.125mV	-13.75mV				
	0.75mV	10mV	9.375mV	1.25mV				
	-9.375mV	-1.25mV	-1.25mV	-10mV				
5.000 s	12.5mV	5mV	4.375mV	12.5mV	0111	1001	0011	1100
	-1.25mV	-8.75mV	-7.5mV	-2.5mV				
	0.75mV	10mV	9.375mV	1.25mV				
	-3.125mV	-7.5mV	-7.5mV	-3.75mV				
5.500 s	0 V	10mV	9.375mV	1.25mV	0 V	0110	1001	1101
	-13.75mV	-3.75mV	-1.125mV	-13.75mV				
	0.75mV	10mV	9.375mV	1.25mV				
	-9.375mV	-1.25mV	-1.25mV	-10mV				
6.000 s	12.5mV	5mV	4.375mV	12.5mV	0111	1111	0110	1011
	-1.25mV	-8.75mV	-7.5mV	-2.5mV				
	0.75mV	10mV	9.375mV	1.25mV				
	-3.125mV	-7.5mV	-7.5mV	-3.75mV				
6.500 s	0 V	10mV	9.375mV	1.25mV	0 V	1010	1101	1001
	-13.75mV	-3.75mV	-1.125mV	-13.75mV				
	0.75mV	10mV	9.375mV	1.25mV				
	-9.375mV	-1.25mV	-1.25mV	-10mV				
7.000 s	12.5mV	5mV	4.375mV	12.5mV	0100	1011	1100	1100
	-1.25mV	-8.75mV	-7.5mV	-2.5mV				
	0.75mV	10mV	9.375mV	1.25mV				
	-3.125mV	-7.5mV	-7.5mV	-3.75mV				
7.500 s	0 V	10mV	9.375mV	1.25mV	0 V	0111	1111	1011
	-13.75mV	-3.75mV	-1.125mV	-13.75mV				
	0.75mV	10mV	9.375mV	1.25mV				
	-9.375mV	-1.25mV	-1.25mV	-10mV				



# Chapter 6

## RMS Recorder Function

### 6.1 Outline

#### 6.1.1 Outline of the RMS Recorder Function

The RMS recorder function has the following features.

- (1) The voltage value and DC signal for the commercial power supplies are displayed and recorded as the rms value.
- (2) Real time continuous recording
- (3) The 8835-01 is designed to measure commercial power supplies (50/60 Hz) and DC signal.
- (4) Time axis setting  
5 s/DIV to 1 h/DIV
- (5) Time axis resolution 100 points/DIV (printer)
- (6) Sampling speed  
20 rms data/s (200  $\mu$ s fixed)
- (7) Waveform magnification/compression display and printout
  - Time axis direction:  $\times 1$  to  $\times 1/200$
  - Voltage axis direction:  $\times 10$  to  $\times 1/2$
 With the variable function
- (8) Display format  
Time axis waveform: single, dual, quad screen display
- (9) Scrollable display
  - The most recent 2000 divisions<sup>(\*1)</sup> of the data are stored in memory.
  - It is possible to scroll back for easy review.
- (10) Additional recording function
- (11) Logging function  
Numeric printout of waveform data
- (12) Reprint function  
The most recent 2000 divisions<sup>(\*1)</sup> of the data stored in memory can be printed as many times as required.  
\*1: See "Waveform storage" in Section 14.5.

## 6.1.2 Operation Sequence

The flowchart below illustrates the sequence of operations involved in using the RMS recorder function.

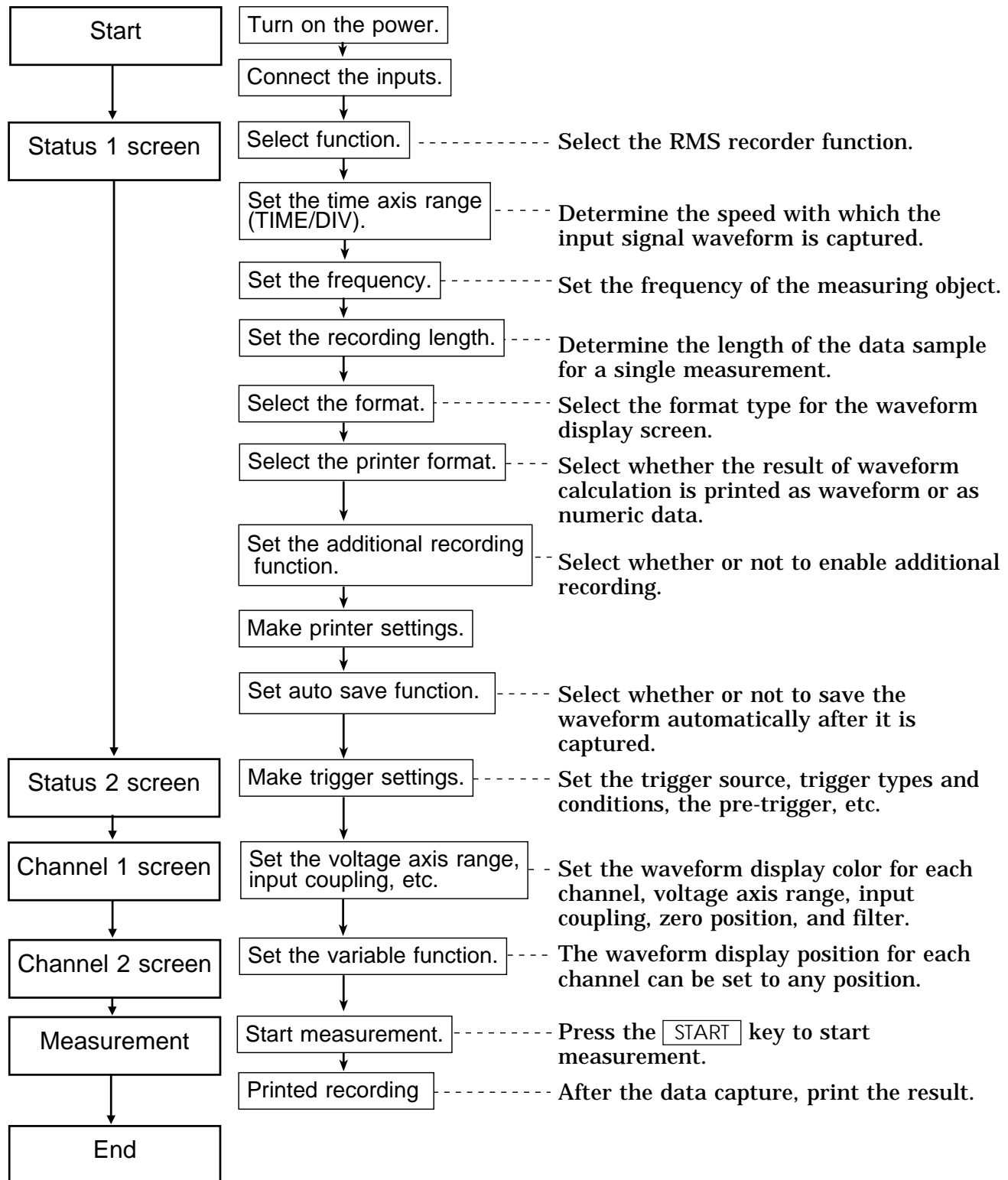

## 6.2 Making Settings

### 6.2.1 Setting the Function Mode

The 8835-01 has three function modes: the memory recorder function mode, the recorder function mode, and the RMS recorder function mode. Select the RMS recorder function.

**Method** Screen: STATUS 1, 2, CHANNEL, DISPLAY

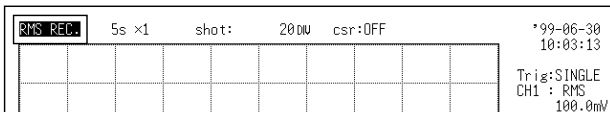
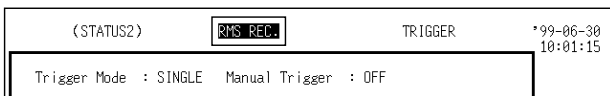

1. Call up the STATUS 1, 2, CHANNEL or DISPLAY screen.

2. Move the flashing cursor to the position shown in the figure on the left.

3. Press **F3** [ RMS ].



: Memory recorder function



: Recorder function



: RMS recorder function

## 6.2.2 Setting the Time Axis Range

- Set the speed for inputting and storing the waveform of the input signal.
- Time axis range setting expresses the time for 1 DIV.
- The sampling interval is constant, regardless of the time axis range.

### Method 1 Screen: STATUS 1, DISPLAY

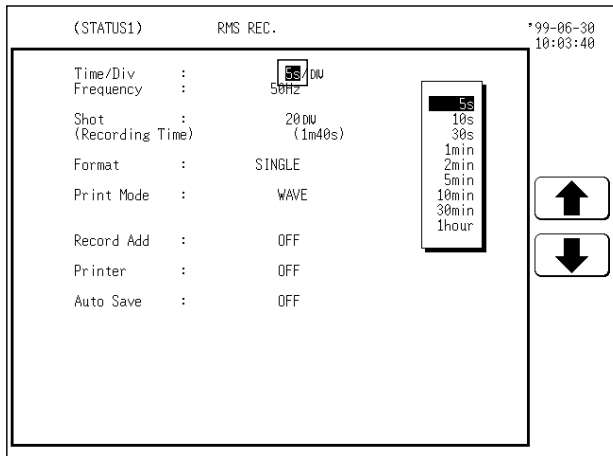

1. Call up the STATUS 1 or DISPLAY screen.
2. Move the flashing cursor to the time/div item, as shown in the figure on the left.
3. Use the JOG control or the function keys to make the selection.



: Move the cursor up in the selection window.



: Move the cursor down in the selection window.

#### NOTE

On the DISPLAY screen, the selection window is not displayed.

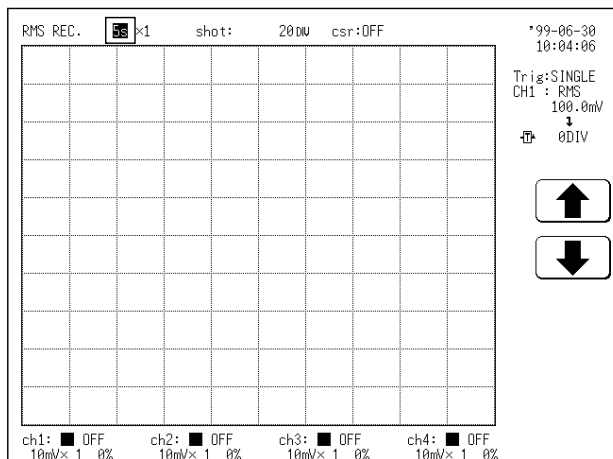

### Method 2 Screen: STATUS 1, DISPLAY

1. Call up the STATUS 1 or DISPLAY screen.
2. Use the TIME/DIV key to make the selection.

#### NOTE

The TIME/DIV key can be used regardless of where the flashing cursor is located, if the STATUS 1 or DISPLAY screen is displayed.

## 6.2.3 Setting the Frequency

Serves to set the frequency of the signal to be measured.

### Method

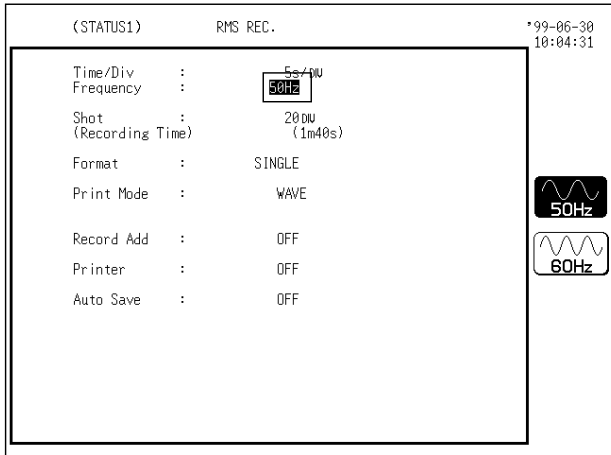

1. Press the **STATUS** key to call up the STATUS 1 screen.

2. Move the flashing cursor to the frequency item, as shown in the figure on the left.

3. Use the function keys to make the selection.

 : Measure rms value of 50 Hz signal

 : Measure rms value of 60 Hz signal

## 6.2.4 Setting the Recording Length

- The length of recording for one measurement operation (number of DIV) can be set.
- Two types of recording length can be set.  
 Fixed recording length mode:  
 Any recording length mode: Any recording length can be selected by the user.

### Method 1 (Fixed recording length mode)

Screen: STATUS 1, DISPLAY

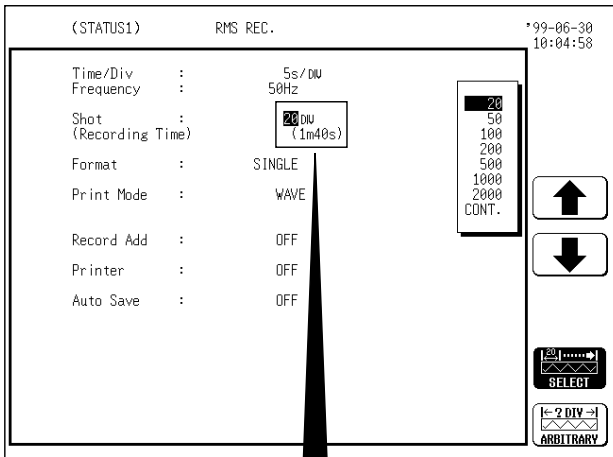

1. Call up the STATUS 1 or DISPLAY screen.
2. Move the flashing cursor to the shot item, as shown in the figure on the left.
3. Use the JOG control or the function keys to make the selection.

- : Move the cursor up in the selection window.
- : Move the cursor down in the selection window.
- : Set the fixed recording length mode.
- : Set the any recording length mode.

**NOTE**

On the DISPLAY screen, the selection window is not displayed.

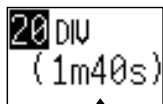

Shows the measurement time in the set time axis range and recording length.

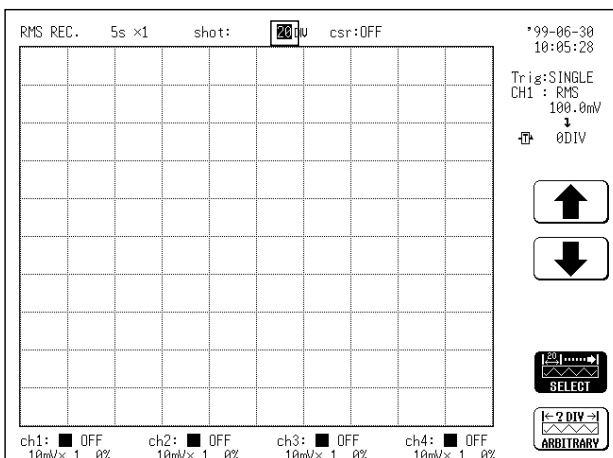

## Method 2 (Any recording length mode)

Screen: STATUS 1, DISPLAY

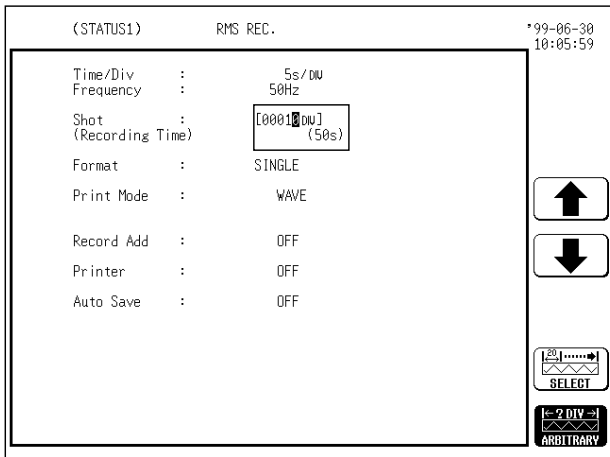

1. Call up the STATUS 1 or DISPLAY screen.
2. Move the flashing cursor to the shot item, as shown in the figure on the left.
3. Set the any recording length mode.
4. Use the JOG control or the function keys to make the selection. Use the cursor keys to change the column.



: Value up



: Value down



: Set the fixed recording length mode.



: Set the any recording length mode.

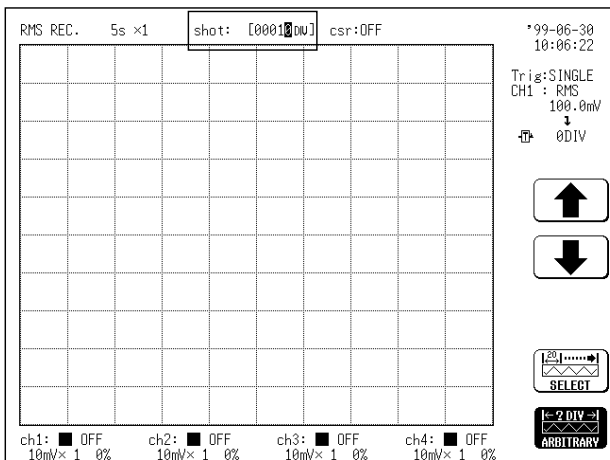

### NOTE

On the DISPLAY screen, the setting cannot be made with the JOG control.

## 6.2.5 Setting the Format

- The style can be set for showing input signals on the screen display and recording them on the printer.
- The styles single, dual, and quad are available.

### (1) Single

Display and record as one graph. (At the most, 8 analog + 16 logic signals)

Input waveform

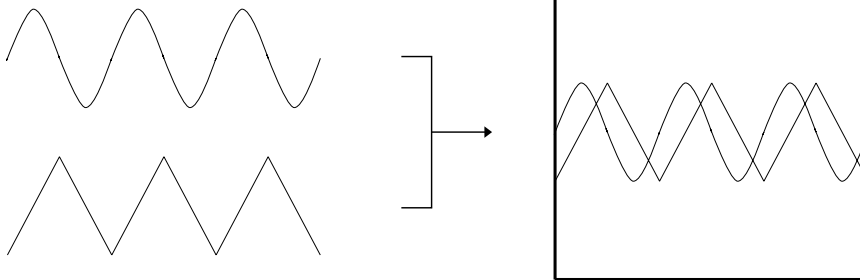

### (2) Dual

- Display and record as two graphs. (At the most, 8 analog + 16 logic signals)
- Specify which input channel to use for waveform graph display and recording.

Input waveform

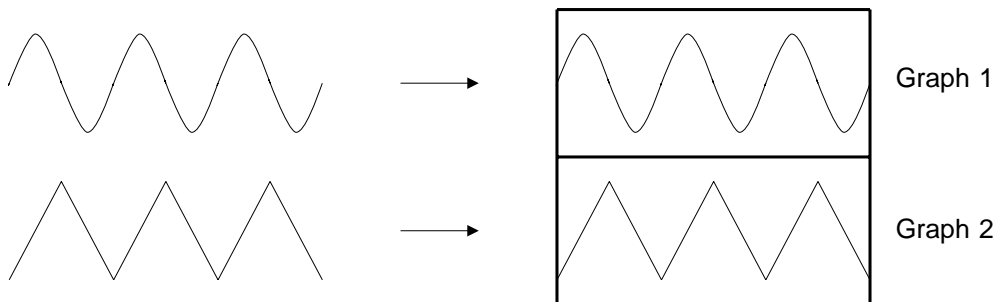

### (3) Quad

- Display and record as four graphs. (At the most, 8 analog + 16 logic signals)
- Specify which input channel to use for waveform graph display and recording.

Input waveform

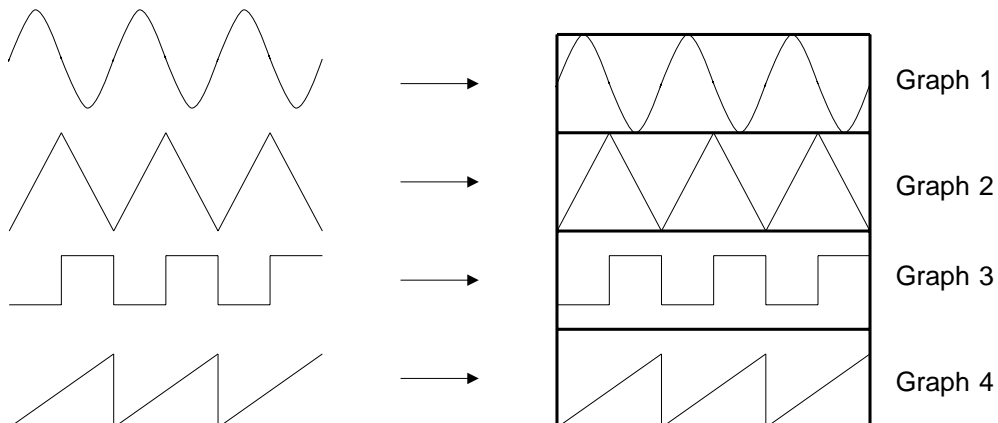

**NOTE**

Waveform displayed and recorded with RMS recorder is specified as RMS waveform.



## Method Screen: STATUS 1

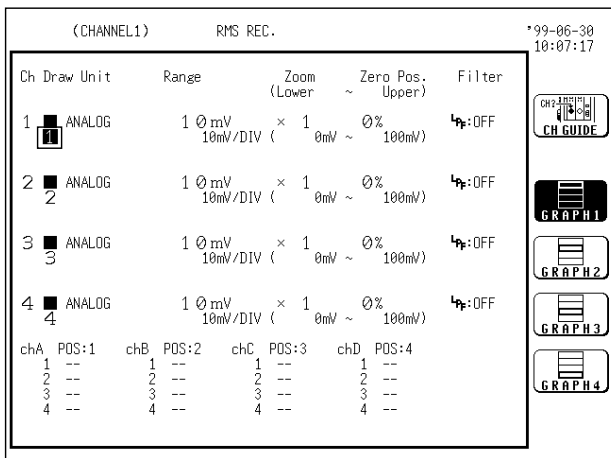
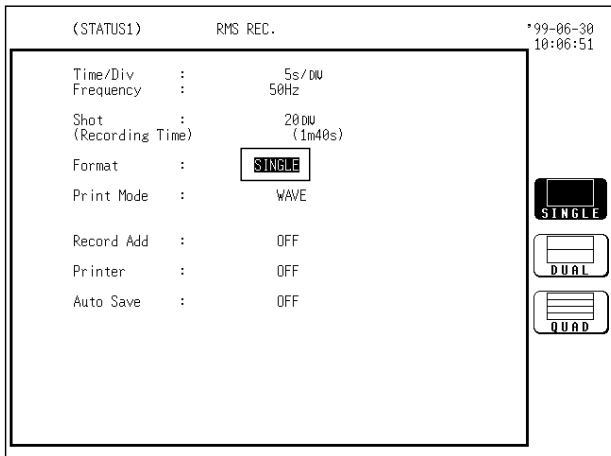

1. Press the **STATUS** key to call up the STATUS 1 screen.
2. Move the flashing cursor to the format item, as shown in the figure on the left.
3. Use the function keys to select the display format.

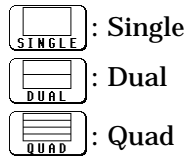

4. If dual or quad screen display was chosen in step 3, determine which input channel to display on which graph. This setting is made with the CHANNEL 1 screen.

- ① Press the **CHAN** key to call up the CHANNEL 1 screen.
- ② Use the **CH SELECT** key to open selected channel screen.
- ③ Move the flashing cursor to the point shown in the illustration at left.
  - The illustration shows the setting for CH1.
  - Settings for CH2 - CH8 should be made in the same way.
- ④ Use the function keys to select the graph.
  - GRAPH 1** : Display the waveform on graph 1.
  - GRAPH 2** : Display the waveform on graph 2.
  - GRAPH 3** : Display the waveform on graph 3. (\*)
  - GRAPH 4** : Display the waveform on graph 4. (\*)

\*: when the quad screen display is selected

## 6.2.6 Setting the Printer Format

- Selects whether waveform data are printed as waveform or as numeric data.
- When numeric data are selected, the print interval also must be set.

### Printing as a waveform

#### Method

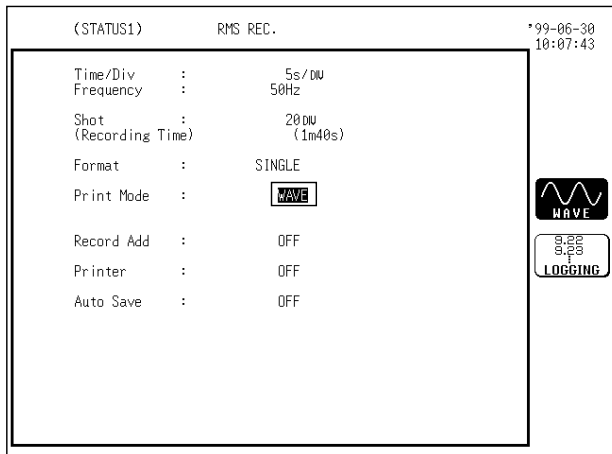

1. Press the **STATUS** key to call up the STATUS 1 screen.
2. Move the flashing cursor to the print mode item, as shown in the figure on the left.
3. Use the function keys to make the selection.



: Waveform data are printed as a waveform.





: Waveform data are printed as numeric data.

## Printing as numeric data

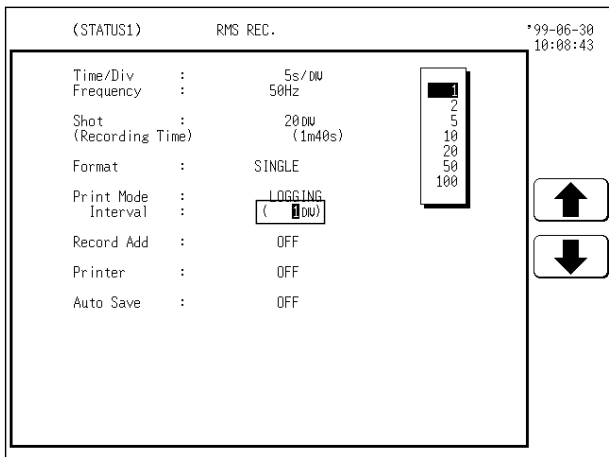
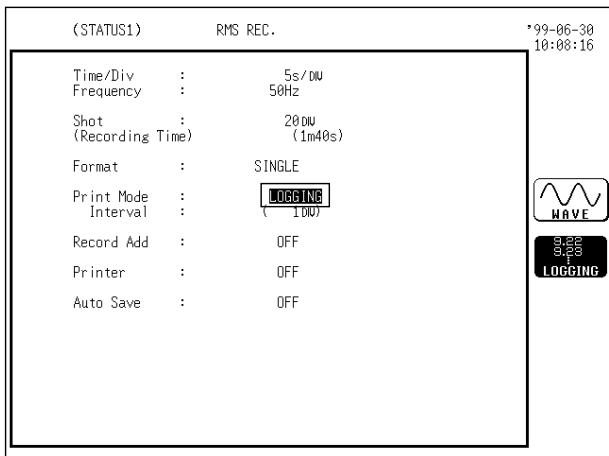

### Method



1. Press the **STATUS** key to call up the STATUS 1 screen.
2. Move the flashing cursor to the print mode item, as shown in the figure on the left
3. Use the function keys to select numeric data.
  -  : Waveform data are printed as a waveform.
  -  : Waveform data are printed as numeric data.

4. Move the flashing cursor to the print interval item.

5. Use the JOG control or the function keys to select the print interval.

-  : Move the cursor up in the selection window.
-  : Move the cursor down in the selection window.

#### NOTE

- When the print interval longer than the recording length is set, only the first dot is printed.
- The maximum and minimum values are printed in the time axis range other than 5 s/DIV (see Section Appendix 3.4).
- The print intervals of 0.01 to 0.5 DIV can be selected, only when there are waveform data present.

## 6.2.7 Setting the Additional Recording Function

- This records, regarding the memory as though it were recording paper.
- The last 2000 divisions of waveform can be held in memory.
- The waveform can be scrolled and printed.

Switching the additional recording on and off affects the use of memory as shown below.

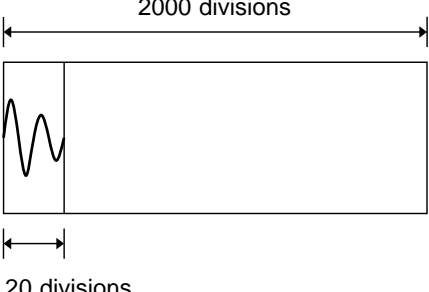
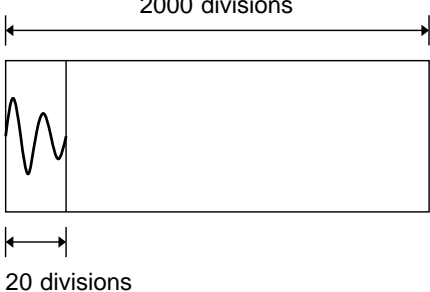
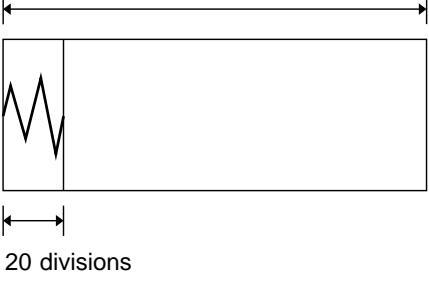
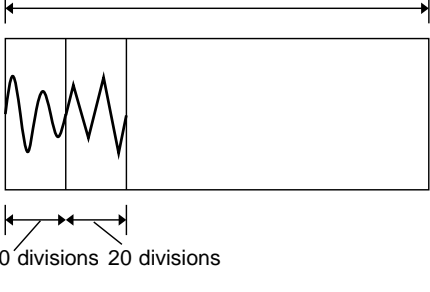
Additional recording OFF	Additional recording ON
<p>1. Recording 20 divisions of waveform</p>  <p>2000 divisions</p> <p>20 divisions</p>	<p>1. Recording 20 divisions of waveform</p>  <p>2000 divisions</p> <p>20 divisions</p>
<p>2. Recording another 20 divisions of waveform</p> <p>The first set of measurement data is discarded, and recording of the second set of measurement data starts again from the beginning of memory.</p>  <p>20 divisions</p>	<p>2. Recording another 20 divisions of waveform</p> <p>The first set of measurement data is preserved, and recording of the second set of measurement data starts after the first set.</p>  <p>20 divisions 20 divisions</p> <p>The first and second sets of waveforms can be observed by scrolling or printing the waveform.</p>

## Method

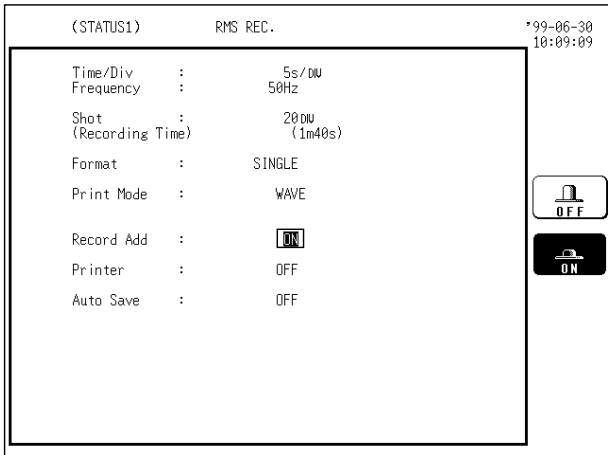

1. Press the **STATUS** key to call up the STATUS 1 screen.
2. Move the flashing cursor to the additional recording item, as shown in the figure on the left.
3. Use the function keys to make the selection.

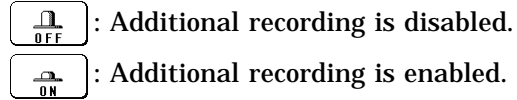

### NOTE

- Time values output to the printer and displayed on the screen with the additional recording function enabled are equal to those of the most recently acquired waveforms. Therefore, when measuring waveforms in a different time axis range, always take that difference into consideration.
- The voltage axis range is determined by the most recently acquired waveforms.

## 6.2.8 Setting the Printer Function (Real Time Printing)

The rms value of the input signal is continuously printed in real time.

### Method

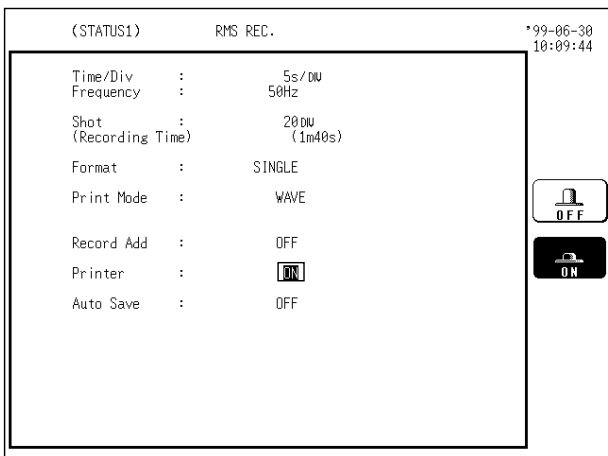

1. Press the **STATUS** key to call up the STATUS screen (page 1).
2. Move the flashing cursor to the printer item, as shown in the figure on the left.
3. Use the function keys to make the selection.

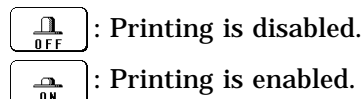

### NOTE

See Section 10.7.3.

## 6.2.9 Setting the Auto Save Function

When the function is enabled, waveform data are automatically stored on a floppy disk or PC card after they are captured.

### Method

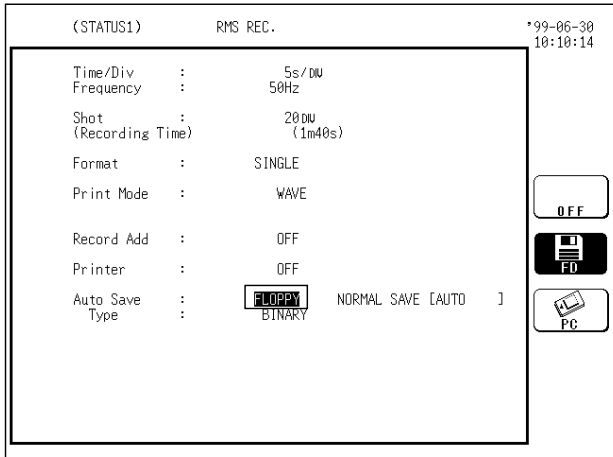

1. Press the **STATUS** key to call up the STATUS 1 screen.
2. Move the flashing cursor to the auto save item, as shown in the figure on the left.
3. Use the function keys to select the media.

**OFF** : Auto save is disabled.

**FD** : Waveform data are automatically stored on floppy disk

**PC** : Waveform data are automatically stored on PC card.

**NOTE** The LAN selection is available only when a LAN is connected.

4. Selecting Media displays saving data options.

**NORM. SAVE** : Cancels automatic save when media is full.

**DEL. SAVE** : Deletes old files and automatically saves when media is full.

**NOTE**

- In delete save, file is saved as RMS. extension file in binary format and TXT. extension file in text format.
- If the A/B cursors are used, partial save is applied (see Section 13.4.5). However, when additional recording is enabled, partial save cannot be performed. A/B cursors are disabled automatically.

5. File naming

See Section 9.5.5 for entry options.

In automatic save, file is titled with a number following the file name.

When file is left untitled during processing, AUTO automatically executes.

**NOTE**

- File name contains eight alphanumeric characters. In automatic save the last character may be replaced with a number to designate the file.
- When the characters below are used in a file, the file cannot be handled on a PC running Windows 2000 or XP. Do not use these characters when handling a file on your PC.  
 +, =, [, ]

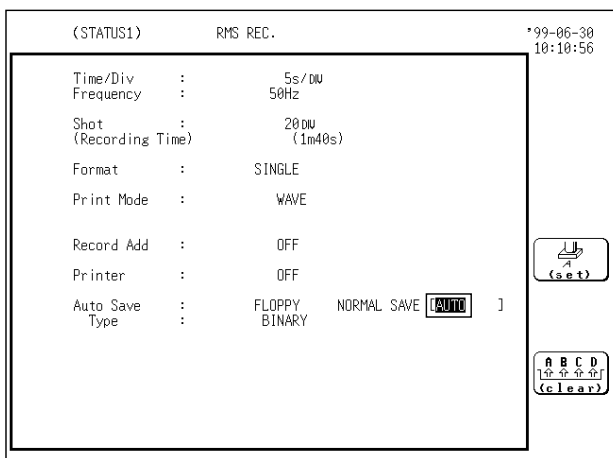
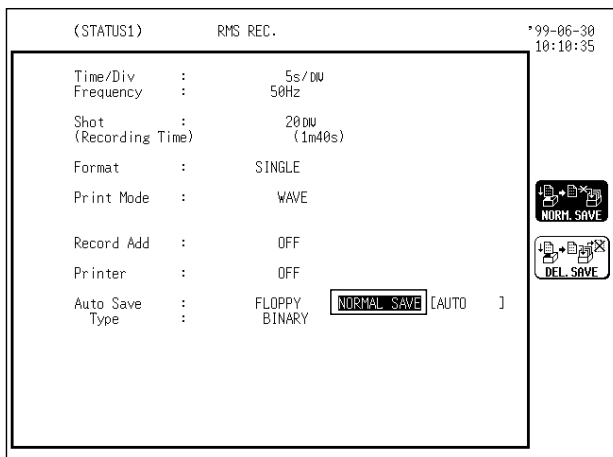

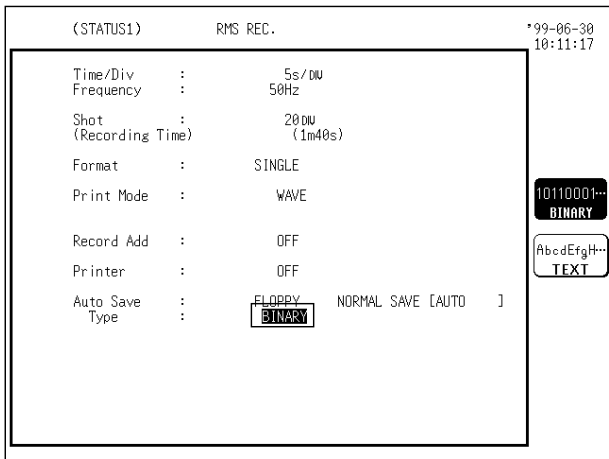

6. Use the function keys to select the data store principle.

: Data are stored as binary data.

: Data are stored as text data.

**NOTE**

Data stored in the text format is not readable by the 8835-01.

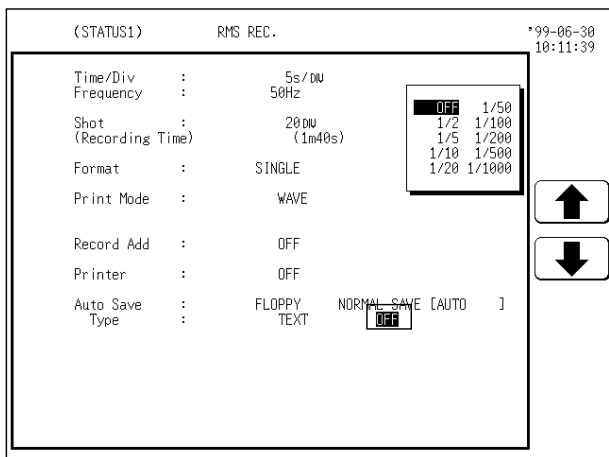

7. Selected TEXT in save options opens Thinning.

Use the JOG control or the function keys to make the selection.

**NOTE**

- In automatic save channels cannot be selected. Only current channel displaying waveform is saved.
- A file is stored in the directory currently selected on the file screen.
- Only a limited number of directories and files can be stored in the directory.
- When the recording length is "continuous", the auto save function is disabled.
- When the auto save function is used while the additional recording function is ON, only newly acquired waveform data is stored. (In this case, the A/B cursors are set OFF.)
- If the data quantity is too large, it may not fit on a floppy diskette or PC Card. For the size of a file, see Section Appendix 4.

## 6.2.10 Setting the Trigger

Select the trigger that is suitable for the signal to be captured.  
For details, see Chapter 8.

## 6.2.11 Input Channel Settings

The settings differ for each unit.  
See the settings for each unit in Chapter 7.

## 6.3 Settings on the Display Screen

Explains the setting items on the Display screen.

### 6.3.1 Setting Compression Along the Time Axis

- The compression ratio along the time axis can be set.
- By compressing the waveform, an entire change can be promptly apprehended.

#### Method

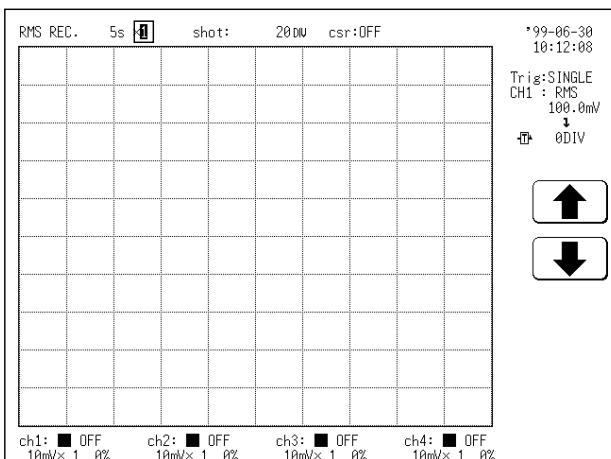

1. Move the flashing cursor to the position shown in the figure on the left.

2. Use the function keys to select the compression ratio.



: Ratio up



: Ratio down

#### NOTE

The compression factor can be changed also after measurement is completed.

**Reference** The **HELP** key can be used to check which position within the entire recording length is occupied by the currently shown waveform (see Section 3.1.7).

## 6.4 Start and Stop Measurement Operation

#### Method

1. Press the **START** key to initiate measurement or set the unit to trigger standby.
2. Press the **STOP** key during measurement to stop the measurement. (see Section 3.1.4.)

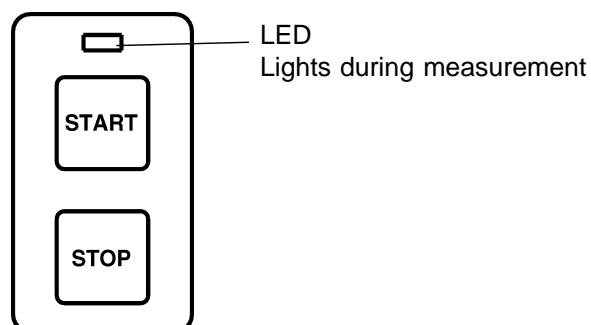



# 6.5 Print Examples

**Single screen** (The list and gauge functions are enabled.)

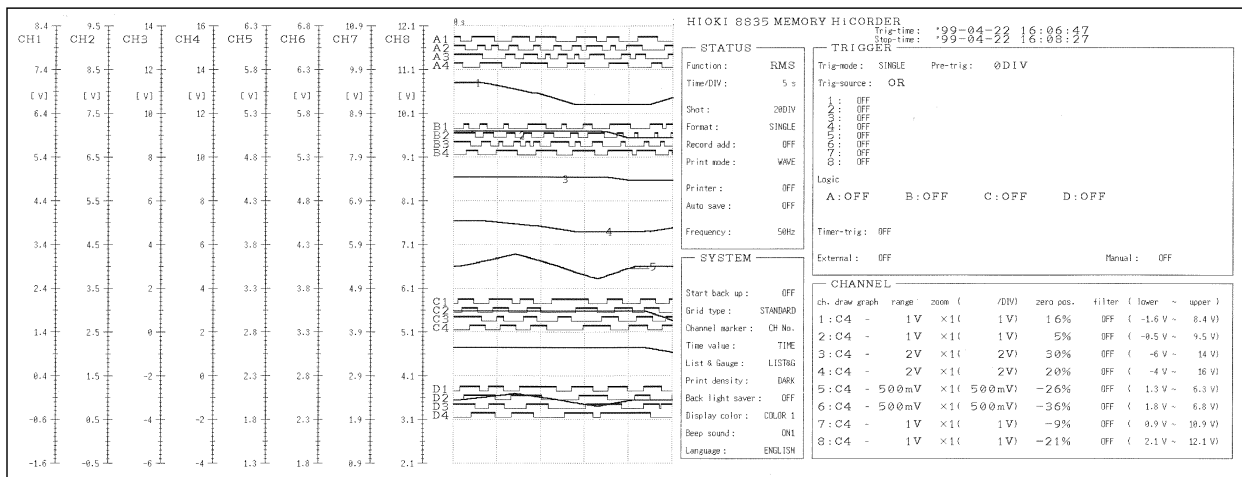

**Dual screen** (The gauge function is enabled.)

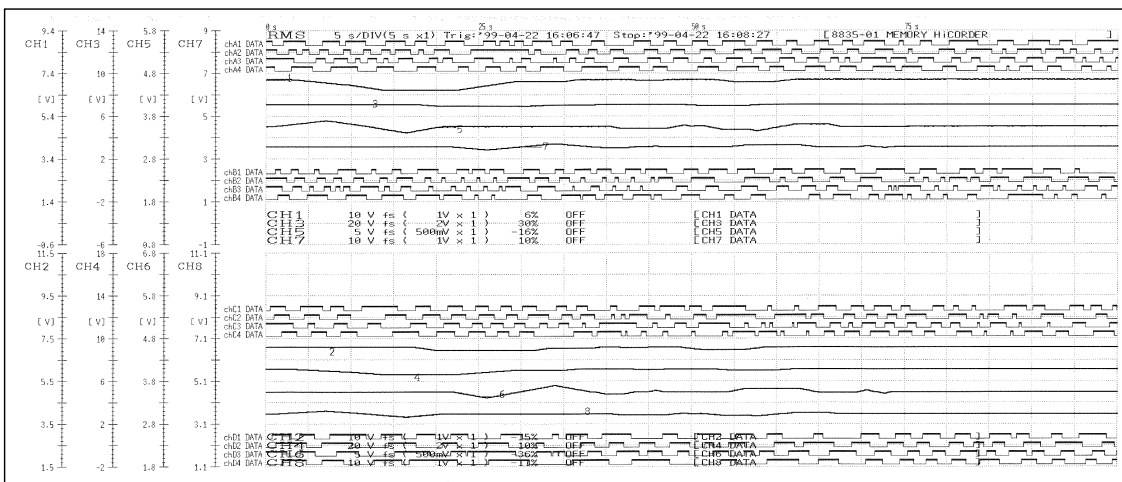

**Quad screen** (The gauge function is enabled.)

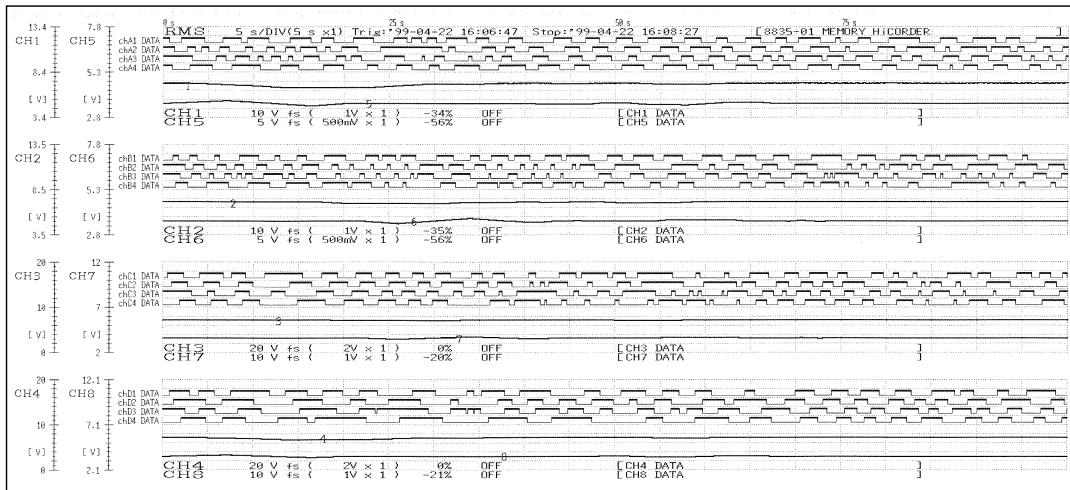

### Report

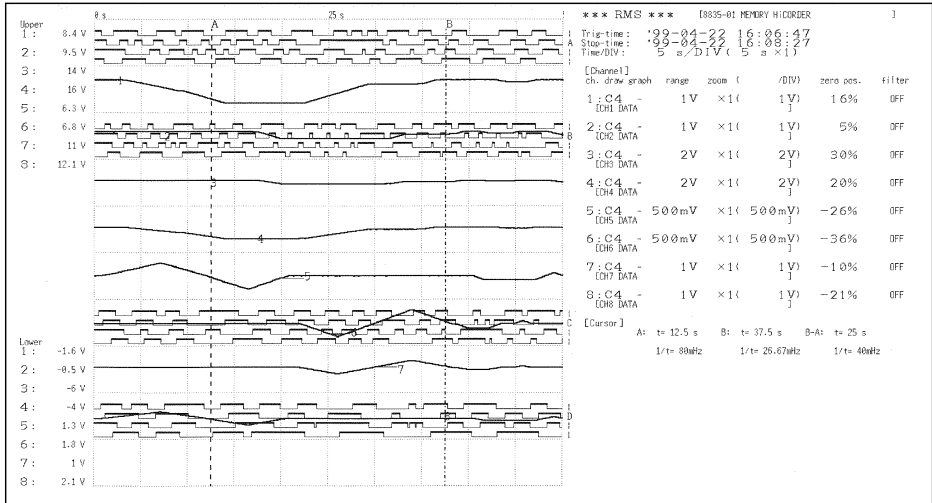

### List

HIOKI 8835 MEMORY HiCORDER  
 Trig-time: '99-04-22 16:06:47  
 Stop-time: '99-04-22 16:08:27

STATUS

Function: RMS  
 Time/DIV: 5 s  
 Shot: 20DIV  
 Format: SINGLE  
 Record add: OFF  
 Print mode: WAVE  
 Printer: OFF  
 Auto save: OFF  
 Frequency: 50Hz

TRIGGER

Trig-mode: SINGLE Pre-trig: 0DIV  
 Trig-source: OR

1: OFF  
 2: OFF  
 3: OFF  
 4: OFF  
 5: OFF  
 6: OFF  
 7: OFF  
 8: OFF

Lexic  
 A: OFF B: OFF C: OFF D: OFF

Timer-trig: OFF  
 External: OFF Manual: OFF

SYSTEM

Start back up: OFF  
 Grid type: STANDARD  
 Channel marker: CH No.  
 Time value: TIME  
 List & Gauge: GAUGE  
 Print density: DARK  
 Back light saver: OFF  
 Display color: COLOR 1  
 Beep sound: ONL  
 Language: ENGLISH

CHANNEL

ch.	draw graph	range	zoom ( /DIV)	zero pos.	filter	lower ~ upper
1: C4	-	1V	x1( 1V )	16%	OFF	( -1.6 V ~ 8.4 V )
2: C4	-	1V	x1( 1V )	5%	OFF	( -0.5 V ~ 9.5 V )
3: C4	-	2V	x1( 2V )	30%	OFF	( -6 V ~ 14 V )
4: C4	-	2V	x1( 2V )	20%	OFF	( -4 V ~ 16 V )
5: C4	-	500mV	x1( 500mV )	-26%	OFF	( 1.3 V ~ 6.3 V )
6: C4	-	500mV	x1( 500mV )	-36%	OFF	( 1.8 V ~ 6.8 V )
7: C4	-	1V	x1( 1V )	-10%	OFF	( 1 V ~ 11 V )
8: C4	-	1V	x1( 1V )	-21%	OFF	( 2.1 V ~ 12.1 V )

### Numeric data

Trig-time: '99-04-22 16:06:47 Stop-time: '99-04-22 16:08:27  
 File: 8835-01 MEMORY HiCORDER  
 Comment:

(time)	CH1	CH5	CH2	CH3	CH4	A	B	C	D
	CH1	CH5	CH2	CH3	CH4	1234	1234	1234	1234
0 s	7.8937 V	7.8875 V	7.8875 V	7.8875 V	7.8875 V	1111	0110	0010	0010
	3.55 V	3.5486 V	3.5438 V	3.5438 V	3.5438 V				
5.00 s	7.405 V	7.8875 V	7.8875 V	7.8875 V	7.8125 V	0101	0001	1110	1010
	3.6486 V	3.5486 V	3.5375 V	3.5375 V	3.5375 V				
10.00 s	6.8375 V	7.8875 V	7.8875 V	7.8875 V	6.825 V	1001	1001	0001	1110
	3.6863 V	3.5486 V	3.5375 V	3.5375 V	3.6 V				
15.00 s	6.6 V	7.8875 V	7.8875 V	7.8875 V	6.5875 V	1000	1001	1101	1101
	3.45 V	3.5486 V	3.5375 V	3.5375 V	3.4838 V				
20.00 s	6.6 V	6.9375 V	6.9375 V	6.9375 V	6.5875 V	0110	1001	0100	0001
	3.5201 V	3.5486 V	3.5375 V	3.5375 V	3.525 V				
25.00 s	6.7502 V	6.9375 V	6.9375 V	6.9375 V	6.75 V	0110	1100	1011	0+10
	3.55 V	3.4344 V	3.4333 V	3.4333 V	3.5438 V				
30.00 s	7.0802 V	6.9375 V	6.9375 V	7 V	7 V	1111	0100	0011	1001
	3.55 V	3.5469 V	3.55 V	3.5438 V	3.5438 V				
35.00 s	7.8125 V	7.8312 V	7.825 V	7.825 V	7 V	1000	0101	1110	0010
	3.55 V	3.6409 V	3.6433 V	3.6433 V	3.5438 V				
40.00 s	7.1 V	7.8875 V	7.8875 V	7.8875 V	7.0075 V	0001	1001	0011	1001
	3.55 V	3.4906 V	3.4938 V	3.4938 V	3.5438 V				
45.00 s	7.0550 V	7.075 V	7.075 V	7.075 V	7.075 V	1110	1001	1000	0011
	3.5863 V	3.5469 V	3.5438 V	3.5438 V	3.5 V				
50.00 s	7.0937 V	7.8125 V	7.8125 V	7.8125 V	7.0875 V	0000	1101	100+ 0000	
	3.5563 V	3.5486 V	3.5438 V	3.5438 V	3.55 V				
55.00 s	6.9837 V	6.95 V	6.95 V	6.95 V	6.975 V	1110	0000	1101	0101
	3.4781 V	3.5688 V	3.5688 V	3.5688 V	3.475 V				
60.00 s	7.6802 V	7.8875 V	7.8875 V	7.8875 V	7 V	0101	10+0	0101	1101
	3.5281 V	3.6125 V	3.6125 V	3.6125 V	3.525 V				
65.00 s	7.0937 V	7.8875 V	7.8875 V	7.8875 V	7.8875 V	1001	1001	1100	1101
	3.5969 V	3.525 V	3.525 V	3.525 V	3.5937 V				
70.00 s	7.1 V	7.8875 V	7.8875 V	7.8875 V	7.8875 V	0010	0110	1000	1100
	3.5438 V	3.55 V	3.55 V	3.55 V	3.5375 V				
75.00 s	7.1 V	7.8875 V	7.8875 V	7.8875 V	7.8875 V	0011	+010	1001	1001
	3.5486 V	3.5486 V	3.5375 V	3.5375 V	3.5375 V				

# Chapter 7

## Input Channel Settings

(For all functions)

### 7.1 Overview

- Input channel settings are made with the CHANNEL screen of each function.
- The 8835-01 can use up to 8 analog and 16 logic channels.
- Settings are made separately for one analog channel or four logic channels (1 probe).
- Before making input channel settings, use the SYSTEM screen to select the channels to be used (see Section 9.3.1).

7

### 7.2 Selecting Channels (Memory Recorder Function Only)

- Perform this setting before making the input channel settings in the memory recorder function.
- This setting on the SYSTEM 1 screen determines the channels in use. Use the menu items SETUP and (1) using channel.
- For details, see Section 9.3.1.

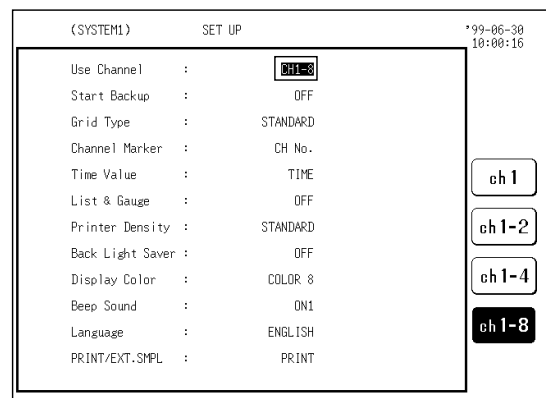

**NOTE**

Depending on the channels in use, the recording length of the memory recorder function differs.

## 7.3 Making the Settings of the 8936 ANALOG UNIT

This section explains the settings of the 8936 ANALOG UNIT.

The 8936 ANALOG UNIT is a unit for measuring the voltage waveforms.

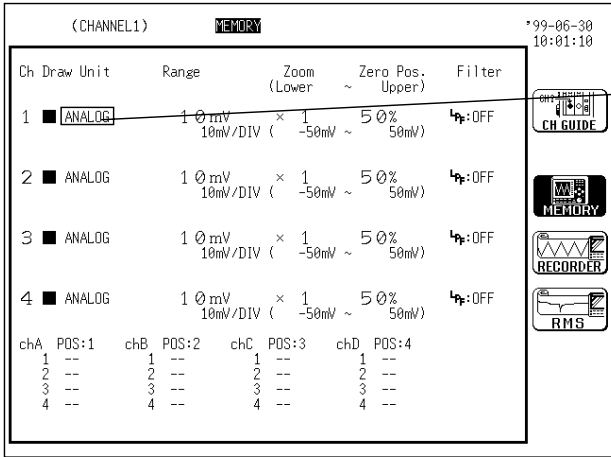

Displays the type of the installed unit

### 7.3.1 Setting the Waveform Display Color

Set the display color for the waveform.

**Method** Screen: CHANNEL 1, DISPLAY

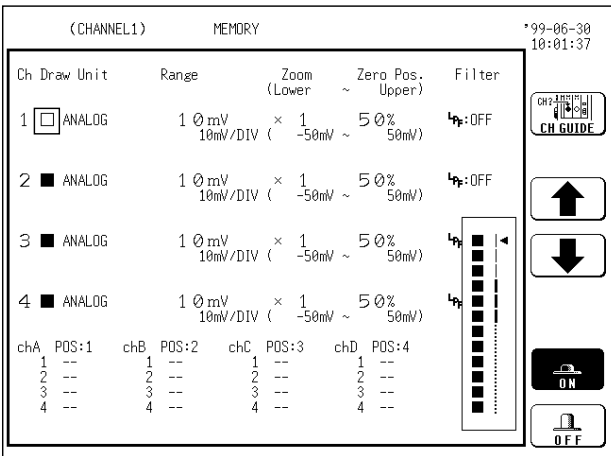

1. Call up the CHANNEL 1 or DISPLAY screen.

2. Move the flashing cursor to the point shown in the figure on the left.

3. Use the JOG control or the function keys to make the selection.

: Move the arrow up in the selection window.

: Move the arrow down in the selection window.

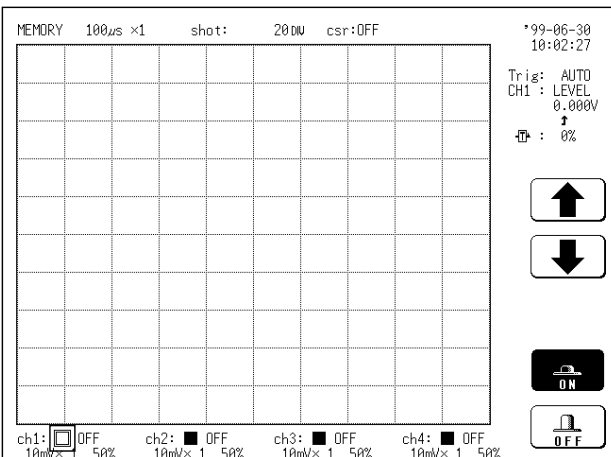

: Waveform display is enabled.

: Waveform display is disabled.

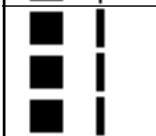

**NOTE**

- On the DISPLAY screen, the selection window is not displayed.
- Depending on the waveform display color, the color of the printer output for either the print function or the hard copy function changes. See the following table.

Waveform display color	Print function	Hard copy function
	NORMAL	DARK
	DARK	
	LIGHT	LIGHT

## 7.3.2 Setting the Waveform Display Graph Type

Set which graph type to use when display format has been set to DUAL or QUAD screen display on the STATUS 1 screen.

### (1) DUAL or QUAD screen display

#### Method

(CHANNEL1)		MEMORY		*99-06-30 10:03:08	
Ch	Draw Unit	Range	Zoom (Lower ~ Upper)	Zero Pos.	Filter
1	ANALOG	1 0mV 10mV/DIV	× 1 (-50mV ~ 50mV)	5 0%	HP:OFF
2	ANALOG	1 0mV 10mV/DIV	× 1 (-50mV ~ 50mV)	5 0%	HP:OFF
3	ANALOG	1 0mV 10mV/DIV	× 1 (-50mV ~ 50mV)	5 0%	HP:OFF
4	ANALOG	1 0mV 10mV/DIV	× 1 (-50mV ~ 50mV)	5 0%	HP:OFF
chA	POS:1	chB	POS:2	chC	POS:3
1	--	1	--	1	--
2	--	2	--	2	--
3	--	3	--	3	--
4	--	4	--	4	--

1. Press the **CHAN** key to call up the CHANNEL 1 screen.

2. Move the flashing cursor to the point shown in the illustration at left.

- The illustration shows the setting for CH1.
- Settings for CH2 - CH8 should be made in the same way.

3. Use the function keys to select the graph.



: Display the waveform on graph 1.



: Display the waveform on graph 2.



: Display the waveform on graph 3. (\*)



: Display the waveform on graph 4. (\*)

\*: when the quad screen display is selected

### (2) X-Y combined plotting

Set the channel to be used as X axis when display format has been set to X-Y (dot) or X-Y (line) display on the STATUS 1 screen.

#### Method

(CHANNEL1)		MEMORY		*99-06-30 10:03:42	
Ch	Draw Unit	Range	Zoom (Lower ~ Upper)	Zero Pos.	Filter
1	ANALOG X	1 0mV 10mV/DIV	× 1 (-50mV ~ 50mV)	5 0%	HP:OFF
2	ANALOG Y	1 0mV 10mV/DIV	× 1 (-50mV ~ 50mV)	5 0%	HP:OFF
3	ANALOG	1 0mV 10mV/DIV	× 1 (-50mV ~ 50mV)	5 0%	HP:OFF
4	ANALOG	1 0mV 10mV/DIV	× 1 (-50mV ~ 50mV)	5 0%	HP:OFF
chA	POS:1	chB	POS:2	chC	POS:3
1	--	1	--	1	--
2	--	2	--	2	--
3	--	3	--	3	--
4	--	4	--	4	--

1. Press the **CHAN** key to call up the CHANNEL 1 screen.

2. Use the **CH SELECT** key to open selected channel screen.

3. Move the cursor to the channel to be used as X axis, as shown at left.

4. Use the function keys to select X axis.

The channels other than the channel assigned to the X axis are automatically assigned to the Y axis.

### 7.3.3 Setting the Voltage Axis Range

- The voltage axis range for each channel is set.
- The set value denotes the voltage value for 1 DIV along the voltage axis (vertically).
- When waveform data is out of range limit, that waveform portion is displayed in another color in the display window.

#### Method 1 Screen: CHANNEL 1, DISPLAY

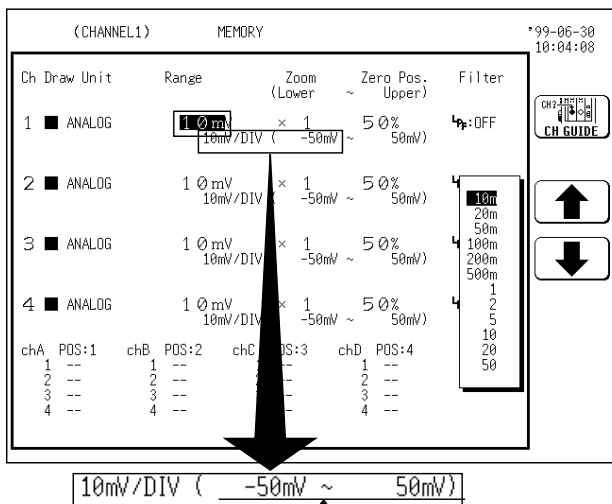

The full-span voltage range is displayed.

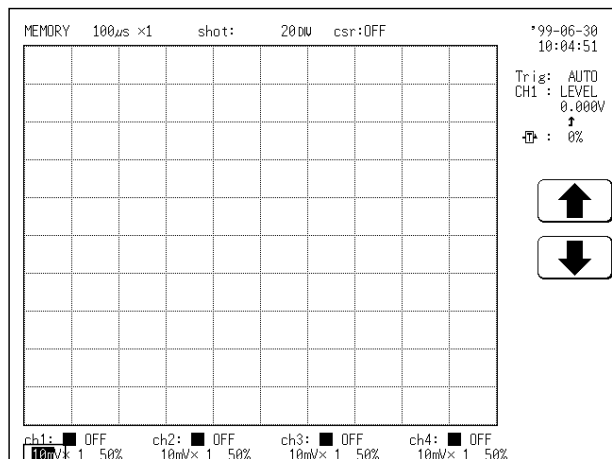

1. Call up the CHANNEL 1 or DISPLAY screen.
2. Use the **CH SELECT** key to open selected channel screen.
3. Move the flashing cursor to the point shown in the figure on the left.
4. Use the JOG control or the function keys to make the selection.



: Move the cursor up in the selection window.



: Move the cursor down in the selection window.

#### NOTE

- On the DISPLAY screen, the selection window is not displayed.
- When out of range, waveform may not appear even if it is indicated within the range based on zero position settings.

#### Method 2 Screen: CHANNEL 1, DISPLAY

1. Use the **CH SELECT** key to open selected channel screen.
2. Press the **INPUT RANGE** key to set the range for each channel.

#### NOTE

- The **INPUT RANGE** key can be used regardless of where the flashing cursor is located, if the selected channel is displayed on the CHANNEL 1 or DISPLAY screen.
- If the variable function is enabled, the size of a waveform on the screen does not change, even if the voltage axis range is changed.

## 7.3.4 Setting the Input Coupling

The input coupling for the input signal is set.

**Method** Screen: CHANNEL 1, DISPLAY

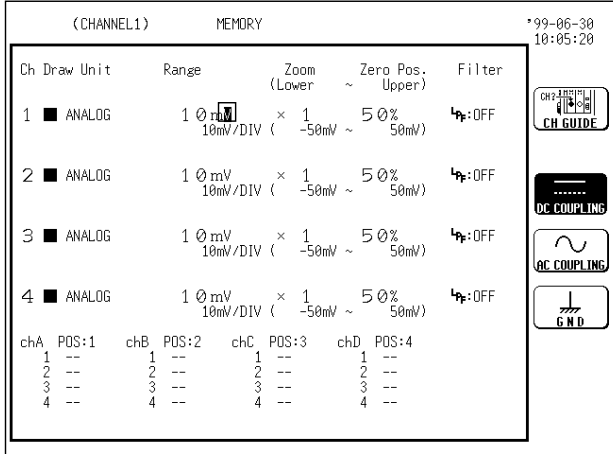

1. Call up the CHANNEL 1 or DISPLAY screen.
2. Use the **CH SELECT** key to open selected channel screen.
3. Move the flashing cursor to the point shown in the figure on the left.
4. Use the function keys to make the selection.



: DC coupling



: AC coupling



: The input signal is not connected.

This allows the zero position to be checked.

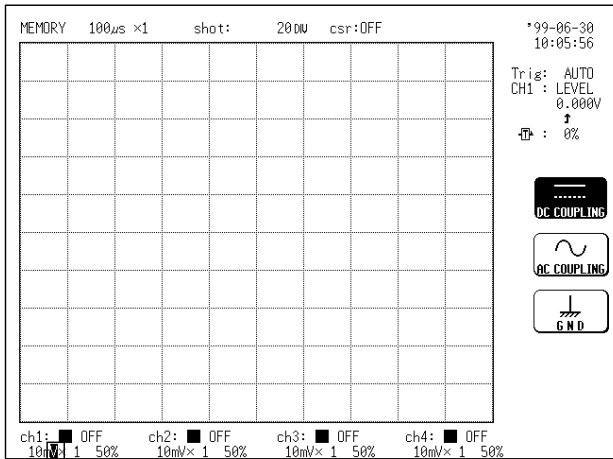

**NOTE**

Input coupling is determined by type of input unit or measurement mode.



## 7.3.5 Setting the Magnification/Compression Ratio Along the Voltage Axis

- Specifies the magnification/compression ratio for each channel to be used for display and recording.
- Performs magnification/compression using the center of the screen as reference.

### Method 1 Screen: CHANNEL 1

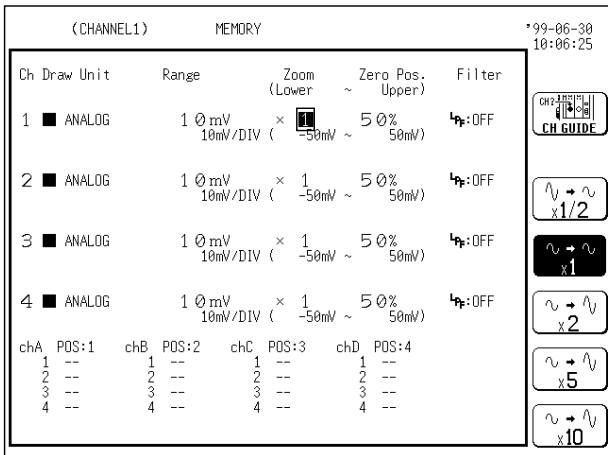

1. Call up the CHANNEL 1 screen.
2. Use the **CH SELECT** key to open selected channel screen.
3. Move the flashing cursor to the point shown in the figure on the left.
4. Use the function keys to make the selection.

: Display is compressed to 1/2.

: Display is shown as is.

: Display is magnified by factor 2.

: Display is magnified by factor 5.

: Display is magnified by factor 10.

#### NOTE

Magnification/compression is performed using the center of the screen as reference, if the magnification /compression ratio is changed.

### Method 2 Screen: DISPLAY

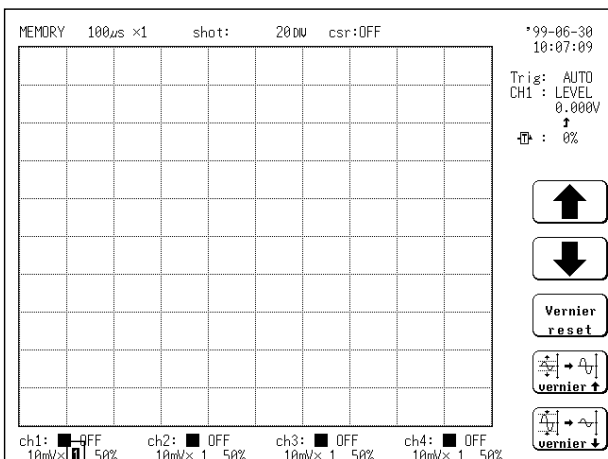

1. Call up the DISPLAY screen.
2. Use the **CH SELECT** key to open selected channel screen.
3. Move the flashing cursor to the point shown in the figure on the left.
4. Use the function keys to make the selection.

: Ratio up

: Ratio down

## 7.3.6 Setting the Zero Position

The position of the zero voltage is set.

### Method 1 Screen: CHANNEL 1, DISPLAY

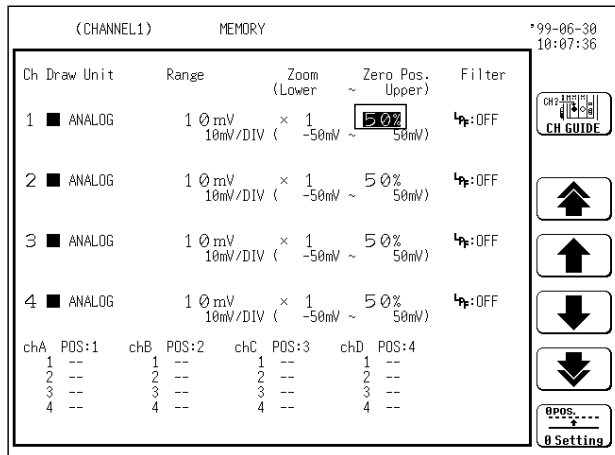

1. Call up the CHANNEL 1 or DISPLAY screen.
2. Use the **CH SELECT** key to open selected channel screen.
3. Move the flashing cursor to the point shown in the figure on the left.
4. Use the JOG control or the function keys to make the selection.



: Changes the +10% zero position.



: Changes the +1% zero position.



: Changes the -1% zero position.



: Changes the -10% zero position.

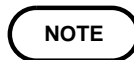

On the DISPLAY screen, the setting cannot be made with the JOG control.

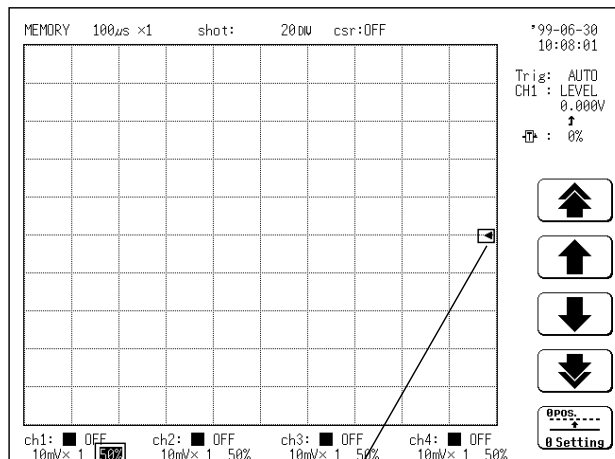

On the DISPLAY screen, flashing cursor at zero indicates zero position.

### Method 2 Screen: CHANNEL 1, DISPLAY

1. Call up the CHANNEL 1 or DISPLAY screen.
2. Use the **CH SELECT** key to open selected channel screen.
3. Press the front-panel **POSITION** key for the channel whose zero position you want to adjust.

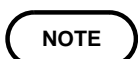

- The **POSITION** key can be used regardless of where the flashing cursor is located, if the selected channel is displayed on the CHANNEL 1 or DISPLAY screen.
- Magnification/compression along the voltage axis is performed using the center of the screen as reference,

## Reference

- The zero positions are shown in the figure below.
- It is possible to display the hidden portion of the waveform by setting "0 V" to a proper percentage on the display.

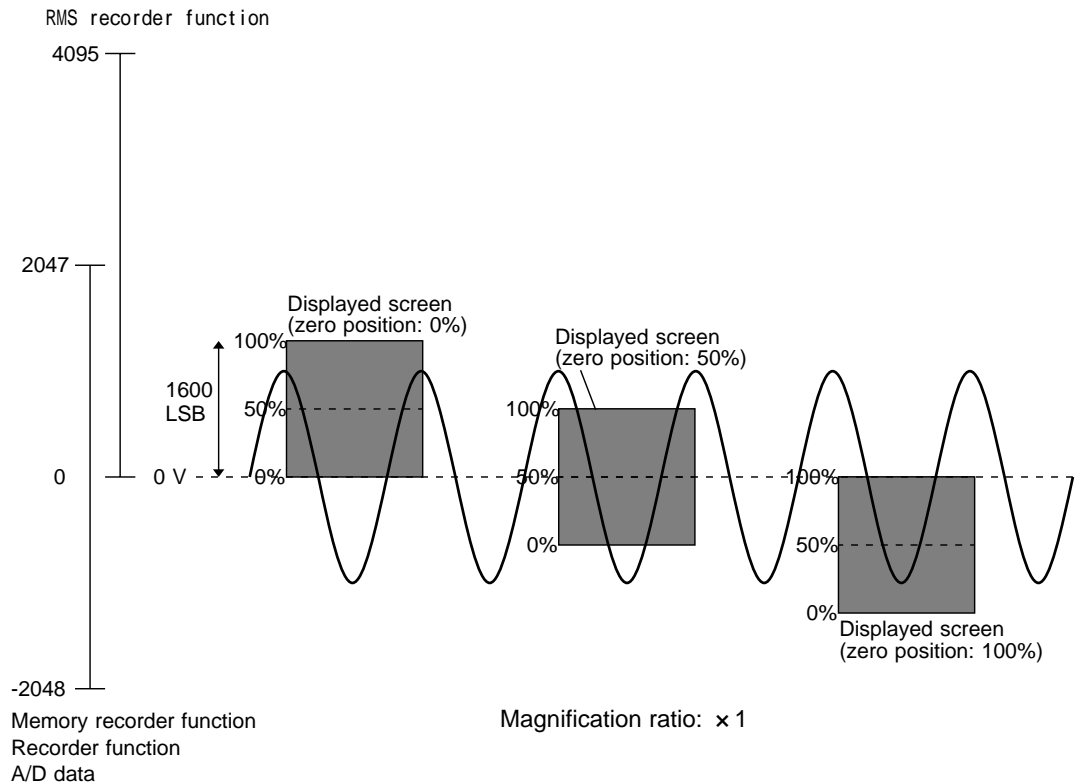

Magnification ratio	× 1/2	× 1	× 2	× 5	× 10
No. of full-scale LSBs	3200	1600	800	320	160
Zero position adjustment area (Memory, recorder)	0 to 100	-50 to 150	-150 to 250	-450 to 550	-950 to 1050
Zero position adjustment area (RMS recorder)	-50 to 100	-150 to 150	-350 to 250	-950 to 550	-1950 to 1050

### NOTE

- Available measurement range of each range is approximately +, - 12.5 times voltage axis range setting. Any part beyond available voltage measurement range is not loaded as waveform but indicated as out of range.
- According to zero position and magnification/compression ratio of voltage axis, voltage range displayed in waveform display screen varies but available measurement range does not.

## 7.3.7 Zero Adjustment

- This function calibrates the 0 V position (ground position) to the selected zero position. Use it to assure precise results.
- Allow the unit to warm up for at least 30 minutes to ensure that the internal temperature of the input units has stabilized.

**Method** Screen: CHANNEL 1, DISPLAY

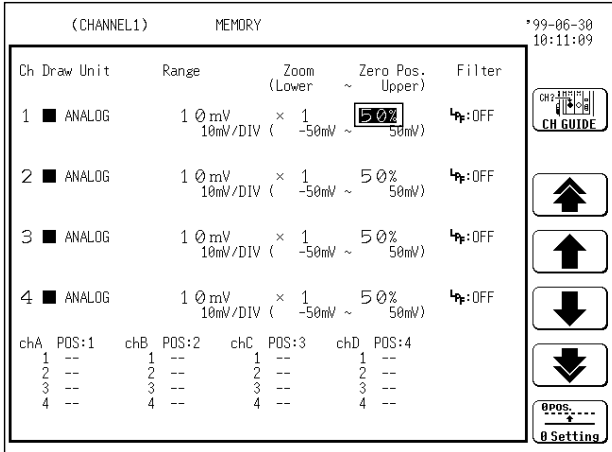

1. Call up the CHANNEL 1 or DISPLAY screen.
2. Move the flashing cursor to the zero position item, and select zero setting.

: Opens baseline offset and zero adjustment setting screen.

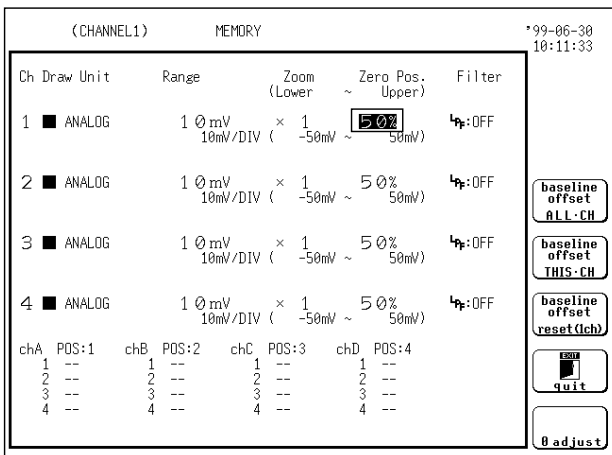

3. Press 0 Adjust. All channels will be calibrated together.

: Applies baseline offset to all channels.

: Applies baseline offset to selected channel only.

: Cancels baseline offset to selected channel.

: Disengages from zero adjustment setting screen.

: Executes zero adjustment.

**NOTE**

- Zero adjustment cannot be performed during measurement.
- Repeat the zero adjustment when the voltage axis range was changed, when the input unit was changed, when the power is on/off, or when the system is set to reset.
- When there is a sudden change in ambient temperature, the zero position may drift. To assure continued measurement precision, perform the zero adjustment again.

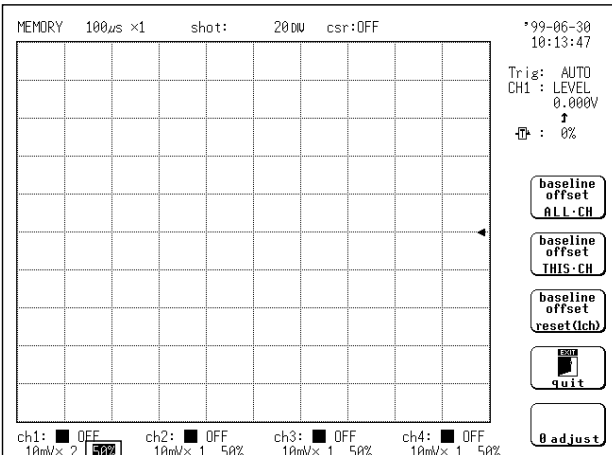

## 7.3.8 Configuring Baseline Offset

- Adjusts voltage value to 0 V. Baseline offset is not available when range is set above +,-10 DIV.
- Baseline offset is available for measuring voltage and amperage. Not available for any other measuring.
- Configuration is not reset to initial settings when power is turned OFF. New entry input resets settings.

### Method Screen: CHANNEL 1, DISPLAY

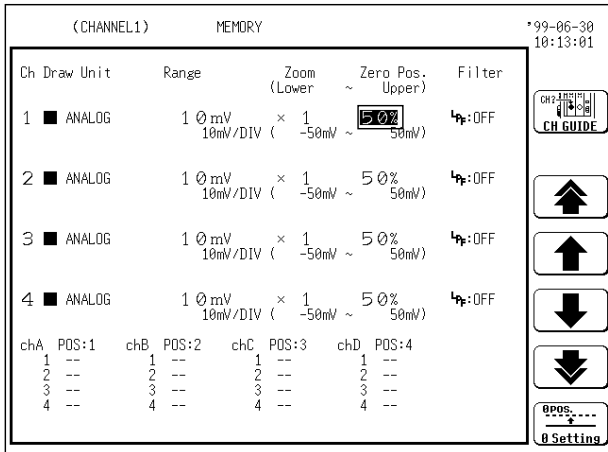

1. Call up the CHANNEL 1 or DISPLAY screen.
2. Move the flashing cursor to the zero position item, and select zero setting.

: Opens baseline offset and zero adjustment setting screen.

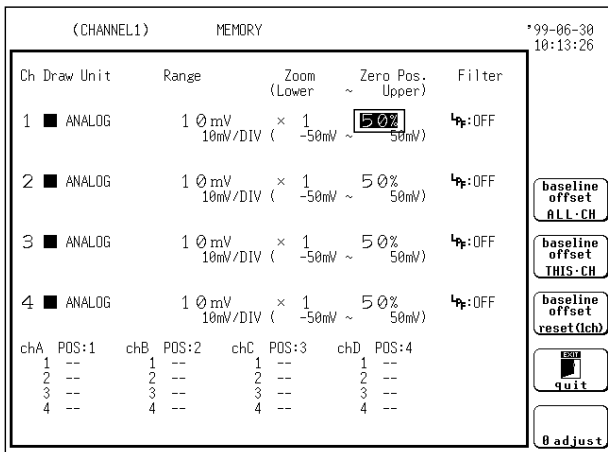

3. Use the function keys to make the selection.

: Applies baseline offset to all channels.

: Applies baseline offset to selected channel only.

: Cancels baseline offset to selected channel.

: Disengages from zero adjustment setting screen.

: Executes zero adjustment. Cancels baseline offset to all channels.

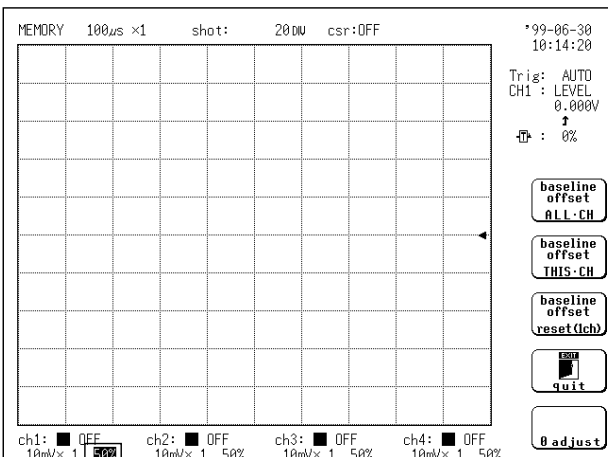

## Input Voltage at Baseline Offset

Baseline offset requires consistent input voltage. When input voltage is variable, baseline offset timing determines values adjusted to 0 V.

When input voltage is consistent

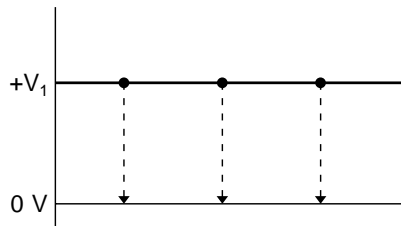

At any time during baseline offset,  $+V_1$  is adjusted to 0 V.

When input voltage is variable

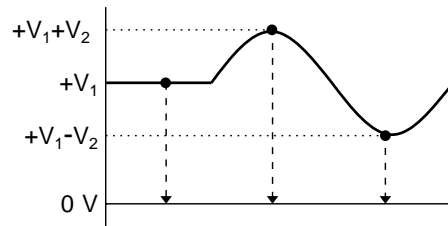

According to the baseline offset time, value adjusted to 0 V varies.

### NOTE

- Baseline offset enables input voltage to be set to 0 V. Before executing baseline offset, specify signal to be set to 0 V.
- Adjusting input voltage to 0 V by baseline offset does not vary maximum input voltage and maximum rated voltage to earth. When baseline offset is applied, pay close attention to maximum input voltage and maximum rated voltage to earth.
- In process of applying baseline offset to all channels, if setting any channels fail (input voltage to adjust to 0 V is above +, -10 DIV, WARNING is displayed. Baseline offset to remaining channels are in effect.

## Difference from using zero adjustment

Baseline offset shifts and graphically brings the standard electric potential of input signal to 0 V. When a variance occurs between the standard electric potential of testing device and MEMORY HiCORDER standard electric potential (0 V), baseline offset functions to adjust standard electric potential of testing device to 0 V.

Zero adjustment adjusts variance in input unit and standardizes MEMORY HiCORDER standard electric potential to 0 V as 0 position.

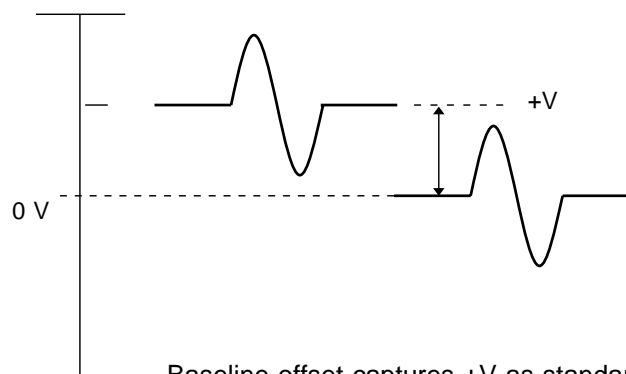

Baseline offset captures  $+V$  as standard electric potential.

## 7.3.9 Setting the Low-Pass Filter

- Low-pass filters internal to the input units are set.
- Effective for removing unneeded high-frequency components.

**Method** Screen: CHANNEL 1, DISPLAY

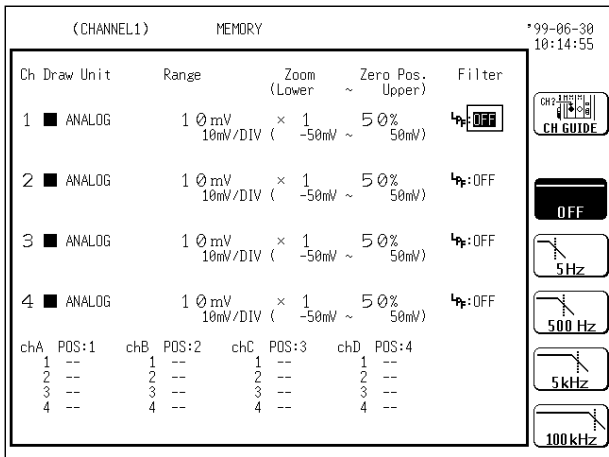

1. Call up the CHANNEL 1 or DISPLAY screen.
2. Move the flashing cursor to the point shown in the figure on the left.
3. Use the function keys to make the selection.

- OFF : No low-pass filter is connected.
- 5 Hz : Connect a filter with a cutoff frequency of 5 Hz
- 500 Hz : Connect a filter with a cutoff frequency of 500 Hz
- 5 kHz : Connect a filter with a cutoff frequency of 5 kHz
- 100 kHz : Connect a filter with a cutoff frequency of 100 kHz

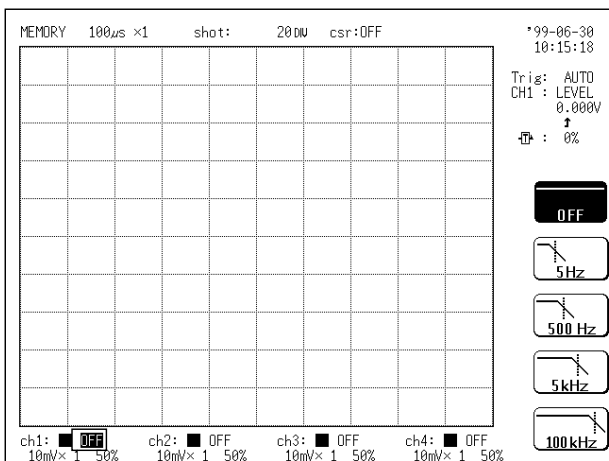

**NOTE**

Cutoff frequency of low-pass filter is determined by type of input unit.

Unit	Low-pass filter	
8 9 3 6	OFF, 5, 500, 5 k, 100 kHz	
8 9 3 7	Voltage	OFF, 5, 500, 5 k, 100 kHz
	Temperature	OFF, 5, 500 Hz
8 9 3 8	OFF, 5, 500, 5 k, 100 kHz	
8 9 3 9	OFF, 10, 30, 300, 3 kHz	
8 9 4 0	OFF, 5, 500, 5 k, 100 kHz	
8 9 4 6	OFF, 5, 500, 5 k, 50 kHz	
8 9 4 7	Voltage	OFF, 5, 500, 5 k, 100 kHz
	Acceleration	OFF, 500, 5 kHz

## 7.4 Making the Settings of the 8937 VOLTAGE/TEMP UNIT

The 8937 VOLTAGE/TEMP UNIT allows measurement of voltage or temperature on any channel.

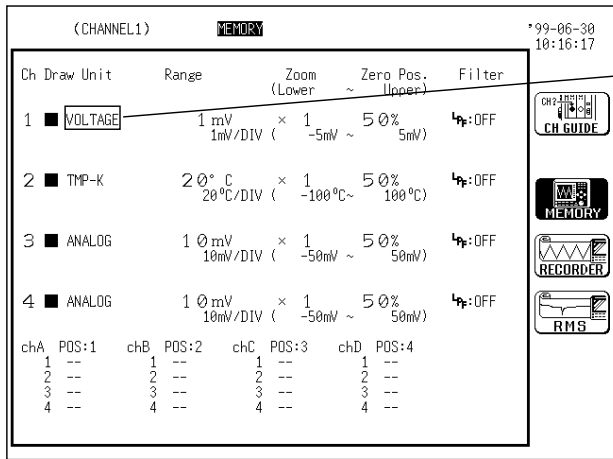

Displays the measurement mode

### 7.4.1 Setting Input for the VOLTAGE/TEMP UNIT

- Choose whether you want to measure voltage or temperature.
- When measuring temperature, select the thermocouple to be used.
- Resetting the system puts it in the voltage mode.

**Method** Screen: CHANNEL 1

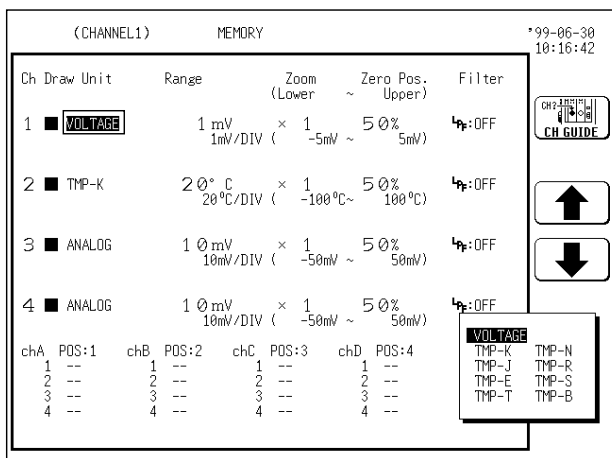

1. Call up the CHANNEL 1 screen.
2. Move the flashing cursor to the point shown in the figure on the left.
3. Use the JOG control or the function keys to make the selection.

↑ : Move the cursor up in the selection window.

↓ : Move the cursor down in the selection window.

VOLTAGE: Set for voltage measurement

TMP- \*: Set for temperature adjustment

The thermocouple used is selected at the same time.





## 7.4.2 Making the Settings of Voltage Measurement



**A common GND is used for voltage and temperature input on all channels. Never input voltage and temperature simultaneously, since doing so could result in damage to the sample being tested.**

- Perform the zero adjustment when measuring voltage.
- Allow the unit to warm up for at least 1 hour to ensure that the internal temperature of the input units has stabilized (see Section 7.3).
- The voltage measurement settings are the same as in the 8936 ANALOG UNIT.
- The digital filter can be configured when the measurement range is 1 mV to 5 mV.
- The digital filter is a function which eliminates the noise component by additive averaging inside the amplifier. This results in a data update rate of about 100  $\mu$ s.

### Setting the digital filter

Screen: CHANNEL 1, DISPLAY

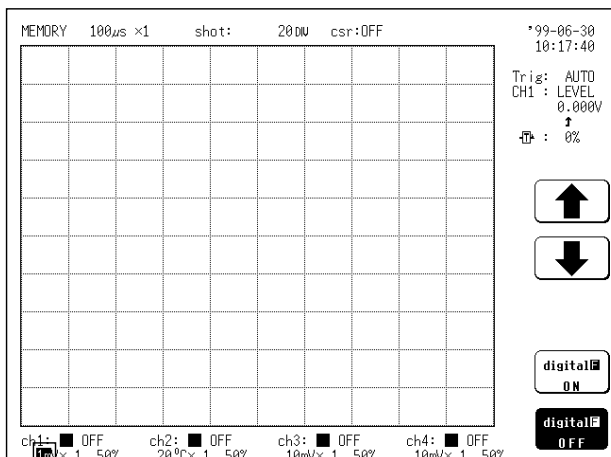
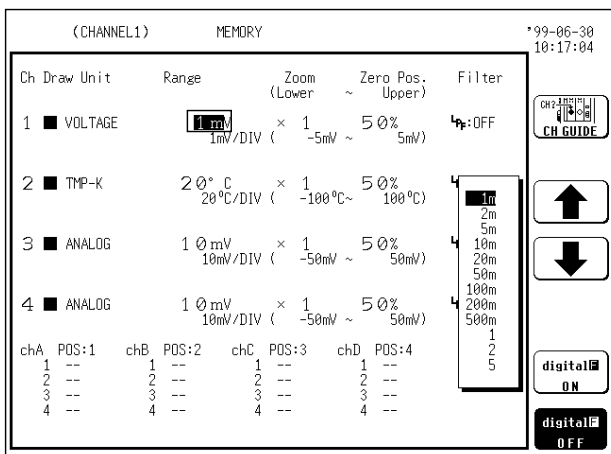

1. Call up the CHANNEL 1 or DISPLAY screen.
2. Move the flashing cursor to the point shown in the figure on the left.
3. The digital filter can be configured when the voltage axis range is 1 mV to 5 mV.

**digital ON**: Digital filter is enabled.

**digital OFF**: Digital filter is disabled.

#### NOTE

- When using the **RANGE** key, the flashing cursor can be located in any field of the channel to be set.
- Repeat the zero adjustment when the voltage axis range was changed, when the input unit was changed, when the power is on/off, or when the system is set to reset.
- When there is a sudden change in ambient temperature, the zero position may drift. To assure continued measurement precision, perform the zero adjustment again.
- Digital filter settings cannot be determined from the DISPLAY or CHANNEL 1 screen. Check through the function key display that appears when the flashing cursor is moved to the measurement range item.

## 7.4.3 Making the Settings of Temperature Measurement

The settings of the waveform display color, waveform display graph type, magnification/compression ratio along the measurement range, zero position and low-pass filter are the same as in the 8936 ANALOG UNIT.

### Setting the measurement range and drift compensation

Set the measurement range.

Drift compensation is a function that periodically (about once per second) cancels the variances in the reference voltage that accumulate over time.

#### Method Screen: CHANNEL 1

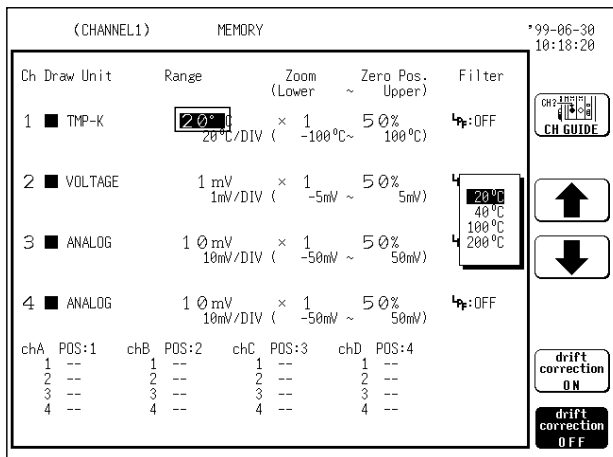

1. Call up the CHANNEL 1 or DISPLAY screen.
2. Move the flashing cursor to the point shown in the figure on the left.
3. Use the function keys, the **RANGE** key or the JOG control to make the selection.



: Move the cursor up in the selection window.



: Move the cursor down in the selection window.

4. Set drift compensation.

Drift compensation can be used with temperature measurement.



: Drift compensation is enabled.



: Drift compensation is disabled.

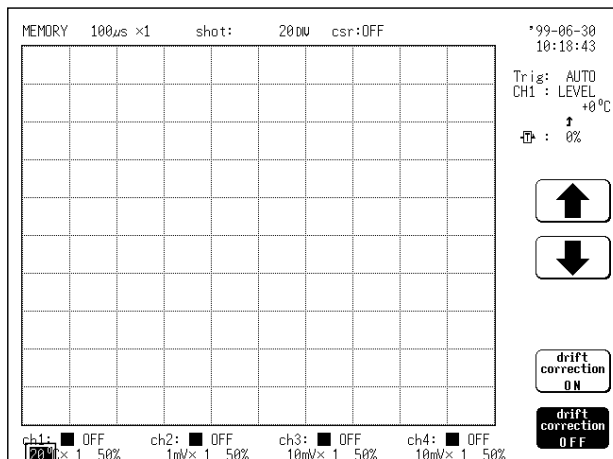

#### NOTE

- Upon resetting the system, the "Input Selection" item is set to Voltage.
- If ambient temperature changes suddenly, loss of thermal equilibrium can result in measurement error. When this occurs, allow the unit to acclimate to the new temperature for about one hour, then take measurements after thermal equilibrium is reached.
- It is recommended that drift compensation be turned ON when using a thermocouple with small thermoelectromotive force (sensor R, S or B) to record over an extended period of time in an environment where ambient temperature fluctuates.
- If the temperature input terminal is exposed to a strong draft, loss of thermal equilibrium at the input may result in measurement error. When taking measurements under such conditions, arrange the unit in such a manner that the input terminal is protected for direct exposure to drafts.

## Setting reference junction compensation

Set reference junction compensation.

When connecting a thermocouple directly to the input module, select [RJC Internal].

Reference junction compensation is performed within the input module.

When connecting through a reference junction device (e.g., a 0°C control tank), select [RJC External]

When measuring temperature with thermocouple, temperature differential is measured between device to be tested and tester terminal. Reference junction compensation enables direct reading of temperature of device to be tested by compensating for tester terminal temperature.

### Method Screen: CHANNEL 1

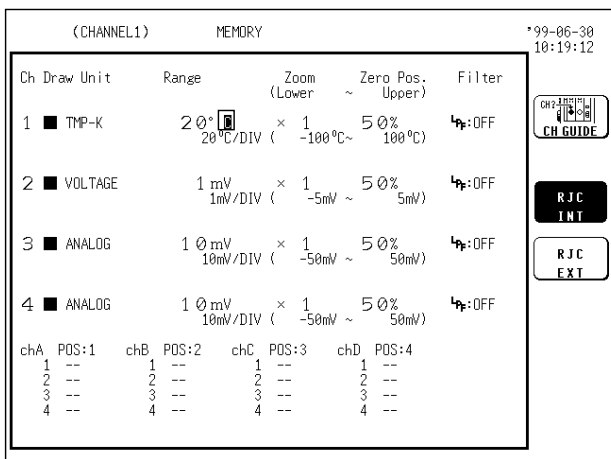

1. Call up the CHANNEL 1 or DISPLAY screen.

2. Move the flashing cursor to the point shown in the figure on the left.

3. Use the function keys to make the selection.

**RJC INT**: Reference junction compensation is performed internally by the 8937. (Measurement accuracy is the sum of the accuracy of temperature measurement plus reference junction compensation accuracy.)

**RJC EXT**: Reference junction compensation is not performed by the 8937. Select this option when using an external reference junction compensation unit. (Measurement accuracy refers only to the accuracy of temperature measurement.)

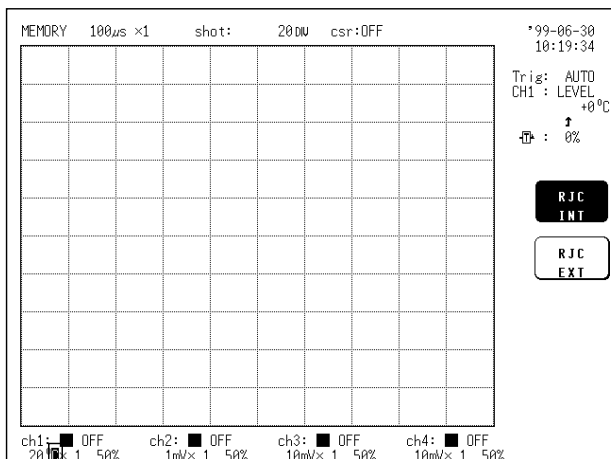

Discriminating between internal and external reference junction compensation

20°C Internal: No underbar appears below C.

20°C External: The underbar appears below C.

## Measurement range and upper and lower limits of measurement input

Note that the upper and lower limits of measurement input vary according to measurement range. Waveform saturation will result if the limits indicated in the table below are exceeded.

Measurement range	20 /DIV	40 /DIV	100 /DIV	200 /DIV
Upper limit of measurement input	400	800	2000	4000
Lower limit of measurement input	-92	-184	-460	-920

### Examples of waveform display measurement according to measurement range

(Zero position: 50%, magnification/compression ratio: x 1, NORMAL screen, thermocouple: T)

When thermocouple measurement range is exceeded

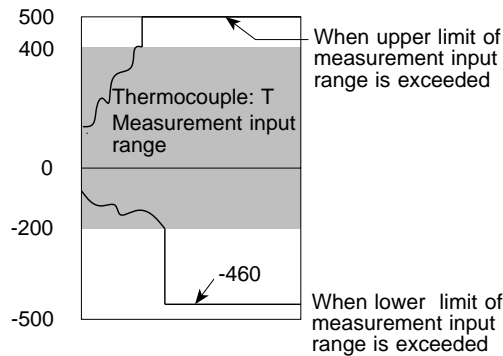

Thermocouple: T  
 Measurement input range: -200 to 400  
 Measurement range: 100 /DIV

Within thermocouple measurement range

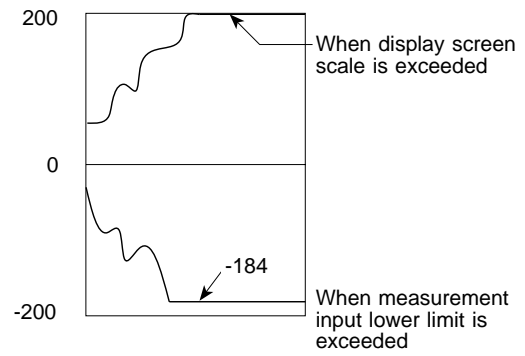

Thermocouple: T  
 Measurement input range: -200 to 400  
 Measurement range: 40 /DIV

### Determining Measurement Conditions

- Measurement conditions for the measured waveform data can be determined from the printed listing.
- The settings for the digital filter, drift compensation, reference junction compensation and the type of thermocouple can be determined.

HIOKI 8835 MEMORY HiRECORDER  
 Trig-time: '99-06-07 10:25:46

STATUS		TRIGGER			
Function :	MEMORY	Trig-mode :	AUTO	Pre-trig :	0%
Time/DIV :	100μs	Trig-source :	OR		
Shot :	20DIV	1 :	OFF		
Format :	SINGLE	2 :	OFF		
Roll mode :	OFF	3 :	OFF		
Print mode :	WAVE	4 :	OFF		
Smooth print :	OFF	5 :	OFF		
Auto print :	OFF	6 :	OFF		
Auto save :	OFF	7 :	OFF		
Overlay :	OFF	8 :	OFF		
		Logic			
		A :	OFF	B :	OFF
		C :	OFF	D :	OFF
		Timer-trig :	OFF		
		External :	OFF	Manual :	OFF

SYSTEM		CHANNEL														
Use channel :	CH1-8	ch.	draw	graph	range	zoom	(	/DIV)	zero	pos.	filter	(	lower	~	upper	)
Start back up :	OFF	1 :	C4	-	20°C	□	×	1(	20°C	50%	☑	OFF	(	-100°C	~	100°C)
Grid type :	STANDARD	2 :	C4	-	20°C	□	×	1(	20°C	50%	☐	OFF	(	-100°C	~	100°C)
Channel marker :	CH No.	3 :	C4	-	1mV	□	×	1(	1mV	50%	☐	OFF	(	-5mV	~	5mV)
Time value :	TIME	4 :	C4	-	1mV	□	×	1(	1mV	50%	☐	OFF	(	-5mV	~	5mV)
List & Gauge :	GAUGE	5 :	OFF													
Print density :	DARK	6 :	OFF													
Back light saver :	OFF	7 :	OFF													
Display color :	COLOR 1	8 :	OFF													
Beep sound :	ON1															
Language :	ENGLISH															

Reference junction compensation settings      Types of thermocouple

Drift compensation ON      Digital filter ON

Printed listing

## 7.5 Making the Settings of the 8938 FFT ANALOG UNIT

(CHANNEL1)		MEMORY		*99-06-30 10:20:22	
Ch	Draw Unit	Range	Zoom (Lower ~ Upper)	Zero Pos. ~	Filter
1	FFT	1 0 mV 10mV/DIV	× 1 (-50mV ~ 50mV)	5 0%	LP: OFF HP: OFF
2	FFT	1 0 mV 10mV/DIV	× 1 (-50mV ~ 50mV)	5 0%	LP: OFF HP: OFF
3	ANALOG	1 0 mV 10mV/DIV	× 1 (-50mV ~ 50mV)	5 0%	LP: OFF HP: OFF
4	ANALOG	1 0 mV 10mV/DIV	× 1 (-50mV ~ 50mV)	5 0%	LP: OFF HP: OFF
chA	POS:1	chB	POS:2	chC	POS:3
1	--	1	--	1	--
2	--	2	--	2	--
3	--	3	--	3	--
4	--	4	--	4	--

Displays the type of the installed unit

### 7.5.1 Settings

The settings of the waveform display color, waveform display graph type, voltage axis range, input coupling, magnification/compression ratio along the voltage axis, zero position, zero adjustment and low-pass filter are the same as in the 8936 ANALOG UNIT.

For the settings, see Section 7.3.

### 7.5.2 Setting the Anti-aliasing Filter (Advanced Version)

The 8938 FFT ANALOG UNIT incorporates an antialiasing filter designed to prevent aliasing distortion. The filter can be set to ON or OFF. The cutoff frequency of the filter is set automatically, according to the frequency range setting.

**Method** Screen: CHANNEL 1

(CHANNEL1)		MEMORY		*99-06-30 10:20:47	
Ch	Draw Unit	Range	Zoom (Lower ~ Upper)	Zero Pos. ~	Filter
1	FFT	1 0 mV 10mV/DIV	× 1 (-50mV ~ 50mV)	5 0%	LP: OFF HP: OFF
2	FFT	1 0 mV 10mV/DIV	× 1 (-50mV ~ 50mV)	5 0%	LP: OFF HP: OFF
3	ANALOG	1 0 mV 10mV/DIV	× 1 (-50mV ~ 50mV)	5 0%	LP: OFF HP: OFF
4	ANALOG	1 0 mV 10mV/DIV	× 1 (-50mV ~ 50mV)	5 0%	LP: OFF HP: OFF
chA	POS:1	chB	POS:2	chC	POS:3
1	--	1	--	1	--
2	--	2	--	2	--
3	--	3	--	3	--
4	--	4	--	4	--

1. Press the **CHAN** key to call up the CHANNEL 1 screen.

2. Move the flashing cursor to the point shown in the figure on the left, and use the function keys to make the selection.

: Anti-aliasing filter is disabled.

: Anti-aliasing filter is enabled.

Frequency Range, Frequency Resolution, Window Width,  
Corresponding Time Axis Range (Number of FFT points: 1000)

Frequency range [ Hz ]	Frequency resolution [ Hz ]	Window width	Time axis [ /DIV ]
400 k * <sup>1</sup>	1 k	1 ms	100 μs
200 k * <sup>1</sup>	500	2 ms	200 μs
80 k * <sup>1</sup>	200	5 ms	500 μs
40 k	100	10 ms	1 ms
20 k	50	20 ms	2 ms
8 k	20	50 ms	5 ms
4 k	10	100 ms	10 ms
2 k	5	200 ms	20 ms
800	2	500 ms	50 ms
400	1	1 s	100 ms
200	500 m	2 s	200 ms
80	200 m	5 s	500 ms
40	100 m	10 s	1 s
20	50 m	20 s	2 s
8 * <sup>2</sup>	20 m	50 s	5 s
4 * <sup>2</sup>	10 m	100 s	10 s
1.33 * <sup>2</sup>	3.3 m	5 min	30 s
667 m * <sup>2</sup>	1.67 m	10 min	1 min
333 m * <sup>2</sup>	0.83 m	20 min	2 min
133 m * <sup>2</sup>	0.33 m	50 min	5 min

The cutoff frequency of the antialiasing filter is the same as the selected frequency range, except for the cases listed below.

\*<sup>1</sup>: Antialiasing filter is OFF.

\*<sup>2</sup>: Cutoff frequency is 20 Hz.

## 7.6 Making the Settings of the 8939 STRAIN UNIT

This section explains the settings of the 8939 STRAIN UNIT.

The 8939 STRAIN UNIT is a unit for making measurements using a strain gauge adapter.

(CHANNEL1)		MEMORY		*99-06-30 10:21:32			
Ch	Draw Unit	Range	Zoom (Lower ~ Upper)	Zero Pos. ~	Filter		
1	STRAIN	50 $\mu\epsilon$ 50 $\mu\epsilon$ /DIV (	$\times$ 1 -250 $\mu\epsilon$ ~	50 % 250 $\mu\epsilon$ )	Hz: OFF		
2	STRAIN	50 $\mu\epsilon$ 50 $\mu\epsilon$ /DIV (	$\times$ 1 -250 $\mu\epsilon$ ~	50 % 250 $\mu\epsilon$ )	Hz: OFF		
3	ANALOG	10 mV 10 mV/DIV (	$\times$ 1 -50 mV ~	50 % 50 mV)	Hz: OFF		
4	ANALOG	10 mV 10 mV/DIV (	$\times$ 1 -50 mV ~	50 % 50 mV)	Hz: OFF		
chA	POS:1	chB	POS:2	chC	POS:3	chD	POS:4
1	--	1	--	1	--	1	--
2	--	2	--	2	--	2	--
3	--	3	--	3	--	3	--
4	--	4	--	4	--	4	--

Displays the type of the installed unit

### 7.6.1 Setting the Waveform Display Color

Set the display color for the waveform.

For the setting, see Section 7.3.1.

### 7.6.2 Setting the Waveform Display Graph Type

Set the display format for the waveform display screen.

For the setting, see Section 7.3.2.

### 7.6.3 Setting the Measurement Range

- The measurement range for each channel is set.
- The set value denotes the range for 1 DIV vertically.

## Method 1 Screen: CHANNEL 1, DISPLAY

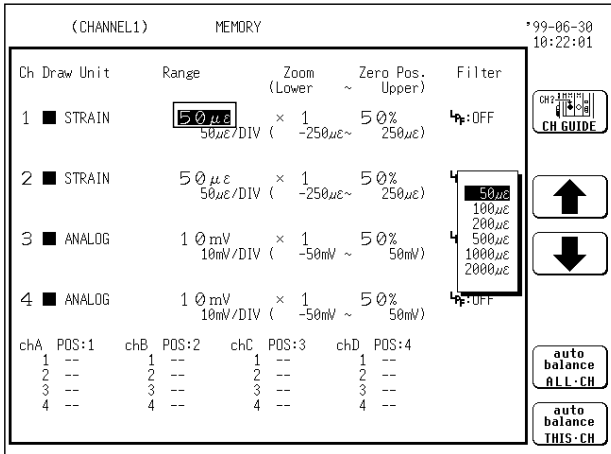

1. Call up the CHANNEL 1 or DISPLAY screen.
2. Move the flashing cursor to the point shown in the figure on the left.
3. Use the JOG control or the function keys to make the selection.



: Move the cursor up in the selection window.



: Move the cursor down in the selection window.

### NOTE

On the DISPLAY screen, the selection window is not displayed.

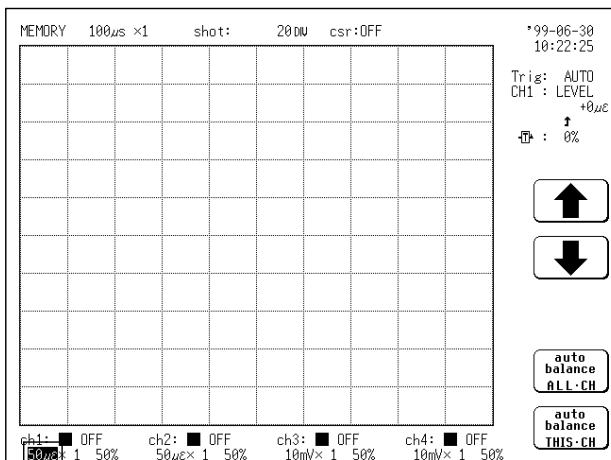

## Method 2 Screen: CHANNEL 1, DISPLAY

Press the **INPUT RANGE** key to set the range for each channel.

### NOTE

- The **INPUT RANGE** key can be used regardless of where the flashing cursor is located, if the CHANNEL 1 or DISPLAY screen is displayed.
- If the variable function is enabled, the size of a waveform on the screen does not change, even if the measurement range is changed.

## 7.6.4 Auto-balancing

- This function aligns the reference output level of the adapter with the specified origin position.
- Allow the unit to warm up for at least approx. one hour to ensure that the internal temperature of the input units has stabilized.
- It can be specified whether the auto balancing is applied only to a selected channel or to all channels.



## Method Screen: CHANNEL 1, DISPLAY

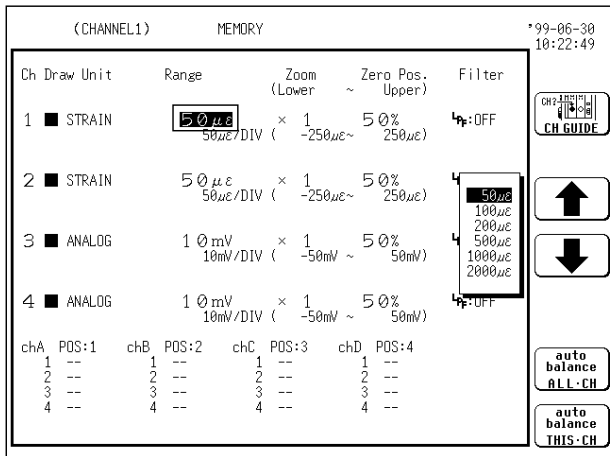

1. Call up the CHANNEL 1 or DISPLAY screen.
2. Move the flashing cursor to the point shown in the figure on the left.

3. Use the function keys to make the selection.

**auto balance THIS-CH** : Carries out auto-balancing for the selected channel only.

**auto balance ALL-CH** : Carries out auto-balancing for all of the strain unit channels.

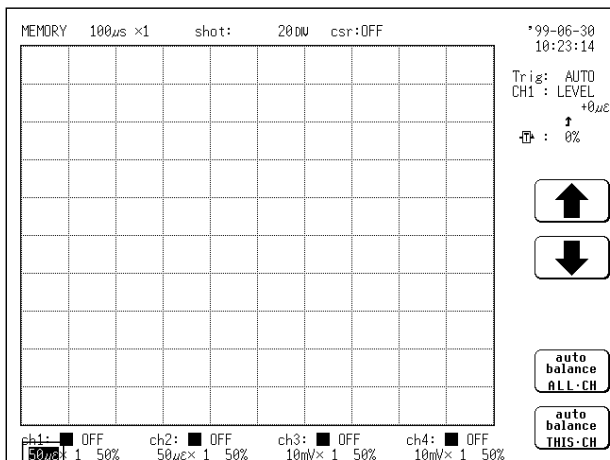

### NOTE

- Connect the sensor, make sure there is no input, and execute auto balancing.
- Auto-balancing cannot be performed during measurement.
- During auto-balancing, the keys are inactive.
- Repeat the auto-balancing when the setting range was changed, when the input unit was changed, when the strain gauge adapter was changed, when the zero position was changed, when the power is on/off, or when the system is set to reset.
- When there is a sudden change in ambient temperature, the zero position may drift. To assure continued measurement precision, perform the auto-balancing again.

## 7.6.5 Setting the Magnification/Compression Ratio Along the Measurement Range

- Specifies the magnification/compression ratio for each channel to be used for display and recording.
- Performs magnification/compression using the center of the screen as reference.

For the setting, see Section 7.3.5.

## 7.6.6 Setting the Zero Position

The position of 0  $\mu$  is set.  
 For the setting, see Section 7.3.6.

## 7.6.7 Setting the Low-Pass Filter

- Low-pass filters internal to the input units are set.
- Effective for removing unneeded high-frequency components.

**Method** Screen: CHANNEL 1, DISPLAY

(CHANNEL1) MEMORY \*99-06-30 10:23:46

Ch	Draw	Unit	Range	Zoom (Lower ~ Upper)	Zero Pos.	Filter
1	■	STRAIN	50 $\mu$ ε 50 $\mu$ ε/DIV	× 1 (-250 $\mu$ ε ~ 250 $\mu$ ε)	50%	OFF
2	■	STRAIN	50 $\mu$ ε 50 $\mu$ ε/DIV	× 1 (-250 $\mu$ ε ~ 250 $\mu$ ε)	50%	OFF
3	■	ANALOG	10 mV 10 mV/DIV	× 1 (-50 mV ~ 50 mV)	50%	OFF
4	■	ANALOG	10 mV 10 mV/DIV	× 1 (-50 mV ~ 50 mV)	50%	OFF

CH GUIDE  
 OFF  
 10 Hz  
 30 Hz  
 300 Hz  
 3 kHz

chA	POS:1	chB	POS:2	chC	POS:3	chD	POS:4
1	--	1	--	1	--	1	--
2	--	2	--	2	--	2	--
3	--	3	--	3	--	3	--
4	--	4	--	4	--	4	--

1. Call up the CHANNEL 1 or DISPLAY screen.
2. Move the flashing cursor to the point shown in the figure on the left.
3. Use the function keys to make the selection.

- OFF : No low-pass filter is connected.
- 10 Hz : Connect a filter with a cutoff frequency of 10 Hz
- 30 Hz : Connect a filter with a cutoff frequency of 30 Hz
- 300 Hz : Connect a filter with a cutoff frequency of 300 Hz
- 3 kHz : Connect a filter with a cutoff frequency of 3 kHz

MEMORY 100  $\mu$ s ×1 shot: 200W csr:OFF \*99-06-30 10:24:10

Trig: AUTO  
 CH1: LEVEL  
 +0  $\mu$ ε  
 0%

OFF  
 10 Hz  
 30 Hz  
 300 Hz  
 3 kHz

ch1: ■ OFF 50  $\mu$ ε × 1 50%  
 ch2: ■ OFF 50  $\mu$ ε × 1 50%  
 ch3: ■ OFF 10 mV × 1 50%  
 ch4: ■ OFF 10 mV × 1 50%

## 7.7 Making the Settings of the 8940 F/V UNIT

This section explains the settings of the 8940 F/V UNIT.

The 8940 F/V UNIT measures frequency, count, pulse duty ratio, voltage and current at each channel (one measurement type is available for each channel).

Frequency:	Frequency is obtained from input pulses derived from the measured waveform.
Count:	This is a count of the number of input pulses.
Pulse Duty Ratio:	This is the duty ratio of the measured waveform.
Voltage:	Measures the voltage waveform
Current:	Measures the current waveform

### Notes on measuring the pulses duty ratio

Upon measurement of pulses that rise during dead time, the duty ratio is determined from pulses that follow the dead time; the duty ratio of dead time pulses is not measured.

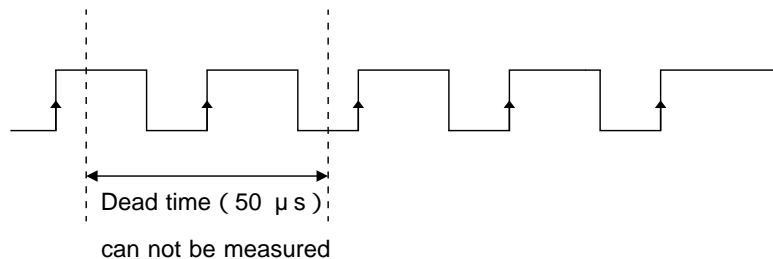

(CHANNEL1)		MEMORY		*99-06-30 10:27:17			
Ch	Draw Unit	Range	Zoom (Lower ~ Upper)	Zero Pos. ~ Upper	Filter		
1	■ FREQUENCY +0.0V	0.1 Hz 0.1Hz/DIV	× 1 (-500mHz~ 500mHz)	5 0%	⚡:OFF		
2	■ FREQUENCY +0.0V	0.1 Hz 0.1Hz/DIV	× 1 (-500mHz~ 500mHz)	5 0%	⚡:OFF		
3	■ ANALOG	1 0 mV 10mV/DIV	× 1 (-50mV ~ 50mV)	5 0%	⚡:OFF		
4	■ ANALOG	1 0 mV 10mV/DIV	× 1 (-50mV ~ 50mV)	5 0%	⚡:OFF		
chA	POS:1	chB	POS:2	chC	POS:3	chD	POS:4
1	--	1	--	1	--	1	--
2	--	2	--	2	--	2	--
3	--	3	--	3	--	3	--
4	--	4	--	4	--	4	--

Displays the measurement mode

### 7.7.1 Settings

The settings of the waveform display color, waveform display graph type, magnification/compression ratio along the voltage axis, zero adjustment, baseline offset and low-pass filter are the same as in the 8936 ANALOG UNIT.

For the settings, see Section 7.3.

## 7.7.2 Setting for Measuring Frequency

Measurement of frequency allows three types of measurements: frequency, cycle and commercial power supply.

Frequency is between 0.1 Hz to 10 kHz, cycle is between 10 r/min to 1 kr/min and commercial power supply is P50 Hz or P60 Hz.

### Setting the Measurement Mode

Method Screen: CHANNEL 1

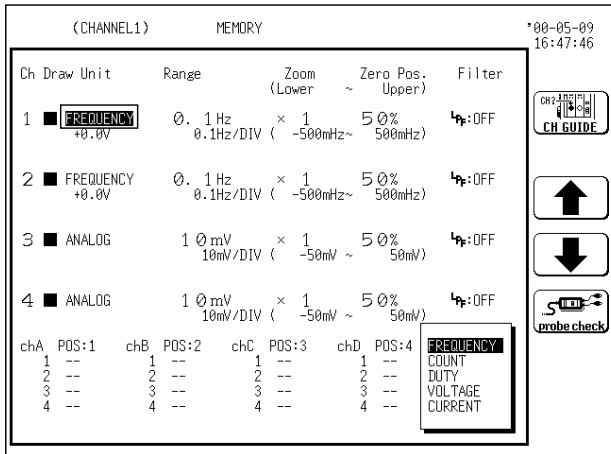

1. Call up the CHANNEL 1 screen.
2. Move the flashing cursor to the **unit** item.
3. Use the JOG control or the function keys to select Frequency.



: Move the cursor up in the selection window.



: Move the cursor down in the selection window.



: Probe check is performed.

#### NOTE

For the probe check, see Section 7.7.5.

## Setting the Measurement Range and Hold

Set the measurement range and Hold.

Hold is a function for retaining the preceding result.

When Hold is enabled (ON), the previously measured value is displayed until the next frequency measurement is confirmed.

When Hold is disabled (OFF), half of the previously measured value is displayed if the next frequency measurement is not confirmed within a specified time (selectable from 10 ms or 1 s). The half value display remains for as long as the next frequency measurement is not confirmed within the specified time. When the next frequency measurement is confirmed, the new value is displayed.

### Method Screen: CHANNEL 1, DISPLAY

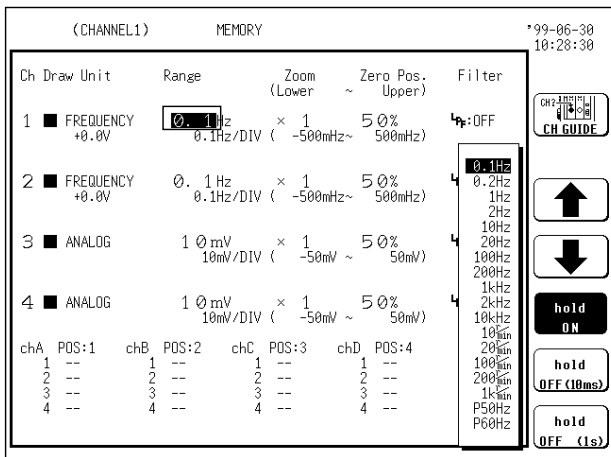

1. Call up the CHANNEL 1 or DISPLAY screen.
2. Move the flashing cursor to the **range** item.
3. Use the function keys, the jog control or the **RANGE** key to make the selection.



: Move the cursor up in the selection window.



: Move the cursor down in the selection window.

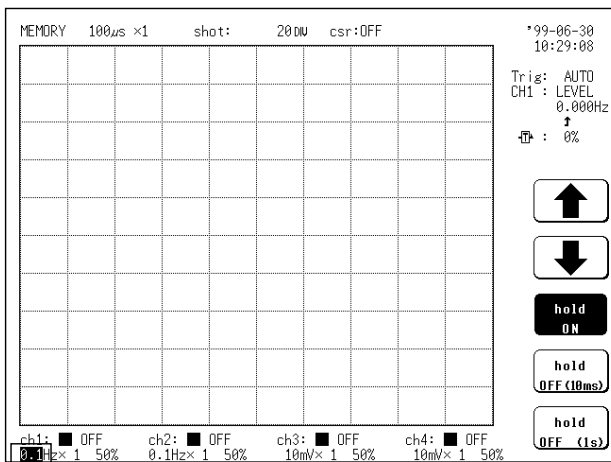

4. Set the Hold.



: Hold the last value until the next frequency measurement is confirmed.



: Half of the last value is displayed if the next frequency measurement is not confirmed within 10 ms.



: Half of the last value is displayed if the next frequency measurement is not confirmed within 1 s.

#### NOTE

- The measurement range can be set to P50 Hz or P60 Hz for commercial power. Although 0 Hz is the usual zero position, in this case 50 or 60 Hz becomes the zero position.
- Hold settings cannot be determined from the DISPLAY or CHANNEL 1 screen. Check through the function display that appears when the flashing cursor is moved to the "range" item. Hold ON or OFF is printed when doing a list print.

**About Hold ON/OFF**

(1) Hold ON/OFF in the stopping operation

For Frequency and RPM measurement, results are displayed after one confirmation cycle.

When measuring phenomena such as stopping of a rotating body, if Hold is ON, stopping cannot be detected because there is no confirmation cycle.

When Hold is OFF, half of the previous measurement value is displayed if the confirmation cycle does not occur within the specified time (10 ms or 1 s).

Therefore, a condition such as stopping can be estimated by gradually approaching zero.

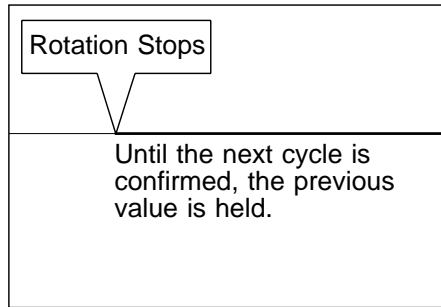

Hold ON

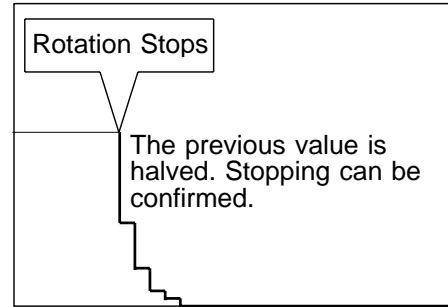

Hold OFF

(2) The following are differences depending on whether Hold is ON or OFF when the frequency drops to 0 Hz from a certain frequency, then increases from that point.

**Actual Event**

Frequency drops to 0 Hz from a certain frequency, then increases from that point.

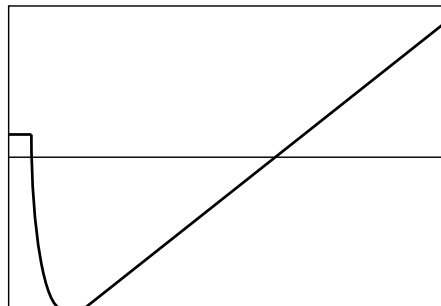

**When Hold is ON**

The initial value is held (the signal is not halved), so the result is as shown in the diagram below.

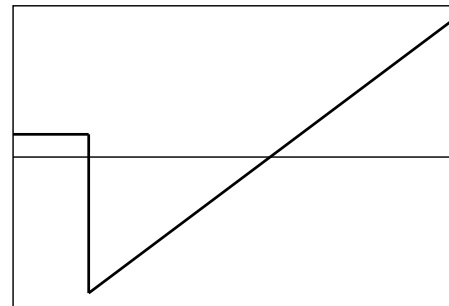

**When Hold is OFF (10 ms)**

At frequencies of less than 100 Hz, the signal is halved.

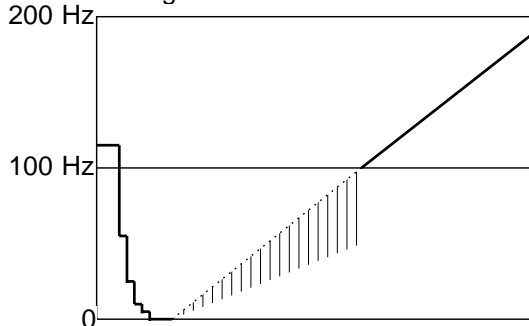

**When Hold is OFF (1 s)**

At frequencies of less than 1 Hz, the signal is halved.

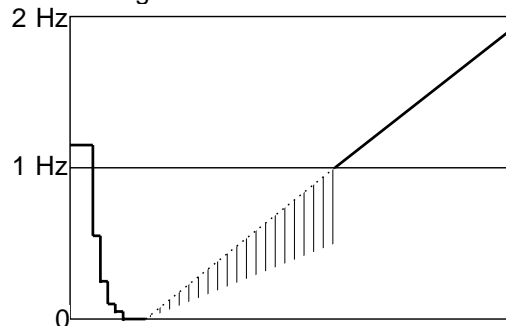

## Setting the Pull-Up Resistance

- Set the pull-up resistance on or off.
- Pull-up resistance is used when connecting to an open collector output signal. For normal measurements, disable the pull-up resistance (set to OFF).

**Method** Screen: CHANNEL 1, DISPLAY

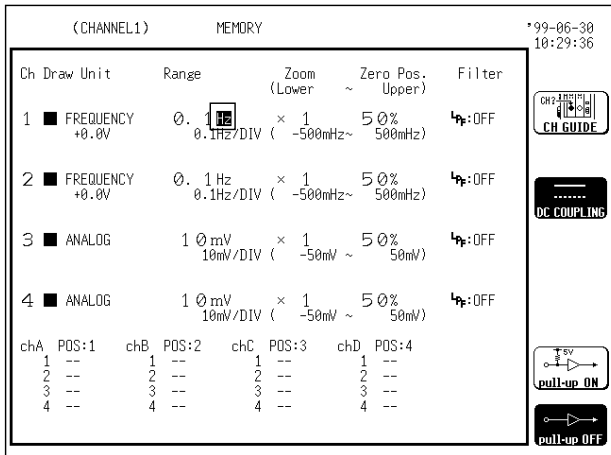

1. Call up the CHANNEL 1 or DISPLAY screen.
2. Move the flashing cursor to the point shown in the figure on the left.

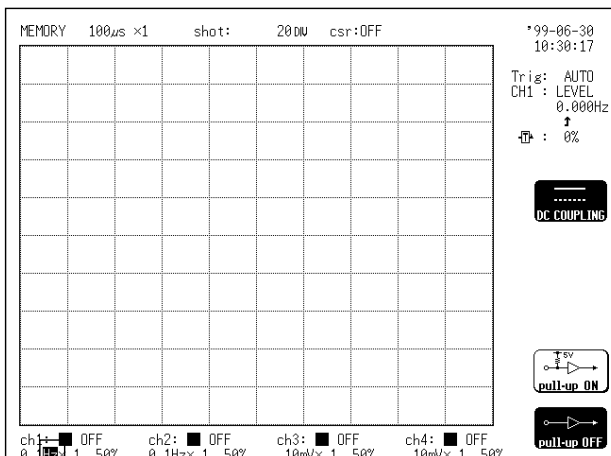

3. Use the function keys to make the selection.

 : Pull-up resistance is enabled (ON).  
(for connection to open collector)

 : Pull-up resistance is disabled (OFF).

### NOTE

Pull-up settings cannot be determined from the DISPLAY or CHANNEL 1 screen. Check through the function display that appears when the flashing cursor is moved to the "input coupling" item.

Pull-up ON or OFF is printed when doing a list print.

### Setting the Threshold Value

Set the threshold value.

**Method** Screen: CHANNEL 1

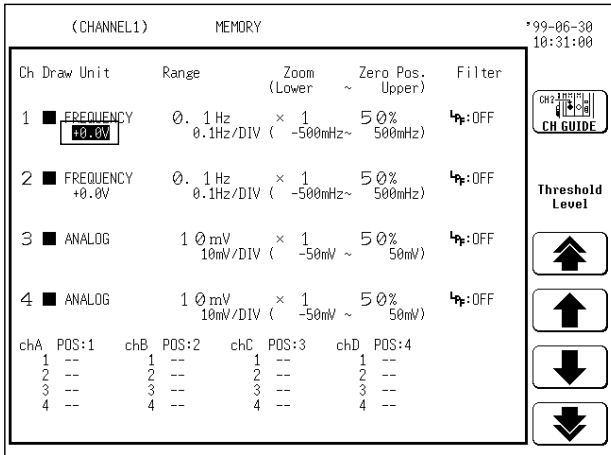

1. Call up the CHANNEL 1 screen.
2. Move the flashing cursor to the **threshold value** item.
3. Use the function keys or the jog control to make the setting.

- : Value up, large step
- : Value up, small step
- : Value down, small step
- : Value down, large step

**NOTE**

Measurement results may differ depending on the threshold setting. To obtain the correct measurement, set the threshold to match the input waveform.

Threshold Setting Example

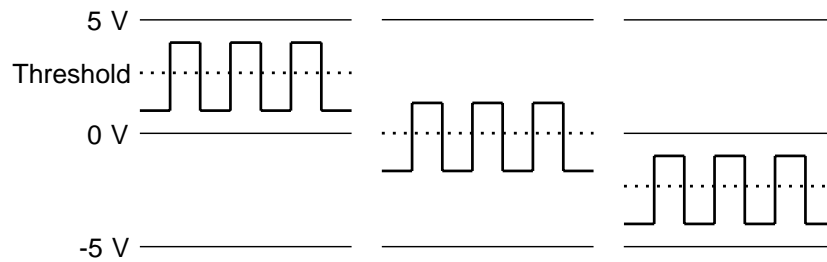

### 7.7.3 Setting Integral Measurement

- Set integral measurement.
- Adds input pulse counts.

#### Setting the Measurement Mode

**Method** Screen: CHANNEL 1

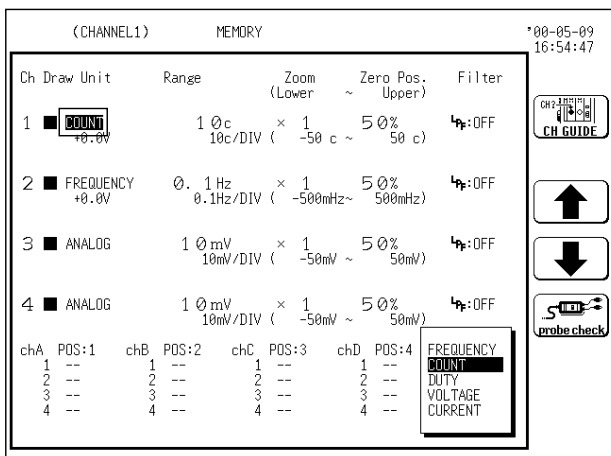

1. Call up the CHANNEL 1 screen.
2. Move the flashing cursor to the **unit** item.
3. Use the JOG control or the function keys to select count.

- : Move the cursor up in the selection window.
- : Move the cursor down in the selection window.
- : Probe check is performed.

**NOTE**

For the probe check, see Section 7.7.5.



## Setting the Measurement Range

- Set the measurement range.
- For count mode, the unit of measurement is 'c' (counts).

**Method** Screen: CHANNEL 1, DISPLAY

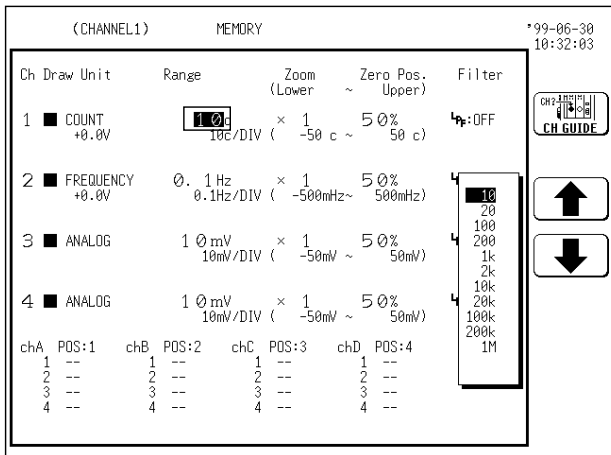

1. Call up the CHANNEL 1 or DISPLAY screen.
2. Move the flashing cursor to the **range** item.
3. Use the function keys, the jog control or the **RANGE** key to make the selection.



: Move the cursor up in the selection window.



: Move the cursor down in the selection window.

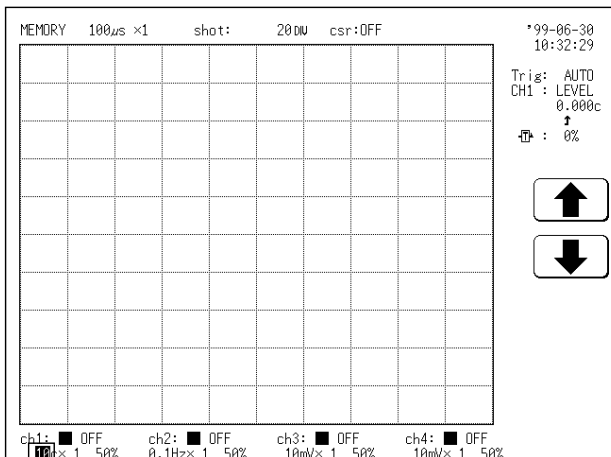

## Setting the Pull-Up Resistance

See Section 7.7.2.

## Setting the Threshold Value

See Section 7.7.2.

## 7.7.4 Setting for Measuring Pulse Duty Ratio

### Setting the Measurement Mode

Method Screen: CHANNEL 1

Ch	Draw	Unit	Range	Zoom (Lower ~ Upper)	Zero Pos. ~	Filter
1	■	DUTY +0.0V	1 0% 10%/DIV (	× 1 -50% ~	5 0% 50%)	hp: OFF
2	■	FREQUENCY +0.0V	0. 1Hz 0.1Hz/DIV (	× 1 -500mHz~	5 0% 500mHz)	hp: OFF
3	■	ANALOG	1 0 mV 10mV/DIV (	× 1 -50mV ~	5 0% 50mV)	hp: OFF
4	■	ANALOG	1 0 mV 10mV/DIV (	× 1 -50mV ~	5 0% 50mV)	hp: OFF

chA	POS:1	chB	POS:2	chC	POS:3	chD	POS:4
1	--	1	--	1	--	1	--
2	--	2	--	2	--	2	--
3	--	3	--	3	--	3	--
4	--	4	--	4	--	4	--

FUNCTION	DESCRIPTION
↑	Move the cursor up in the selection window.
↓	Move the cursor down in the selection window.
probe check	Probe check is performed.

1. Call up the CHANNEL 1 screen.
2. Move the flashing cursor to the **unit** item.
3. Use the JOG control or the function keys to select **DUTY**.



: Move the cursor up in the selection window.



: Move the cursor down in the selection window.



: Probe check is performed.

#### NOTE

For the probe check, see Section 7.7.5.

### Setting the Pull-Up Resistance

See Section 7.7.2.

### Setting the Threshold Value

See Section 7.7.2.

## 7.7.5 Setting for Measuring Voltage

The settings of the waveform display color, waveform display graph type, measurement range, input coupling, magnification/compression ratio along the voltage axis, zero adjustment, baseline offset and low-pass filter are the same as in the 8936 ANALOG UNIT.

For the settings, see Section 7.3.

### Setting the Measurement Mode

Method Screen: CHANNEL 1

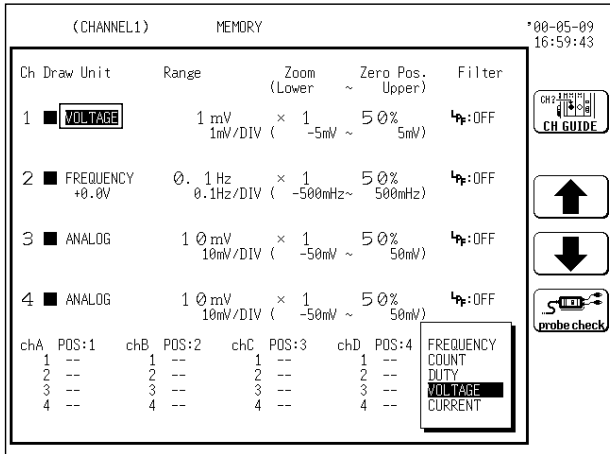

1. Call up the CHANNEL 1 screen.

2. Move the flashing cursor to the **unit** item.

3. Use the JOG control or the function keys to select Voltage.



: Move the cursor up in the selection window.



: Move the cursor down in the selection window.

### Setting the Pull-Up Resistance

See Section 7.7.2.

### Probe Check

- When using the 9322 DIFFERENTIAL PROBE with the 8940 F/V UNIT, the probe check confirms the 9322 connection and sets the voltage axis scale multiplier to 1000 times. For frequency, duty ratio and count modes, the threshold value is multiplied times 100.
- When several 9332s are connected to the 8940 F/V UNIT, the probe check need be performed only once for all probes.

Method Screen: CHANNEL 1, DISPLAY

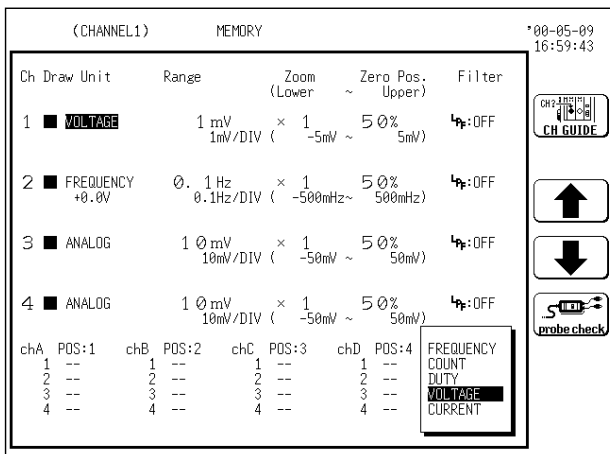

1. Move the flashing cursor to the **unit** item.

2. Use the JOG control or the function keys to select voltage. The probe check may be performed from the frequency, count or duty modes.

3. Connect the 9322 DIFFERENTIAL PROBE to be used and select probe check from the displayed function keys.



: Probe check is performed.

#### NOTE

For more details, refer to instruction manual of the 9322 DIFFERENTIAL PROBE.

## 7.7.6 Setting for Measuring Current

- Measures electric current with clamp on sensor or clamp on probe.
- When starting up MEMORY HiCORDER with 9439 DC POWER ADAPTER, measuring in parallel with printing this limits number of available channels for current measurement.
- The settings of the waveform display color, waveform display graph type, input coupling, magnification/compression ratio along the voltage axis, zero adjustment, baseline offset and low-pass filter are the same as in the 8936 ANALOG UNIT. For the settings, see Section 7.3.

### Setting the Measurement Mode

Method Screen: CHANNEL 1

(CHANNEL1) MEMORY \*99-06-30 10:39:12

Ch	Draw	Unit	Range	Zoom (Lower ~ Upper)	Zero Pos. (Lower ~ Upper)	Filter
1	■	CURRENT	1 0 mA 10mA/DIV	× 1 (-50mA ~ 50mA)	5 0% 50mA)	OFF
2	■	FREQUENCY	0. 1Hz 0.1Hz/DIV	× 1 (-500Hz~ 500Hz)	5 0% 500Hz)	OFF
3	■	ANALOG	1 0 mV 10mV/DIV	× 1 (-50mV ~ 50mV)	5 0% 50mV)	OFF
4	■	ANALOG	1 0 mV 10mV/DIV	× 1 (-50mV ~ 50mV)	5 0% 50mV)	OFF

chA POS:1 chB POS:2 chC POS:3 chD POS:4

1 -- 1 -- 1 -- 1 --  
2 -- 2 -- 2 -- 2 --  
3 -- 3 -- 3 -- 3 --  
4 -- 4 -- 4 -- 4 --

FREQUENCY  
COUNT  
DUTY  
VOLTAGE  
CURRENT

clamp check

1. Call up the CHANNEL 1 screen.

2. Move the flashing cursor to the unit item.

3. Use the JOG control or the function keys to select Current.

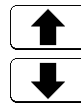

: Move the cursor up in the selection window.





: Move the cursor down in the selection window.

## Checking the Clamp

- The clamp check needs to be performed when Current mode is selected.
- The clamp check identifies the clamp sensor (probe) for use by the 8940. Measurement range is determined by the clamp to be used. It must be performed before current measurement.

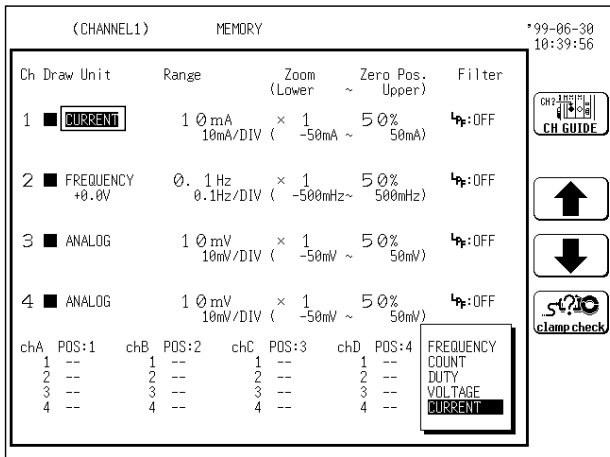
### Method Screen: CHANNEL 1



1. Move the flashing cursor to the **unit** item.
  2. Use the JOG control or the function keys to select current.
  3. Connect the clamp to be used and select clamp check from the displayed function keys.
- : Clamp check is performed.

### NOTE

- Always perform the clamp check before measuring current. Correct measurement is not possible if the clamp check has not been performed.
- When starting up MEMORY HiCORDER with 9439 DC POWER ADAPTER and current is selected in over 3 ch, printing is not available. Print after loading waveform or select less channels for current.
  1. When automatic printing and roll mode are set to ON in memory recorder.
  2. When printing is set to ON in recorder, RMS recorder and recorder & memory.
- For details on the clamp connections, see Section 2.4.4 8940 F/V UNIT.

## Setting the Measurement Range

- Measurement range is determined by the clamp to be used.
- See Section 7.7.3.

## 7.8 Making the Settings of the 8946 4 ch ANALOG UNIT

This section explains the settings of the 8946 4 ch ANALOG UNIT.

The 8946 4 ch ANALOG UNIT is a unit for measuring the voltage waveforms.

Ch	Draw	Unit	Range	Zoom (Lower ~ Upper)	Zero Pos. ~	Filter
1	4CH		20mV 20mV/DIV	× 1 (-100mV ~ 100mV)	50% 100mV	Hz: OFF
2	4CH		20mV 20mV/DIV	× 1 (-100mV ~ 100mV)	50% 100mV	Hz: OFF
3	ANALOG		10mV 10mV/DIV	× 1 (-50mV ~ 50mV)	50% 50mV	Hz: OFF
4	ANALOG		10mV 10mV/DIV	× 1 (-50mV ~ 50mV)	50% 50mV	Hz: OFF

chA	POS:1	chB	POS:2	chC	POS:3	chD	POS:4
1	--	1	--	1	--	1	--
2	--	2	--	2	--	2	--
3	--	3	--	3	--	3	--
4	--	4	--	4	--	4	--

Displays the type of the installed unit

### 7.8.1 Settings

The settings of the waveform display color, waveform display graph type, voltage axis range, magnification/compression ratio along the voltage axis, zero position, zero adjustment, baseline offset and low-pass filter are the same as in the 8936 ANALOG UNIT.

For the settings, see Section 7.3.

## 7.8.2 Setting the Input Coupling

The input coupling for the input signal is set.

**Method** Screen: CHANNEL 1, DISPLAY

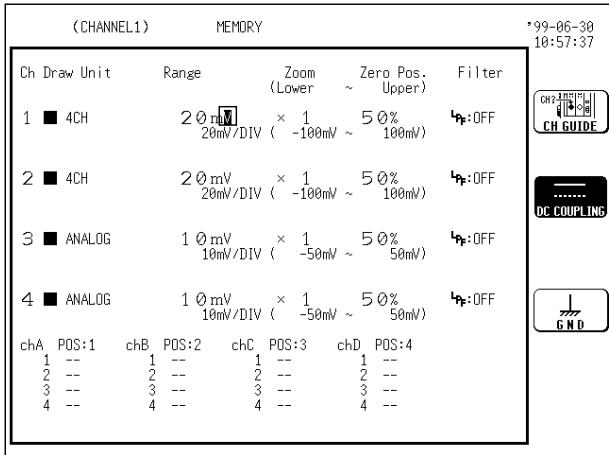

1. Call up the CHANNEL 1 or DISPLAY screen.

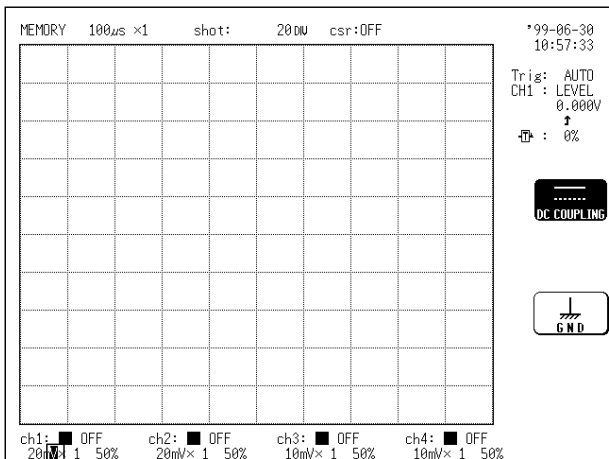

2. Use the **CH SELECT** key to open selected channel screen.

3. Move the flashing cursor to the point shown in the figure on the left.

4. Use the function keys to make the selection.

: DC coupling

: The input signal is not connected.  
This allows the zero position to be checked.

## 7.9 Making the Settings of the 8947 CHARGE UNIT

### ⚠ WARNING

- **DO NOT** connect connection cable to the 8947 CHARGE UNIT when connected to measuring unit to avoid risk of electric shock.
- BNC terminal and miniature connector terminal of each channel share same GND. Do not connect both at once.
- During measuring with measurement mode set to PREAMP or when level monitor function is in use, electric current (2 mA, +15 V) output is active. In order to avoid risk of electric shock and damage to testing device, examine channel mode for connecting sensor and probe to BNC terminal and either cancel PREAMP or shut down power.
- Voltage measurement and internal acceleration pickup sensor share same terminal. Make sure to check measurement mode before measuring.
- Before using internal acceleration pickup sensor, verify that sensor ratings is compatible with 8947 CHARGE UNIT rated output (2 mA, +15 V). Use of Non compatible sensor may cause damage to sensor.

8947 CHARGE UNIT can measure voltage or acceleration in each channel.  
(One type of measurement per channel)

Ch	Draw	Unit	Range	Zoom (Lower ~ Upper)	Zero Pos. 50%	Filter
1	CHARGE	1pC	1 1/2% 1 1/2%/DIV	× 1 -5 1/2%~	50%	HP: OFF LP: OFF
2	CHARGE	1pC	1 1/2% 1 1/2%/DIV	× 1 -5 1/2%~	50%	HP: OFF LP: OFF
3	ANALOG	10 mV	10 mV/DIV	× 1 -50 mV ~	50%	HP: OFF
4	ANALOG	10 mV	10 mV/DIV	× 1 -50 mV ~	50%	HP: OFF

chA	POS:1	chB	POS:2	chC	POS:3	chD	POS:4
--	1	--	1	--	1	--	1
--	2	--	2	--	2	--	2
--	3	--	3	--	3	--	3
--	4	--	4	--	4	--	4

Displays the measurement mode

Charge:

Measures with electrical charge output piezoelectric acceleration pickup sensor.

Preamp:

Measures with preamplifier internal acceleration pickup sensor.

Voltage:

Measures voltage waveform.

System reset defaults to Electrical Charge setting.

### 7.9.1 Settings

The settings of the waveform display color, waveform display graph type, magnification/compression ratio along the voltage axis, zero position, zero adjustment, baseline offset and low-pass filter are the same as in the 8936 ANALOG UNIT.

For the settings, see Section 7.3.



## 7.9.2 Setting for Measuring Acceleration

### WARNING

- Maximum electrical charge input is 500 pC at range 6 high sensitivity and 50000 pC at range 6 low sensitivity. Make sure input is within the range to avoid damage to unit.
- When selecting Preamp mode and starting up, confirmation message appears. Check channel connection before proceeding with measuring.
- When measuring starts in Preamp mode, electric current (2 A, + 15 V) output is active. Switching to another mode (Electrical Charge or Voltage) terminates output. (Not terminated by **STOP** key.)

### Setting the Measurement Mode

Method Screen: CHANNEL 1

(CHANNEL1)		MEMORY		*99-06-30 10:59:13			
Ch	Draw Unit	Range	Zoom (Lower ~ Upper)	Zero Pos. Upper	Filter		
1	CHARGE 1pC	1 $\mu\text{s}$ 1 $\mu\text{s}$ /DIV	$\times$ 1 -5 $\mu\text{s}$ ~	5 0% 5 $\mu\text{s}$	Hz: OFF Hz: OFF		
2	CHARGE 1pC	1 $\mu\text{s}$ 1 $\mu\text{s}$ /DIV	$\times$ 1 -5 $\mu\text{s}$ ~	5 0% 5 $\mu\text{s}$	Hz: OFF Hz: OFF		
3	ANALOG	1 0 mV 10mV/DIV	$\times$ 1 -50mV ~	5 0% 50mV	Hz: OFF		
4	ANALOG	1 0 mV 10mV/DIV	$\times$ 1 -50mV ~	5 0% 50mV	Hz: OFF		
chA	POS:1	chB	POS:2	chC	POS:3	chD	POS:4
1	--	2	--	3	--	4	--
2	--	3	--	4	--		
3	--						
4	--						

1. Call up the CHANNEL 1 screen.

2. Use the JOG control or the function keys to select Charge or Preamp.



: Move the cursor up in the selection window.



: Move the cursor down in the selection window.

### Adjusting Sensor Sensitivity

- Adjust sensor sensitivity.
- Sensor sensitivity is measured as a specific value of the acceleration sensor.
- Sensor sensitivity modifies measurement range. Adjust sensor sensitivity before setting measurement range (see Section 15.2.7).

Method Screen: CHANNEL 1

(CHANNEL1)		MEMORY		*99-06-30 10:59:36			
Ch	Draw Unit	Range	Zoom (Lower ~ Upper)	Zero Pos. Upper	Filter		
1	CHARGE 1pC	1 $\mu\text{s}$ 1 $\mu\text{s}$ /DIV	$\times$ 1 -5 $\mu\text{s}$ ~	5 0% 5 $\mu\text{s}$	Hz: OFF Hz: OFF		
2	CHARGE 1pC	1 $\mu\text{s}$ 1 $\mu\text{s}$ /DIV	$\times$ 1 -5 $\mu\text{s}$ ~	5 0% 5 $\mu\text{s}$	Hz: OFF Hz: OFF		
3	ANALOG	1 0 mV 10mV/DIV	$\times$ 1 -50mV ~	5 0% 50mV	Hz: OFF		
4	ANALOG	1 0 mV 10mV/DIV	$\times$ 1 -50mV ~	5 0% 50mV	Hz: OFF		
chA	POS:1	chB	POS:2	chC	POS:3	chD	POS:4
1	--	2	--	3	--	4	--
2	--	3	--	4	--		
3	--						
4	--						

1. Move the flashing cursor to the point shown in the figure on the left.

2. Use the function keys or the jog control to make the setting.



: Value up, large step



: Value up, small step



: Value down, small step



: Value down, large step

### NOTE

Sensor sensitivity is measured as a specific value of the acceleration sensor. Adjust sensor sensitivity to sensor to assure accurate acceleration values.

## Sensor sensitivity value

Sensor sensitivity set for the 8947 CHARGE UNIT is determined as value per  $m/s^2$ . For value per G determined acceleration sensors, adjust sensor sensitivity value by dividing by 9.8 ( $m/s^2$ ).

Example 1

When sensor sensitivity 1.08 ( $pC/(m/s^2)$ ) is noted, adjust setting value to 1.08.

Example 2

When sensor sensitivity 64.0 ( $pC/G$ ) is noted,

$64.0/9.8 = 6.53$  ( $pC/(m/s^2)$ )

adjust setting value to 6.53.

## Units

The 8947 CHARGE UNIT measures electrical charge per  $m/s^2$ .

Scaling function converts measurement into value per G.

Configure scaling settings as below.

[Conversion ratio scaling]

EU/V:  $1/9.8 = 0.1020E+00$

Offset:  $0.0000E+00$

EU: G

[2-point scaling]

$9.8000E+00$      $1.0000E+00$

$0.0000E+00$      $0.0000E+00$

EU: G

For details of of the scaling function, see Section 9.4.

## Using sensor outside setting range

Sensor sensitivity setting range is between 0.1 to 10 ( $pC/(m/s^2)$ ), 0.1 to 10 ( $mV/(m/s^2)$ ). Scaling allows use of sensor outside setting range.

**Method**    Screen: CHANNEL 1    SCALING (SYSTEM 3)

1. Display CHANNEL 1 screen and set sensor sensitivity. Multiply sensor sensitivity by appropriate number to determine value for setting.
2. Display SCALING screen and specify out-of-range sensor channel to either SCI or ENG.
3. Set conversion ratio at the same value as the number for multiplying sensor sensitivity.

(Example 1) When sensor sensitivity is 23.4 ( $pC/(m/s^2)$ )

Multiply value by  $1/2.34$  and take 10 ( $pC/(m/s^2)$ ) as sensor sensitivity value as setting.

Configure scaling.

[Conversion ratio scaling]

EU/V:  $10/23.4 = 0.4274E+00$

Offset:  $0.0000E+00$

EU:  $m/s^2$

[2-point scaling]

$2.3400E+01$      $1.0000E+01$

$0.0000E+00$      $0.0000E+00$

EU:  $m/s^2$

(Example 2) When sensor sensitivity is 0.05 (pC/(m/s<sup>2</sup>))

Multiply value by 2 and take 0.1 (pC/(m/s<sup>2</sup>)) as sensor sensitivity value as setting.

Configure scaling.

[Conversion ratio scaling]

EU/V: 0.1/0.05 = 2.0000E+00

Offset: 0.0000E+00

EU: m/s<sup>2</sup>

[2-point scaling]

0.0000E+00 0.0000E+00

0.0000E+00 0.0000E+00

EU: m/s<sup>2</sup>

## Setting the Measurement Range

- Set the measurement range.
- Sensor sensitivity modifies measurement range. Adjust sensor sensitivity before setting measurement range (see Section 15.2.7).

### Method Screen: CHANNEL 1, DISPLAY

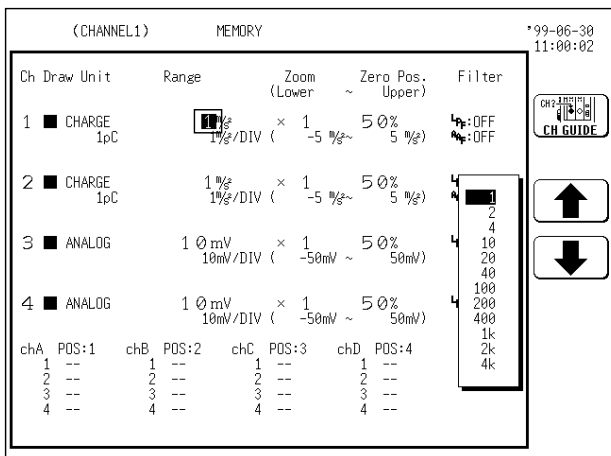

1. Move the flashing cursor to the point shown in the figure on the left.

2. Use the function keys or the jog control or to make the selection.



: Move the cursor up in the selection window.



: Move the cursor down in the selection window.

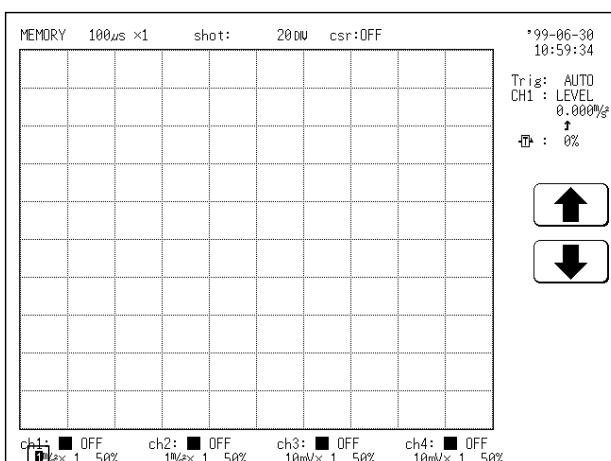

## Setting the Input Coupling

The input coupling for the input signal is set.

**Method** Screen: CHANNEL 1, DISPLAY

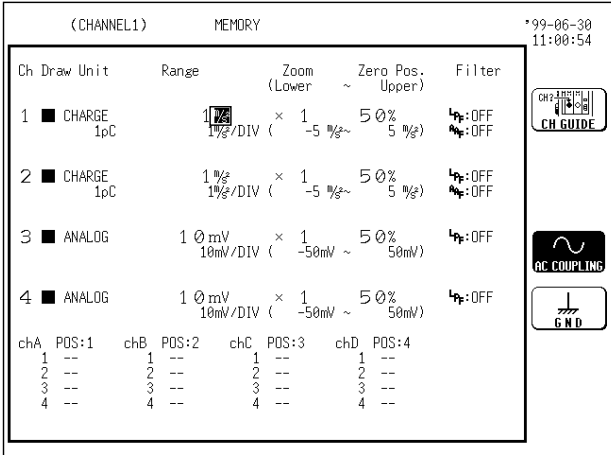

1. Move the flashing cursor to the point shown in the figure on the left.

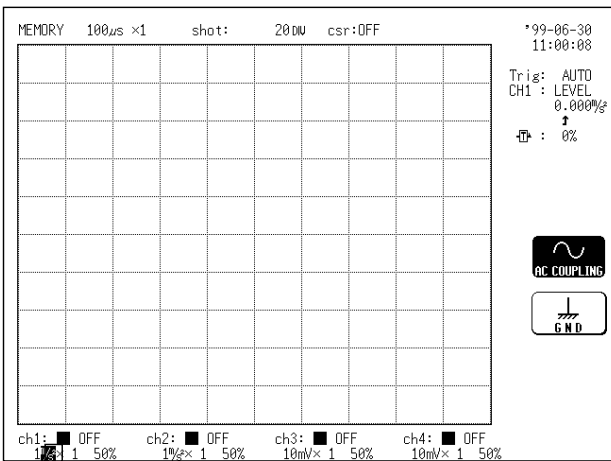

2. Use the function keys to make the selection.



AC coupling



The input signal is not connected.

This allows the zero position to be checked.

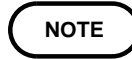

Charge and preamp mode do not enable DC coupling.

## Setting the Anti-aliasing Filter

- Set an antialiasing filter designed to prevent aliasing distortion.
- The cutoff frequency of the filter is set automatically, according to the frequency range and time axis range settings (see Section 7.5.2).

**Method** Screen: CHANNEL 1

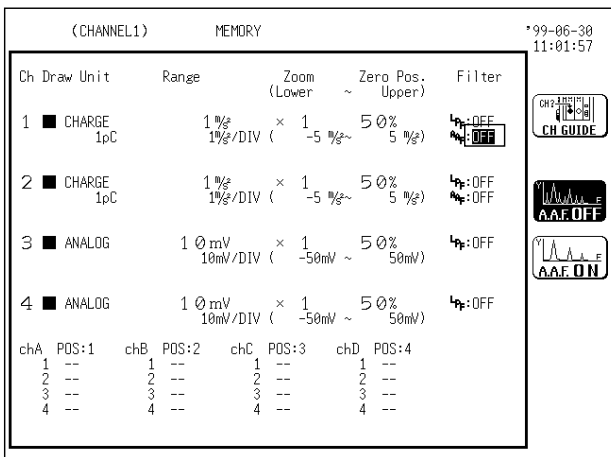

1. Move the flashing cursor to the point shown in the figure on the left.

2. Use the function keys to make the selection.



Anti-aliasing filter is disabled.



Anti-aliasing filter is enabled.

## 7.9.3 Setting for Measuring Voltage

### Setting the Measurement Mode

Method Screen: CHANNEL 1

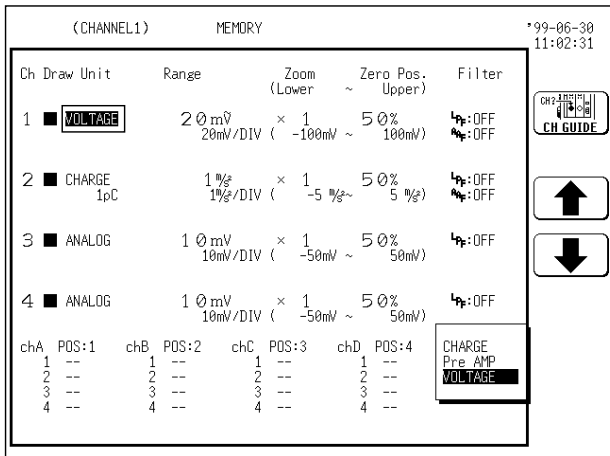

1. Call up the CHANNEL 1 screen.

2. Use the JOG control or the function keys to select Voltage.



: Move the cursor up in the selection window.



: Move the cursor down in the selection window.

### Setting the Anti-aliasing Filter

- Set an antialiasing filter designed to prevent aliasing distortion.
- The cutoff frequency of the filter is set automatically, according to the frequency range and time axis range settings (see Section 7.5.2).

Method Screen: CHANNEL 1, DISPLAY

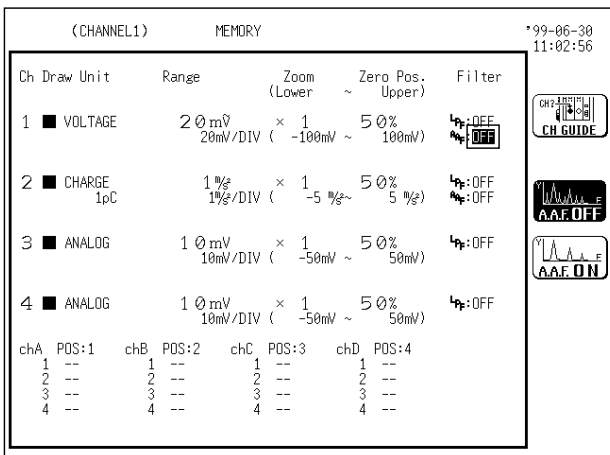

1. Move the flashing cursor to the point shown in the figure on the left.

2. Use the function keys to make the selection.



: Anti-aliasing filter is disabled.



: Anti-aliasing filter is enabled.

For the other settings, see Section 7.3.

# 7.10 Making Logic Input Settings

- Select the display positions for CH A - CH D (1 probe).
- Select the display color for the logic waveform.

**Method** Screen: CHANNEL 1

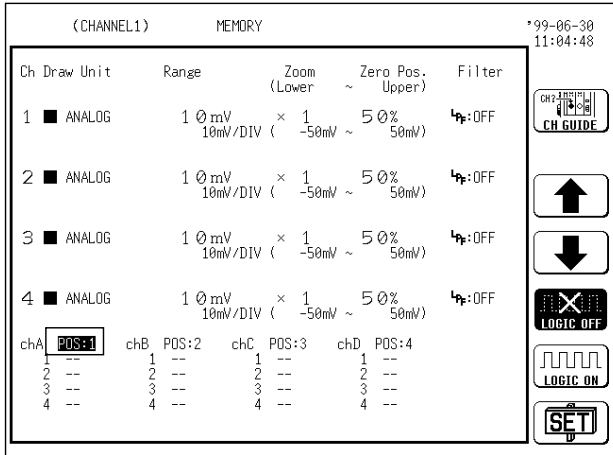

1. Press the **CHAN** key to call up the CHANNEL 1 screen.

2. Set the display position.

- (1) Move the flashing cursor to the "Position" point of the channel to be set, as shown in the figure on the left.
- (2) Use the function keys to set the position.

- : Change the display position.
- : Change the display position.
- : Logic waveforms are not displayed.
- : All logic waveforms are displayed.
- : Set to the displayed position number.

The logic waveform display positions are as follows.

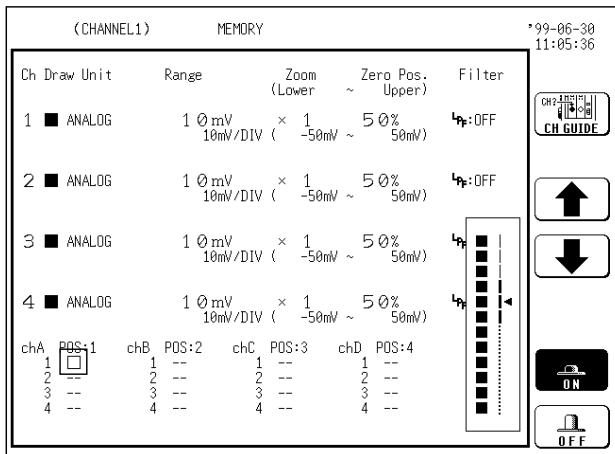
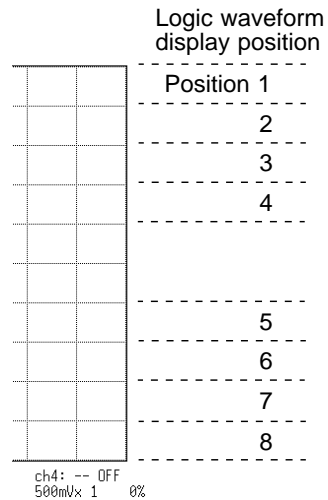



3. Set the display color.

- (1) Move the flashing cursor to the "1, 2, 3, 4" item of the channel for which the display color is to be set, as shown in the figure on the left.
- (2) Use the JOG control or the function keys to make the selection.

## NOTE

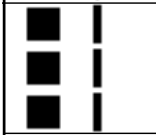
Depending on the waveform display color, the color of the printer output for either the print function or the hard copy function changes. See the following table.

Waveform display color	Print function	Hard copy function
	DARK	DARK
		
		LIGHT

## 7.11 Copying Channels

- Duplicates selected input channel configurations (voltage axis range, input coupling, low-pass filter) and variable function and comment settings to other channels.
- Channels cannot be copied unless same measuring mode is selected in channels to copy regardless of status of units.

### Method Screen: CHANNEL 1

(CHANNEL1)		MEMORY		*99-06-30 11:06:23	
Ch	Draw Unit	Range	Zoom (Lower ~ Upper)	Zero Pos. (Lower ~ Upper)	Filter
1	ANALOG	1 0mV 10mV/DIV	× 1 -50mV ~	50% 50mV	HP:OFF
<input checked="" type="checkbox"/>	ANALOG	1 0mV 10mV/DIV	× 1 -50mV ~	50% 50mV	HP:OFF
3	ANALOG	1 0mV 10mV/DIV	× 1 -50mV ~	50% 50mV	HP:OFF
4	ANALOG	1 0mV 10mV/DIV	× 1 -50mV ~	50% 50mV	HP:OFF
chA	POS:1	chB	POS:2	chC	POS:3
1	--	1	--	1	--
2	--	2	--	2	--
3	--	3	--	3	--
4	--	4	--	4	--

(CHANNEL2)		MEMORY		VARIABLE		*99-06-30 11:06:49	
Ch	Set	(Lower) (Range)	(Upper) (Position %)	(EU)			
1	OFF	[-5.0000E-02]	[+5.0000E-02]	(V)			
<input checked="" type="checkbox"/>	OFF	[-5.0000E-02]	[+5.0000E-02]	(V)			
3	OFF	[-5.0000E-02]	[+5.0000E-02]	(V)			
4	OFF	[-5.0000E-02]	[+5.0000E-02]	(V)			

(SYSTEM3)		COMMENT		*99-06-30 11:07:52	
Title	:	Setting	:		
ch1	:	[CH1 COMMENT]	:		
<input checked="" type="checkbox"/>	:	[CH2 COMMENT]	:		
ch3	:	[ ]	:		
ch4	:	[ ]	:		
ch5	:	[ ]	:		
ch6	:	[ ]	:		
ch7	:	[ ]	:		
ch8	:	[ ]	:		

1. Call up the CHANNEL 1 screen.

2. Use the **CH SELECT** key to display channel screen to copy.

3. Use the cursor key and move the flashing cursor of desired channel number to copy shown as figure left.

4. Use the function key or the jog control to select channel to copy.

When for ALL is selected, channel settings (comments) indicated by a flashing cursor are copied to all channels.

↑ : Channel number up

↓ : Channel number down

5. Press Execute function key to copy.

#### NOTE

- When copying input channel configuration, select for ALL to copy magnification and zero position.
- Input channel configuration, variable function and comment settings cannot be copied together at the same time.
- Depending on the waveform display color, the color of the printer output for either the print function or the hard copy function changes.



## 7.12 Arbitrary Setting of Voltage Axis Magnification/ Compression and Display Range

(Variable Function)

- The variable function allows the user to modify the waveform position and size.
- The variable screen serves for setting the lower and upper limit of the waveform display range.
- The allowable waveform display range between the upper and lower limits is 5000 times larger or smaller the currently set range. If the variable function is used, the magnification is limited to 1000 times.
- The variable function can be set to ON or OFF for each channel individually.

**NOTE**

- If the variable function is enabled, the size of a waveform on the screen does not change, even if the voltage axis range is changed.
- When the set value exceeds the allowable voltage axis range, a warning message appears following the appearance of the waveform display screen (e.g., when the measurement starts). After the warning message appears, the set value is changed so that it falls into the allowable range.

The function can also be combined with the scaling function<sup>(\*)</sup>.

This is useful when wishing to display the sensor output over the full range (full-span display).

Example

Output from sensor		After conversion
1.23 V min.	Scaling	0 [EU] min.
5.78 V max.		10 [EU] max.

The scaling function allows conversion of the voltage output by the sensor into a desired physical quantity. But unless the setting is changed as shown below, the display will continue to show the waveform of the sensor output voltage (with the voltage axis and zero position as set on the channel screen). To use the full-span display, make the following setting:

Lower limit: 0 [EU]

Upper limit: 10 [EU]

\*1: See Section 9.4.

**Method** Screen: CHANNEL 2

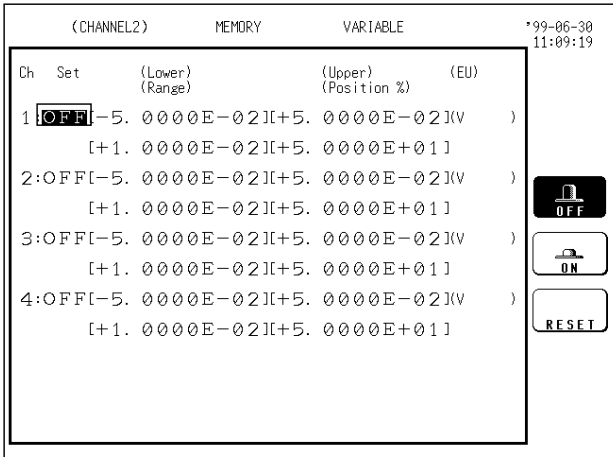

1. Press the **CHAN** key to call up the CHANNEL 2 screen.
2. Use the **CH SELECT** key to open selected channel screen.
3. To use the variable function, move the flashing cursor to the desired channel, as shown in the figure on the left.
4. Use the function keys to make the selection.



: Variable function is disabled.



: Variable function is enabled.

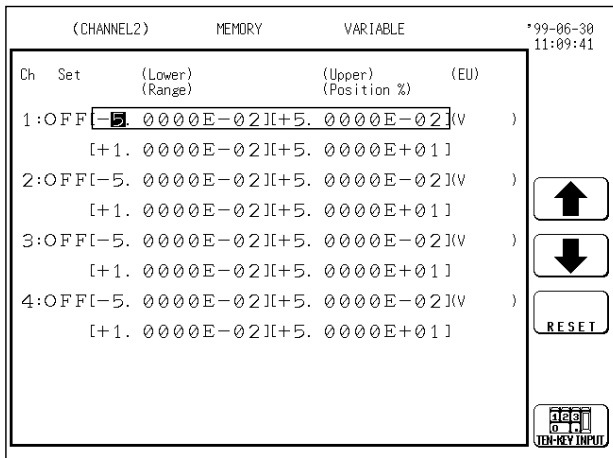

5. Move the flashing cursor to the position shown in the figure on the left, and set the lower and upper limits. The setting can be made in two ways.

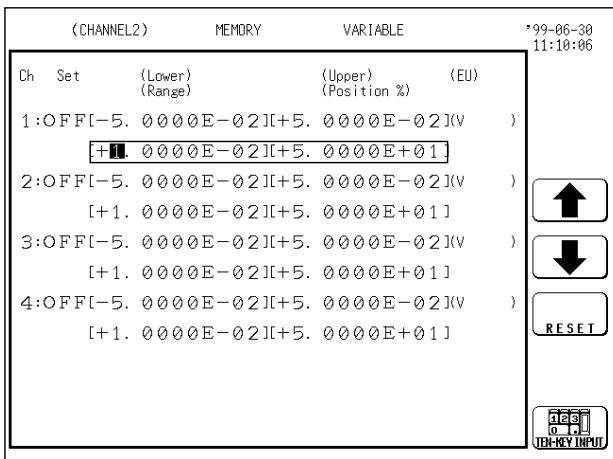

### Method 1

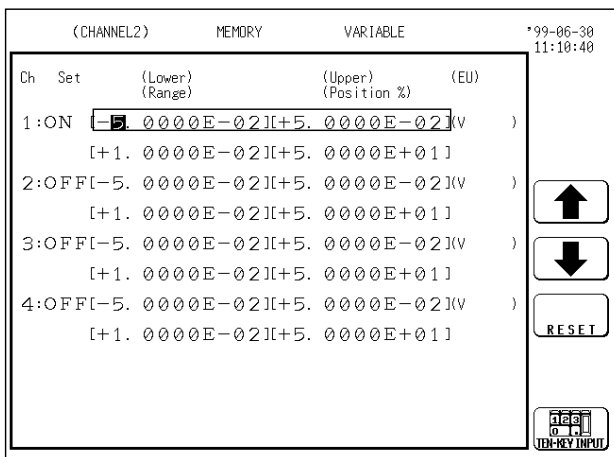

Move the flashing cursor to the respective columns and select columns individually with the JOG control or the function keys. (Move the column with the cursor keys.)

- : Value up
- : Value down
- : Reset. The reset value is determined by the voltage-axis range, zero position, and magnification ratio.
- : Enter the value using the numeric keys (Method 2).

### Method 2 (Using the numeric keys)

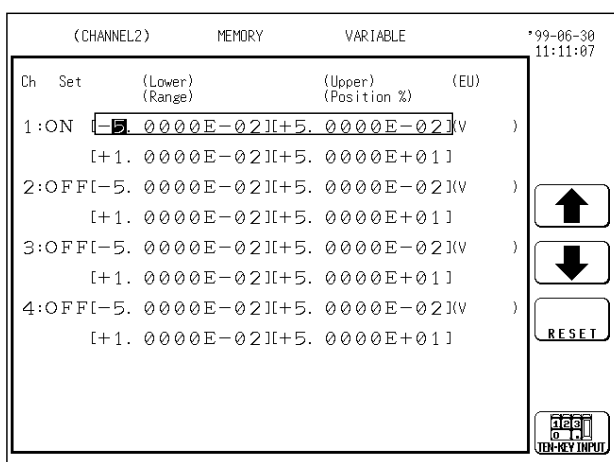

As opposed to method 1, selection is made for each column individually using the numeric keypad.

1. Move the flashing cursor to the item to set.

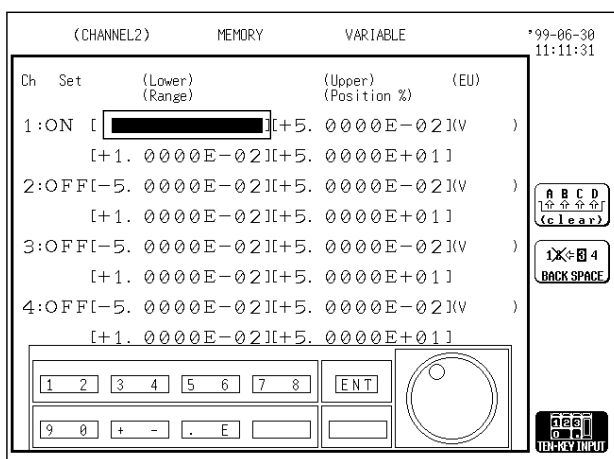

2. Select the numeric keypad using the function key. The number key layout appears.
3. Enter the parameter.

The cursor can be moved along the columns using the cursor keys. After the value is input using the numeric keys, the cursor moves to the next column.

4. Use the function keys to make the setting.

- : Reset
- : Enable the input value and escape from the ten-key input screen.

## 7.13 Input Level Monitor Function

- It is possible to set the voltage axis range and zero position while monitoring the levels of the all the input waveforms in real time.
- The display is for each of channels 1 to 8 and logic channel groups A to D.
- Only numerical values are displayed during measurement (while the LED above the **START** key is lit). A bar graph is also displayed while waiting for trigger.

**Method** Screen: Display

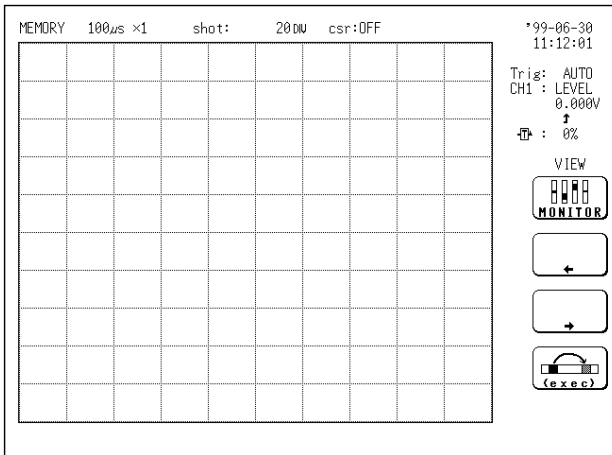

1. Press the **VIEW** key.
2. Use the function keys to select level monitor.
3. Use the **INPUT RANGE** key and the **POSITION** key to change the voltage axis range and zero position respectively.

**NOTE**

The level monitor is not displayed for the disabled channel.

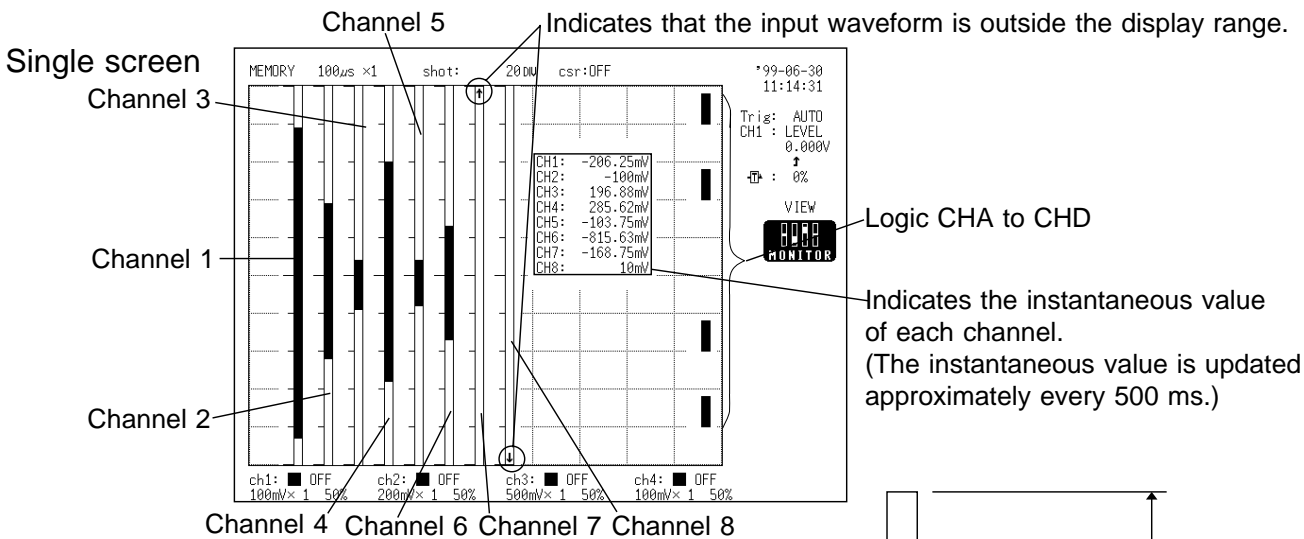

**Dual screen**

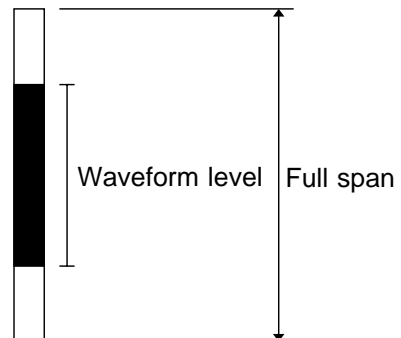
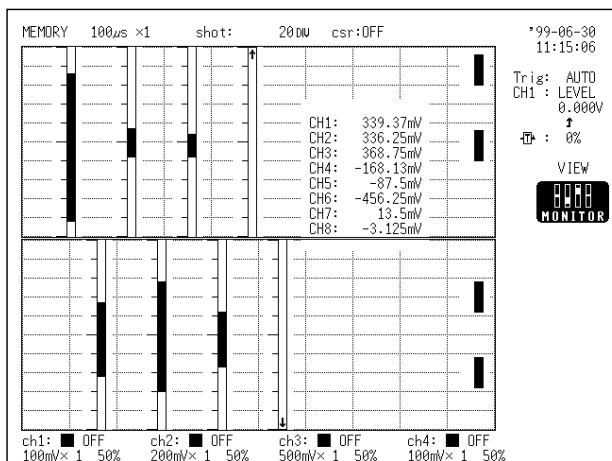

Waveform levels on channels 1 to 8 are displayed from the left.



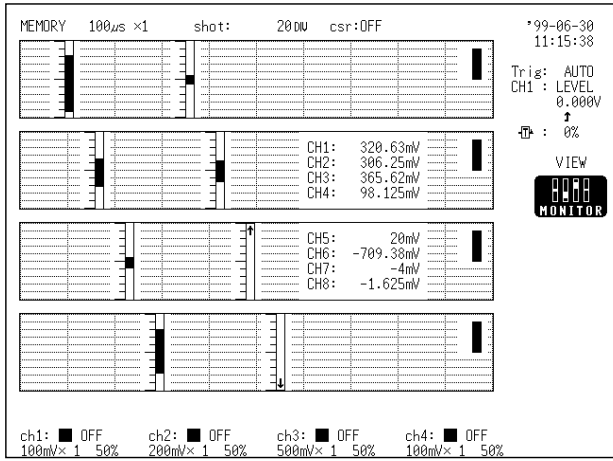

Quad screen

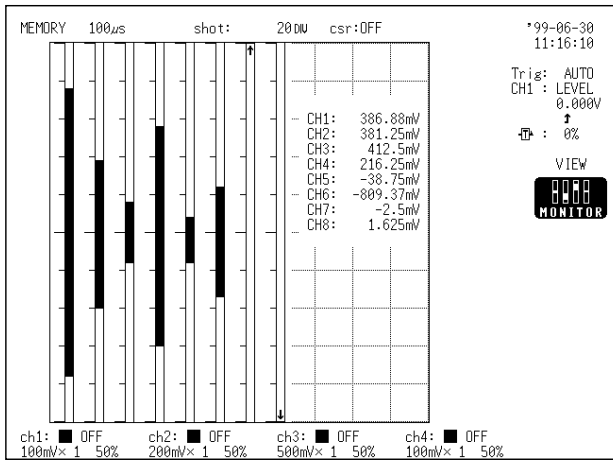

X-Y screen



Logic level display

-  : The input is stabilized at the HI level.
-  : The input varies drastically between the HI and LOW levels.
-  : The input is stabilized at the LOW level.
-  : The display is disabled.

**NOTE**

- These functions cannot be used in FFT function (advanced version).
- These functions cannot be used in RMS Recorder function during measurement.

## 7.14 Channel Guide

Views collation of input unit terminals to channels.

**Method** Screen: CHANNEL 1

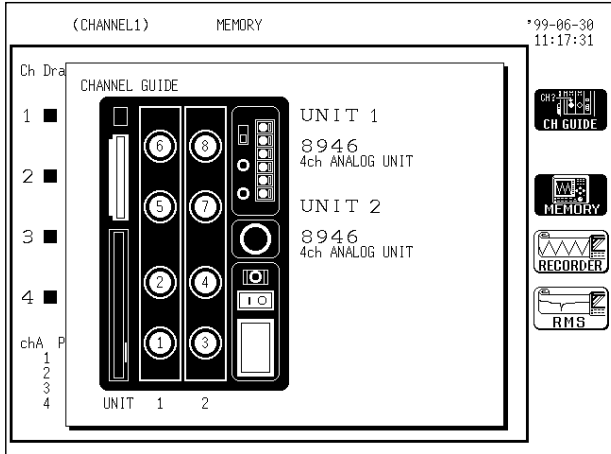

1. Call up the CHANNEL 1 screen.
2. Press  key (CH guide) to display channel guide window.
3. Use any key to close window.

### Setting Channels in 8946 4 ch ANALOG UNIT

When using 8946 4 ch ANALOG UNIT, input channels are not numbered in numeric order as 1,2,3,4. Channel number is determined by connection to units. (See below.) To verify position of channels, see Channel Guide.

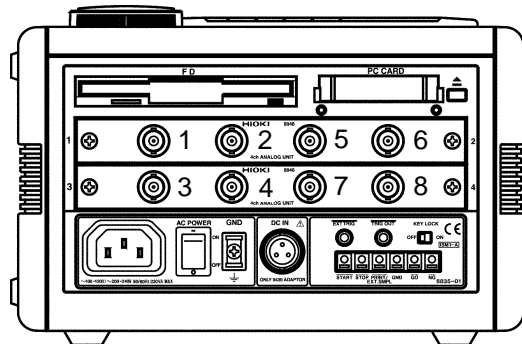

# Chapter 8

## Trigger Functions

### 8.1 Overview

- The term "trigger" refers to a signal which is used to control the timing for recording start or stop.
- The term "triggering has occurred" refers to the state when such a signal has activated recording start or stop.
- Trigger parameters for the various functions are set using the STATUS 2 screen or the DISPLAY screen.
- There are five types of signals which can be used for triggering (as trigger source).

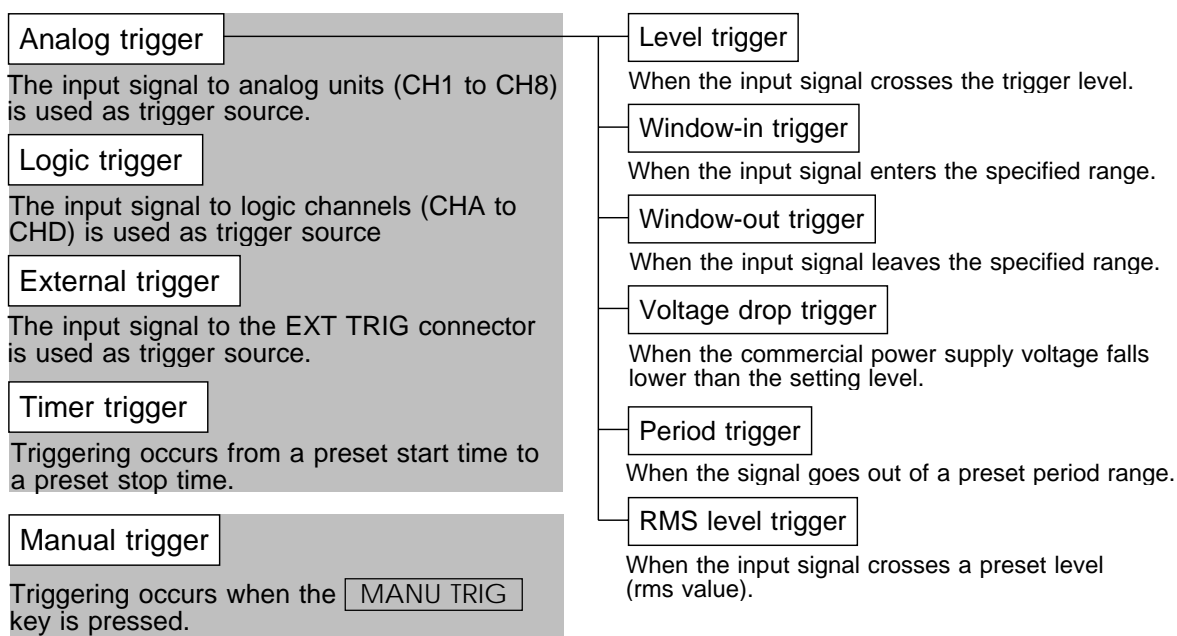

**NOTE**

The manual trigger is always activated when the **MANU TRIG** key is pressed, regardless of other trigger source settings.

**Trigger mode setting**

This determines whether the trigger is accepted repeatedly after once completing a measurement operation.

**Pre-trigger setting**

The pre-trigger setting can be used to record the waveform not only after but also before triggering has occurred (memory recorder and RMS recorder functions).

**Trigger timing setting**

The trigger timing setting refers to which of the start and stop events are controlled by the trigger (recorder function).

**Trigger marker**

A trigger marker (■) appears at the trigger point (the point where a trigger event occurred) on the waveform.

**NOTE**

- If the trigger settings (trigger source parameters, pre-trigger) are changed during recording, the measurement is restarted, using the new settings.
- If setting all of the trigger sources to OFF, the data is captured immediately after measurement starts (free-run operation).
- During recording, the indication *Waiting for trigger* is shown on the display until the trigger settings are met. During this interval, the level monitor is also shown.



## 8.2 Setting the Trigger Mode

- The trigger mode determines the way triggering is used to control operation of the 8835-01.
- When all trigger sources are OFF, a recording operation begins immediately (free-run operation).

**Method** Screen: STATUS 2, DISPLAY

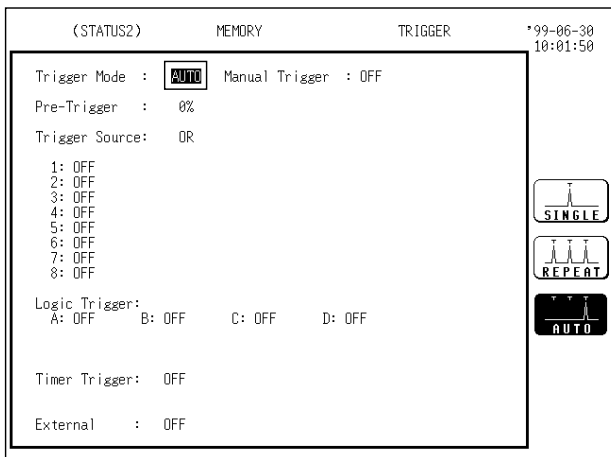

1. Call up the STATUS 2 or DISPLAY screen.
2. Move the flashing cursor to the trig mode item, as shown in the figure on the left.
3. Use the function keys to make the selection.



: SINGLE

Trigger is registered only once. After **START** key was pressed, unit starts waveform recording when triggering occurs and continues for preset recording length. Measurement then ends automatically.



: REPEAT

Trigger is registered continuously. Unit is in trigger standby condition when trigger conditions are not met. Measurement ends when **STOP** key is pressed.



: AUTO

Trigger is registered continuously. If trigger conditions are not met within 1 second, waveform recording starts automatically and continues for preset recording length. Measurement ends when **STOP** key is pressed (memory recorder function only).

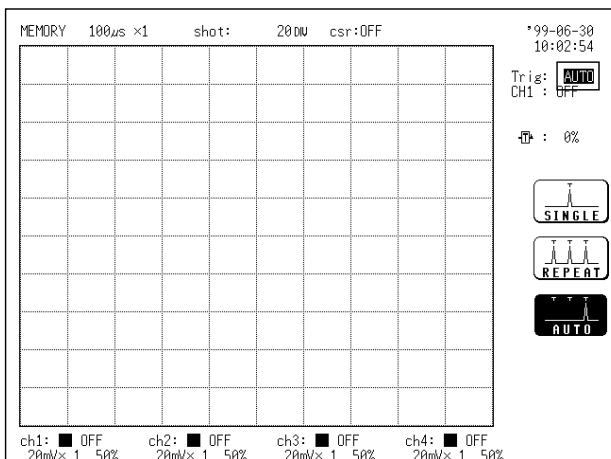

## 8.3 Setting the Pre-trigger (Memory Recorder and RMS Recorder Functions)

- The pre-trigger function serves to record the waveform not only after but also before triggering has occurred.
- In the memory recorder function, using the recording start point as 0% and the recording end point as 100%, the trigger point can be specified in percent. In the RMS recorder function, using the recording start point as 0 DIV, the trigger point can be specified in DIV (0, 5, 10 DIV).

(1) In the Memory recorder function

Example  ..... recording range (recording length)

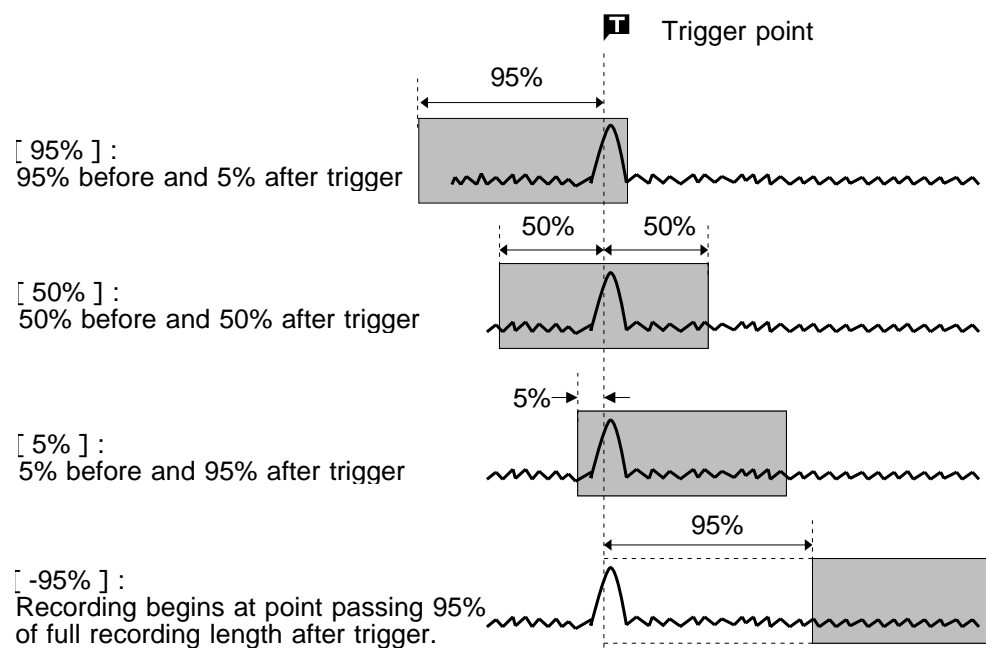

(2) In the RMS recorder function

Example  ..... recording range (recording length)

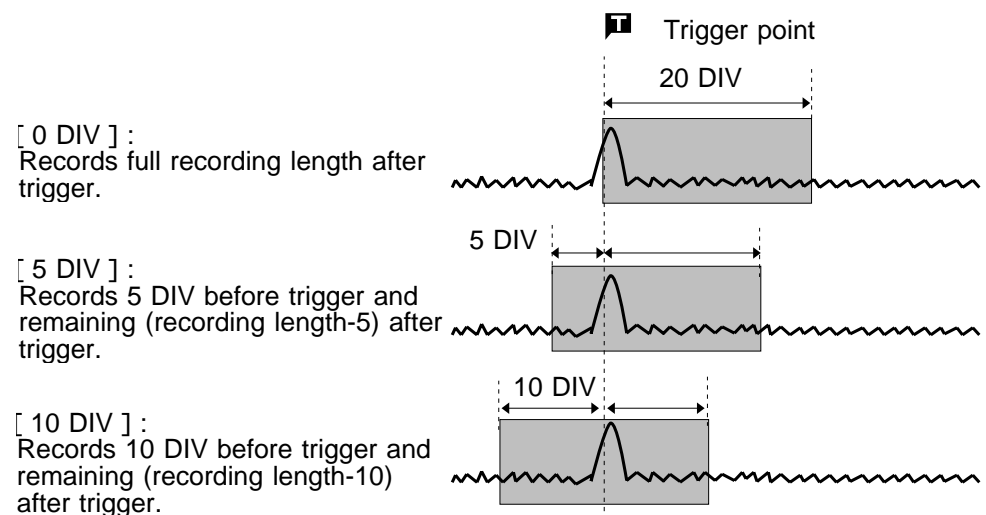

**NOTE**

- When all trigger sources are set to OFF, the pre-trigger setting is invalid.
- In the RMS recorder function, a trigger can be accepted immediately from the start time. In some cases, therefore, the pre-trigger portion of a recording may not be available.
- In the RMS recorder function, pre-trigger is invalid if the additional recording is set.

**Method** Screen: STATUS 2, DISPLAY

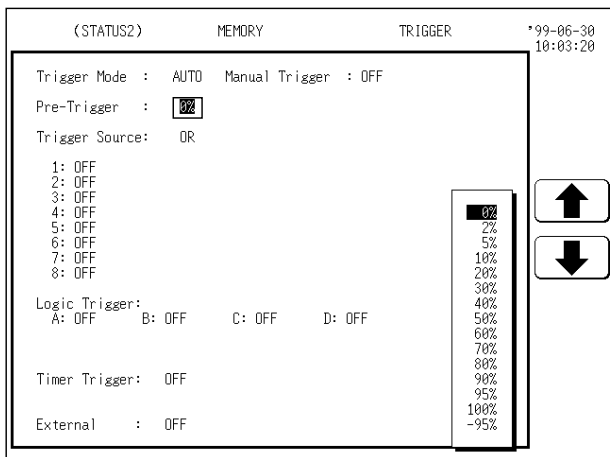
**Memory recorder function**

1. Call up the STATUS 2 or DISPLAY screen.
2. Move the flashing cursor to the pre-trig item, as shown in the figure on the left.
3. Use the JOG control or the function keys to make the selection.



: Move the cursor up in the selection window.

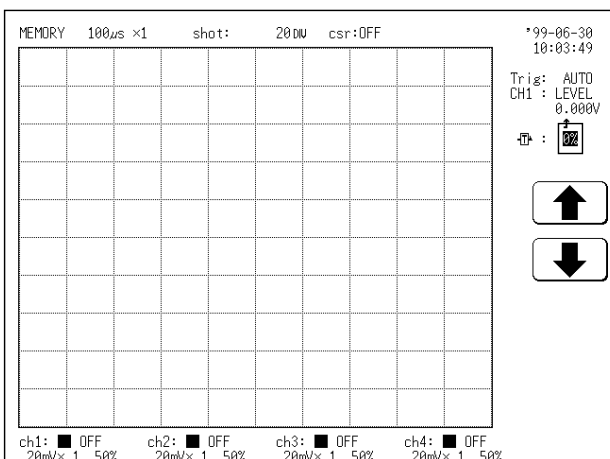

: Move the cursor down in the selection window.

**NOTE**

- When the pre-trigger is set, the trigger will not be registered for a certain period after the start of measurement. (During this interval, Pre-trigger standby is shown on the display.)
- When the trigger can be registered, the indication Waiting for trigger is shown on the display.
- On the DISPLAY screen, the selection window is not displayed.

### RMS recorder function

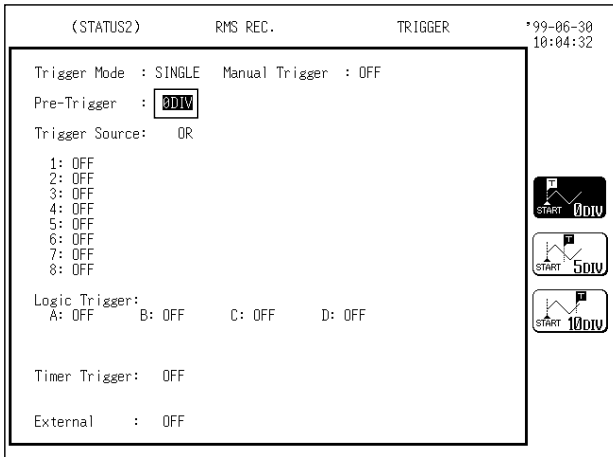

1. Call up the STATUS 2 or DISPLAY screen.
2. Move the flashing cursor to the pre-trig item, as shown in the figure on the left.
3. Use the function keys to make the selection.



: Record from the trigger.



: Record from 5 DIV before the trigger.



: Record from 10 DIV before the trigger.

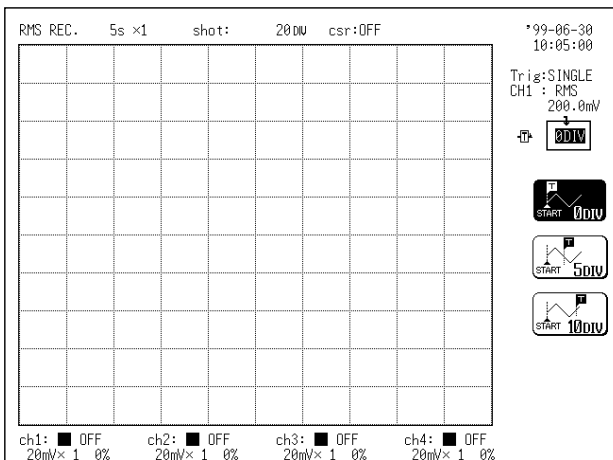

**NOTE**



In the RMS recorder function, recording starts immediately when triggering occurs, even if the pre-trigger is set.

## 8.4 Trigger Timing (Recorder Function)

- The moment the trigger occurs, the time related to the waveform being recorded can be set.
- Not only the waveform after the trigger but also the waveform before the trigger can be recorded.

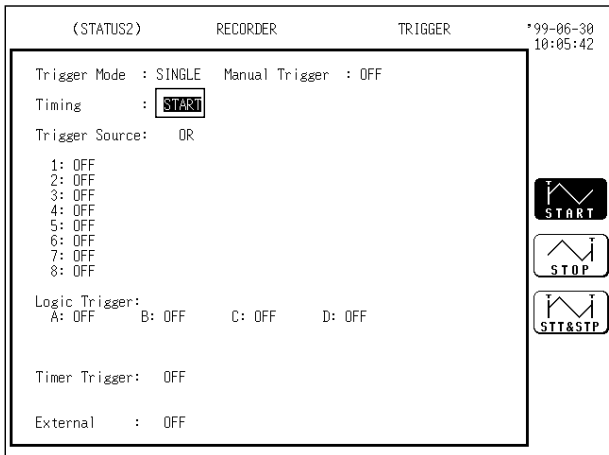
**Method** Screen: STATUS 2



1. Call up the STATUS 2 screen.
2. Move the flashing cursor to the timing item, as shown in the figure on the left.
3. Use the function keys to make the selection.
  -  : Recording starts when the trigger is applied.
  -  : Recording starts only when the **START** key is pressed, and stops when the trigger is applied.
  -  : Recording starts when the trigger is applied, and stops when the trigger is applied next.

## 8.5 Setting Trigger Source AND/OR Linking

The analog trigger, logic trigger, and timer trigger can be linked with the AND/OR logical operators.

OR: Triggering occurs when conditions for one trigger are met.

AND: Triggering occurs when conditions for all triggers are met.

**NOTE**

If the trigger source is set to AND, and the trigger source setting conditions have already been met when the **START** key is pressed, triggering does not occur. When the conditions are not met once but met subsequently, triggering occurs.

**Method** Screen: STATUS 2

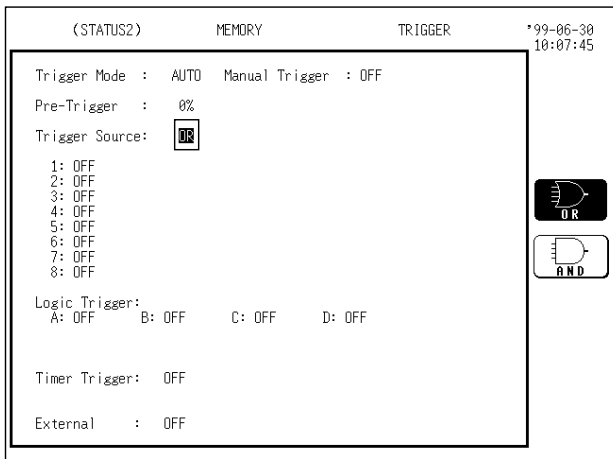

1. Press the **STATUS** key to call up the STATUS 2 screen.
2. Move the flashing cursor to the trigger source item, as shown in the figure on the left.
3. Use the function keys to select the AND or OR.



: Link trigger sources with logical operator OR.



: Link trigger sources with logical operator AND.

**Example** The figures below show the difference between the effect of AND/OR linking.

Channel	Trigger	Trigger level	Slope	Filter
CH1	Level	0.00 V	↓	OFF
CH2	Level	0.00 V	↓	OFF

AND linking

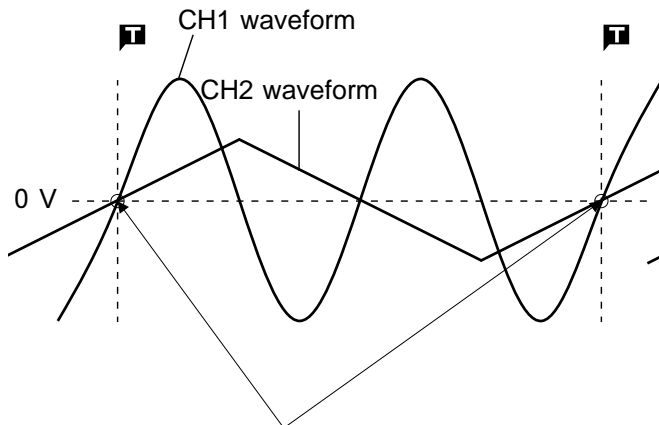

OR linking

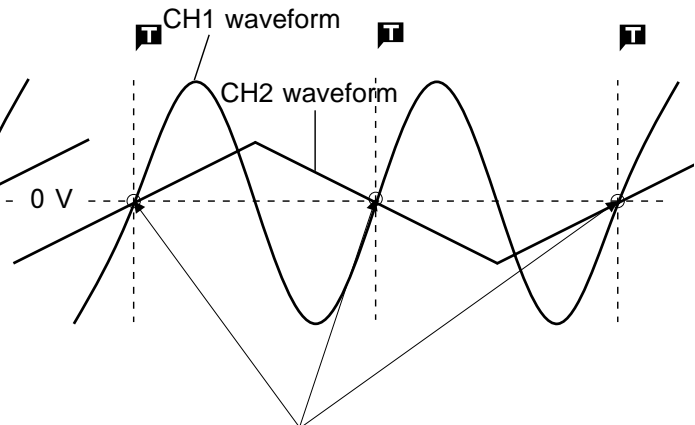

## 8.6 Using the Analog Trigger Function

- The analog signal input channels can be used as trigger source.
- The type of trigger that can be used for the various functions is limited.

Available trigger types for each function

Function Trigger	Memory recorder	Recorder	RMS recorder
Level	Yes	Yes	No
Window	Yes	Yes	No
Voltage drop	Yes	No	No
Period	Yes	Yes	No
RMS level	No	No	Yes

**Method** Screen: STATUS 2, DISPLAY

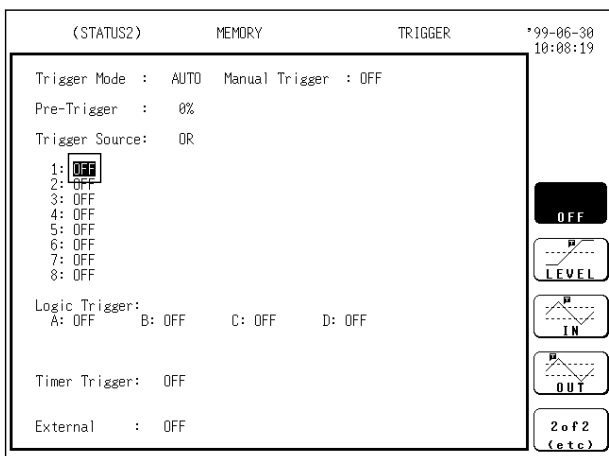

1. Call up the STATUS 2 or DISPLAY screen.
2. Move the flashing cursor to the point shown in the figure on the left.
3. Use the function keys to select the trigger type.

**Changing the analog channel on the DISPLAY screen**

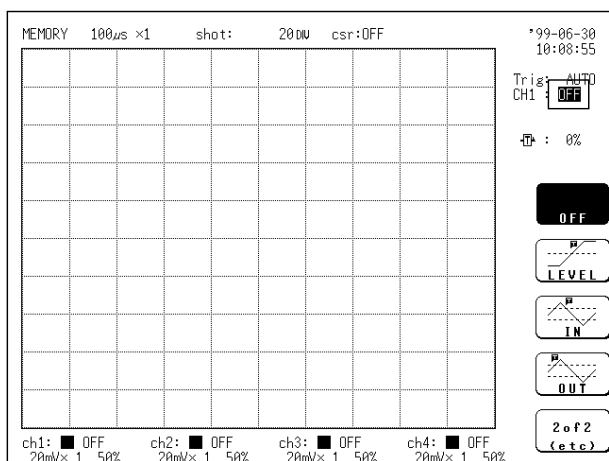

### Method

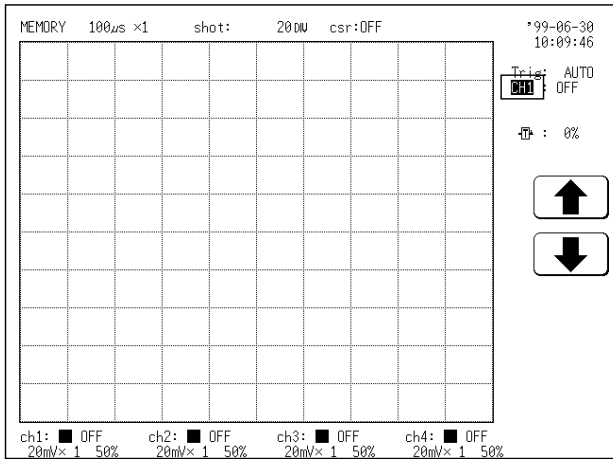

1. Move the flashing cursor to the point shown in the figure on the left.
2. Use the function keys to select the channel for which you want to set the analog trigger.

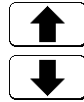

: Channel number up



: Channel number down

## 8.6.1 Level Trigger (RMS Recorder Function Excluded)

- Triggering occurs when the input signal crosses the preset trigger level (voltage) with the preset trigger slope (  $\uparrow$ ,  $\downarrow$  ).
- When a trigger filter is used, triggering occurs only within the filter width. This is useful to exclude noise.

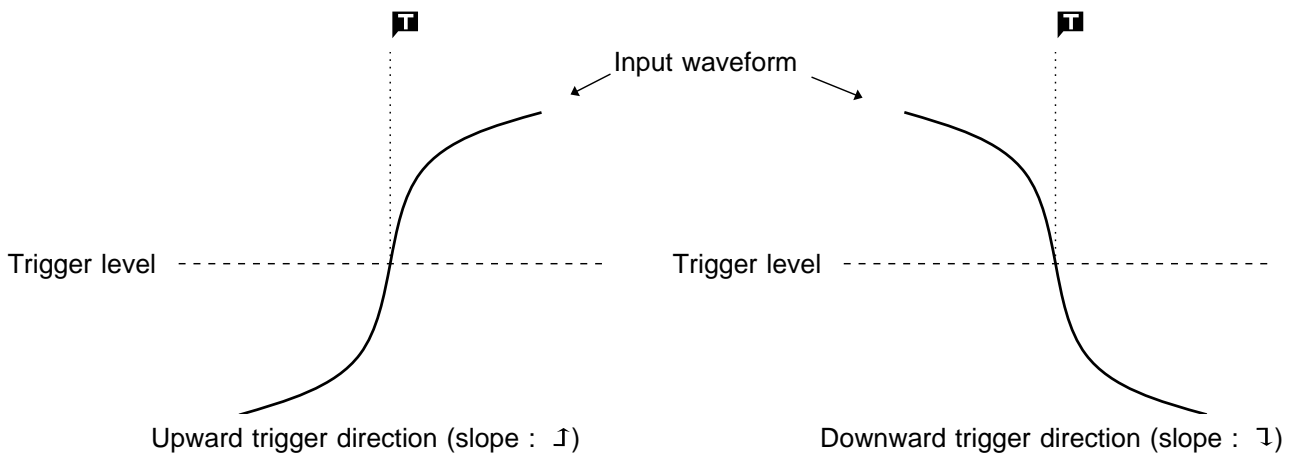



## Trigger filter

- Triggering occurs when the trigger conditions are met within the filter width.
- This is useful to prevent spurious triggering by noise.
- The filter width is specified by the number of divisions of the memory recorder function, while it is fixed to 10 ms, which is enabled and disabled using the ON/OFF keys, for the recorder function.

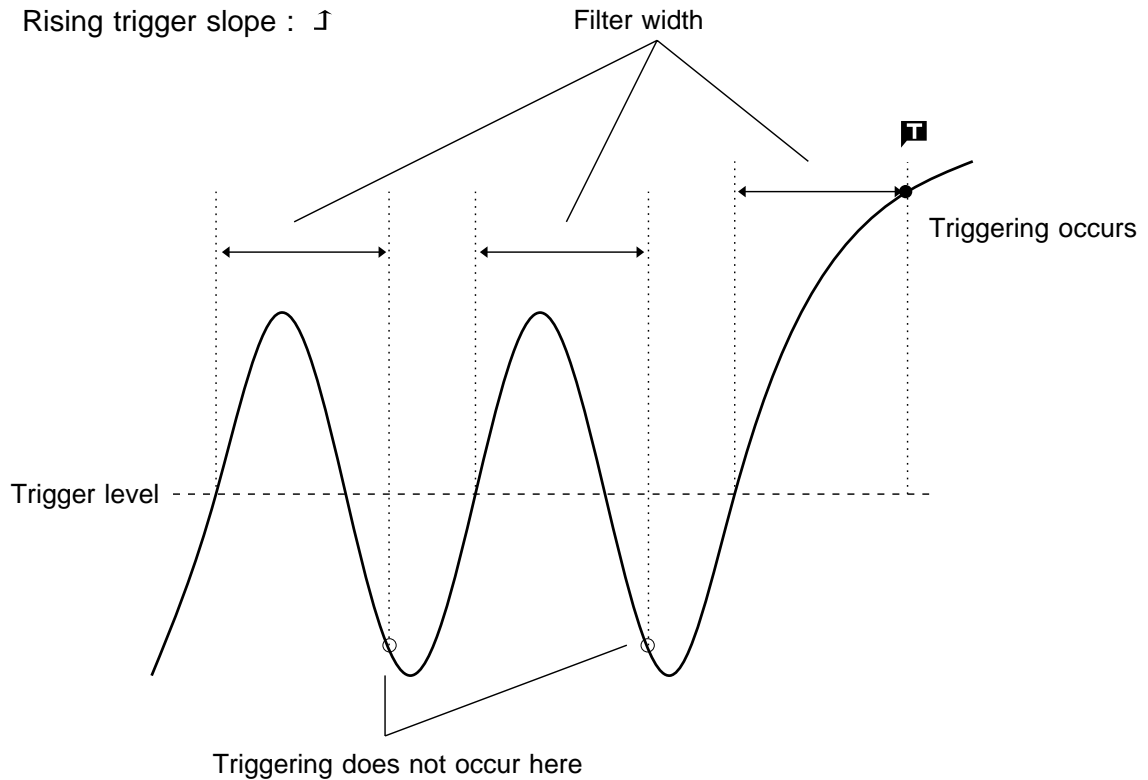

### Method Screen: STATUS 2, DISPLAY

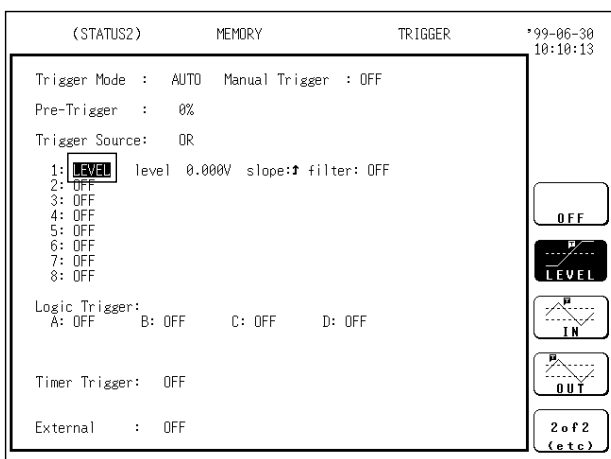

#### 1. Select the level trigger.

(1) Call up the STATUS 2 or DISPLAY screen.

(2) Move the flashing cursor to the position shown in the figure on the left.

(3) Use the function keys to select level trigger.

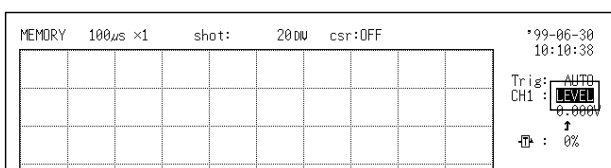

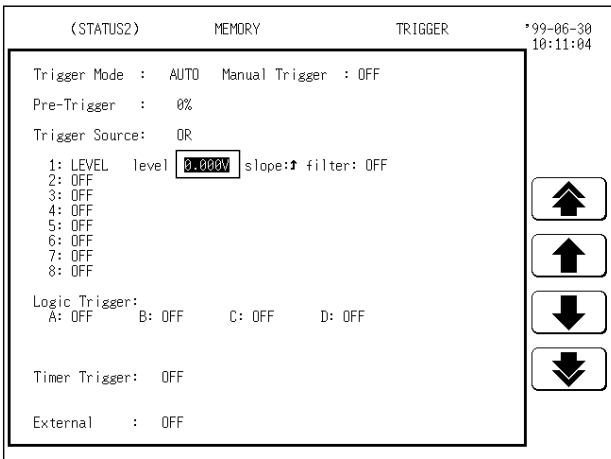

**2. Set the trigger level.**

- (1) Move the flashing cursor to the position shown in the figure on the left.
- (2) Use the JOG control or the function keys to make the selection.  
(On the DISPLAY screen, the setting cannot be made with the JOG control.)

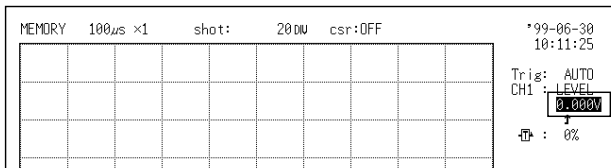
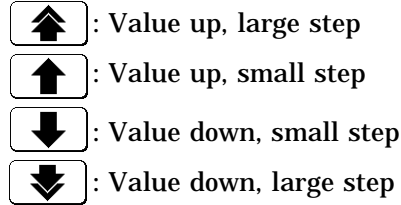

**3. Select the trigger direction (slope).**

- (1) Move the flashing cursor to the position shown in the figure on the left.
- (2) Use the function keys to make the selection.

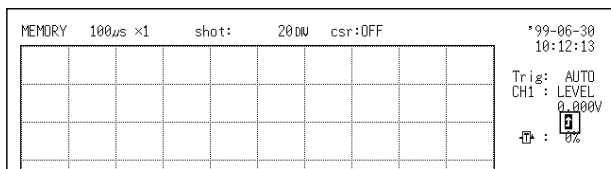
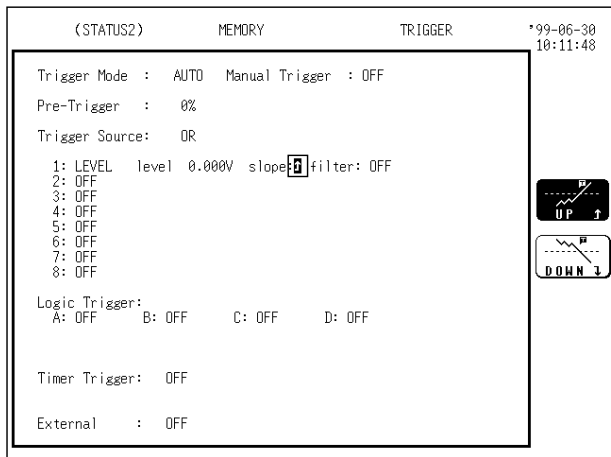
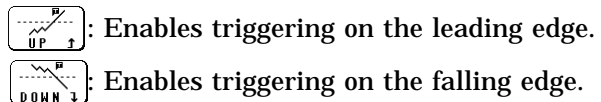

**4. Set the trigger filter**

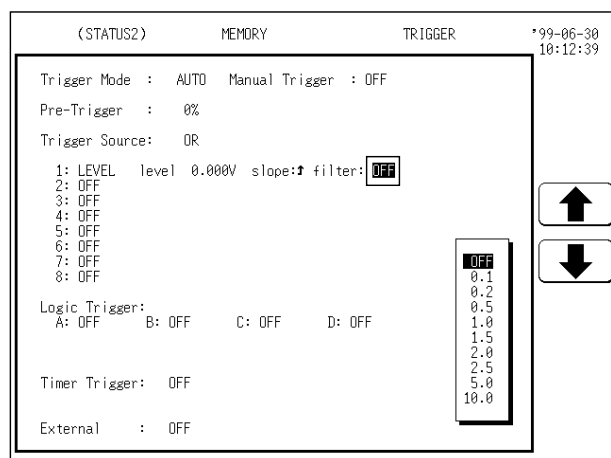

This setting cannot be made from the display screen.

- (1) Press the **STATUS** key to call up the STATUS 2 screen.
- (2) Move the flashing cursor to the position shown in the figure on the left.
- (3) Use the JOG control or the function keys to make the selection.

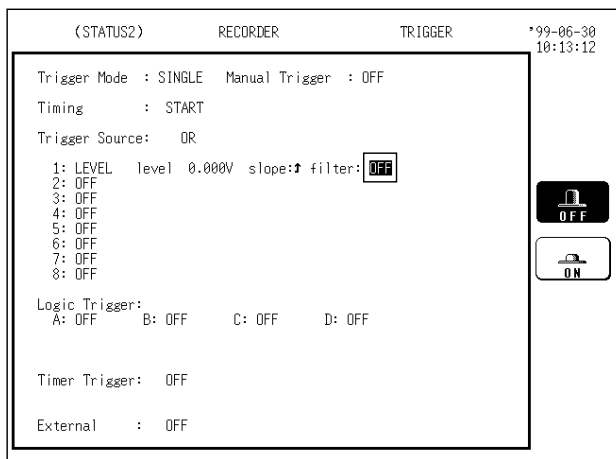



**In the recorder function**

-  : Trigger filter is disabled.
-  : Trigger filter is enabled. Filter width is 10 ms.

**Example**

To cause triggering at point A or point B with the sine wave shown below, make the following settings.

- ① Point A trigger level: 200 mV, trigger direction (slope): rising ( ⌆ )
- ② Point B trigger level: -600 mV, trigger direction (slope): falling ( ⌋ )

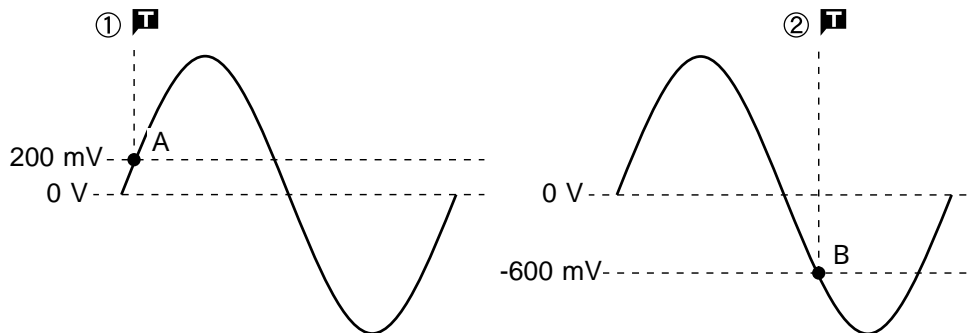

## 8.6.2 Window-In, Window-Out Trigger (RMS Recorder Function Excluded)

### Window-in trigger

Set upper limit level and lower limit level and activated when the input signal enters the range between these limits.

### Window-out trigger

Set upper limit level and lower limit level and activated when the input signal leaves this range.

Window-in-trigger

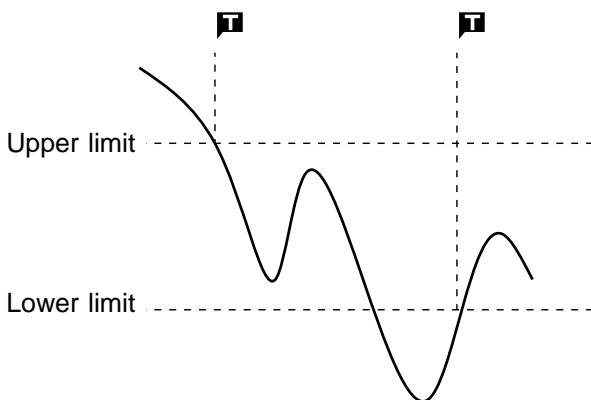

Window-out-trigger

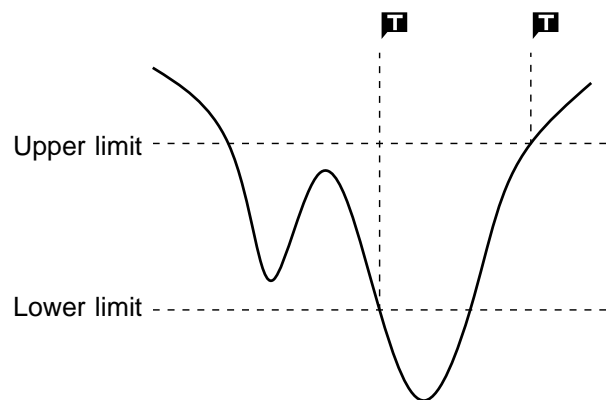

### Method Screen: STATUS 2, DISPLAY

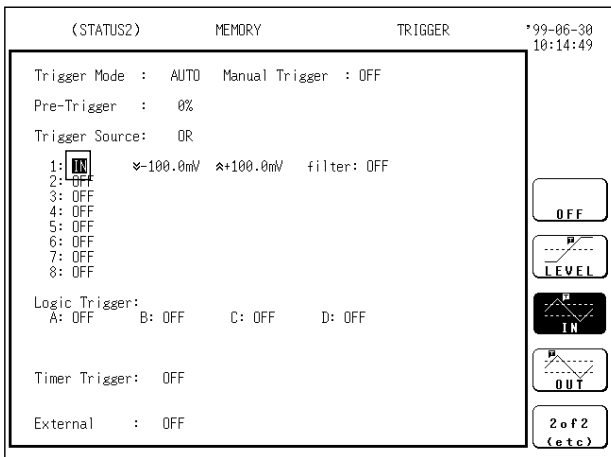

1. Select the window-in or window-out trigger.
- (1) Call up the STATUS 2 or DISPLAY screen.
- (2) Move the flashing cursor to the position shown in the figure on the left.
- (3) Use the function keys to select window-in or window-out.

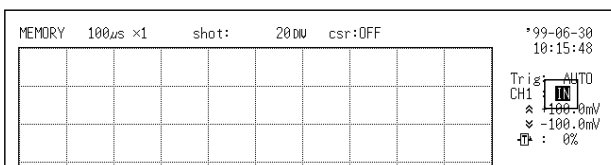

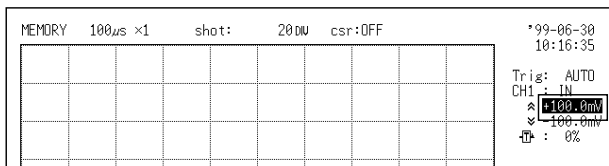
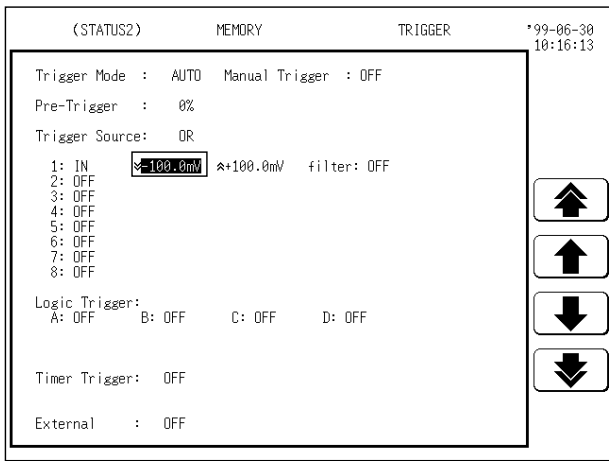
**NOTE**

The upper trigger level must not be smaller than the lower trigger level, or the lower trigger level must not be larger than the upper trigger level.

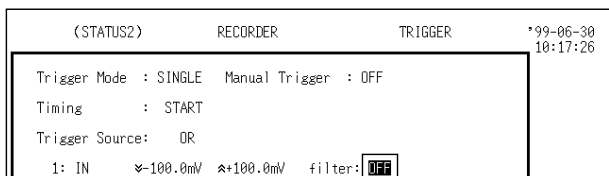
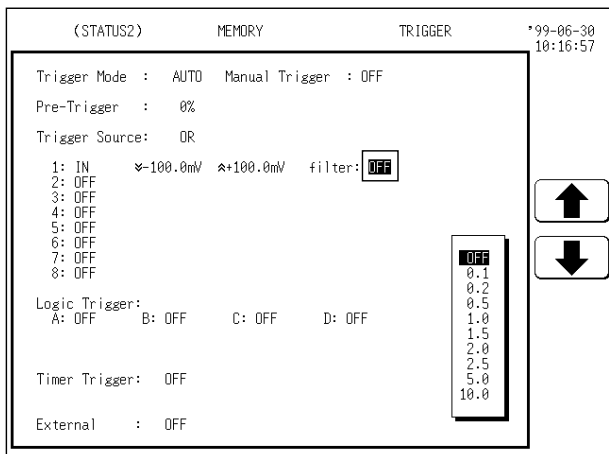

## 2. Set the lower and upper trigger levels.

(1) Move the flashing cursor to the position shown in the figure on the left, and use the function keys to set the lower trigger level.



: Value up, large step



: Value up, small step



: Value down, small step



: Value down, large step

(2) Move the flashing cursor to the position shown in the figure on the left, and use the JOG control or the function keys to set the upper trigger level.

(On the DISPLAY screen, the setting cannot be made with the JOG control.)

## 3. Set the trigger filter

- This setting cannot be made from the display screen.
- Filter width is specified using sampling points.

(1) Move the flashing cursor to the position shown in the figure on the left.

(2) Use the JOG control or the function keys to select the filter width.

In the memory recorder function

OFF: Trigger filter is disabled.

0.1 to 10.0: Trigger filter is enabled.

Filter width is specified using divisions.

In the recorder function



: Trigger filter is disabled.



: Trigger filter is enabled.  
Filter width is 10 ms.

**Example**

In order to cause triggering when the signal as shown in the figure below leaves the hatched area, the following settings are made:

Window-out trigger

Upper limit : 1 V, lower limit: -1 V

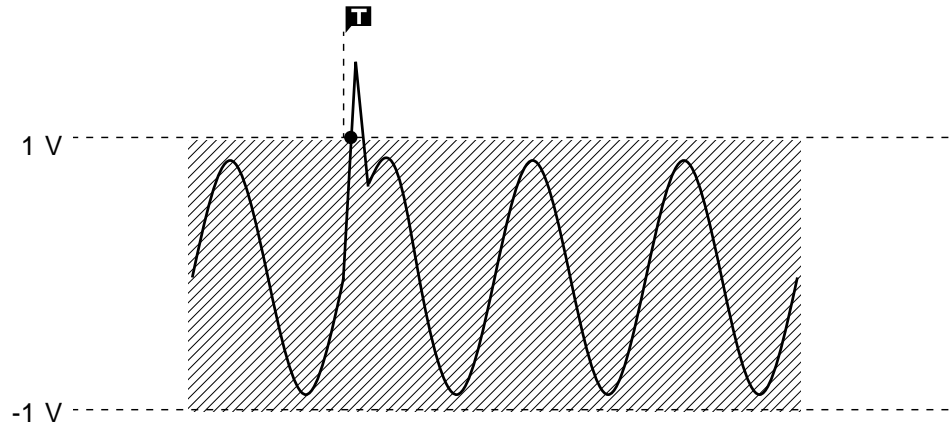

## 8.6.3 Voltage Drop Trigger (Memory Recorder Function Only)

- The 8835-01 is designed to measure commercial power supplies (50/60 Hz).
- This unit detects momentary voltage drops in commercial power supplies.
- When the peak of the voltage falls lower than the setting level, the trigger will occur.

### NOTE

- The time axis ranges that can be used are 100  $\mu$ s to 50 ms/DIV.
- If the conditions are met already when measurement is started, triggering does not occur. Triggering only occurs if the conditions are removed and then met again.

**Method** Screen: STATUS 2, DISPLAY

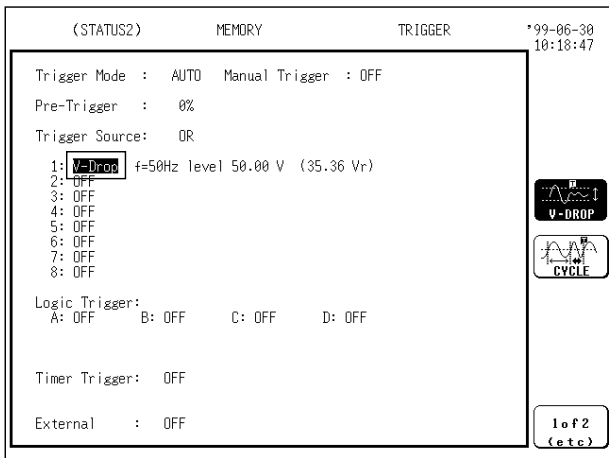

1. Select the voltage drop trigger.

- (1) Call up the STATUS 2 or DISPLAY screen.
- (2) Move the flashing cursor to the position shown in the figure on the left.
- (3) Use the function keys to select voltage drop.

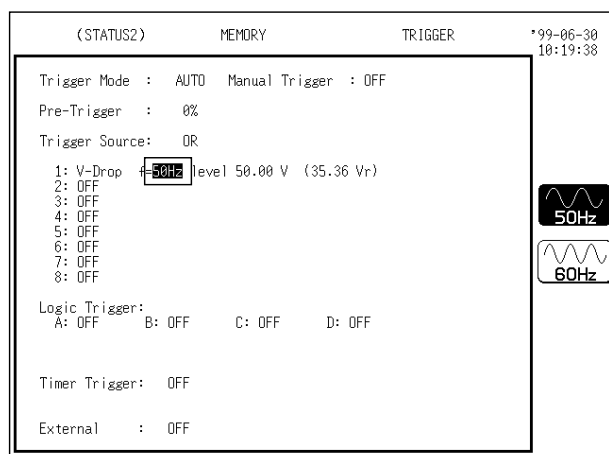
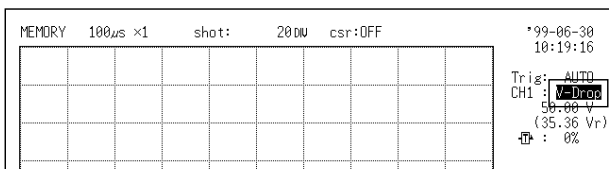

2. Select the frequency of the measuring object.

The setting cannot be made on the DISPLAY screen.

- (1) Move the flashing cursor to the position shown in the figure on the left.
- (2) Use the function keys to select the frequency.

50Hz : 50 Hz

60Hz : 60 Hz

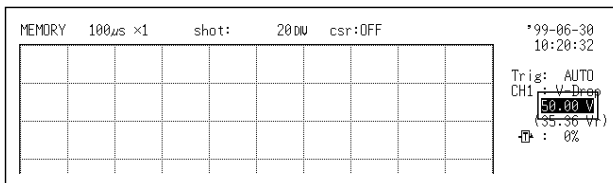
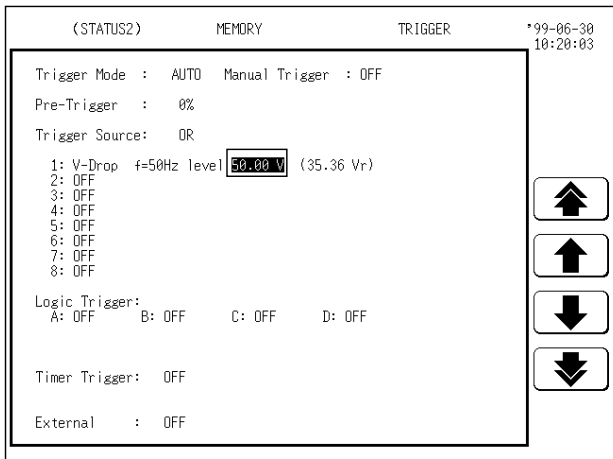

3. Set the trigger level.

The rms value as well as the trigger level are displayed

- (1) Move the flashing cursor to the position shown in the figure on the left.
- (2) Use the JOG control or the function keys to set the trigger level.  
 (On the DISPLAY screen, the setting cannot be made with the JOG control.)

- : Value up, large step
- : Value up, small step
- : Value down, small step
- : Value down, large step

**Example**

For a signal such as shown in the illustration (frequency 50 Hz), the following applies:

$$V_{max} < 1.000 \text{ V} \quad (\text{RMS} < 707.1 \text{ mVrms})$$

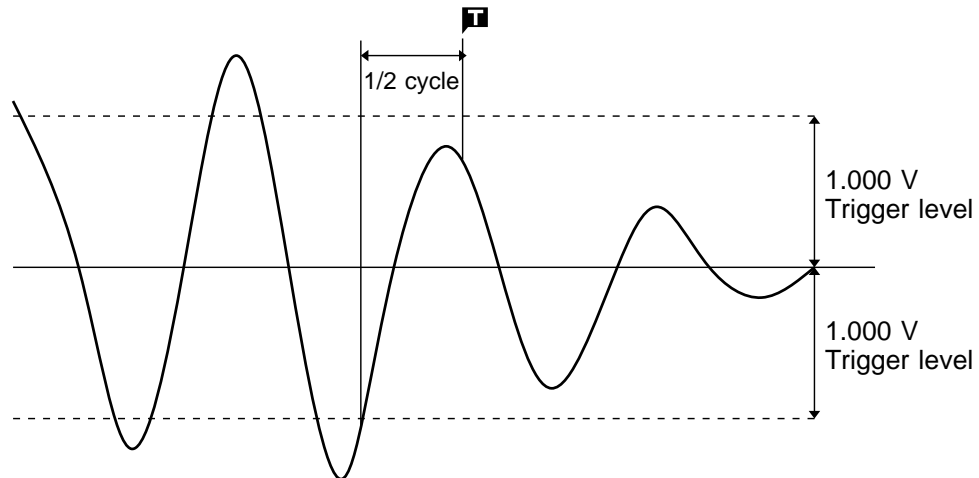

To perform trigger measurement under the above conditions, make the following setting.

$$\text{Voltage drop } f = 50 \text{ Hz Level} = 1.000 \text{ V (707.1 mVrms)}$$



## 8.6.4 Period Trigger (RMS Recorder Function Excluded)

The period trigger setting determines the period reference voltage and period range. This trigger is tripped when the measured period of the rise (or fall) of the reference voltage exceeds the period range.

### NOTE

- The setting for the period range of the period trigger changes depending on the sampling period.
  - Lower limit: Ten times the sampling period or more
  - Upper limit: 20000 times the sampling period or less
- In the recorder function, check the sampling period setting when using the period trigger.

### Method Screen: STATUS 2

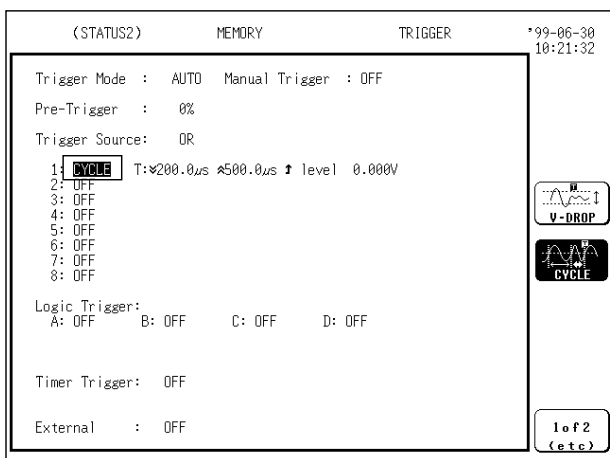

### 1. Select the period trigger.

- (1) Call up the STATUS 2 screen.
- (2) Move the flashing cursor to the position shown in the figure on the left.
- (3) Use the function keys to select cycle.

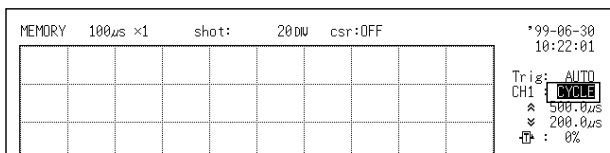

### 2. Set the period range.

- (1) Move the flashing cursor to the position shown in the figure on the left.
- (2) Use the JOG control or the function keys to set the lower limit of the period.

- ▲ : Value up, large step  
↑ : Value up, small step  
↓ : Value down, small step  
▼ : Value down, large step

- (3) Set the upper limit in the same way.

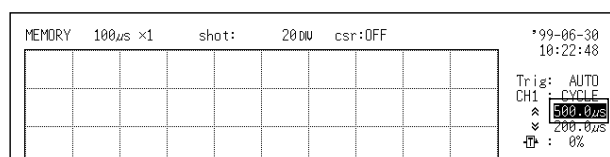
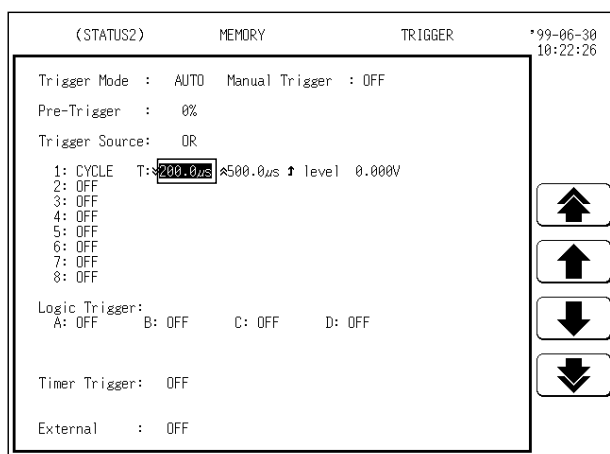

### NOTE

On the DISPLAY screen, the setting cannot be made with the JOG control.

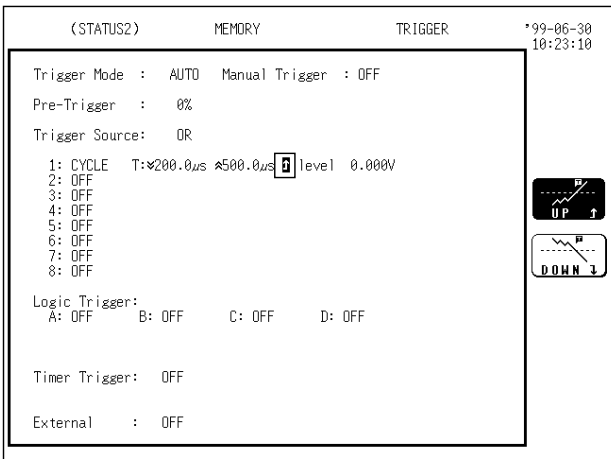

3. Select the trigger direction (slope).

The setting cannot be made on the DISPLAY screen.

(1) Move the flashing cursor to the position shown in the figure on the left.

(2) Use the function keys to select the trigger direction (slope).



: Enables triggering on the leading edge.



: Enables triggering on the falling edge.

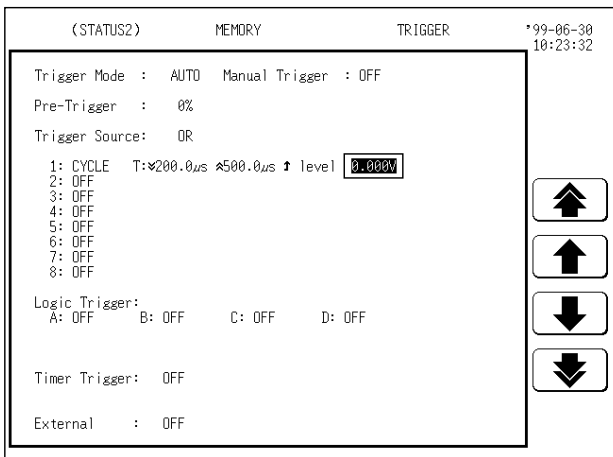

4. Set the reference voltage value.

The setting cannot be made on the DISPLAY screen.

(1) Move the flashing cursor to the position shown in the figure on the left.

(2) Use the JOG control or the function keys to make the setting.



: Value up, large step



: Value up, small step



: Value down, small step



: Value down, large step

**NOTE**

Since a trigger filter is not prepared for the period trigger, triggering may mistakenly occur due to noise (see the figure below).

To prevent such an event, use an appropriate low-pass filter.

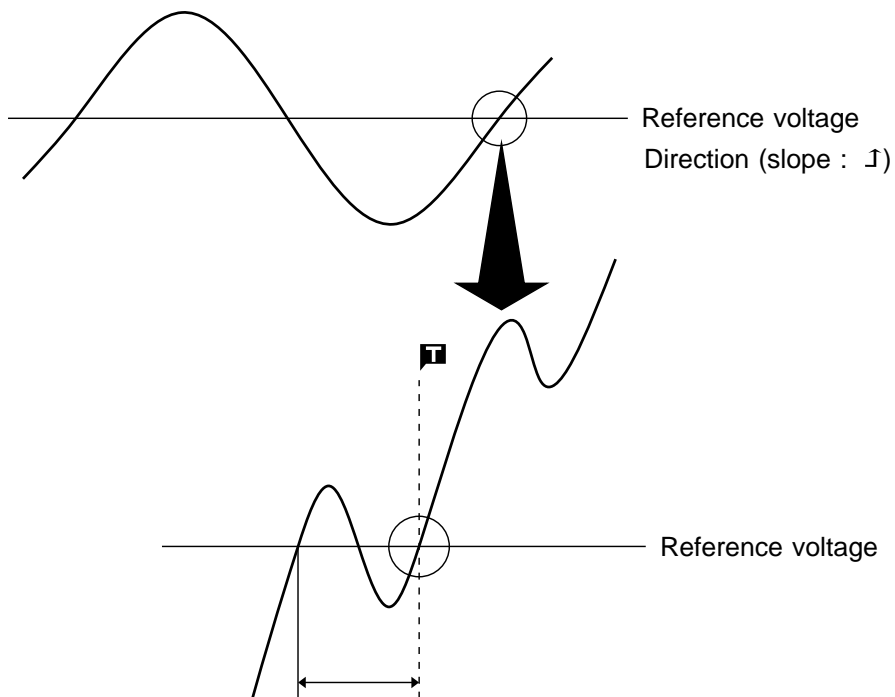

Triggering occurs, since the system judges that the period deviates from the specified range.

## Triggering position of the period trigger

The system monitors the period of the signal that crosses the set reference voltage. When the monitored period deviates from the set range, triggering occurs. The trigger position is determined by the set period range and the measurement signal period.

- (1) Signal with a period to be measured that is smaller than the lower limit of the period trigger (trigger slope:  $\uparrow$ ):

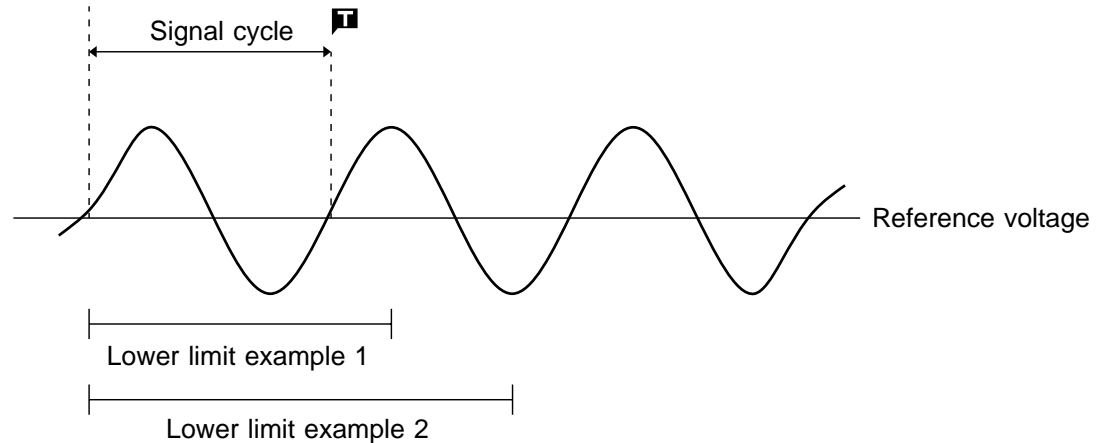

When the signal crosses the reference voltage at the set trigger slope before the lower limit of the set period range appears on the screen, the intersection is always defined as the triggering position.

- (2) Signal with a period to be measured that is larger than the upper limit of the period trigger (trigger slope:  $\uparrow$ ):

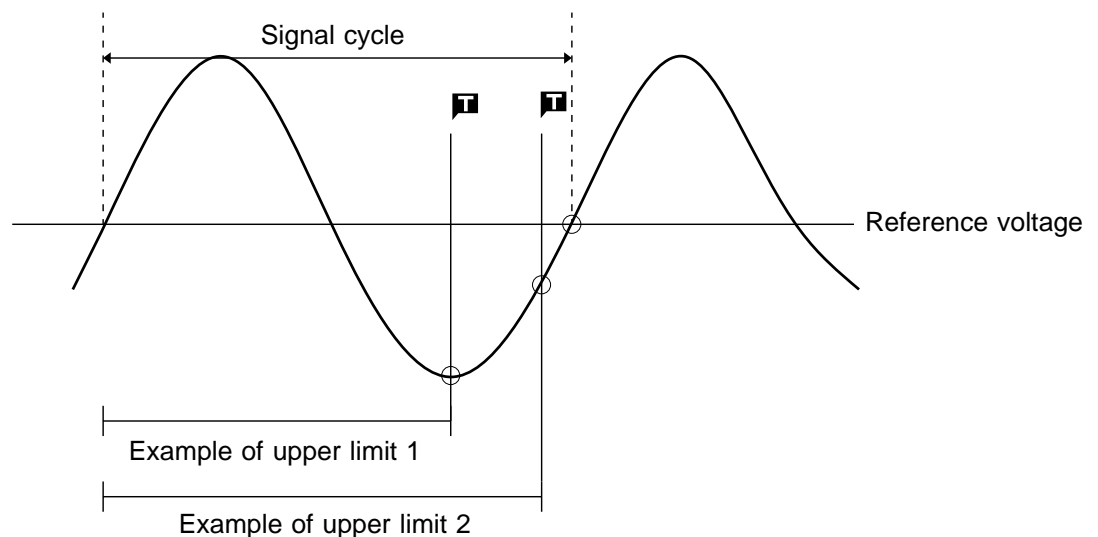

When the upper limit of the set period range appears on the screen before the signal crosses the reference voltage at the set trigger slope, the upper limit is defined as the triggering position. The triggering position is determined by the position of the upper limit in the period range, as shown in the figure above.

**Example**

In order to cause triggering when the signal as shown in the figure below leaves the period range of 0.9 to 1.1 s, the following settings are made:

Lower limit of the period: 900 ms, Upper limit of the period: 1.1 s,

Reference voltage: 0.000 V

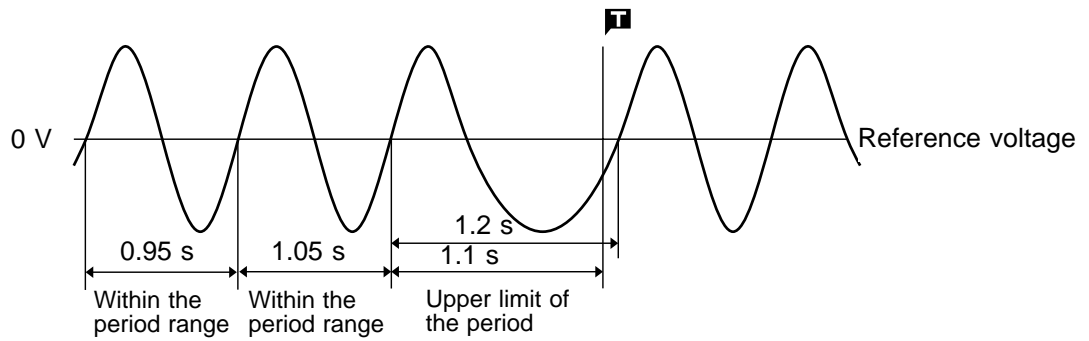

## 8.6.5 RMS Level Trigger (RMS Recorder Function Only)

- The commercial power supplies, 50/60 Hz and the DC signals can be measured.
- This trigger occurs when the input signal crosses a predetermined trigger level (rms value) in a particular direction ("slope":  $\uparrow$  or  $\downarrow$ ).

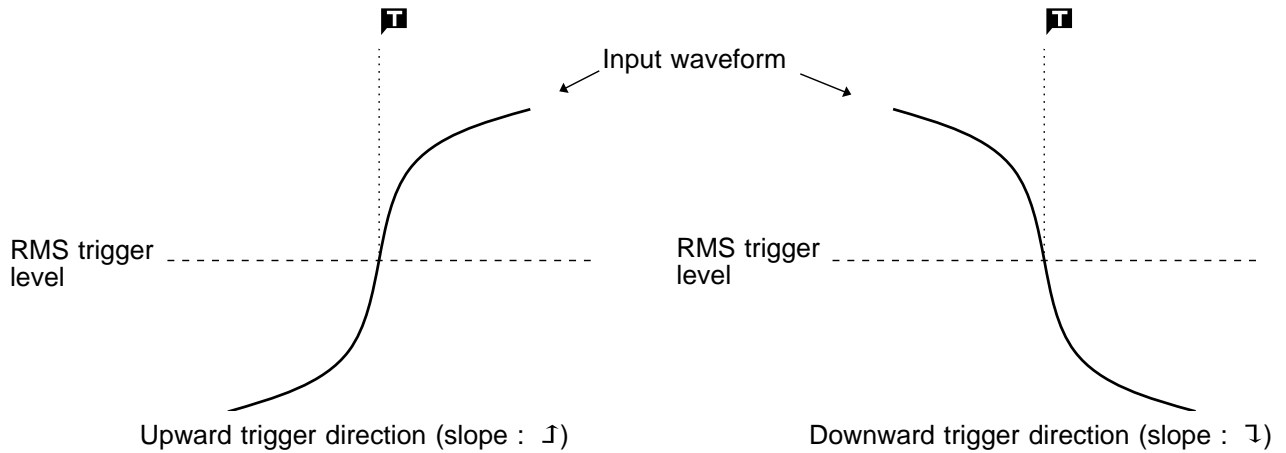

**Method** Screen: STATUS 2, DISPLAY

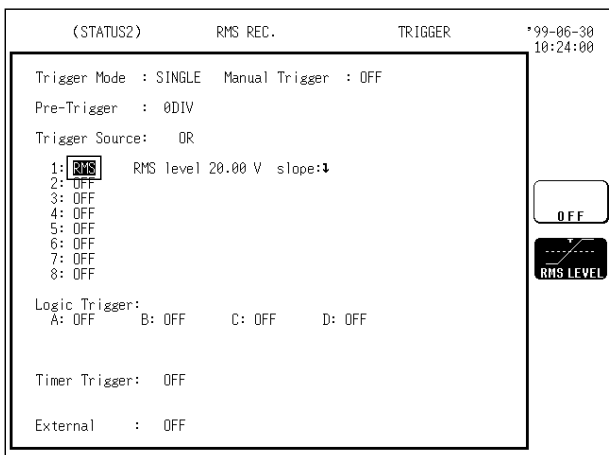

1. Select the RMS level trigger.

- (1) Call up the STATUS 2 or DISPLAY screen.
- (2) Move the flashing cursor to the position shown in the figure on the left.
- (3) Use the function keys to select RMS.

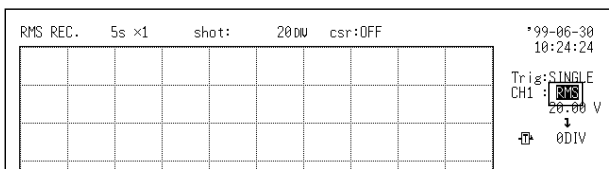

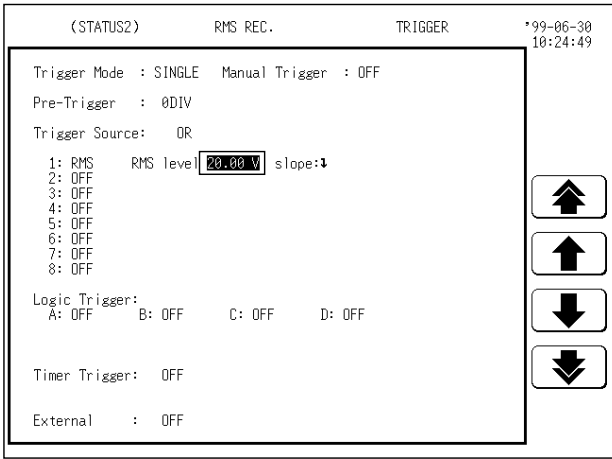

2. Set the trigger level.

(1) Move the flashing cursor to the position shown in the figure on the left.

(2) Use the JOG control or the function keys to set the trigger level.

On the DISPLAY screen, the setting cannot be made with the JOG control.

- : Value up, large step
- : Value up, small step
- : Value down, small step
- : Value down, large step

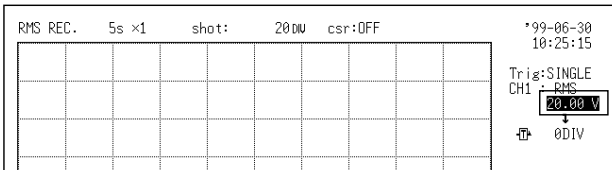

3. Select the trigger direction (slope).

(1) Move the flashing cursor to the position shown in the figure on the left.

(2) Use the function keys to select the trigger direction (slope).

- : Enables triggering on the leading edge.
- : Enables triggering on the falling edge.

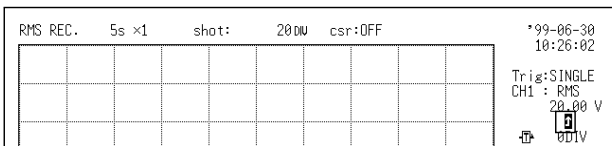
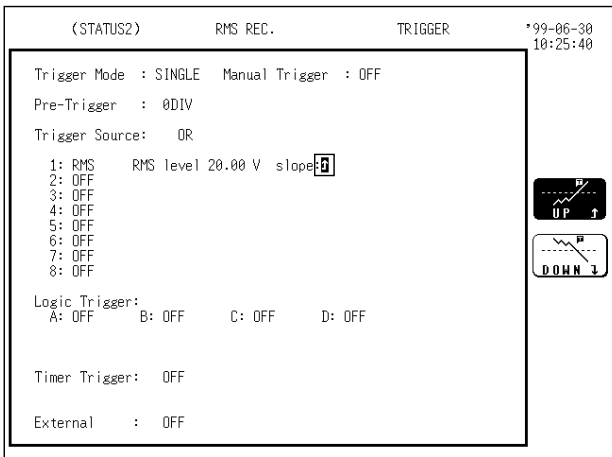

**NOTE**

- Set the frequency of the measuring object on the STATUS 1 screen.
- 'AND' cannot be set between the trigger sources using the RMS level trigger and the logic trigger. When a shift is made from "OR" to "AND," the logic trigger setting is turned OFF.
- When the trigger source is set as "AND", the trigger is engaged simultaneously with the start in the following instances.

Upward trigger direction (slope : 1)	If the input signal is higher than the trigger level.
Downward trigger direction (slope : 1)	If the input signal is lower than the trigger level.

**Example**

To cause triggering at point A with the signal as shown in the figure below, make the following settings.

RMS level: 1.000 V, trigger direction (slope): (  $\downarrow$  )

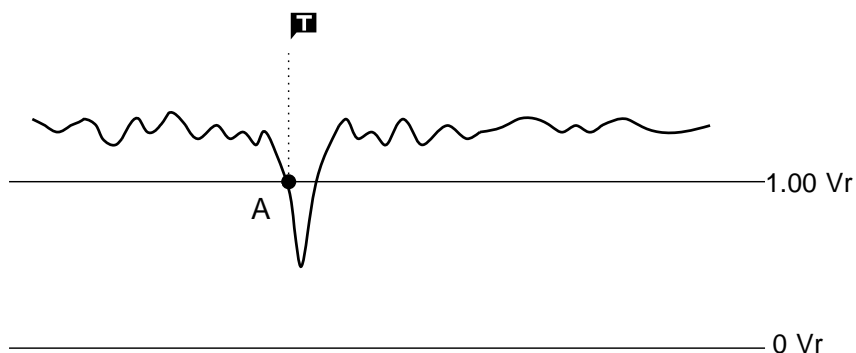

## 8.7 Using the Logic Trigger Function

- The signal of a logic channel can be used as trigger source.
- A trigger pattern and logical operator (AND/OR) are specified, and triggering occurs when the trigger conditions are met.
- A trigger filter can be specified, so that triggering occurs only when the trigger conditions are met within the filter width.

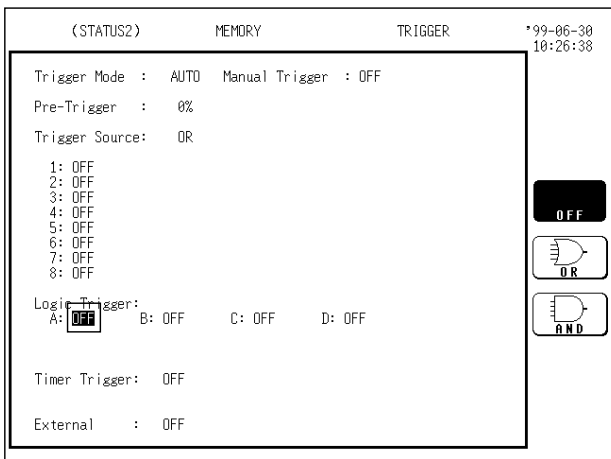

**Method** Screen: STATUS 2

(1) Set the logic trigger



1. Call up the STATUS 2 screen.
2. Move the flashing cursor to the position shown in the figure on the left.

3. Use the function keys to select ON.

-  : Logic trigger is not used.
-  : Triggering occurs if any one of the logic input signals conforms to the trigger pattern.
-  : Triggering only occurs if all of the logic input signals conforms to the trigger pattern.

**NOTE**

- If the conditions are met already when measurement is started (AND: all trigger patterns are met, OR: one trigger pattern is met), triggering does not occur at this slope. Triggering only occurs if the conditions are removed and then met again.
- 'AND' cannot be set between the trigger sources using the logic trigger and the RMS level trigger. When a shift is made from "OR" to "AND," the logic trigger setting is turned OFF.

(2) Set the trigger filter.

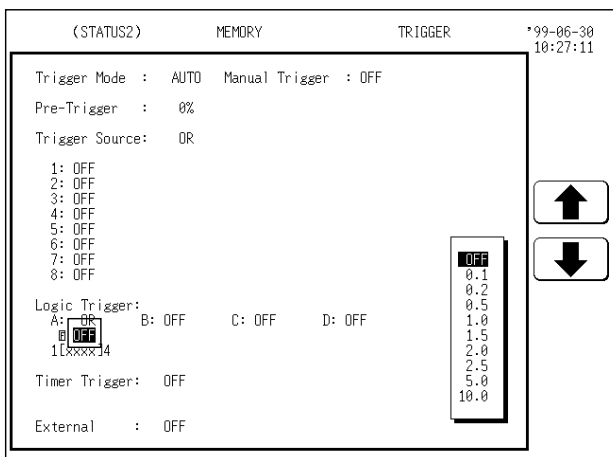

Filter width is specified using sampling points.

1. Move the flashing cursor to the position shown in the figure.
2. Use the function keys or the JOG control to make the setting.

In the memory recorder function

OFF: Trigger filter is disabled.

0.1 to 10: Trigger filter is enabled.

Filter width is specified using divisions.

In the recorder function

 : Trigger filter is disabled.

 : Trigger filter is enabled.  
Filter width is 10 ms.



(3) Set the trigger pattern

- When "CH A" is selected, the setting is for logic input CH A1 - CH A4 from left to right.
- Make the setting with the function keys.

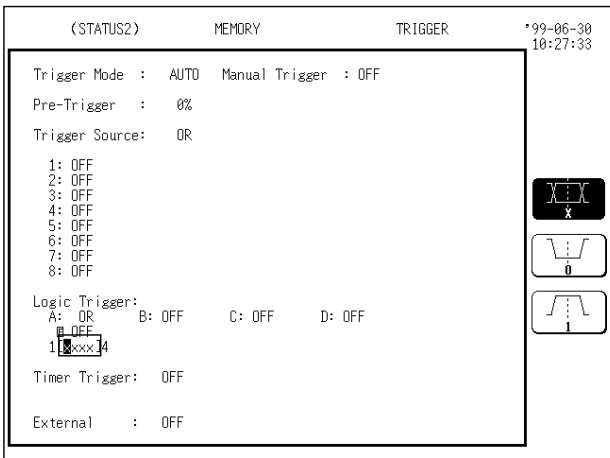

1. Move the flashing cursor to the position shown in the figure on the left.

2. Select 1 - 4 with the function key display.

- : Signal disregarded
- : Low level signal
- : High level signal

**Setting example of the logic trigger**

(1) If the trigger pattern has been set to "10 x x" with the operator OR, then triggering occurs as shown in the figure below.

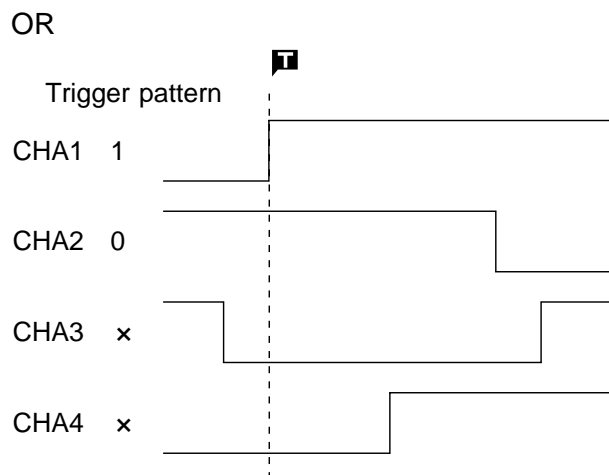

(2) If the trigger pattern has been set to "10 x x" with the operator AND, then triggering occurs as shown in the figure below.

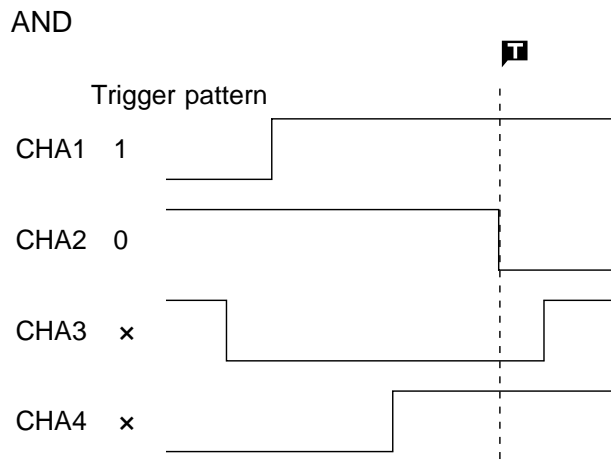

## 8.8 Using the Timer Trigger Function

- This function serves to activate recording at preset times.
- Triggering can be performed at constant intervals within a preset start time and stop time.

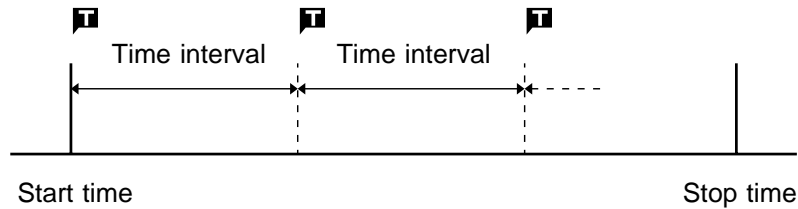

The internal trigger (analog trigger etc.) can be made active for the preset time interval only.

Set the time interval to 0.

### Method Screen: STATUS 2

#### (1) Set the timer trigger

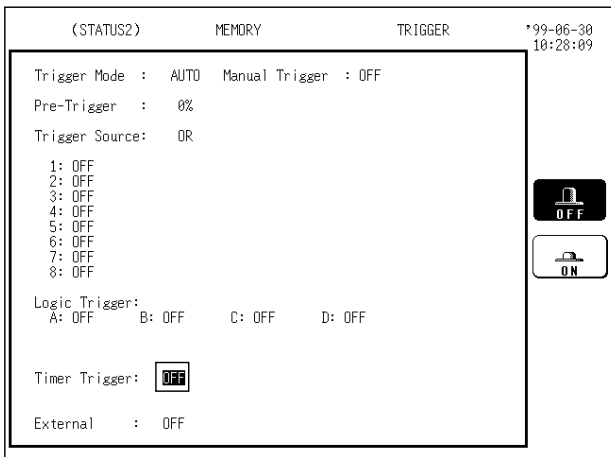

1. Press the **STATUS** key to call up the STATUS 2 screen.
2. Move the flashing cursor to the timer source item, as shown in the figure on the left.
3. Use the function keys to select ON.

#### (2) Set the start and end time

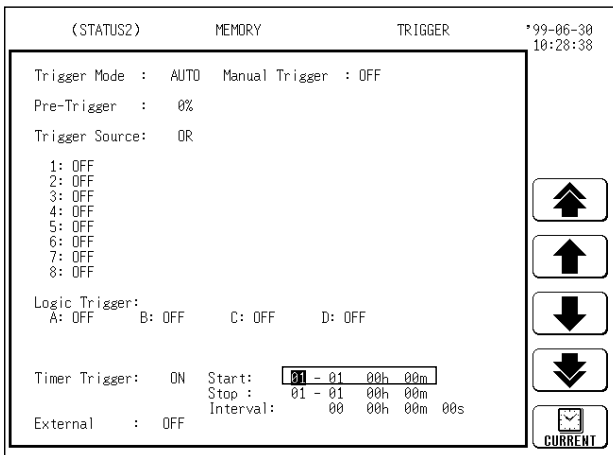

1. Move the flashing cursor to the start item.
2. Use the function keys or the JOG control to make the setting.
  - : Value up, 10-units
  - : Value up, 1-units
  - : Value down, small step
  - : Value down, 10-units
  - : Use current time as start time or end time.
3. Move the flashing cursor to the stop item.
4. Use the function keys or the JOG control to make the setting.

## (3) Set the trigger interval (day, hour, minute, second)

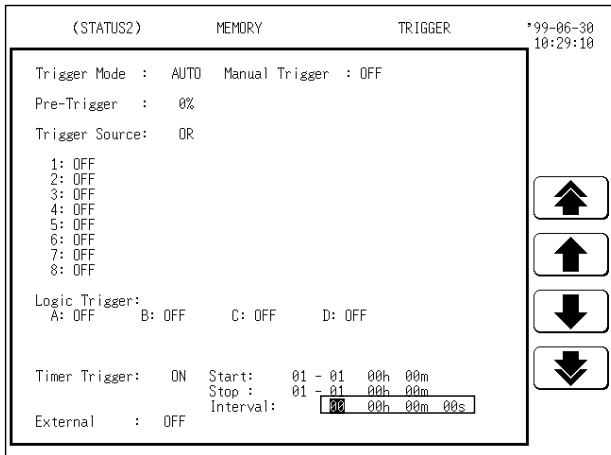

1. Move the flashing cursor to the interval item, as shown in the figure on the left.

2. Use the function keys or the JOG control to make the setting.

Available time ranges are between 0 day 0 hour 0 minute 0 second to 31 days 23 hours 59 minutes 59 seconds.

**NOTE**

- Set the start time and end time to a point after the pressing of the **START** key.
- When the trigger mode is set to "Single", only one trigger event is valid for the start time. The settings for time interval and end time are invalid (when timer trigger only is ON).
- When trigger sources have been linked with OR, all trigger sources that are ON are valid. Therefore triggering may occur even before the start time, and trigger standby and measurement may continue even after the stop time.
- When trigger sources have been linked with AND, trigger standby is enabled at the measurement start time and at each time interval, and triggering will occur when all trigger conditions other than timer trigger are met simultaneously.
- To perform recording at regular intervals, establish the following settings.
  - Trigger mode: continuous
  - Trigger source linking: AND or OR
  - Other trigger sources: all OFF

Between end of recording and standby, triggers are invalid while processing is taking place (auto save, auto print, waveform display process, calculation process) and therefore data may not be recorded at regular intervals with some measurement setting.

### Relation between timer trigger and AND/OR linking

(1) When trigger sources are set to OR

All trigger sources are valid. If other trigger sources have been set, triggering can also occur before the start time or after the stop time.

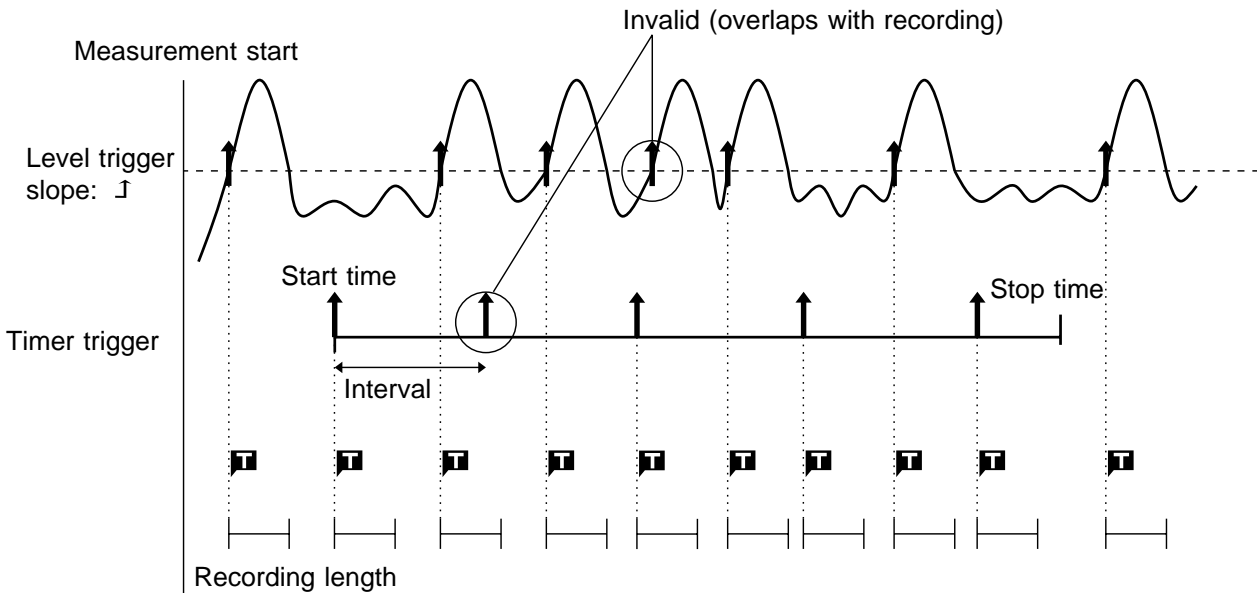

(2) When trigger sources are set to AND

- Measurement is carried out from the start time to the end time. Triggering occurs at the preset intervals if the conditions for the other trigger sources are also met at these points.
- If the interval has been set to 0s, triggering occurs at any point between the start and stop time, if the conditions for the other trigger sources are met.

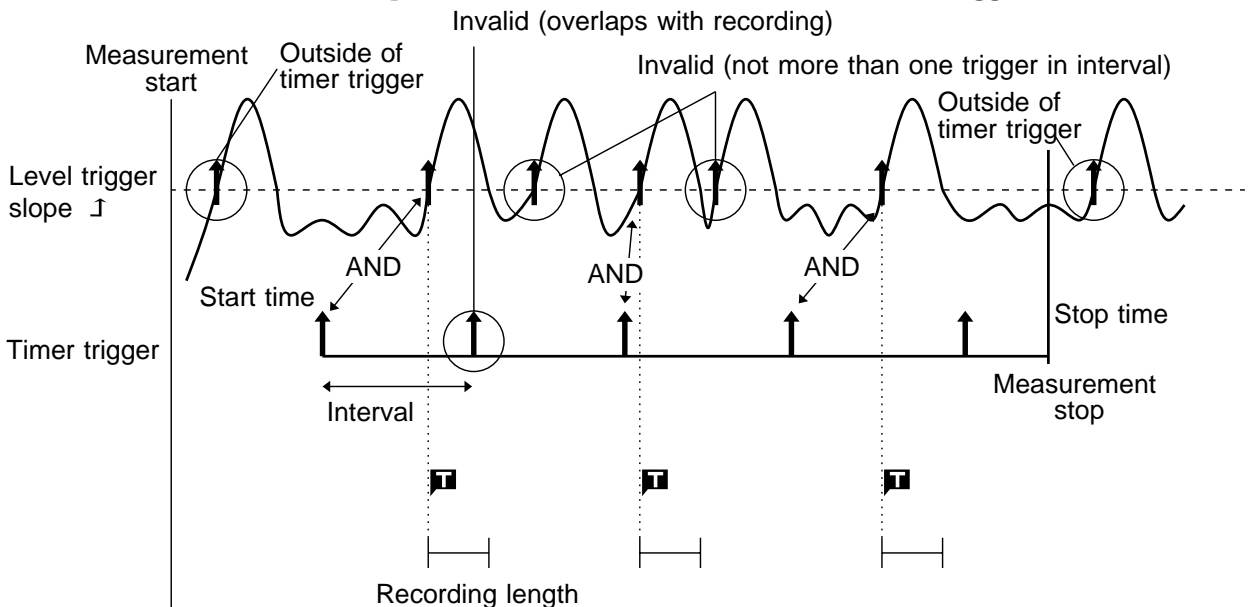

**NOTE**

- When the trigger mode has been set to **SINGLE**, only one triggering action occurs after the measurement was started.
- To perform recording at regular intervals, establish the following settings.  
 Trigger mode: continuous  
 Trigger source linking: AND or OR  
 Other trigger sources: all OFF

## 8.9 Using the External Trigger Function

- An external signal can be used as trigger source.
- The EXT TRIG connector is used for this purpose.
- The external trigger is activated by either shorting the EXT TRIG terminal or applying a falling edge signal going below 2.5 V.

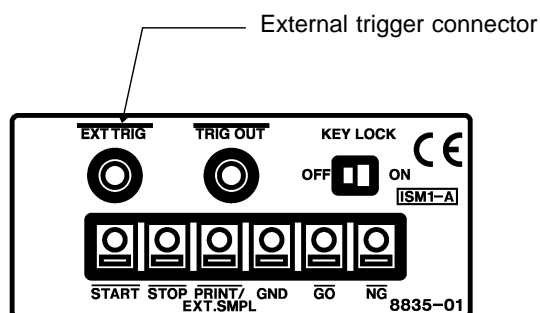

### Method Screen: STATUS 2

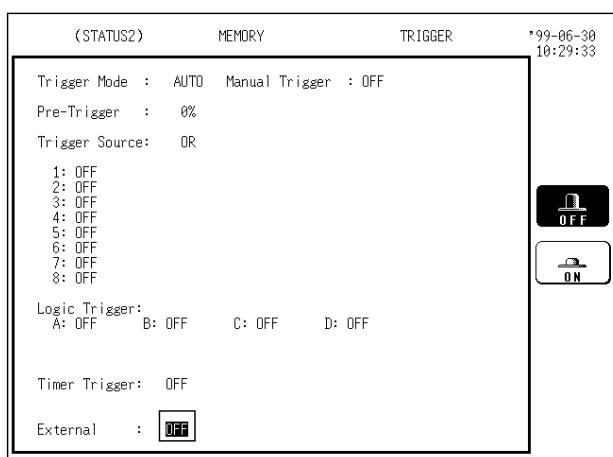

1. Press the **STATUS** key to call up the STATUS 2 screen.
2. Move the flashing cursor to the position shown in the figure on the left.
3. Use the function keys to make the selection.



: External trigger is not used.



: External trigger is used.

## 8.10 Manual Trigger

Triggering occurs when the **MANU TRIG** key is pressed.

**NOTE**

The manual trigger is always activated when the **MANU TRIG** key is pressed, regardless of other trigger source setting.

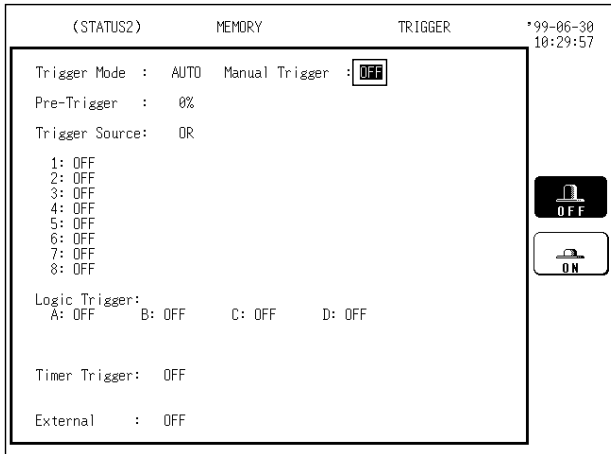

 : Manual trigger is disabled.

 : Manual trigger is enabled.

## 8.11 Trigger Output Connector

- When triggering occurs, a signal is output from the TRIG OUT connector.
- This can be used to synchronize several 8835-01 units.
- For details, see Section 12.6.

**NOTE**

Pressing the  $\leftarrow$  and  $\rightarrow$  cursor keys simultaneously to use the auto ranging function causes a trigger signal to be output. Care is therefore required when using the auto ranging function when the trigger output connector is in use. (Only a memory recorder function)

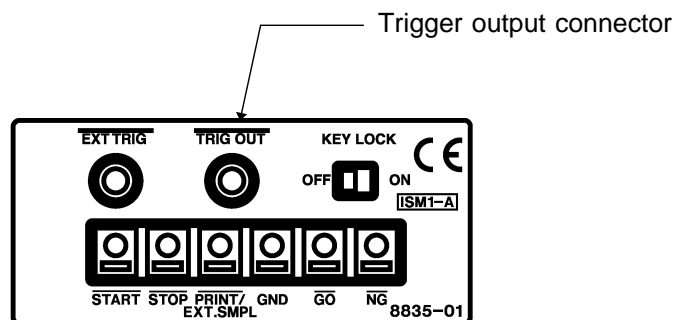

# Chapter 9

## SYSTEM Screen Settings

(For all functions)

### 9.1 Overview

The SYSTEM screen serves to set the following items which are common to all functions.

Special settings	<ul style="list-style-type: none"> <li>• Channel selection</li> <li>• Start key backup</li> <li>• Setting the grid</li> <li>• Channel marker function</li> <li>• Time display</li> <li>• List and gauge functions</li> <li>• Printer density</li> <li>• Backlight saver function</li> <li>• Setting display colors</li> <li>• Setting the beep sound</li> <li>• Language</li> <li>• PRINT/EXT.SMPL</li> </ul>
Scaling function	<ul style="list-style-type: none"> <li>• Conversion ratio scaling</li> <li>• 2-point scaling</li> </ul>
Appending comments	<ul style="list-style-type: none"> <li>• Title</li> <li>• Analog channel</li> <li>• Logic channel</li> </ul>
Interface settings	<ul style="list-style-type: none"> <li>• Setting the media</li> <li>• Setting the screen hard copy output destination</li> </ul>
Initialization	<ul style="list-style-type: none"> <li>• Setting the clock</li> <li>• Initializing waveform data</li> <li>• System reset</li> </ul>
Self check	<ul style="list-style-type: none"> <li>• ROM/RAM check</li> <li>• Printer check</li> <li>• Display check</li> <li>• Key check</li> <li>• PC card check</li> </ul>

## 9.2 How to Use the SYSTEM Screen

- Press the **SYSTEM** key or the function key to call up the SYSTEM screen.
- On the SYSTEM screen, items common to all functions are displayed.
- Press the **SYSTEM** key to switch items and then make the setting.

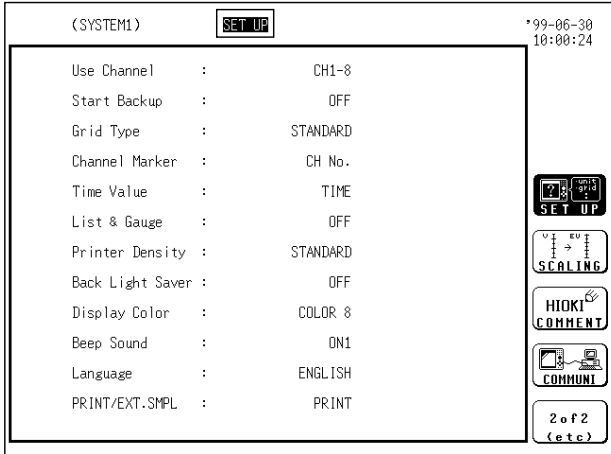

**NOTE**

If the flashing cursor is moved to the position shown in the figure above after the **SYSTEM** key is pressed to call up any of the SYSTEM screens, the other SYSTEM screens can be called up with the function key.



## 9.3 Special Function Settings [ SETUP ]

The following functions are available.

- (1) Channel selection
- (2) START key backup
- (3) Setting the grid
- (4) Channel marker function \*
- (5) Displaying the time from the trigger point \*
- (6) Setting the List and gauge functions
- (7) Printer density
- (8) Setting the backlight saver function
- (9) Setting screen colors
- (10) Setting the beep sound
- (11) Setting the language
- (12) Setting PRINT/EXT.SMPL

\*: These functions cannot be used in FFT function (advanced version).

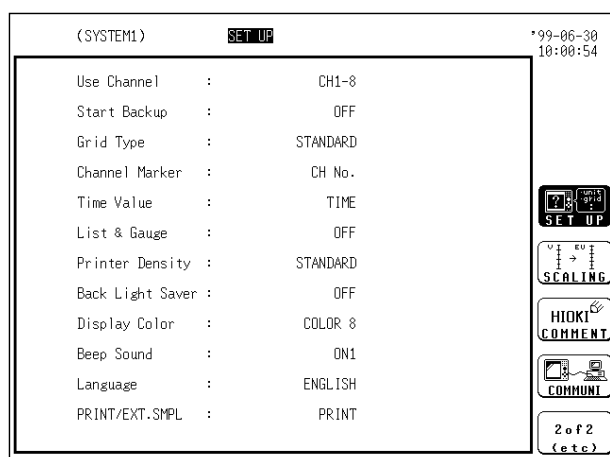

### 9.3.1 Channel Selection (Memory Recorder Function)

- Assign channels to allocate memory for measurement data.
- The setting is valid only when the memory recorder function is used.
- The smaller the number of channels in use, the longer will be settable recording length (see Section 14.3).

**Method** Screen: SYSTEM (SETUP)

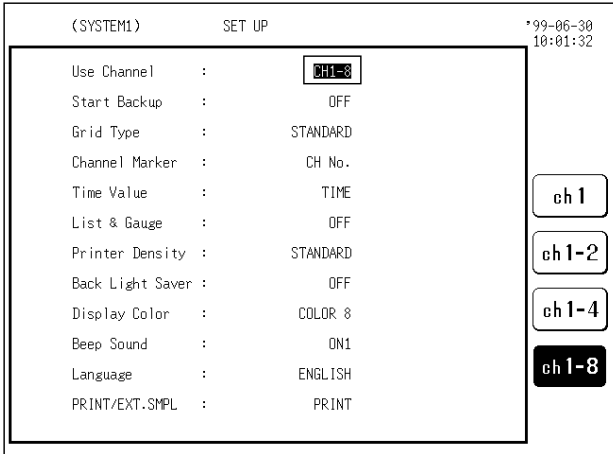

1. Press the **SYSTEM** key to call up the SET UP screen.
2. Move the flashing cursor to the position shown in the figure on the left.
3. Press the function key to make the setting.

- ch 1**: Allocates the memory for measurement data to channel 1. Measurement cannot be made on channels 2 to 8. Only logic channel A can be used.
- ch 1-2**: Allocates the memory for measurement data to channels 1 and 2. Measurement cannot be made on channels 3 to 8. Only logic channels A and B can be used.
- ch 1-4**: Allocates the memory for measurement data to 4 channels. Measurement cannot be made on channels 5 to 8. All logic channels can be used.
- ch 1-8**: Allocates the memory for measurement data to 8 channels. All logic channels can be used.

### 9.3.2 Start Key Backup

- When this function is enabled, the unit will operate as follows: If the power supply is interrupted during recording operation (while the **START** key LED is lit), and then the power supply is restored, the 8835-01 goes back into the measurement operation mode, and recording is restarted immediately.
- If the trigger function is used, the unit goes into trigger standby mode. However, this is disabled with the timer trigger.

**Method** Screen: SYSTEM 1 (SET UP)

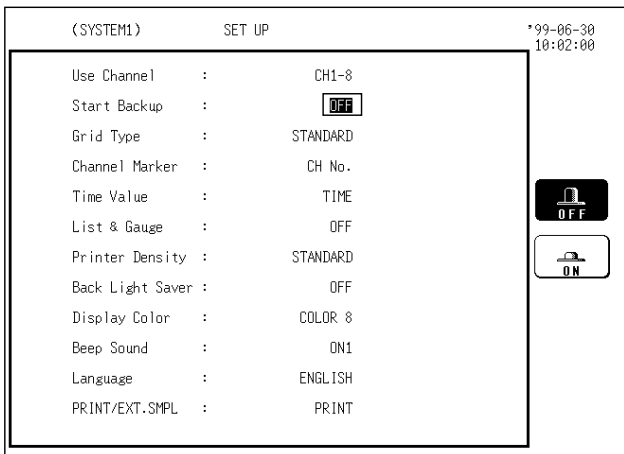

1. Press the **SYSTEM** key to call up the SET UP screen.
  2. Move the flashing cursor to the position shown in the figure on the left.
  3. Press the function key to make the setting.
- OFF**: The start key backup function is not used.
  - ON**: The start key backup function is used.

### 9.3.3 Setting the Grid

- Selects the type of grid shown on the display screen and drawn on the recording paper.
- The following five settings are available: OFF, standard, fine, standard (dark), fine (dark).
- On the waveform display screen, the standard and fine grids are defined as the standard, and the standard (dark) and fine (dark) grids are defined as the standard (dark) grids.



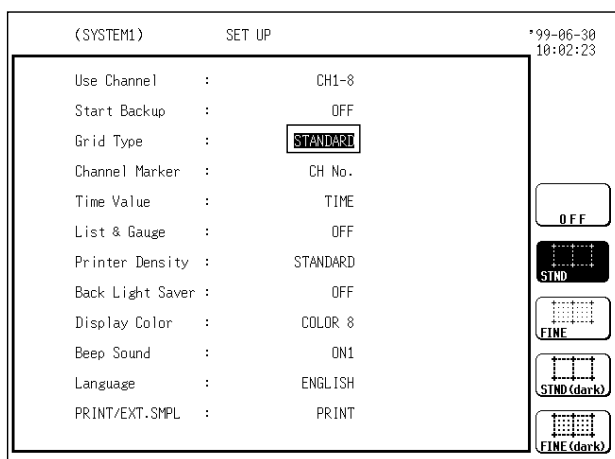

**Method** Screen: SYSTEM 1 (SET UP)



1. Press the **SYSTEM** key to call up the SET UP screen.

2. Move the flashing cursor to the position shown in the figure on the left.

3. Press the function key to make the setting.

-  : No grid on display and printout
-  : Standard grid on printout
-  : Fine grid on printout
-  : Standard (dark) grid on printout
-  : Fine (dark) grid on printout

### 9.3.4 Channel Marker Function

The channel numbers or the comments are printed together with the waveform on the recording paper (see Section 9.5).

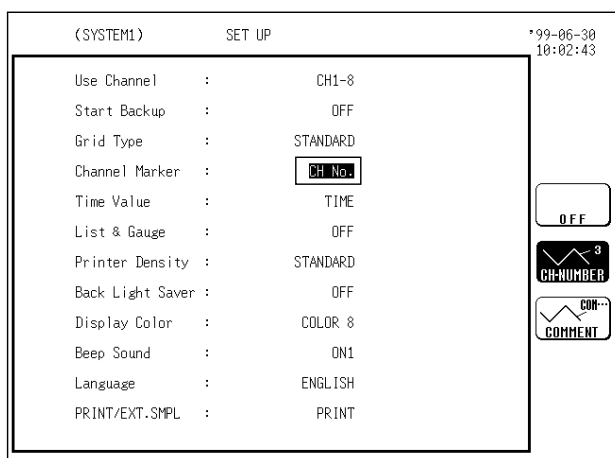

**Method** Screen: SYSTEM 1 (SET UP)



1. Press the **SYSTEM** key to call up the SET UP screen.

2. Move the flashing cursor to the position shown in the figure on the left.

3. Press the function key to make the selection.

-  : Channel numbers will not be printed for the waveform on the recording paper.
-  : Channel numbers will be printed for the waveform on the recording paper.
-  : Comments will be printed for the waveform on the recording paper.

**NOTE**

This function cannot be used in FFT function (advanced version).

### 9.3.5 Displaying the Time from the Trigger Point (Time Display)

The time from the trigger point and other information can be printed.

**Method** Screen: SYSTEM 1 (SET UP)

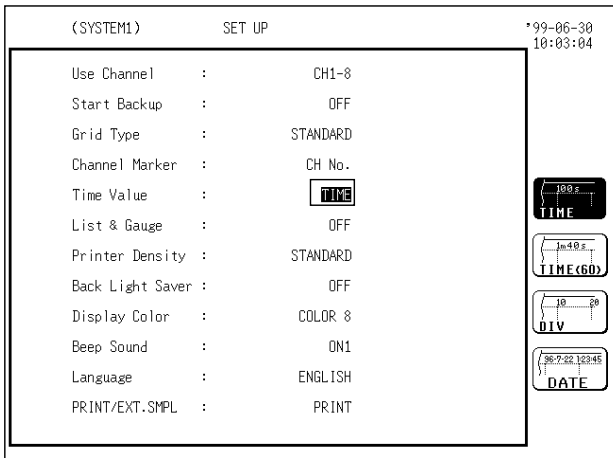

1. Press the **SYSTEM** key to call up the SET UP screen.
2. Move the flashing cursor to the position shown in the figure on the left.
3. Use the function keys to make the selection.

**100 s TIME** : Displays the time from the trigger point (unit: fixed).

**1m48 s TIME(60)** : Displays the time from the trigger point (unit: base 60).

**10 DIV** : Displays the number of DIV from trigger point.

**88-2-20 12345 DATE** : Displays the time when a waveform is captured.

**NOTE** This function cannot be used in FFT function (advanced version).

### 9.3.6 List and Gauge Functions

When a waveform is printed (except for screen hard copies), the gauge can be printed out at the beginning, and a listing can be printed out at the end.

**Method** Screen: SYSTEM 1 (SET UP)

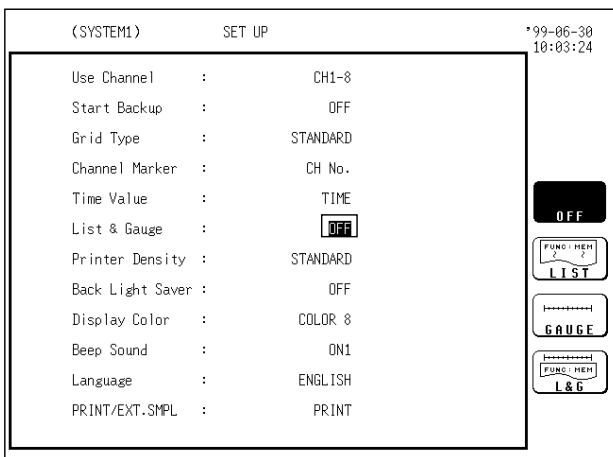

1. Press the **SYSTEM** key to call up the SET UP screen.
2. Move the flashing cursor to the position shown in the figure on the left.
3. Use the function keys to make the selection.

**OFF** : No gauges or listing

**FUNC: MEM ? LIST** : Print listing only

**GAUGE** : Print gauges only

**FUNC: MEM ? L&G** : Print both gauges and listing



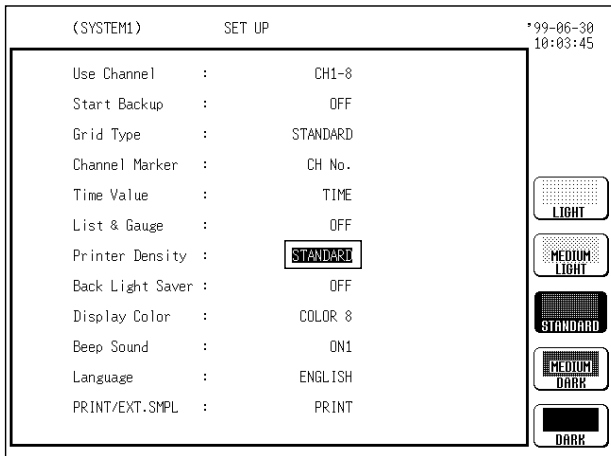

### 9.3.7 Setting the Printer Density

- Serves to set the printer density.
- The density can be set in five steps.
- Select the setting which yields the most easy to read printout.

**Method** Screen: SYSTEM 1 (SET UP)



1. Press the **SYSTEM** key to call up the SET UP screen.
2. Move the flashing cursor to the position shown in the figure on the left.
3. Use the function keys to make the selection.

-  : Print light
-  : Print semi-light
-  : Print standard density
-  : Print semi-dark
-  : Print dark



### 9.3.8 Setting Backlight Saver Function

- When this function is enabled, LCD backlighting is turned off automatically if no key is pressed for the preset interval.
- Pressing any key will turn the display on again.
- This increases the service life of the backlight.

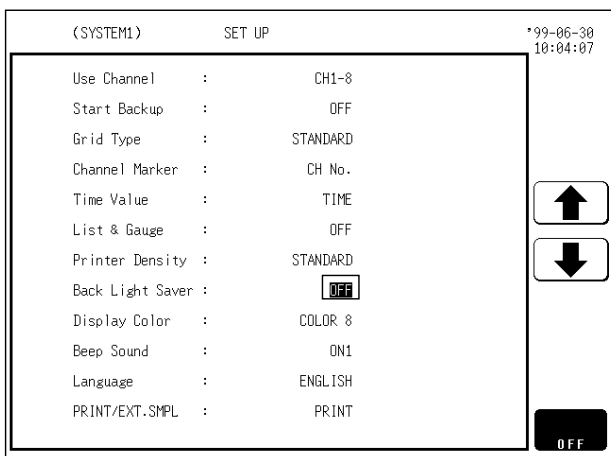
**Method** Screen: SYSTEM 1 (SET UP)



1. Press the **SYSTEM** key to call up the SET UP screen.
2. Move the flashing cursor to the position shown in the figure on the left.
3. Use the function keys to make the selection.

-  : Increase time.
-  : Decrease time.
-  : Disable the backlight saver function.

- OFF: The display is shown continuously.
- 1 to 30: The display automatically goes off after the preset interval (minutes).

### 9.3.9 Setting the Display Colors

- Serves to set the display color.
- The display color can be selected from among the display colors 1 to 8 and the customer color 9 which can be set as desired.

**Method** Screen: SYSTEM 1 (SETUP)

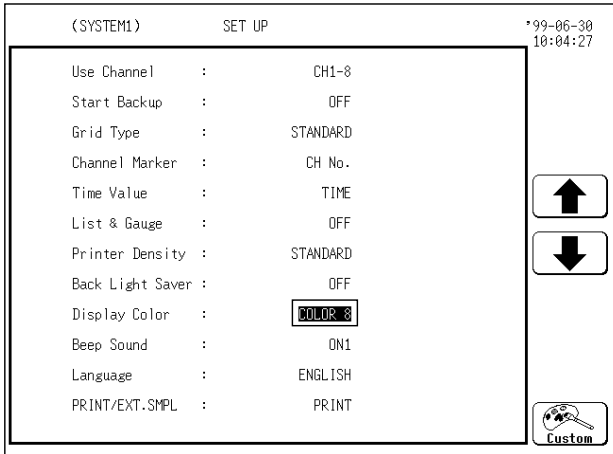

1. Press the **SYSTEM** key to call up the SET UP screen.
2. Move the flashing cursor to the position shown in the figure on the left.
3. Use the function keys to make the selection.

- : Display color number up
- : Display color number down
- : Call up the custom setting screen

#### Custom setting (setting the color as desired)

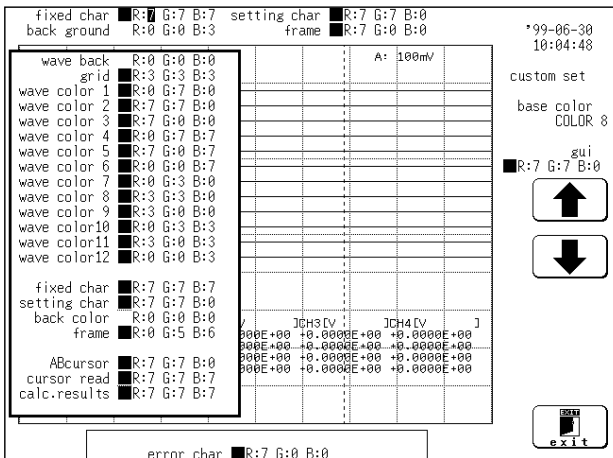

1. Change the R.G.B. setting values of each item on the screen.
2. Move the flashing cursor to the item for which you want to change the setting values, and use the JOG control or the function keys to make the settings.
3. The setting values inside the window applies to the colors of the particular window. When a value is changed, the color of the area corresponding to this item changes.

- : Value up
- : Value down
- : Exit from the custom setting screen

**NOTE**

- When system reset is executed, set colors are initialized and become the same color as that of display color 1.
- Only one customer color type can be set as desired.

### 9.3.10 Setting the Beep Sound

Serves to set the beep sound.

**Method** Screen: SYSTEM 1 (SET UP)

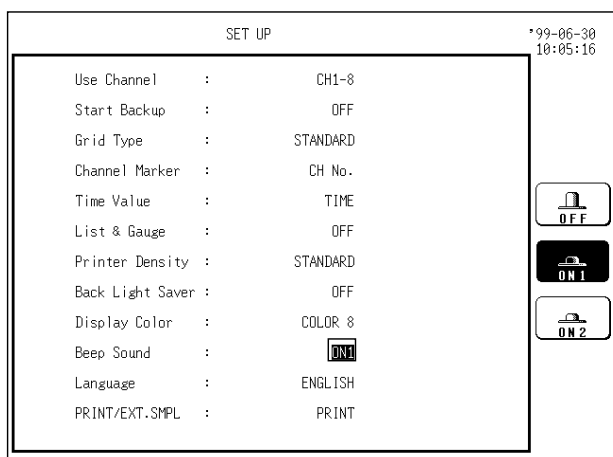

1. Press the **SYSTEM** key to call up the SET UP screen.
2. Move the flashing cursor to the position shown in the figure on the left.

3. Use the function keys to make the selection.



: Beep is not heard.



: Beeps at error, warning, and failure of measuring waveform area decision (advanced version) and waveform parameter decision (advanced version).



: Beeps at start, trigger, stop, completion of automatic save, error, warning, and failure of measuring waveform area decision (advanced version) and waveform parameter decision (advanced version).

### 9.3.11 Setting the Language

Serves to set the display language.

**Method** Screen: SYSTEM 1 (SET UP)

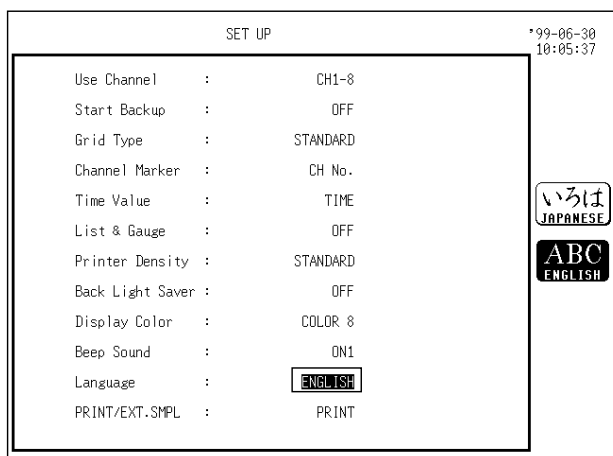

1. Press the **SYSTEM** key to call up the SET UP screen.

2. Move the flashing cursor to the position shown in the figure on the left.

3. Use the function keys to make the selection.



: The display language is Japanese.





: The display language is English.

### 9.3.12 Setting PRINT/EXT.SMPL

- Selecting external printing/external sampling terminal.
- System reset defaults to external printing.  
 PRINT: Enables external printing in all functions. By setting time axis range (frequency in FFT) to External in memory recorder and FFT (advanced version), it functions as external sampling terminal.  
 EXT.SMPL: Functions as external sampling terminal. (Memory recorder and FFT only)

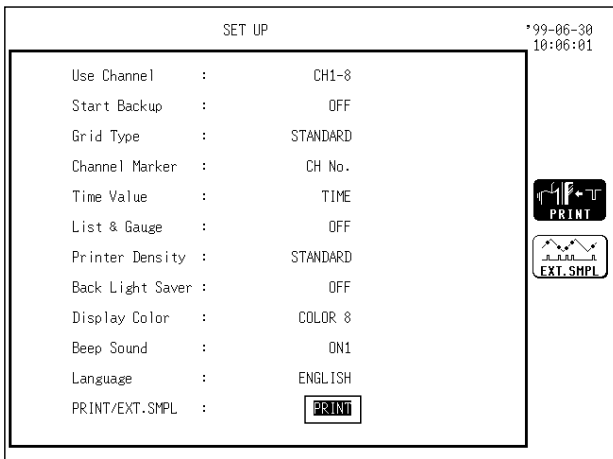
**Method** Screen: SYSTEM 1 (SET UP)



1. Press the **SYSTEM** key to call up the SET UP screen.
2. Move the flashing cursor to the position shown in the figure on the left.
3. Use the function keys to make the selection.  
: Use for external printing and external sampling terminal.  
: Use for external sampling terminal.

**NOTE**

In memory recorder and FFT (advanced version), setting time axis range (frequency in FFT) to External determines use of external sampling terminal even when PRINT is selected.  
 For external printing, set time axis range (or frequency) to another setting other than External.



## 9.4 Scaling Function [ SCALING ]

- The scaling function can be used to convert an output voltage from a sensor or similar into a physical quantity.
- Two types of scaling functions are available.

Method 1 (conversion ratio scaling)

Scaling is performed by specifying a physical quantity to correspond to a 1 V input signal (conversion ratio: EU/V), an offset value, and the unit (EU: Engineering Units). This will cause the measurement voltage to be converted into the selected units.

Method 2 (2-point scaling)

Scaling is performed by specifying two input signal points (voltage values) and the conversion values for these two points in engineering units (EU). This will cause the measurement voltage to be converted into the selected units.

- The gauge scale (maximum and minimum values of horizontal axis) and A/B cursor measurement values are displayed in the scaled units.
- Scaling can be performed for every channel.
- The scaling function can be used with the variable function.

### Method Screen: SYSTEM 2 (SCALING)

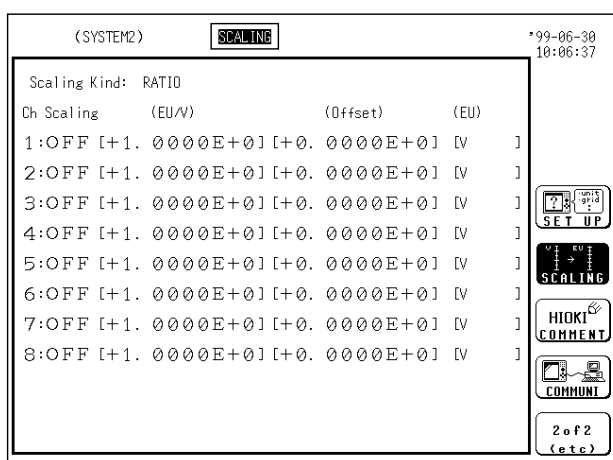

1. Press the **SYSTEM** key to call up the **SCALING** screen.

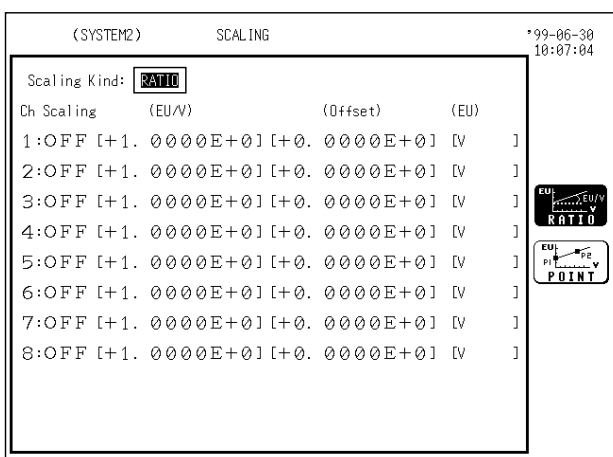

2. Move the flashing cursor to the position shown in the figure on the left.
3. Use the function keys to make the selection.

: Use conversion ratio scaling

: Use 2-point scaling

## 9.4.1 Conversion Ratio Scaling

Scaling is performed by specifying a physical quantity to correspond to a 1V input signal (conversion ratio: EU/V), an offset value, and the unit (EU: Engineering Units). This will cause the measurement voltage to be converted into the selected units.

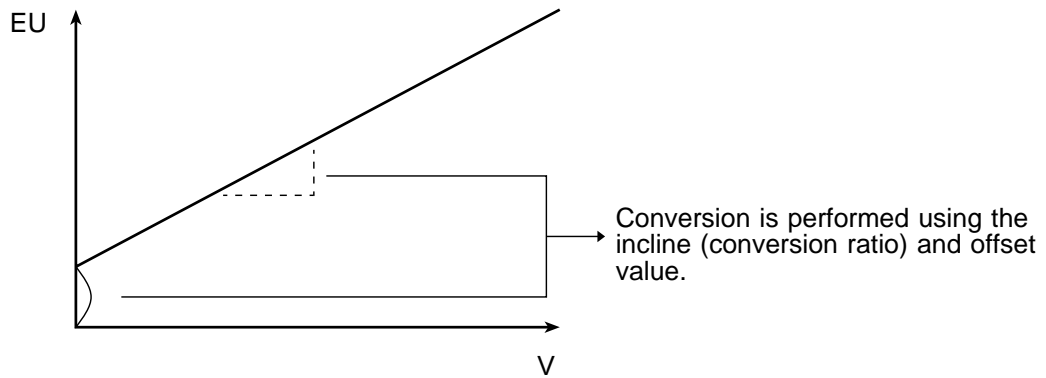

The setting can be made in two ways.

**Method 1** Screen: SYSTEM 2 (SCALING)

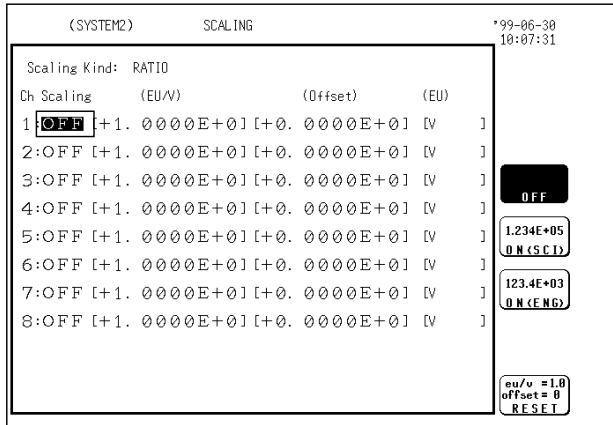

1. Move the flashing cursor to the channel for which you want to perform scaling and use the function keys to make the setting.

- : Scaling not used
- : Scaling used (specify exponent as integer)
- : Scaling used (specify exponent as multiple of 3)
- : Reset.

**NOTE**

If the exponents of data are integers (SCI), the numeral used as the cursor value or the value to be printed out will be expressed as it is rather than in exponential form, provided that it is 0.0001 to less than 100,000.

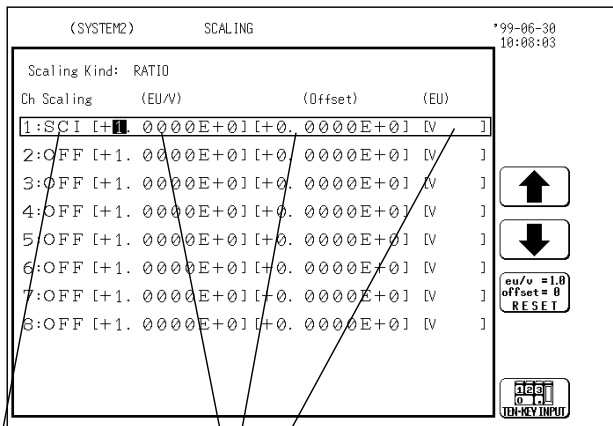

- 1. Scaling ON/OFF
- 2. Set conversion ratio and offset
- 3. Enter engineering unit (EU)

2. Enter the "Conversion ratio: EU/V" and "Offset". The setting range for both these items is -9.9999E+9 to +9.9999E+9. Move the flashing cursor to each digit and use the JOG control or the function keys to enter individual digits. (Use the cursor keys to move the column.)

- : Value up
- : Value down
- : Reset.
- : Enter the value using the numeric keys.

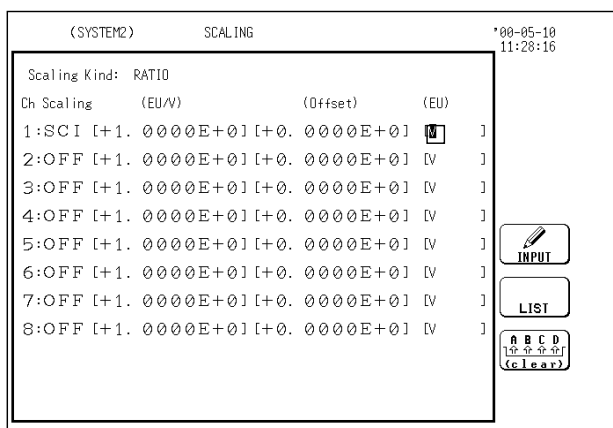

3. Enter the "Unit name: EU". Move the flashing cursor to the position shown in the figure on the left and enter the required unit. See Section 9.4.3.

### Method 2 (Using the numeric keys)

As opposed to method 1, selection is made not for each column individually but globally using the numeric keypad.

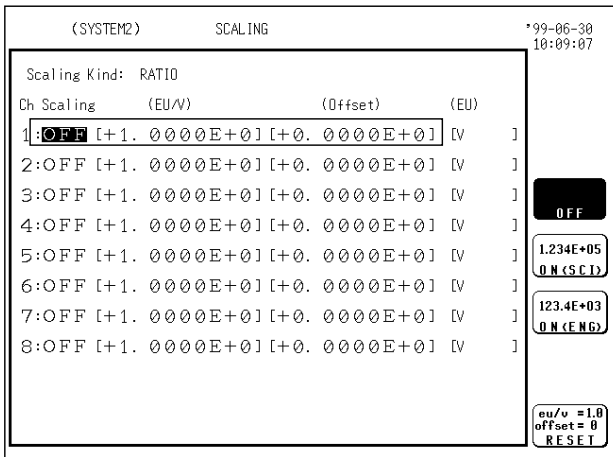

1. Move the flashing cursor to the channel for which you want to perform scaling and use the function keys to change the setting to ON.

- : Scaling not used
- : Scaling used (specify exponent as integer)
- : Scaling used (specify exponent as multiple of 3)
- : Reset.

**NOTE**

If the exponents of data are integers (SCI), the numeral used as the cursor value or the value to be printed out will be expressed as it is rather than in exponential form, provided that it is 0.0001 to less than 100,000.

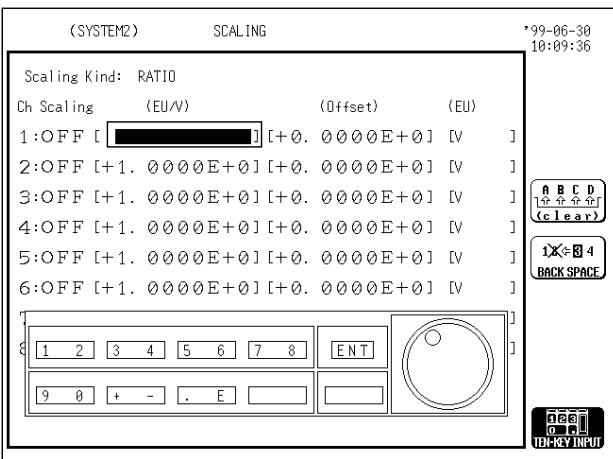

2. Move the flashing cursor to the value which you want to enter, and select TEN-KEY INPUT using the function key. The number key layout appears.
3. Enter the "Conversion ratio: EU/V" and "Offset". The setting range for both these items is -9.9999E+9 to +9.9999E+9. The cursor can be moved along the columns using the cursor keys. After the value is input using the numeric keys, the cursor moves to the next column. (The parameters can be input using the function keys.)

- : Value up
- : Value down
- : Reset
- : Escape from the ten-key input screen.

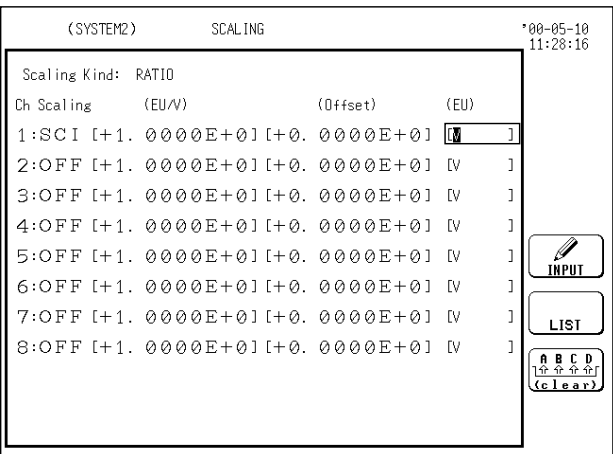

4. Enter the "Unit name: EU". Move the flashing cursor to the position shown in the figure on the left and enter the required unit. See Sections 9.4.3.

## 9.4.2 2-Point Scaling

Scaling is performed by specifying two input signal points (voltage values) and the conversion values for these two points in engineering units (EU). This will cause the measurement voltage to be converted into the selected units.

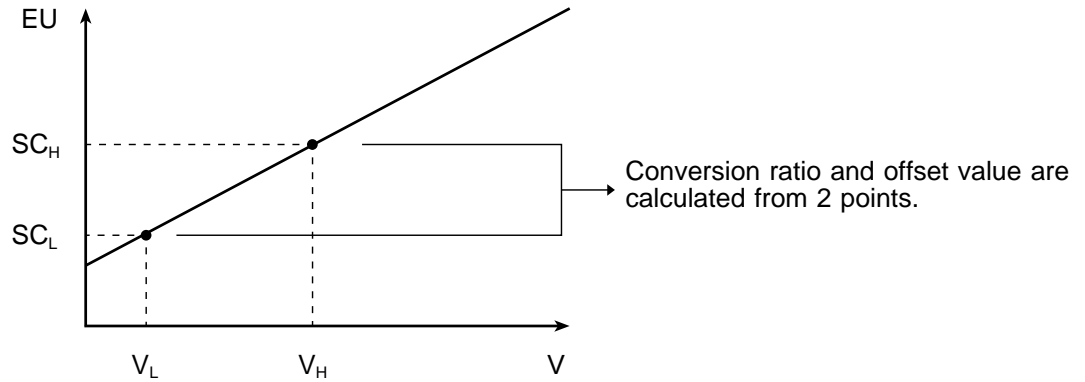

The setting can be made in two ways.

**Method 1** Screen: SYSTEM 2 (SCALING)

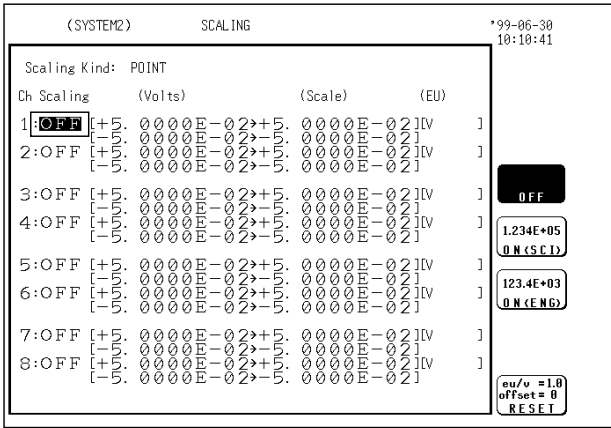

1. Move the flashing cursor to the channel for which you want to perform scaling and use the function keys to make the setting.

- : Scaling not used
- : Scaling used (specify exponent as integer)
- : Scaling used (specify exponent as multiple of 3)

**NOTE**

If the exponents of data are integers (SCI), the numeral used as the cursor value or the value to be printed out will be expressed as it is rather than in exponential form, provided that it is 0.0001 to less than 100,000.

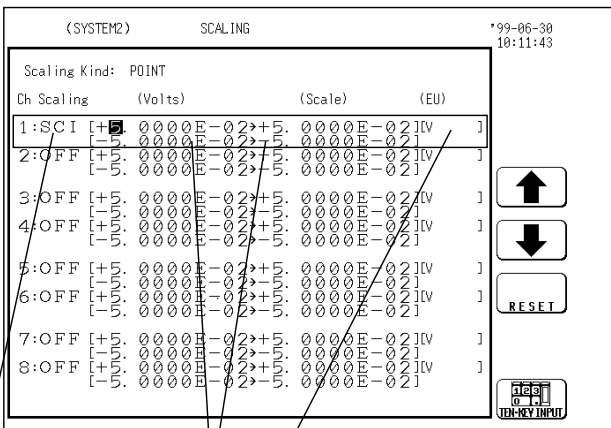

2. Enter the two points.

- Enter the voltage value on the left and the corresponding converted value on the right.
- The setting range is  $-9.9999E+9$  to  $+9.9999E+9$ .

Move the flashing cursor to each digit and use the JOG control or the function keys to enter individual digits. (Use the cursor keys to move the column.)

- : Value up
- : Value down
- : Reset
- : Enter the value using the numeric keys.

- 1. Scaling ON/OFF
- 2. Set voltage value conversion value
- 3. Enter engineering unit (EU)

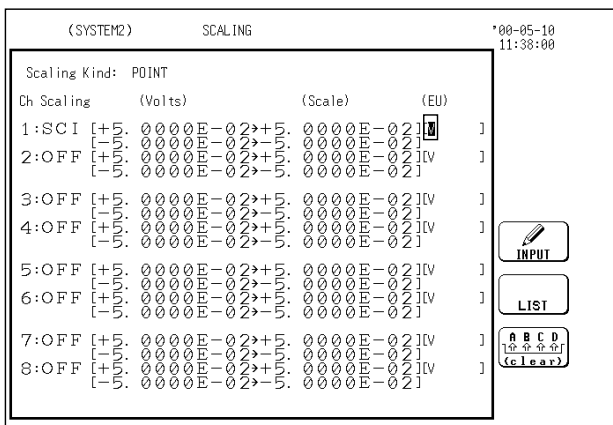

3. Enter the "Unit name: EU".

Move the flashing cursor to the position shown in the figure on the left and enter the required unit. See Sections 9.4.3.

## Method 2 (Using the numeric keys)

As opposed to method 1, selection is made not for each column individually but globally using the numeric keypad.

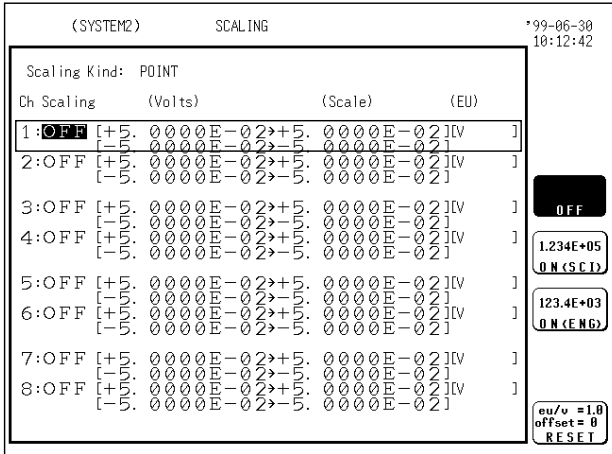

1. Move the flashing cursor to the channel for which you want to perform scaling and use the function keys to change the setting to ON.

- OFF : Scaling not used
- 1.234E+05 ON (SCI) : Scaling used (specify exponent as integer)
- 123.4E+03 ON (ENG) : Scaling used (specify exponent as multiple of 3)

**NOTE**

If the exponents of data are integers (SCI), the numeral used as the cursor value or the value to be printed out will be expressed as it is rather than in exponential form, provided that it is 0.0001 to less than 100,000.

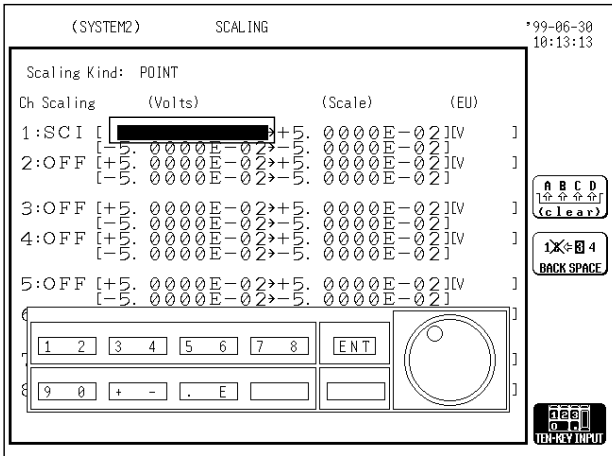

2. Move the flashing cursor to the value which you want to enter, and select TEN-KEY INPUT using the function key. The number key layout appears.
3. Enter the two points (for details, refer to Method 1).  
The cursor can be moved along the columns using the cursor keys. After the value is input using the numeric keys, the cursor moves to the next column. (The parameters can be input using the function keys.)

- ↑ : Value up
- ↓ : Value down
- RESET : Reset
- TEN-KEY INPUT : Escape from the ten-key input screen.

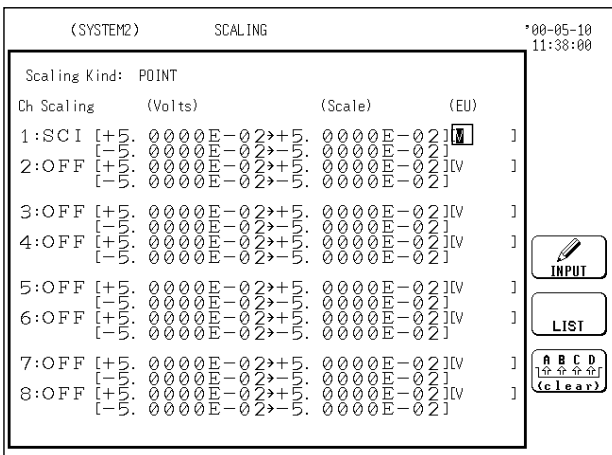

4. Enter the "Unit name: EU".  
Move the flashing cursor to the position shown in the figure on the left and enter the required unit. See Sections 9.4.3.

**NOTE**

- When the 2-point scaling is used, scaling is performed using the following equation.

$$Y = \left[ \frac{SC_H - SC_L}{V_H - V_L} \right] X + \left[ \frac{V_H \times SC_L - V_L \times SC_H}{V_H - V_L} \right]$$

$V_H$ : Voltage high point       $SC_H$ : Scaling high point  
 $V_L$ : Voltage low point       $SC_L$ : Scaling low point

- The ranges for the parts enclosed in dotted lines are as follows.

-9.9999E+9    value of enclosed part    -1.0000E-9

Value of enclosed part = 0

-1.0000E-9    value of enclosed part    +9.9999E+9

A setting outside of the above range cannot be made.

**Relationship between scaling function and variable function**

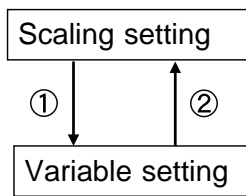

- Convert the measured value to a physical quantity.
- Set the unit.

- Set the upper and lower limits to be used after conversion to a physical quantity.

- Results are the same regardless of the order in which ① and ② are set.
- In ②, set the variable function with the value after scaling.  
 (Set the unit (EU) on the SCALING screen.)

**NOTE**

- When using both the scaling and variable functions, the upper and lower limits for the variable display after scaling are as follows.

-9.9999E + 29    setting value    -1.0000E - 29

Setting value = 0

+1.0000E-29    setting value    +9.9999E+29

- When a setting outside of the above range is attempted, a warning indication is given.



## 9.4.3 Unit Entry Procedure

The unit (EU) after scaling is entered.

**Method** Screen: SYSTEM 2 (SCALING)

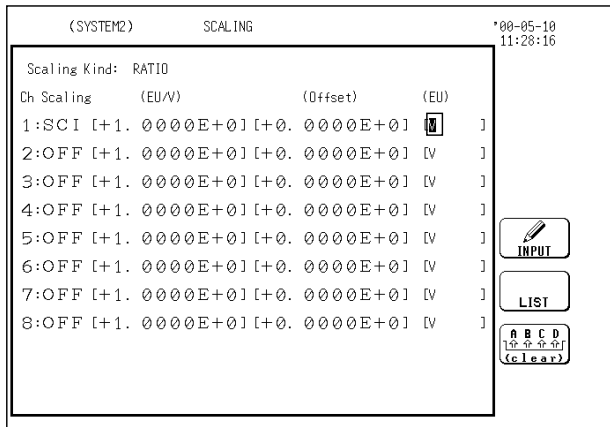

1. Move the flashing cursor to the position shown in the figure on the left.
2. Use the function keys to make the selection.



: Enter the unit.



: Select from the unit list.



: Clear the set unit.

3. Enter the unit name.

For details on unit input, see Section 9.5.5.

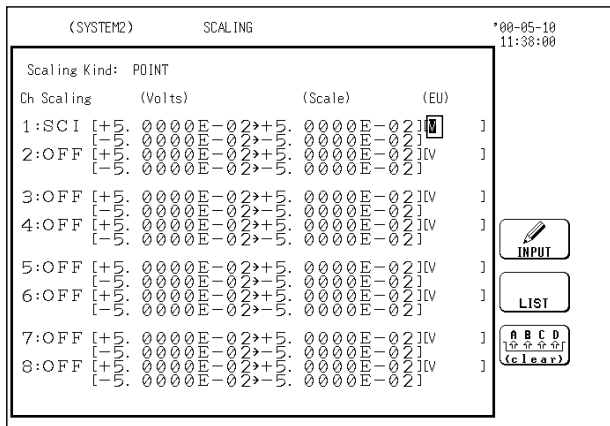

4. When List is selected, the unit setting is selected by the displayed function keys.



: Move the cursor up in the selection window.



: Move the cursor down in the selection window.



: Enter the selected unit .



: Cancel.

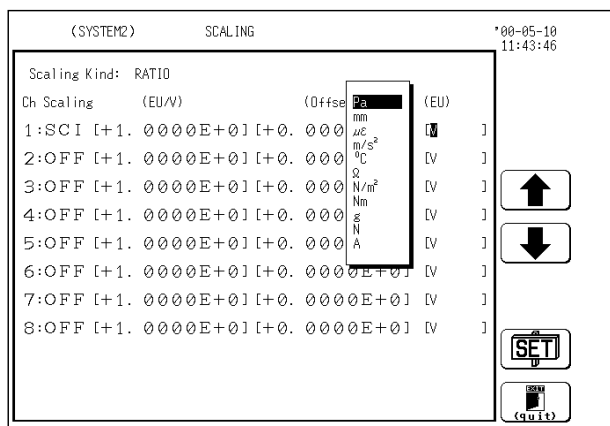

## 9.4.4 Copy Settings

Scaling settings can be copied from one channel to another, by specifying either a conversion ratio or two points.

**Method** Screen: SYSTEM 2 (SCALING)

(SYSTEM2) SCALING \*00-05-10 11:57:26

Scaling Kind: RATIO

Ch	Scaling	(EU/V)	(Offset)	(EU)
1	SCI	[+5. 5555E+5]	[+1. 1111E+1]	[A ]
2	OFF	[+1. 0000E+0]	[+0. 0000E+0]	[V ]
3	OFF	[+1. 0000E+0]	[+0. 0000E+0]	[V ]
4	OFF	[+1. 0000E+0]	[+0. 0000E+0]	[V ]
5	OFF	[+1. 0000E+0]	[+0. 0000E+0]	[V ]
6	OFF	[+1. 0000E+0]	[+0. 0000E+0]	[V ]
7	OFF	[+1. 0000E+0]	[+0. 0000E+0]	[V ]
8	OFF	[+1. 0000E+0]	[+0. 0000E+0]	[V ]

COPY SOURCE

CH ↑

1CH

CH ↓

set

Specifies the copy destination channel

Specifies copy source channel

1. Move the flashing cursor to the channel number of the copy destination channel.
2. Use the function keys or the Jog/Shuttle control to specify the copy target channel. Selection of "for ALL" enables the settings (comments) for the channel with the flashing cursor to be copied to all channels

- : Select next higher channel.
- 1CH : Copy source channel.
- : Select next lower channel.
- :Execute.

(SYSTEM2) SCALING \*00-05-10 11:57:54

Scaling Kind: RATIO

Ch	Scaling	(EU/V)	(Offset)	(EU)
1	SCI	[+5. 5555E+5]	[+1. 1111E+1]	[A ]
2	SCI	[+5. 5555E+5]	[+1. 1111E+1]	[A ]
3	OFF	[+1. 0000E+0]	[+0. 0000E+0]	[V ]
4	OFF	[+1. 0000E+0]	[+0. 0000E+0]	[V ]
5	OFF	[+1. 0000E+0]	[+0. 0000E+0]	[V ]
6	OFF	[+1. 0000E+0]	[+0. 0000E+0]	[V ]
7	OFF	[+1. 0000E+0]	[+0. 0000E+0]	[V ]
8	OFF	[+1. 0000E+0]	[+0. 0000E+0]	[V ]

COPY SOURCE

CH ↑

1CH

CH ↓

set

3. Press the Execute function key to copy. In the example at the left, CH1 settings are copied to CH2.

### 9.4.5 Scaling Setting Example

(SYSTEM2) SCALING \*99-06-30 10:16:11

Scaling Kind: POINT

Ch	Scaling	(Volts)	(Scale)	(EU)
1:	SCI	[+1. 20000E+00]	[+0.0000E+00]	[G]
2:	OFF	[+0.0000E+00]	[+0.0000E+00]	[V]
3:	OFF	[+5.0000E-02]	[+5.0000E-02]	[V]
4:	OFF	[+5.0000E-02]	[+5.0000E-02]	[V]
5:	OFF	[+5.0000E-02]	[+5.0000E-02]	[V]
6:	OFF	[+5.0000E-02]	[+5.0000E-02]	[V]
7:	OFF	[+5.0000E-02]	[+5.0000E-02]	[V]
8:	OFF	[+5.0000E-02]	[+5.0000E-02]	[V]

Buttons: OFF, 1.234E+05 0.N (SCD), 123.4E+03 0.N (ENG), eu/v = 1.0 offset = 0 RESET

The example below shows the scaling function of the strain unit.

When a sensor having a gage ratio of 2 (the conversion ratio is characterized as "3G = 1200 μ (micro strain)") is used:

Scaling method : 2-point scaling

Setting : SCI or ENG

Converting value : 1200 ( μ ) 3 ( scale )  
0 ( μ ) 0 ( scale )

unit (eu) : G

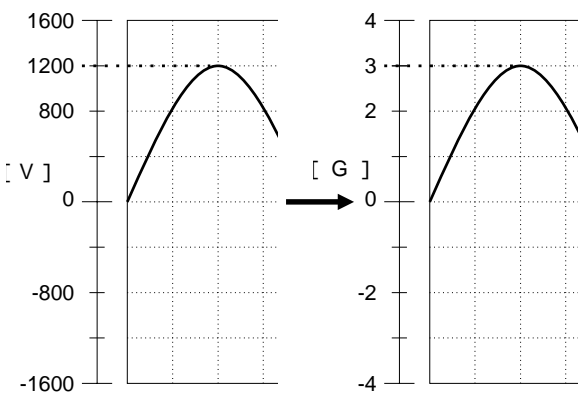

Through the use of the scaling function, the signal from the sensor can be obtained in the form of a physical quantity.

- Cursor values A and B, respectively, show the physical quantities.
- If the gage is turned on before the printout is made, the gage is output in a physical quantity.

(SYSTEM2) SCALING \*99-06-30 10:17:15

Scaling Kind: POINT

Ch	Scaling	(Volts)	(Scale)	(EU)
1:	SCI	[+2.0000E-01]	[+1.0000E+01]	[A]
2:	OFF	[+1.0000E+00]	[+0.0000E+00]	[V]
3:	OFF	[+5.0000E-02]	[+5.0000E-02]	[V]
4:	OFF	[+5.0000E-02]	[+5.0000E-02]	[V]
5:	OFF	[+5.0000E-02]	[+5.0000E-02]	[V]
6:	OFF	[+5.0000E-02]	[+5.0000E-02]	[V]
7:	OFF	[+5.0000E-02]	[+5.0000E-02]	[V]
8:	OFF	[+5.0000E-02]	[+5.0000E-02]	[V]

Buttons: OFF, 1.234E+05 0.N (SCD), 123.4E+03 0.N (ENG), eu/v = 1.0 offset = 0 RESET

The example below shows the type of scaling when the measurement range is set to 10 A using the 9018 CLAMP ON PROBE.

Scaling method : 2-point scaling

Setting : SCI or ENG

Converting value : 0.2 ( V ) 10 ( scale )  
0 ( V ) 0 ( scale )

unit (eu) : A

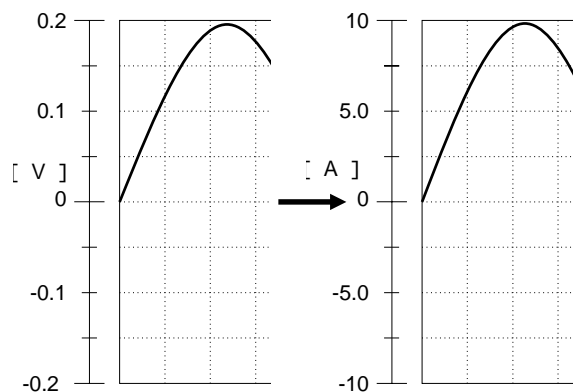

Through the use of the scaling function, the signal from the sensor can be obtained in the form of a current value.

- Cursor values A and B, respectively, show the current values.
- If the gage is turned on before the printout is made, the gage is output in a current value.

## 9.5 Adding Comments to a Graph [ COMMENT ]

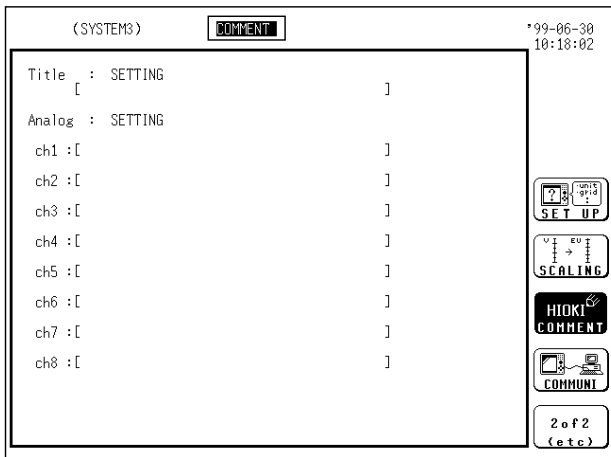

Two types of comment are available.

### (1) Title comment input

Title comments of up to 40 characters can be included on the recording paper.

If "COMMENT" or "SET & COMMENT" is selected, this title comment will be included on the recording paper in all functions.

### (2) Input of comments for each channel

Comments of up to 40 characters can be included on the recording paper on each channel.

If "COMMENT" or "SET & COMMENT" is selected, this comment will be included on the recording paper in all functions.

#### NOTE

When the printer format is "numeric data", the setting items are not printed.

## 9.5.1 Title Comment Input

- Title comment input is described.
- Three types of title comment are available.

1. SET: Function, time axis range, magnification/compression ratio along the time axis, date and time of trigger
2. COMMENT: Comment of up to 40 characters
3. SET & COMMENT: Both 1 and 2

**Method** Screen: SYSTEM 3 (COMMENT)

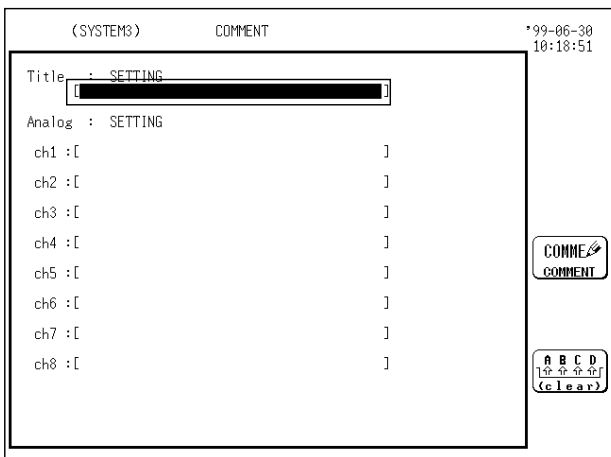
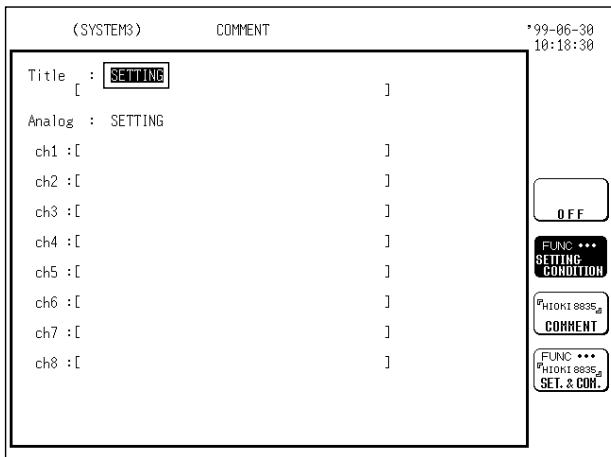

1. Press the **SYSTEM** key to call up the COMMENT screen.
2. Move the flashing cursor to the position shown in the figure on the left.
3. Use the function keys to make the selection.
  - OFF** : Standard printout is performed.
  - FUNC \*\*\* SETTING CONDITION** : Setting item is printed.
  - H10K1 8835a COMMENT** : Comment is printed.
  - FUNC \*\*\* H10K1 8835a SET. & COM.** : Both item and comment are printed.

4. When the flashing cursor is moved with the CURSOR keys, the following function key indication appears.

- COMME COMMENT** : Display the comment input window.
- A B C D 1st 2nd 3rd 4th (c.l.e.a.r)** : Clear the currently displayed comments.

For details on comment input, see Section 9.5.5.

When "COMMENT" or "SET & COMMENT" is selected, the comments are printed for the report print (see Section 10.7.7).

**NOTE**

The printer-recording format is set to numeric, and setting items are not printed.

## 9.5.2 Analog Channel Comment Input

- Analog channel comment input is described.
- Three types of analog channel comment are available.

1. SET: Full-span voltage for each channel, voltage axis range, magnification/compression ratio along the voltage axis, zero position, low-pass filter setting
2. COMMENT: Comment of up to 40 characters
3. SET & COMMENT: Both 1 and 2

**Method** Screen: SYSTEM 3 (COMMENT)

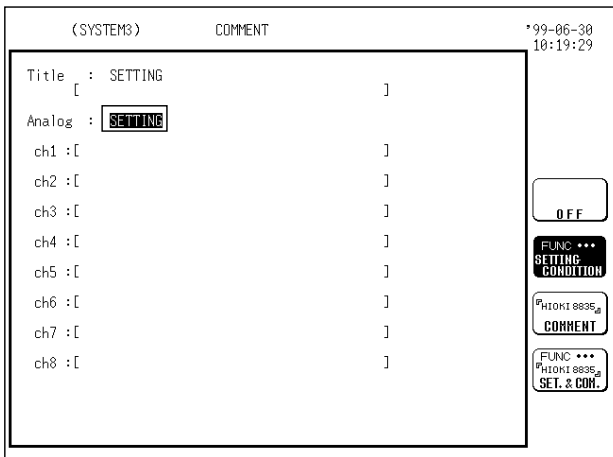

1. Press the **SYSTEM** key to call up the COMMENT screen.
2. Move the flashing cursor to the position shown in the figure on the left.
3. Use the function keys to make the selection.

- OFF** : Standard printout is performed.
- FUNC \*\*\* SETTING CONDITION** : Setting item is printed.
- FHIOKI 8835 COMMENT** : Comment is printed.
- FUNC \*\*\* FHIOKI 8835 SET. & COM.** : Both item and comment are printed.

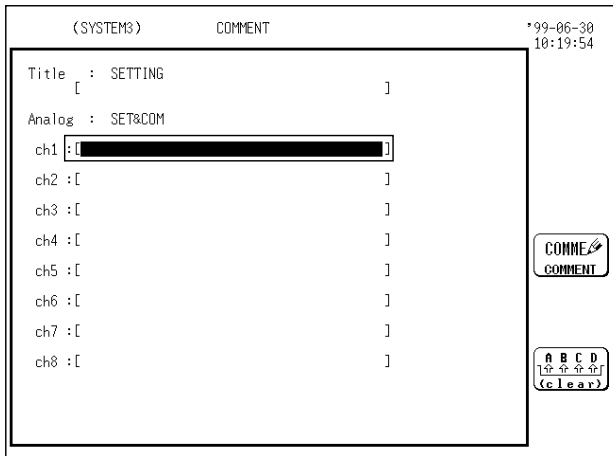

4. When the flashing cursor is moved with the CURSOR keys, the following function key indication appears.

- COMME COMMENT** : Display the comment input window.
- A B C D [ ] (clear)** : Clear the currently displayed comments.

For details on comment input, see Section 9.5.5. When "COMMENT" or "SET & COMMENT" is selected, the comments are printed for the report print (see Section 10.7.7).

**NOTE**

The printer-recording format is set to numeric, and setting items are not printed.

## 9.5.3 Moving to the Analog Channel Comment Input Screen or the Logic Channel Comment Input Screen

### Method

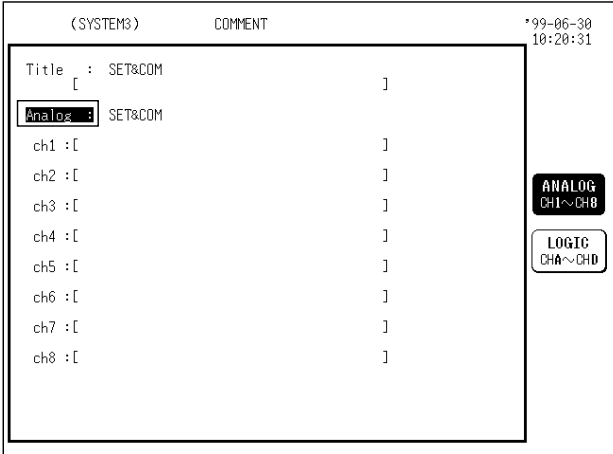

1. Move the flashing cursor to the position shown in the figure on the left.

2. Use the function keys to make the selection.

**ANALOG CH1~CH8** : Move to the analog channel comment input screen.

**LOGIC CHA~CHD** : Move to the logic channel comment input screen.

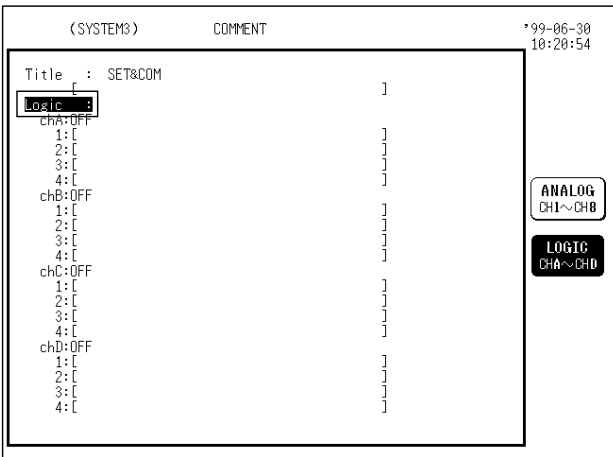

## 9.5.4 Logic Channel Comment Input

- Logic channel comment input is described.
- One type of logic channel comment is available.

### COMMENT

Comments can be entered separately for every channel.

**Method** Screen: SYSTEM 3 (COMMENT)

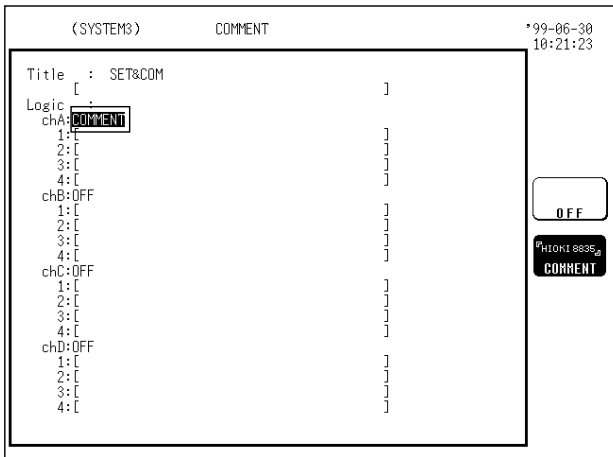

1. Press the **SYSTEM** key to call up the COMMENT screen.
2. Call up the logic channel comment input screen
3. Move the flashing cursor to the position shown in the figure on the left.
4. Use the function keys to make the selection.

**OFF** : Standard printout is performed.

**PHI0KI 8835 COMMENT** : Comment is printed.

5. When the flashing cursor is moved with the CURSOR keys, the following function key indication appears.

**COMMENT** : Display the comment input window.

**A B C D (clear)** : Clear the currently displayed comments.

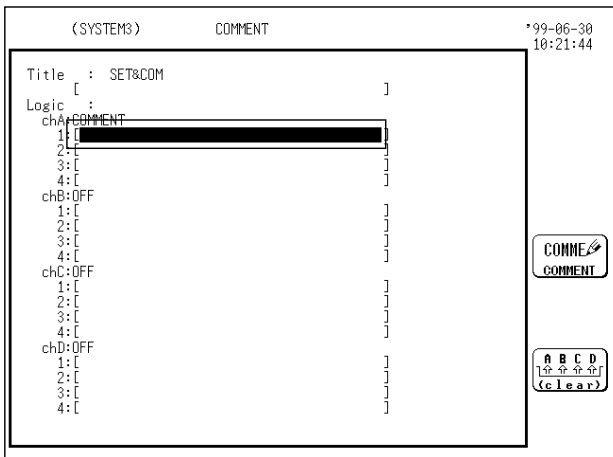

For details on comment input, see Section 9.5.5.





## 9.5.5 Character Entry Procedure

The procedure for entering the characters for the comments, units, etc. is described.

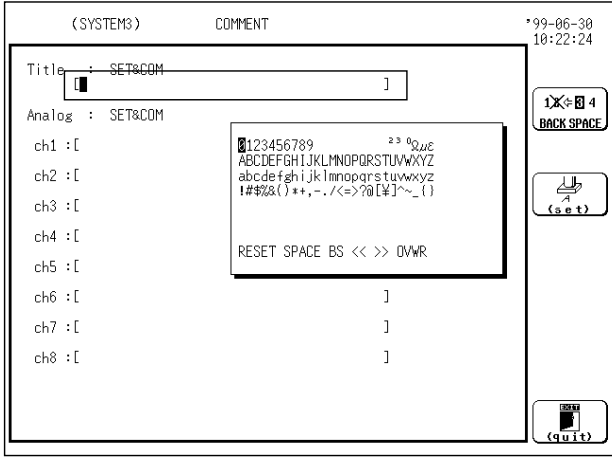
### Method Screen: SYSTEM 3 (COMMENT)





1. Move the flashing cursor to the position in which you want to enter the comment.
2. Use the function keys to make the selection.

 : Enter a comment.  
 : Clear a comment.

3. Use the cursor keys to select the character, and press the F1 (set) key to enter it.

- Use the JOG control to move the cursor.  
**JOG control:** Moves the cursor in the character entry field

**Cursor:** Move the the character selection cursor.

- The  key performs backspacing.
4. When the all the characters are entered, press the  (quit) key.

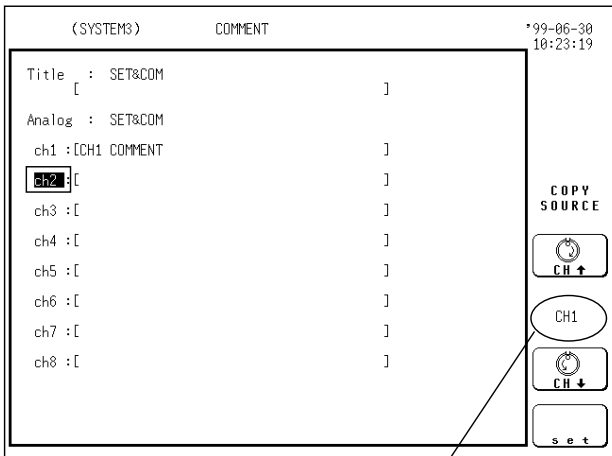

A comment made on one channel can be copied onto another channel. This can be done for either an analog or logic channel.

### Method



Indicates the copy source channel

1. Move the flashing cursor to the channel for which you want to enter the comment.
2. Use the function keys to select the channel to be copied.

 : Channel number up  
 : Channel number down  
 : Copy the comments for the selected channel.

## 9.5.6 Description of Window Contents

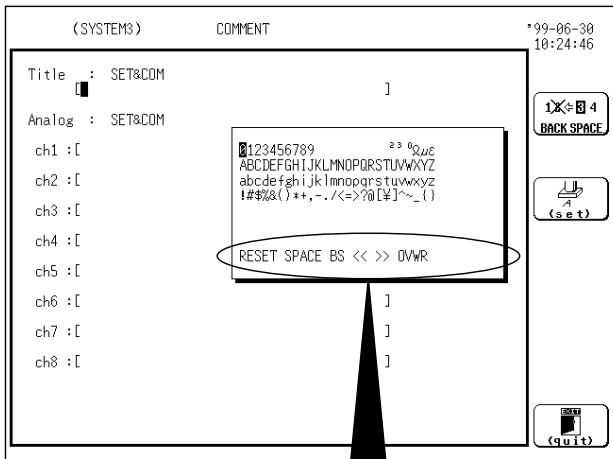

Reset, Space, BS, <<. >>, Overwrite

**Reset:** Recalls an unedited comment in comment input mode. Recalls the default units in unit input mode.

**Space:** Enter a space.

**BS:** Performs backspacing (same as the **VIEW** key).

**<<:** Moves the input position to the left (same as the JOG control).

**>>:** Moves the input position to the right (same as the JOG control).

**Overwrite / insert:** Switches the mode between overwrite and insert

## 9.6 Interface Settings (Media Settings)

- Settings for various interfaces
- The output destination for the **COPY** key can be set (see Section 9.6.1).
- The output destination for the **PRINT** key can be set (see Section 9.6.2).
- GP-IB settings can be performed when the 9558 GP-IB CARD is installed (see Section 9.6.3).
- RS-232C card settings can be performed when the 9557 RS-232C CARD is installed (see Section 9.6.4).
- LAN settings can be performed when the 9578 10BASE-T LAN CARD is installed. High-speed data transfer between the 8835-01 and a PC, and remote control from a PC, can be performed over the LAN when the 9578 10BASE-T LAN CARD and the 9333 LAN COMMUNICATOR software are installed. (see Section 9.6.5)

Please refer to the 9578 10BASE-T LAN CARD and 9333 LAN COMMUNICATOR Instruction Manual for details.

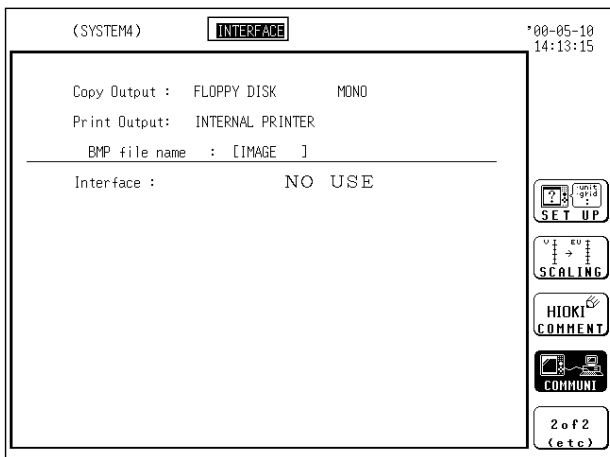

A BMP file name can be entered when the **COPY** key output destination is set to floppy disk, PC card or interface.

### Method Screen: SYSTEM 4 (INTERFACE)

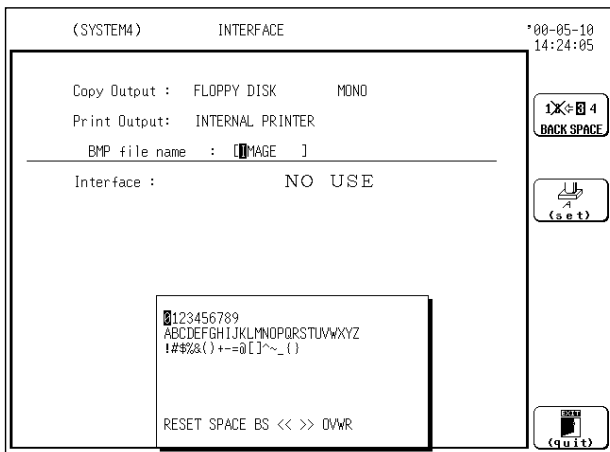



1. Move the flashing cursor to the BMP file name item, as shown in the figure on the left.
2. Enter the BMP file name. Default name is "IMAGE."  
For details on the procedure for entering the characters, see Section 9.5.5.

## 9.6.1 Setting the Output Destination by the COPY Key

The screen data output destination when the **COPY** key is pressed is specified.

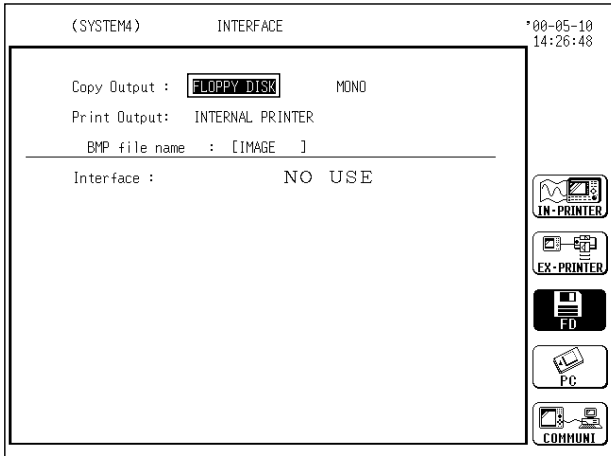
**Method** Screen: SYSTEM 4 (INTERFACE)



: Output to internal printer.

: Output to external printer.

: Output to floppy disk (BMP format).

: Output to PC card (BMP format).

: Output using the interface (BMP format).

**NOTE**

The 9559 PRINTER CARD is required to print on an external printer (see Section 10.7.8).

When the external printer is the output destination, select the control code.

: Uses ESC/P as the control code.

: Uses ESC/P raster as the control code.

Select the printing size (external printer only).

: Print normal size.

: Print at 1.5 times magnification.

When the internal printer is not the output destination, select the color of the output destination.

: Output color data.

: Output gray-scale data.

: Output monochrome data.

: Output reverse monochrome data.

**NOTE**

- When the output destination specified excluding internal and external printer and the color is set to monochrome, the screen is displayed in monochrome while data saving is in progress.
- Stores a file in the directory currently selected on the file screen.
- Refer to printer manual for control code selections.
- A file stored in the BMP format is not readable by the 8835-01.
- When the LAN interface is selected, only Color and Monochrome output destination color selections are available.

## 9.6.2 Setting the Output Destination by the PRINT Key

The measurement data output destination when the **PRINT** key is pressed is specified.

**Method** Screen: SYSTEM 4 (INTERFACE)

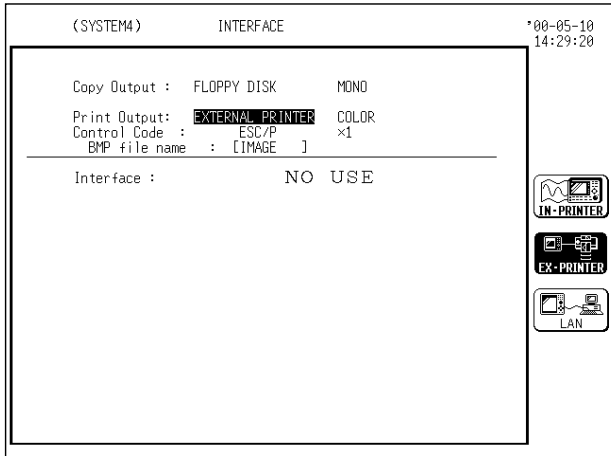

: Output to internal printer.



: Output to external printer.



: Print data is automatically transferred to the data collection server on the LAN (when connected to a LAN).

### NOTE

The 9559 Printer Card is required to print on an external printer. See Section 10.7.8.

When the external printer is the output destination, select the control code.



: Uses ESC/P as the control code.



: Uses ESC/P raster as the control code.

When the external printer is the output destination, select the color of the output destination.



: Output color data.



: Output monochrome data.

Select the printing size.



: Print normal size.



: Print at 1.5 times magnification.

### NOTE

- Even if the information that has been input using the **PRINT** key is to be output to the external printer, automatic printing or real-time printing is performed on the internal printer rather than the external printer.
- Refer to printer manual for control code selections.

## 9.6.3 GP-IB Interface Settings

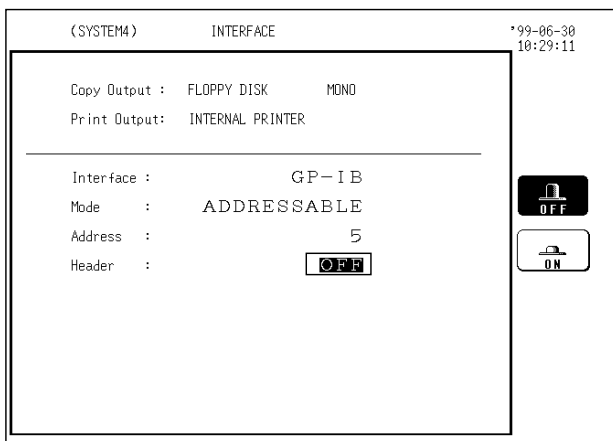
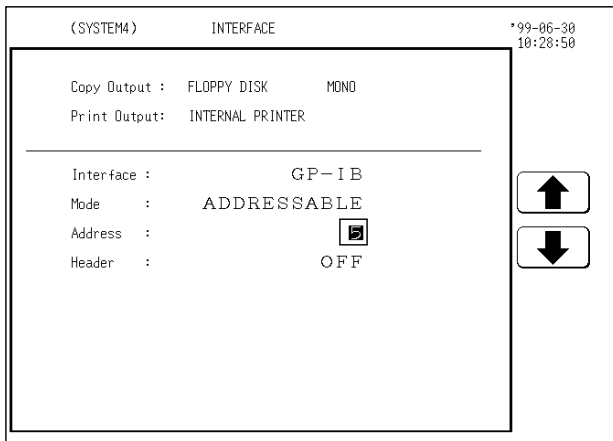
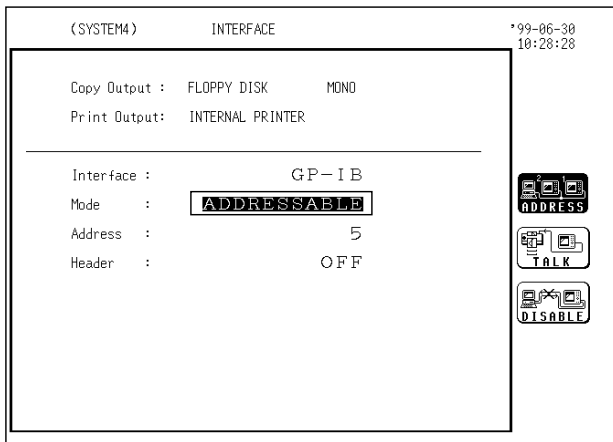
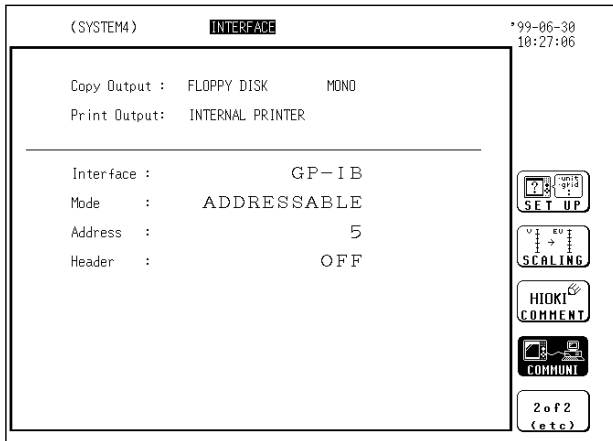

When the GP-IB interface has been selected, and the 9558 GP-IB CARD is connected, the following items must be set.

**NOTE**

- Settings are not displayed unless the 9558 GP-IB CARD is connected.
- For more details, refer to its instruction manual.

### 1. Mode

Set the mode. Move the flashing cursor to the position shown in the figure on the left, and use the function keys to make the selection.

- : ADDRESSABLE
- : TALK ONLY
- : DISABLE

### 2. Address

Set the address. Move the flashing cursor to the position shown in the figure on the left, and use the JOG control or the function keys to make the setting. (0 to 30)

- : Address up
- : Address down

### 3. Header

Set the header. Move the flashing cursor to the position shown in the figure on the left, and use the function keys to make the selection.

- : Header information is not appended.
- : Header information is appended.

## 9.6.4 RS-232C Interface Settings

(SYSTEM4) **INTERFACE** \*99-06-30 10:29:50

Copy Output : FLOPPY DISK MONO  
Print Output: INTERNAL PRINTER

---

Interface : RS-232C  
Speed : 1200  
Data : 8 bit  
Parity : NONE  
Stop : 1 bit  
Delimiter : LF  
Header : OFF  
Flow : NONE

7 8 9 10 11 12  
SET UP  
V E U  
SCALING  
HIKI  
COMMENT  
2 of 2  
(etc)

(SYSTEM4) INTERFACE \*99-06-30 10:30:14

Copy Output : FLOPPY DISK MONO  
Print Output: INTERNAL PRINTER

---

Interface : RS-232C  
Speed : 1200  
Data : 8 bit  
Parity : NONE  
Stop : 1 bit  
Delimiter : LF  
Header : OFF  
Flow : NONE

1200 bit/s  
2400 bit/s  
4800 bit/s  
9600 bit/s  
2 of 2  
(etc)

(SYSTEM4) INTERFACE \*99-06-30 10:30:36

Copy Output : FLOPPY DISK MONO  
Print Output: INTERNAL PRINTER

---

Interface : RS-232C  
Speed : 1200  
Data : 8 bit  
Parity : NONE  
Stop : 1 bit  
Delimiter : LF  
Header : OFF  
Flow : NONE

8 bit  
7 bit

(SYSTEM4) INTERFACE \*99-06-30 10:30:57

Copy Output : FLOPPY DISK MONO  
Print Output: INTERNAL PRINTER

---

Interface : RS-232C  
Speed : 1200  
Data : 8 bit  
Parity : NONE  
Stop : 1 bit  
Delimiter : LF  
Header : OFF  
Flow : NONE

NONE  
EVEN  
ODD

When the RS-232C interface has been selected, and the 9557 RS-232C CARD is connected, the following items must be set.

### NOTE

- Settings are not displayed unless the 9557 RS-232C CARD is connected.
- For more details, refer to its instruction manual.

### 1. Transfer rate

Set the transfer rate. Move the flashing cursor to the position shown in the figure on the left, and use the function keys to make the selection.

### 2. Data word length

Set the data word length. Move the flashing cursor to the position shown in the figure on the left, and use the function keys to make the selection.

**8 bit** : Set the data word length to 8 bits.

**7 bit** : Set the data word length to 7 bits.

### 3. Parity

Set the parity. Move the flashing cursor to the position shown in the figure on the left, and use the function keys to make the selection.

**NONE** : No parity

**EVEN** : Even parity

**ODD** : Odd parity

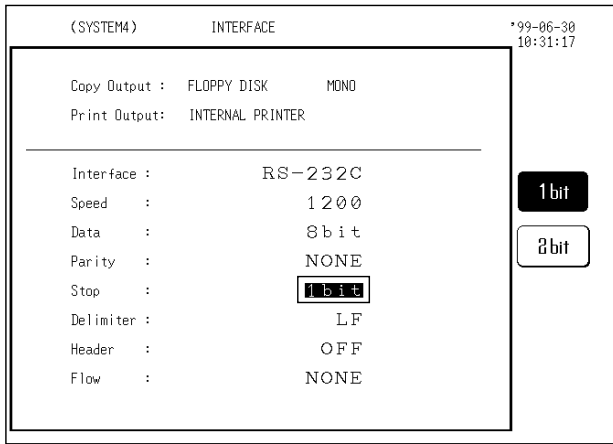

#### 4. Stop bit

Set the stop bit. Move the flashing cursor to the position shown in the figure on the left, and use the function keys to make the selection.

- : Set to 1 bit.
- : Set to 2 bits.

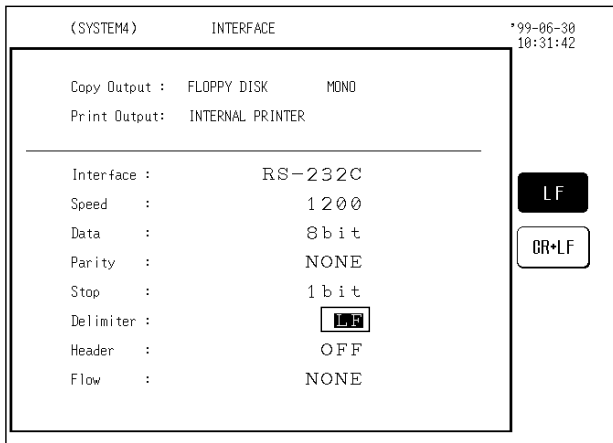

#### 5. Delimiter

Set the delimiter. Move the flashing cursor to the position shown in the figure on the left, and use the function keys to make the selection.

- : Set to LF.
- : Set to CR+LF.

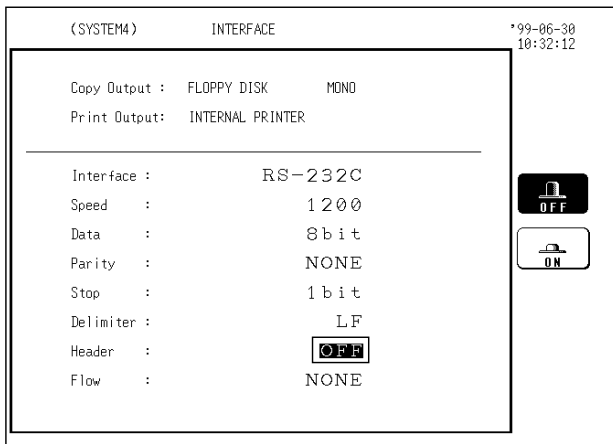

#### 6. Header

Set the header. Move the flashing cursor to the position shown in the figure on the left, and use the function keys to make the selection.

- : Header information is not appended.
- : Header information is appended.

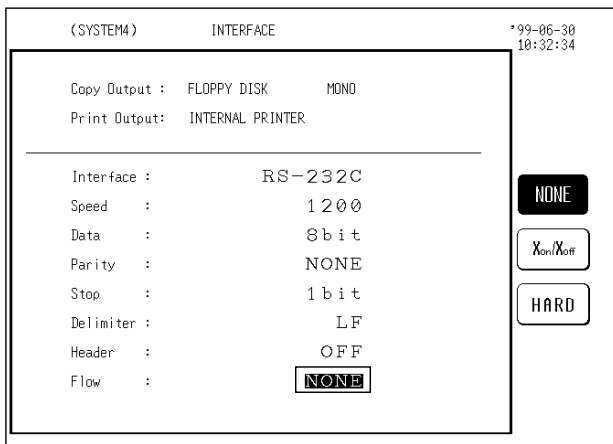

#### 7. Flow control

Set the flow control. Move the flashing cursor to the position shown in the figure on the left, and use the function keys to make the selection.

- : None
- : Software handshake
- : Hardware handshake



---

## 9.6.5 Setting the LAN Interface

### LAN Interface

The 8835-01 MEMORY HiCORDERs provide the LAN functions below by using a LAN card inserted in the PC card slot.

### Supporting the 9333

When using the HIOKI 9333 LAN COMMUNICATOR, you can remotely control the 8835-01 on a PC or use the Auto Save function to save 8835-01 data on a PC via the 9333. For details, refer to the instruction manual provided with the 9333.

### Communications Command

The 8835-01 can be operated using common RS-232C/GPIB communications commands. The 8802 port is set as the command input port by default. To control the 8835-01, create a program and connect TCP via this port. For details, see the Application Disk (CD-R.)

### Compatible LAN Card

The LAN cards below are compatible with the 8835-01. (As of April 2003)

HIOKI 9578 10BASE-T LAN CARD \*

KOREGA Fether II PCC-TXD

For the latest information, visit the HIOKI website.

\*: Sales of the HIOKI 9578 10BASE-T LAN CARD have been discontinued.

Please use the commercially available LAN cards recommended by HIOKI.

### Setting

This section describes the setting procedure.

Set up the 8835-01 and connect the cable in the sequence below.

1. Insert a LAN card.
2. Set up the LAN parameters in "SYSTEM 4." (Do not connect the cable yet.)  
For details, see "Setting Individual Parameters" below.
3. After setting all the parameters, press F5 [Enter].
4. Connect the LAN cable to the 8835-01 and the network.

Be sure to make the settings above before connecting the 8835-01 to the network. Note that making these settings with the 8835-01 connected to the network may result in illegal information being sent to the network-for example, if the same IP address as that of another device on the network is selected.

### Preparations for Setting Parameters

When connecting to an existing network, the following parameters must be set up. Ask the administrator (department) of the network system to assign the following in advance:

- \* Host name and address of the 8835-01
  - Host name (up to 12 characters) : \_\_\_\_\_
  - IP address : \_\_\_\_\_
  - Subnet mask : \_\_\_\_\_
- \* Gateway
  - Gateway : Used/not used
  - IP address (when using gateway) : \_\_\_\_\_
- \* TCP/IP Port No. : X (default: 880X)  
 (Specify the three leftmost digits of the four digits. Numbers 0 to 9 in the least significant digit are used by the 8835-01 or reserved. Specify the port No. when default numbers 8800 to 8809 are not available.)

When setting up a network when only using a PC and recorders, not connecting to an existing network, for example, set the parameters as shown below.

IP address of PC : 192.168.0.1  
 IP address of 1st recorder : 192.168.0.2  
 2nd : 192.168.0.3  
 3rd : 192.168.0.4  
 4th : 192.168.0.5

Host name : Enter the desired name (each host name must be unique).  
 Subnet mask : 255.255.255.0  
 Gateway : OFF  
 Port No. : 880x

### Setting Individual Parameters

Once the LAN card is inserted, setting parameters appear on the SYSTEM 4 INTERFACE screen as shown below. Move the cursor to a parameter you want to set up. After making all necessary setting changes, press F5 [Enter] to confirm. Otherwise, the changes will not be reflected.

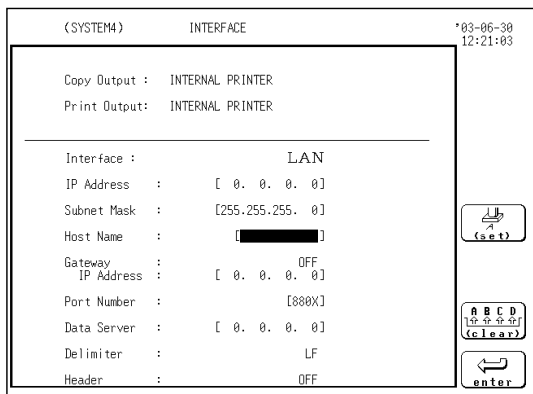

### Host Name

Set the name to represent the 8835-01 on the network. Choose a unique name that is different from those of other devices on the network. When using the 9333 LAN COMMUNICATOR, note that the host name is used to identify a directory on the PC.

### IP Address

Set the IP address of the 8835-01.

The IP address is used to identify individual devices on a network. Set a unique address that is different from those of other devices on the network.

### Subnet Mask

Subnet mask is used to divide an IP address into a network address and host address. Set the subnet mask the same way that subnet masks of other devices on the network are set up.

### Gateway ON/OFF and IP Address

Set the default gateway (default router).

Turn this ON and specify the IP of the device serving as a gateway when the 8835-01 communicates with a device (PC) on a network other than its own network. When the PC is on the same network, use the default gateway of the PC. When the 8835-01 is connected one-to-one with a PC or both are connected to the same hub, a gateway is not necessary. Turn it off.

### Data Acquisition Server IP

Specify the PC that runs the 9333 LAN COMMUNICATOR, with which the 8835-01 communicates. This setting is required for acquiring data using the 9333 LAN COMMUNICATOR.

When acquiring data using the 9333:

- \* To send measurement data (saved by using the Auto Save function) to the 9333, set Media on Status 1 screen to COMMUNI (LAN). (Real-time transfer of measurement data is not available.)
- \* To send an Auto Print image to the 9333, set Auto Print destination on Status 1 screen to COMMUNI (LAN).
- \* To send parameter calculation results to the 9333, set Result Save on Status 3 screen to COMMUNI (LAN).
- \* To send a screen image by using the  key, set Copy Destination on System 4 screen to COMMUNI (interface).
- \* To send a print image by using the  key, set Output Destination on System 4 screen to COMMUNI (interface).

### Port No.

The 8835-01 uses TCP/IP for communications. TCP/IP allows multiple connections for different types of communications. A port number identifies each connection. The 8835-01 uses port numbers 8800 to 8809.

- \* 8800 (8835-01 as the server.) : Used by the 9333 remote control application.
- \* 8801 (8835-01 as the client) : Used by the 9333 data acquisition application.
- \* 8803 (8835-01 as the server) : Used with communications commands.
- \* 8802 to 8809 : Reserved

You need not edit the port number setting, unless some ports are not available due to security reasons or not available on the PC with which the 8835-01 communicates.

This sets the three leftmost digits only. The rightmost digit (from 0 to 9) is used by the 8835-01 or reserved.

**Delimiter and Header ON/OFF**

Used when applying control by using communications commands.

Header ON/OFF sets whether to add a header in the response to a command.

Delimiter sets whether to use LF or CR+LF for the response to a command.

Both LF and CR+LF are accepted in command transmission. Communications commands are transmitted by connecting to port 8802 (default) of the 8835-01 using TCP and sending a character string.

**Connection**

After completing the setting above, connect the devices.

\* Connecting the 8835-01 to an existing network

Connect the LAN connector of the 8835-01 to the hub using a straight LAN cable or the 9642 LAN CABLE.

\* Connecting the 9941/42 to a PC one-to-one

A cross cable or straight cable and a cross connector are required. (The 9642 straight cable is supplied with a cross connector.)

A 100BASE cable is required for connecting to a 100BASE network using the 100BASE card.

## 9.7 Initialization [ INITIALIZE ]

Setting the clock (TIME SET), clearing waveform data (DATA INITIALIZE), and initialization of setting items (SYSTEM RESET) are available.

### Method 1 Screen: SYSTEM 5 (INITIALIZE)

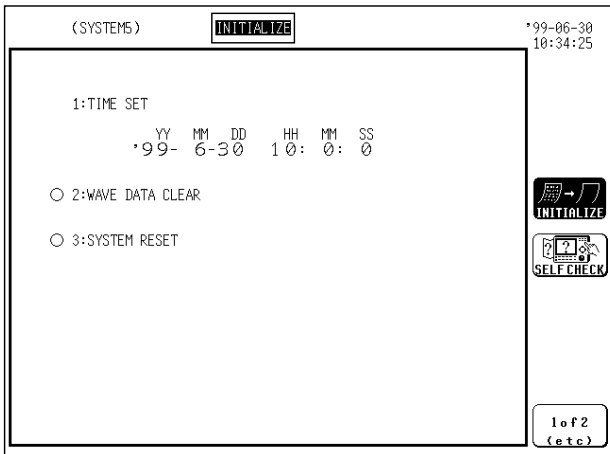

1. Press the **SYSTEM** key to call up the INITIALIZE screen.
2. Move the flashing cursor to the setting item, and press the function key to make the selection.

For details on items, see Sections 9.7.1 to 9.7.3.

### 9.7.1 Setting the Clock [ TIME SET ]

- This unit incorporates a calendar with automatic leap year compensation and 24-hour clock.
- The clock is used for the following functions:
  - Display of year/month/day/hour/minutes/seconds on the screen
  - Timer trigger function
  - Trigger time list printout

### Method 1 Screen: SYSTEM 5 (INITIALIZE)

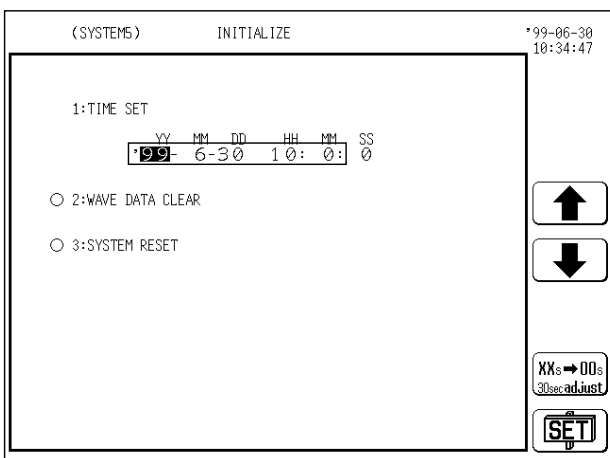

1. Press the **SYSTEM** key to call up the INITIALIZE screen.
2. Move the flashing cursor to the year, month, day, hour, minute items of (1) TIME SET, as shown in the figure on the left, and use the JOG control or the function keys to make the settings.
  - ↑ : Value up
  - ↓ : Value down
3. Press **F5** [ SET ] to start the clock. Seconds are reset to 00.

**Method 2** Screen: SYSTEM 5 (INITIALIZE)  
 (For correcting errors of less than 1 minute)

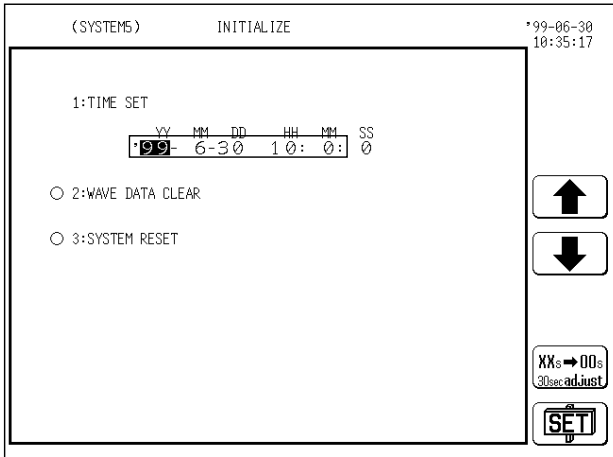

1. Press the **SYSTEM** key to call up the INITIALIZE screen.
2. Move the flashing cursor to any of the year, month, day, hour, minute items of (1) TIME SET, as shown in the figure on the left.
3. Press **F4** [30secadjust] to make the setting.  
 When **F4** [30secadjust] is pressed, the seconds are handled as follows.  
 00 - 29 seconds: Minutes are unchanged and seconds are reset to 00.  
 30 - 59 seconds: Minutes are advanced by 1 and seconds are reset to 00.

### 9.7.2 Clear Waveform Data [ WAVE DATA CLEAR ]

Clears and initializes waveform data stored in memory.

**Method** Screen: SYSTEM 5 (INITIALIZE)

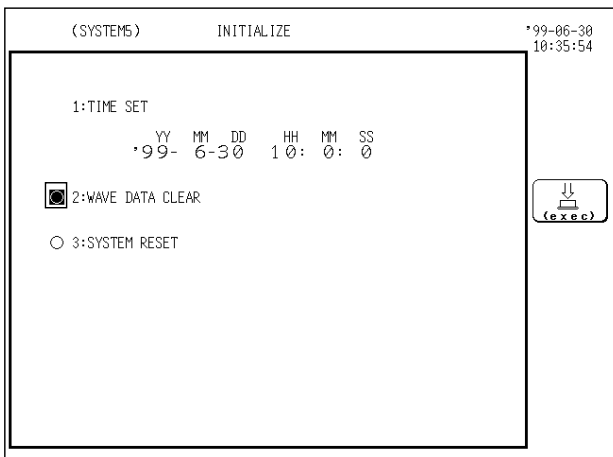

1. Press the **SYSTEM** key to call up the INITIALIZE screen.
2. Move the flashing cursor to (2) WAVE DATA CLEAR, as shown in the figure on the left, and make the setting.
3. Press **F1** [exec].

### 9.7.3 System Reset [ SYSTEM RESET ]

- Resets all settings other than communication-related settings (GP-IB, RS-232C, LAN) to the factory default values.
- The same effect can be achieved by turning power to the unit on while holding down the **STOP** key.

**Method** Screen: SYSTEM 5 (INITIALIZE)

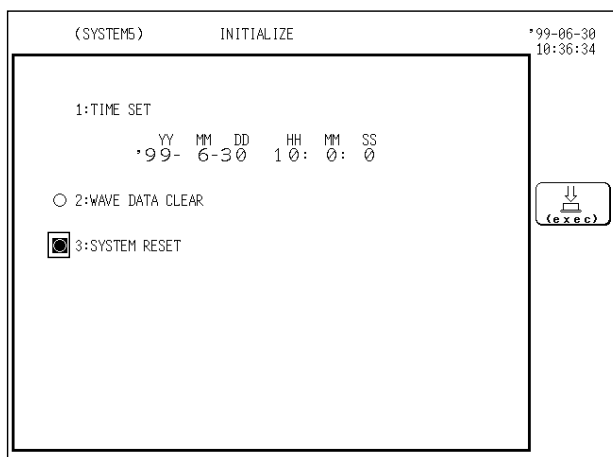

1. Press the **SYSTEM** key to call up the INITIALIZE screen.
2. Move the flashing cursor to the (3) SYSTEM RESET item, as shown in the figure on the left, and make the setting.
3. Press **F1** [exec].

**NOTE**

To reset all settings, including communication-related settings, to the factory default values, turn the power on while simultaneously pressing the START and **STOP** keys.

## 9.8 Self Check

The self-check routine of this unit includes the following five items.

- (1) ROM/RAM check
- (2) Printer check
- (3) Display check
- (4) Key check
- (5) PC card check

**Method** Screen: SYSTEM 6 (SELF CHECK)

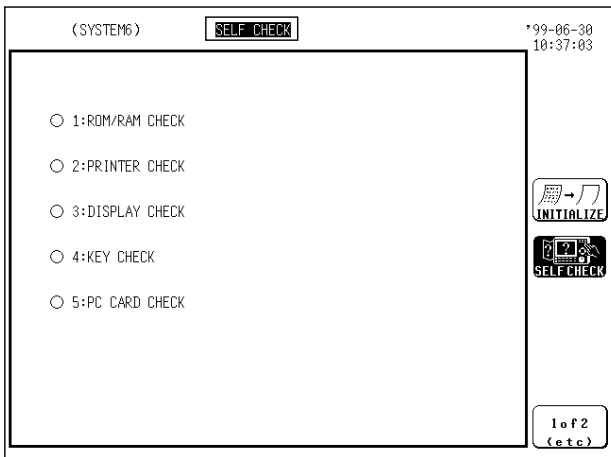

1. Press the **SYSTEM** key to call up the SELF CHECK screen.
2. Check each item. See Sections 9.8.1 to 9.8.5.

**NOTE**

When the result of a self-check is "NG", or if another problem is observed during the test, the unit should be returned for servicing.

### 9.8.1 ROM/RAM Check

- This test checks the internal memory (ROM and RAM) of the 8835-01.
- The test is non-destructive; it does not affect the contents of RAM.
- The result is displayed as follows. OK: Passed, NG: Failed

**Method** Screen: SYSTEM 6 (SELF CHECK)

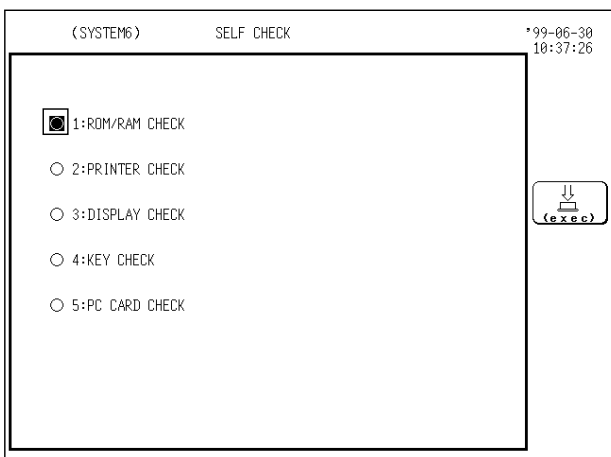

1. Move the flashing cursor to the position shown in the figure on the left.
2. Press **F1** [exec] to check the ROM and RAM.

**NOTE**

- During the test, all keys are disabled.
  - When "OK" appears, the test result was normal.
3. When the test is completed, press any key to return to the self-test setting screen.



## 9.8.2 Printer Check

- This test checks the printer operation.
- The printer head is cleaned.

**Method** Screen: SYSTEM 6 (SELF CHECK)

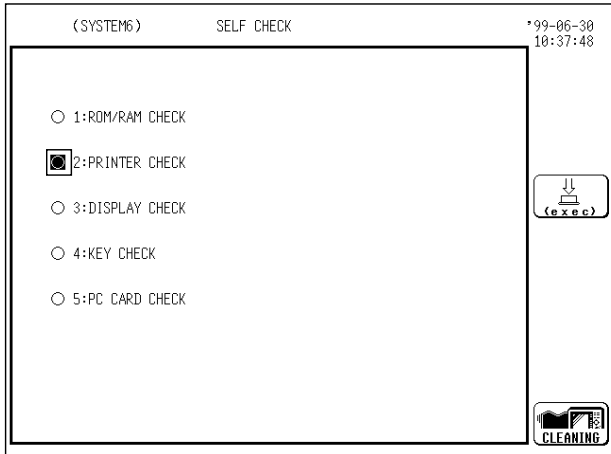

1. Move the flashing cursor to the position shown in the figure on the left.

2. Use the function keys to make the selection.



: Check the printer operation.



: Clean the printer head.

Hold down this key for approx. 5 seconds.

**NOTE**

To cancel the test pattern printout, press the **STOP** key.

## 9.8.3 Display Check

- This test checks the display.
- Two check patterns (solid-color display check <sup>(\*)</sup> and gradation check <sup>(\*\*)</sup>) are available.

\*1: Solid-color display check

Display solid red, green, blue, black, and white screens, respectively.

\*2: Gradation check

Display the gradated colors red, green, and blue, respectively.

**Method** Screen: SYSTEM 6 (SELF CHECK)

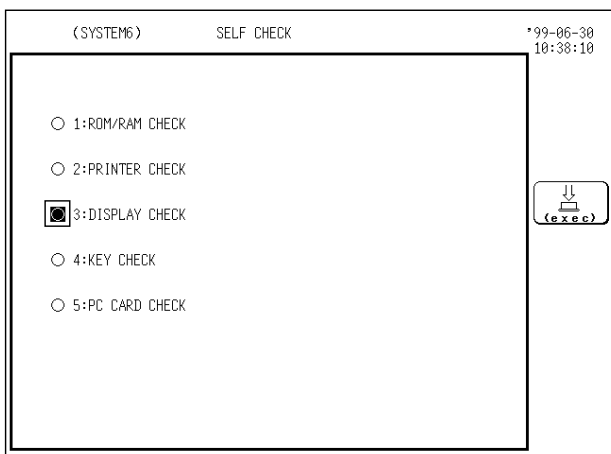

1. Move the flashing cursor to the position shown in the figure on the left.

2. Press **F1** [exec] to check the display.

3. Press any key to move to the next check.

## 9.8.4 Key Check

This test checks the key operation.

**Method** Screen: SYSTEM 6 (SELF CHECK)

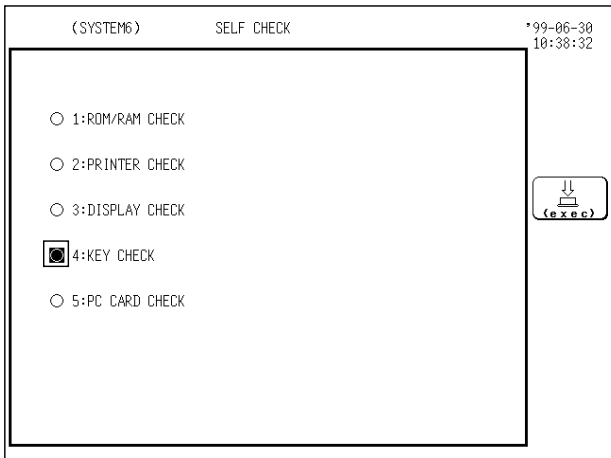

1. Move the flashing cursor to the position shown in the figure on the left.
2. Press  [exec] to start the test.
3. Press any key on the front panel, and the corresponding field on the display changes to reverse.
4. Turn the JOG and SHUTTLE controls at least one turn fully clockwise and counterclockwise and press each of the keys at least once, and the test is completed.

**NOTE**

- If any key is defective, the key test cannot not be completed normally.
- In this case, press the  key and the  key together to return to the SELF CHECK screen.
- The  key and  key also serve for testing the LED function.

## 9.8.5 PC Card Check

This test checks the PC card and displays the information.

**Method** Screen: SYSTEM 6 (SELF CHECK)

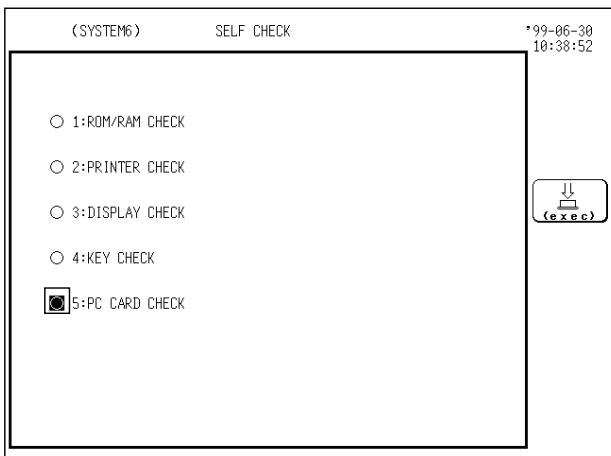

1. Move the flashing cursor to the position shown in the figure on the left.
2. Press  [exec] to check the PC card.

**NOTE**

In the case of the interface card, its identification is displayed.

---

# Chapter 10

## Printout of Waveform Data

---

---

### 10.1 Overview

- Waveform data can be printed out in two formats: waveform or numeric.
- A smooth print function is available for waveform printout (memory recorder function only).
- The following printing modes are available:
  - Manual print
  - Auto print
  - Real-time print
  - Partial print
  - Screen hard copy
  - List print
  - Report print
  - External printer

## 10.2 Selecting Waveform or Numeric Print

- This item lets the user select waveform or numeric print.
- Making this setting is required for manual print, auto print, real-time print, and partial print.

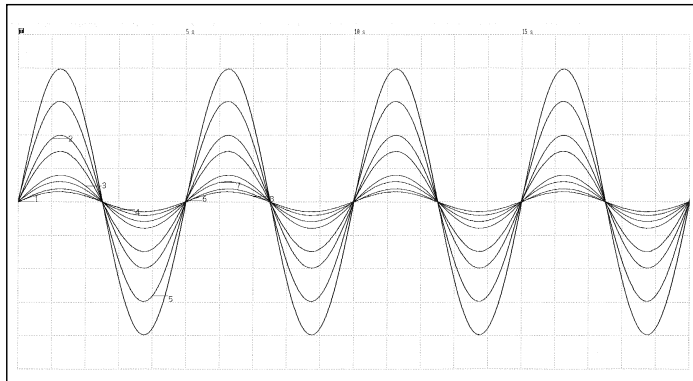

Waveform

(time)	CH5	CH6	CH7	CH8
0 s	0.250V	1.250V	3.1250V	-6.250V
1.00 s	377.50mV	388mV	6.250V	9.3750V
2.00 s	233.13mV	236.75mV	237.5mV	231.25mV
3.00 s	-233.13mV	-236.75mV	-237.5mV	-231.25mV
4.00 s	-377.50mV	-388mV	-6.250V	-9.3750V
5.00 s	0 V	1.250V	3.1250V	-6.250V
6.00 s	377.50mV	388mV	6.250V	9.3750V
7.00 s	233.13mV	236.75mV	237.5mV	231.25mV
8.00 s	-233.13mV	-236.75mV	-237.5mV	-231.25mV
9.00 s	-377.50mV	-388mV	-6.250V	-9.3750V
10.00 s	0 V	1.250V	3.1250V	-6.250V
11.00 s	377.50mV	388mV	6.250V	9.3750V
12.00 s	233.13mV	236.75mV	237.5mV	231.25mV
13.00 s	-233.13mV	-236.75mV	-237.5mV	-231.25mV
14.00 s	-377.50mV	-388mV	-6.250V	-9.3750V
15.00 s	0 V	1.250V	3.1250V	-6.250V
16.00 s	377.50mV	388mV	6.250V	9.3750V
17.00 s	233.13mV	236.75mV	237.5mV	231.25mV
18.00 s	-233.13mV	-236.75mV	-237.5mV	-231.25mV
19.00 s	-377.50mV	-388mV	-6.250V	-9.3750V
20.00 s	0 V	1.250V	3.1250V	-6.250V

Numeric

### Waveform print

**Method** Screen: STATUS 1 in each function

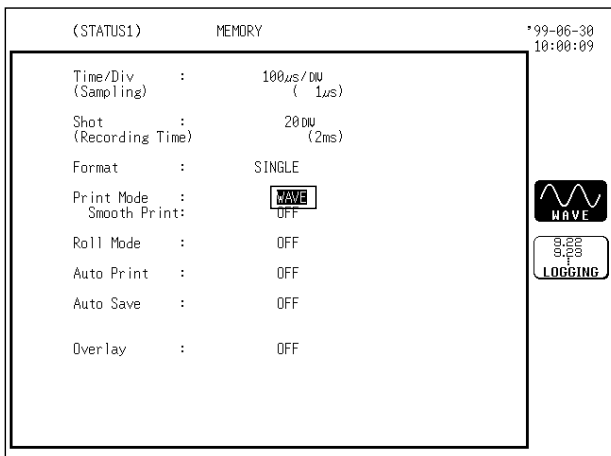

1. Press the **STATUS** key to call up the STATUS 1 screen.
2. Move the flashing cursor to the print mode item, as shown in the figure on the left.
3. Use the function keys to select waveform.

: Perform waveform print

: Perform numeric print

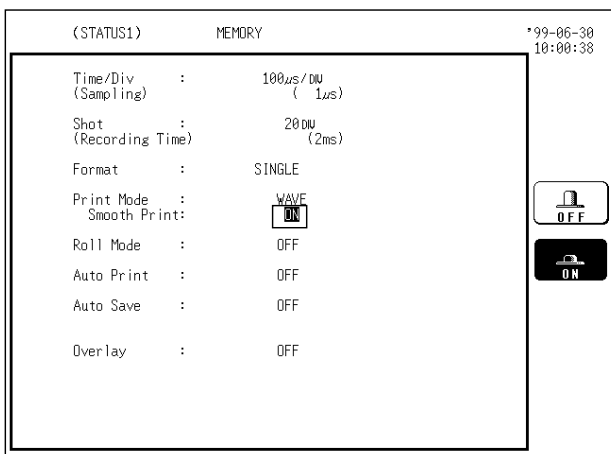

4. In the memory recorder function, the smooth print function can be set. Use the function keys to make the selection.

: Smooth printing is disabled.

: Smooth printing is enabled.

## Numeric print

**Method** Screen: STATUS 1 in each function

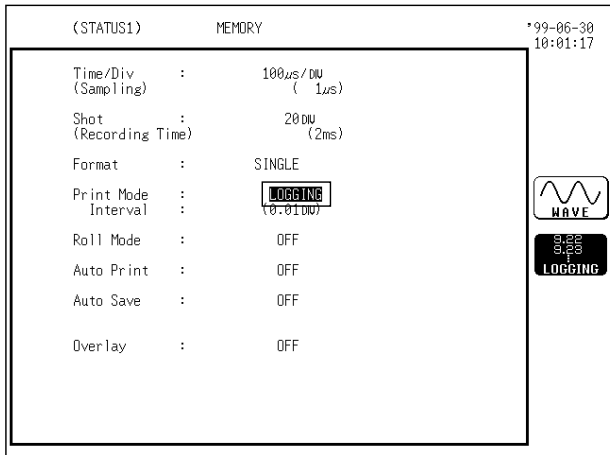

1. Press the **STATUS** key to call up the STATUS 1 screen.
2. Move the flashing cursor to the print mode item, as shown in the figure on the left.
3. Use the function keys to select numeric data.

: Perform waveform print

: Perform numeric print

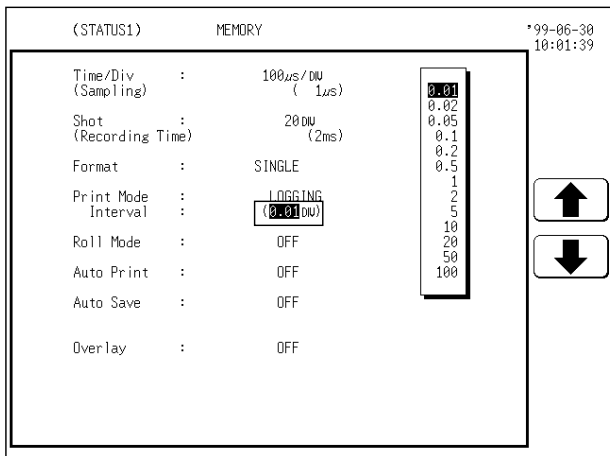

4. Move the flashing cursor to the print interval item.
5. Use the JOG control or the function keys to select the print interval.

: Move the cursor up in the selection window.

: Move the cursor down in the selection window.

### NOTE

- When the print interval longer than the recording length is set, only the first do is printed.
- In the recorder and RMS recorder functions (except 5 s/DIV), the maximum and minimum values are printed (see Section Appendix 3.4).
- In the recorder and RMS recorder functions, the print interval is 1 to 100 DIV before a waveform is captured. The print intervals of 0.01 to 0.5 DIV can be selected after a waveform is captured.

## 10.3 Using the Smooth Print Function (Memory Recorder Function Only)

- When waveform print is selected, the smooth print function can be used.
- When smooth print is enabled, density along the time axis increases by a factor of 2, to achieve a smooth waveform shape. Print speed will decrease.
- This option can be selected when using the memory recorder function.

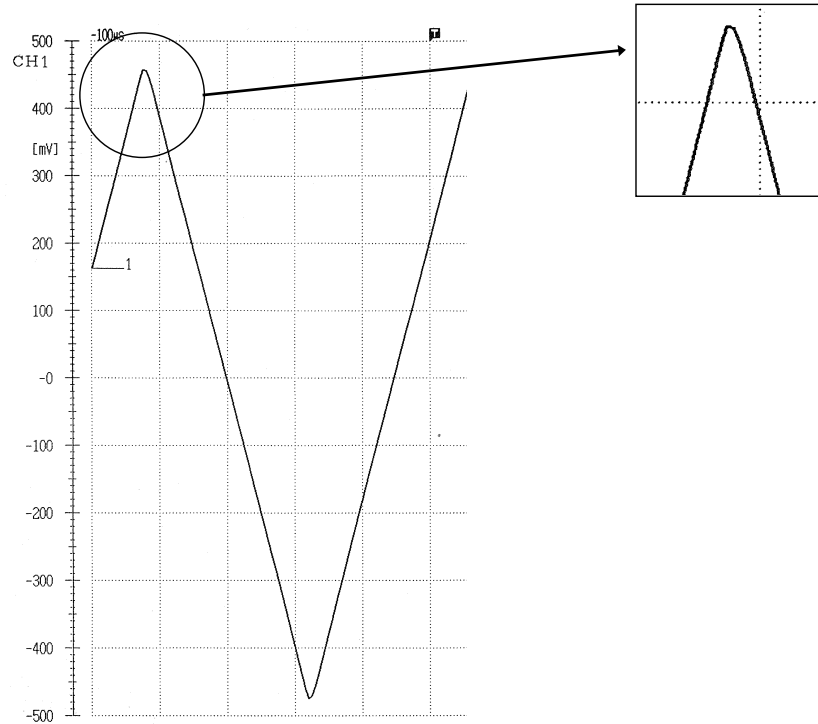

Smooth print OFF

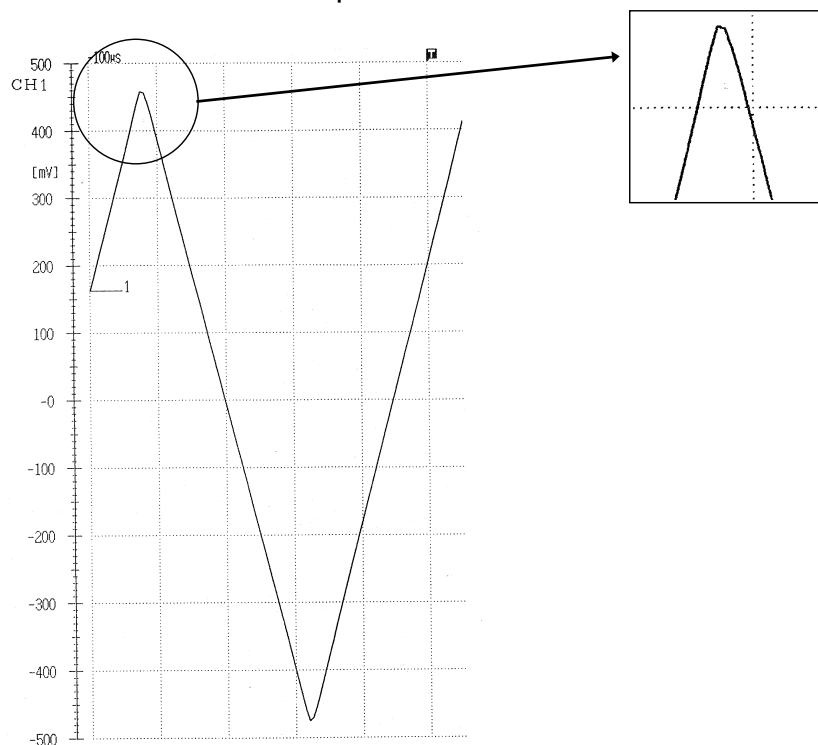

Smooth print ON

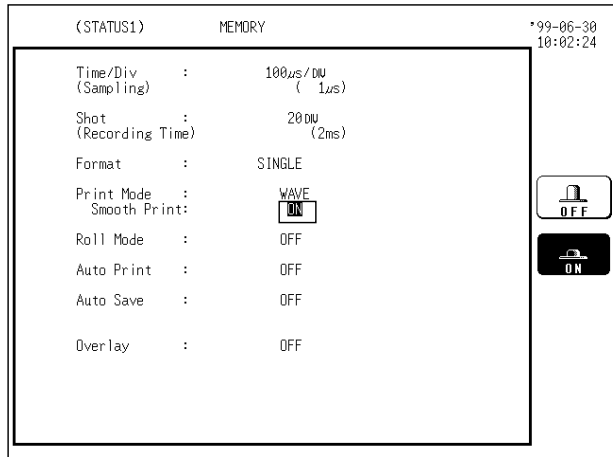
**Method** Screen: STATUS 1

1. Press the **STATUS** key to call up the STATUS 1 screen.
2. Move the flashing cursor to the smooth print item, as shown in the figure on the left.
3. Use the function keys to make the selection.

 : Normal printing is carried out.

 : Smooth printing is enabled.

## 10.4 Setting the Grid

- Selects the type of grid shown on the display screen and drawn on the recording paper.
- The following five settings are available: OFF, standard, fine, standard (dark), fine (dark).
- The display on the display screen is as follows:  
Standard, fine: standard  
Standard (dark), fine (dark): standard (dark)

### Method Screen: SYSTEM 1 (SET UP)

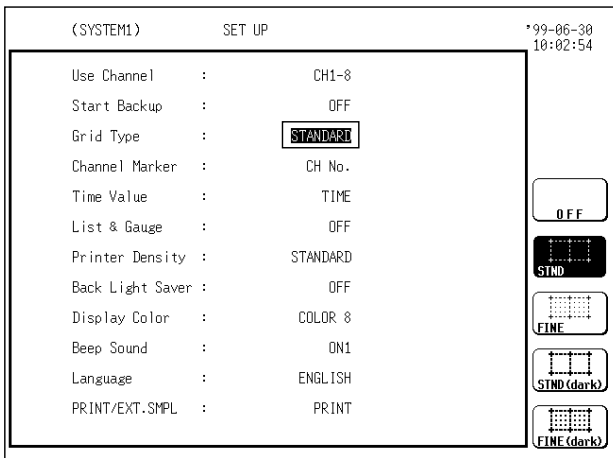

1. Press the **SYSTEM** key to call up the SET UP screen.
2. Move the flashing cursor to the position shown in the figure on the left.
3. Press the function key to make the setting.

- : No grid on display and printout
- : Standard grid on printout
- : Fine grid on printout
- : Standard (dark) grid on printout
- : Fine (dark) grid on printout

## 10.5 Channel Marker Function

The channel numbers or comments are printed together with the waveform on the recording paper.

### Method Screen: SYSTEM 1 (SET UP)

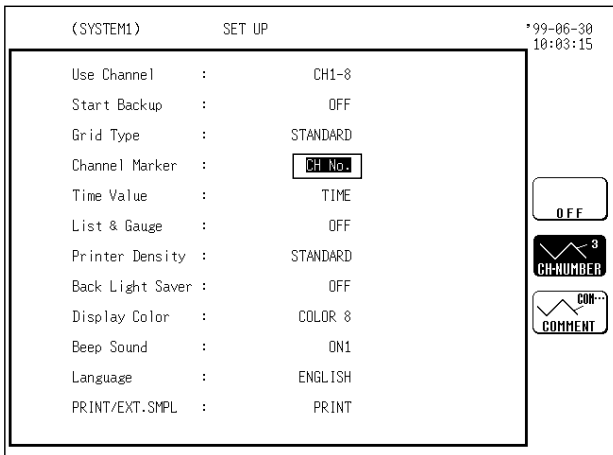

1. Press the **SYSTEM** key to call up the SET UP screen.
2. Move the flashing cursor to the position shown in the figure on the left.
3. Press the function key to make the selection.

- : Channel numbers will not be printed for the waveform on the recording paper.
- : Channel numbers will be printed for the waveform on the recording paper.
- : Comments set for each channel will be printed for the waveform on the recording paper (refer to Section 9.5).



## 10.6 Adding Comment to Printout

Two types of comment are available.

### (1) Title comment input

Title comments of up to 40 characters can be included on the recording paper. If "COMMENT" or "SET & COMMENT" is selected, this title comment will be included on the recording paper in all functions.





### (2) Input of comments for each channel

Comments of up to 40 characters can be included on the recording paper on each channel.

If "COMMENT" or "SET & COMMENT" is selected, this comment will be included on the recording paper in all functions.

### Method Screen: SYSTEM 3 (COMMENT)

1. Press the **SYSTEM** key to call up the COMMENT screen.
2. Move the flashing cursor to the position shown in the figure on the left.
3. Use the function keys to make the selection.

-  : Standard printout is performed.
-  : Setting item is printed.
-  : Comment is printed.
-  : Both item and comment are printed.

4. When [ COMMENT ] or [ SET&CMT ] is selected, enter the comment.  
Only the comment is entered for each logic channel.  
For details, see Section 9.5.

# 10.7 Printing Procedure

The following printing modes are available:

- Manual print ( **PRINT** key, DISPLAY screen)
- Auto print (set with STATUS screen)
- Real-time print (set with STATUS screen)
- Partial print (A/B cursors, **PRINT** key, DISPLAY screen)
- Screen hard copy ( **COPY** key)
- List print ( **PRINT** key, any screen except DISPLAY screen)
- Report print ( **FEED** key + **COPY** key, DISPLAY screen)
- External printer (print by the external printer)

## 10.7.1 Manual Print (All Functions)

This mode serves to print waveform data from the internal memory.

Memory recorder:

Measurement data from one measurement (entire recording length) are printed.

Recorder:

Measurement data stored in memory before the end of measurement are printed (2000 divisions max.).

RMS Recorder:

Measurement data stored in memory before the end of measurement are printed (2000 divisions max.).

**Method** Screen: DISPLAY

After the measurement is completed, press the **PRINT** key.

- Since data are stored, they can be printed as often as desired.
- When magnification/compression was used, the print reflects this condition.

**NOTE**

Information about settings and scale can also be printed at the same time (see Section 9.3.6).

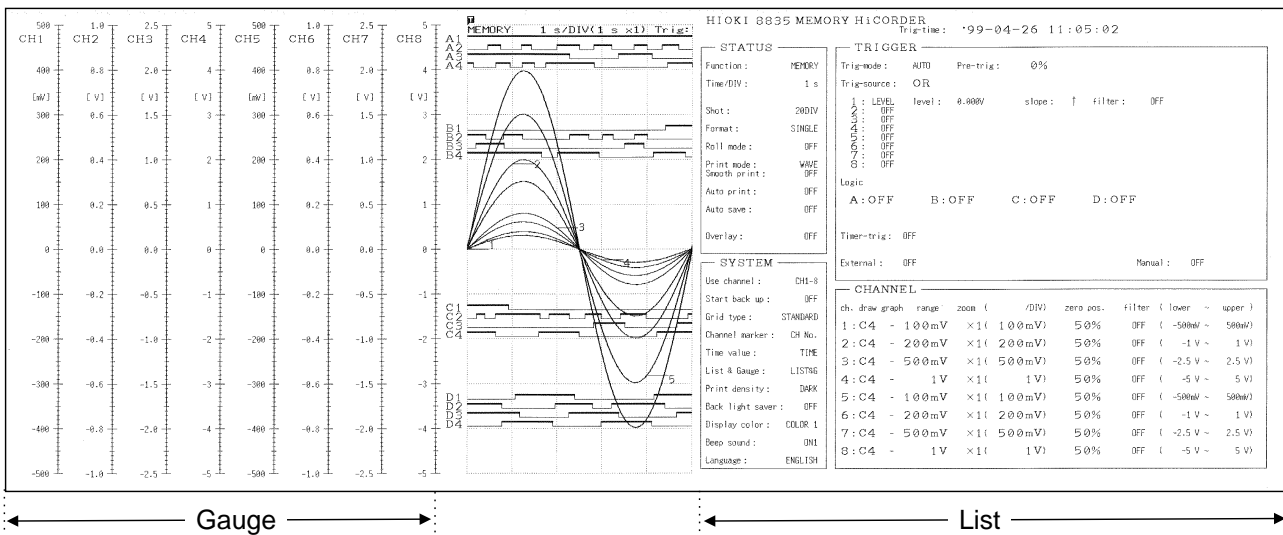

Both the list and gauge functions are used.

## 10.7.2 Auto Print (Memory Recorder)

Print is carried out automatically after a waveform has been captured for the specified recording length.

**Method** Screen: STATUS 1

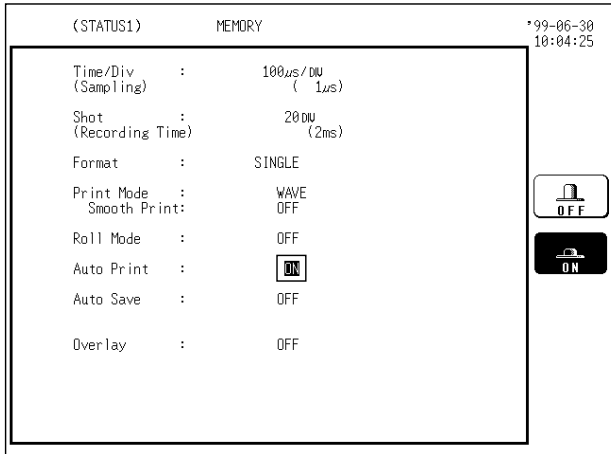

1. Press the **STATUS** key to call up the STATUS screen 1.

2. Move the flashing cursor to the auto print item, as shown in the figure on the left.

3. Use the function keys to make the selection.

 : Disable auto print

 : Enable auto print

4. Press the **START** key to start the measurement.

Print is carried out automatically after a waveform has been captured for the specified recording length.

### NOTE

- Information about settings and scale can also be printed at the same time (see Section 9.3.6).
- If the A/B cursors are used, partial save is applied (see Section 10.7.4).



### 10.7.3 Real-Time Print (Recorder, RMS Recorder)

The input waveform and data are printed continuously in real time.

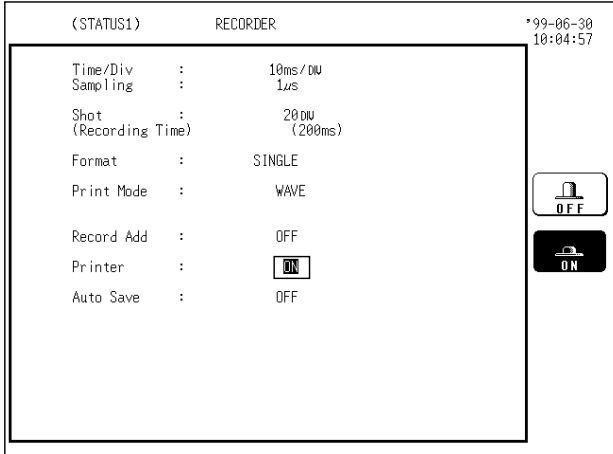
**Method** Screen: STATUS 1



1. Call up the STATUS screen 1.
2. Move the flashing cursor to the printer item, as shown in the figure on the left.
3. Use the function keys to make the selection.

 : Disable real-time print print  
 : Enable real-time print print

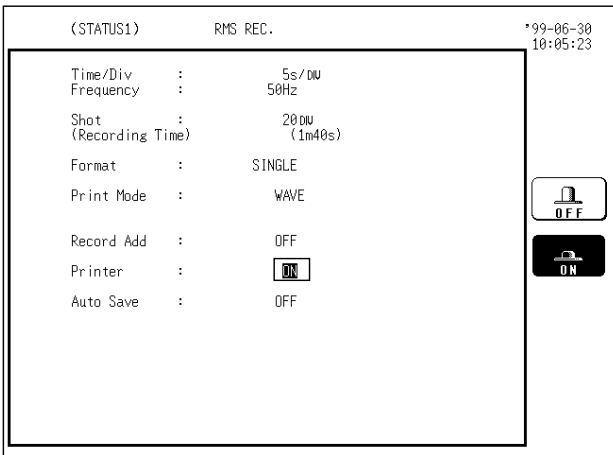

4. When measurement starts, waveform appears on screen and print starts.

**NOTE**

- At a time axis range setting of 200 ms/DIV or faster, the waveform data will be printed out later.
- While the printer always outputs the data at the measurement magnification in recording mode, the waveform on the screen is reduced in size at the ratio shown in the table below, depending on the time-axis range.

Range	Compression ratio
50 ms/DIV	× 1/2
20 ms/DIV	× 1/10
10 ms/DIV	× 1/20

- When time axis range is between 10 ms - 200 ms/DIV and recording length is set to CONTINUOUS in recorder function, printer defaults to OFF.
- If the A/B cursors are used, partial save isn't applied.

## 10.7.4 Partial Print (All Functions)

- This function prints the waveform between the A and B cursors (vertical or trace cursors).
- Memory recorder  
Specified range (out of entire data recorded from a measurement) is printed.
- Recorder, RMS Recorder  
Specified range (out of last 2000 divisions (magnification:  $\times 1$ ) of data in memory) is printed.
- The function is available also when the A/B cursors are currently outside the range displayed on screen.
- For details regarding the use of the A/B cursors, refer to Section 11.2.
- Printing is possible also when the print format is currently set to "numeric".

Method Screen: DISPLAY

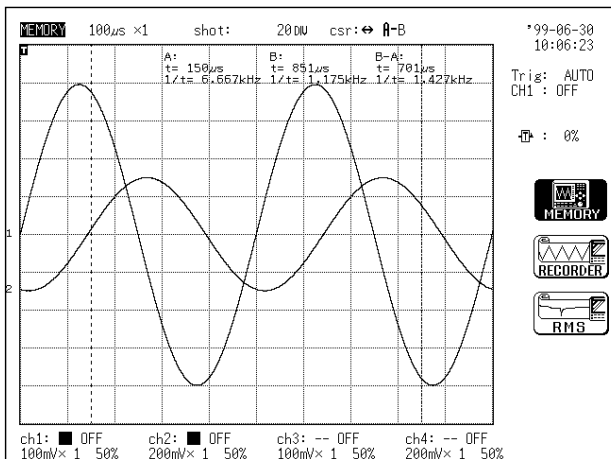

1. Position cursor A at the start point of the range to be printed.
2. Move cursor B to the right. When the cursor is at the rightmost edge of the screen, the waveform scrolls to the left, and cursor A scrolls with it.
3. Specify the end point of the range with cursor B. Then press the **PRINT** key. The specified range is printed, also if cursor A is currently off screen.

### NOTE

- The range is printed also if the positions of cursor A and cursor B are reversed.
- When only the cursor A is used, the waveform data from the position of cursor A to the end of the data is printed.

## 10.7.5 Screen Hard Copy (All Functions)

The display contents of the STATUS screen, CHANNEL screen, DISPLAY screen, SYSTEM screen, and FILE screen can be printed as is.

### Method

1. Call up the desired screen.
2. Press the COPY key.

**NOTE**

- The screen hard copy function is not available during measurement.
- The following four types of copy output destination are available.  
 Internal printer: Built-in printer  
 FD: Data are stored on floppy disk.  
 PC: Data are stored on PC card.  
 Communication: Data are sent using the interface.  
 See Section 9.6.1.

## 10.7.6 List Print (All Functions)

The settings for the various functions made with the STATUS screen, CHANNEL screen etc. can be printed in list format.

### Method

Screen: Respective function setting screen, except DISPLAY screen  
 While the setting screen (STATUS, CHANNEL, SYSTEM) is displayed, press the PRINT key.

**NOTE**

- The list to be printed contains the setup conditions for the acquired waveforms. Even if the settings are changed following wave acquisition, the contents of the list remain unchanged.
- Only data entered in channel of the list is in analog waveform.

HIOKI 8835 MEMORY HiCORDER				Trig-time: '99-06-07 10:48:37			
<b>STATUS</b>				<b>TRIGGER</b>			
Function:	MEMORY	Memory div:	OFF	Trig-mode:	SINGLE	Pre-trig:	0%
Time/DIV:	100us	Averaging:	OFF	Trig-source:	OR		
Shot:	20DIV	Wave comparison:	OFF	1: LEVEL	level: 0.000V	slope: ↑	filter: OFF
Format:	SINGLE	Measurement:	OFF	2: OFF			
Roll mode:	OFF	Wave calculation:	OFF	3: OFF			
Print mode:	LOGG			4: OFF			
Interval:	0.01DIV			5: OFF			
Auto print:	OFF			6: OFF			
Auto save:	OFF			7: OFF			
Overlay:	OFF			8: OFF			
				Logic			
				A: OFF	B: OFF	C: OFF	D: OFF
				Timer-trig:	OFF		
				External:	OFF	Manual:	OFF
<b>SYSTEM</b>				<b>CHANNEL</b>			
Use channel:	CH1-8	Print density:	DARK	ch. draw graph	range	zoom ( /DIV)	zero pos. filter ( lower ~ upper )
Start back up:	OFF	Back light saver:	OFF	1: C1	- 20mV	x1( 20mV)	50% OFF ( -100mV ~ 100mV)
Grid type:	STANDARD	Display color:	COLOR 1	2: C2	- 50mV	x1( 50mV)	50% OFF ( -250mV ~ 250mV)
Channel marker:	CH No.	Beep sound:	ON1	3: C3	- 100mV	x1( 100mV)	50% OFF ( -500mV ~ 500mV)
Time value:	TIME	Language:	ENGLISH	4: C4	- 200mV	x1( 200mV)	50% OFF ( -1V ~ 1V)
List & Gauge:	OFF	PRT/SMPL:	PRINT	5: C5	- 500mV	x1( 500mV)	50% OFF ( -2.5V ~ 2.5V)
				6: C6	- 1V	x1( 1V)	50% OFF ( -5V ~ 5V)
				7: OFF			
				8: OFF			

## 10.7.7 Report Print (All Functions)

- This function prints the waveform range shown on the display, along with the active settings.
- If the A and B cursors are displayed on the screen, they are also printed.
- When "COMMENT" or "SET & COMMENT" is set, the comments are also printed (see Section 9.5).

**Method** Screen: DISPLAY

Call up the desired display screen and press the **FEED** key and **COPY** key simultaneously. (Press and hold the **FEED** key and then press the **COPY** key.)

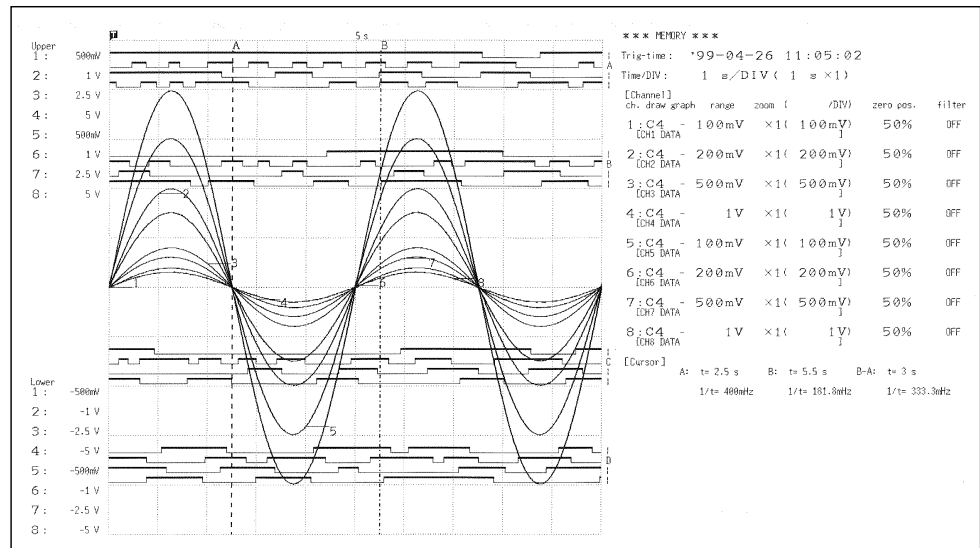
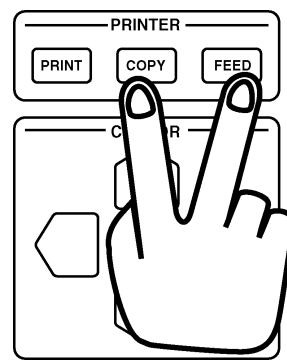
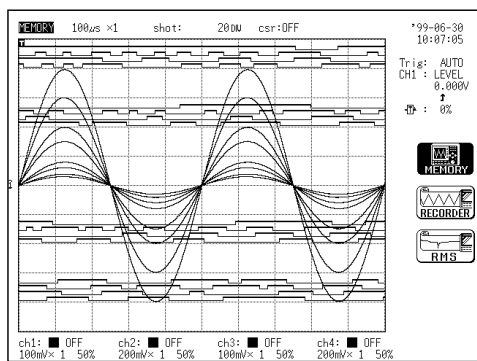

## 10.7.8 External Printer (Color Print)

Using the 9559 PRINTER CARD, waveform data can be output on A4-size sheets from the external printer in color or monochrome.

**PRINT** key: Prints out waveform data or numerical data.

**COPY** key: Prints out the screen hard copy.

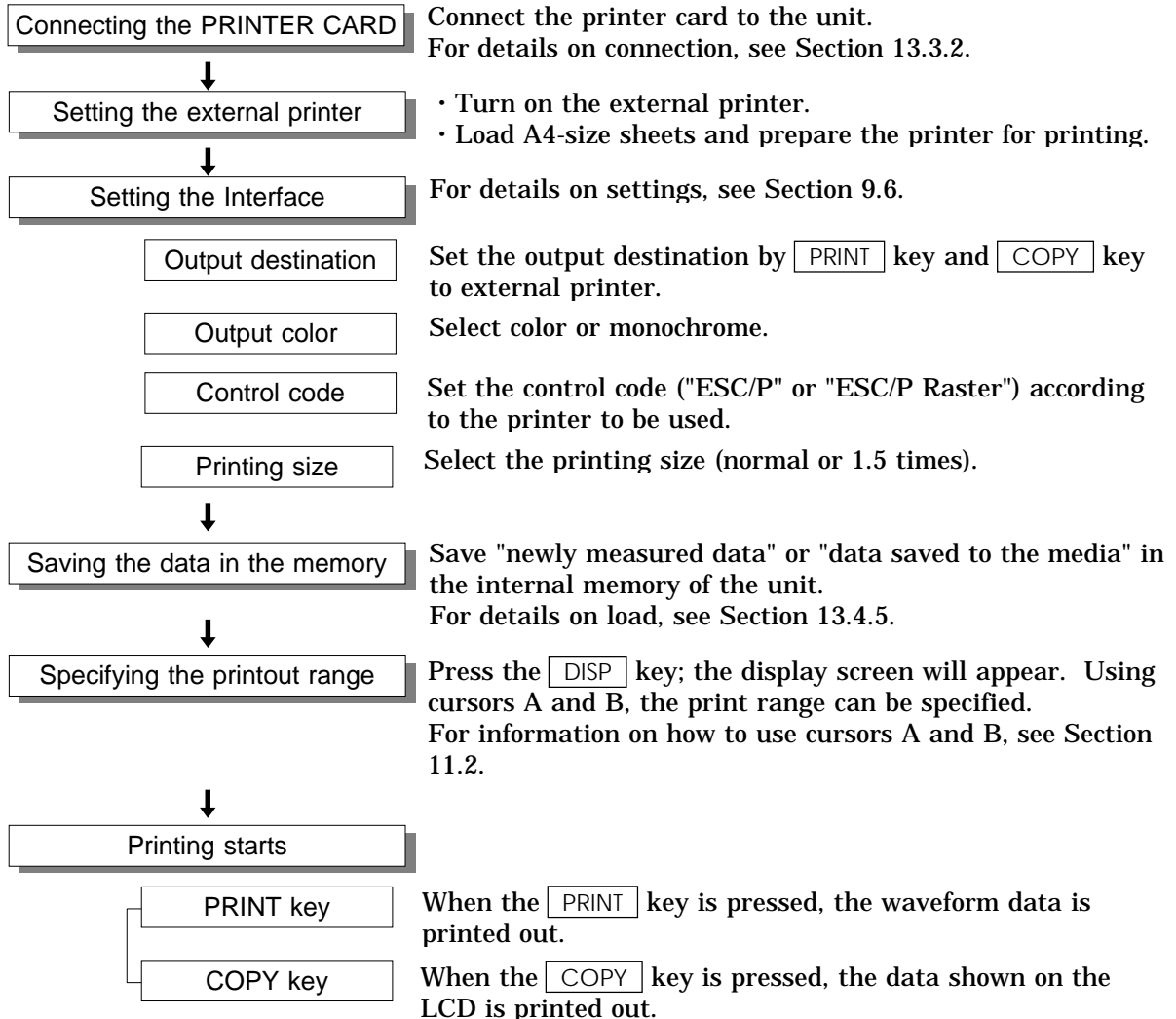

### NOTE

With respect to the following items, the external printer differs from the internal printer:

- The gauge is printed out for every page.
- When the display format is the X-Y screen, waveform data is printed out in monochrome.
- For details on settings, see Sections 9.6.1 and 9.6.2.



---

# Chapter 11

## Using the A/B Cursors / Waveform Scrolling

---

---

### 11.1 Overview

- The following three types of A/B cursors are available:
- Line cursor (vertical)
- Line cursor (horizontal)
- Trace cursor
- The scroll function can be used to view a waveform.

## 11.2 Using the A/B Cursors

- The A/B cursors can be used to read a time difference, frequency, or potential difference on screen. (When scaling is used, the difference is displayed in the scaling value. See Section 9.4.)
- The following three types of A/B cursors are available:
  - Line cursor (vertical): Used to read time, a period, or a frequency.
  - Line cursor (horizontal): Used to read a voltage value of the specified channel.
  - Trace cursor: Used to read the value at the point where the cursor crosses the waveform of the specified channel.
- If the A/B cursors are used, partial print and partial save are applied.

### 11.2.1 Line Cursor (Vertical, Horizontal) (All Functions)

The value at cursor A and cursor B, and the value between the two cursors can be determined.

Value	Vertical cursor		Horizontal cursor	
A or B	t	time from the trigger point	V	voltage difference from 0 V
	1/t	frequency taking t as the period		
B - A	t	time interval between the A and B cursors	V	voltage difference between the A and B cursors.
	1/t	frequency taking t as the period		

### 11.2.2 Trace Cursor

- The value at the point where the cursor crosses the waveform can be determined.
- The trace point moves on the waveform of the specified channel.
  - ① A or B value
    - t: Time from trigger point to trace point
    - V: Potential difference from 0 V
  - ② B - A value
    - t: Time difference between the trace points
    - V: Potential difference between the trace points
- In the recorder and RMS recorder functions (except 5 s/DIV), the maximum and minimum values are displayed (see Section Appendix 3.4).
- In additional recording, the junction between data is invalid data.

## 11.2.3 Using the Cursors

Method Screen: DISPLAY

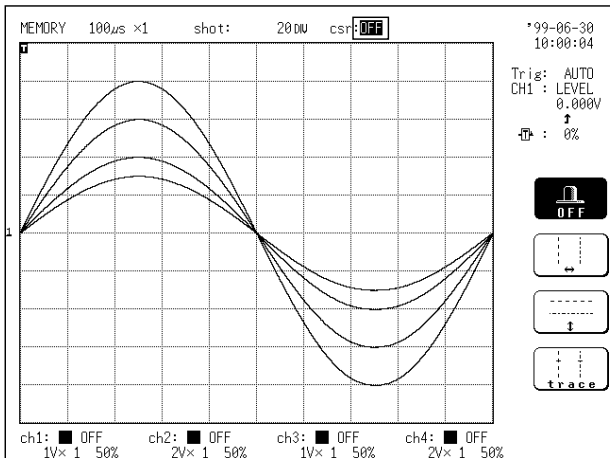

1. Move the flashing cursor to the csr item.
2. Use the function keys to select the cursor shape.

- : Disable A/B cursors
- : Line cursor (vertical: t, 1/t)
- : Line cursor (horizontal: V)
- : Trace cursor (the point where the cursor crosses the waveform)

### To use the line cursor (vertical)

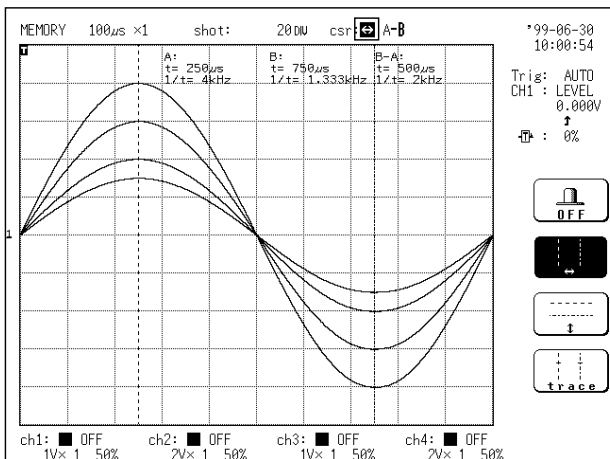

- (1) Select [  $\leftrightarrow$  ] (Line cursor, vertical) key.
- (2) Press the key so that the A.B CSR LED lights up.
- (3) Rotate the JOG control to move the cursor.

### To use the line cursor (horizontal)

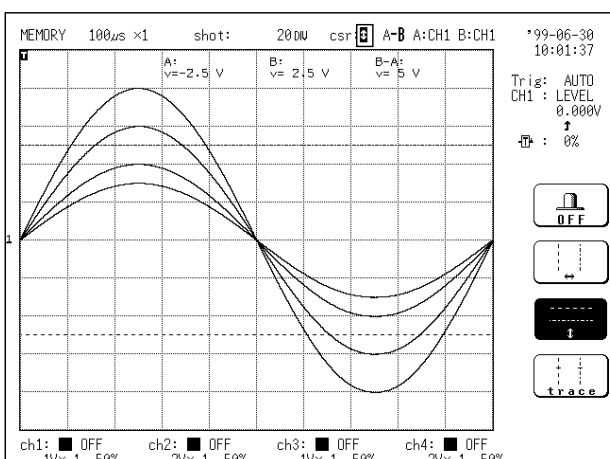

- (1) Select [  $\updownarrow$  ] (Line cursor, horizontal) key.
- (2) The channel select option appears. Use the flashing cursor to select the channel for which you want to read the voltage value with the A/B cursors. You can specify different channels for the two cursors.
- (3) Press the key so that the A.B CSR LED lights up.
- (4) Rotate the JOG control to move the cursor.

#### NOTE

- The channel select option does not appear when using the vertical line cursor.
- Only channels for which a waveform is being displayed can be specified.
- By specifying a different channel for the A and B cursors, a potential difference between the waveforms in the respective channels can be determined.

To use the trace cursor

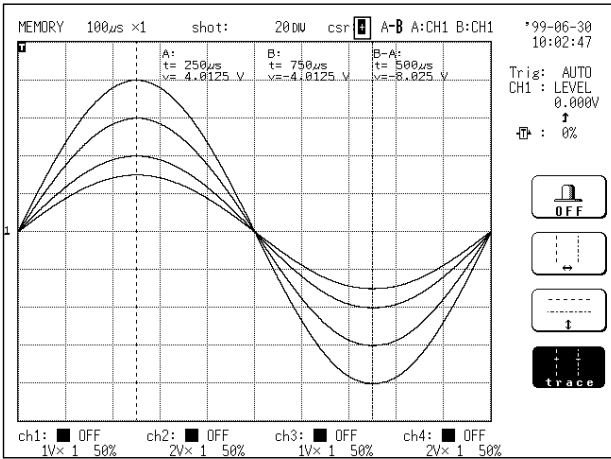

- (1) Select **F4** [ TRACE CURSOR ].
- (2) The channel select option appears. Use the flashing cursor to select the channel for which you want to read the trace point with the A/B cursors. You can specify different channels for the two cursors.
- (3) Press the **SELECT** key so that the A.B CSR LED lights up.
- (4) Rotate the JOG control to move the cursor.
  - t or V at the cursor position can be determined.
  - When the vertical cursor or trace cursor is used, cursor measurements are possible also when one of the cursors is currently off screen.

**NOTE**

When the **SELECT** key is used to activate the A/B cursor mode, the trace cursor can be used, also if it was set to OFF.

**Reference**

When the vertical cursor or the trace cursor is off screen, the **VIEW** key can be used to check the cursor position within the total recording length (see Section 3.1.7).

Moving the cursor

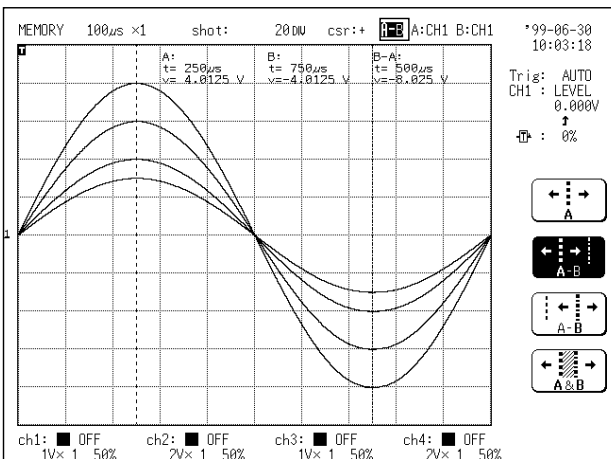

1. Move the flashing cursor to the position shown in the figure on the left.
2. Use the function keys to select the cursor to be moved.

- : Use one cursor only
- : Move the A cursor only
- : Move the B cursor only
- : Move both the A and B cursors

3. Rotate the JOG control to move the cursor. (If the A.B CSR LED does not light up, the cursor cannot be moved.)

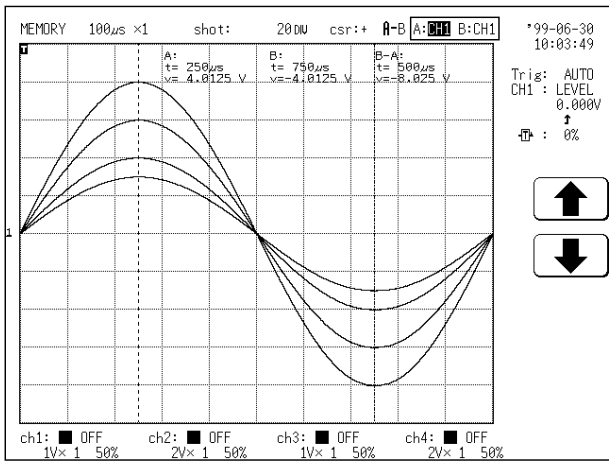

4. When the cursor is of the line-cursor (horizontal) or trace-cursor type, select the analog channel from which values are to be read. Use the function keys to make the selection.

: Channel number up

: Channel number down

Using A cursor only:

When ALL is selected, the value is to be read.

### Auto-scroll

- If turning the the SHUTTLE control fully and holding the control for a few seconds, the indication Auto scroll appears on the function key display and the waveform continues to scroll even if releasing the control.
- Auto-scroll is canceled by pressing any key.

# 11.3 Scrolling the Waveform

The waveform on the display can be scrolled horizontally.

**Method** Screen: DISPLAY

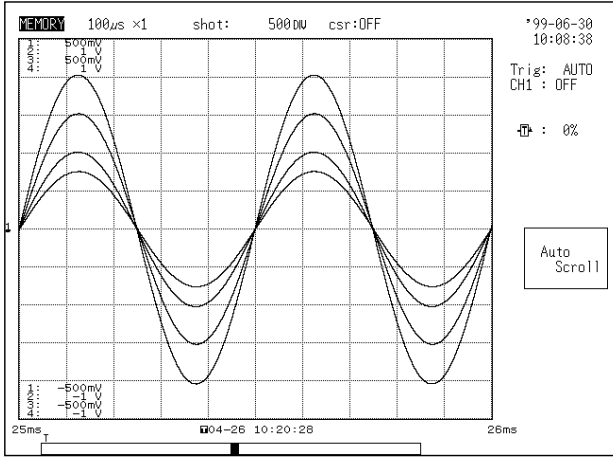

1. Press the **SELECT** key so that the WAVE LED lights up.
2. Use the JOG/SHUTTLE control to scroll the waveform.

## Auto-scroll

- If turning the the SHUTTLE control fully and holding the control for a few seconds, the indication Auto scroll appears on the function key display and the waveform continues to scroll even if releasing the control.
- Auto-scroll is canceled by pressing any key.

## Waveform scrolling

When the waveform is scrolled, the screen status and waveform position are as illustrated below.

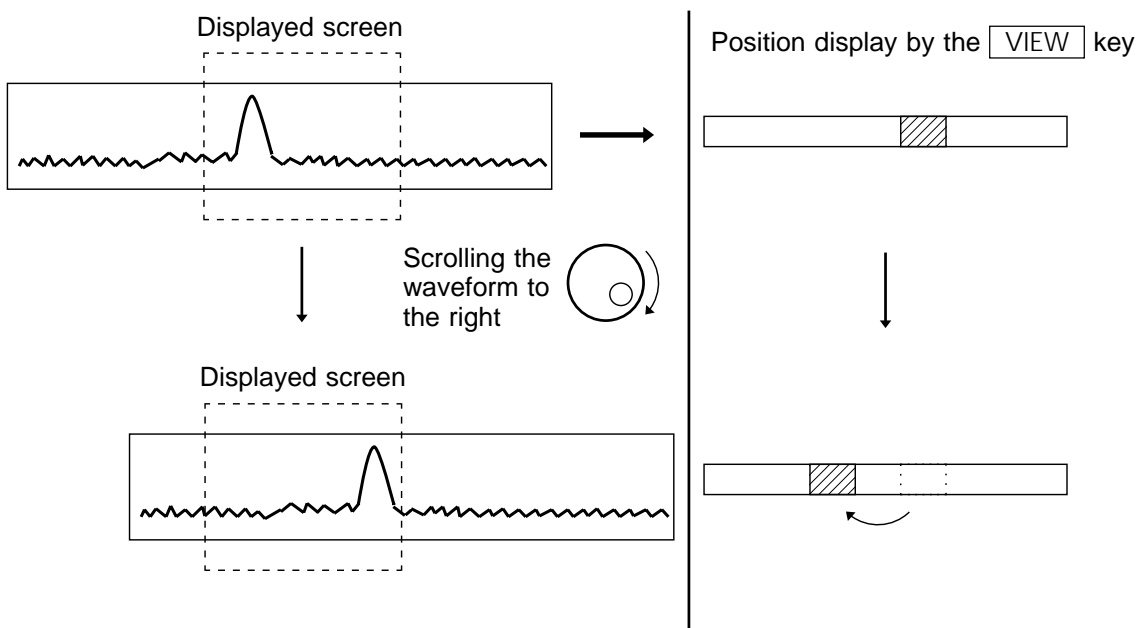

## 11.4 Zoom Function

### (Memory Waveform Only in the Memory Recorder Function and the Recorder and Memory Function\*)

This function divides the display screen into two screens (upper and lower), and allows the waveform on the upper screen to be magnified along the time axis and displayed on the lower screen.

In the recorder and memory function\*, the following operations are required.

1. Capture the waveform in the recorder and memory function.
2. Change the function to the memory recorder function.
3. The memory waveform is continuously relayed.
4. Zooming affects this waveform.

\*: Advanced version

Method Screen: DISPLAY

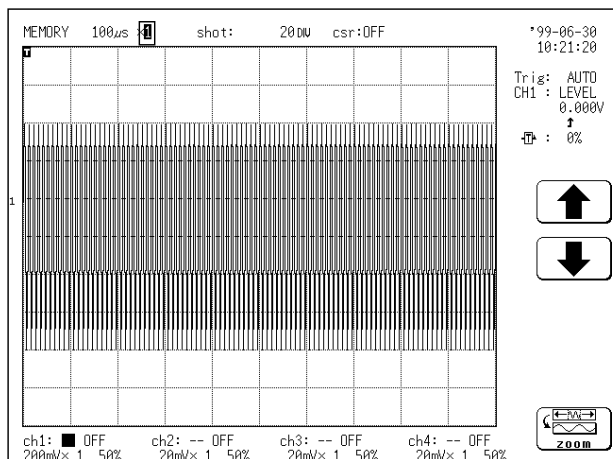

1. Press the **DISP** key to call up the DISPLAY screen.

2. Move the flashing cursor to the position shown in the figure on the left.

3. Use the function keys to select zoom.



: Time axis direction magnification up



: Time axis direction magnification down



: Zoom function is used.

When the zoom function is selected, the display is split into two horizontally tiled screens.

The waveform before the zoom mode was activated is displayed on the upper screen (standard screen). The lower screen shows the zoomed waveform (zoom screen).

11

Standard screen

Magnified range

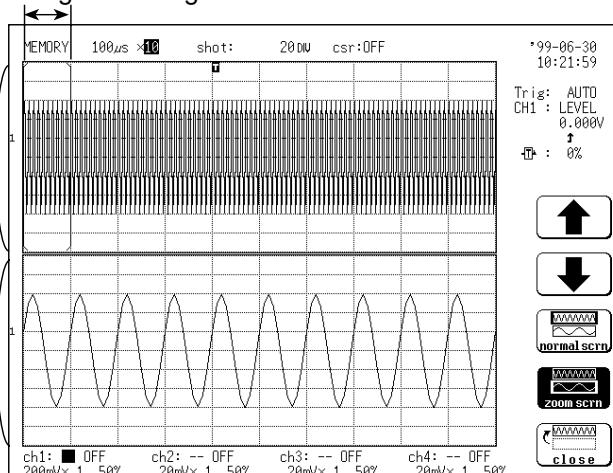





Zoom screen

4. Use the JOG control or the function keys to set the magnification ratio.

The lower screen's display magnification is always larger than the upper screen's display magnification.

{ } brackets on the upper screen indicate the waveform range displayed on the lower screen.

-  : Time axis direction magnification up
-  : Time axis direction magnification down
-  : Enables operations on the standard screen
-  : Enables operations on the zoom screen
-  : Terminates the zoom function

5. To terminate the zoom function, press the function key [close].

**NOTE**

- The A/B cursors can be used only for the waveform on the lower screen.
- During the zoom function, pressing the  key prints the waveform on the lower screen. (The waveform becomes that of the one screen display. If the A/B cursors are used, partial print is applied.)
- The time axis direction magnification indicates the magnification in relation to the original waveform both in the case of the standard display and the in the case of the zoom display.
- The display magnification of the lower display can only be set at a value that exceeds the magnification of the upper display. (E.g., if the upper magnification is  $\times 1$ , the lower can only be set to  $\times 2$ , 5 or 10. If the upper is  $\times 10$ , this should be decreased to  $\times 5$  and the lower set to  $\times 10$ .)
- Scrolling the waveform with the jog button is executed on the lower display. When the lower waveform is scrolled, the brackets indicating the range of the upper display also move.  
(When the lower waveform is scrolled beyond the range indicated at the top, redisplay the upper waveform. Display it so that the range displayed at the bottom is at the center of the screen.)
- When the zoom function is used, the logic waveform display positions are indicated on the screen provided they are 1 to 4. If 5 to 8, the positions are not indicated.



# 11.5 Vernier Function

- Using fine adjustment, the input voltage can be matched to a desired reading.
- For example, an actual input voltage of 1.8 V can be converted to a 2.0 V reading.

**Method** Screen: DISPLAY

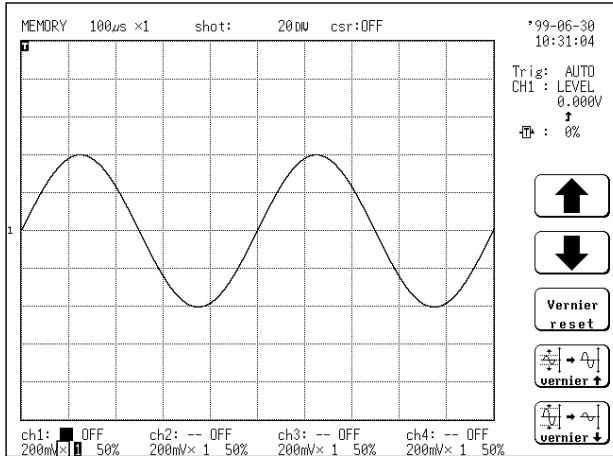

1. Press the **DISP** key to call up the DISPLAY screen.
2. Move the flashing cursor to the position shown in the figure on the left.
3. Use the function keys to select the vernier function.

Use  $\approx$  to magnify and  $\approx$  to compress. The adjustment range is from 1/2 to 2 times of the original waveform.

$\approx$	Displays the magnified waveform.
$\times$	Displays the waveform with no vernier scaling.
$\approx$	Displays the compressed waveform.

- Vernier reset**: Cancels the vernier function. (The original waveform returns.)
- vernier +**: Magnifies the waveform.
- vernier -**: Compresses the waveform.

**NOTE** The vernier function is not applicable to a waveform after waveform processing\*. \*: Advanced version

Example: Changing a 1.8 Vp-p waveform to a 2.0 Vp-p waveform

The actual captured waveform

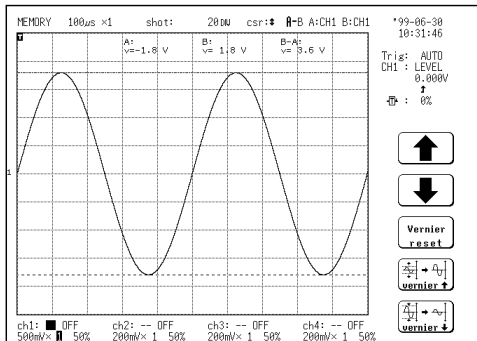

Adjusted to 2 Vp-p using the vernier function.

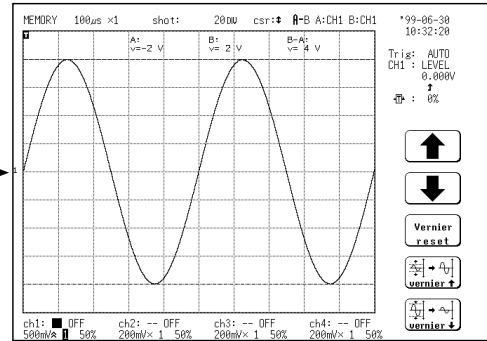



---

# Chapter 12

## External Input/Output Connectors / Key Lock Function

---

---

### 12.1 Overview

The input/output connectors of the 8835-01 serve the following functions:

- Measurement start/stop, printer output control
- External sampling signal input
- Trigger signal input/output

The KEY LOCK switch can be used to temporarily disable the other controls of the 8835-01.

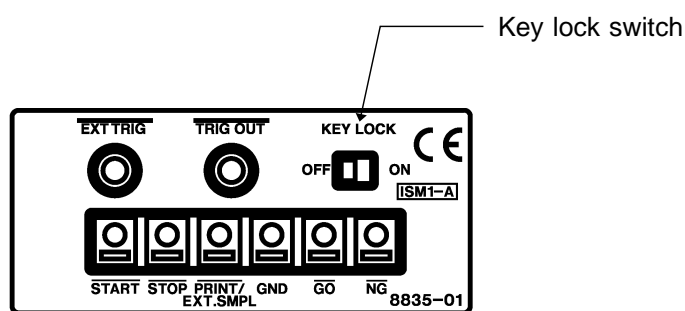

## 12.2 External Start/Stop



- To prevent damage to the unit, take care never to exceed the voltage rating of the inputs. The external I/O terminal and the 8835-01 have a common GND.

Input/output terminal	Maximum input voltage	Maximum rated voltage to earth
EXT TRIG	-5 to +10 VDC	Not insulated
START/STOP		
PRINT/EXT SMPL		
TRIG OUT	-20 V to +30 VDC 100 mA max. 200 mW max.	
GO		
NG		

Using the external START/STOP terminals, recording start/stop can be controlled for all functions.

**START terminal** Measurement starts when a signal is input here.

**STOP terminal** Measurement and printing stop when a signal is input here.

### Signal input method

- Short the terminal to ground, or input a pulse signal (High level: 2.5 to 5.0 V, Low level: 0 to 1.0 V) or a square wave signal.
- Control is activated at the falling edge of the input waveform (active Low).

Voltage range High level: 2.5 to 5.0 V  
Low level: 0 to 1.0 V

Pulse width High level: min. 20 ms  
Low level: min. 30 ms

Maximum input voltage -5 to 10 V

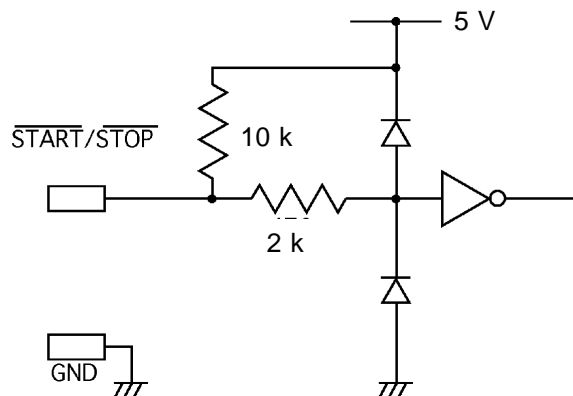
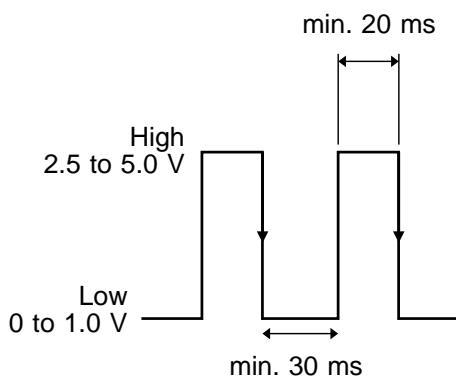

## Using the terminals

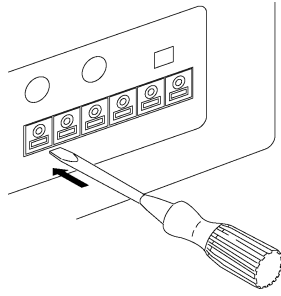

1. Push the tab with a flatblade screwdriver or similar.

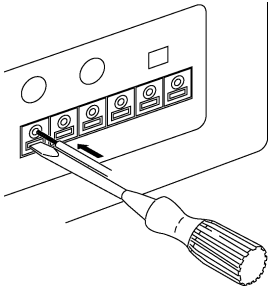

2. While keeping the tab depressed, insert a stripped wire into the connector opening.

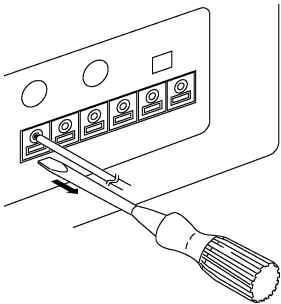

3. Release the tab to lock the wire.

Recommended wire	Single strand: 1.0 mm dia. (AWG #18) Multi-strand: 0.75 mm <sup>2</sup>
Usable limits	Single strand: 0.3 to 1.0 mm dia. (AWG #26 to #18) Multi-strand: 0.3 to 0.75 mm <sup>2</sup> (AWG #22 to #20) Strand diameter: minimum 0.18 mm
Standard insulation stripping length	10 mm

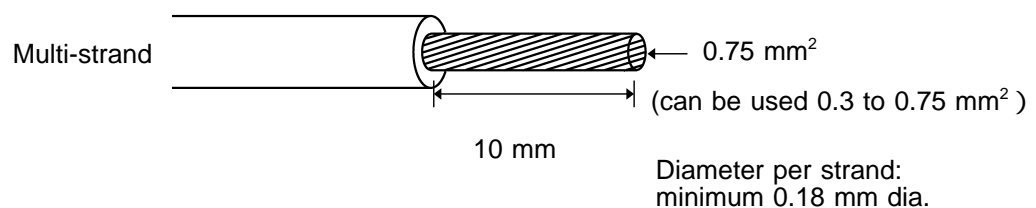
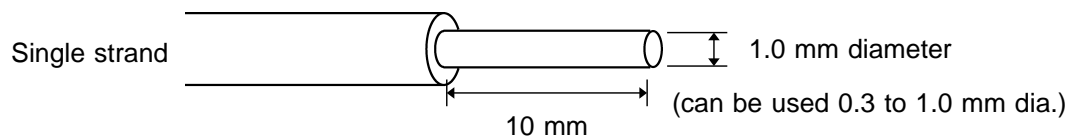

## 12.3 External Printing/Sampling



To prevent damage to the unit, take care never to exceed the voltage rating of the inputs.

- The external print/sampling terminal is used for controlling a printer or for external sampling. External sampling can be used with the memory recorder and FFT functions.\*
- The external print/sampling terminal can be enabled as either an external print terminal or an external sampling terminal (see Section 9.3.12).
- The external printer terminal function is enabled when a system reset is performed.

### When the external print terminal function is enabled:

- Printing starts at the falling edge (active low) of the input waveform.
- Operation is the same as the PRINT key.
- When the time axis range (memory recorder) or frequency range (FFT\*) is set to External, the external sampling terminal function is enabled.

### When the external sampling function is enabled:

- External signals are input and sampled at the desired rate.
- Sampling occurs at the rising edge (active high) of the input waveform.
- For the memory recorder function, set the time axis range to External (see Section 4.2.2).
- For the FFT function,\* set the frequency range to External.

### Signal Input Procedure

Either short the terminal to ground, or apply a pulse or square wave at 2.5 to 5V (high) and 0 to 1.0V (low).

Voltage range	2.5 to 5.0V HIGH level (print and sampling) Zero to 1.0V LOW level (print and sampling)
Pulse width	At least 20 ms HIGH, at least 30 ms LOW (print) At least 0.5 $\mu$ s HIGH and LOW (sampling)
Max. input voltage	-5 to 10V (print and sampling)

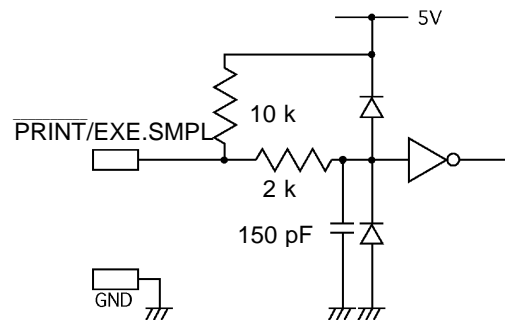
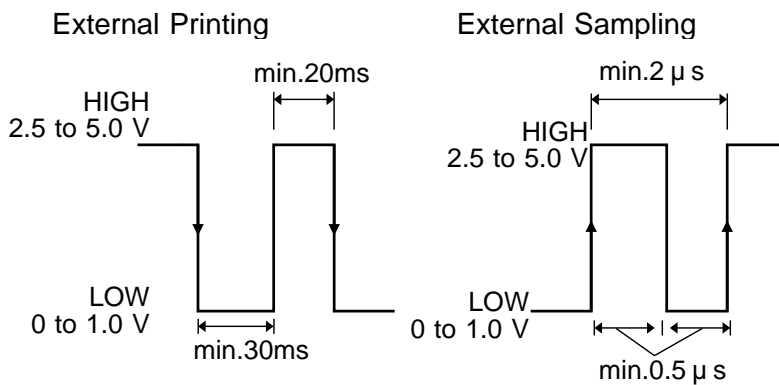

### Using the terminals

See Section 12.2.

## 12.4 Using the External Trigger Input (EXT TRIG)

### CAUTION

To prevent damage to the unit, take care never to exceed the voltage rating of the EXT TRIG input.

- An external signal can be used as trigger source.
- Several 8835-01 units can be synchronized for parallel operation. (see Section 9.3.12)
- Use the 9305 TRIGGER CORD for connection.

### Signal input method

- Short the terminal to ground, or input a pulse signal (High level: 2.5 to 5.0 V, Low level: 0 to 1.0 V) or a square wave signal.
- Triggering is activated at the falling edge of 2.5 V of the input waveform or using a terminal short (active Low).

Voltage range    High level: 2.5 to 5.0 V  
                           Low level: 0 to 1.0 V

Maximum input voltage    -5 to 10 V

Connector type    miniature phone jack, 3.5 mm dia.

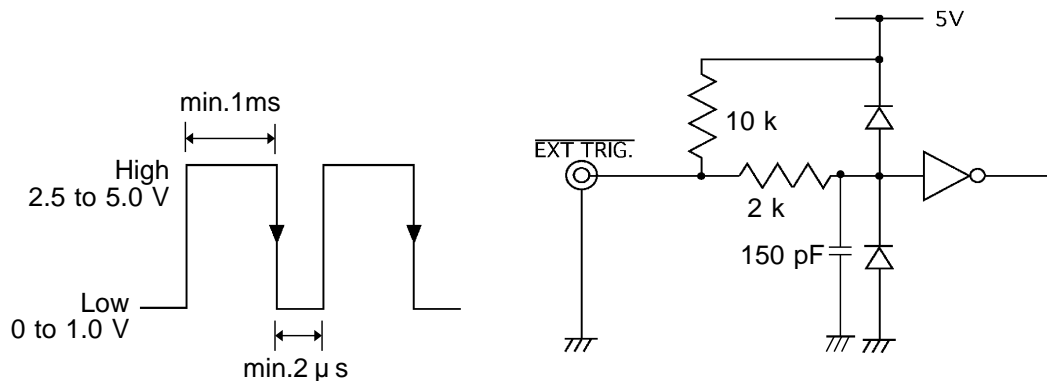

### NOTE

The external trigger input (EXT TRIG) cannot be used, unless the external trigger is enabled on the STATUS 2 screen.

## 12.5 Using the External Trigger Output (TRIG OUT)

### CAUTION

To prevent damage to the unit, take care never to exceed the voltage rating of the TRIG OUT input.

- When triggering occurs, a signal is output from this connector.
- Several 8835-01 units can be synchronized for parallel operation.
- Use the 9305 TRIGGER CORD for connection.

### Trigger output signal

Signal type open-collector signal, active Low

Output voltage High level: 4.0 to 5.0 V  
range Low level: 0 to 0.5 V

Pulse width min. 10 ms.

Maximum input voltage -20 to +30 V, max. 100 mA, max. 200 mW

Connector type miniature phone jack, 3.5 mm dia.

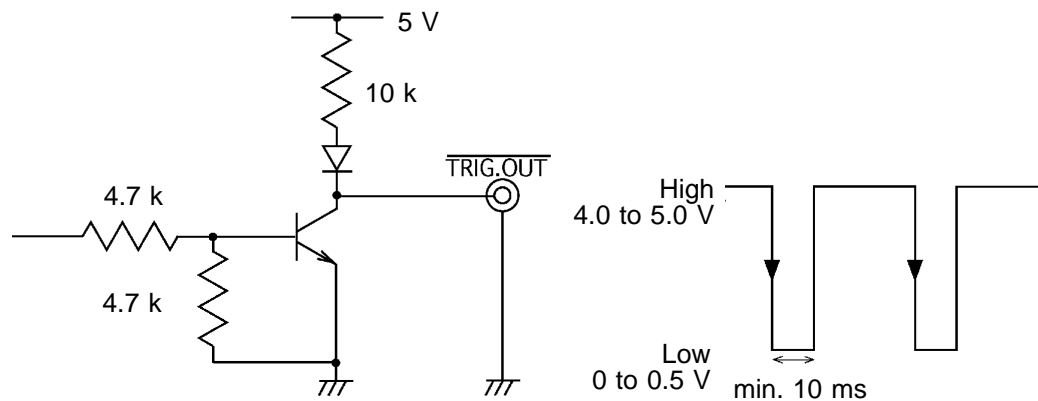

### NOTE

When the auto range function is activated, a trigger output signal is generated. This should be taken into consideration when using both the trigger output and the auto range function. (Memory recorder function only) (see Section 4.3.2)



## 12.6 Using the Evaluation Outputs (GO), (NG)



To prevent damage to the unit, take care never to exceed the voltage rating of the GO and NG outputs.

When waveform evaluation or waveform parameter evaluation is used, a signal is output from these connectors when the result is GO (pass) or NG (fail).

### Output signal

Signal type      open-collector signal, active Low

Output voltage    High level: 4.0 to 5.0 V

range              Low level: 0 to 0.5 V

Maximum input voltage    -20 to +30 V, max. 100 mA, max. 200 mW

#### ① Evaluation output interval (min. 70 ms)

The evaluation outputs are shown in the following table. Between these states, there is an interval during which the next data are read and waveform data are created. The duration of this interval is inversely proportional to the time axis and proportional to the recording length.

Output	Evaluation result	
	GO	NG
GO	Low level	High level
NG	High level	Low level

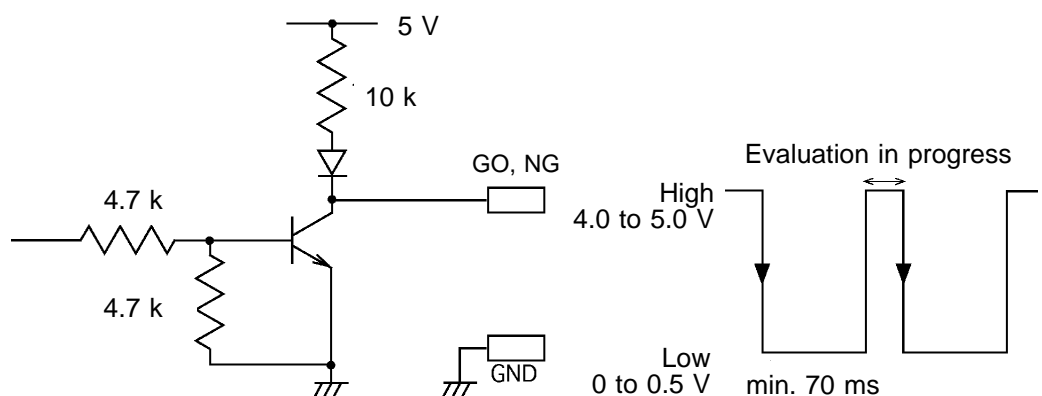

## ② Evaluation interval (approx. 20 ms)

Both the GO and NG outputs are High level. Evaluation is carried out during this interval.

Example (NG output)

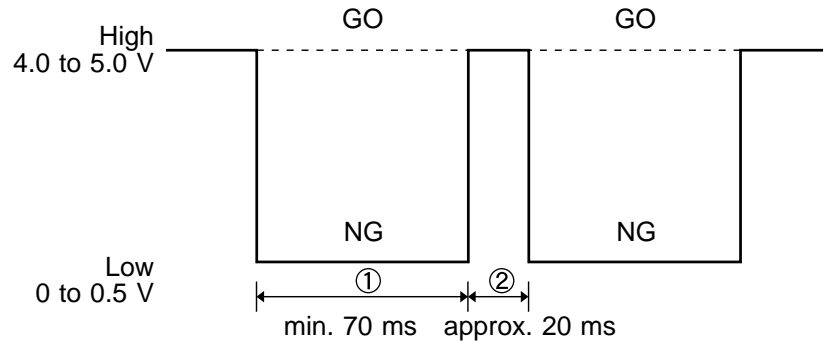
**NOTE**

The waveform area evaluation and waveform parameter evaluation functions can be used only in the advanced version.

## 12.7 Using the Key Lock Function

- This function disables all front-panel controls of the 8835-01.
- The function serves to prevent unintended changes to settings during a measurement.

**Method**

1. Set the KEY LOCK switch to ON.
  2. To cancel the function, set the KEY LOCK switch to OFF.  
(The key lock function will not be canceled by turning the power off and on.)
- When the key lock function is active, the indication "KEY LOCK" is shown on the display.
  - If the backlight saver function is used and the display backlight turns off, it can be turned on again by touching any key. The function assigned to the key will not be activated.

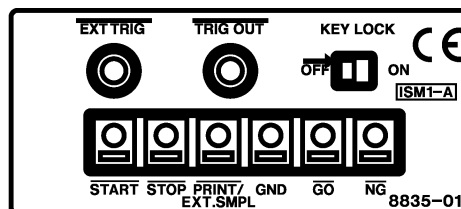

---

# Chapter 13

## Storing, Retrieving and Deleting Waveform Data and Measurement Settings

---

---

### 13.1 Outline

- A floppy disk or PC card can be used to store and retrieve measurement and setting data.
- The floppy disk must be initialized (formatted) before using it (see Section 13.2.3).
- If the A/B cursors are used, partial save is applied (see Section 13.4).
- Only a limited number of files can be stored in the directory (see Section 13.4).

## 13.2 Handling the Floppy Disk

A floppy disk can be used to store and retrieve measurement and setting data. The floppy disk must be initialized (formatted) before using it.

**NOTE**

If the write-protect tab on the floppy disk is in the set position, the following operations can not be performed.

- Initialize
- Store
- Delete
- Make dir
- Del dir

Move the write-protect tab to the unset position.

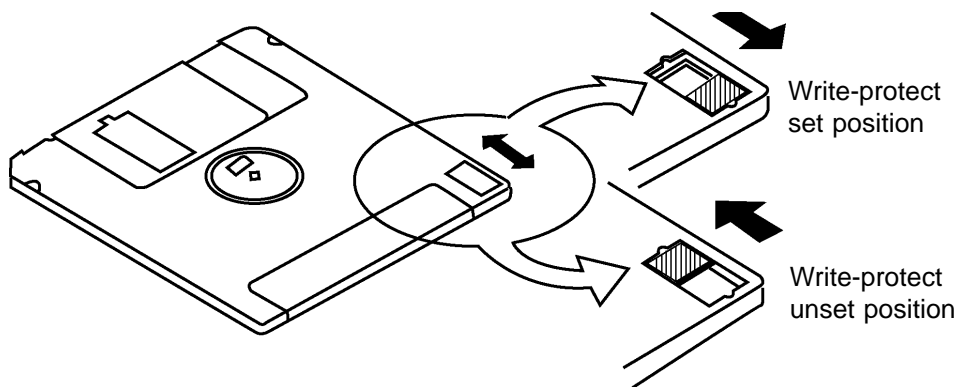

### 13.2.1 Floppy Disk

**CAUTION**

- If a floppy disk is inserted upside down, backwards, or in the wrong direction, the floppy disk or the unit may suffer damage.
- Do not remove the floppy disk while the floppy disk unit is operating (the LED on the floppy disk unit is on).
- Before shipping the unit, always remove the floppy disk.

3.5 inch 2HD or 2DD floppy disks can be used.

The following floppy disk formats can be used:

720 KB (IBM PC/AT compatible), 1.2 MB (NEC PC-9801 series), 1.44 MB (IBM PC/AT compatible or NEC PC-9801 series with 3-mode drive)

**NOTE**

- 2DD floppy disks formatted in PC9801 640 K-byte format cannot be used.
- When loading data to personal computer via floppy disk, verify that floppy disk formatted in MEMORY HiCORDER is recognized on desktop.

## 13.2.2 Using the Floppy Disk Drive

**CAUTION**

- Take care to insert the floppy disk with correct orientation.
- Do not remove the floppy disk while the LED on the floppy disk unit is on. The floppy disk or the unit may suffer damage.

### How to insert a floppy disk:

Hold the disk with its written-on face to the left and push it all the way into the slot in the proper orientation.

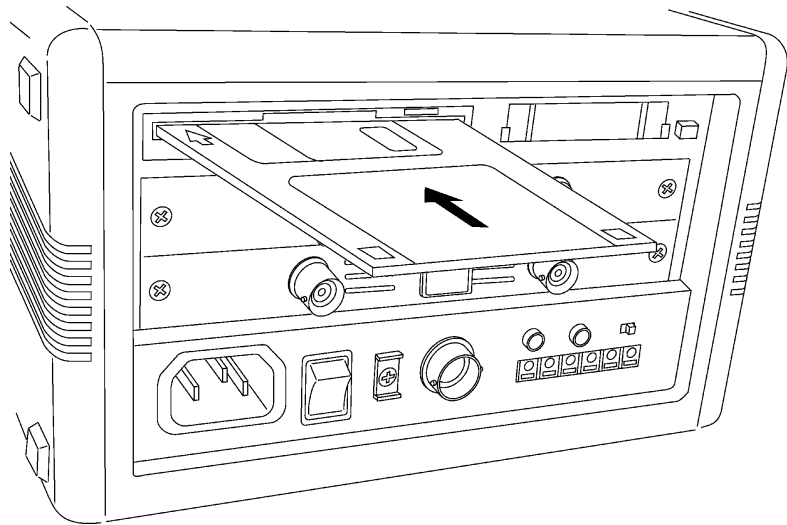

### How to remove a floppy disk:

Press the button as shown in the figure below and the disk is ejected.

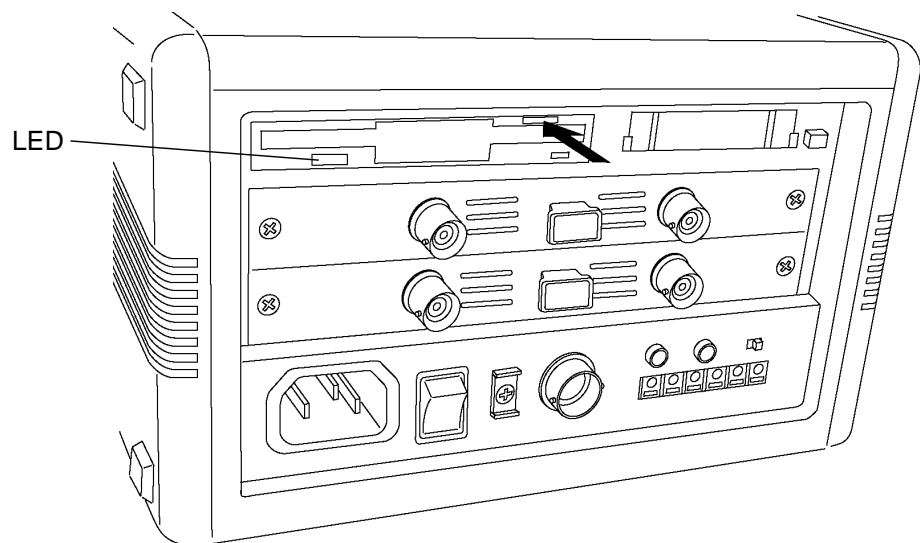

### 13.2.3 Initializing (Formatting) the Floppy Disk

The floppy disk must be initialized (formatted) before using it.  
 The floppy disk initialization (formatting) method is described below.

**Method**

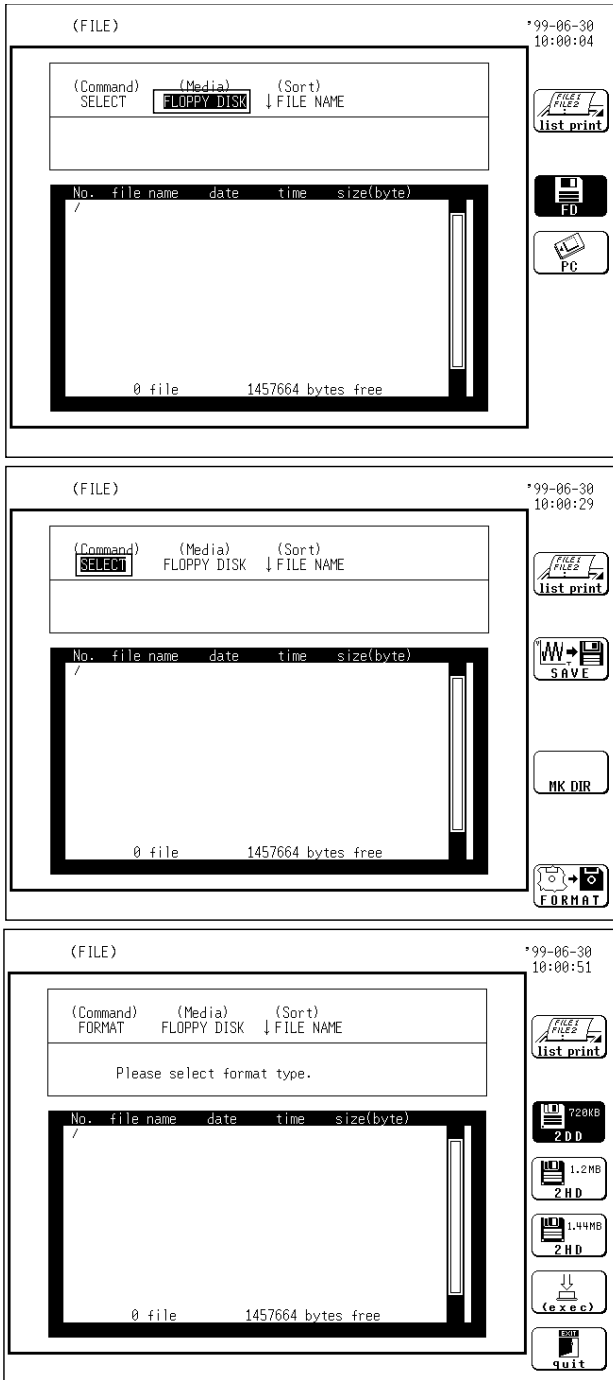

1. Press the **FILE** key to call up the FILE screen. Move the flashing cursor to the position shown in the figure on the left, and use the function keys to select FD.
2. Use the CURSOR keys to move the flashing cursor to the position shown in the figure on the left.
3. Use the function keys to select FORMAT.
4. The format modes appear on the function key display.  
 Use the function keys to select the floppy disk format mode.
  - : Format in 2DD (720 KB) format.
  - : Format in 2HD (1.2 MB) format.
  - : Format in 2HD (1.44 MB) format.

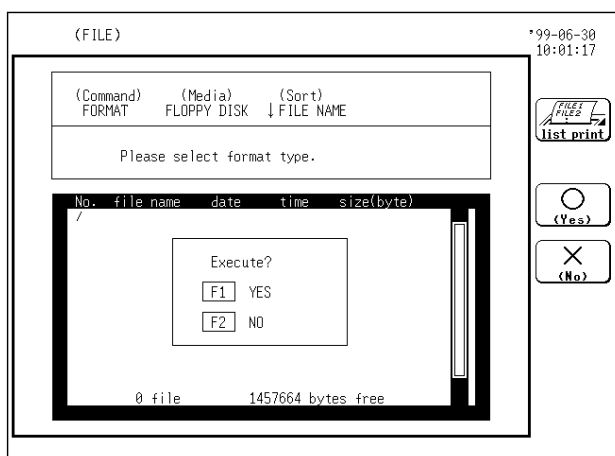

5. Use the function keys to select execution.

6. Use the function keys to select whether to execute or not.

(Yes) : Execute the format procedure.

(No) : Cancel the format procedure.

**NOTE**

When loading data to personal computer via floppy disk, verify that floppy disk formatted in MEMORY HiCORDER is recognized on desktop.

## 13.3 Handling the PC Card

PC cards can be used for interface and to save measurement and settings data.

**WARNING**

**Use only PC Cards sold by HIOKI.**

**Compatibility and performance are not guaranteed for PC cards made by other manufacturers. You may be unable to read from or save data to such cards.**

**NOTE**

When formatting a PC card on a PC, use the FAT-16 format. Formatting a card in FAT-32 format may result in incompatibility problems.

---

### 13.3.1 PC Card

**⚠ CAUTION**

- Printing is not possible if the recording paper is loaded wrong-side up.
  - To avoid damage to the product, be sure to remove the PC card before shipping.
- 
- The 8835-01 is compatible with optional PC cards (compact flash, RS-232C card, GP-IB card, printer card, LAN card).
  - Please use the following optional PC cards (compact flash) for saving data.
    - 9626 PC CARD (32 M)\*
    - 9627 PC CARD (64 M)\*
    - 9726 PC CARD (128 M)
    - 9727 PC CARD (256 M)
    - 9728 PC CARD (512 M)
    - 9729 PC CARD (1 G)
- \*: discontinued product



## 13.3.2 Using the PC Card Slot (PC Card with a Cable Only)

### CAUTION

When making the connection, the cable connector and PC card should be properly aligned, so that the connector can be pushed in straight. Do not exert strong force on the PC card connector, to prevent the possibility of damage and contact problems.

### Cable and PC card connection

1. Pass the PC card protector through the connection cable, as shown below.

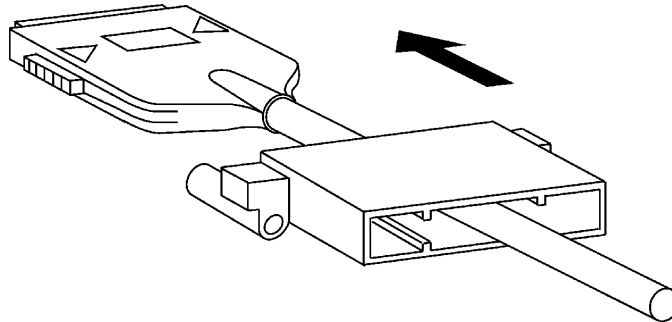

Fig. 13.1 Passing protector through connection cable

2. Plug the PC card end of the connection cable into the PC card. The top side of the cable connector (marked with a ) should match the top side of the PC card, as shown below.

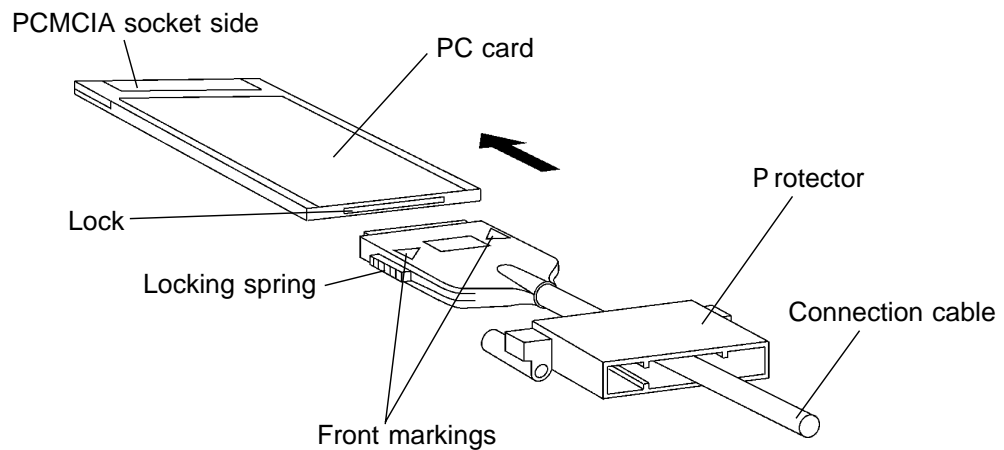

Fig. 13.2 Connection cable and PC card connection

## Inserting the PC card

### CAUTION

If a PC card is inserted upside down, backwards, or in the wrong direction, the PC card or the unit may suffer damage.

To avoid damage to the PC card or connector, observe the cautions listed below.

- Inserting the card with the wrong orientation or in other ways than described above.
- Inserting the card while attached to the connection cable.
- Moving the 8835-01 while the connection cable is connected to the card.
- Pulling the card out by the cable or exerting excessive force on the connector.
- Placing objects on the connection cable connector.

1. Insert the PC card in the PC card slot on the 8835-01. Verify that the mark on the card points in the correct direction as shown below, and make sure that the card is properly seated in the slot.

The PC card is keyed to prevent wrong insertion, but exerting excessive force may damage the card or the slot.

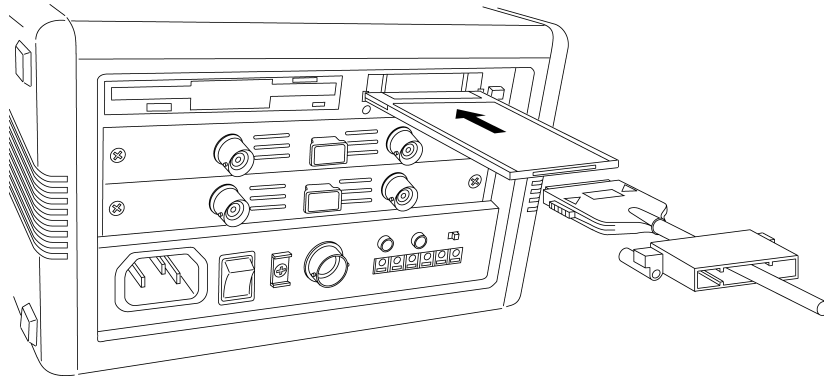

Fig. 13.3 PC card insertion

2. Attach the PC card protector to the 8835-01 as shown below.

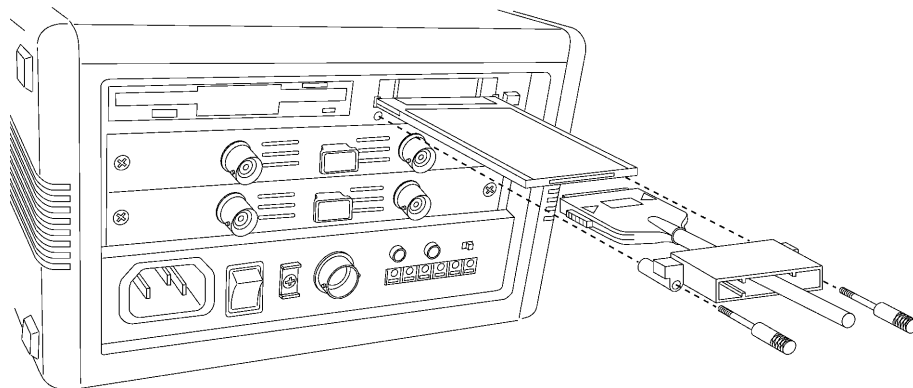

Fig. 13.4 Attaching the protector

## Removing the PC card

**CAUTION**

- Do not press the eject button before removing the PC card protector.
- Do not remove the PC card while the PC card unit is operating.
- To avoid damage to the product, be sure to remove the PC card before shipping.

1. Remove the PC card protector as shown below.

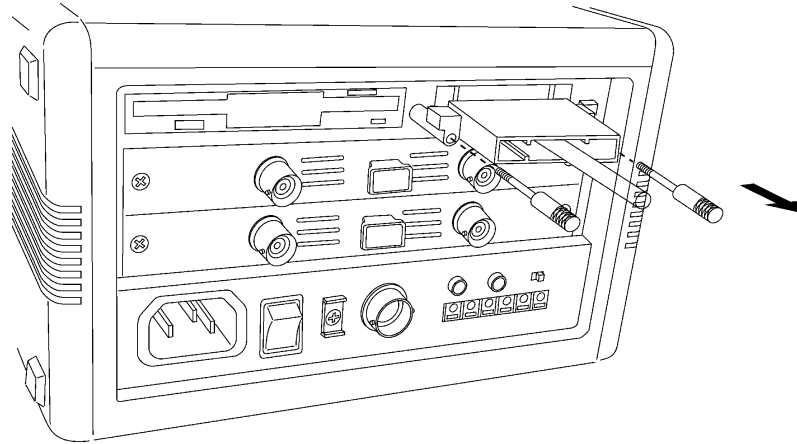

Fig. 13.5 Removing the protector

2. To remove the PC card, press the eject button as shown below.

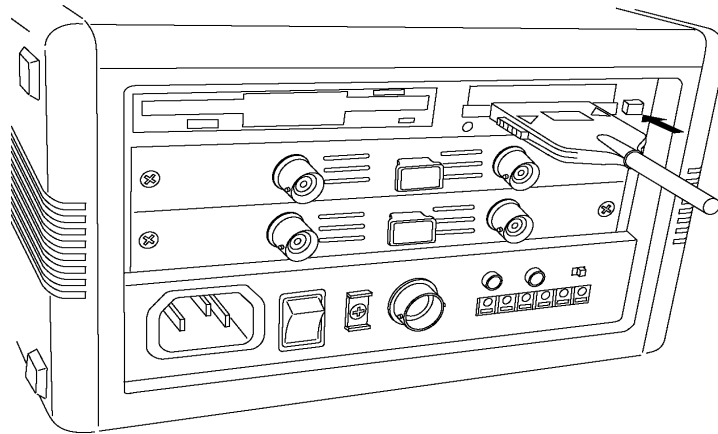

Fig. 13.6 Removing the PC card

---

## 13.4 Storing, Retrieving and Deleting Data on the Floppy Disk or PC Card

---

### 13.4.1 Overview

This section explains how to use the SAVE, LOAD, INFO, and DELETE commands and how to create, change, and delete a directory.

---

### 13.4.2 FILE Screen

- The FILE screen appears when the  key is pressed.
- The general operation flow is shown below.

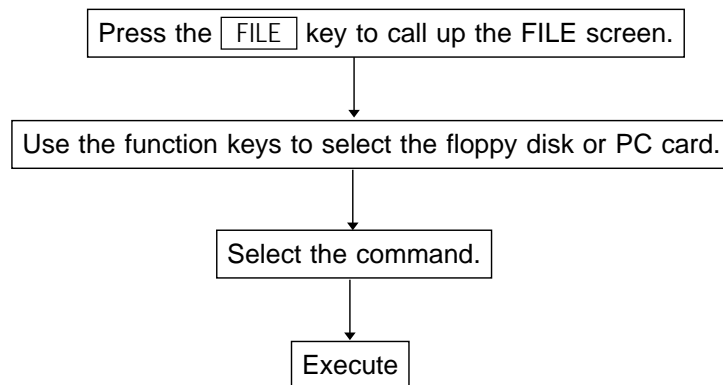

---

### 13.4.3 What Can Be Recorded and How Much

#### (1) Setting state (FUNCTION)

1. It is possible to record the setting state for each of the functions: the memory recorder function, the recorder function, and the RMS recorder function.
2. When a setting state is read into the 8835-01, it is restored in the unit.

Size of recording in each function

	Size of recording for the setting state
Normal	512 bytes × 24 = 12288 bytes
Advanced version (After the 9540-01 FUNCTION UP DISK is installed)	512 bytes × 28 = 14336 bytes

## (2) Measurement data (WAVE)

1. It is possible to save the measurement data of a waveform which has been captured.
2. When measurement data is read into the 8835-01, the waveform data recorded on the floppy disk or PC card is put into the designated memory channel.
3. When the measurement data of a waveform is recorded, its setting state (the recording length, time axis, voltage axis, scaling and comments) is also simultaneously recorded. Because when this is loaded the unit is set to the condition when the measurement data was recorded, it can be checked by being listed. (see "File contents" in Section 13.4.5.) (Logic channels CHA to CHD are considered as one channel in any function.) For the size of a file, see Section Appendix 5.

## (3) Screen hard copy (BMP)

The each screen display of the 8835-01 can be stored in the bit map file (BMP) format.

Size of a file

Color setting	Size of a file
color, gray-scale	308,278 bytes
monochrome, reverse monochrome	38,462 bytes

- The bit map file is one of the standard graphic type of the WINDOWS\*, therefore by using the graphic software, this file format can be used.
- For setting the output destination of the screen display data, see Section 9.6.1.

\*: The WINDOWS is a registered trademark of Microsoft Corporation.

## NOTE

- The number of bytes depends on the floppy disk or PC CARD format.
- Data stored in the BMP format is not readable by the 8835-01.
- If the A/B cursors are used, partial save is applied (see Section 13.4).

## 13.4.4 Selecting the Media Type

The media type is specified.

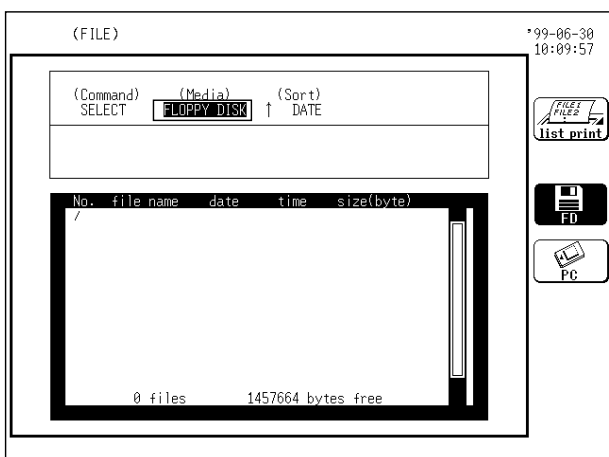

1. Press the **FILE** key to call up the FILE screen.
2. Move the flashing cursor to the position shown in the figure on the left, and use the function keys to make the selection.

 : Floppy disk media are used.

 : PC card media are used.

## 13.4.5 Detailed Explanation of the Commands

### 1. SAVE

- Unit settings and measurement data can be stored on floppy disk.
- They are stored in the directory currently selected on the file screen.
- Waveform data can be stored as binary or text data.
- Use of cursors A and B enables partial saving.
- The floppy disk must be initialized (formatted) before using it (see Section 13.2.3).

**NOTE**

- Since only a limited number of files (including directories) can be created in the root directory, subdirectories should be created to enable the creation of multiple files.
- For a subdirectory, see "7. MKDIR."
- Data stored in the text format is not readable by the 8835-01.
- X-Y waveforms in the recorder function cannot be saved in TEXT format.
- If the data quantity is too large, it may not fit on a floppy diskette or PC Card. For the size of a file, see Section Appendix 4.

#### Method

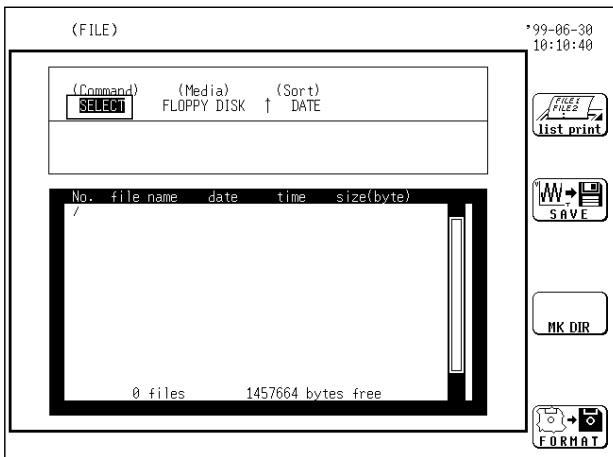

1. Press the **FILE** key to call up the FILE screen.
2. Use the CURSOR keys to move the flashing cursor to the position shown in the figure on the left, and use the function keys to select **SAVE**.

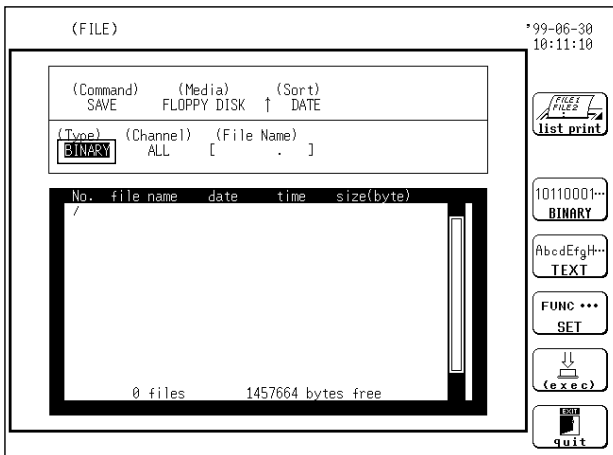

3. Move the flashing cursor to the position shown in the figure on the left, and use the function keys to select the store format.

- 10110001... BINARY**: Data are stored as binary data.
- AbcdEfgH... TEXT**: Data are stored as text data.
- FUNC SET**: Store settings.

**NOTE**

- The TEXT format is intended for reading by a PC. Select BINARY for reading by the 8835-01.
- X-Y waveforms in the recorder function cannot be saved in TEXT format. Also, the waveforms cannot be saved automatically.
- When the characters below are used in a file, the file cannot be handled on a PC running Windows 2000 or XP. Do not use these characters when handling a file on your PC.  
+, =, [, ]

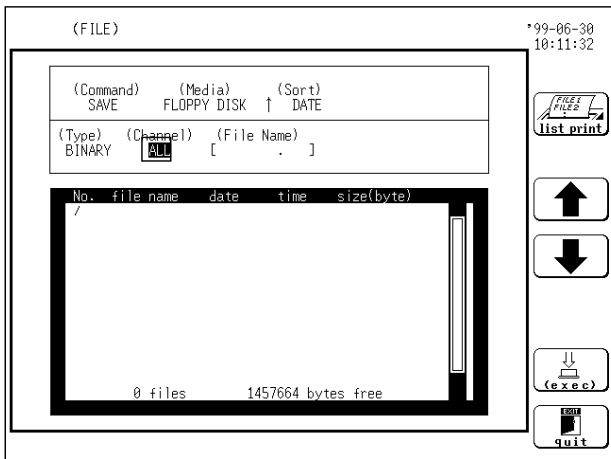

4. Move the flashing cursor to the position shown in the figure on the left, and use the function keys to select the channel for storing data.

- ↑ : Channel number up  
↓ : Channel number down

**NOTE**

Select ALL to save all displayed channels. Undisplayed channels are not saved.

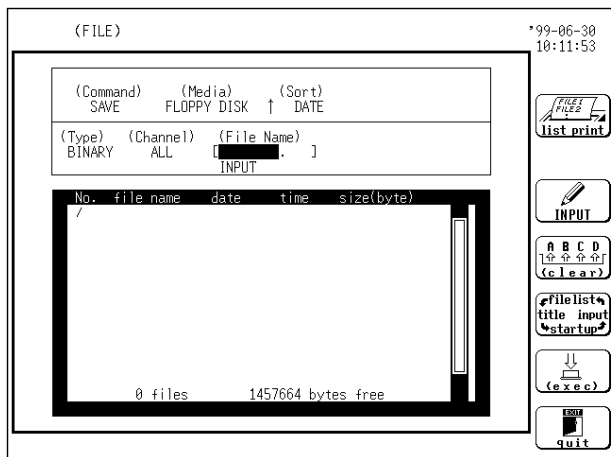

5. Move the flashing cursor to the position shown in the figure on the left, and enter the file name (see Section 9.5.5).

6. Press the (exec) function key.

To save the waveform data in the specified format, press the **F1** (Yes) key. To abort saving, press the **F2** (No) key.

**NOTE**

If the A/B cursors are used, partial save is applied.

### Entering the file name

Select from file name entry options in function key display.

Enter: Type in name.

File list: Characters highlighted with line cursor are entered as file name.

Title: Comment in title comment is entered as file name.

Start up: Name for auto setup function is entered as file name.

### Method

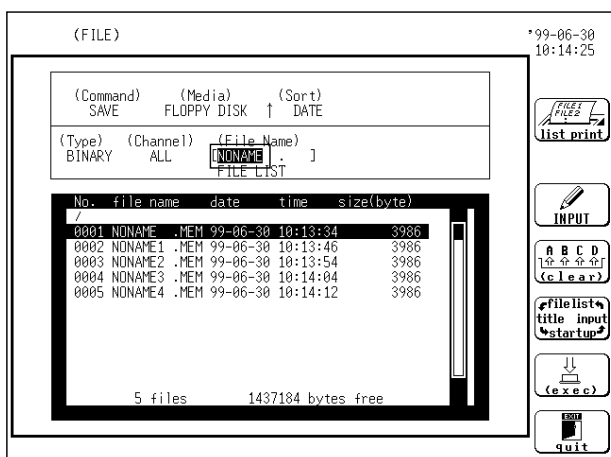

1. Move the flashing cursor to File name.

2. Each pressing of the **F3** function key display selected file name entry.

When selecting file list, use the cursor key to move the line cursor to select file.

file list title input startup : Switches entry selection.

3. Press Character Entry in function key display to rename file. (see Section 9.5.5)

**NOTE**

- When loading comment in title comment as file name, first 8 characters are entered as file name.
- When name for auto setup function is entered as file name, extension is not attached. Extension appropriate to file Category is attached during save.

### File name extension

If no file name extension (3 characters after period) is entered, the following extensions are automatically assigned, according to the stored data type.

Extension	Meaning	
MEM	Memory recorder binary data file	Yes
REC	Recorder binary data file	Yes
RMS	RMS recorder binary data file	Yes
XYC	X-Y CONT recorder binary data file	Yes
SEQ*	Sequential save index file	Yes
MUL*	Multi-block index file	Yes
TXT	Text data file	No
SET	Setting data file	Yes
ARE*	Waveform decision area	Yes
BMP	Bitmap (.bmp) file	No
FFT*	FFT binary data file	Yes
R_M*	Recorder and memory index file	Yes

Yes: Files can be read into the unit.

No: Reading is not possible.

\*: Advanced version

### Automatic file name assignment

If the file name is entered as a blank (     ), it is assigned automatically according to the following principle.

Auto save	Waveform data, screen data	Parameter calculation result
[ AUTO .Extension ]	[ NONAME .Extension ]	[ MEASURE .TXT ]
[ AUTO1 .Extension ]	[ NONAME1 .Extension ]	[ MEASURE1.TXT ]
[ AUTO10 .Extension ]	[ NONAME10.Extension ]	[ MEASUR10.TXT ]
[ AUTO100 .Extension ]	[ NONAM100.Extension ]	[ MEASU100.TXT ]
[ AUTO5000.Extension ]	[ NONA5000.Extension ]	[ MEAS5000.TXT ]

**NOTE**

In automatic save, file is titled with a number following the file name specified in the STATUS screen of each function. Leaving the file name untitled in the STATUS screen enters AUTO in file name.



**Directory and file numbers available for saving**

Media	Type	Limit	
		Root	Sub
FD	720 K	112	5000
	1.2 M	192	5000
	1.44 M	224	5000
PC card	Flash ATA	512 to 1024	5000

**File contents**

The file contents depend on the file type.

: The data is saved to the file. Settings for the 8835-01 are always enabled during reading.

(\*1): The data is saved to the file. During reading, settings for the 8835-01 are enabled only in case of "new load."

x: The data is not saved to the file.

	WAVE (Binary)			SET (Setting)
	MEM	REC	RMS	
Function				
Time axis range				
Recording length				
Format				
Roll mode				
Overlay				
Printer format				
Smooth print				
Auto print				
Auto save				
Trigger settings	(*2)	(*2)	(*2)	

\*1: When the waveform data functions in the 8835-01 are the same as those to be read and all settings on the 8835-01 are to be enabled, deletes the waveform data from the unit and load the new data.

\*2: Trigger settings for each channel:  
Other trigger settings:

### Partial Save

- When the A/B cursors are active (vertical or trace cursors), partial saving is enabled.
- Waveform data between the A and B cursors is saved (the order of the cursors does not matter).
- When only the A cursor is active, the portion of the waveform from the A cursor to the end of the waveform is saved.
- Partial saving is enabled even if the A and B cursors are off screen due to waveform amplitude or scrolling.
- Refer to Section 11.2, Using the A/B Cursors, for more information on cursor operation.
- Partial save is possible according to operating conditions, as shown in the following table.

### Text data thinning setting

When the store format is set to text data, thinning can be set as follows.

Setting items

OFF: No thinning is carried out.

1/n (n = 2, 5, 10, 20, 50, 100, 200, 500, 1000):

The number of data is reduced. Only one data per n data is stored, using sequential ordering.

**NOTE**

- Not enough data for thinning results in creating a single data file.
- Thinning is not available in FFT (advanced version).

### Text data save example

Text data is saved as following.

Function determines data saving methods.

```
"COMMENT", "8835-01 MEM DATA" : Comment character string, data type
"DATE", "04-09-1999"           : Date (month-day-year)
"TIME", "10:10:00"            : Time
"NUM_SIGS", 3                  : Number of signals
"INTERVAL", 1.000E-06          : Horizontal axis interval
"HORZ_UNITS", "S"              : Horizontal axis unit
"VERT_UNITS", "S", "V", "V"    : Vertical axis unit
"SIGNAL", "TIME", "ACH 1", "ACH 2" : Signal name
"DATA"                          : Saving data.
+0.000000E+00, -5.9375E-03, +9.3750E-04
+1.000000E-06, -5.6875E-03, +7.5000E-04
```

Example 1: When saving analog 4 ch & logic 4 ch in memory recorder  
(memory recorder, memory data with recorder&memory, FFT function)

```
"COMMENT","8835-01 MEM DATA"
"DATE","04-09-1999"
"TIME","10:10:00"
"NUM_SIGS", 9
"INTERVAL", 1.000E-06
"HORZ_UNITS", "S"
"VERT_UNITS", "S", "V", "V", "V", "V", "Bit", "Bit", "Bit", "Bit"
"SIGNAL", "TIME", "ACH 1", "ACH 2", "ACH 3", "ACH 4", "LCHA1", "LCHA2",
"LCHA3", "LCHA4"
"DATA"
+0.000000E+00, -5.9375E-03, +9.3750E-04, +2.3500E-03, -9.3750E-04, 1,1,1,1
+1.000000E-06, -5.6875E-03, +7.5000E-04, +2.4125E-03, -1.0312E-03, 1,1,1,1
+2.000000E-06, -5.5000E-03, +6.2500E-04, +2.3688E-03, -1.0437E-03, 1,1,1,1
+3.000000E-06, -5.5000E-03, +6.2500E-04, +2.4000E-03, -1.1750E-03, 1,1,1,1
+4.000000E-06, -5.3750E-03, +4.3750E-04, +2.4000E-03, -1.1687E-03, 1,1,1,1
+5.000000E-06, -5.6250E-03, -5.1875E-03, +1.0250E-03, -1.2187E-03, 1,1,1,1
+6.000000E-06, +4.3750E-04, -7.6875E-03, -1.1250E-03, -9.3750E-05, 1,1,1,1
+7.000000E-06, +2.1875E-03, -6.1875E-03, -1.6875E-03, +8.0000E-04, 1,1,1,1
+8.000000E-06, +1.5625E-03, -6.5000E-03, -2.0687E-03, +1.1687E-03, 1,1,1,1
+9.000000E-06, +1.3750E-03, -6.3750E-03, -2.2500E-03, +1.3125E-03, 1,1,1,1
+1.000000E-05, +1.3750E-03, -6.2500E-03, -2.2875E-03, +1.4250E-03, 1,1,1,1
```

Example 2: When saving in memory recorder  
(recorder, RMS recorder, recorder data with recorder&memory, )

```
"COMMENT","8835-01 REC DATA"
"DATE","04-09-1999"
"TIME","10:10:00"
"NUM_SIGS",13
"INTERVAL", 1.000E-04
"HORZ_UNITS", "S"
"VERT_UNITS", "S", "V", "V", "V", "V", "Bit", "Bit", "Bit", "Bit", "Bit", "Bit", "Bit"
"SIGNAL", "TIME", "ACH 1(Max)", "ACH 1(Min)", "ACH 2(Max)", "ACH 2(Min)",
"LCHA1(Max)", "LCHA2(Max)", "LCHA3(Max)", "LCHA4(Max)", "LCHA1(Min)",
"LCHA2(Min)", "LCHA3(Min)", "LCHA4(Min)"
"DATA"
+0.000000E+00, +2.5000E-03, -8.5000E-03, +1.8125E-03, -8.9375E-03, 1,1,1,1, 0,0,0,0
+1.000000E-04, +2.2500E-03, -8.8125E-03, +1.8750E-03, -9.1250E-03, 1,1,1,1, 0,0,0,0
+2.000000E-04, +2.5000E-03, -8.7500E-03, +1.8125E-03, -9.2500E-03, 1,1,1,1, 0,0,0,0
+3.000000E-04, +2.4375E-03, -8.5000E-03, +2.0000E-03, -9.1250E-03, 1,1,1,1, 0,0,0,0
+4.000000E-04, +2.5625E-03, -8.6875E-03, +1.9375E-03, -9.3125E-03, 1,1,1,1, 0,0,0,0
+5.000000E-04, +2.3750E-03, -8.3750E-03, +1.9375E-03, -8.9375E-03, 1,1,1,1, 0,0,0,0
+6.000000E-04, +2.5000E-03, -8.8750E-03, +2.0625E-03, -8.8750E-03, 1,1,1,1, 0,0,0,0
+7.000000E-04, +2.3750E-03, -8.8125E-03, +1.8750E-03, -9.0625E-03, 1,1,1,1, 0,0,0,0
+8.000000E-04, +2.5000E-03, -8.6250E-03, +2.0625E-03, -9.3125E-03, 1,1,1,1, 0,0,0,0
+9.000000E-04, +2.3750E-03, -8.3750E-03, +2.0000E-03, -9.1875E-03, 1,1,1,1, 0,0,0,0
```

**NOTE**

- Faster sampling than time axis in the screen applies to recorder waveform, RMS recorder waveform, recorder & memory recorder waveform.
- Loaded data is converted to sampling data adjusted to display screen range. Maximum value and minimum value between samplings are saved in memory. However when thinning is applied, data without thinning is saved as is.

## 2. LOAD

- Unit settings or measurement data are transferred from the floppy disk or PC card to the memory of the unit.
- When loading measurement data, the channel can be specified.

### Method

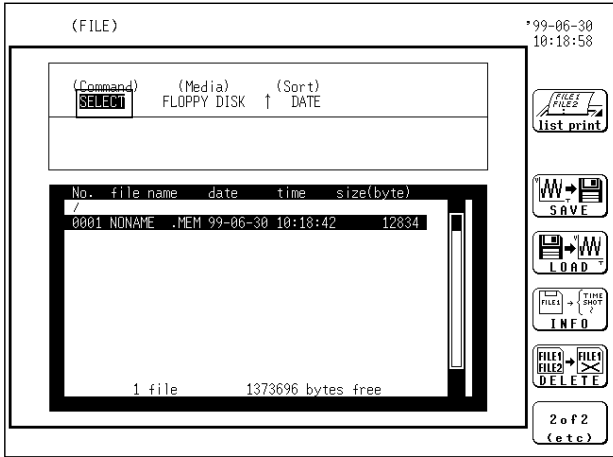

1. Use the JOG control or the CURSOR keys to select the desired file name.
2. Move the flashing cursor to the position shown in the figure on the left, and use the function keys to select LOAD.

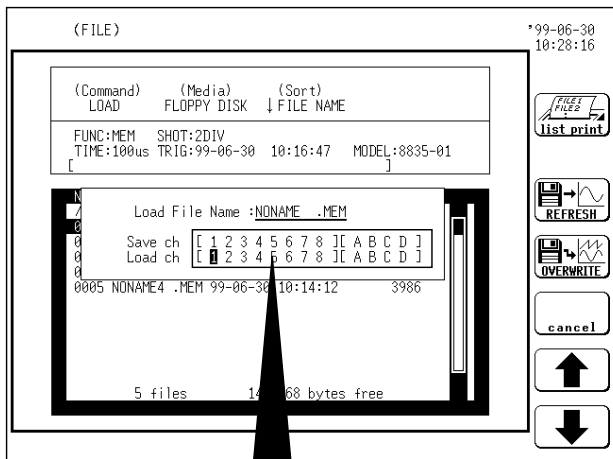

3. Select either of the following loading methods.

- REFRESH: Deletes the waveform data from the unit and load the new data.
- OVERWRITE: Load the new data by overwriting the waveform data already in the unit.
- cancel: Cancel the load procedure.
- ↑: Change the channel from which to load.
- ↓: Change the channel from which to load.

• Data is not loaded to channels that are set to [ - ].

### Example

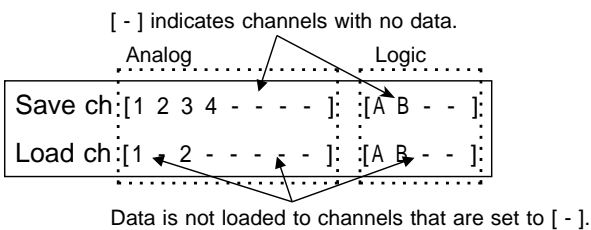

- In the example at left, analog data from CH 1 to 4 (none for CH 5 to 8) and logic data from CH A and B (none for CH C and D) are saved to file.
- CH 1 data is loaded to CH 1 on the recorder, CH 3 data is loaded to CH 2, and CH A and B data is loaded to CH A and B. (Data is not loaded from CH 2 or 4.)

**NOTE**

- Waveform data measured using an external sampling cannot be overwrite and load.
- If the functions and/or time axis range of the data stored in the unit differ from those of the data to be loaded, a warning message appears to disable the overwriting and loading process.
- In the X-Y CONT recorder, recorder and memory, and FFT functions (advanced version), the overwriting and loading function is not available.

**NOTE**

- Data stored in the text or BMP format is not readable by the 8835-01.
- Only the waveform data and setup files created by the 8835-01 can be read.
- (\*) When batch saving with the Recorder & Memory, the measurement data (with REC, MEM extensions) are created together with an index file. When only the measurement data are read, these are read to the respective functions. To read to the Recorder & Memory, read the index file.
- (\*) Do not change or delete the name of a file to be batch read. The batch reading may not be executed correctly. (\*): Advanced version
- In case of "overwrite load, the settings specified in the 8835-01 take precedence over other settings (see "File contents" in Section 13.4.5).

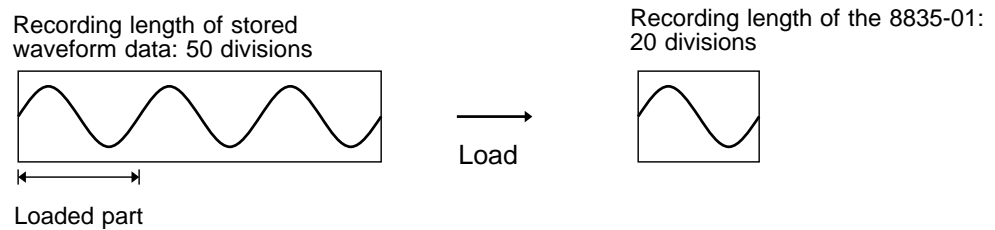
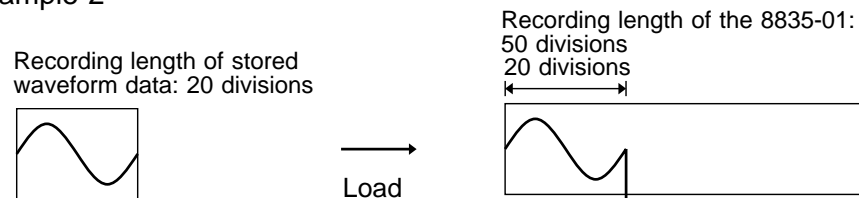
**Example 1****Example 2****Auto setup function**

When the power is switched on with a floppy disk or PC card inserted, the setting up of the 8835-01 is performed automatically by reading the setting data file called **STARTUP.SET** on the floppy disk.

The same measurement conditions can be simply established by using this function.

**Method**

Define the setup data file name as **STARTUP.SET**, and save the file to the root directory of the floppy disk or PC card. The file is read to the 8835-01 when the equipment is turned on.

**NOTE**

When **STARTUP.SET** is in both floppy disk and PC card, file is read from floppy disk.

### 3. INFO

File information is displayed.

The settings for the function, recording length, time axis range and trigger time are displayed.

#### Method

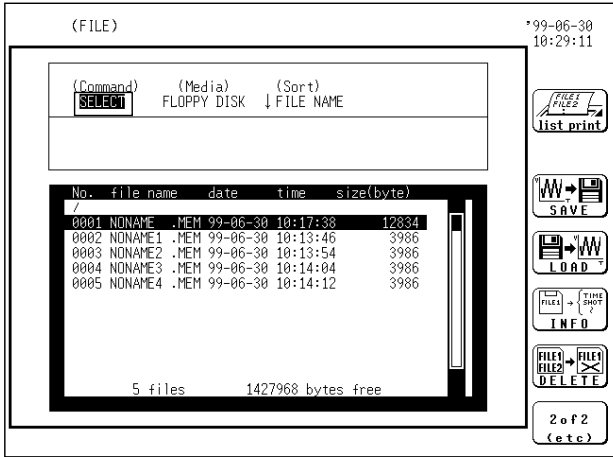

1. Use the JOG control or the CURSOR keys to select the desired file name.

2. Move the flashing cursor to the position shown in the figure on the left, and use the function keys to select INFO.

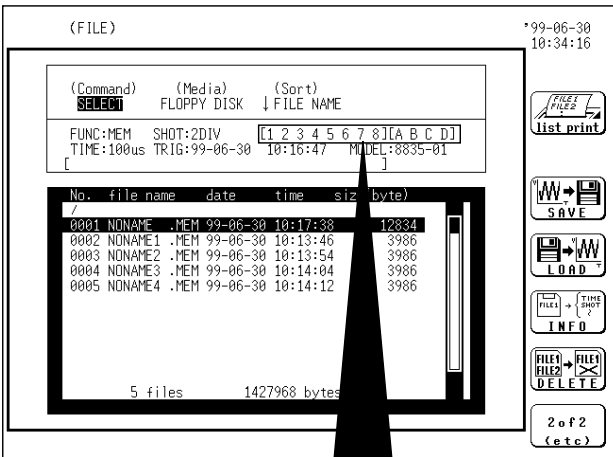

3. Information about the selected file is displayed, as shown in the figure on the left.

[1 2 3 4 5 6 7 8] [A B C D]  
 Analog Logic

The above numerals and letters show the channels to which the data is saved.

For channels having no data, an asterisk "\*" is shown in place of a character.

**NOTE**

Information about only the files readable by the 8835-01 is displayed.

- FUNC: Function
- SHOT: Recording length
- TIME: Time axis range
- TRIG: Trigger time

## 4. DELETE

The file on the floppy disk or PC card is deleted.

### Method

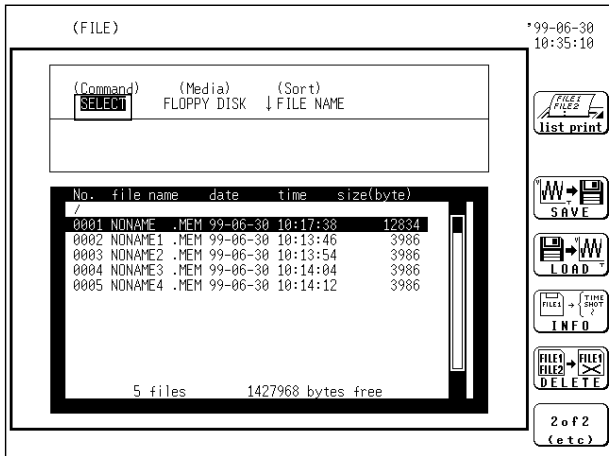

1. Use the CURSOR keys or the JOG control to select the desired file name.
2. Move the flashing cursor to the position shown in the figure on the left, and use the function keys to select DELETE.

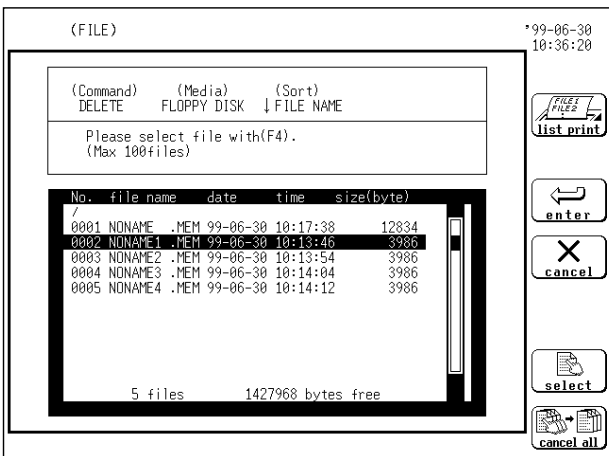

3. To delete more than one file, use the CURSOR keys or the JOG control and move line cursor to files. Select Choose File in function key display. Pressing key again cancels Choose File.



: Specifies file to delete.



: Cancels selecting files to delete.

4. After selecting files to delete, select Confirm in function key display.



: Confirms files to delete.



: Cancels deleting.

5. Select YES in function key display.



: Deletes selected files.



: Cancels deleting.

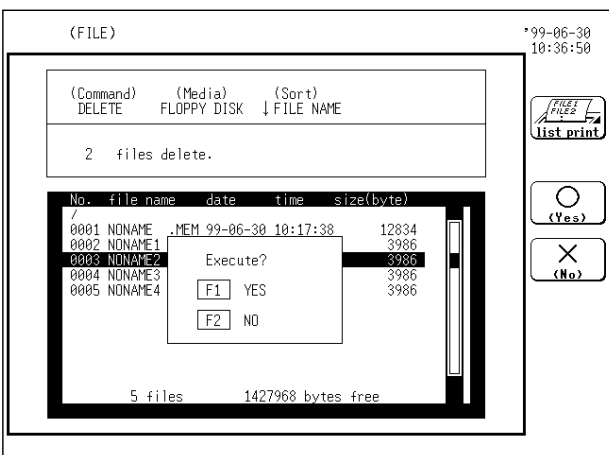

#### NOTE

- Up to 100 files can be deleted at one time.
- Delete appears in function key display when file is selected by line cursor.

## 5. Sorting Files

- Sorts files by selecting options in the file screen.
- Options for sorting are file name, data, file size and category (extension).

### Method

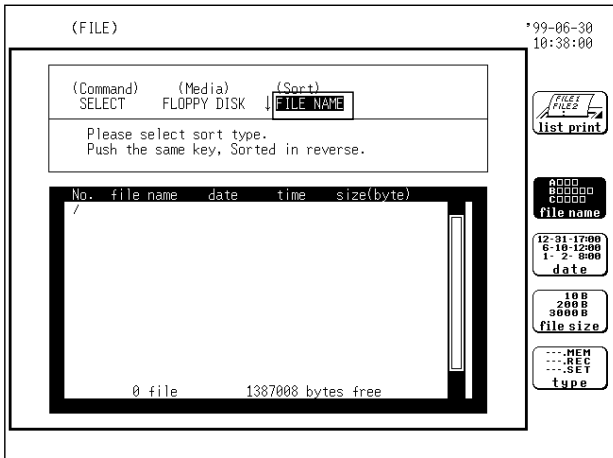

1. Move the flashing cursor to the position shown in the figure on the left.
2. Use the function keys to make the selection. Select reverse function key for reverse sorting.

- : Sort by file name.
- : Sort by data.
- : Sort by file size.
- : Sort by category (extension).

**NOTE**

When sorting directory and file together, directory is prioritized.

## 6. Copying File

Copies file to other media.

### Method

(Copy from floppy disk to PC card.)

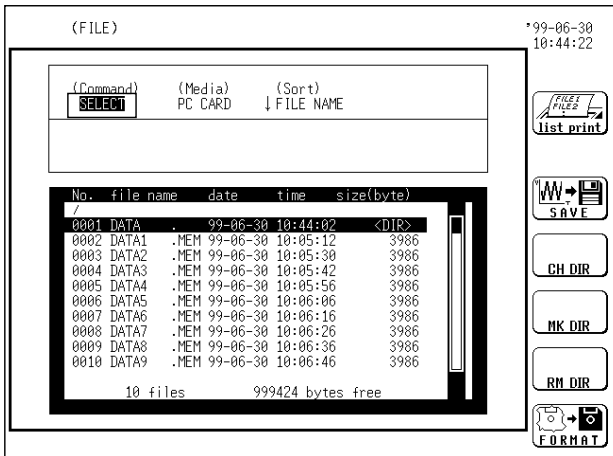

1. Choose media destination
2. Choose directory destination. (see 8. CH DIR.)



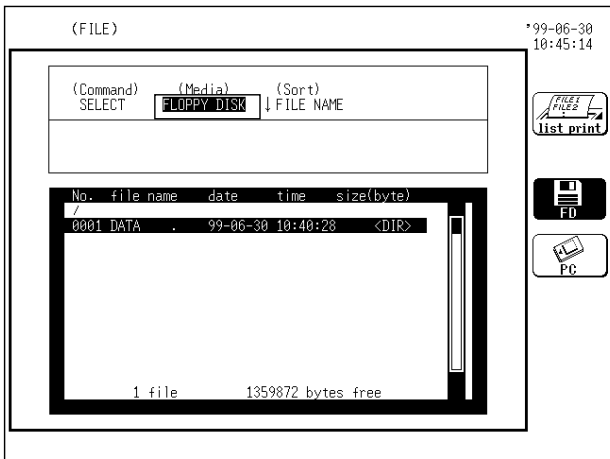

3. Choose media origin.

4. Select file to copy.

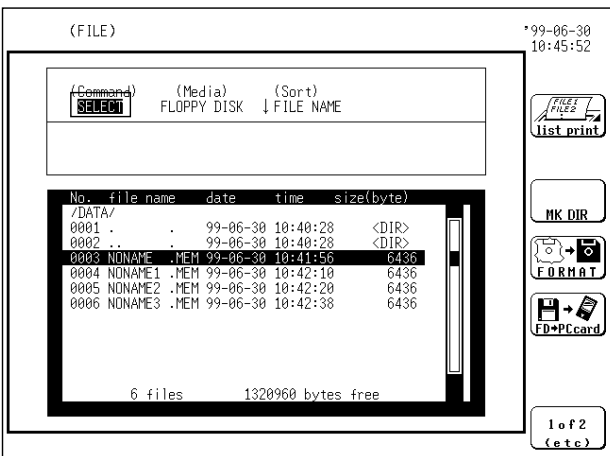

5. Select from function key display **F3**.

Function key varies depending on the media origin.

 : Copies file from floppy disk to PC card.

 : Copies file from PC card to floppy disk.

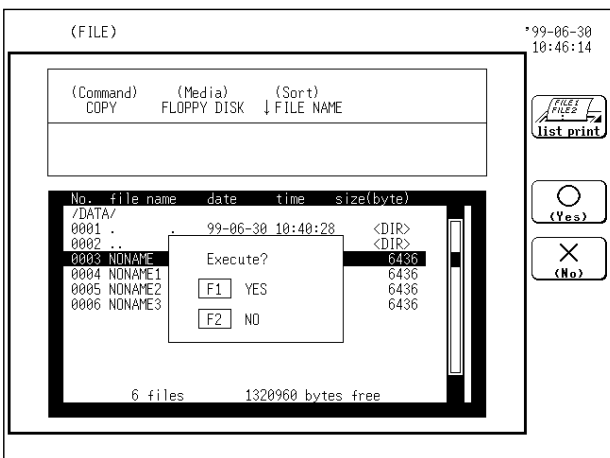

6. Select YES in function key display.

## 7. MKDIR

A subdirectory is created.

### Method

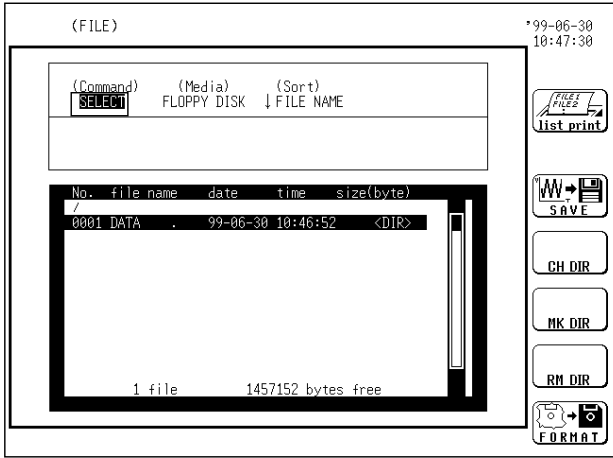

1. Move the flashing cursor to the position shown in the figure on the left, and use the function keys to select MKDIR.

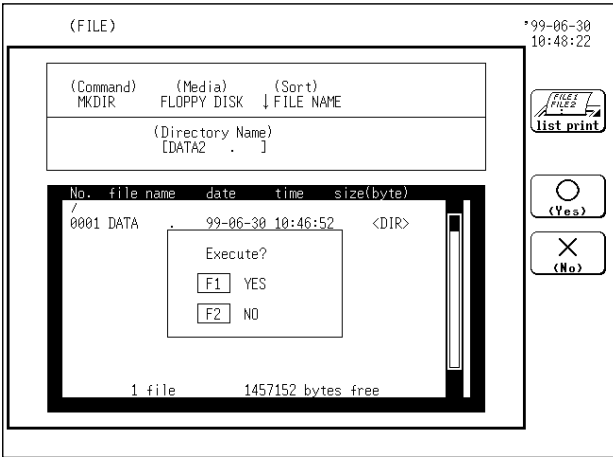

2. Enter the directory name (see Section 9.5).
3. Press the (exec) function key.

**NOTE**

A directory cannot be created, unless the directory name is set.

## 8. CH DIR

A direcorey is changed.

### Method

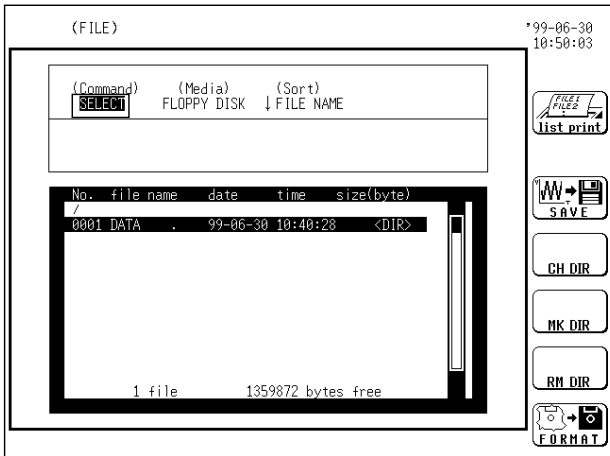

1. Use the JOG control or the CURSOR keys to select the desired directory name.
2. Use the function keys to select CH DIR.

### NOTE

- The 8835-01 provides direct movement only one layer up or down in the directory hierarchy.
- To move to the parent directory, select a directory with "..".

## 9. RM DIR

- A directory is deleted.
- Deletes directory with files included in directory.

### Method

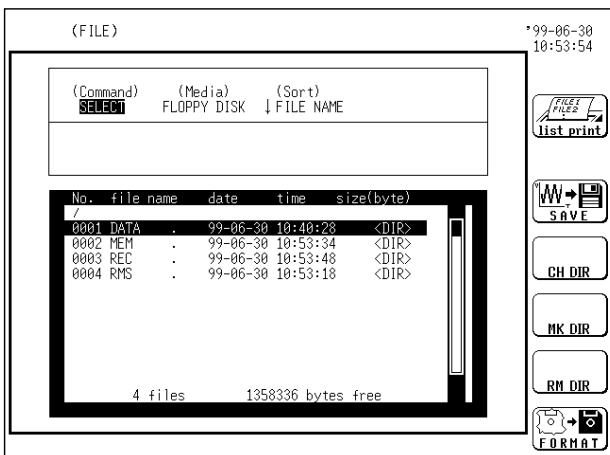

1. Use the JOG control or the CURSOR keys to select directory to be deleted in the file list.

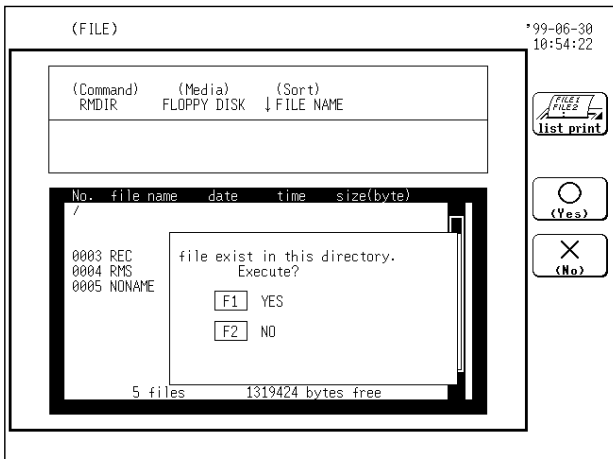

2. Use the function keys to select RM DIR.
  3. Select Yes in function key display. When there is a file in the directory, a question is displayed to confirm deleting or cancel deleting.
  4. Select YES in function key display.
- (Yes) : Delete the selected directory.  
 (No) : Cancel the deletion procedure.

### 10. List Print Files

- Prints file list including directory displayed in the file screen.
- Prints file list to the destination designated by **PRINT** key.

#### Method 1 Screen: FILE

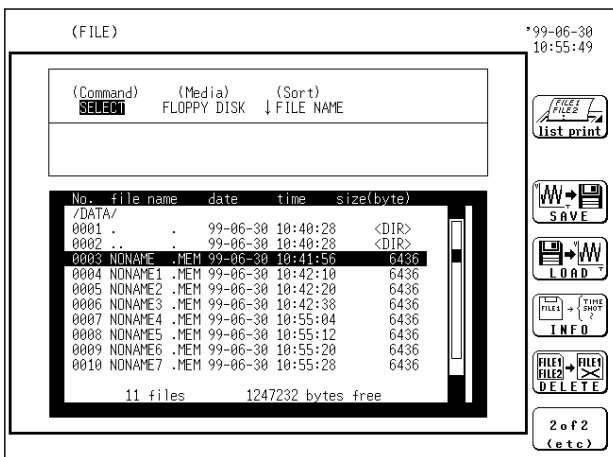

1. Display file list to be printed. When printing data in subdirectory, move it into directory to be printed.
2. Press **VIEW** key for printing.

**NOTE**

Data printed by list printing is what is displayed in the file screen. When printing directory, list of directories is printed, not including data in directories.

---

## 13.5 Using a PC Card on a Personal Computer

---

### 13.5.1 Windows 95

Flash ATA card and hard disk card inserted in PC card slot are ready for use without any other setting.

The SRAM card cannot be used in the initial setup state of Windows 95.

It is necessary to make the following settings.

- (1) Open Explorer.
- (2) In the Explorer View menu, click Options. In the View tab of the dialog box, under Hidden Files, select "Show All Files," and click OK to close the dialog box.
- (3) With Explorer, find the file config.sys in the Window 95 folder.
- (4) Click the config.sys file, to edit it with Notepad or another editor.
- (5) Add the following to the config.sys file.

```
DEVICE=DRIVE:WINDOWS\SYSTEM\CSMAPPER.SYS
```

```
DEVICE=DRIVE:WINDOWS\SYSTEM\CARDDR.V.EXE/SLOT=The number of slots
```

Here the DRIVE is the drive on which Windows 95 is installed.

Example: for a PC/AT compatible

```
DEVICE=C:\WINDOWS\SYSTEM\CSMAPPER.SYS
```

```
DEVICE=C:\WINDOWS\SYSTEM\CARDDR.V.EXE/SLOT=2
```

- (6) Restart the computer. Turn the power temporarily off and then on again. This completes the setting process.  
If the settings are correct, the PC card drive will appear as a removable drive in the "My Computer" folder.

---

### 13.5.2 Windows 3.1 and MS-DOS

Install the SRAM card driver supplied with the personal computer.

For more details, refer to its instruction manual.



# Chapter 14

## Specifications

### 14.1 General Specifications

#### 14.1.1 Basic Specifications

Measurement functions	Measurement function	Feature	Version
	Memory recorder	High-speed data saving	Basic version
	Recorder	Real time recording	
	RMS recorder	For commercial power supplies	
	Recorder & Memory	Real time recording & High-speed data saving	Advanced version
	FFT	Frequency analysis	

Number of channels (maximum)	8 analog channels + 16 logic channels (The logic channels are standard equipment for the 8835-01, common ground with main unit)
Memory capacity	4 M words When 1 channel is in use: 12 bits × 4 M words /channel When 2 channels are in use: 12 bits × 2 M words /channel When 4 channels are in use: 12 bits × 1 M words /channel When 8 channels are in use: 12 bits × 500 K words /channel
Maximum sampling period	1 μs (all channels simultaneously) (Maximum sampling speed: 1 MS/s, all channels simultaneously)
Time axis accuracy	± 0.01% (difference between grid and actual time)
Input method	Plug-in analog units
External control connections	External trigger input, trigger output, GO/NG output, external start/stop, print input
Time measurement functions	Auto calendar with automatic leap year, 24 hour clock
Backup battery and lifetime	Used for clock and to preserve settings, approx. 10 years (reference value at 25 °C) To preserve waveforms, more than approximately one hour after shutting down MEMORY HiCORDER power (requires a minimum of two minutes upon power up) (reference value at 25 °C)

Operational ranges for temperature and humidity	Temperature: 5 to 40 (41°F to 104°F) Relative humidity: 35% to 80%RH (with no condensation)
Operating place	Max. 2000 m (6562 feet) height, indoors
Temperature and humidity ranges for assured accuracy Guaranteed accuracy period	Temperature: 23 ± 5 (73 ± 9°F) Relative humidity: 35% to 80%RH (with no condensation) For 1 year
Temperature and humidity ranges for storage	Temperature: -10 to 50 (14°F to 122°F) Relative humidity: 20% to 90%RH (with no condensation)
Insulation resistance	At least 100 M /500 VDC
Dielectric strength	One minute at 1.35 kVAC between the main unit and the power supply Value between the input unit and main unit, and between input units, depends on which units are installed. See Section 15.2.
Power supply	Rated power voltage 100 to 120 VAC, 200 to 240 VAC (auto-switching) Rated power frequency 50/60 Hz 10 to 28 VDC (the optional DC power adapter is used) (Voltage fluctuations of 10% from the rated supply voltage are taken into account.)
Maximum rated power	AC: 150 VA (55 W) (when 2 8936 ANALOG UNITS are installed) DC: 80 VA (80 W) (when 2 8936 ANALOG UNITS are installed) AC: 230 VA (95 W) (when 2 8940 F/V UNITS are installed) DC: 80 VA (80 W) (when 2 8940 F/V UNITS are installed and 2 ch current testing is ON)
Dimensions	Approx. 285W × 220H × 132D mm (11.22"W × 8.66"H × 5.20"D) (excluding projections)
Mass	Approx. 4.5 kg (158.73 oz.)
Standards applying	EMC EN61326 ClassA EN61000-3-2 EN61000-3-3 Safety EN61010 Pollution Degree 2, Measurement Category II (anticipated transient overvoltage: 4000 V)



## 14.1.2 Recorder

Method of recording	Thermosensitive recording method using a thermal line head
Recording paper	Roll type thermosensitive paper, 110 mm × 30 m (long)
Width of recording	Total recording width: 104 mm ± 0.3 mm (832 dots) Waveform portion: 100 mm ± 0.3 mm f.s. (1 DIV=10 mm)
Recording speed	Approx. 25 mm/s max.
Paper feed accuracy	± 1% (25 , 60%RH)

## 14.1.3 Display

Display language	Japanese/English (selectable)
Screen	6.4 inch TFT color LCD display (640 × 480 dots)
Display resolution	In the memory recorder, recorder and RMS recorder functions (1 DIV = 50 (horizontally) × 40 (vertically) dots) · Waveform: 10 DIV × 10 DIV f.s. · Text: 40 characters × 30 lines In X-Y format (1 DIV = 40 dots) · Waveform: 10 DIV × 10 DIV f.s. · Text: 40 characters × 30 lines
Dots spacing	0.204 (H) × 0.202 (V) mm
Backlight lifetime	Approx. 50000 hours

**NOTE**

TFT color LCDs characteristically have a few defective pixels that do not always light, or that remain lit.

We do not consider the presence of six or fewer such defects to indicate a damaged or faulty display. Please be aware of this in advance.

## 14.1.4 External Data Storage

### (1) Floppy disk

Device	3.5-inch floppy disk drive
Capacity	<ul style="list-style-type: none"> <li>• 1.44 MB (2HD) (IBM PC/AT compatible or NEC PC-9801 series with 3-mode drive)</li> <li>• 1.2 MB (2HD) (NEC PC-9801 series)</li> <li>• 720 KB (2DD) (IBM PC/AT compatible)</li> </ul>
Data format	MS-DOS format* <sup>1</sup>
Data stored	Settings, measurement data, waveform decision area (advanced version), screen data (Measurement data can be saved between cursors A and B.)

### (2) PC card

Expansion slot	<ul style="list-style-type: none"> <li>• PC card standard (1 slot)</li> <li>• Accepts TYPE I, II, III PC cards</li> </ul>
Card types	SRAM card, flash ATA card, hard disk drive card (HDD) Use only PC Cards sold by HIOKI.
Card capacity	32 MB max. (SRAM), 1 GB max. (flash, HDD)
Data format	MS-DOS format* <sup>1</sup>
Data stored	Settings, measurement data, waveform decision area (advanced version), screen data (Measurement data can be saved between cursors A and B.)

\*1: MS-DOS is the registered trademark of Microsoft Corporation.

## 14.1.5 Interface

GP-IB	<ul style="list-style-type: none"> <li>• Complies with IEEE 488.2-1987</li> <li>• Remote control including input unit is possible.</li> <li>• The optional 9558 GP-IB CARD is used. (Option)</li> </ul>
RS-232C	<ul style="list-style-type: none"> <li>• Complies with EIA RS-232C</li> <li>• Remote control including input unit is possible.</li> <li>• The optional 9557 RS-232C CARD is used. (Option)</li> </ul>
LAN	<ul style="list-style-type: none"> <li>• Complies with IEEE 802.3i (Ethernet 10BASE-T)</li> <li>• Remote control including input unit is possible.</li> <li>• The optional 9578 10BASE-T LAN CARD is used. (Option)</li> <li>• Commercially available LAN cards (compatible cards) can be used.</li> <li>• Remote measurement and data collection are possible using the 9333 LAN COMMUNICATOR.</li> </ul>
Printer	<ul style="list-style-type: none"> <li>• Complies with PC-AT centronics</li> <li>• Color printing available with connection to external printer</li> <li>• The optional 9559 PRINTER CARD is used. (Option)</li> </ul>

## 14.1.6 Others

Accessories	Grounded three-core power cord	1
	Ground adapter	1
	Recording paper	1
	Protective cover	1
	Roll paper attachment	2
	PC card protector	1
	Instruction Manual	1
	Waveform viewer(Wv)FD	1
Options	9540-01 FUNCTION UP DISK	
	8936 ANALOG UNIT	
	8937 VOLTAGE/TEMP UNIT	
	8938 FFT ANALOG UNIT	
	8939 STRAIN UNIT	
	8940 F/V UNIT	
	8946 4 ch ANALOG UNIT	
	8947 CHARGE UNIT	
	9439 DC POWER ADAPTER	
	9221 RECORDING PAPER (10 rolls)	
	9557 RS-232C CARD	
	9558 GP-IB CARD	
	9559 PRINTER CARD	
	9333 LAN COMMUNICATOR	
	9335 WAVE PROCESSOR	
	9578 10BASE-T LAN CARD	
	9626 PC CARD 32 M	
	9627 PC CARD 64 M	
	9726 PC CARD 128 M	
	9727 PC CARD 256 M	
	9728 PC CARD 512 M	
	9729 PC CARD 1 G	
	9388 CARRYING CASE	
	9320 LOGIC PROBE	
	9321 LOGIC PROBE	
	9322 DIFFERENTIAL PROBE	
	9324 POWER CORD (for logic connector)	
	9325 POWER CORD (for the 8940 F/V UNIT sensor connector)	
	9303 PT *	
	9197 CONNECTION CORD (for high voltage, maximum input voltage 500 V)	
	9198 CONNECTION CORD (for low voltage, maximum input voltage 300 V)	
	9199 CONVERSION ADAPTOR	
	9217 CONNECTION CORD (insulated BNC to insulated BNC)	
	9318 CONVERSION CABLE (for 9270, 9271, 9272, 9277, 9278 and 9279)	
	9319 CONVERSION CABLE (for 3273)	
	9305 TRIGGER CORD	
	220H PAPER WINDER	
3273 CLAMP ON PROBE		
9018-10 CLAMP ON PROBE (10 to 500 A, 40 Hz to 3 kHz)		
9132-10 CLAMP ON PROBE * (20 to 1000 A, 40 Hz to 1 kHz)		
9270 CLAMP ON SENSOR * (20 A, 5 Hz to 50 kHz)		
9271 CLAMP ON SENSOR * (200 A, 5 Hz to 50 kHz)		
9272 CLAMP ON SENSOR * (20/200 A, 5 Hz to 10 kHz)		
9277 UNIVERSAL CLAMP ON CT (20 A, DC to 100 kHz)		
9278 UNIVERSAL CLAMP ON CT (200 A, DC to 100 kHz)		
9279 UNIVERSAL CLAMP ON CT * (500 A, DC to 20 kHz)		
9555 SENSOR UNIT * (used with the 9270 to 9272, and the 9277 to 9279)		
*: Not complied with the CE marking		

## 14.2 Trigger Unit

Trigger Method	Digital comparison															
Trigger modes	<table border="1"> <thead> <tr> <th>Function</th> <th>Available trigger modes</th> <th>Version</th> </tr> </thead> <tbody> <tr> <td>Memory recorder</td> <td>Single, repeat, auto</td> <td rowspan="3">Basic version</td> </tr> <tr> <td>Recorder</td> <td>Single, repeat</td> </tr> <tr> <td>RMS recorder</td> <td>Single, repeat</td> </tr> <tr> <td>Recorder &amp; Memory</td> <td>Single, repeat</td> <td rowspan="2">Advanced version</td> </tr> <tr> <td>FFT</td> <td>Single, repeat, auto</td> </tr> </tbody> </table>	Function	Available trigger modes	Version	Memory recorder	Single, repeat, auto	Basic version	Recorder	Single, repeat	RMS recorder	Single, repeat	Recorder & Memory	Single, repeat	Advanced version	FFT	Single, repeat, auto
Function	Available trigger modes	Version														
Memory recorder	Single, repeat, auto	Basic version														
Recorder	Single, repeat															
RMS recorder	Single, repeat															
Recorder & Memory	Single, repeat	Advanced version														
FFT	Single, repeat, auto															
Trigger source	<p>CH1 to CH8, logic CHA to CHD</p> <ul style="list-style-type: none"> <li>• External trigger</li> <li>• Manual trigger</li> <li>• Timer trigger</li> </ul> <p>Sources can be set on or off. When all sources are off, the unit is in the free-run state.</p> <p>Trigger conditions can be set for each channel individually.</p> <p>With an external trigger, the triggering occurs on a falling edge of 2.5 V, or when the terminals are shorted together.</p>															
Trigger conditions	Logical AND or OR of any trigger sources															
Trigger types (analog)	<p>(1) Level trigger</p> <ul style="list-style-type: none"> <li>• Digital setting of voltage values for full scale</li> <li>• Triggering occurs at rising edge (falling edge) of set value.</li> </ul> <p>(2) Window-in, window-out trigger</p> <ul style="list-style-type: none"> <li>• Upper and lower trigger levels can be set.</li> <li>• Triggering occurs when the waveform enters or leaves the defined area.</li> </ul> <p>(3) Voltage drop trigger</p> <p>Triggering occurs when the peak of the voltage falls lower than the setting level (for commercial power supplies).</p> <p>(4) RMS level trigger</p> <p>Digital setting of rms values</p> <p>Triggering occurs at rising edge (falling edge) of set value (for commercial power supplies and DC).</p> <p>(5) Period trigger</p> <p>The period trigger setting determines the period reference voltage and period range beyond which the measured rise (or fall) of the set voltage results in tripping of the period trigger.</p>															
Trigger type (logic)	<p>Pattern trigger specified by 1, 0, and ×</p> <p>(× means that either 1 or 0 is fine.)</p>															
Trigger filter	<ul style="list-style-type: none"> <li>• Memory recorder and recorder &amp; memory functions OFF, 0.1, 0.2, 0.5, 1.0, 1.5, 2.0, 2.5, 5.0, 10.0 DIV</li> <li>• Recorder and X-Y CONT recorder functions (advanced version) ON, OFF</li> </ul>															
Trigger level resolution	0.25 % f.s. (f.s. = 10 DIV)															
Pre-trigger	<p>Memory recorder function, recorder &amp; memory function (advanced version):</p> <p>0, 2, 5, 10, 20, 30, 40, 50, 60, 70, 80, 90, 95, 100, -95 %</p> <p>RMS recorder function: 0, 5, 10 DIV</p>															
Trigger timing	Start, stop, start and stop (recorder function)															
Trigger output	<ul style="list-style-type: none"> <li>• Open collector output (with 5 V output voltage, active low)</li> <li>• Pulse width 10 ms min.</li> </ul>															
Trigger input and output connectors	Mini-jack (3.5 mm dia.)															

## 14.3 Memory Recorder Function

Time axis	100, 200, 500 $\mu$ s/DIV 1, 2, 5, 10, 20, 50, 100, 200, 500 ms/DIV 1, 2, 5, 10, 30 s/DIV 1, 2, 5 min/DIV External
Time axis resolution	100 points/DIV
Sampling period	1/100 of the time axis
Recording length	Any setting <sup>(*)1</sup> or preset setting (see below) 20, 50, 100, 200, 500, 1000, 2000, 5000, 10000 <sup>(*)2</sup> , 20000 <sup>(*)3</sup> , 40000 <sup>(*)4</sup> DIV
Screen • print format	Single, dual, quad screen display, X-Y (dot), X-Y (line)
Recording line display	12-color
Superimposition function	Provided
Waveform magnification/ compression	• Time axis × 10, × 5, × 2, × 1, × 1/2, × 1/5, × 1/10, × 1/20, × 1/50, × 1/100, × 1/200, × 1/500, × 1/1000, × 1/2000, × 1/5000 • Voltage axis × 10, × 5, × 2, × 1, × 1/2
Waveform scrolling	Available in the left/right directions
Auto-print	ON/OFF switchable. Automatically prints the memorized waveform
Manual print	Available
Partial print	Prints between the A and the B cursors
Print smoothing function	When set, a smoothed waveform is printed, with twice the density in the time axis direction.
Logging function	Records measured data as digital values
Variable function	Provided
Vernier function	Provided

\*1: Set from 1 division to the maximum number of divisions at 1-division intervals

\*2: When 4 channels are in use

\*3: When 2 channels are in use

\*4: When 1 channel is in use

## 14.4 Recorder Function

Time axis	10 <sup>(*)</sup> , 20 <sup>(*)</sup> , 50 <sup>(*)</sup> , 100 <sup>(*)</sup> , 200 <sup>(*)</sup> , 500 ms/DIV 1, 2, 5, 10, 30 s/DIV 1, 2, 5, 10, 30 min/DIV 1 h/DIV
Time axis resolution	100 points/DIV (with the printer)
Sampling period	1, 10, 100 $\mu$ s, 1, 10, 100 ms (Can be selected, from 1/100 of the time axis setting)
Recording length	Any setting <sup>(*)2)</sup> or preset setting (see below) 20, 50, 100, 200, 500, 1000, 2000 DIV, continuous <sup>(*)3)</sup>
Screen · print format	Single, dual, quad screen display X-Y screen display
Interpolation function	Line (other than X-Y), dot, line (X-Y)
Recording line display	12-color
Spatial resolution	40 dots/DIV (with the display) 100 dots/DIV (horizontally), 80 dots/DIV (vertically) (with the printer)
X-Y sampling period	Dot: 100 $\mu$ s fixed, line: 100 $\mu$ s to 6 ms
Waveform magnification/ compression	· Time axis × 1, × 1/2, × 1/5, × 1/10, × 1/20, × 1/50, × 1/100, × 1/200 · Voltage axis × 10, × 5, × 2, × 1, × 1/2
Waveform storage	Last 2000 divisions of data saved in memory Can be checked by reverse scrolling and reprinted
Print function	Can be set to ON, OFF, or reprint.
Additional recording function	ON/OFF <sup>(*)4)</sup>
Logging function	Records measured data as digital values
Variable function	Provided
Vernier function	Provided

\*1: Although real-time recording to the recording paper is not possible in the high-speed range (10 to 200 ms/DIV), the waveforms are stored to the memory and can therefore be monitored on the screen. The last 2000 divisions of each waveform are retained in memory before the measurement is complete. If the recording length is not set to "continuous," the printer can also be operated, enabling the waveforms to be printed out later.

\*2: Set from 1 division to the maximum number of divisions at 1-division intervals

\*3: With time axis 10 to 200 ms/DIV, "continuous" is not possible with printer ON.

\*4: Additional recording function (recording data without paper)

- When enabled, the memory is regarded as printer paper. Recording starts at the end of previous data, without erasing them. When the recording length has been reached, old data will be overwritten.

- When OFF, previous data will be erased. Set to ON if erasing is not desired.

## 14.5 RMS Recorder Function

Time axis	5, 10, 30 s/DIV 1, 2, 5, 10, 30 min/DIV 1 h/DIV
Time axis resolution	100 lines/DIV (with the printer)
Sampling period	20 rms data/s (200 $\mu$ s fixed)
RMS accuracy	$\pm 3\%$ f.s. (at 50/60 Hz $\pm 2$ Hz, DC) (f.s.=10 DIV)
Measuring object	Commercial power supplies (50/60 Hz), DC
Recording length	Any setting <sup>(*)1</sup> or preset setting (see below) 20, 50, 100, 200, 500, 1000, 2000 DIV, continuous
Screen $\cdot$ print format	Single, dual, quad screen display
Recording line display	12-color
Waveform magnification/ compression	<ul style="list-style-type: none"> <li><math>\cdot</math> Time axis <math>\times 1, \times 1/2, \times 1/5, \times 1/10, \times 1/20, \times 1/50, \times 1/100, \times 1/200</math></li> <li><math>\cdot</math> Voltage axis <math>\times 10, \times 5, \times 2, \times 1, \times 1/2</math></li> </ul>
Waveform storage	Last 2000 divisions of data saved in memory Can be checked by reverse scrolling and reprinted
Print function	Can be set to ON, OFF, or reprint.
Additional recording function	ON/OFF <sup>(*)2</sup>
Logging function	Records measured data as digital values
Variable function	Provided
Vernier function	Provided

\*1: Set from 1 division to the maximum number of divisions at 1-division intervals

\*2: Additional recording function (recording data without paper)

When enabled, the memory is regarded as printer paper. Recording starts at the end of previous data, without erasing them. When the recording length (2000 DIV) has been reached, old data will be overwritten.

## 14.6 Recorder & Memory Function (Advanced Version)

Time axis	<ul style="list-style-type: none"> <li>• Recorder               <ul style="list-style-type: none"> <li>500 ms/DIV</li> <li>1, 2, 5, 10, 30 s/DIV</li> <li>1, 2, 5, 10, 30 min/DIV</li> <li>1 h/DIV</li> </ul> </li> <li>• Memory               <ul style="list-style-type: none"> <li>100, 200, 500 <math>\mu</math>s/DIV</li> <li>1, 2, 5, 10, 20, 50, 100, 200, 500 ms/DIV</li> <li>1, 2, 5, 10, 30 s/DIV</li> <li>1, 2, 5 min/DIV</li> </ul> </li> </ul>
Time axis resolution	100 points/DIV
Sampling period	1/100 of the time axis.....memory waveform
Recording length	Any recording length <sup>(*)</sup> or preset setting (see below) 20, 50, 100, 200, 500, 1000 DIV, continuous (recorder) 20, 50, 100, 200, 500, 1000, 2000 DIV (memory)
Screen • print format	Single, dual, quad screen display
Display	Switchable between recorder and memory waveforms
Printer output	During measurement operation, recorder waveform only. After data capture, printout of recorder waveform as on display or memory waveform.
Waveform storage (recorder)	Last 1000 divisions of data saved in memory Can be checked by reverse scrolling and reprinted
Additional recording function	ON/OFF <sup>(**)</sup>
Trigger source	CH1 to CH8, CHA to CHD and external trigger (memory)
Trigger mode	Single, repeat, timer (recorder)
Ancillary function	Sequential save
Variable function	Provided
Vernier function	Provided

\*1: Set from 1 division to the maximum number of divisions at 1-division intervals

\*2: Additional recording function (recording data without paper)

At start choose ON or OFF to process recorded data.

OFF: Deletes recorded data and records from the beginning.

ON: Saves recorded data and continues recording.

When total recorded data reaches over 1000 DIV, overwrites previous data from the beginning.



## 14.7 FFT Function (Advanced Version)

FFT channel mode	1 channel FFT, 2 channel FFT
FFT range setting	133 mHz to 400 kHz, external
Dynamic range	72 dB (logical value)
Number of sampling points	1000, 2000, 5000, 10000
Frequency resolution	1/400, 1/800, 1/2000, 1/4000
Antialiasing filter	Automatic cutoff frequency selection linked to frequency range
Analysis channel setting	1 channel FFT, 2 channel FFT for any channel
FFT analysis mode setting	Storage waveform, linear spectrum, RMS spectrum, power spectrum, cross-power spectrum, auto-correlation function, histogram, transfer function, cross-correlation function, unit-impulse response, coherence function, octave analysis
Display format setting	Single, dual screen display, Nyquist display
Window functions	Rectangular, hanning, exponential
Display scale	Linear scale, log scale, phase
Print function	As per the memory recorder function, excluding partial print function
Averaging function	Additive average of time and frequency domains, exponential averaging, peak hold (2, 4, 8 to 4096 samples)
Variable function	Provided
Vernier function	Not provided

## 14.8 Advanced Version

It is possible to upgrade the basic version to the advanced version, using the 9540-01 FUNCTION UP DISK available as an option.

Measurement functions	Recorder & Memory (real time recording & high-speed data saving) FFT (frequency analysis)
Computation functions (memory recorder function)	
Waveform processing calculations	Arithmetic operations, absolute value, exponents, common logarithms, square roots, moving average, 1st and 2nd derivatives, 1st and 2nd integrals, time axis parallel shift
Averaging function	Memory recorder function: Additive averaging (2, 4, 8 to 256 samples) FFT function: Simple averaging, exponential averaging, peak hold (2, 4, 8 to 4096 samples)
Waveform decision (memory recorder function)	
① Waveform area decision	Waveform decision based on reference area for Y-T waveform, X-Y waveform, or FFT results
Decision modes	Out: fail if any part of waveform is outside reference area All out: fail if whole of waveform is outside reference area
Stop conditions	GO (pass) stop, NG (fail) stop, GO & NG stop Printer output or waveform save at stop
Decision output	GO and NG outputs on side panel: open collector outputs (with 5 V output, active low, pulse width 10 ms min.)
② Waveform parameter decision	Decision based on setting minimum and maximum values for waveform parameter calculation results
Graphics editor	Provided, used for defining an arbitrary reference area for waveform decisions
Editor commands	Paint, parallel shift, lines, eraser, loading waveform, reverse, screen clear, delete within area, cancel, save new area, close editor
Memory segmentation	
Memory segmentation function	Memory can be segmented among channels.
Number of segments	Maximum 255 Multi-block Sequential saving

## 14.9 Auxiliary Function

Waveform parameter calculations	Average value, effective value, peak-to-peak value, maximum value, time to maximum value, minimum value, time to minimum value, period, frequency, rise time, fall time, area value, XY area value, standard deviation
---------------------------------	--

## 14.10 Others

Comment printing	Function, channel, input range, zero position, trigger time, DIV and other information can be printed.
Cursor measurement function	Time difference, voltage difference or number of cycles between cursors A and B, voltage at each cursor, time from trigger
Scaling function	Specifiable for each channel
Comment input function	Provided
Display copy function	Provided
List · gauge functions	ON, OFF
Waveform backup function	Provided (more than approximately one hour after shutting down MEMORY HiCORDER power, requires a minimum of two minutes upon power up)
Starting status backup function	Provided
Auo setup function	When the power is turned on, settings and a waveform decision area stored on a floppy disk can be automatically loaded. (waveform decision area: advanced version)
Auto save function	Provided
Remote control	Start, stop and print control terminals (threshold value: 2.5 V ± 1 V, active low, or terminal short)
Auto-range function	Provided, selects optimum time axis and voltage axis for input waveform
VIEW function	<ul style="list-style-type: none"> <li>· In memory recorder and recorder functions, shows relative positions of displayed data within recording length and to full-scale point.</li> <li>· In memory recorder function, when memory segmentation is used, usage condition of each block is shown (advanced version).</li> </ul>
On-line help	Pressing the HELP key brings up a brief explanation of procedures for using the current function or feature.
GP-IB	<ul style="list-style-type: none"> <li>· Complies with IEEE 488.2-1987</li> <li>· Remote control including input unit is possible.</li> <li>· The optional 9558 GP-IB CARD is used.</li> </ul>
RS-232C	<ul style="list-style-type: none"> <li>· Complies with EIA RS-232C</li> <li>· Remote control including input unit is possible.</li> <li>· The optional 9557 RS-232C CARD is used.</li> </ul>
Key lock function	Locks all keys except the KEY LOCK key
LCD back lighting	ON, OFF (with the auto OFF function)
List print function	<ul style="list-style-type: none"> <li>· Settings output after waveform data print (selectable on/off)</li> <li>· Output by pressing PRINT key other than on display screen</li> </ul>
Zoom function	Provided (memory recorder function only)
Customer color setting	Provided

## 14.11 9439 DC POWER ADAPTER Specifications

- Used for operating the unit on DC power.
- Connect DC power adapter output to 8835-01, and connect DC source (battery etc.) to adapter input.
- Accuracy at  $23 \pm 5$  ( $73^{\circ}\text{F} \pm 9^{\circ}\text{F}$ ), 35% to 80%RH after 30-minute warming-up time
- Guaranteed accuracy period: 1 year

Input voltage range	10 to 28 VDC
Rated output voltage	24 VDC
Output voltage accuracy	$24 \pm 1$ VDC
Rated output current	2.2 A
Efficiency	70% min. (under rated output conditions)
Output over-current protection	Detected at 110%+15% or -5% of rated output current (output shutoff)
Output over-voltage protection	Detected at 115% $\pm$ 5% of rated output voltage (output shutoff)
Maximum rated power	80 VA
Operational ranges for temperature and humidity	Same as the 8835-01 MEMORY HiCORDER
Temperature and humidity ranges for storage	-10 to 50 ( $14^{\circ}\text{F}$ to $122^{\circ}\text{F}$ ), 20% to 90%RH (with no condensation)
Operating place	Same as the 8835-01 MEMORY HiCORDER
Output indication	Output indicated by the red LED
When used together with AC power supply	When both AC power and the 9439 DC POWER ADAPTER are connected to the 8835-01, AC power has priority. When AC power shuts off, the 8835-01 switches to DC.
Dielectric strength	One minute at 700 VDC (between the input and the output, and between the input and the main unit)
Insulation resistance	100 M $\Omega$ /500 VDC
Dimensions	Approx. 152W $\times$ 92H $\times$ 54D mm (5.98"W $\times$ 3.62"H $\times$ 2.13"D) Input cable: Approx. 2000 mm $\pm$ 100 mm (78.74" $\pm$ 3.94") Output cable: Approx. 300 mm $\pm$ 30 mm (11.81" $\pm$ 1.18")
Mass	Approx. 770 g (27.2 oz.)
Standards applying	EMC EN61326 ClassA Safety EN61010 Pollution Degree 2
Accessories	None

## 14.12 System Operation

System operation is explained according to the block diagram.

- (1) All system operations are controlled by a 32-bit RISC CPU.
- (2) Each input unit incorporates high-speed 12-bit A/D converters which are connected to the main unit via a photocoupler integrated in each input unit. Each channel has its own power supply, to assure electrical isolation from the main unit.
- (3) Measurement data stored in memory are processed by the CPU, displayed on the LCD screen, and output to the printer. Output to floppy disk, the SRAM card, flash ATA card, GP-IB card, RS-232C card or printer card is also provided.

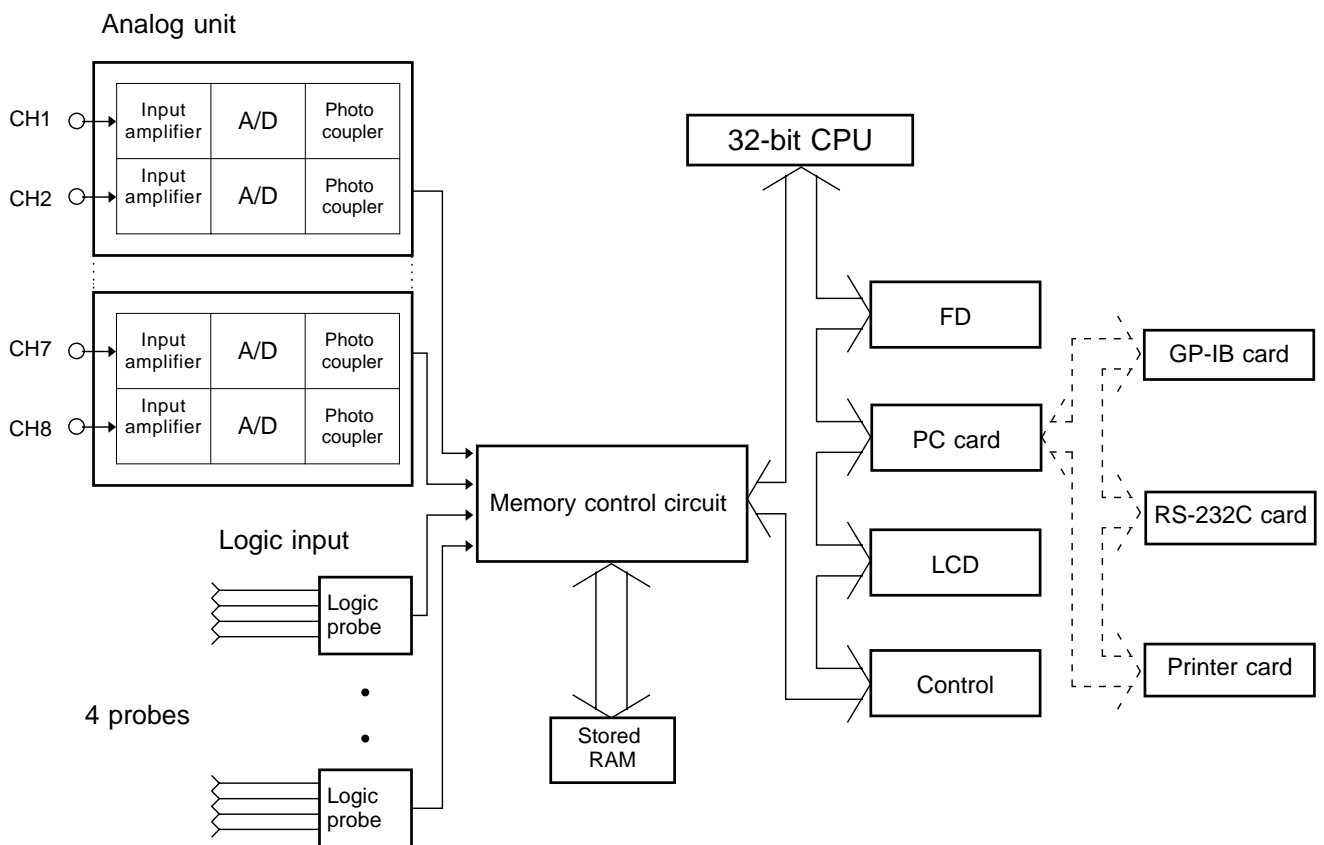

**Block Diagram**

Table 1

Sampling period and maximum recording length for various time axis settings

## 1. Memory recorder function

Time axis range [ /DIV ]	Sampling period	Max. recording length (*1) ( 40000 DIV )
100 $\mu$ s	1.00 $\mu$ s	4 s
200 $\mu$ s	2.00 $\mu$ s	8 s
500 $\mu$ s	5.00 $\mu$ s	20 s
1 ms	10.0 $\mu$ s	40 s
2 ms	20.0 $\mu$ s	1 min 20 s
5 ms	50.0 $\mu$ s	3 min 20 s
10 ms	100 $\mu$ s	6 min 40 s
20 ms	200 $\mu$ s	13 min 20 s
50 ms	500 $\mu$ s	33 min 20 s
100 ms	1.00 ms	1 h 6 min 40 s
200 ms	2.00 ms	2 h 13 min 20 s
500 ms	5.00 ms	5 h 33 min 20 s
1 s	10.0 ms	11 h 6 min 40 s
2 s	20.0 ms	22 h 13 min 20 s
5 s	50.0 ms	2 d 7 h 33 min 20 s
10 s	100 ms	4 d 15 h 6 min 40 s
30 s	300 ms	13 d 21 h 20 min 0 s
1 min	600 ms	27 d 18 h 40 min 0 s
2 min	1.20 s	55 d 13 h 20 min 0 s
5 min	3.00 s	138 d 21 h 20 min 0 s

Time axis resolution: 100 points/DIV

(\*1): When using one channel only

Table 2

Time axis resolution and maximum recording length for various time axis settings

## 2. Recorder function

Time axis range [ /DIV ]	Recording paper feeding speed	Approximate recording time on one roll (30 m) of recording paper
10 ms	20 mm/s	30 s
20 ms	20 mm/s	1 min
50 ms	20 mm/s	2.5 min
100 ms	20 mm/s	5 min
200 ms	20 mm/s	10 min
500 ms	20 mm/s	25 min
1 s	10 mm/s	50 min
2 s	5 mm/s	1 h 40 min
5 s	2 mm/s	4 h 10 min
10 s	1 mm/s	8 h 20 min
30 s	20 mm/min	1 d 1 h
1 min	10 mm/min	2 d 2 h
2 min	5 mm/min	4 d 4 h
5 min	2 mm/min	10 d 10 h
10 min	1 mm/min	20 d 20 h
30 min	20 mm/h	62 d 12 h
1 h	10 mm/h	125 d

Time axis resolution: 100 points/DIV







# Chapter 15

## Logic and Analog Inputs

### 15.1 Logic Inputs

- The logic input is located on the top side of the unit. Up to four probes can be connected.
- Since one logic probe can record 4 channels, the combined maximum recording capability for logic waveforms is 16 channels.

#### WARNING

- The 8835-01 has separate inputs for four probes, but the ground lines of these inputs are not isolated from each other and from the frame ground of the unit (common ground).
- Do not connect logic probes other than supplied by HIOKI to the logic inputs.

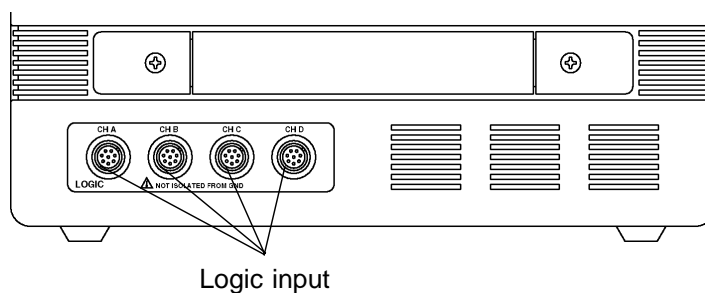

#### NOTE

If no logic probe is connected, the corresponding logic waveform is displayed on the screen at high level.



## 15.1.1 Logic Probes

### 9320 LOGIC PROBE

Input can be switched between voltage input and contact input. Suitable for a wide range of applications, from checking electronic circuits to measuring relay timing.

#### **⚠ DANGER**

The 8835-01 has separate inputs for four probes, but the ground lines of these inputs are not isolated from each other and from the frame ground of the unit (common ground). If voltages with different ground levels are input, probe short-circuiting may occur and lead to accidents.

#### NOTE

- Carefully read the documentation supplied with the 9320.
- The 9306-01 (discontinued) can also be used. Carefully read the documentation supplied with the 9306-01.

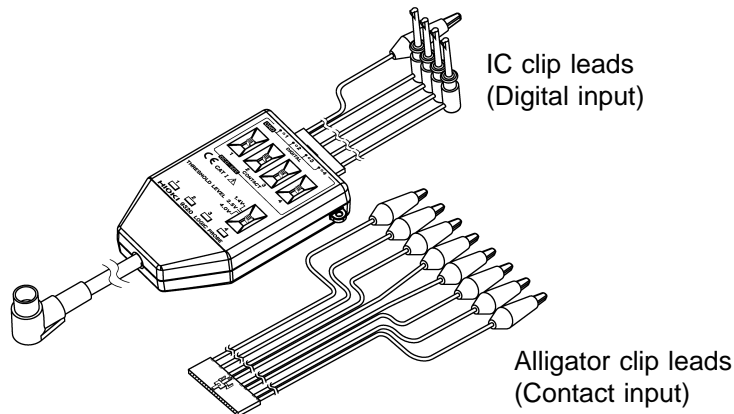



## 9321 LOGIC PROBE

- Can be used to detect the on/off status of AC line voltage. Maximum input voltage is 250 V. The probe is suitable for timing measurements of relay sequencers or similar.
- The probe provides internal isolation between channels and between input and output.

### DANGER

The maximum rated voltage to earth between input and output is 150 Vrms in the low range, and 250 Vrms in the high range. To avoid the risk of electric shock and damage to the unit, make sure that the voltage between input and output does not exceed this value.

### NOTE

- Carefully read the documentation supplied with the 9321.
- The 9307 (discontinued) can also be used. Carefully read the documentation supplied with the 9307.

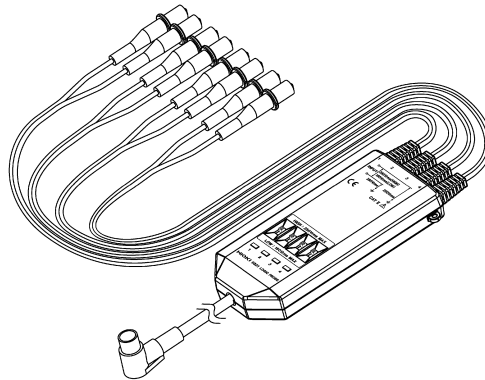

## 15.2 Analog Inputs

### 15.2.1 8936 ANALOG UNIT

Accuracy at  $23 \pm 5$  ( $73^{\circ}\text{F} \pm 9^{\circ}\text{F}$ ), 35% to 80%RH after zero adjustment after 30-minute warming-up time. Accuracy guaranteed for 1 year.

Measurement ranges	10, 20, 50, 100, 200, 500 mV/DIV 1, 2, 5, 10, 20, 50 V/DIV
DC amplitude accuracy	$\pm 0.4\%$ f.s.
Zero position setting range	-50 to 150% of the recording width (in full-size representation of the voltage axis)
Zero position accuracy	$\pm 0.1\%$ f.s. (after zero adjustment)
Temperature characteristic	Gain: $\pm 0.025\%$ f.s./ Zero position: $\pm 0.02\%$ f.s./ (after zero adjustment)
Frequency characteristic	DC to 400 kHz $\pm 3$ dB (DC coupling) 7 Hz to 400 kHz $\pm 3$ dB (AC coupling, low cut-off frequency: 7 Hz $\pm 20\%$ )
Noise	450 $\mu$ Vp-p typical, 750 $\mu$ Vp-p max. (sensitivity range, with input shorted)
Common mode rejection ratio	80 dB minimum (at 50/60 Hz and with signal source resistance 100 $\Omega$ maximum)
Low-pass filter	OFF, 5, 500, 5 k, 100 k $\pm 50\%$ (Hz) -3 dB
Input type	Unbalanced (input isolated from output)
Input resistance	1 M $\Omega$ $\pm 1\%$
Input capacitance	30 pF $\pm 10$ pF (at 100 kHz)
Input coupling	DC, GND, AC
A/D resolution	12 bits
Voltage axis resolution	160 points/DIV
Maximum sampling speed	1 MS/s (sampling period: 1 $\mu$ s)
Input terminals	Insulated BNC terminal
Maximum input voltage	400 V DC max.
Maximum rated voltage to earth	370 V AC/DC (between each input channel and main unit, and between input channels)
Operational ranges for temperature and humidity	Same as the MEMORY HiCORDER in which the 8936 is installed
Operating place	Same as the MEMORY HiCORDER in which the 8936 is installed
Temperature and humidity ranges for storage	Temperature: $-10$ to $50$ ( $14^{\circ}\text{F}$ to $122^{\circ}\text{F}$ ) Relative humidity: 80%RH maximum (with no condensation)
Effect of radiated radio-frequency electromagnetic field	$\pm 2\%$ f.s. at 3V/m
Effect of conducted radio-frequency electromagnetic field	$\pm 28\%$ f.s. at 3V
Dielectric strength	One minute at 3.7 kVAC between the 8936 and the main unit, and between the 8936 and the input unit
Dimensions	Approx. 170W $\times$ 20H $\times$ 148.5D mm (6.69"W $\times$ 0.79"H $\times$ 5.85"D)
Mass	Approx. 290 g (10.2 oz.)
Standards applying	EMC EN61326 ClassA Safety EN61010 Pollution Degree 2, Measurement Category II (anticipated transient overvoltage: 4000 V)

## 15.2.2 8937 VOLTAGE/TEMP UNIT

Accuracy at 23 ± 5 (73°F ± 9°F), 35% to 80%RH after zero adjustment after 60-minute warming-up time. Accuracy guaranteed for 1 year.

### Voltage input

Measurement ranges	1, 2, 5, 10, 20, 50, 100, 200, 500 mV/DIV 1, 2, 5 V/DIV
DC amplitude accuracy	± 0.4% f.s.
Zero position setting range	-50 to 150% of the recording width (in full-size representation of the vertical axis)
Zero position accuracy	± 0.15% f.s.
Temperature characteristic	Gain: ± 0.02%f.s./ Zero position: ± 0.03%f.s./ (after zero adjustment)
Frequency characteristic	DC to 400 kHz $\pm 1$ dB (in 1 mV to 5 V/DIV range) DC to 3 kHz $\pm 1$ dB (with digital filter ON in 1 mV to 5 mV/DIV range) (data update rate: 100 $\mu$ s ± 20%)
Low-pass filter	5, 500, 5k, 100k ± 50% (Hz) (-3 dB)
Noise	75 $\mu$ Vp-p typical, 120 $\mu$ Vp-p max. (with digital filter OFF in 1 mV/DIV range) 20 $\mu$ Vp-p typical, 30 $\mu$ Vp-p max. (with digital filter ON in 1 mV/DIV range)
Input terminal	BNC terminal
Input resistance	1 M ± 1%
Input capacitance	50 pF ± 20 pF (at 100 kHz)
Input coupling	DC, GND, AC

### Temperature input

Measurement ranges	20, 40, 100, 200 /DIV
Measurement input range	K: -200 to 1350 R: 0 to 1700 E: -200 to 800 S: 0 to 1700 J: -200 to 1100 B: 300 to 1800 T: -200 to 400 N: -200 to 1300
Zero position setting range	-100 to 100% f.s. (in full-size representation of the vertical axis)
Temperature measurement accuracy	K, E, J, T, N ± 0.1% f.s. ± 1.0 ± 0.1% f.s. ± 2.0 (-200 to 0 ) R, S ± 0.1% f.s. ± 3 B (effective measurement range: 400 to 1800 ) ± 0.1% f.s. ± 4
Reference junction compensation	Selectable internal or external
Reference junction compensation accuracy	± 0.1% f.s. ± 1.5 (with internal reference junction compensation and input terminal in state of temperature equilibrium)

Temperature characteristic	$\pm 0.05\%$ f.s./ (sensor: K, E, J, T, N, with drift compensation mode OFF) $\pm 0.25\%$ f.s./ (sensor: R, S, B, with drift compensation mode OFF) $\pm 0.04\%$ f.s./ (all sensors, with drift compensation mode ON)
Frequency characteristic	DC to 1 kHz $\pm 1$ dB (data update rate: 250 $\mu$ s $\pm 70\%$ , with drift compensation mode OFF) (data update rate: 1 s $\pm 20\%$ , with drift compensation mode ON)
Low-pass filter	5, 500 $\pm 50\%$ (Hz) (-3 dB)
Input terminals	2-terminal terminal block
Input resistance	5.1 M $\pm 5\%$

### Common specifications

Common mode rejection ratio	80 dB minimum (at 50/60 Hz and with signal source resistance 100 $\Omega$ maximum)
Input type	Unbalanced (input isolated from output)
A/D resolution	12 bits
Maximum sampling speed	1 MS/s (However, update rate differs with temperature input.)
Maximum input voltage	30 V rms or 60 V DC
Maximum rated voltage to earth	30 V rms or 60 V DC
Operational ranges for temperature and humidity	Same as the MEMORY HiCORDER in which the 8937 is installed
Operating place	Same as the MEMORY HiCORDER in which the 8937 is installed
Temperature and humidity ranges for storage	Temperature: -10 to 50 ( $14^{\circ}$ F to $122^{\circ}$ F) Relative humidity: 80%RH maximum (with no condensation)
Effect of radiated radio-frequency electromagnetic field	$\pm 2\%$ f.s. at 3V/m (in the 10 mV/DIV range)
Dielectric strength	One minute at 400 VAC between the 8937 and the main unit, and between the 8937 and the input unit
Dimensions	Approx. 170W $\times$ 20H $\times$ 148.5D mm (6.69"W $\times$ 0.79"H $\times$ 5.85"D) (excluding projections)
Mass	Approx. 300 g (10.6 oz.)
Standards applying	EMC EN61326 ClassA Safety EN61010 Pollution Degree 2, Measurement Category I (anticipated transient overvoltage: 330 V)

## 15.2.3 8938 FFT ANALOG UNIT

Accuracy at 23 ± 5 (73°F ± 9°F), 35% to 80%RH after zero adjustment after 30-minute warming-up time. Accuracy guaranteed for 1 year.

Number of input channels	2
Measurement ranges	10, 20, 50, 100, 200, 500 mV/DIV 1, 2, 5, 10, 20, 50 V/DIV
DC amplitude accuracy	± 0.4% f.s.
Zero position accuracy	± 0.1% f.s. (after zero adjustment)
Temperature characteristic	Gain: ± 0.025%f.s./ Zero position: ± 0.02%f.s./ (after zero adjustment)
Frequency characteristic	DC to 400 kHz ± 3 dB (DC coupling) 7 Hz to 400 kHz ± 3 dB (AC coupling, low cut-off frequency: 7 Hz ± 20%)
Noise	500 μVp-p typical, 750 μVp-p max. (sensitivity range, with input shorted)
Common mode rejection ratio	80 dB minimum (at 50/60 Hz and with signal source resistance 100 maximum)
Low-pass filter	OFF, 5, 500, 5 k, 100 k ± 50% (Hz) -3 dB
Anti-aliasing filter	Cutoff frequency (fc) of 20, 40, 80, 200, 400, 800, 2 k, 4 k, 8 k, 20 k, 40 kHz (selected automatically with anti-aliasing filter ON) Attenuation is -66 dB min. at 1.5 fc.
Input type	Unbalanced (floating)
Input coupling	DC, GND, AC
Input resistance	1 M ± 1%
Input capacitance	30 pF ± 10 pF (at 100 kHz)
A/D resolution	12 bits
Maximum sampling speed	1 MS/s (sampling period: 1 μs)
Input terminals	Insulated BNC terminal
Maximum input voltage	400 V DC max.
Maximum rated voltage to earth	370 V AC/DC (between each input channel and main unit, and between input channels)
Operational ranges for temperature and humidity	Same as the MEMORY HiCORDER in which the 8938 is installed
Operating place	Same as the MEMORY HiCORDER in which the 8938 is installed
Temperature and humidity ranges for storage	Temperature: -10 to 50 (14°F to 122°F) Relative humidity: 80%RH maximum (with no condensation)
Dielectric strength	One minute at 3.7 kVAC between the 8938 and the main unit, and between the 8938 and the input unit
Dimensions	Approx. 170W × 20H × 148.5D mm (6.69"W × 0.79"H × 5.85"D)
Mass	Approx. 290 g (10.2 oz.)
Effect of radiated radio-frequency electromagnetic field	± 2% f.s. at 3V/m
Effect of conducted radio-frequency electromagnetic field	± 28% f.s. at 3V
Standards applying	EMC EN61326 ClassA Safety EN61010 Pollution Degree 2, Measurement Category II (anticipated transient overvoltage: 4000 V)

## 15.2.4 8939 STRAIN UNIT

Accuracy at  $23 \pm 5$  ( $73^{\circ}\text{F} \pm 9^{\circ}\text{F}$ ), 35% to 80%RH after carrying out auto-balancing after 60-minute warming-up time. Accuracy guaranteed for 1 year.

Number of input channels	2
Appropriate adapter	Strain gauge adapter (bridge resistance: 120 to 1 k )
Bridge voltage	$2 \pm 0.05$ V
Balancing	Electronic auto-balancing
Balance adjustment range	$\pm 10000 \mu$ max.
Measurement ranges	50, 100, 200, 500, 1000, 2000 $\mu$ /DIV
DC amplitude accuracy	$\pm (0.5\% \text{ f.s.} + 2 \mu)$ (after auto-balancing)
Zero position accuracy	$\pm 0.5\% \text{ f.s.}$ (after auto-balancing)
Zero position setting range	-50 to 150% of the recording width (in full-size representation of the vertical axis)
Temperature characteristic	Gain: $\pm 0.05\% \text{ f.s./}$ max. (after auto-balancing) Zero position: $\pm 2 \mu /$ max. (50, 100 $\mu$ /DIV ranges), $\pm 0.1\% \text{ f.s./}$ max. (200, 500, 1000, 2000 $\mu$ /DIV ranges)
Frequency characteristic	DC to 20 kHz +1/-3 dB
Low-pass filter	OFF, 10, 30, 300, 3 k $\pm 30\%$ (Hz) -3 dB
A/D resolution	12 bits
Maximum sampling speed	1 MS/s (sampling period: 1 $\mu$ s)
Maximum allowable input voltage	10 V (DC+AC peak)
Maximum rated voltage to earth	30 Vrms or 60 VDC
Operational ranges for temperature and humidity	Same as the MEMORY HiCORDER in which the 8939 is installed
Operating place	Same as the MEMORY HiCORDER in which the 8939 is installed
Temperature and humidity ranges for storage	Temperature: -10 to 50 Relative humidity: 80%RH maximum (with no condensation)
Effect of radiated radio-frequency electromagnetic field	$\pm 5\% \text{ f.s.}$ at 3V/m
Dielectric strength	One minute at 400 VAC between the 8939 and the main unit, and between the 8939 and the input unit
Dimensions	Approx. 170W $\times$ 20H $\times$ 148.5D mm (6.69"W $\times$ 0.79"H $\times$ 5.85"D)
Mass	Approx. 250 g (8.8 oz.)
Standards applying	EMC EN61326 ClassA Safety EN61010 Pollution Degree 2, Overvoltage Category I (anticipated transient overvoltage: 330 V)
Accessories	Conversion cable $\times$ 2 (Compatible sensor connector: PRC03-12A10-7M10.5 by TAJIMI)



## 15.2.5 8940 F/V UNIT

Accuracy at  $23 \pm 5$  ( $73^{\circ}\text{F} \pm 9^{\circ}\text{F}$ ), 35% to 80%RH after zero adjustment after 30-minute warming-up time. Accuracy guaranteed for 1 year.

### General specifications

A/D resolution	12 bits
Vertical axis resolution	160 LSB/DIV
Measurement functions	Frequency, count, pulse duty ratio, voltage and current measurement
Maximum sampling period	1 $\mu\text{s}$ (voltage, current and count measurement) 1.125 $\mu\text{s}$ (frequency and pulse duty ratio measurement)
Low-pass filter	OFF, 5, 500, 5 k, 100 k $\pm 50\%$ (Hz) -3 dB
Input coupling	DC, GND, AC (fixed DC coupling except voltage and current measurement)
Pull-up resistance	ON/OFF (OFF in current measurement), 10 k
Maximum input voltage	30 Vrms or 60 VDC
Maximum rated voltage to earth	30 Vrms or 60 VDC (BNC)
BNC terminal (for voltage, frequency, count and pulse duty ratio measurement)	Input resistance: 1 M $\pm 1\%$ (with pull-up resistance disabled) Input capacitance: 60 pF $\pm 20$ pF (at 100 kHz) Input type: Unbalanced (Note: With the 3273 or 3273-50 <sup>*1</sup> , the sensor connector terminal is used together.) Maximum rated voltage to earth: 30 Vrms or 60 VDC
Sensor connector terminal (for power supply to measure current)	4 channels can be connected. GND: Common with the MEMORY HiCORDER in which the 8940 is installed (Note: With the 3273 or 3273-50 <sup>*1</sup> , the BNC terminal is used together.)
Operational ranges for temperature and humidity	Same as the MEMORY HiCORDER in which the 8940 is installed
Operating place	Same as the MEMORY HiCORDER in which the 8940 is installed
Temperature and humidity ranges for storage	Temperature: -10 to 50 ( $14^{\circ}\text{F}$ to $122^{\circ}\text{F}$ ) Relative humidity: 80%RH maximum (with no condensation)
Effect of radiated radio-frequency electromagnetic field	$\pm 5\%$ f.s. at 3V/m
Dielectric strength	One minute at 400 VAC between the 8940 and the main unit, and between the 8940 and the input unit
Dimensions	Approx. 170W $\times$ 20H $\times$ 148.5D mm (6.69"W $\times$ 0.79"H $\times$ 5.85"D) (excluding projections)
Mass	Approx. 300 g (10.6 oz.)
Standards applying	EMC EN61326 ClassA Safety EN61010 Pollution Degree 2, Measurement Category I (anticipated transient overvoltage: 330 V)
Options	9318 CONVERSION CABLE (for connection of a clamp-on sensor) 9319 CONVERSION CABLE (for connection of a clamp-on probe)
Compatible current sensors and probe	9270, 9271, and 9272 CLAMP-ON SENSORS 9277, 9278 and 9279 UNIVERSAL CLAMP ON CTs 3273, 3273-50 <sup>*1</sup> CLAMP-ON PROBE

\*1: When using the Model 3273-50 with the 8940, bear in mind that the maximum input of the 3273-50 is 15 Arms.

## Frequency, count and pulse duty ratio measurement

Frequency measurement ranges	0.1, 0.2, 1, 2, 10, 20, 100, 200 Hz/DIV, 1, 2, 10 kHz/DIV 10, 20, 100, 200, 1k r/min/DIV Power source frequency ranges: 50 Hz (40 to 60 Hz), 60 Hz (50 to 70 Hz)
Frequency measurement accuracy	± 0.7% f.s. (100 kHz f.s. range) ± 0.2% f.s. (other than above) ± 0.032 Hz (power source frequency ranges)
Frequency hold	ON, OFF (waiting time: 10 ms, 1 s variable) When hold is OFF, the current measurement value is halved if the next measurement value is not fixed within the waiting time.
Count measurement ranges	10, 20, 100, 200 counts/DIV, 1, 2, 10, 20, 100, 200 k counts/DIV, 1 M counts/DIV
Pulse duty ratio measurement ranges	100% f.s.
Pulse duty ratio accuracy	± 1% (10 Hz to 10 kHz)
Threshold value (common)	-10 to +10 V variable (0.2 V steps)
Frequency measurement ranges (common)	DC to 100 kHz (frequency) DC to 90 kHz (count) 10 Hz to 10 kHz (pulse duty ratio)
Response time (common)	10 μs max. (frequency of 300 Hz or greater, count) 50 μs max. (frequency of 300 Hz or less, pulse duty ratio) The sampling period of the MEMORY HiCORDER in which the 8940 is installed must be added to the above.

## Voltage and current measurement

Voltage measurement ranges	1, 2, 5, 10, 20, 50, 100, 200, 500 mV/DIV, 1, 2, 5 V/DIV
Current measurement ranges	With the 9270, 9272 (20 A), 9277, 3273 and 3273-50 10, 20, 50 100, 200, 500 mA, 1, 2, 5 10 A/DIV With the 9271, 9272 (200 A) and 9278 100, 200, 500 mA, 1, 2, 5 10, 20, 50, 100 A/DIV With the 9279 200* <sup>1</sup> , 500 mA, 1, 2* <sup>1</sup> , 5 10, 20* <sup>1</sup> , 50, 100, 200* <sup>1</sup> A/DIV
Frequency characteristic* <sup>2</sup>	DC to 400 kHz ± 3 dB (DC coupling) (When using a sensor, same as the sensor.)
DC amplitude accuracy* <sup>2</sup>	± 0.4% f.s. (Using the 9279 ..... ± 0.5 %f.s.)
Zero position accuracy* <sup>2</sup>	± 0.15% f.s. (Using the 9279 ..... ± 0.2 %f.s.)
Temperature characteristic* <sup>2</sup>	Gain: ± 0.025%f.s./ Zero position: ± 0.04%f.s./ (1, 2, 5 mV/DIV ranges) ± 0.03%f.s./ (other than above)
Common mode rejection ratio	80 dB minimum (at 50/60 Hz and with signal source resistance 100 maximum)
Noise	150 μVp-p max. (1 mV/DIV range)

\*<sup>1</sup> : Vertical resolution: 128 LSB/DIV

\*<sup>2</sup>: When measuring current, the accuracy and characteristics of the sensor or probe must be added to the above.

## 15.2.6 8946 4 ch ANALOG UNIT

Accuracy at  $23 \pm 5$  ( $73^{\circ}\text{F} \pm 9^{\circ}\text{F}$ ), 35% to 80%RH after zero adjustment after 30-minute warming-up time. Accuracy guaranteed for 1 year.

Number of input channels	4
Measurement ranges	20, 50, 100, 200, 500 mV/DIV 1, 2, 5 V/DIV
DC amplitude accuracy	$\pm 0.5\%$ f.s.
Zero position accuracy	$\pm 0.15\%$ f.s. (after zero adjustment)
Temperature characteristic	Gain: $\pm 0.05\%$ f.s./ Zero position: $\pm 0.02\%$ f.s./
Frequency characteristic	DC to 100 kHz $\pm 3$ dB
Noise	1 mVp-p typical, 2 mVp-p max. (sensitivity range, with input shorted)
Common mode rejection ratio	80 dB minimum (at 50/60 Hz and with signal source resistance 100 maximum)
Low-pass filter	OFF, 5, 500, 5 k, 50 k $\pm 50\%$ (Hz) -3 dB
Input type	Unbalanced (input isolated from output)
Input coupling	DC, GND
Input resistance	1 M $\pm 1\%$
Input capacitance	15 pF $\pm 10$ pF (at 100 kHz)
A/D resolution	12 bits
Maximum sampling speed	1 MS/s
Input terminals	BNC terminal
Maximum input voltage	30 Vrms or 60 VDC
Maximum rated voltage to earth	30 Vrms or 60 VDC (between each input channel and main unit, and between input channels)
Operational ranges for temperature and humidity	Same as the MEMORY HiCORDER in which the 8946 is installed
Operating place	Same as the MEMORY HiCORDER in which the 8946 is installed
Temperature and humidity ranges for storage	Temperature: $-10$ to $50$ ( $14^{\circ}\text{F}$ to $122^{\circ}\text{F}$ ) Relative humidity: 80%RH maximum (with no condensation)
Effect of radiated radio-frequency electromagnetic field	$\pm 2\%$ f.s. at 3V/m
Dielectric strength	One minute at 330 VAC between the 8946 and the main unit, and between the 8946 and the input unit
Dimensions	Approx. 170W $\times$ 20H $\times$ 148.5D mm (6.69"W $\times$ 0.79"H $\times$ 5.85"D)
Mass	Approx. 310 g (10.9 oz.)
Standards applying	EMC EN61326 ClassA Safety EN61010 Pollution Degree 2, Overvoltage Category I (anticipated transient overvoltage: 330 V)

## 15.2.7 8947 CHARGE UNIT

Accuracy at 23 ± 5 (73°F ± 9°F), 35% to 80%RH after zero adjustment after 60-minute warming-up time. Accuracy guaranteed for 1 year.

### Electrical charge input

Compatible converter	Electrical charge output piezoelectric acceleration pickup sensor
Measurement sensitivity	0.1 to 10 pC/(m/s <sup>2</sup> )
Measurement ranges	4, 10, 20, 40, 100, 200, 400, 1 k, 2 k, 4 k, 10 k, 20 km/s <sup>2</sup> /DIV ( 0.1 to 0.25 pC/(m/s <sup>2</sup> ) ) 2, 4, 10, 20, 40, 100, 200, 400, 1 k, 2 k, 4 k, 10 km/s <sup>2</sup> /DIV ( 0.251 to 10.5 pC/(m/s <sup>2</sup> ) ) 1, 2, 4, 10, 20, 40, 100, 200, 400, 1 k, 2 k, 4 km/s <sup>2</sup> /DIV ( 0.501 to 1.0 pC/(m/s <sup>2</sup> ) ) 400 m, 1, 2, 4, 10, 20, 40, 100, 200, 400, 1 k, 2 km/s <sup>2</sup> /DIV ( 1.01 to 2.5 pC/(m/s <sup>2</sup> ) ) 200 m, 400 m, 1, 2, 4, 10, 20, 40, 100, 200, 400, 1 km/s <sup>2</sup> /DIV ( 2.51 to 5.0 pC/(m/s <sup>2</sup> ) ) 100m, 200m, 400m, 1, 2, 4, 10, 20, 40, 100, 200, 400 m/s <sup>2</sup> /DIV ( 5.01 to 10.0 pC/(m/s <sup>2</sup> ) ) * ( ): Measurement sensitivity
Amplitude accuracy	± 2% f.s.
Temperature characteristic	± 0.2%f.s./
Frequency characteristic	1 to 50 kHz (+1/-3 dB)
Low-pass filter	500, 5 kHz ± 50% (-3 dB)
Maximum input electrical charge	500 pC (when range 6 high sensitivity is selected) 50000 pC (when range 6 low sensitivity is selected)
Input terminal	Miniature connector (#10-32UNF)

### Preamplifier input

Compatible converter	Preamplifier internal acceleration pickup sensor
Measurement sensitivity	0.1 to 10 mV/(m/s <sup>2</sup> )
Measurement ranges	4, 10, 20, 40, 100, 200, 400, 1 k, 2 k, 4 k, 10 k, 20 km/s <sup>2</sup> /DIV ( 0.1 to 0.25 mV/(m/s <sup>2</sup> ) ) 2, 4, 10, 20, 40, 100, 200, 400, 1k, 2k, 4 k, 10 km/s <sup>2</sup> /DIV ( 0.251 to 0.5 mV/(m/s <sup>2</sup> ) ) 1, 2, 4, 10, 20, 40, 100, 200, 400, 1 k, 2 k, 4 km/s <sup>2</sup> /DIV ( 0.501 to 1.0 mV/(m/s <sup>2</sup> ) ) 400 m, 1, 2, 4, 10, 20, 40, 100, 200, 400, 1 k, 2 km/s <sup>2</sup> /DIV ( 1.01 to 2.5 mV/(m/s <sup>2</sup> ) ) 200 m, 400 m, 1, 2, 4, 10, 20, 40, 100, 200, 400, 1 km/s <sup>2</sup> /DIV ( 2.51 to 5.0 mV/(m/s <sup>2</sup> ) ) 100 m, 200 m, 400 m, 1, 2, 4, 10, 20, 40, 100, 200, 400 m/s <sup>2</sup> /DIV ( 5.01 to 10 mV/(m/s <sup>2</sup> ) ) * ( ): Measurement sensitivity
Amplitude accuracy	± 2% f.s.
Temperature characteristic	± 0.2%f.s./
Frequency characteristic	1 to 50 kHz (+1/-3 dB) (low cut-off frequency: 1 Hz ± 50%)
Low-pass filter	500, 5 kHz ± 50% (-3 dB)
Operating power	2 mA ± 20%, +15 V ± 5%
Input terminal	BNC terminal

## Voltage input

Measurement ranges	1, 2, 5, 10, 20, 50, 100, 200, 500 mV, 1, 2, 5 V/DIV
DC amplitude accuracy	± 0.4% f.s.
Zero position accuracy	± 0.15% f.s.
Temperature characteristic	Gain: ± 0.02%f.s./ Zero position: ± 0.03%f.s./ (after zero adjustment)
Frequency characteristic	DC to 400 kHz (+1/-3 dB) (DC coupling) 1 to 400 kHz (+1/-3 dB) (AC coupling, low cut-off frequency: 1 Hz ± 50%) (in 1 to 5 mV/DIV range)
Noise	75 µVp-p typical, 120 µVp-p max. (in 1 mV/DIV range)
Low-pass filter	5, 500, 5 k, 100 k ± 50% (Hz) (-3 dB)
Input resistance	1 M ± 1%
Input capacitance	200 pF max. (at 100 kHz)
Input coupling	DC, GND, AC
Maximum input voltage	30 V rms or 60 V DC
Maximum rated voltage to earth	30 V rms or 60 V DC
Input terminal	BNC terminal

## Common specifications

Number of input channels	2 (switching mode: select from electrical charge input, preamplifier input, voltage input or by channel.)
Input type	Unbalanced (input interval floating, floating between input and main unit GND, common input between voltage input GND and charge input GND)
Zero position setting range	-50 to 150% f.s. (in full-size representation of the vertical axis)
Common mode rejection ratio	80 dB minimum (at 50/60 Hz and with signal source resistance 100 maximum)
Anti-aliasing filter	Cutoff frequency (fc) of 20, 40, 80, 200, 400, 800, 2 k, 4 k, 8 k, 20 k, 40 kHz (ON/OFF possible, automatic setting synchronized with time axis and frequency axis range) Attenuation is -66 dB min. at 1.5 fc.
Maximum sampling speed	1 MS/s
A/D resolution	12 bits
Operating place	Same as the MEMORY HiCORDER in which the 8947 is installed
Operational ranges for temperature and humidity	(Same as the MEMORY HiCORDER in which the 8947 is installed)
Temperature and humidity ranges for storage	Temperature: -10 to 50 (14°F to 122°F) Relative humidity: 80%RH maximum (with no condensation)
Dielectric strength	One minute at 400 VAC between the 8947 and the main unit, and between the 8947 and the input unit
Dimensions	Approx. 170W × 20H × 148.5D mm (6.69"W × 0.79"H × 5.85"D) (excluding projections)
Mass	Approx. 310 g (10.9 oz.)
Effect of radiated radio-frequency electromagnetic field	± 10% f.s. at 3V/m (in the 10 mV/DIV range)
Standards applying	EMC EN61326 ClassA Safety EN61010 Pollution Degree 2, Measurement Category I (anticipated transient overvoltage: 330 V)

## 15.3 Replacement Procedure

- This section describes how to replace the INPUT UNIT.

**⚠ DANGER**

To avoid the danger of electric shock, never operate the unit with an input unit removed. If you should wish to use the unit after removing an input unit, fit a blank panel over the opening of the removed unit.

**⚠ WARNING**

To prevent electrical shock, before adding or replacing the input unit, check that the power for the unit is off and the power cord and input cables are disconnected. The fixing screws must be firmly tightened or the input unit may not function up to specification, or may even fail.

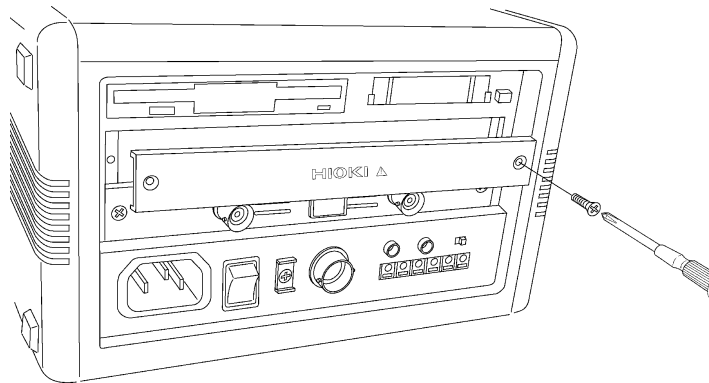

Fitting a blank panel

**NOTE**

Do not measure with a blank panel removed. Otherwise, the unit internal temperature becomes unstable and consequently the specifications are not met.

---

### 15.3.1 Replacement Procedure 1

- This section describes how to replace the 8936 ANALOG UNIT, 8938 FFT ANALOG UNIT, 8939 STRAIN UNIT, 8940 F/V UNIT or 8947 CHARGE UNIT.
- The following procedure describes how to remove the input unit.
- Install the units by reversing the procedure for removal.

1. Remove the input cables from all input units.
2. Power off the 8835-01 main unit, and disconnect the power cord.
3. Remove the two fixing screws with a Phillips screwdriver, as shown in the figure below.
4. Grasp the handle and pull the unit out, as shown in the illustration.

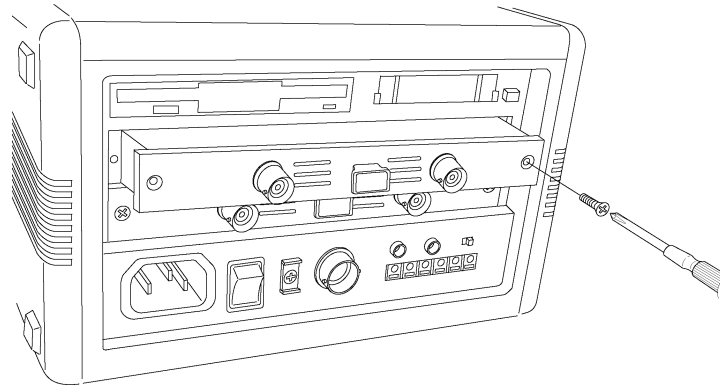

---

### 15.3.2 Replacement Procedure 2

- This section describes how to replace the 8937 VOLTAGE/TEMP UNIT or 8946 4 ch ANALOG UNIT.
- The following procedure describes how to remove the input unit.
- Install the units by reversing the procedure for removal.

1. Remove the input cables from all input units.
2. Power off the 8835-01 main unit, and disconnect the power cord.
3. Remove the two fixing screws with a Phillips screwdriver, as shown in the figure below.
4. Grasp both the BNC connectors and pull the unit out, as shown in the illustration.

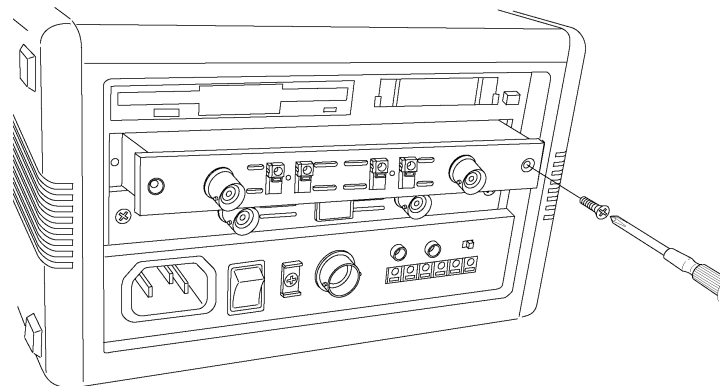

---

## 15.4 Input Cables

---

### 15.4.1 Connection Cable

**⚠ CAUTION**

- When disconnecting the BNC connector, be sure to release the lock before pulling off the connector. Forcibly pulling the connector without releasing the lock, or pulling on the cable, can damage the connector.
- Use designated connection cables only. Other cables may interfere with proper connection and measurement accuracy.

Use the optional 9197 and 9198 CONNECTION CORDs for the analog input.

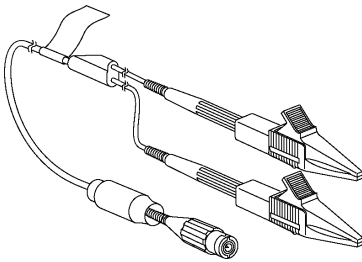

9197 CONNECTION CORD  
( Maximum input voltage: 500 V )

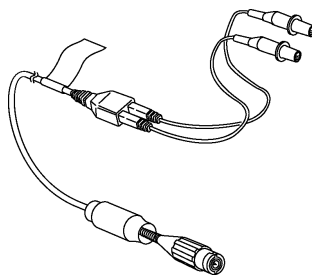

9198 CONNECTION CORD  
( Maximum input voltage: 300 V )

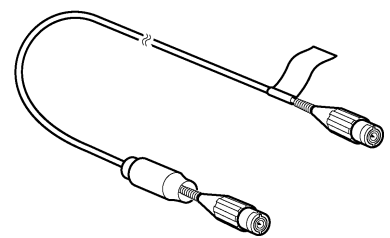

9217 CONNECTION CORD  
( Maximum input voltage: 300 V )



## 15.4.2 9322 DIFFERENTIAL PROBE Connection

### **⚠ DANGER**

- When using grabber clips, the 9322's maximum rated voltage to earth is 1500 V AC/DC; when using alligator clips, it is 1000 V AC/DC. To avoid electrical shock and possible damage to the unit, never apply voltages greater than these limits between the input channel terminals and chassis, or across the inputs of two 9322s.
- Maximum input voltage is 1000 VAC/2000 VDC. Do not measure voltage in excess of these limitations, as doing so may damage the unit or cause an accident that might result in injury or death.

9322 is a differential probe that connects to input of 8835-01 MEMORY HiCORDER input unit. For more details, refer to its instruction manual.

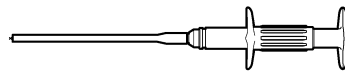
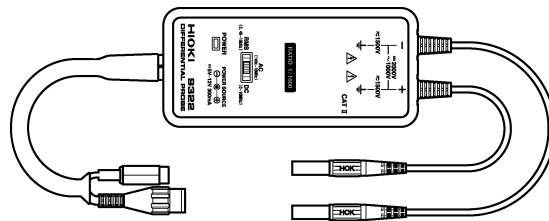

Grabber clips

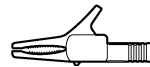

Alligator clips



### 15.4.3 9018-10/9132-10 CLAMP-ON PROBE

#### **⚠ DANGER**

- Always connect the clamp-on probe to the secondary side of a breaker. On the secondary side of a breaker, even if the lines are shorted the breaker can trip and prevent an accident. On the primary side, however, the current capacity may be large, and in the event of a short-circuit there may be a serious accident.
- Before using the 9018-10/9132-10 CLAMP-ON PROBE, be sure to carefully read its instruction manual and familiarize yourself with the operation principles of this product.

The HIOKI 9018-10/9132-10 CLAMP-ON PROBE can be used to perform current measurement. This probe has a voltage output. The 8835-01 is designed for voltage input. It cannot be used to perform current measurements by itself.

#### **Connections**

Connect the BNC connector of the 9018-10/9132-10 CLAMP-ON PROBE to the analog input of the 8835-01. Refer to "2.4 Probe Connection."

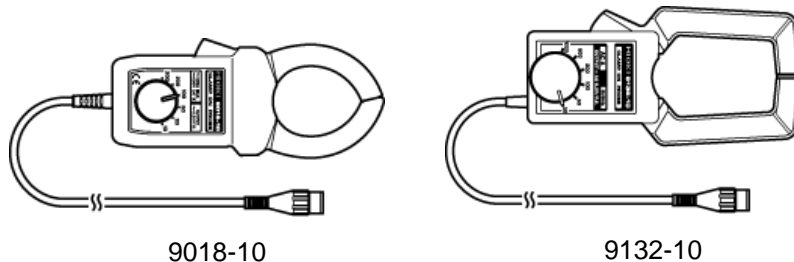

#### **NOTE**

- The 8835-01 will indicate measurement results as voltage.
- Using the scaling function, units can be converted to "A" for display. See Section 9.4.
- When the clamp-on probe is used for measurement, the measurement precision will be affected both by the 8835-01 precision and clamp-on probe precision ratings. The same is true for cases where other clamps are used.
- When using the 9018/9132 CLAMP-ON PROBE, always use the 9199 CONVERSION ADAPTER.

## 15.5 Measurement Errors Caused by Signal Source Internal Resistance

- If the signal source impedance is higher than the input impedance of the unit, a measurement error will occur.
- The input impedance of the 8936 ANALOG UNIT is 1 M $\Omega$ . If the signal source impedance is 1 k $\Omega$ , an error of about 0.1% will occur.

$$\text{Measurement errors} = E_s \left[ 1 - \frac{R_{in}}{R_s + R_{in}} \right] [V]$$

$E_s$ : Signal voltage

$R_s$ : Signal source resistance

$R_{in}$ : Input resistance

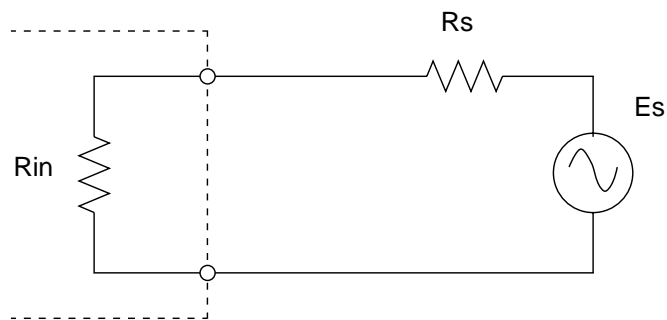



---

# Chapter 16

## Maintenance

---

## 16.1 Printer Head Cleaning

In normal use, the printer does not require periodic maintenance. However, depending on usage conditions, the thermal head may become contaminated by dust or paper scraps. If the print seems light or if there are dropped sections, clean the head as described below.

- Method 1**
1. Press the **SYSTEM** key to call up the SELF CHECK screen.
  2. Move the flashing cursor to the Printer check item.
  3. Press the **F5** [CLEANING] key for about 5 seconds. During this interval, the printer prints 100% black section.
  4. If this method does not alleviate the problem, perform the steps of cleaning method 2 as described below.
- \* See Section 9.8.2.

- Method 2**
1. Moisten printer paper on the rear with dehydrated alcohol and set the paper in the printer. (If the front side of the paper is moistened, discoloring will occur.)
  2. Lower the head-up lever and move the printer paper back and forth to clean the head.

Moisten this side with cleaning alcohol

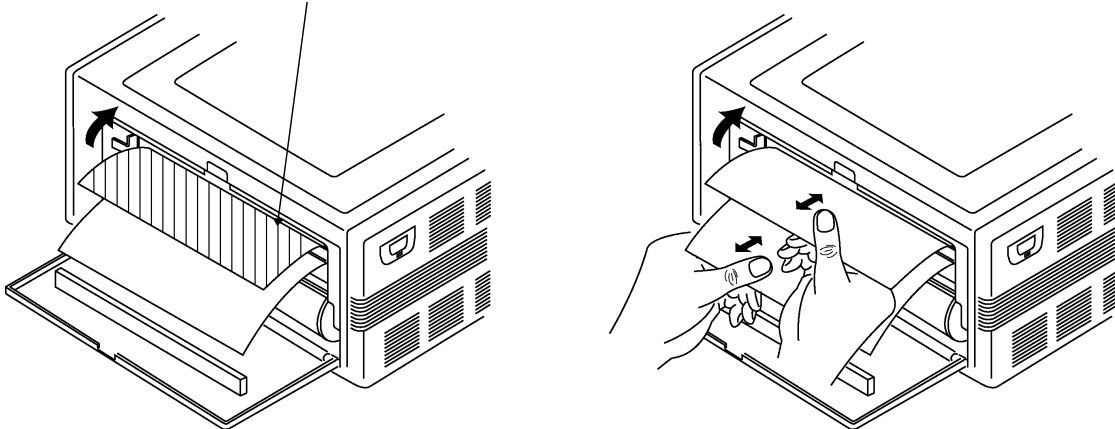

**NOTE**

- Do not use organic solvents such as thinners.
- Be sure that the printer is completely dry.
- After extended use, paper residue (visible as a white powder-like substance) may accumulate on the roller. While a small amount of residue has no adverse effect, the roller can be cleaned using an air-blow brush (such as sold as a camera accessory).
- Always use the paper cutter integrated in the printer cover to cut printer paper. If the paper is cut near the thermal head, a large amount of paper residue may accumulate on the roller.

## 16.2 Removing the Battery Before Discarding the 8835-01

- The 8835-01 incorporates a lithium battery for memory backup.
- Before final disposal of the 8835-01, remove the battery as described below.

### WARNING

- To avoid the risk of electric shock, be sure that all cables and the power cord are disconnected before removing the battery.
- Dispose of the battery as prescribed in your community.

### Removing the battery

1. Verify that the power is switched OFF.
2. Disconnect all input cables and the power cord.
3. Remove the 8 screws which fasten the rear panel, using a Phillips screwdriver.

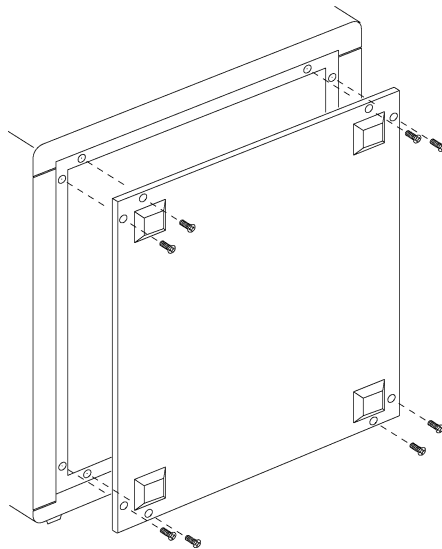

4. Remove the rear panel. The battery is located in the position on the PCB shown in the figure.

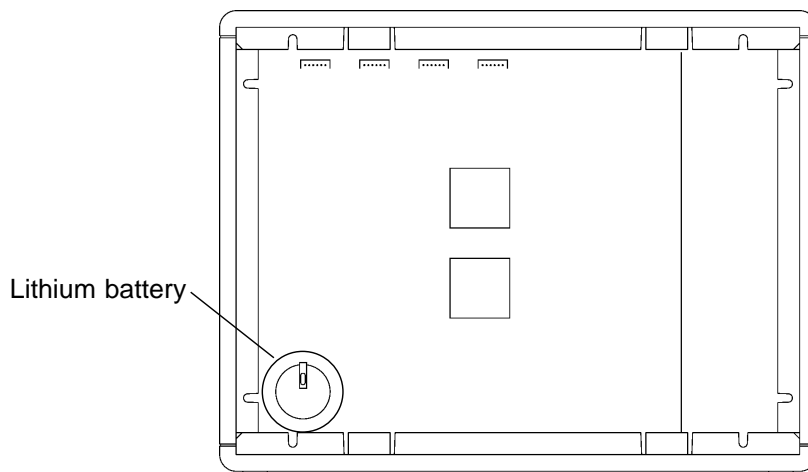

5. Pull the battery up and cut the positive terminal with a wire cutter.
6. Pull the battery further up.
7. Cut the negative terminal (under the battery) with a wire cutter.

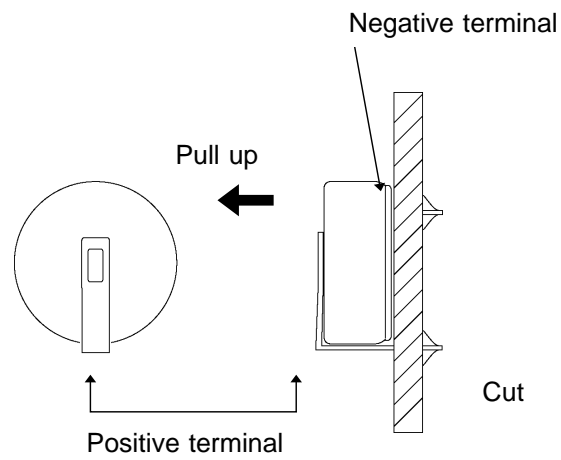



## 16.3 Troubleshooting

If the unit does not seem to operate normally, check the following points before requesting service.

Problem	Check	Ref. page
LED does not light when the unit is turned on.	Is power cord connected properly?	15, 16
Even when the <b>START</b> key is pressed, no data is printed.	Is the "Pretrigger stanby" message displayed? (When pretriggering is activated, triggering does not occur until the current waveform is fully captured.)	173
	Has the "Waiting for trigger" message appeared? Check the trigger settings.	170
There is absolutely no variation in the recorded waveform.	Is the measurement range setting appropriate?	121
	Has a low pass filter been set?	129
	Has the vernier function been set?	267
	Has baseline offset been set?	127
The printed recording is non-existent.	Is the recording paper back to front?	28
Even when the <b>PRINT</b> or the <b>COPY</b> key is pressed, no data is printed.	Make sure the destination of the printout created by pressing the <b>PRINT</b> key or the <b>COPY</b> key is set to "Internal Printer."	230, 231
The printed recording is very faint	Are you using the correct recording paper? (9221)	ii
During memory recorder operation, the apparent frequency of the recording is much lower than the expected frequency.	This is likely to be an aliasing error. Make the time axis range setting faster. For more details see "Time Axis Range Setting" and "Aliasing Distortion."	APPENDIX5, APPENDIX7
Recording lines are dense or blurred.	Input signal contains ripple components. Make suitable filter settings at input unit.	129
Recording lines are duplicated.	When "Dotted line" is selected as the printed line type in the waveform display color settings, the top and bottom of the line become separated by a 1-dot gap. With waveforms that have little variation, this can cause waveform printing to appear variously as one line or as two lines. To correct this, select "Solid line" as the printed line type.	118
The keys are dead and do not respond.	Has the unit been put into the key lock condition (message "KEY LOCK" appeared)? Press the <b>KEY LOCK</b> key to clear the key lock condition.	276
	Is the unit being remotely controlled ("GP-IB REMOTE" is displayed, if the GP-IB interface is being used)?	*
Some channles cannot be used.	Is the number of channels to be used restricted?	204
The size of a waveform does not change, even if the input range is changed.	Has the variable function been enabled? Disable the variable function.	163

\*: See the 9558 Instruction Manual.

If none of the above conditions apply, and the cause of the problem is not understood, try performing a SYSTEM RESET. All the settings will revert to the factory settings. Try the following operation, 1 or 2.

## System reset

### Method 1

1. Press the **SYSTEM** key to call up the **Initialize** screen.
2. Move the flashing cursor to the **Sytem reset** item and select **Exec**.  
For details, see Section 9.7.3.

### Method 2

Turn the unit on while holding down the **STOP** key.

---

## 16.4 Cleaning the Unit

- Gently wipe dirt from the surface of the unit with a soft cloth moistened with a small amount of water or mild detergent.  
Do not try to clean the unit using cleaners containing organic solvents such as benzine, alcohol, acetone, ether, ketones, thinners, or gasoline. They may cause discoloration or damage.
  - Wipe the LCD gently with a dry, soft cloth.
- 

## 16.5 Service

- If damage is suspected, check the "Troubleshooting" section before contacting your dealer or HIOKI representative.
- Pack the product carefully so that it will not be damaged during shipment, and include a detailed written description of the problem. HIOKI cannot be responsible for damage that occurs during shipment.
- Periodic calibration is necessary to verify and maintain accuracy. If calibration becomes necessary, return the unit to us for maintenance.

---

# Appendix

---

---

## Appendix 1 Error and Warning Messages

The unit produces two levels of message to indicate problems. These are distinguished as follows.

### Error messages

- (1) The "ERROR" indication appears at the bottom of the screen, followed by the message. This remains until the cause of the error is removed, or the  key is pressed.
- (2) If the "beep sound" item on the system screen is set to ON, then the beeper sounds intermittently while the message is displayed.

### Warning messages

- (1) The "WARNING" indication is displayed on the bottom line of the screen, followed by the message, but disappears after a few seconds.
- (2) Warning messages also disappear if any key is pressed.
- (3) If the "beep sound" item on the system screen is set to ON, then the beeper sounds once only when the message is displayed.

## Appendix 1.1 Error Messages

ERROR 1: Set printer paper.	Printer paper has run out. Reload.
ERROR 2: Set printer lever.	The head up/down lever has been left in the up position. Lower it.
ERROR 11: Wait printer initialize.	Make sure that the external printer is ready to print.
ERROR 12: Set printer power on	Make sure that the external printer is connected or the unit is powered on.
ERROR 13: Paper End	Printer paper has run out. Reload.
ERROR 14: Printer Error.	This indicates an internal printer error.

## Appendix 1.2 Warning Messages

WARNING 70: Insert Floppy disk.	No disk is present in the floppy disk drive. Insert one.
WARNING 71: Cannot load. (not 8835 data)	Data cannot be loaded, because it is not a set of data created by the 8835-01.
WARNING 72: Illegal format.	The floppy disk is not a correctly formatted MS-DOS disk, or is a 2DD, 640 KB format disk.
WARNING 73: Write Protected.	The floppy disk is write-protected. Change the write-protect setting or use a different disk.
WARNING 74: Disk full.	There is insufficient space remaining.
WARNING 75: File is read only.	File cannot be written or deleted, because it is read-only.
WARNING 76: General failure.	Access to disk is not possible because of some low-level error, such as in formatting or file saving.
WARNING 80: Insert PC card.	No card is present in the PC card slot. Insert one.
WARNING 81: Cannot load. (not 8835 data)	Data cannot be loaded, because it is not a set of data created by the 8835-01.
WARNING 82: Illegal format.	The PC card is not a correctly formatted MS-DOS disk.
WARNING 83: Write Protected.	The PC card is write-protected. Change the write-protect setting or use a different card.
WARNING 85: File is read only.	File cannot be written or deleted, because it is read-only.
WARNING 86: General failure.	Access to card is not possible because of some low-level error, such as in formatting or file saving.
WARNING 90: File already exists.	File cannot be saved because a file of the same name already exists. Change the file name.
WARNING 91: Directory full	Only a limited number of files and directories can be created in the root directory.
WARNING 92: Directory not empty	The directory is not empty. Delete files in it.
WARNING 93: Disk full	Delete files or use a different media.

WARNING 94: Path name error.	Make sure that the path name does not exceed 127 characters.
WARNING 95: Empty directory name.	Specify a directory name.
WARNING 96: Directory already exists.	A directory of the same name already exists. Change the directory name.
WARNING 97: 2DD type FD.	The floppy disk is a 2DD media. Select the appropriate disk format.
WARNING 98: 2HD type FD.	The floppy disk is a 2HD media. Select the appropriate disk format.
WARNING 99: Conditions for OVERWRITE are not satisfied.	Set the instrument's measurement data, file function, and time axis range settings.
WARNING 201: Set printer paper.	Printer paper has run out. Reload.
WARNING 202: Set printer lever.	The head up/down lever has been left in the up position.
WARNING 207: AUTO RANGE failure	The auto ranging function has failed. Check the input signal.
WARNING 208: Cannot SAVE. (Write Protected)	Move the write-protect tab to the unset position.
WARNING 209: Cannot SAVE. (Disk Full)	Delete files or use a different media.
WARNING 213: Invalid. (MEASUREMENT)	Pressed key is invalid, because parameter processing is ON.
WARNING 214: Invalid. (Pre Trigger)	The pre-trigger cannot be set, because the additional recording function is set.
WARNING 300: Cannot START.	Cannot start measurement from SYSTEM screen.
WARNING 301: Invalid (SYSTEM)	The key pressed is not valid on the system screen.
WARNING 310: Change auto print	When operating DC power supply, auto printing and roll mode are set to ON, current cannot be tested in more than 3 ch. Current testing in more than 3 ch turned auto printing OFF.
WARNING 311: Change print	When operating DC power supply, printer is set to ON, voltage cannot be tested in more than 3 ch. Voltage testing in more than 3 ch turned printer OFF.
WARNING 312: Cannot set. (Auto Print)	When operating DC power supply, auto printing cannot be set, because current testing is set in more than 3 ch.
WARNING 313: Cannot set. (Print)	When operating DC power supply, printer cannot be set, because current testing is set in more than 3 ch.
WARNING 324: Ignore in running. (AVERAGE)	Because averaging is used, waveform processing is not carried out during the start operation.
WARNING 325: Ignore in running. (WAVE CALC.)	Because a waveform processing calculation is carried out, vernier adjustment cannot be carried out.
WARNING 327: Invalid. (COMPARISON)	Pressed key is invalid, when waveform evaluation is being carried out.
WARNING 328: Invalid. (OVER LAY)	Operation is not possible, since the overlay function is enabled.
WARNING 329: Wrong format for Comparison	Since the format is not SINGLE or XYsing, a waveform decision is not possible.

WARNING 330: Cannot set. (SHOT too long)	The recording length is too long for the memory segmentation function or a waveform processing calculation to be carried out.
WARNING 334: Cannot set. (AVERAGE)	The memory segmentation function cannot be set together with the averaging function.
WARNING 335: Cannot set. (SEQUENTIAL)	Waveform processing cannot be carried out, because memory segmentation function is active.
WARNING 336: Cannot set. (MULTI BLOCK)	Waveform processing cannot be carried out, because memory segmentation function is active.
WARNING 337: Cannot set. (ROLL MODE)	Superimpose and waveform decision cannot be carried out, because roll mode is active.
WARNING 338: Cannot set. (OVER LAY)	Waveform processing cannot be carried out, because overlay function is active.
WARNING 339: Invalid. (STATUS)	On the status screen, the key pressed is invalid.
WARNING 345: Cannot set. (AND logic trigger)	'AND' cannot be set between the trigger sources using the logic trigger and the RMS level trigger
WARNING 346: Cannot set. (AND rms level )	'AND' cannot be set between the trigger sources using the RMS level trigger and the logic trigger.
WARNING 347: Invalid. (Pre Trigger)	When the trigger is not set, the pre-trigger is invalid.
WARNING 348: Invalid. (V-drop Trigger)	In the time axis range of 100 ms to 5 min, the voltage drop trigger is invalid.
WARNING 351: Cannot set. (Free run)	The pre-trigger setting cannot be made, since all trigger sources are switched off (free run).
WARNING 352: Invalid. (CHAN)	On the CHANNEL screen, the key pressed is invalid.
WARNING 353: Cannot set. (time/div:100ms-5min)	The time axis range within which the voltage drop trigger can be used is 100 $\mu$ s to 50 ms/DIV.
WARNING 380: No data in Ref. Block	When using the memory segmentation function (multi-block), there is no data in the reference block.
WARNING 381: Ref. block = Using block	When using the memory segmentation function (multi-block), the reference block and the block specified by the "using block" item are the same.
WARNING 382: No waveform data.	Because there is no waveform data present, it cannot be displayed. Start measurement operation to capture data.
WARNING 384: Different Ref. shot.	The recording lengths are different for the reference block and the block specified by the "using block" item. Capture data with the recording lengths set the same.
WARNING 386: Invalid. (RECORDER)	In the recorder function, the key pressed is invalid.
WARNING 387: Invalid. (X-Ycont)	In the X-Y recorder function, the key pressed is invalid.
WARNING 388: No comparison AREA	No waveform evaluation area. Create waveform evaluation area.
WARNING 389: Cannot use Printer.	The printer cannot be used when the time axis range is 10 ms to 200 ms/DIV, and the recording length is "continuous."
WARNING 390: Cannot set over up level.	Setting cannot be higher than upper limit.
WARNING 391: Cannot set under low level.	Setting cannot be lower than lower limit.

WARNING 392: Cannot set. (Using unit 2ch)	Recording length cannot be set to higher value because 2 channels are being used. Reduce number of channels.
WARNING 396: Out of range. (variable)	The settable range for the variable function (captured voltage range full-scale value $\times \pm 500$ ) was exceeded. When this warning appears, the upper and lower value setting is automatically changed to be within range.
WARNING 397: Out of range. (scaling)	POINT was set for scaling and the settable range (shown on Section 9.4.2) was exceeded.
WARNING 398: A/B cursor positions invalid.	Move A/B cursors to appropriate position.
WARNING 421: Equation contains a syntax error.	Correct equation.
WARNING 422: Cannot copy the equation. (Zxx)	Copy function cannot be carried out, because the copy source equation contains a Z number higher than the copy target equation.
WARNING 423: Upper value has to be bigger than lower value.	Upper limit must be higher than lower limit.
WARNING 610: No interface card.	Insert the interface card (PC card).
WARNING 799: Invalid. (shot:CONT.)	Operation is not possible, because the recording length is set to continuous.

## Appendix 2 Glossary

A/D	Conversion of an analog quantity into a digital quantity
Aliasing	Phantom signal components; a phenomenon that occurs if sampling frequency is low in relation to the frequency of the sampled signal (see Section Appendix 3.2).
Variance at aliasing	In FFT processing when input signal has more than 1/2 frequency component in sampling frequency, non-existing frequency spectrum is observed caused by aliasing.
Analog	Continuous physical quantity such as voltage or current
Attenuator	Device for reducing the level of a signal
Bit	Smallest unit of binary information
Byte	Unit of information. 1 byte is made up of 8 bits.
Channel (CH)	Input signal route
Chassis	Metal frame of the unit
Comment	A string input by the user. Also measurement conditions and other information printed for all functions.
Common mode	Voltage between ground and measurement input line
Cutoff frequency	Point where the filter output amplitude is $1/\sqrt{2}$ of the input.
Digital	Discrete physical quantity
DIV (division)	Increment on display or printout

Dynamic range	Ratio of maximum vs. minimum amplitude that can be displayed
File	A collection of data on a medium such as tape
LED	Abbreviation of "light-emitting diode"
Logic-level	Waveform expressed as High and Low level
Low-pass filter	Filter that passes through only signals below a certain frequency
Memory	A device for storing digital data
MS-DOS	Personal computer operating system. MS-DOS is a registered trademark of Microsoft Corporation.
Offset	Amount of shift in relation to 0 V when scaling is used
Open collector	Transistor output format. Requires an output increase.
Pre-trigger	The condition of the signal before triggering occurred
Probe	Signal line for supplying the signal to the input
PT	Abbreviation of (voltage) "potential transformer"
Recording length	Total amount of sampling data expressed as number of increments
Ripple component	AC component of noise
Sampling	Measuring an analog waveform at regular intervals (☞ Appendix 2.1)
Sampling rate	Rate at which sampling carried out; sampling frequency
Scaling	Conversion of voltage value into a specified unit
Storage	Storing measurement data in the internal memory
Thermal head	Print head of thermal printer
Threshold value	When turning an analog signal into a logic signal, the level at which the measured value is divided between High and Low.
Trigger	An event that causes a certain action (such as starting or stopping a measurement) to happen.
Unbalanced input	Using a two-pole input in such a way that one pole carries the signal referenced to the other pole
Word	A unit for expressing digital data. The digital data for one input signal point after conversion.



## Appendix 3 Reference

### Appendix 3.1 Sampling

- The 8835-01 converts the input signal to a digital value, then carries out all internal processing digitally. This process of converting an analog signal to digital values is termed sampling.
- Sampling measures the magnitude of the signal at fixed time intervals (sampling periods).

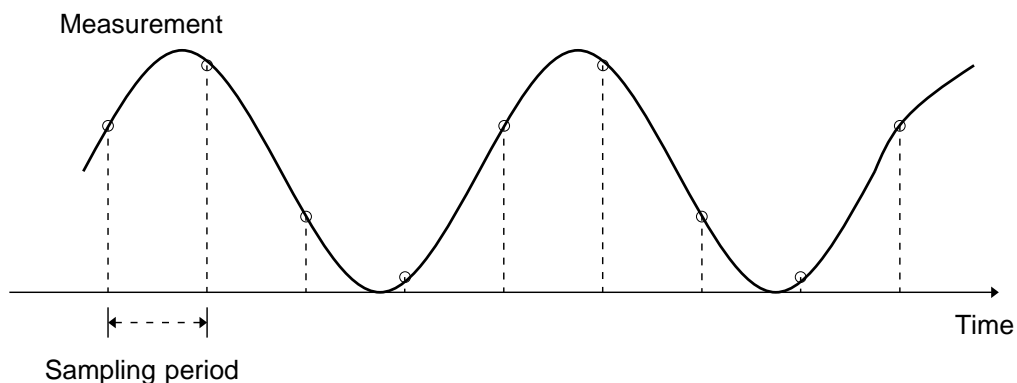

- The rate of taking these measurements is termed the sampling rate.
- The units are S/s, read as samples per second.
- This is the reciprocal of the sampling period ( $1/T$ ).

### Appendix 3.2 Aliasing

- If the frequency of the signal being measured is significantly higher than the sampling rate, it is possible for sampling to produce an apparent signal which is actually nonexistent. This phenomenon is termed aliasing.

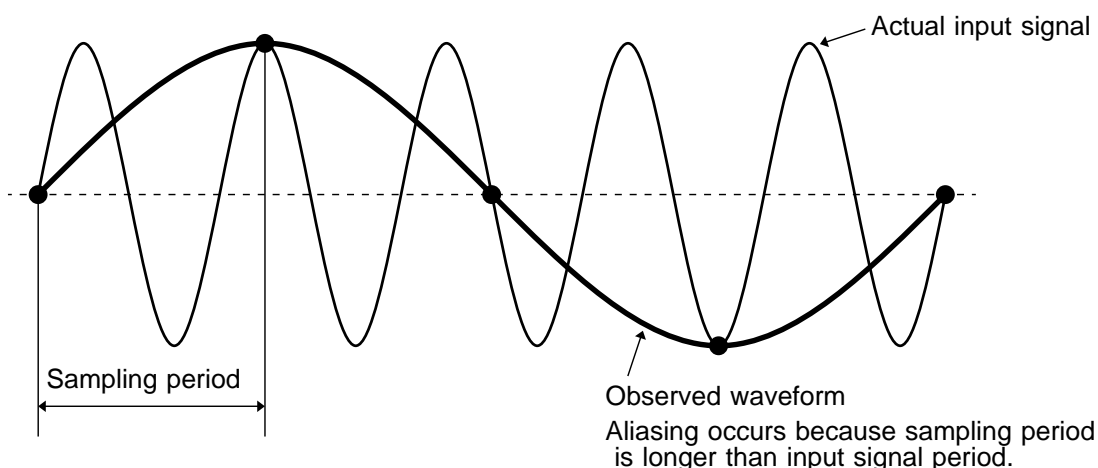

- When using the memory recorder function, because the sampling period for the time axis range may vary widely, care should be taken in setting the range not to produce aliasing.
- The measurement frequency limit is determined by the setting of the time axis range. In any event, it is always best to use the highest practicable sampling rate.
- When measuring a repeating signal, using the auto ranging function is another useful technique.

## Appendix 3.3 Measurement Limit Frequency

- As a general rule, to ensure that sampling catches the peaks of a typical sine wave input on the display, more than 25 samples are required for each input cycle.
- The measurement limit frequency changes depending on the time axis range.

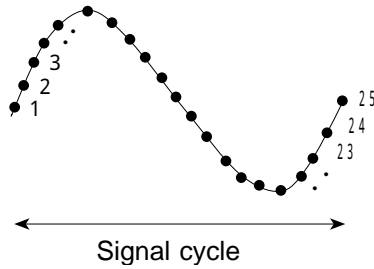

Time axis range (/DIV)	Sampling period	Measurement limit frequency
100 $\mu$ s	1 $\mu$ s	40 kHz
200 $\mu$ s	2 $\mu$ s	20 kHz
500 $\mu$ s	5 $\mu$ s	8 kHz
1 ms	10 $\mu$ s	4 kHz
2 ms	20 $\mu$ s	2 kHz
5 ms	50 $\mu$ s	800 Hz
10 ms	100 $\mu$ s	400 Hz
20 ms	200 $\mu$ s	200 Hz
50 ms	500 $\mu$ s	80 Hz
100 ms	1ms	40 Hz
200 ms	2ms	20 Hz
500 ms	5ms	8 Hz
1s	10ms	4 Hz
2s	20ms	2 Hz
5s	50ms	0.8 Hz
10s	100ms	0.4 Hz
30s	300ms	0.1333 Hz
1 min (60 s)	600ms	0.0666 Hz
2 min (120 s)	1.2s	0.0333 Hz
5 min (300 s)	3s	0.0133 Hz

## Appendix 3.4 Recorder Function

- The waveform data is collected under the following condition: one division is equal to 100 samples.
- One piece of sample data collected using the recorder function contains the maximum and minimum voltage obtained in the set sampling period. Therefore, this data is of a certain width.

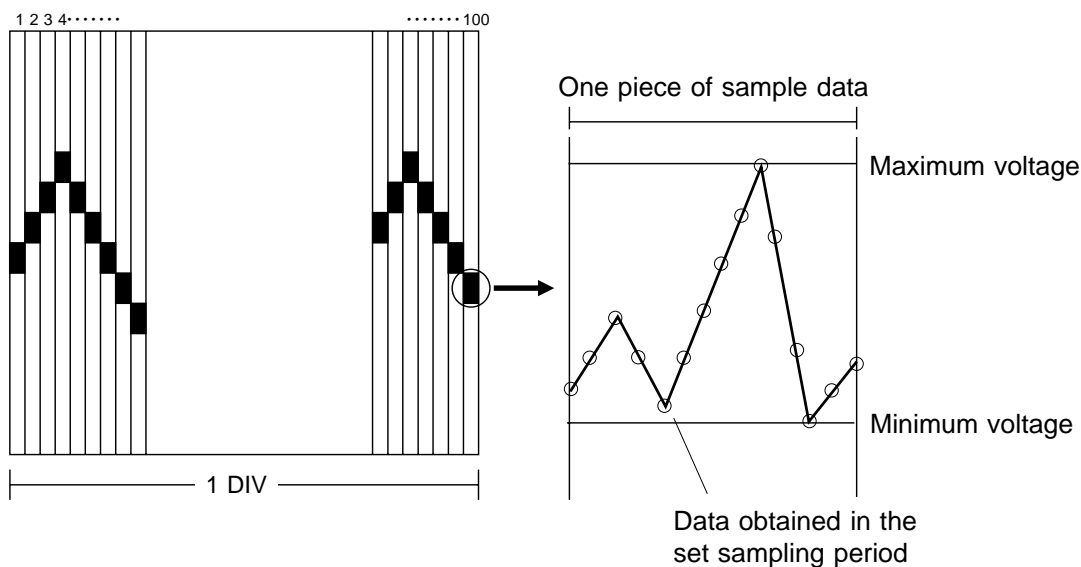

When a short sampling period is set and the input waveform changes slightly, a sudden disturbance such as noise will increase the difference between the maximum and minimum values. To eliminate this phenomenon, set a long sampling period.

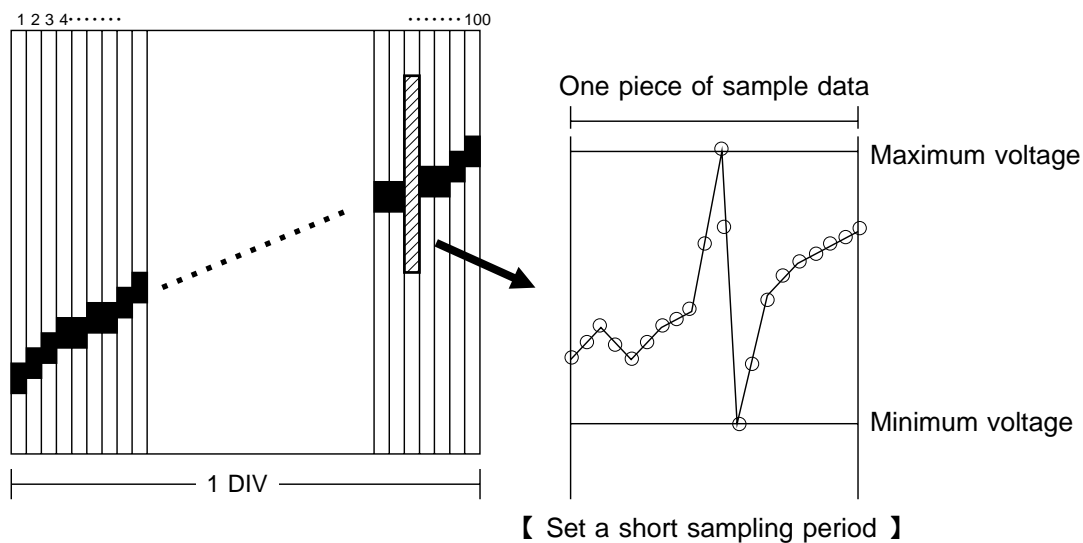

## Appendix 3.5 RMS Recorder Function

- For the RMS recorder function, the sampling period is fixed to 20 RMS value data items per second.
- One division is equal to 100 samples.

### Calculate one RMS value

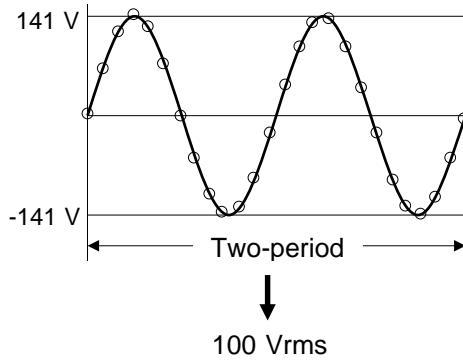

Sample the 50 Hz or 60 Hz waveforms at 200 μs and calculate one RMS value item using two-period data.

[ Two-period ]  
 50 Hz : 40 ms    200 sampling data  
 60 Hz : 33.4 ms    167 sampling data

(1) Time axis: 5 s/division

Since the sampling period is fixed to 20 RMS-value data items per second, 5 s/division provides 100 RMS-value data items per division. This value is in agreement with 100 samples per division and, therefore, the voltage axis does not have a width (upper and lower limits).

(2) Time axis: other than 5 s/division

The maximum and minimum values are specified based on the RMS-value data (by multiplying 20 RMS-value data items per second by the time-axis range [s/division]/100), and the data containing these maximum and minimum values are defined as one item of sample data. When the time-axis range is set to 1 mm/division, the maximum and minimum values are specified in the RMS-value data (20 x 60 [s/division]/100 = 12), and the data containing these maximum and minimum values are defined as one item of sample data.

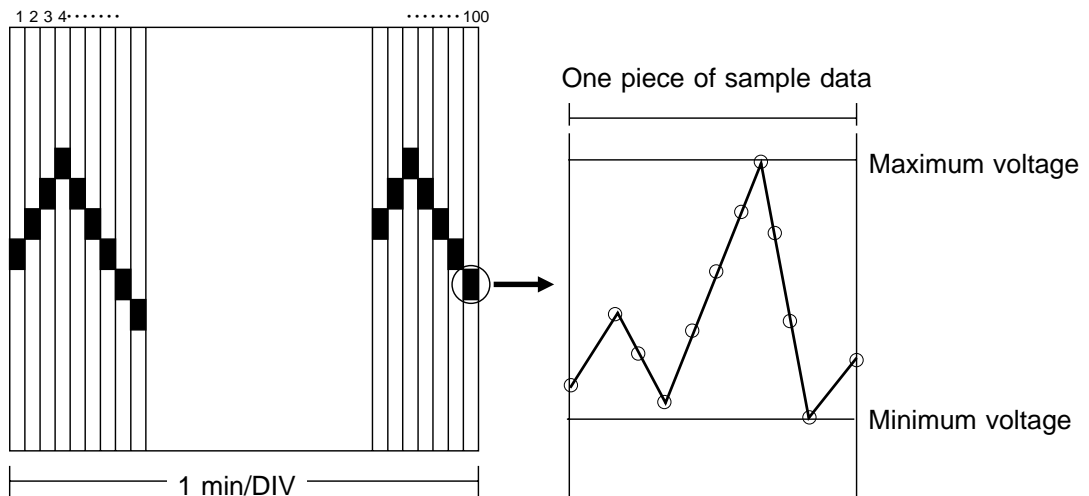

○ : RMS-value data (20 x 60 [s/division]/100 = 12)

## Appendix 4 Size of a Waveform File

### Appendix 4.1 Binary Data

- Recording length is the number of division.
- Truncates the decimal portion of the quotient of division.

#### In the memory recorder and recorder & memory functions (\* .MEM)

File size = header size + data size

Header size =  $512 \times (6 + \text{number of saved analog channels} + \text{number of saved logic probes})$

Data size =  $(2 \times \text{number of saved analog channels} + (\text{number of saved logic probes} + 1) / 2) \times (\text{recording length} \times 100 + 1)$

\* Truncates the decimal portion of the quotient of division.

Recording length: DIV

Recording length	Number of saved logic probes				
	0				
	Number of saved analog channels				
	0	1	2	4	8
20		7,586	12,100	21,128	39,184
50		13,586	24,100	45,128	87,184
100		23,586	44,100	85,128	167,184
200		43,586	84,100	165,128	327,184
500		103,586	204,100	405,128	807,184
1000		203,586	404,100	805,128	1,607,184
2000		403,586	804,100	1,605,128	3,207,184
5000		1,003,586	2,004,100	4,005,128	8,007,184
10000		2,003,586	4,004,100	8,005,128	
20000		4,003,586	8,004,100		
40000		8,003,586			

Recording length	Number of saved logic probes				
	1				
	Number of saved analog channels				
	0	1	2	4	8
20	5,585	10,099	14,613	23,641	41,697
50	8,585	19,099	29,613	50,641	92,697
100	13,585	34,099	54,613	95,641	177,697
200	23,585	64,099	104,613	185,641	347,697
500	53,585	154,099	254,613	455,641	857,697
1000	103,585	304,099	504,613	905,641	1,707,697
2000	203,585	604,099	1,004,613	1,805,641	3,407,697
5000	503,585	1,504,099	2,504,613	4,505,641	8,507,697
10000	1,003,585	3,004,099	5,004,613	9,005,641	
20000	2,003,585	6,004,099	10,004,613		
40000	4,003,585	12,004,099			

Recording length	Number of saved logic probes				
	2				
	Number of saved analog channels				
	0	1	2	4	8
20	6,097	10,611	15,125	24,153	42,209
50	9,097	19,611	30,125	51,153	93,209
100	14,097	34,611	55,125	96,153	178,209
200	24,097	64,611	105,125	186,153	348,209
500	54,097	154,611	255,125	456,153	858,209
1000	104,097	304,611	505,125	906,153	1,708,209
2000	204,097	604,611	1,005,125	1,806,153	3,408,209
5000	504,097	1,504,611	2,505,125	4,506,153	8,508,209
10000	1,004,097	3,004,611	5,005,125	9,006,153	
20000	2,004,097	6,004,611	10,005,125		
40000	4,004,097	12,004,611			

Recording length	Number of saved logic probes				
	3				
	Number of saved analog channels				
	0	1	2	4	8
20	8,610	13,124	17,638	26,666	44,722
50	14,610	25,124	35,638	56,666	98,722
100	24,610	45,124	65,638	106,666	188,722
200	44,610	85,124	125,638	206,666	368,722
500	104,610	205,124	305,638	506,666	908,722
1000	204,610	405,124	605,638	1,006,666	1,808,722
2000	404,610	805,124	1,205,638	2,006,666	3,608,722
5000	1,004,610	2,005,124	3,005,638	5,006,666	9,008,722
10000	2,004,610	4,005,124	6,005,638	10,006,666	
20000	4,004,610	8,005,124	12,005,638		
40000	8,004,610	16,005,124			

Recording length	Number of saved logic probes				
	4				
	Number of saved analog channels				
	0	1	2	4	8
20	9,122	13,636	18,150	27,178	45,234
50	15,122	25,636	36,150	57,178	99,234
100	25,122	45,636	66,150	107,178	189,234
200	45,122	85,636	126,150	207,178	369,234
500	105,122	205,636	306,150	507,178	909,234
1000	205,122	405,636	606,150	1,007,178	1,809,234
2000	405,122	805,636	1,206,150	2,007,178	3,609,234
5000	1,005,122	2,005,636	3,006,150	5,007,178	9,009,234
10000	2,005,122	4,005,636	6,006,150	10,007,178	
20000	4,005,122	8,005,636	12,006,150		
40000	8,005,122	16,005,636			

Note: Four logic channels are assigned to each unit.  
 Unit: byte

### In the recorder, RMS recorder and recorder & memory functions (\*.REC, \*.RMS)

File size = header size + data size

Header size = 512 × (6 + number of saved analog channels + number of saved logic probes)

Data size = (4 × number of saved analog channels + number of saved logic probes) × (recording length × 100 + 1)

\* Truncates the decimal portion of the quotient of division.

Recording length: DIV

		Number of saved logic probes				
		0				
		Number of saved analog channels				
Recording length	0	1	2	4	8	
20		11,588	20,104	37,136	71,200	
50		23,588	44,104	85,136	167,200	
100		43,588	84,104	165,136	327,200	
200		83,588	164,104	325,136	647,200	
500		203,588	404,104	805,136	1,607,200	
1000		403,588	804,104	1,605,136	3,207,200	
2000		803,588	1,604,104	3,205,136	6,407,200	

		Number of saved logic probes				
		1				
		Number of saved analog channels				
Recording length	0	1	2	4	8	
20	5,585	14,101	22,617	39,649	73,713	
50	8,585	29,101	49,617	90,649	172,713	
100	13,585	54,101	94,617	175,649	337,713	
200	23,585	104,101	184,617	345,649	667,713	
500	53,585	254,101	454,617	855,649	1,657,713	
1000	103,585	504,101	904,617	1,705,649	3,307,713	
2000	203,585	1,004,101	1,804,617	3,405,649	6,607,713	

		Number of saved logic probes				
		2				
		Number of saved analog channels				
Recording length	0	1	2	4	8	
20	8,098	16,614	25,130	42,162	76,226	
50	14,098	34,614	55,130	96,162	178,226	
100	24,098	64,614	105,130	186,162	348,226	
200	44,098	124,614	205,130	366,162	688,226	
500	104,098	304,614	505,130	906,162	1,708,226	
1000	204,098	604,614	1,005,130	1,806,162	3,408,226	
2000	404,098	1,204,614	2,005,130	3,606,162	6,808,226	

	Number of saved logic probes				
	3				
	Number of saved analog channels				
Recording length	0	1	2	4	8
20	10,611	19,127	27,643	44,675	78,739
50	19,611	40,127	60,643	101,675	183,739
100	34,611	75,127	115,643	196,675	358,739
200	64,611	145,127	225,643	386,675	708,739
500	154,611	355,127	555,643	956,675	1,758,739
1000	304,611	705,127	1,105,643	1,906,675	3,508,739
2000	604,611	1,405,127	2,205,643	3,806,675	7,008,739

	Number of saved logic probes				
	4				
	Number of saved analog channels				
Recording length	0	1	2	4	8
20	13,124	21,640	30,156	47,188	81,252
50	25,124	45,640	66,156	107,188	189,252
100	45,124	85,640	126,156	207,188	369,252
200	85,124	165,640	246,156	407,188	729,252
500	205,124	405,640	606,156	1,007,188	1,809,252
1000	405,124	805,640	1,206,156	2,007,188	3,609,252
2000	805,124	1,605,640	2,406,156	4,007,188	7,209,252

Note: Four logic channels are assigned to each unit.

Unit: byte

### In the FFT function (\* .FFT)

Number of points	Averaging OFF		Averaging ON	
	1 ch FFT	2 ch FFT	1 ch FFT	2 ch FFT
1000	14,096	24,608	16,100	38,620
2000	24,096	44,608	28,100	72,620
5000	54,096	104,608	64,100	174,620
10000	104,096	204,608	124,100	344,620



## Appendix 4.2 Text File

- Recording length is the number of division.
- Truncates the decimal portion of the quotient of division.

### In the memory recorder and recorder & memory functions (\*.TXT) (Reference values)

- Recording length is the number of division.
- Truncates the decimal portion of the quotient of division.

File size = header size + data size

Header size = 170 + 27 × saved analog channels + 64 × number of saved logic probes

Data size = (14 + 13 × saved analog channels + 9 × number of saved logic probes) × (recording length × 100 + 1)

- \* Truncates the decimal portion of the quotient of division.

Recording length: DIV

	Number of saved logic probes				
	0				
	Number of saved analog channels				
Recording length	0	1	2	4	8
20		58,226	84,266	136,346	240,506
50		145,226	210,266	340,346	600,506
100		290,226	420,266	680,346	1,200,506
200		580,226	840,266	1,360,346	2,400,506
500		1,450,226	2,100,266	3,400,346	6,000,506
1000		2,900,226	4,200,266	6,800,346	12,000,506
2000		5,800,226	8,400,266	13,600,346	24,000,506
5000		14,500,226	21,000,266	34,000,346	60,000,506
10000		29,000,226	42,000,266	68,000,346	
20000		58,000,226	84,000,266		
40000		116,000,226			

	Number of saved logic probes				
	1				
	Number of saved analog channels				
Recording length	0	1	2	4	8
20	50,259	76,299	102,339	154,419	258,579
50	125,259	190,299	255,339	385,419	645,579
100	250,259	380,299	510,339	770,419	1,290,579
200	500,259	760,299	1,020,339	1,540,419	2,580,579
500	1,250,259	1,900,299	2,550,339	3,850,419	6,450,579
1000	2,500,259	3,800,299	5,100,339	7,700,419	12,900,579
2000	5,000,259	7,600,299	10,200,339	15,400,419	25,800,579
5000	12,500,259	19,000,299	25,500,339	38,500,419	64,500,579
10000	25,000,259	38,000,299	51,000,339	77,000,419	
20000	50,000,259	76,000,299	102,000,339		
40000	100,000,259	152,000,299			

Recording length	Number of saved logic probes				
	2				
	Number of saved analog channels				
	0	1	2	4	8
20	68,332	94,372	120,412	172,492	276,652
50	170,332	235,372	300,412	430,492	690,652
100	340,332	470,372	600,412	860,492	1,380,652
200	680,332	940,372	1,200,412	1,720,492	2,760,652
500	1,700,332	2,350,372	3,000,412	4,300,492	6,900,652
1000	3,400,332	4,700,372	6,000,412	8,600,492	13,800,652
2000	6,800,332	9,400,372	12,000,412	17,200,492	27,600,652
5000	17,000,332	23,500,372	30,000,412	43,000,492	69,000,652
10000	34,000,332	47,000,372	60,000,412	86,000,492	
20000	68,000,332	94,000,372	120,000,412		
40000	136,000,332	188,000,372			

Recording length	Number of saved logic probes				
	3				
	Number of saved analog channels				
	0	1	2	4	8
20	86,405	112,445	138,485	190,565	294,725
50	215,405	280,445	345,485	475,565	735,725
100	430,405	560,445	690,485	950,565	1,470,725
200	860,405	1,120,445	1,380,485	1,900,565	2,940,725
500	2,150,405	2,800,445	3,450,485	4,750,565	7,350,725
1000	4,300,405	5,600,445	6,900,485	9,500,565	14,700,725
2000	8,600,405	11,200,445	13,800,485	19,000,565	29,400,725
5000	21,500,405	28,000,445	34,500,485	47,500,565	73,500,725
10000	43,000,405	56,000,445	69,000,485	95,000,565	
20000	86,000,405	112,000,445	138,000,485		
40000	172,000,405	224,000,445			

Recording length	Number of saved logic probes				
	4				
	Number of saved analog channels				
	0	1	2	4	8
20	104,478	130,518	156,558	208,638	312,798
50	260,478	325,518	390,558	520,638	780,798
100	520,478	650,518	780,558	1,040,638	1,560,798
200	1,040,478	1,300,518	1,560,558	2,080,638	3,120,798
500	2,600,478	3,250,518	3,900,558	5,200,638	7,800,798
1000	5,200,478	6,500,518	7,800,558	10,400,638	15,600,798
2000	10,400,478	13,000,518	15,600,558	20,800,638	31,200,798
5000	26,000,478	32,500,518	39,000,558	52,000,638	78,000,798
10000	52,000,478	65,000,518	78,000,558	104,000,638	
20000	104,000,478	130,000,518	156,000,558		
40000	208,000,478	260,000,518			

Note: Four logic channels are assigned to each unit.

Unit: byte

## In the recorder, RMS recorder and recorder & memory functions (\*.TXT) (Reference values)

File size = header size + data size

Header size =  $170 + 64 \times \text{number of saved analog channels} + 165 \times \text{number of saved logic probes}$

Data size =  $(14 + 26 \times \text{number of saved analog channels} + 18 \times \text{number of saved logic probes}) \times (\text{recording length} \times 100 + 1)$

\* Truncates the decimal portion of the quotient of division.

Recording length: DIV

		Number of saved logic probes				
		0				
		Number of saved analog channels				
Recording length		0	1	2	4	8
20			84,276	136,366	240,546	448,906
50			210,276	340,366	600,546	1,120,906
100			420,276	680,366	1,200,546	2,240,906
200			840,276	1,360,366	2,400,546	4,480,906
500			2,100,276	3,400,366	6,000,546	11,200,906
1000			4,200,276	6,800,366	12,000,546	22,400,906
2000			8,400,276	13,600,366	24,000,546	44,800,906

		Number of saved logic probes				
		1				
		Number of saved analog channels				
Recording length		0	1	2	4	8
20		68,369	120,459	172,549	276,729	485,089
50		170,369	300,459	430,549	690,729	1,211,089
100		340,369	600,459	860,549	1,380,729	2,421,089
200		680,369	1,200,459	1,720,549	2,760,729	4,841,089
500		1,700,369	3,000,459	4,300,549	6,900,729	12,101,089
1000		3,400,369	6,000,459	8,600,549	13,800,729	24,201,089
2000		6,800,369	12,000,459	17,200,549	27,600,729	48,401,089

		Number of saved logic probes				
		2				
		Number of saved analog channels				
Recording length		0	1	2	4	8
20		104,552	156,642	208,732	312,912	521,272
50		260,552	390,642	520,732	780,912	1,301,272
100		520,552	780,642	1,040,732	1,560,912	2,601,272
200		1,040,552	1,560,642	2,080,732	3,120,912	5,201,272
500		2,600,552	3,900,642	5,200,732	7,800,912	13,001,272
1000		5,200,552	7,800,642	10,400,732	15,600,912	26,001,272
2000		10,400,552	15,600,642	20,800,732	31,200,912	52,001,272

Recording length	Number of saved logic probes				
	3				
	Number of saved analog channels				
	0	1	2	4	8
20	140,735	192,825	244,915	349,095	557,455
50	350,735	480,825	610,915	871,095	1,391,455
100	700,735	960,825	1,220,915	1,741,095	2,781,455
200	1,400,735	1,920,825	2,440,915	3,481,095	5,561,455
500	3,500,735	4,800,825	6,100,915	8,701,095	13,901,455
1000	7,000,735	9,600,825	12,200,915	17,401,095	27,801,455
2000	14,000,735	19,200,825	24,400,915	34,801,095	55,601,455

Recording length	Number of saved logic probes				
	4				
	Number of saved analog channels				
	0	1	2	4	8
20	176,918	229,008	281,098	385,278	593,638
50	440,918	571,008	701,098	951,278	1,481,638
100	880,918	1,141,008	1,401,098	1,921,278	2,961,638
200	1,760,918	2,281,008	2,801,098	3,841,278	5,921,638
500	4,400,918	5,701,008	7,001,098	9,601,278	14,801,638
1000	8,800,918	11,401,008	14,001,098	19,201,278	29,601,638
2000	17,600,918	22,801,008	28,001,098	38,401,278	59,201,638

Note: Four logic channels are assigned to each unit.

Unit: byte

**In the FFT function (\* .TXT) (Reference values)**

Number of points	Analysis mode			
	STR, ACR, CCR, IMP	LIN, RMS, PSP, HIS, TRF, CSP, CHO	OCT (1/1)	OCT (1/3)
1000	27,190	11,017	320	580
2000	54,190	21,817		
5000	135,190	54,217		
10000	270,190	108,217		

The size in case of one screen. In the case of two screens, add the respective graph sizes.

## Appendix 5 Waveform Viewer (Wv)

The waveform viewer provides a simplified view of data transferred to a PC by remote control or data acquisition. The viewer has a CSV conversion function. Converted files may be read by a spreadsheet program.

### System requirements

For a PC running Windows 95, 98, Me, Windows NT4.0 SP3 or later, Windows 2000, or Windows XP

### Installation

Install by the following procedure:

1. When you insert the Application Disk (CD-R) into the CD-ROM drive, the opening page should appear automatically. If it does not appear, open the "index.htm" file with your Web browser.
2. Select the language to display (click the English icon).
3. Click the [Wave viewer (Wv)] icon to view Wv specifications and revision history.
4. Click the [Install] icon at the top right of the page to open the [File Download] dialog.
5. Click [Open] to display the confirmation dialog to proceed with installation.
6. Click [Next] to open the installation destination selection window. Click the [Browse] button to change the installation folder.
7. Click [Next] to start installation.  
The program is now installed.

### Handling the CD-R

**CAUTION**

- Always hold the disc by the edges, so as not to make fingerprints on the disc or scratch the printing.
- Never touch the recorded side of the disc. Do not place the disc directly on anything hard.
- Do not wet the disc with volatile alcohol or water, as there is a possibility of the label printing disappearing.
- To write on the disc label surface, use a spirit-based felt pen. Do not use a ball-point pen or hard-tipped pen, because there is a danger of scratching the surface and corrupting the data. Do not use adhesive labels.
- Do not expose the disc directly to the sun's rays, or keep it in conditions of high temperature or humidity, as there is a danger of warping, with consequent loss of data.
- To remove dirt, dust, or fingerprints from the disc, wipe with a dry cloth, or use a CD cleaner. Always wipe radially from the inside to the outside, and do not wipe with circular movements. Never use abrasives or solvent cleaners.
- Hioki shall not be held liable for any problems with a computer system that arises from the use of this CD-R, or for any problem related to the purchase of a Hioki product.

In the Windows Start menu, select [Programs] - [HIOKI] - [Wv]. This starts the waveform viewer application.

To close the waveform viewer application, in the [File] menu select [Exit]. You can also click the Close button at the top right corner of the window.

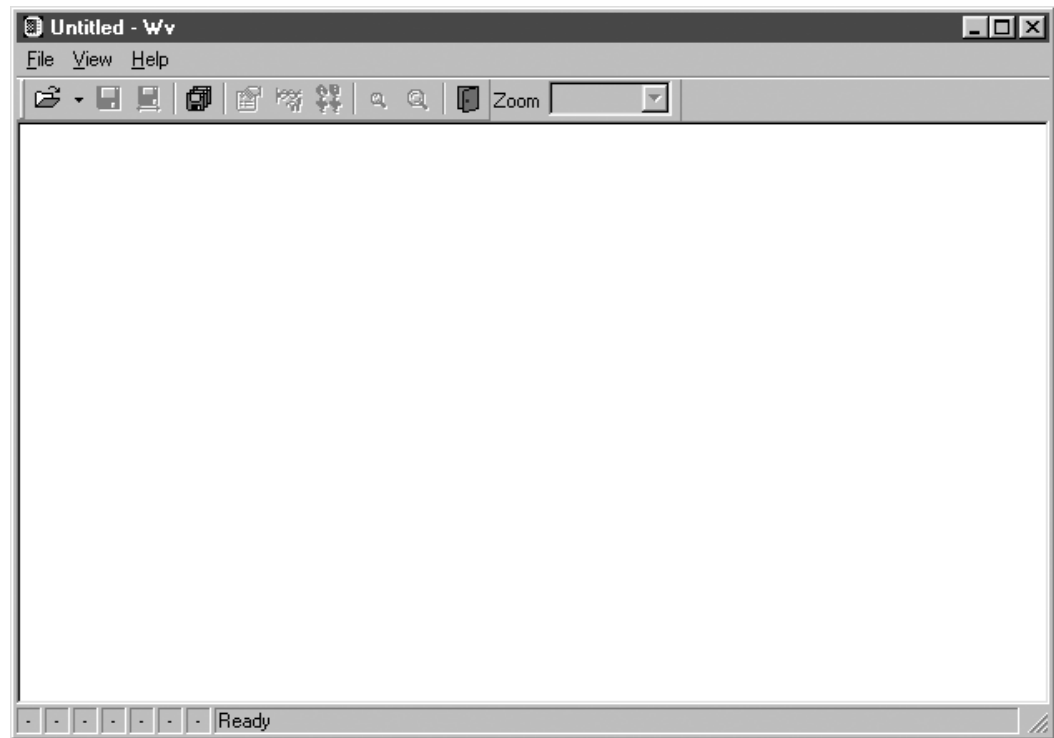

### Toolbar

Click the icons in the toolbar for the respective functions.

From the left, these are: [Open], [Save All], [Save Between Cursors], [Batch Conversion], [Properties], [Wave Control Panel], [Trace], [Zoom Out], [Zoom In], and [Exit].

For details of these operations, see the descriptions of the corresponding menu items.

You can also select the magnification factor for the time axis by selecting on the toolbar.

### Status bar

The status bar shows, from the left, the model name, function, recording length, time axis, trigger time, pre-trigger and judgment result.

### Version information

When making inquiries, the version number will be required.

To check the software version number, in the [Help] menu select [About Wv].

## Appendix 5.1 Waveform Viewer Menus

The following is the complete menu tree of the waveform viewer application.

File ⋮ ↓	Open		
	Save All		
	Save Between Cursors		
	Batch Conversion		
	Exit		
View	Toolbar		
	Status Bar		
	Wave Control Panel		
	Properties		
	Trace		
	Block List		
	Zoom In		
	Zoom Out		
	Set Magnification		
	Jump	Trig	
		A Cursor	
		B Cursor	
	Time Notation	DIV	
		Sec	
		Point	
		Trig	
		Date	
	Grid Type	None	
		Standard	
		Fine	
Title			
Remarks			
Fixed			
Capture			

Right-click with the mouse in the waveform display screen for the following functions.

Right-click with the mouse	Wave Control Panel		
	Properties		
	Trace		
	Block List		
	Zoom In		
	Zoom Out		
	Set Magnification		
	Jump	Trig	
		A Cursor	
		B Cursor	
	Time Notation	DIV	
		Sec	
		Point	
		Trig	
		Date	
	Grid Type	None	
		Standard	
		Detail	
	Title		
	Remarks		
	Fixed		
	Color	Text	
		Background	
		Grid	
	Font		
	Capture		



## Appendix 5.2 Using the Waveform Viewer

### Waveform display

To display a waveform it is first necessary to select the file to be displayed. In the [File] menu, select [Open], to display the file selection dialog box. Select a waveform file, and click Open to read in the file, and display the waveform.

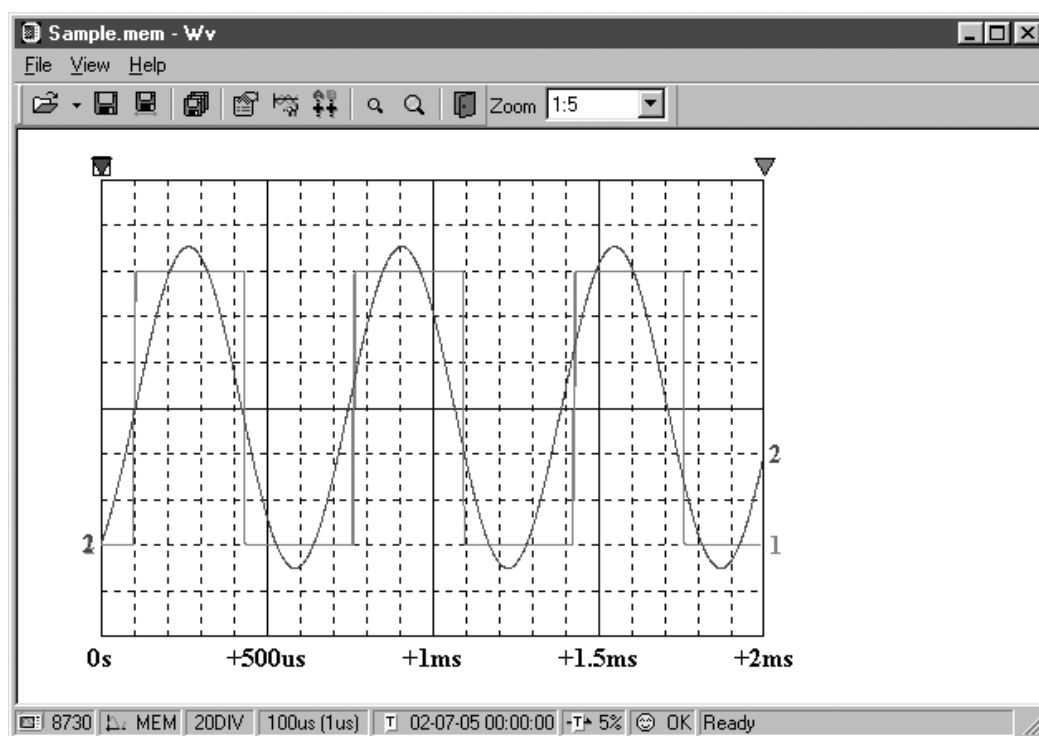

### Changing the time axis scale (zoom function)

You can change the time axis scale in the display using the menus or toolbar. In the toolbar, click the [Set Magnification] box, to display the possible zoom factors: you can then select any desired value.

### Changing waveform scale and position (Waveform Control Panel)

You can adjust the display for each channel separately. In the [View] menu, select [Wave Control Panel] to display a dialog box.

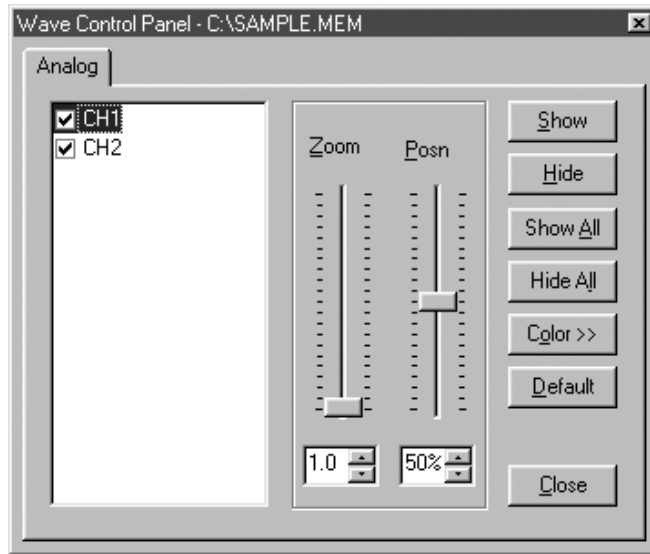

CH	This indicate the list of channel. When a check mark is present the corresponding channel is displayed.
Zoom	Set the magnification on the voltage axis for the specified channel.
Posn	Set the position of the specified channel.
Show	Display the specified channel(s).
Hide	Do not display the specified channel(s).
Show All	Display all channels.
Hide All	Do not display all channels.
Color	Change the color of the specified channel(s).
Default	Set all values of the specified channel(s) to their default values.
Close	Close the Waveform Control Panel.

### Checking the waveform measurement conditions (Properties)

Select [View], then [Properties] from the menu to display the measurement settings on the MEMORY HiCORDER.

### Checking voltage values (Trace)

Select [View], then [Trace] from the menu to check the time value and difference of the two cursors (A and B) and the voltage values and differences of all channels.

### File list in index file

Select [View], then [Block List] to check the file list (block number, file name, time axis range, trigger time) in the index file.

Double-click a file in the list opens a new window in which you can check waveform in that file.

\* This is effective only when reading Sequential, Multi-block, REC&MEM index files.

### **Waveform jump function**

Select [View], then [Jump] to jump to the trigger position or the positions of the A or B cursors.

### **Time Notation**

Select [View], then [Time Notation]. You can select the time notation on the waveform display screen.

### **Setting Grid Type**

Select [View], then [Grid Type] on the menu to set the type of grid (None, Standard, or Fine).

### **Display of Title Comment**

Select [View], then [Title] on the menu to display a title comment at the top of the waveform screen.

### **Waveform legend view**

Select [View], then [Remarks] on the menu to view the unit type of each channel, measurement mode, measurement range, filters, comments, scaling, display position, and magnification on the portion below the waveform screen.

### **Fixing waveform view conditions**

Select [View], then [Fixed] on the menu to always view waveforms with the same color, display position and magnification.

When this item is enabled, the file view settings are disabled.

The standard values for display conditions are automatically saved when the application is terminated or when the check mark is removed from [Fixed] menu.

### **Setting the display colors**

Right-click on the waveform display screen, and select [Color], then [Text] [Background] [Grid] to display a dialog box for setting the respective colors.

### **Font settings (character size)**

Right-click on the waveform display screen, and select [Font], to display the font setting dialog box. You can then select the font for text on the waveform display screen.

### **Waveform display snaps (capture)**

Select [View], then [Capture] on the menu to capture waveform display and copy to clipboard as a bit image. You can paste it into other applications.

## Appendix 5.3 Conversion to CSV Format

You can convert displayed waveform data to a CSV format file. Once in CSV format, the file can be loaded into spreadsheet or other software for further processing. You can either convert the whole data file or a range selected with the cursors.

If selecting a range, first set the cursors to the required positions. These are indicated at the top of the waveform screen by inverted blue and red "▼": drag these triangles with the mouse to set the range.

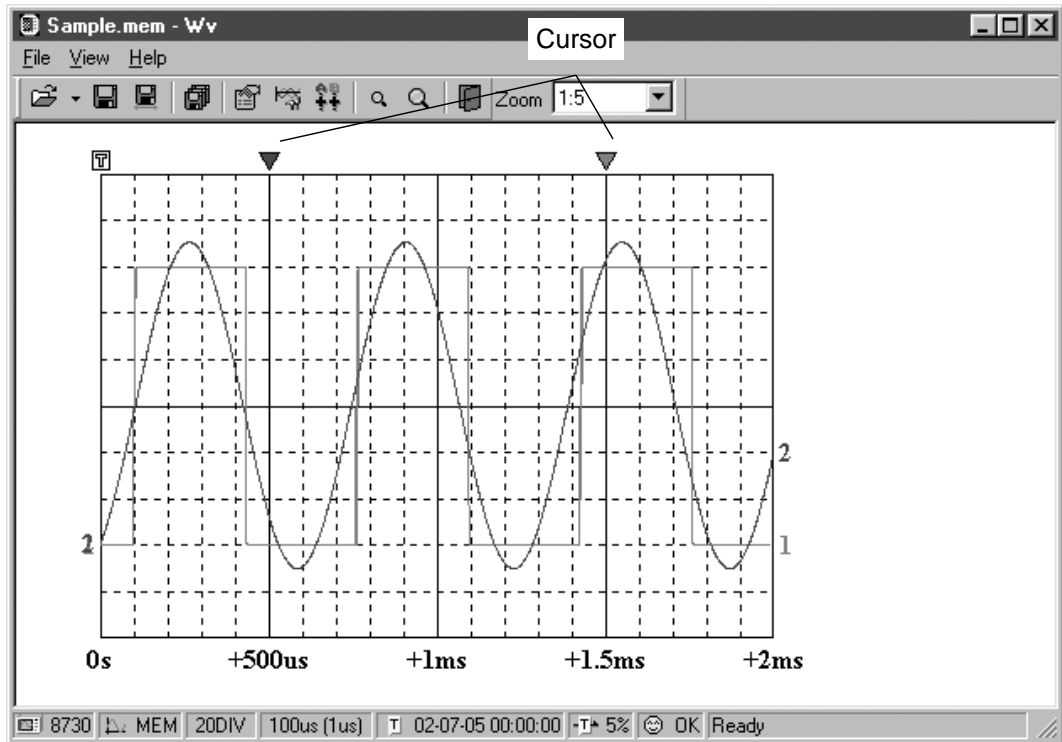

Then to save all of the data, in the [File] menu, select [Save All]; to save the range only, in the [File] menu, select [Save Between Cursors].

A dialog box appears for setting the file to be saved, and the thinning.

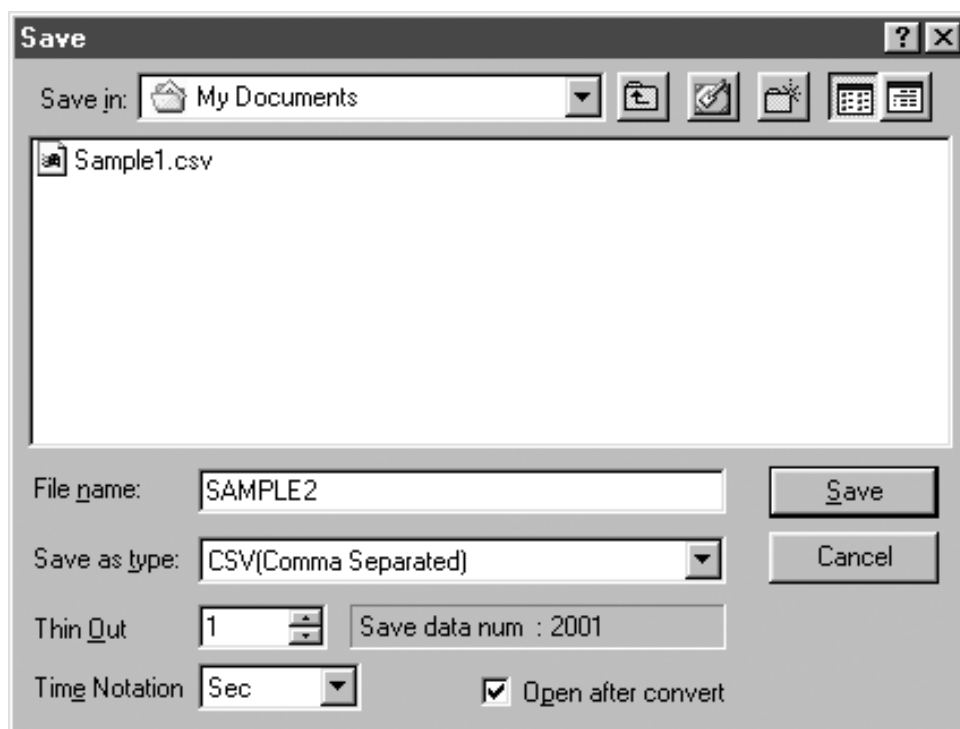

To save in text formats other than CSV (space delimited or tab delimited), select the desired format from the [Save as type] list.

In the [Thin Out] box, enter the number of original samples corresponding to one converted value.

Use this when data over a large range (long time interval) is required, but the whole set of sampled data is not required.

Select [Time Notation] from among [Sec], [Date], [Trig], and [Point].

Enter the name of the file to be saved, and click the [Save] button to convert the data to CSV format and save the file.

## Appendix 5.4 Batch Conversion

You can convert multiple waveform files CSV files.

1. Select [File] from the menu bar, then select [Batch Conversion] from the File menu.
2. Select the desired files from the file list. To select two or more files, left-click on the desired files while holding down the Shift or Control key.

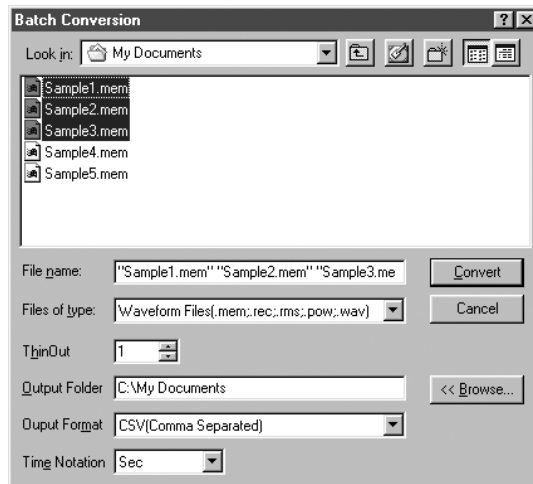

3. If required, specify the sampling intervals in the [ThinOut] box at which data is to be converted. Remember that not all data needs to be converted. This setting is useful when you need data over a broad time span.
4. In the [Output Folder], specify the folder in which to save the CSV files converted from waveform files. You can specify the desired folder without typing simply by clicking on the [<<Browse...] button and selecting the desired folder from the list.
5. To save in text formats other than CSV (space delimited or tab delimited), select the desired format from the [Output Format] list.
6. Select [Time Notation] from among [Sec], [Date], [Trig], and [Point].
7. Click the [Convert] button. All selected waveform files are converted to CSV files and saved in the specified folder.

# Index

## - A -

A/B cursors	37, 259
A/D	APPENDIX5
Additional recording	91, 110
Aliasing	APPENDIX7
Analog trigger	177
ANALOG UNIT	19, 33, 118, 326
AND/OR	176, 194
Any recording length	53, 84, 104
Area value	73
Attenuator	APPENDIX5
AUTO	171
Auto print	61, 253
Auto range function	36, 67
Auto save	62, 93, 112
Auto setup function	295
Auto-balancing	138
Auto-scroll	263, 264
Automatic file name assignment	290
Average value	71

## - B -

Backlight saver	207
Baseline offset	127
Battery	345
Beep sound	209
Bit map file (BMP)	229, 287
Block diagram	319
Bridge voltage	22, 330
Byte	APPENDIX5

## - C -

CHAN key	35
CH DIR	301
Channel Guide	168
Channel marker	205, 250
CHANNEL screen	117
CHARGE UNIT	25, 34, 154, 334
CLAMP-ON PROBE	340
Comment	222, 251
Common mode	APPENDIX5
CONNECTION CORD	19, 338
Continuous X-Y plot	88
Conversion ratio scaling	212
COPY key	39, 230
Copy	298
Cursor keys	36
Cutoff frequency	APPENDIX5

## - D -

DC POWER ADAPTER	16, 318
DELETE	297
DIFFERENTIAL PROBE	27, 339
Digital filter	131
Directory	300
DISP key	35
Display check	243
Display color	208
DISPLAY screen	66, 95, 114
DIV (division)	53, APPENDIX5
Dot	87, 88
Drift compensation	132
Dual	55, 86, 106

**- E -**

Error	APPENDIX1, APPENDIX2
Error messages	APPENDIX1, APPENDIX2
External printer	210, 231, 258
External sampling	53, 210, 272
External trigger	199, 273, 274

**- F -**

Fall time	72
FEED key	39
FFT ANALOG UNIT	19, 33, 135, 329
FFT function	315
File contents	291
FILE key	35
Filter width	181, 183
Fixed recording length	53, 84, 104
Floppy disk	278
Format	55, 86, 106, 280
Free-run operation	170, 171
Frequency	72, 103
Function keys	36
Functional ground terminal	9, 17
Fuse	14
F/V UNIT	23, 34, 141, 331

**- G -**

Gauge	206
GND	9
GO	275
GP-IB	232, 317
Grid	205, 250
Grounding	14

**- H -**

Hard Copy	256
HELP key	35, 41
Hold	144
Horizontal cursor	260
Horizontal scroll bar	39

**- I -**

INFO	296
Initialization	239, 280
Input coupling	122, 153
Input level monitor function	166
Installation environment	v
Installation orientation	12
Interface	229, 308
Interval	197

**- J -**

Jog control	37
-------------	----

**- K -**

Key check	244
Key lock function	276

**- L -**

LAN	235
Language	209
LED	37, 38
Level trigger	178
Line cursor (horizontal)	260
Line cursor (vertical)	260
List and gauge	206
List print	256, 302
Load	294
LOGIC PROBE	26, 324
Logic trigger	194
Logic waveform	160, 323
Low-pass filter	129, 140

**- M -**

Magnification/compression	66, 123
Manual print	252
Manual trigger	39, 200
Maximum input voltage	vi, 31, 33, 270



Maximum rated voltage to earth ..... vi, 31  
 Maximum sampling ..... 305  
 Maximum value ..... 71  
 Measurement limit frequency ..... APPENDIX8  
 Memory capacity ..... 305  
 Memory recorder function ..... 49, 311  
 MK DIR ..... 300  
 Minimum value ..... 71  
 MS-DOS ..... APPENDIX6

**- N -**

NG ..... 9, 275  
 Numeric data ..... 60, 90, 109

**- O -**

Offset ..... APPENDIX6  
 On-line help ..... 41  
 Open collector ..... APPENDIX6  
 Overlay ..... 64

**- P -**

PRINT key ..... 39, 231  
 Partial print ..... 255  
 Partial save ..... 292  
 Partial X-Y plot ..... 58  
 PC card ..... 281, 286, 303  
 PC card check ..... 244  
 Peak-to-peak value ..... 71  
 Period ..... 72  
 Period trigger ..... 187  
 Power switch ..... 18  
 Pre-trigger ..... 172  
 PRINT/EXT.SMPL ..... 210  
 Printer check ..... 243  
 Printer density ..... 207  
 Printer format ..... 59, 89, 108  
 Printer head cleaning ..... 344  
 Probe ..... 19, 324  
 Processing functions ..... 68  
 Pull-up resistance ..... 145

**- Q -**

QUAD ..... 55, 86, 106

**- R -**

Real time printing ..... 92, 111, 254  
 Recorder & memory function ..... 314  
 Recorder function ..... 79, 312, APPENDIX9  
 Recording length ..... 53, 84, 104  
 Recording paper ..... ii, viii, 27  
 Reference junction compensation ..... 133  
 REPEAT ..... 171  
 Report print ..... 257  
 Ripple component ..... APPENDIX6  
 Rise time ..... 72  
 RM DIR ..... 301  
 RMS level trigger ..... 191  
 RMS recorder function  
 ..... 99, APPENDIX10  
 RMS value ..... 71  
 ROM/RAM check ..... 242  
 Roll Mode ..... 61  
 RS-232C ..... 233, 317

**- S -**

Safety symbols ..... iii  
 Sampling ..... APPENDIX7  
 Save ..... 288  
 Scaling function ..... 211  
 Screen hard copy ..... 256  
 Scrolling ..... 264  
 Select key ..... 37  
 Self-check ..... 242  
 Setting state ..... 286  
 SETUP ..... 203  
 Shuttle control ..... 37  
 SINGLE ..... 55, 86, 106, 171  
 Size of a waveform file ..... APPENDIX11  
 Smooth printing ..... 59, 248  
 Sort ..... 298  
 Standard deviation ..... 73

Start and stop	75, 96, 114, 270
START key	38
Start key backup	204
Start time	196
STOP key	38
Stop time	196
Storage	APPENDIX6
Storage capacity	49
STRAIN UNIT	22, 33, 137, 330
System reset	241, 348
SYSTEM screen	201

**- T -**

Thermal head	344
Threshold value	146
Time axis range	52, 82, 102, 320
Time interval	196
TIME SET	239
Time to maximum value	71
Time to minimum value	72
Timer trigger	196
Time value	206
Title comment	223, 251
Trace cursor	260
Trigger direction	180, 188, 192
Trigger filter	179, 194
Trigger functions	169
Trigger level	178, 186
Trigger marker	170
Trigger mode	171
Trigger output	200, 274
Trigger pattern	195
Trigger position	40
Trigger source	176
Trigger timing	175

**- U -**

Unbalanced input	APPENDIX6
Unit	219
Use Channel	204

**- V -**

Variable function	163
Vernier function	267
Vertical Cursor	260
VIEW	39
Voltage axis range	121
Voltage drop trigger	185
Voltage transformer	33
VOLTAGE/TEMP UNIT	20, 33, 130, 327

**- W -**

WARNING	APPENDIX1,APPENDIX2
WAVE DATA CLEAR	240
Waveform Viewer (Wv)	APPENDIX19
Waveform display color	118
Waveform processing calculation	4
Window-in trigger	182
Window-out trigger	182
Word	APPENDIX6
Write-protect	278

**- X -**

X-Y area	74
X-Y plot	57

**- Z -**

Zero adjustment	126
Zero position	124
Zoom function	265

**- Others -**

2-point scaling	215
4 ch ANALOG UNIT	19, 33, 152, 333

# HIOKI

## DECLARATION OF CONFORMITY

Manufacturer's Name: HIOKI E.E. CORPORATION  
Manufacturer's Address: 81 Koizumi, Ueda, Nagano 386-1192, Japan  
Product Name: MEMORY HiCORDER  
Model Number: 8835-01  
Options:  
8936 ANALOG UNIT  
8937 VOLTAGE/TEMP UNIT  
8938 FFT ANALOG UNIT  
8939 STRAIN UNIT  
8940 F/V UNIT  
8947 CHARGE UNIT  
9439 DC POWER ADAPTER  
9305 TRIGGER CORD  
9559 PRINTER CARD  
9320 LOGIC PROBE  
9321 LOGIC PROBE  
9197 CONNECTION CORD  
9198 CONNECTION CORD  
9199 CONVERSION ADAPTOR  
9217 CONNECTION CORD

The above mentioned products conform to the following product specifications:

Safety: EN61010-1:2001  
EN61010-031:2002  
EMC: EN61326:1997+A1:1998+A2:2001+A3:2003  
Class A equipment  
Minimum immunity test requirement  
EN61000-3-2:2000  
EN61000-3-3:1995+A1:2001

Supplementary Information:

The products herewith comply with the requirements of the Low Voltage Directive 73/23/EEC and the EMC Directive 89/336/EEC.

HIOKI E.E. CORPORATION

15 September 2006

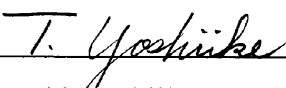
  
\_\_\_\_\_  
Tatsuyoshi Yoshiike  
President

8835A999-09



## **HIOKI 8835-01 MEMORY HiCORDER**

### Instruction Manual

Publication date: November 2006 Revised edition 9

Edited and published by HIOKI E.E. CORPORATION  
Technical Support Section

All inquiries to International Sales and Marketing Department

81 Koizumi, Ueda, Nagano, 386-1192, Japan

TEL: +81-268-28-0562 / FAX: +81-268-28-0568

E-mail: [os-com@hioki.co.jp](mailto:os-com@hioki.co.jp)

URL <http://www.hioki.co.jp/>

Printed in Japan 8835B981-09

- 
- 
- All reasonable care has been taken in the production of this manual, but if you find any points which are unclear or in error, please contact your supplier or the International Sales and Marketing Department at HIOKI headquarters.
  - In the interests of product development, the contents of this manual are subject to revision without prior notice.
  - Unauthorized reproduction or copying of this manual is prohibited.
- 
-

# HIOKI

---

HIOKI E. E. CORPORATION

## HEAD OFFICE

81 Koizumi, Ueda, Nagano 386-1192, Japan  
TEL +81-268-28-0562 / FAX +81-268-28-0568  
E-mail: [os-com@hioki.co.jp](mailto:os-com@hioki.co.jp) / URL <http://www.hioki.co.jp/>

## HIOKI USA CORPORATION

6 Corporate Drive, Cranbury, NJ 08512, USA  
TEL +1-609-409-9109 / FAX +1-609-409-9108

---

8835B981-09 06-11H



Printed on recycled paper

---

**T**  **USA**  
**Equipment**  
**.NET**™  
**1-877-742-TEST (8378)**