

INSTRUCTION MANUAL

8841

8842

MEMORY HiCORDER

HIOKI E. E. CORPORATION

Contents

Introduction	i
Inspection	i
Safety Notes	iii
Notes on Use	v
Chapter Summary	ix
Chapter 1 Product Overview	1
1.1 Major Features	1
1.2 Identification of Controls and Indicators	3
Chapter 2 Installation and Preparation	7
2.1 Installation of the Unit	7
2.2 Power Supply and Ground Connections	9
2.2.1 Connecting the AC Power Supply	9
2.2.2 Connecting the 9433 DC POWER ADAPTER	10
2.2.3 Functional Grounding of the 8841/8842	12
2.3 Power On/Off	13
2.4 Connection of the Input Unit	14
2.4.1 8936/ 8938/ 8946 ANALOG UNITS	14
2.4.2 8937 VOLTAGE/TEMP UNIT	15
2.4.3 8939 STRAIN UNIT	16
2.4.4 8940 F/V UNIT	17
2.4.5 8947 CHARGE UNIT	19
2.5 Logic Probe Connection	20
2.6 9018-10/9132-10 CLAMP ON PROBE	21
2.7 9322 DIFFERENTIAL PROBE Connection	22
2.8 Loading Recoding Paper	23
2.9 Care of Recording Paper	25
2.10 Notes on Measurement	26
2.10.1 Maximum Input Voltage	28
2.10.2 Using a Voltage Transformer	29
Chapter 3 Basic Key Operation	31
3.1 Basic Key Operation	31
3.1.1 Basic Display Operation (MENU)	31
3.1.2 Printer Key Operation	31
3.1.3 Setting the Items	32
3.1.4 Jog/Shuttle Controls and Select Key	32
3.1.5 Basic Input Operation	33
3.1.6 Measurement Start and Stop Operation	33

3.2	Other Keys Operation	34
3.3	Screen Configuration	35
Chapter 4	Memory Recorder Function	37
4.1	Overview of the Memory Recorder Function	37
4.2	Operation Sequence (MEM)	39
4.3	STATUS Settings (MEM)	41
4.3.1	Setting the Function Mode	42
4.3.2	Setting the Time Axis Range	42
4.3.3	Setting the Recording Length	43
4.3.4	Setting the Display Layout	44
4.3.5	Setting the Interpolation (dot-line)	46
4.3.6	Setting the Print Mode	46
4.3.7	Setting the Roll Mode	47
4.3.8	Setting the Auto Print Function	47
4.3.9	Setting the Auto Save Function	48
4.3.10	Setting the Overlay Function	50
4.3.11	Setting the Averaging Function	51
4.3.12	Setting the Waveform Evaluation	53
4.4	Using the X-Y Waveform Plots (MEM)	54
4.5	Settings on the Waveform Display Screen (MEM)	57
4.6	Auto Range Function	58
4.7	Other Screen Settings	60
4.8	Start and Stop Operation (MEM)	61
Chapter 5	Recorder Function	63
5.1	Overview of the Recorder Function	63
5.2	Operation Sequence (REC)	65
5.3	STATUS Settings (REC)	67
5.3.1	Setting the Function Mode	68
5.3.2	Setting the Time Axis Range	68
5.3.3	Setting the Sampling Period	69
5.3.4	Setting the Recording Length	69
5.3.5	Setting the Display Layout	70
5.3.6	Setting the Print Mode	73
5.3.7	Setting the Additional Recording Function	74
5.3.8	Setting the Printer Function (Real Time Printing)	75
5.3.9	Setting the Auto Save Function	76
5.3.10	Setting the Interpolation (dot-line, X-Y only)	77
5.3.11	Setting the Display Clear Function (X-Y only)	77
5.4	Using the X-Y CONT Recorder	78
5.4.1	Setting the Status Screen	79

5.4.2	Setting the Channel Screen	79
5.4.3	Setting the Display Screen	80
5.5	Settings on the Waveform Display Screen (REC)	81
5.6	Start and Stop Operation (REC)	82

Chapter 6 RMS Recorder Function **83**

6.1	Overview of the RMS Recorder Function	83
6.2	Operation Sequence (RMS)	84
6.3	STATUS Settings (RMS)	86
6.3.1	Setting the Function Mode	87
6.3.2	Setting the Time Axis Range	87
6.3.3	Setting the Frequency	88
6.3.4	Setting the Recording Length	88
6.3.5	Setting the Display Layout	89
6.3.6	Setting the Print Mode	91
6.3.7	Setting the Additional Recording Function	92
6.3.8	Setting the Printer Function (Real Time Printing)	93
6.3.9	Setting the Auto Save Function	93
6.4	Settings on the Waveform Display Screen (RMS)	95
6.5	Start and Stop Operation (RMS)	96

Chapter 7 Recorder & Memory Function **97**

7.1	Overview of the Recorder & Memory Function	97
7.2	Operation Sequence (REC&MEM)	98
7.3	STATUS Settings (REC&MEM)	100
7.3.1	Setting the Function Mode	101
7.3.2	Setting the Time Axis Range	102
7.3.3	Setting the Recording Length	103
7.3.4	Display Function	104
7.3.5	Setting the Display Layout	105
7.3.6	Setting the Print Mode	106
7.3.7	Setting the Additional Recording Function	107
7.3.8	Setting the Printer Function (Real-time Printing)	108
7.3.9	Setting the Auto Save Function	109
7.3.10	Setting the Real-Time Save	111
7.4	Settings on the Waveform Display Screen (REC&MEM)	117
7.5	Start and Stop Operation (REC&MEM)	118

Chapter 8 FFT Function 119

8.1	Overview of the FFT Function	119
8.2	Operation Sequence (FFT)	120
8.3	STATUS1 Settings (FFT)	122
8.3.1	Setting the Function Mode	123
8.3.2	Setting the FFT Channel Mode	123
8.3.3	Setting the Frequency Range	124
8.3.4	FFT Number of Points Setup	125
8.3.5	Setting the Window Function	125
8.3.6	Setting the Display Format	126
8.3.7	Selecting Reference Data	128
8.3.8	Setting the FFT Analysis Mode	129
8.3.9	Setting the X-axis and Y-axis Displays	130
8.3.10	Setting the Analysis Channel	132
8.3.11	Setting the Display Scale	133
8.3.12	Octave Filter Setting	134
8.4	STATUS2 Settings (FFT)	135
8.4.1	Setting the Averaging Function	136
8.4.2	Setting the Interpolation (dot-line)	139
8.4.3	Setting the Print Mode	140
8.4.4	Setting the Auto Print Function	140
8.4.5	Setting the Auto Save Function	141
8.4.6	Setting the Waveform Evaluation	142
8.5	Settings on the Waveform Display Screen (FFT) ..	143
8.6	Start and Stop Operation (FFT)	144
8.7	FFT Analysis Function	145
8.7.1	Storage Waveform [STR]	145
8.7.2	Linear Spectrum [LIN]	146
8.7.3	RMS Spectrum [RMS]	148
8.7.4	Power Spectrum [PSP]	150
8.7.5	Auto Correlation [ACR]	152
8.7.6	Histogram [HIS]	153
8.7.7	Transfer Function [TRF]	154
8.7.8	Cross Power Spectrum [CSP]	156
8.7.9	Cross Correlation [CCR]	158
8.7.10	Unit Impulse Response [IMP]	159
8.7.11	Coherence [COH]	160
8.7.12	Octave Analysis [OCT]	161

Chapter 9	Input Channel Settings	165
9.1	Overview	165
9.2	Operation Procedure (Input Channel Setting)	166
9.3	Setting the CHANNEL Screen	168
9.3.1	Setting the Waveform Display Color	169
9.3.2	Setting the Waveform Display Graph Position	169
9.3.3	Setting the Voltage Axis Range	170
9.3.4	Setting the Input Coupling	170
9.3.5	Setting the Magnification/Compression Ratio Along the Voltage Axis	171
9.3.6	Setting the Zero Position	172
9.3.7	Setting the Low-pass Filter	173
9.3.8	Setting the Logic Inputs	174
9.4	Copying Channel Settings	175
9.5	Zero Settings	176
9.5.1	Zero Adjustment	176
9.5.2	Zero Offset Setup	177
9.6	Channel Guide Function	179
9.7	Setting the Variable Function	180
9.8	Scaling Function (SYSTEM2)	182
9.8.1	Setting the Scaling Function	183
9.8.2	Scaling Setting Example	186
9.9	Comment Function (SYSTEM 3)	187
9.9.1	Title Comment Entry	187
9.9.2	Analog/Logic Channel Comment Entry	188
9.9.3	Character Entry Procedure	189
9.10	Setting the Waveform Display Screen	191
9.10.1	Entering by CH.SET Key	191
9.10.2	Setting the Vernier Function	192
9.10.3	Direct Channel Setting	193
9.11	Setting the 8937 VOLTAGE/TEMP UNIT	194
9.11.1	Making the Settings of Voltage Measurement	194
9.11.2	Making the Settings of Temperature Measurement	196
9.12	8938 FFT ANALOG UNIT	199
9.13	Setting the 8939 STRAIN UNIT	200
9.14	8940 F/V UNIT	201
9.14.1	Frequency Measurement	202
9.14.2	Setting the Count Mode	205
9.14.3	Setting the Pulse Duty Ratio Mode	207
9.14.4	Setting the Voltage Mode	209

9.14.5	Setting the Current Measurement	211
9.15	Setting the 8947 CHARGE UNIT	212
9.15.1	Acceleration Measurement (Charge/Preamp) Selection	213
9.15.2	Setting the Sensor Sensitivity	215
9.15.3	Setting the Voltage Measurement	216

Chapter 10 Trigger Functions 217

10.1	Overview of the Trigger Functions	217
10.2	Operation Sequence (Trigger mode setting)	218
10.3	TRIGGER Screen Organization	220
10.4	Trigger Mode	221
10.5	Pre-trigger	222
10.6	Trigger Timing (REC only)	224
10.7	Trigger Source AND/OR Linking	225
10.8	Analog Trigger	226
10.8.1	Level Trigger	226
10.8.2	Window Trigger	229
10.8.3	Voltage Drop Trigger	231
10.8.4	Period Trigger	233
10.8.5	RMS Level Trigger	236
10.9	Logic Trigger	238
10.10	External Trigger Function	240
10.11	Timer Trigger Function	241
10.12	Manual Trigger	244
10.13	Trigger Output Terminal	244

Chapter 11 Waveform Display Screen Operation 245

11.1	Scrolling the Waveform	246
11.2	Using the A·B Cursors	247
11.2.1	Using the Line Cursors (Vertical)	248
11.2.2	Using the Line Cursors (Horizontal)	249
11.2.3	Using the Trace Cursors	250
11.2.4	Using the A·B Cursors (X-Y Screen)	252
11.3	Magnification/compression Ratio Along the Time Axis	253
11.4	Zoom Function (MEM only)	254
11.5	Input Level Monitor Function	255
11.6	View Function (VIEW key)	256
11.6.1	Position Display	256
11.6.2	Block Display (MEM only)	257

Chapter 12	SYSTEM Screen Settings	259
12.1	Overview	259
12.2	SET UP Screen (SYSTEM 1)	260
12.2.1	Using Channel (MEM only)	260
12.2.2	Start Backup	261
12.2.3	Backlight Saver	261
12.2.4	Display Color	262
12.2.5	Beep Sound	262
12.2.6	Display Language	263
12.2.7	Grid Type	263
12.2.8	Channel Marker	263
12.2.9	Time Value	264
12.2.10	List & Gauge	264
12.2.11	Printer Density	264
12.2.12	Upper-lower Values Print	264
12.2.13	0 Position Comment	265
12.2.14	Counter Print	265
12.2.15	Numerical Input	265
12.2.16	Variable Auto Calibration	266
12.3	SCALING Screen (SYSTEM 2)	266
12.4	COMMENT Screen (SYSTEM 3)	267
12.5	INTERFACE Screen (SYSTEM 4)	268
12.5.1	Output Destination by the COPY Key	269
12.5.2	Output Destination by the PRINT Key	269
12.5.3	Interface Settings	269
12.5.4	Setting the SCSI ID	270
12.5.5	Setting the Internal MO (when the 9607 is installed)	270
12.5.6	Setting the LAN	271
12.6	INITIALIZE Screen	278
12.6.1	Setting the Clock	278
12.6.2	Clearing the Waveform Data	278
12.6.3	System Reset	279
12.6.4	List System Configuration	279
12.7	Self-check	280
12.7.1	ROM/RAM Check	280
12.7.2	Printer Check	280
12.7.3	Display Check	281
12.7.4	Key Check	281
12.7.5	PC Card Check	281

Chapter 13	Printout of Measurement Data	283
13.1	Printout of Measurement Data Operating Procedure	284
13.2	Setting the STATUS Screen (printout)	286
13.2.1	Setting the Display Format	286
13.2.2	Setting the Print Mode	287
13.3	Setting the CHANNEL Screen (printout)	288
13.3.1	Setting the Print Density	288
13.3.2	Setting the Waveform Display Graph Position	289
13.4	Setting the SYSTEM Screen (printout)	290
13.4.1	SET UP Screen (SYSTEM 1)	290
13.4.2	SCALING Screen (SYSTEM 2)	292
13.4.3	COMMENT Screen (SYSTEM 3)	292
13.4.4	Setting the Output Destination by the COPY Key	293
13.4.5	Setting the Output Destination by the PRINT Key	294
13.5	Example of Printer Output	296
13.6	Printing Procedure	303
13.6.1	Manual Print	303
13.6.2	Auto Print	304
13.6.3	Real Time Print	305
13.6.4	Partial Print	306
13.6.5	Screen Hard Copy	307
13.6.6	List Print	307
13.6.7	Report Print	307
13.7	External Printer (color print)	308
Chapter 14	Storing Measurement Data	311
14.1	Floppy Disk	312
14.2	9607 MO UNIT (Option)	313
14.2.1	Setting the Internal MO	314
14.3	PC Card	315
14.3.1	Using the PC Card Slot (PC Card with a Cable Only)	316
14.4	SCSI Interface	317
14.4.1	SCSI Interface Specifications	317
14.4.2	Setting the MO Disk Drive	318
14.4.3	Setting the SCSI ID	319
14.5	Selecting the Media Type	320
14.6	Initializing (FORMAT)	321
14.7	Saving the Data (SAVE)	322

14.7.1	Setting the Data to Store	324
14.8	Loading the Data (LOAD)	331
14.9	File Information (INFO)	335
14.10	Deleting the Data (DELETE)	336
14.11	Sorting Files (SORT)	337
14.12	Operating the Directory	338
14.12.1	Making a Directory (MK DIR)	338
14.12.2	Changing a Directory (CH DIR)	339
14.12.3	Deleting a Directory (RM DIR)	340
14.13	Printing the File List	341
Chapter 15	Memory Segmentation Function	343
15.1	Using the Sequential Save Function	344
15.2	Using the Multi-Block Function (MEM)	349
Chapter 16	Waveform Operation Function	353
16.1	Waveform Parameter Calculation (MEM)	353
16.1.1	Making Settings for Waveform Parameter Calculation	355
16.1.2	Making Settings for Waveform Parameter Evaluation	357
16.1.3	Setting the Waveform Parameter GO/NG Stop Mode	358
16.1.4	Executing Waveform Parameter Calculation	359
16.2	Calculating Waveform Data	361
16.2.1	Preparing for Waveform Processing	362
16.2.2	Defining the Processing Equation	363
16.2.3	Copying an Equation	366
16.2.4	Setting the Channel for Recording Processing Results	367
16.2.5	Setting the Display Scale and Number of Moved Points	368
16.2.6	Perform Waveform Processing	370
16.3	Waveform GO/NG Evaluation (MEM, FFT)	372
16.3.1	Setting the Waveform Area	374
16.3.2	Setting the Waveform Evaluation Mode	375
16.3.3	Setting the GO/NG Stop Mode	375
16.3.4	Creating the Evaluation Area	376
16.3.5	Editor Command Details	376

Chapter 17 External Input/ Output Terminals/ Key Lock Function	379
17.1 External Input/Output Terminals	379
17.1.1 Connecting the Terminals	379
17.1.2 External Trigger Input Terminal [EXT TRIG]	380
17.1.3 Trigger Output Terminal [TRIG OUT]	380
17.1.4 External Sampling Terminal [EXT SMPL]	381
17.1.5 External Print Terminal / External Start/Stop Terminal	381
17.1.6 GO/NG Evaluation Output Terminal	382
17.2 Using the Key Lock Function	383
 Chapter 18 Specifications	 385
18.1 General Specifications	385
18.2 External Data Storage and Interface	387
18.3 Trigger Unit	389
18.4 Memory Recorder Function	390
18.5 Recorder Function	391
18.6 RMS Recorder Function	392
18.7 Recorder & Memory Function	393
18.8 FFT Function	394
18.9 Auxiliary Functions	395
18.10 Others	396
18.11 System Operation	397
18.12 Maximum Recording Length for Time Axis Settings	398
18.13 Memory Capacity and Recording Length	400
 Chapter 19 Logic and Analog Inputs	 401
19.1 Logic Inputs	401
19.2 Analog Inputs	403
19.2.1 8936 ANALOG UNIT	403
19.2.2 8937 VOLTAGE / TEMP UNIT	404
19.2.3 8938 FFT ANALOG UNIT	406
19.2.4 8939 STRAIN UNIT	407
19.2.5 8946 4ch ANALOG UNIT	408
19.2.6 8940 F/V UNIT	409
19.2.7 8947 CHARGE UNIT	411

Chapter 20 Maintenance and Service	415
20.1 Maintenance and Inspection	415
20.2 Replacing the Input Units	417
20.3 Replacing the Fuse of the 9433	418
20.4 Removing the Battery Before Discarding the Unit	419
20.5 Troubleshooting	420

Appendix **APPENDIX 1**

Appendix 1 Error Messages	APPENDIX 1
Appendix 2 Glossary	APPENDIX 6
Appendix 3 Reference	APPENDIX 8
Appendix 3.1 Sampling	APPENDIX 8
Appendix 3.2 Aliasing	APPENDIX 8
Appendix 3.3 Measurement Limit Frequency	APPENDIX 9
Appendix 3.4 Recorder Function	APPENDIX 10
Appendix 3.5 RMS Recorder Function	APPENDIX 11
Appendix 3.6 Averaging Equations	APPENDIX 12
Appendix 3.7 "2-point method" Scaling Equation	APPENDIX 12
Appendix 3.8 Waveform Parameter Calculation Details	APPENDIX 13
Appendix 3.9 Details on Operators	APPENDIX 16
Appendix 3.10 FFT Function	APPENDIX 19
Appendix 4 Size of a Waveform File (Binary data)	APPENDIX 26
Appendix 5 Size of a Waveform File (Reference value of text data)	APPENDIX 28
Appendix 6 FFT File Size	APPENDIX 30
Appendix 7 Real-Time Save Files Size (Memory data)	APPENDIX 31
Appendix 8 Waveform Viewer (Wv)	APPENDIX 32
Appendix 8.1 Starting the Waveform Viewer	APPENDIX 33
Appendix 8.2 Waveform Viewer Menus	APPENDIX 34
Appendix 8.3 Using the Waveform Viewer	APPENDIX 36
Appendix 8.4 Conversion to CSV Format	APPENDIX 39
Appendix 8.5 Batch Conversion	APPENDIX 40

Index **INDEX 1**

Introduction

Thank you for purchasing the HIOKI "8841/42 MEMORY HiCORDER."
To obtain maximum performance from the product, please read this manual first, and keep it handy for future reference.

Inspection

When the unit is delivered, check and make sure that it has not been damaged in transit. In particular, check the accessories, panel switches, and connectors. If the unit is damaged, or fails to operate according to the specifications, contact your dealer or HIOKI representative.

Accessories

Power cord	1	9231 RECORDING PAPER	1
Protective cover	1	Roll paper attachment	2
PC card protector	1	Connector cable label	1
Instruction Manual	1	Application Disk (CD-R)	1

Options

Input units

8936	ANALOG UNIT
8937	VOLTAGE/TEMP UNIT
8938	FFT ANALOG UNIT
8939	STRAIN UNIT
8940	F/V UNIT
*18946	4 ch ANALOG UNIT
8947	CHARGE UNIT

Cards

9557	RS-232C CARD
9558	GP-IB CARD
9559	PRINTER CARD
9578	10BASE-T LAN CARD
9607	MO UNIT (with eject pin)
9608	MEMORY BOARD (24M-WORD) total 32 M words
9626	PC CARD 32M
9627	PC CARD 64M
9726	PC CARD 128M
9727	PC CARD 256M
9728	PC CARD 512M
9729	PC CARD 1G

Cables and adapter

9433	DC POWER ADAPTER
9197	CONNECTION CORD (for high voltage, maximum input voltage 500 V)
9198	CONNECTION CORD (for low voltage, maximum input voltage 300 V)
9199	CONVERSION ADAPTOR
9217	CONNECTION CORD (isolated between BNC and BNC)
9320	LOGIC PROBE (maximum input voltage 50 V)
9321	LOGIC PROBE (maximum input voltage 250 V)
9322	DIFFERENTIAL PROBE

9324 POWER CORD (for logic connector)
9325 POWER CORD (for 8940 F/V UNIT sensor connector)
9665 10:1PROBE
9666 100:1PROBE
*29303 PT
9318 CONVERSION CABLE (for 9270-72, 9277-79)
9319 CONVERSION CABLE (for 3273)

Clamps

3273 CLAMP ON PROBE (DC to 50 MHz)
9018-10 CLAMP ON PROBE (10 to 500 A, 40 Hz to 3 kHz)
*29132-10 CLAMP ON PROBE (20 to 1000 A, 40 Hz to 1 kHz)
*29270 CLAMP ON SENSOR (20 A, 5 Hz to 50 kHz)
*29271 CLAMP ON SENSOR (200 A, 5 Hz to 50 kHz)
*29272 CLAMP ON SENSOR (20/200 A, 5 Hz to 10 kHz)
9277 UNIVERSAL CLAMP ON CT (20 A, DC to 100 kHz)
9278 UNIVERSAL CLAMP ON CT (200 A, DC to 100 kHz)
*29279 UNIVERSAL CLAMP ON CT (500 A, DC to 20 kHz)
*29555 SENSOR UNIT (used with the 9270 to 9272, and the 9277 to 9279)

Others

8910 CAN ADAPTER
9333 LAN COMMUNICATOR
9335 WAVE PROCESSOR
9397-01 CARRYING CASE (for 8841)
9349 CARRYING CASE (for 8842)
9231 RECORDING PAPER (6 rolls)
*2220H PAPER WINDER

*1: Only used with 8841/ *2: no CE marking

NOTE

The 9270 to 9272 CLAMP ON SENSORs and 9277 to 9279 UNIVERSAL CLAMP ON CTs are designed for use only with the 9555 SENSOR UNIT, and cannot be used alone.







Safety Notes

This manual contains information and warnings essential for safe operation of the product and for maintaining it in safe operating condition. Before using the product, be sure to carefully read the following safety notes.

⚠ DANGER

This product is designed to conform to IEC 61010 Safety Standards, and has been thoroughly tested for safety prior to shipment. However, mishandling during use could result in injury or death, as well as damage to the product. Be certain that you understand the instructions and precautions in the manual before use. We disclaim any responsibility for accidents or injuries not resulting directly from product defects.

Safety symbols

	<ul style="list-style-type: none"> • In the manual, the ⚠ symbol indicates particularly important information that the user should read before using the product. • The ⚠ symbol printed on the product indicates that the user should refer to a corresponding topic in the manual (marked with the ⚠ symbol) before using the relevant function.
	Indicates a grounding terminal.
	Indicates AC (Alternating Current).
	Indicates DC (Direct Current).
	Indicates both DC (Direct Current) and AC (Alternating Current).
	Indicates the ON side of the power switch.
	Indicates the OFF side of the power switch.

The following symbols are used in this Instruction Manual to indicate the relative importance of cautions and warnings.

⚠ DANGER	Indicates that incorrect operation presents extreme danger of accident resulting in death or serious injury to the user.
⚠ WARNING	Indicates that incorrect operation presents significant danger of accident resulting in death or serious injury to the user.
⚠ CAUTION	Indicates that incorrect operation presents possibility of injury to the user or damage to the equipment.
NOTE	Denotes items of advice related to performance of the equipment or to its correct operation.

Measurement categories (Overvoltage categories)

This instrument conforms to the safety requirements for CAT II (370 V) measurement products (using with the 8936 ANALOG UNIT).

To ensure safe operation of measurement instruments, IEC 61010 establishes safety standards for various electrical environments, categorized as CAT I to CAT IV, and called measurement categories. These are defined as follows.

CAT	Secondary electrical circuits that are connected to a wall outlet through a transformer or similar device.
CAT	Primary electrical circuits in equipment connected to a wall outlet via a power cord (portable tools, household appliances, etc.)
CAT	Primary electrical circuits of heavy equipment (fixed installations) connected directly to the distribution panel, and feeders between the distribution panel and outlets.
CAT	The circuit from the service drop to the service entrance, then to the power meter and to the primary overcurrent protection device.

Higher-numbered categories correspond to electrical environments with greater momentary energy. So a measurement device designed for CAT III environments can endure greater momentary energy than a device designed for CAT II. Using a measurement instrument in an environment designated with a higher-numbered category than that for which the instrument is rated could result in a severe accident, and must be carefully avoided.

Never use a CAT I measuring instrument in CAT II, III, or IV environments.

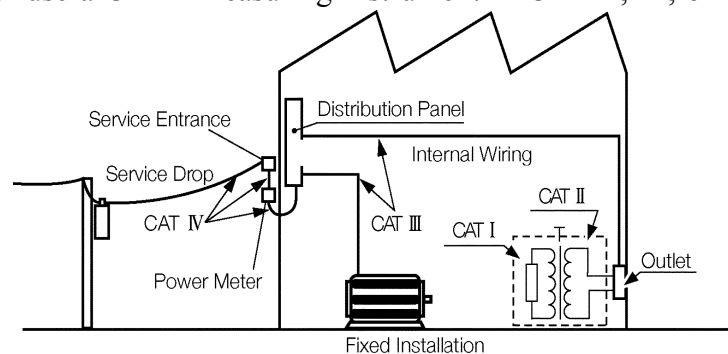

The measurement categories comply with the Overvoltage Categories of the IEC60664 Standards.

Notes on Use



In order to ensure safe operation and to obtain maximum performance from the unit, observe the cautions listed below.

Inspection before Use

Before using the product the first time, verify that it operates normally to ensure that no damage occurred during storage or shipping. If you find any damage, contact your dealer or Hioki representative.

⚠ DANGER

Power Supply Connections

Before connecting the unit, make sure that the power supply voltage matches the rated power supply voltage of the unit.

Probe Connection, Measurement Voltage Input

- **Maximum input voltage ratings for the input unit and the input terminals of the unit are shown below. To avoid the risk of electric shock and damage to the unit, take care not to exceed these ratings.**
- **The maximum rated voltage to earth of the input unit (voltage between input terminals and main unit frame ground, and between inputs of other analog units) is shown below. To avoid the risk of electric shock and damage to the unit, take care that voltage between channels and between a channel and ground does not exceed these ratings.**
- **The maximum rated voltage to earth rating applies also if an input attenuator or similar is used. Ensure that voltage does not exceed these ratings.**
- **When measuring power line voltages with the 8936 or 8938, always connect the probe to the secondary side of the circuit breaker. Connection to the primary side involves the risk of electric shock and damage to the unit.**
- **Always use the supplied connector cables. Any exposed metal sections in a connector cable consist a risk of electric shock.**
- **The logic units all have and the unit have a common ground.**
- **The external I/O terminal and the unit have a common GND.**

Input/output terminal	Maximum input voltage	Maximum rated voltage to earth
8936 (input)	400 VDC max.	370 VAC/DC
8937 (input)	30 Vrms or 60 VDC	30 Vrms or 60 VDC
8938 (input)	400 VDC max.	370 VAC/DC
8939 (input)	10 VDC max.	30 Vrms or 60 VDC
8940 (input)	30 Vrms or 60 VDC (BNC/sensor connector terminal)	30 Vrms or 60 VDC (BNC terminal) Not insulated (Sensor connector terminal)
8946 (input)	30 Vrms or 60 VDC	30 Vrms or 60 VDC
8947 (input) *1	30 Vrms or 60 VDC (BNC terminal)	30 Vrms or 60 VDC (BNC terminal)

*1: The maximum allowable charge that can be applied to the miniature connection terminals is 500 pC at the most sensitive of the six ranges, and 50,000 pC at the least sensitive range.

Input/output terminal	Maximum input voltage	Maximum rated voltage to earth
9322	2000 VDC, 1000 VAC (CAT II) 600 VAC/DC (CAT III)	When using grabber clips 1500 VAC/DC (CAT II), 600 VAC/DC (CAT III) When using alligator clips 1000 VAC/DC (CAT II), 600 VAC/DC (CAT III)
EXT TRIG/ START · STOP/ PRINT/ EXT SMPL	-5 to +10 VDC	Not insulated
TRIG OUT/ GO/ NG	-20 V to +30 VDC 500 mA max./ 200 mW max.	



Logic Probe Connection

- The logic input and 8841/42 Unit share a common ground. Therefore, if power is supplied to the measurement object of the logic probe and to the 8841/42 from different sources, an electric shock or damage to the equipment may result. Even if power is supplied from the same system, if the wiring is such that a potential difference is present between the grounds, current will flow through the logic probe so that the measurement object and 8841/42 could be damaged. We therefore recommend the following connection method to avoid this kind of result. Refer to Section 2.5, "Logic Probe Connection" for details.
- (1) Before connecting the logic probe to the measurement object, be sure that power is supplied from the same outlet box to the measurement object and the 8841/42 using the supplied power cord.
 - (2) Before connecting the logic probe to the measurement object, connect the ground of the measurement object to the 8841/42 ground terminal. Also in this case, power should be supplied from the same source. Refer to Section 2.2, "Power Supply and Ground Connections" for grounding terminal details.

Replacing the Input Units

- In order to avoid accidents from electric shock, before removing or replacing an input unit, check that the connector cables and thermocouple are disconnected, turn off the power, and remove the power cable.
- Normally keep all input units installed permanently. If a unit is not fitted, it must be replaced by a blanking panel. If the unit is operated with an input unit not in place it poses a shock hazard.

Differential Probe Connection

- When using grabber clips, the 9322's maximum rated voltage to earth is 1500 VAC/DC; when using alligator clips, it is 1000 VAC/DC. To avoid electrical shock and possible damage to the unit, never apply voltages greater than these limits between the input channel terminals and chassis, or across the inputs of two 9322s.
- Maximum input voltage is 1000 VAC/2000 VDC. Do not measure voltage in excess of these limitations, as doing so may damage the unit or cause an accident that might result in injury or death.

⚠ WARNING**Installation Environment**

To avoid electric shock, do not allow the product to get wet, and do not use it when your hands are wet.

Grounding the Unit

The unit is constructed so as to be connected to a ground line via a three-core power cord that is supplied with the unit. In order to avoid electric shock, connect the unit to a properly grounded (3-pin) outlet using the power cord provided.

Before Powering on

Check that the power supply is correct for the rating of the unit. (The AC fuse is integrated in the unit.)

Usage Precautions for the Internal MO Drive (option)

Please do not attempt to disassemble the MO drive.

Laser radiation can be emitted when the MO drive is open. Avoid looking directly into the laser when the MO drive is open. Maximum laser output is 50 mW (at 685 nm, pulsed).

A laser warning label is attached to the bottom of the 8841/42 Unit. Refer to Section 1.2, "Identification of Controls and Indicators" for the label location.

CLASS1 LASER PRODUCT
BASED ON EN60825/IEC 60825

⚠ CAUTION**Installation Environment**

- This product should be installed and operated indoors only, between 5°C to 40°C and 35% to 80%RH.
- This product is not designed to be entirely water- or dust-proof. To avoid damage, do not use it in a wet or dusty environment.
- Do not store or use the product where it could be exposed to direct sunlight, high temperature or humidity, or condensation. Under such conditions, the product may be damaged and insulation may deteriorate so that it no longer meets specifications.

Using a printer

Using the printer in a high-temperature or high-humidity environment should be avoided at all costs. This can seriously reduce the printer life.

Using the connecting cables

Use only the specified connection cable. Using a non-specified cable may result in incorrect measurements due to poor connection or other reasons.

Recording paper

- This unit uses a thermal printer. The recording paper supplied has characteristics finely tuned for use with the printer. Using recording paper of a different specification may not only result in impaired printing quality, but even prevent the printer from operating. Always use the HIOKI specified product.
- Printing is not possible if the recording paper is loaded wrong-side up. (Refer to Section 2.8, "Loading Recording Paper.")

CAUTION**Storing**

When the unit is not to be used for an extended period, set the head up/down lever to the "head up" position. This will protect the printer head and prevent deformation of the rubber roller.

Precautions on carrying this equipment

The terminal guard of the equipment protects the inputs. Do not hold this guard when carrying the equipment. To carry this equipment, use the handle. See Section 1.2.

Shipping

- Remove the printer paper from the unit. If the paper is left in the unit, paper support parts may be damaged due to vibrations.
- Remove the PC card, floppy disk, MO disk and SCSI cable from the unit.
- If reshipping the unit, preferable use the original packing.
- Do not transport using the 9397-01 or 9349 CARRYING CASEs.

Others

- In the event of problems with operation, first refer to Section 20.5, "Troubleshooting".
- Carefully read and observe all precautions in this manual.

Handling the CD-R

- Always hold the disc by the edges, so as not to make fingerprints on the disc or scratch the printing.
- Never touch the recorded side of the disc. Do not place the disc directly on anything hard.
- Do not wet the disc with volatile alcohol or water, as there is a possibility of the label printing disappearing.
- To write on the disc label surface, use a spirit-based felt pen. Do not use a ball-point pen or hard-tipped pen, because there is a danger of scratching the surface and corrupting the data. Do not use adhesive labels.
- Do not expose the disc directly to the sun's rays, or keep it in conditions of high temperature or humidity, as there is a danger of warping, with consequent loss of data.
- To remove dirt, dust, or fingerprints from the disc, wipe with a dry cloth, or use a CD cleaner. Always wipe radially from the inside to the outside, and do no wipe with circular movements. Never use abrasives or solvent cleaners.
- Hioki shall not be held liable for any problems with a computer system that arises from the use of this CD-R, or for any problem related to the purchase of a Hioki product.

Chapter Summary

- Chapter 1 Product Overview**
Contains an overview of the unit and its features.
- Chapter 2 Installation and Preparation**
Explains how to set the unit up for measurement.
- Chapter 3 Basic Key Operation**
Explains how to operate the keys and the Jog/Shuttle control for carrying out basic measurement functions.
- Chapter 4 Memory Recorder Function**
Explains how to use the memory recorder functions of the unit.
- Chapter 5 Recorder Function**
Explains how to use the recorder functions of the unit.
- Chapter 6 RMS Recorder Function**
Explains how to use the RMS recorder functions of the unit.
- Chapter 7 Recorder and Memory Recorder Function**
Explains how to use the recorder and memory recorder functions of the unit.
- Chapter 8 FFT Function**
Explains how to use the FFT functions of the unit.
- Chapter 9 Input Channel Settings**
Explains how to make settings using the channel setting screen.
- Chapter 10 Trigger Functions**
Explains how to use the trigger functions of the unit.
- Chapter 11 Waveform Display Screen Operation**
Explains how to perform waveform scrolling, how to use the A•B cursors and so.
- Chapter 12 SYSTEM Screen Settings**
Explains how to make settings using the system setting screen.
- Chapter 13 Printout of Measurement Data**
Explains how to print out measurement data and how to read printed charts.
- Chapter 14 Storing Measurement Data**
Explains how to store, recall, and delete measurement data and measurement settings.
- Chapter 15 Memory Segmentation Function**
Explains how to use the Memory Segmentation Function.

- Chapter 16** **Waveform Operation Function**
Explains how to use the Calculating, Waveform Parameters/Evaluating Parameter value and Waveform GO/NG Evaluation.
- Chapter 17** **External Input/ Output Terminals/ Key Lock Function**
Gives specifications and usage details of the external input/output terminals, and explains how to use the key lock function.
- Chapter 18** **Specifications**
Contains general specifications and detailed function specifications.
- Chapter 19** **Logic and Analog Inputs**
Contains specifications and precautions for logic input section and input amplifier units.
- Chapter 20** **Maintenance and Service**
Describes maintenance procedures.
- Appendix** Contains information that is necessary for using this unit, including a description of error messages, a glossary, and an explanation how to increase memory.

Chapter 1

Product Overview

1.1 Major Features

(1) Waveform recording performance

For the 8841, using the 8946 4ch ANALOG UNIT, waveform recording can be performed in up to 16 channels with 12-bit resolution (8841).

With the 8842, waveform recording can be performed for up to 16 channels at 12-bit resolution, for any combination of input units.

(2) Vertical display

The 10.4-inch vertically-mounted TFT color LCD display has a resolution of 640 × 480 dots.

(3) Five functions

- Memory recorder with up to 1 μs (all channels simultaneously) sampling period.
- Real-time recording capability to paper in recorder function
- RMS recorder function for recording rms values of AC power supply lines and DC sources.
- Recorder & Memory Recorder function provides combined recorder and memory recorder functions
- FFT function offers 12 types of analysis functions

(4) Storage capacity

The 8841/8842 has a standard storage capacity of 8 M words, expandable to 32 M words with memory upgrades.

(5) Trigger function

- Digital trigger circuit
- Trigger types: level trigger, window-in trigger, window-out trigger, voltage drop trigger, RMS level trigger, period trigger, logic trigger (pattern trigger)

(6) Simple function key interface (GUI)

Thanks to its GUI-inspired design using large function key graphics, the unit is easy to set up and operate.

(7) On-line help

On-line help guides the user through operation steps and various functions.

(8) Scaling function

By setting the physical amount and the unit to be used for 1 V input, the measurement result can be converted into any desired scale.

(9) Additional recording function

When enabled, the memory is regarded as printer paper.

(10) Input units

The analog inputs are floating, and so each input can be connected to its own independent potentials.

Select input units suitable for measurements.

(11) Built-in thermal printer

- Thermosensitive recording method using a thermal line head
The built-in printer delivers waveform printouts on the spot.
- The printer can also be used to print screen shots and parameter information.
Report print (A4 size) can be printed.

(12) External storage means

The waveform data and/or setup conditions can be stored on a floppy disk, MO disk, or PC card (SRAM, flash ATA, or HDD card).

(13) SCSI interfaces

If a MO drive is connected to the SCSI interface, the waveform data and/or setup conditions can be stored on a MO disk.

(14) GP-IB, RS-232C, and LAN (10BASE-T) interface

Remote control including input unit is possible.

(15) External print

If a color printer is connected to the printer card, the data can be printed in color.

(16) Dual-language capability

Display language is switchable between Japanese and English.

1.2 Identification of Controls and Indicators

(example: 8841)

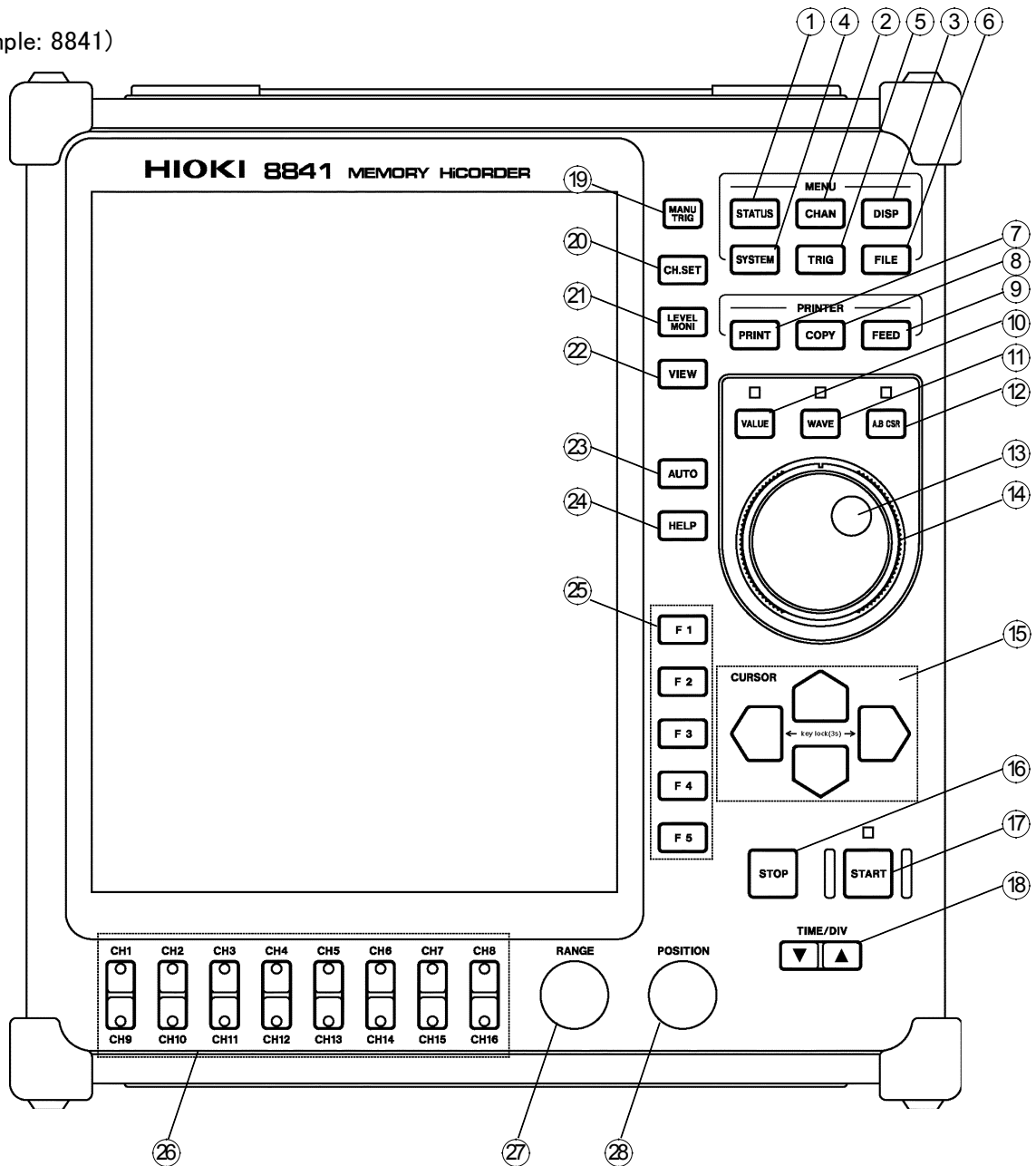

Front Panel

- ① **STATUS** key Causes the display to show the STATUS screen which serves for setting most measurement parameters.
- ② **CHAN** key Causes the display to show the CHANNEL or Variable screen which serves for making input channel settings.
- ③ **DISP** key Causes the display to show measurement and analysis results.
- ④ **SYSTEM** key Causes the display to show the SYSTEM screen which serves for making system-wide settings such as for the scaling function.
- ⑤ **TRIG** key Causes the display to show the TRIGGER screen. Setting the trigger functions.

-
- | | | |
|---|-------------------------------------|--|
| ⑥ | FILE key | Causes the display to show the FILE screen which serves for reading, storing, etc. the waveform data etc. |
| ⑦ | PRINT key | Serves to print out stored waveforms.
Output destination can be set on the SYSTEM4 screen. |
| ⑧ | COPY key | Serves to print out a hard copy of the current screen display.
Copy destination can be set on the SYSTEM4 screen |
| ⑨ | FEED key | Causes the printer paper to advance for as long as the key is pressed. |
| ⑩ | VALUE key | Uses to select the numerical values setting. |
| ⑪ | WAVE key | Uses to select the the waveform scrolling. |
| ⑫ | A•B CSR key | Uses to select the the A•B cursor moving. |
| ⑬ | Jog | Rotary control knob that serves to change values, move the A•B cursors, and scroll the waveform. |
| ⑭ | Shuttle | Concentric ring that serves to change values, move the A•B cursors, and to scroll the waveform. The speed of movement is proportional to the rotation angle. |
| ⑮ | CURSOR key | These keys serve to move the flashing cursor in the four directions. |
| ⑯ | STOP key | Stops measurement and analysis.
Pressing this key twice stops measurement. |
| ⑰ | START key | Initiates the measurement and analysis. During measurement, the LED above the key is lit. |
| ⑱ | TIME/DIV key | Serves to set the speed for inputting and storing the input signal. |
| ⑲ | MANU TRIG key | Serves to cause manual triggering. |
| ⑳ | CH.SET key | Sets the input channel on the display screen
Toggles the screen among those for analog channels (1 to 16) and logic channels (A to D). |
| ㉑ | LEVEL MONI key | Serves to check the input signal level. |
| ㉒ | VIEW key | Serves to indicate the position of the currently displayed screen information in relation to the entire recording length.

Call up information about the status of memory block. |
| ㉓ | AUTO key | Pressing this key activates automatic setting of time axis range and voltage range values of input waveform. |
| ㉔ | HELP key | Provides on-line help. |
| ㉕ | F1 to F5 key | Serve to select setting items. |
| ㉖ | Channel select/
input value keys | Selects channel or sets numerical value |
| ㉗ | RANGE knob | Sets the measurement range for the channel. |
| ㉘ | POSITION knob | Sets the zero position for the channel. |

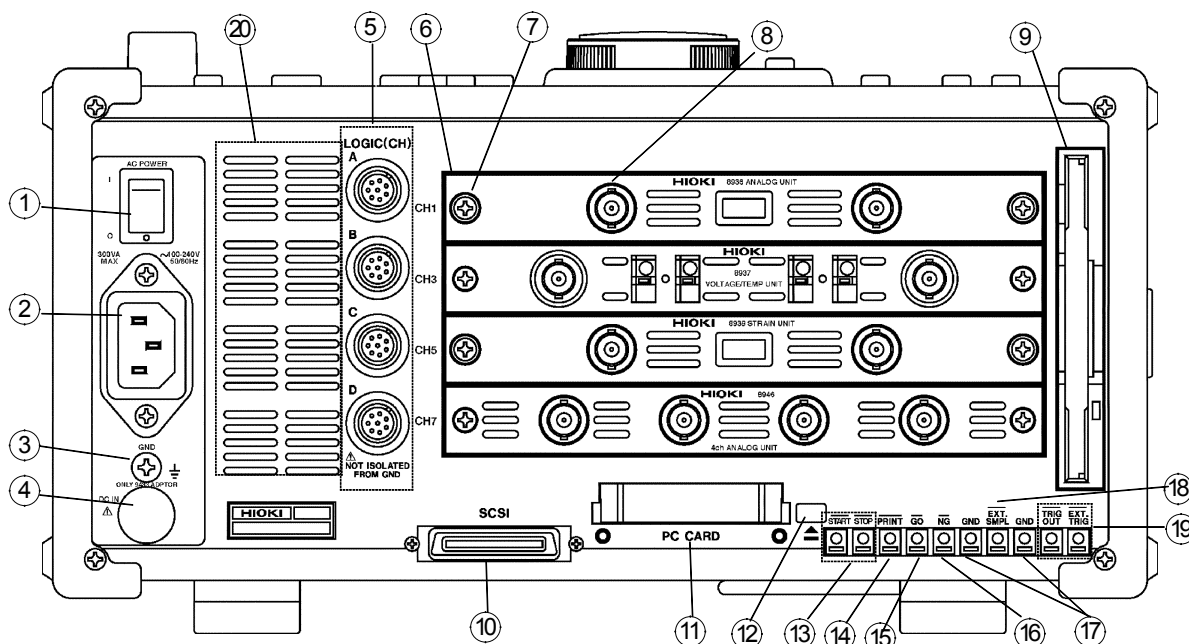

Right Side Panel

- | | |
|----------------------------------|--|
| ① AC power switch | Switches on or off the AC power supply. |
| ② AC connector | The supplied power cord must be plugged in here. |
| ③ Function ground terminal (GND) | Connects to the earth. |
| ④ DC connector | Connects to the optional 9433 DC POWER ADAPTER. |
| ⑤ Logic probe connectors | Input connector for the logic input section, designed for the dedicate logic probes (CH A to D). |
| ⑥ Input unit slots | These slots accept input units. |
| ⑦ Fastening screw | Secures the plug-in unit. |
| ⑧ Analog input connector | Unbalanced analog input. (on ANALOG UNIT) |
| ⑨ FD slot | Floppy disk is inserted. |
| ⑩ SCSI connector | An MO drive can be connected. |
| ⑪ PC card slot | Inserts the PC card. |
| ⑫ Eject button | Removes the PC card. |
| ⑬ External start/stop terminals | Start and stop operation can be controlled. |
| ⑭ External print terminal | Print operation can be controlled. |
| ⑮ GO evaluation output terminal | When the waveform evaluation has resulted in GO, a signal is output from this terminal. |
| ⑯ NG evaluation output terminal | When the waveform evaluation has resulted in NG, a signal is output from this terminal. |
| ⑰ Ground terminal (GND) | Uses with to (except) terminals. |
| ⑱ External sampling terminal | Allows input of an external sampling signal. (in Memory recorder and FFT functions) |
| ⑲ Trigger terminals | Can be used to synchronize multiple units, using the EXT TRIG input and TRIG OUT output. |
| ⑳ Blowing slot | |

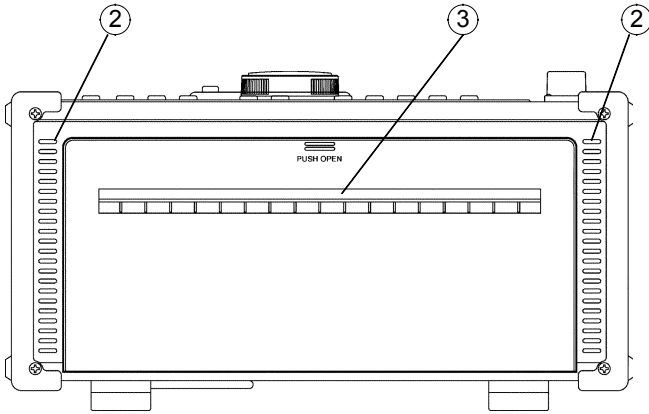

Left Side Panel

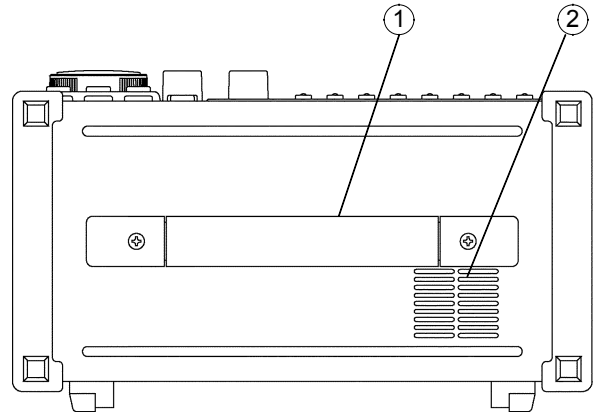

Upper Panel

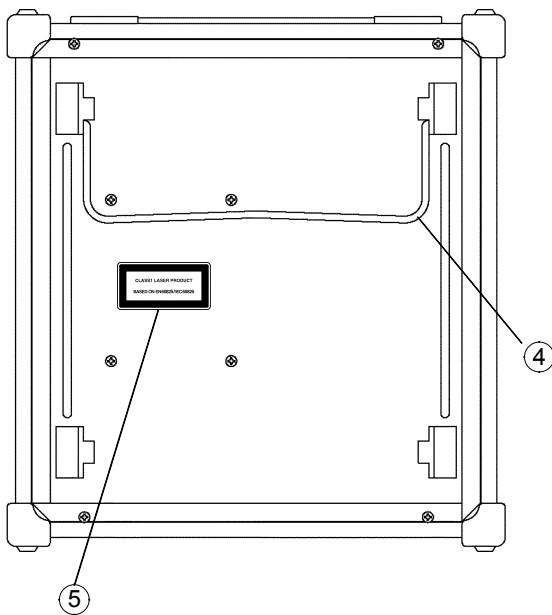

Rear Panel

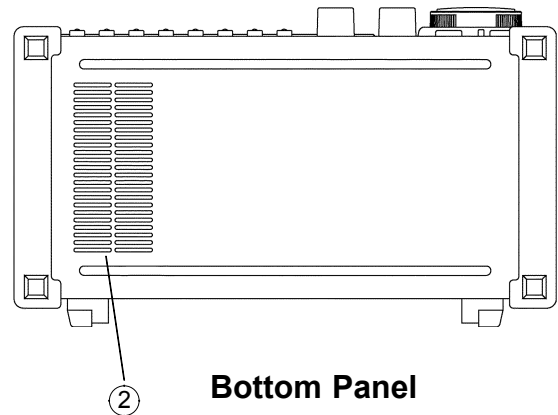

Bottom Panel

- ① Handle Serves for transporting the 8841/42.
- ② Ventilation slots
- ③ Printer
- ④ Stand The unit can also be propped up at an angle using the stand.
- ⑤ Laser warning label (when the 9607 MO UNIT is installed)

Chapter 2

Installation and Preparation

2

2.1 Installation of the Unit

Installation orientation

Install the unit on a flat, level surface.

The unit can also be propped up at an angle, using the stand.

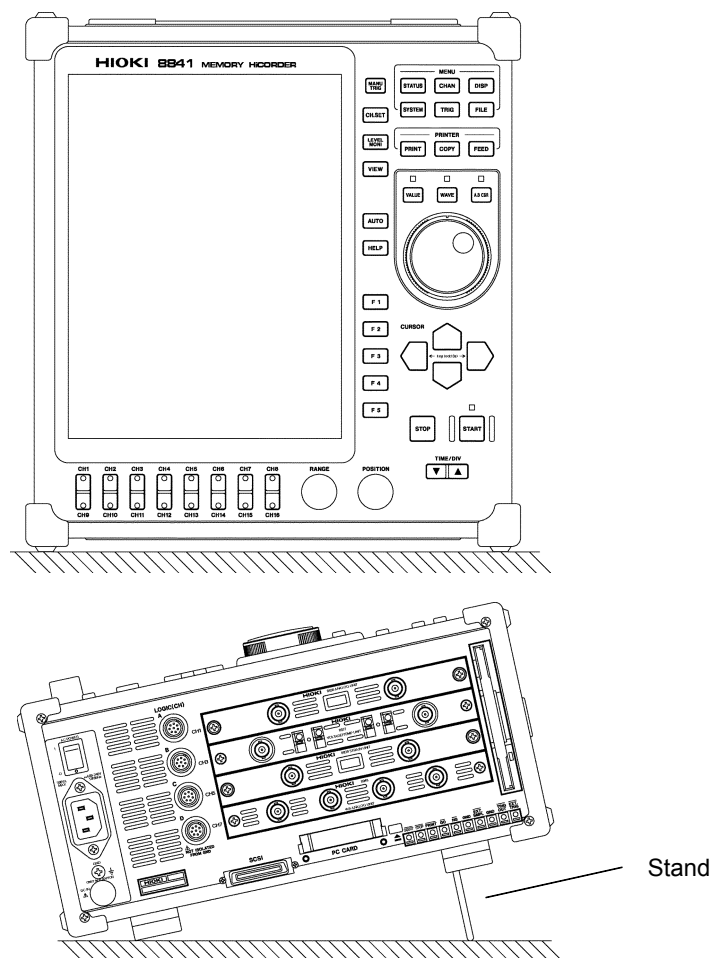

NOTE

When the MO drive is used, do not use the stand to prop up the unit.

Ambient conditions

Temperature	5 to 40°C, 23 ± 5°C recommended for high-precision measurements.
Humidity	35 to 80%RH (no condensation); 50 ± 10%RH (no condensation) recommended for high-precision measurements.
Ventilation	Take care not to block the ventilation openings and assure proper ventilation. When using the unit in an upright position, take care not to block the openings on both side.

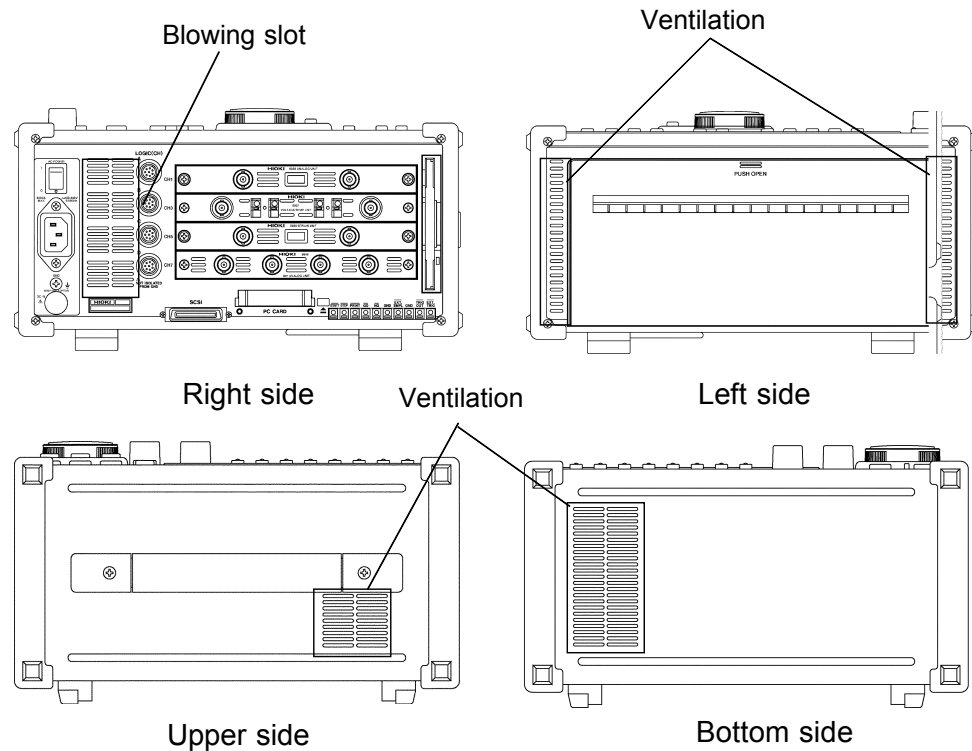

Avoid the following locations:

- Subject to direct sunlight.
- Subject to high levels of dust, steam, or corrosive gases (Avoid using the equipment in an environment containing corrosive gases (e.g., H₂S, SO₂, NI₂, and Cl₂) or substances that generate harmful gasses (e.g., organic silicones, cyanides, and formalins).
- Subject to vibrations.
- In the vicinity of equipment generating strong electromagnetic fields.

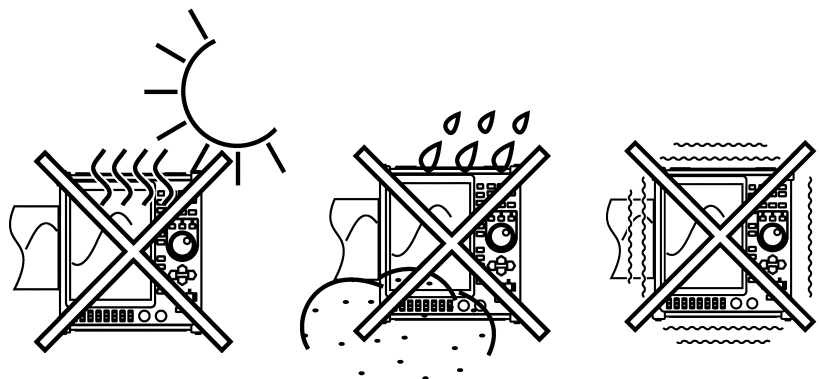

2.2 Power Supply and Ground Connections

2.2.1 Connecting the AC Power Supply

⚠ WARNING

- Check the following points before connecting the unit to a power supply. Take care never to exceed the power supply ratings given below, to avoid the risk of electric shock and damage to the unit.

Power supply matches Rated supply voltage (100 to 240 VAC: Voltage fluctuations of $\pm 10\%$ from the rated supply voltage are taken into account.) and rated supply frequency (50/60 Hz).

The AC power switch of the 8841/42 is set to OFF.

Use only the supplied AC power cord.

- When supplying power with an inverter or an uninterruptible power supply (UPS), use a device that complies with the following conditions. To avoid the risk of electric shock and damage to the unit, do not use devices that have a voltage frequency outside the specified range, or that output square waves.

Voltage: AC100 V to 240 V

Power frequency: 50/60 Hz

Sine wave output (Do not use devices that have an unstable output, even if the output is sinusoidal.)

- To avoid electric shock and ensure safe operation, connect the power cable to a grounded (3-contact) outlet.

1. Verify that the AC power switch of the 8841/42 is set to OFF.
2. Plug the grounded three-core power cord supplied into the AC power connector on the right side of the 8841/42.
3. Plug the power cord into an AC outlet corresponding to the rating of the 8841/42.

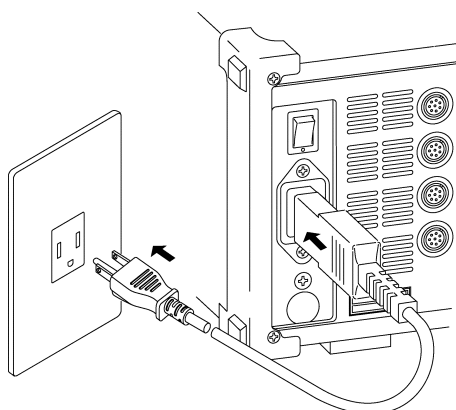

NOTE

The fuse is incorporated in power supply. It is not user-replaceable. If a problem is found, contact your nearest dealer.

2.2.2 Connecting the 9433 DC POWER ADAPTER



DANGER

Before making connections, make sure that the 9433 DC POWER ADAPTER switch is turned off. If the 8841/8842 is connected to a device such as a battery while the switch is in the on position, a spark may be given off, damaging the 8841/8842.

WARNING

- The rated supply voltage of the 9433 is 10 to 28 VDC (Voltage fluctuations of $\pm 10\%$ from the rated supply voltage are taken into account.).
- The 9433 DC POWER ADAPTER generates heat. To provide adequate heat dissipation, avoid placing objects on top of the 8841/8842 or mounting it in confined spaces.
- When connecting the 9433, take care not to mix up the red (+) and black (-) lead. If polarity is reversed, the 9433 may be damaged.
- When wishing to extend DC cable, use a cable of identical or better rating as the cable of the input side.
- The 9433 is made for use specifically with the 8841/8842 MEMORY HiCORDER. Do not use with any other equipment.

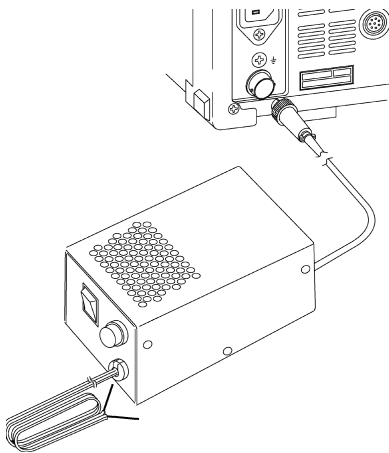

1. Verify that the 9433 switch is set to OFF.
2. Align the ridge of the connector on the unit with the groove in the plug and insert the plug fully, and rotate the plug of the connector to lock.
3. Connect the red input cable to the positive side (+) and the black cable to the negative side (-).
4. To remove the cable, rotate it.

NOTE

- This unit is not equipped to charge an external battery.
- When using a battery, take care not to deplete it completely.
- When the 8841/8842 detects an overcurrent or overvoltage on the output, it will shut down. To turn power back on, turn off 9433 DC POWER ADAPTER switch, wait approximately one minute, then turn on the switch.
- If both the AC power supply and 9433 are connected to the 8841/8842, the AC power supply has priority. However, even when the 8841/8842 runs off the AC power supply, the 9433 remains in standby mode and consumes some power. Keep this in mind when connecting the 9433 to the battery while the 8841/8842 is connected to an AC power source.
- Input cord rating: 37 A (allowable current)
- Failure of the 9433 to power on may indicate a blown fuse.
- For replacing the fuse, see Section 20.3.

Estimated battery operation hours (at room temperature)

Battery type: 12 V, 38 Ah, fully charged

Operation condition \ Units	8841		8842
	8936 installed	8946 installed	8936 installed
Printer not used (trigger waiting)	Approx. 9 h	Approx. 7 h 30 min	Approx. 7 h
Printer used (recorder function 500 ms/DIV, all store)	Approx. 2 h 50 min	Approx. 2 h 40 min	Approx. 2 h 40 min

Actual running time may differ, depending on battery age, charge condition, ambient temperature, and other factors.

If the 9433 is connected to the 8841/8842, and the adapter switch is turned on, even when the 8841/8842 runs off the AC power supply, the 9433 remains in standby mode and consumes some power. In this case, the battery operation time is 95 hours.

Specification of the 9433 DC POWER ADAPTER

Accuracy at 23°C ± 5°C, 35% to 80%RH, after 30-minutes warming-up time.

Input voltage range	10 to 28 VDC
Rated output voltage	24 VDC
Output voltage accuracy	24 VDC ± 2%
Rated output current	7 A
Efficiency	70% or more (12 VDC input, rated output)
Maximum rated power	250 VA
Temperature and humidity range for use	0°C to 40°C (32°F to 104°F), 35% to 85%RH (with no condensation)
Temperature and humidity range for storing	-20°C to 60°C (-4°F to 140°F) 10% to 90%RH (with no condensation)
Location for use	According to specifications for the 8841/8842 MEMORY HiCORDER
Dielectric strength	500 VDC for a minute (between input and output, between input and unit)
Insulation voltage	100 M or more / 500 VDC (between input and output, between input and unit)
Dimensions	Approx. 110W × 65H × 150D mm (4.33"W × 2.56"H × 5.91"D) Input cable: 2000 mm (78.7") Output cable: 500 mm (19.69")
Mass	Approx. 1250 g (44.1 oz) approx.
Accessory	Spare fuse (class A melting fuse (NM) 30 A/125 V, 6.4 dia. × 31.8 mm)

2.2.3 Functional Grounding of the 8841/8842

When the 8841/8842 is used in noise-prone environments, connect the functional grounding terminal to improve noise characteristics.

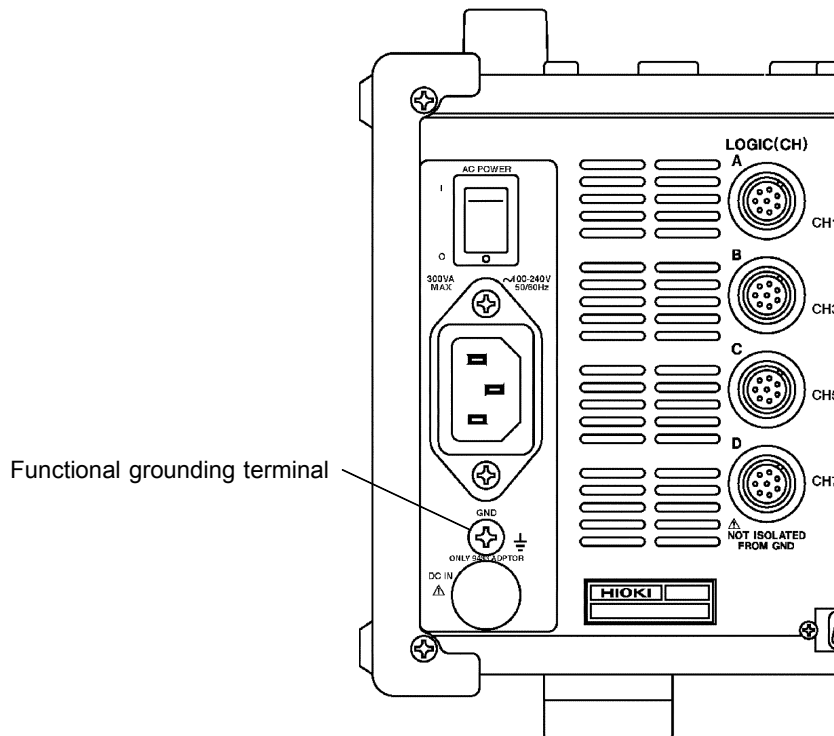

2.3 Power On/Off

⚠ WARNING

Check the following points before the power switch is turned on.

- Power supply matches Rated supply voltage (100 to 240 VAC: Voltage fluctuations of $\pm 10\%$ from the rated supply voltage are taken into account.) and rated supply frequency (50/60 Hz).
- The Unit is correctly installed (Section 2.1).
- Power cord is correctly connected (Section 2.2).
- The unit is properly grounded.

- There is no need for the user to manually select AC or DC power.
- When both AC and DC power are connected, AC power has priority.

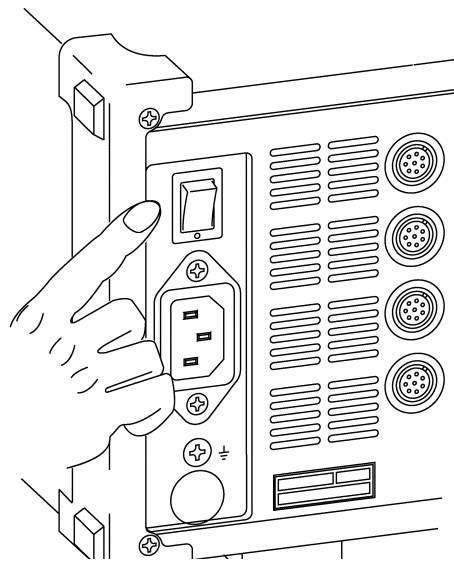

NOTE

- If both the AC power supply and 9433 DC POWER ADAPTER are connected to the 8841/8842, the AC power supply has priority. However, even when the 8841/8842 runs off the AC power supply, the 9433 remains in standby mode and consumes some power. Keep this in mind when connecting the 9433 to the battery while the 8841/8842 is connected to an AC power source.
- After the power switch is turned on, wait approximately 30 min for the 8936, 8938, 8946 and approximately 1 hour for the 8937, 8939, to stabilize the inside temperature of the connected input unit in order to obtain accurate waveforms. Then, make a zero adjustment of the 8936, 8937, 8938, 8946 or perform an auto balancing of the 8939 prior to measurement.
Zero adjustment see Section 9.5.1.
Auto balancing see Section 9.13.
- When the unit is turned off, it memorizes the currently used settings and reestablishes the same settings the next time the unit is turned on again.

2.4 Connection of the Input Unit

2.4.1 8936/ 8938/ 8946 ANALOG UNITS

⚠ WARNING

- Never connect the probe to the 8841/42 while the probe is already connected to the measurement object. Otherwise there is a risk of electric shock.
- Use only the specified connection cables.
An insulated BNC connector is used for the specified connection cables to prevent electric shock. If a metal BNC connector is used, electric shock may result, as the input L-terminal and the metal part of the BNC connector will have the same potential.

⚠ CAUTION

When disconnecting the BNC connector, be sure to release the lock before pulling off the connector. Forcibly pulling the connector without releasing the lock, or pulling on the cable, can damage the connector.

NOTE

Use only the specified connection cables. Using a non-specified cable may result in incorrect measurements due to poor connection or other reasons. In addition, the BNC connector may be damaged. For safety reasons, only use the optional 9197, 9198, or 9217 CONNECTION CORD for connection to the analog input units. (For the 8946, use the 9198 CONNECTION CORD.)

Connector Cable

(Maximum input voltage :)

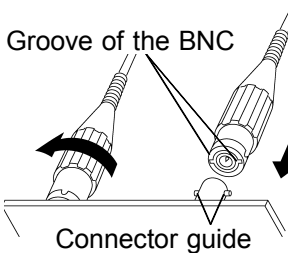
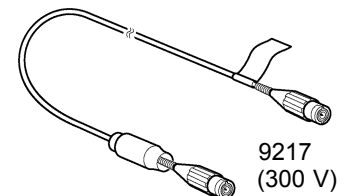
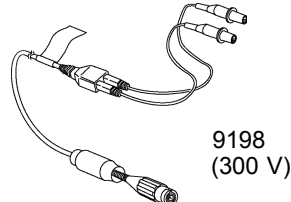
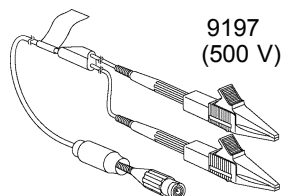

Connecting to the main unit

1. Align the BNC connector with the guide groove of the unit input connector, and turn clockwise while pressing in to lock the connector.
2. To remove from the unit, turn the BNC connector counterclockwise to release the lock, then pull it.

Setting channels of the 8946 4 ch ANALOG UNIT (8841 only)

When the 8946 4-channel analog unit is used, input channels 1 to 4 are not set in this customary sequence on the 8841. The slot position at which the 8946 is mounted determines the set input channel (see the illustration below). To confirm the position of the setting channels, see Section 9.6.

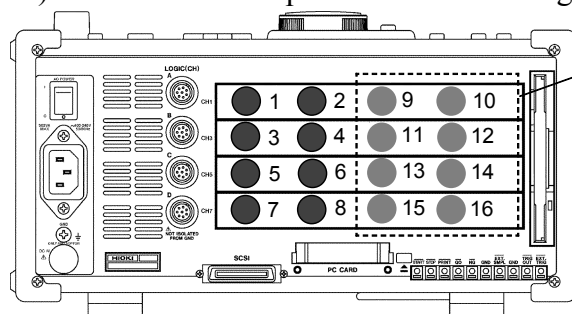

Illustrates active channels when the 8946 is mounted in each slot.

2.4.2 8937 VOLTAGE/TEMP UNIT

⚠ WARNING

- Never connect the cable to the unit while the cable is already connected to the measurement object. Otherwise there is a risk of electric shock.
- When an uninsulated thermocouple is used to measure temperature at a point carrying electric potential, take care not to touch the terminals and connector screws. Otherwise there is a risk of electric shock.
- Between voltage and temperature inputs and unit is insulated.

⚠ CAUTION

- When disconnecting the BNC connector, be sure to release the lock before pulling off the connector. Forcibly pulling the connector without releasing the lock, or pulling on the cable, can damage the connector.
- A common GND is used for voltage and temperature input on all channels. Never input voltage and temperature simultaneously, since doing so could result in damage to the sample being tested.

Connecting to the connector cable (voltage measurement)

1. Align the BNC connector with the guide groove of the 8841/42 input connector, and turn clockwise while pressing in to lock the connector. (Use the 9198 CONNECTION CORD for voltage measurement with the 8937.)
2. To remove from the unit, turn the BNC connector counterclockwise to release the lock, then pull it.

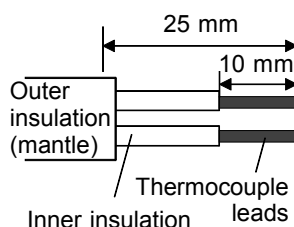

Thermocouple connection (temperature measurement)

1. Strip off the insulation as shown in the illustration.
2. Push the tab with a flatblade screwdriver or similar.
3. While keeping the tab depressed, insert a stripped wire into the connector opening.
4. Release the tab to lock the wire.
5. To remove the thermocouple, pull it out with the button depressed.

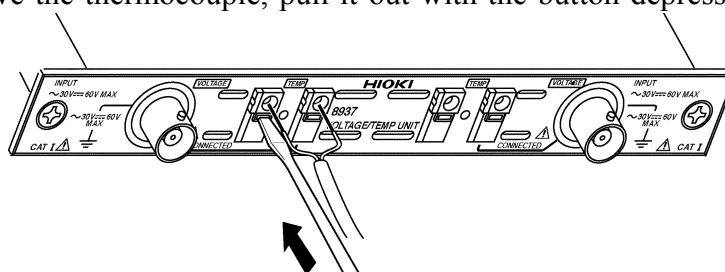

NOTE

- To mount and remove the thermocouple, use a tool such as a screwdriver.
- The push-button terminal block of the 8937 VOLTAGE/TEMP UNIT is specialized for the thermocouple. Do not use thermocouples other than the specified types (K, J, E, T, N, R, S, B).
- If the thermocouple is connected in reverse, the temperature reading will not be correct.

2.4.3 8939 STRAIN UNIT

CAUTION

- Connect only the sensor to the conversion cable supplied with the 8939 STRAIN UNIT.
- To disconnect the conversion cable, always unlock the plug and pull out the cable.

Connecting to the main unit

1. Align the projection on the unit connector with the cutout on the conversion cable, and insert the plug into the connector.
2. Turn the fixing guide (the colored area in the figure below) so that it engages with the connector guides on the unit, fully insert the fixing guide, and turn it clockwise to lock the plug.
3. To remove the conversion cable from the unit, turn the fixing guide (the colored area in the figure below) counterclockwise to unlock the plug, and pull out the plug.

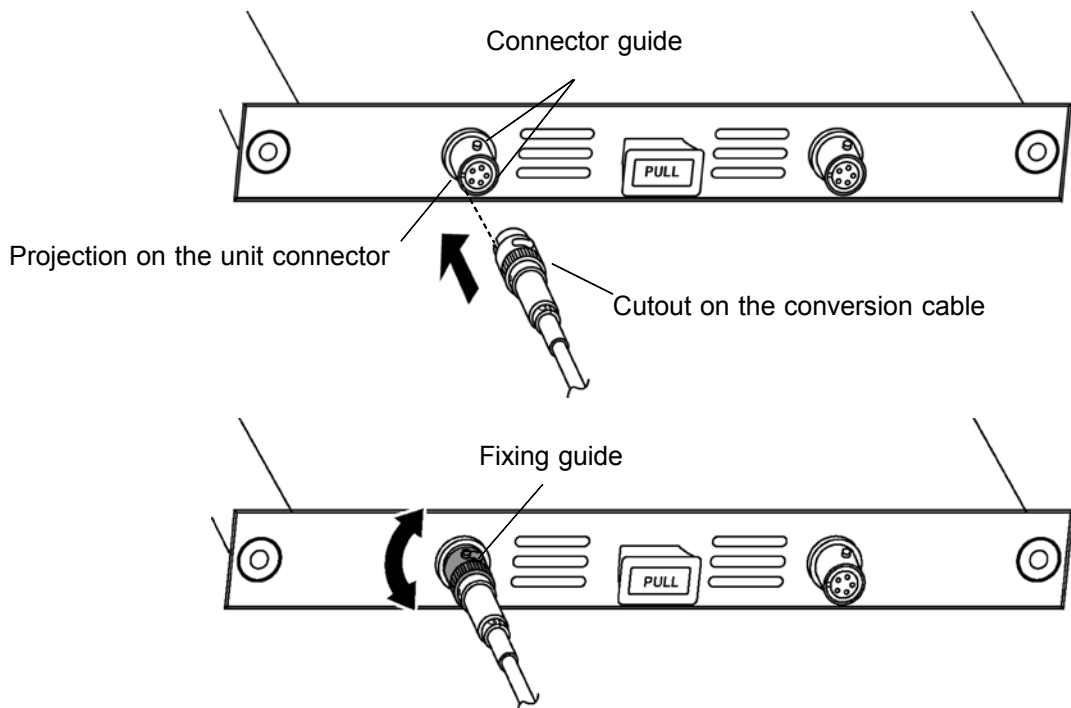

Connector

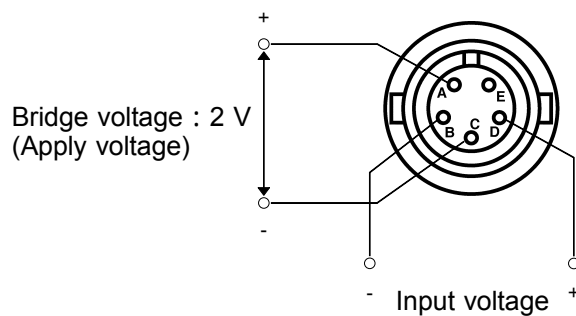

2.4.4 8940 F/V UNIT

⚠ DANGER

- To avoid electrical accidents, make sure that the **MEMORY HiCORDER** and the equipment being measured are powered off before making connections. Do not make connections with the power turned on.
- When using the **9318/9319 CONVERSION CABLE**, there is no isolation between **GND** the **MEMORY HiCORDER** and **GND** of the clamp on sensor/probe. Exercise extreme care in connection to avoid possible damage to the equipment or personal injury.
- When connecting **8940 F/V UNIT** to **3273**, and conductors being measured carry in excess of the safe voltage level (**SELV-E**) and not more than **300 V**, to prevent short circuits and electric shock while the core section is open, make sure that conductors to be measured are insulated with material conforming to (1) Measurement Category I, (2) Double Insulation (Reinforced insulation) Requirements for Working Voltage of 300 V, and (3) Pollution Degree 2. For safeties sake, never use this sensor on bare conductors. The core and shield case are not insulated.
- When connecting **8940 F/V UNIT** to **3273**, do not damage insulation sheathing on testing device.
- Refer to the following standards regarding the meanings of underlined terms. **IEC 61010-1, IEC 61010-2-031, IEC 61010-2-032**

⚠ WARNING

When using the clamp-on sensor or clamp-on probe, be sure to use the optional **9318 or 9319 CONVERSION CABLE**.

⚠ CAUTION

When disconnecting the BNC connector, be sure to release the lock before pulling off the connector. Forcibly pulling the connector without releasing the lock, or pulling on the cable, can damage the connector.

Connection cable connection (Frequency, count, pulse duty ratio and voltage measurement)

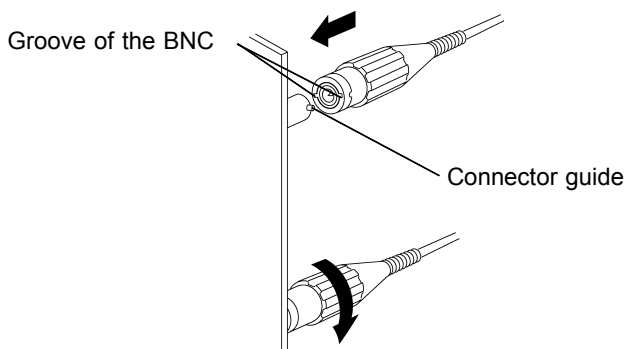

Use the optional **9198 CONNECTION CORD** for connection to the **F/V UNIT**.

1. Align the BNC connector with the guide groove of the **8841** input connector, and turn clockwise while pressing in to lock the connector.
2. To remove from the unit, turn the BNC connector counterclockwise to release the lock, then pull it.

Clamp connection (Current measurement)

The following clamp-on sensors and clamp-on probes can be connected using the 9318 and 9319 CONVERSION CORDs.

9318 : 9270, 9271, 9272, 9277, 9278, 9279 9319 : 3273

It can be connected to a maximum of 4 channels.

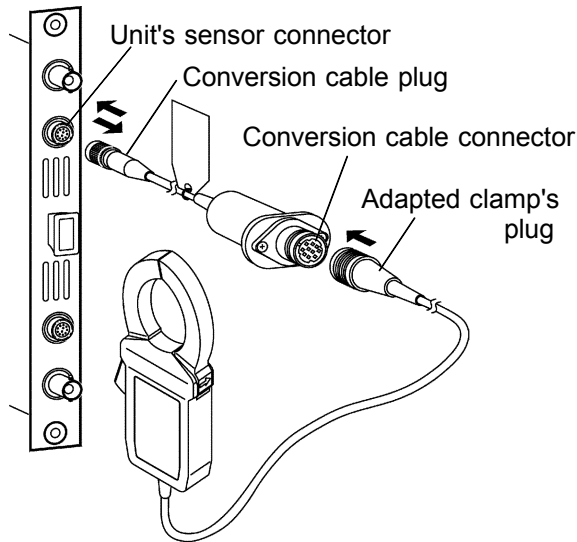

Connecting the 9318 CONVERSION CABLE

1. Align the groove on the conversion cable plug with the sensor connector on the F/V unit and push inward until the connector locks into place.
2. Align the groove on the conversion cable connector with the adapted clamp on sensor plug and push inward until the connector locks into place.
3. To unplug the cables, slide the lock ring on each plug outward to unlock it, then pull out the plug.

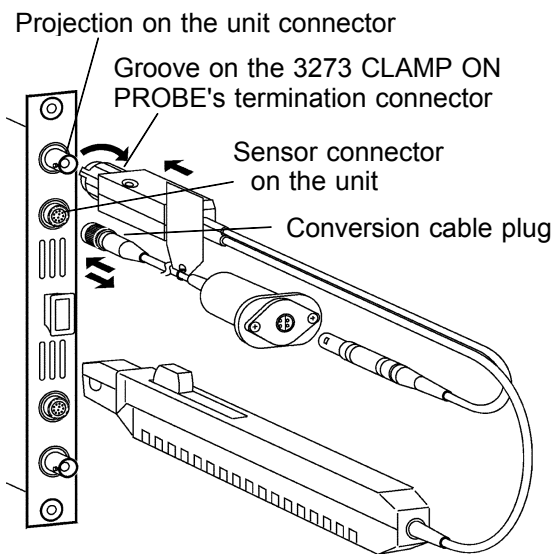

Connecting the 9319 CONVERSION CABLE

1. Align the groove on the 3273 CLAMP ON PROBE's termination connector with the pin on the BNC connector on the F/V unit, then slide the termination connector over the BNC connector and turn to lock it in place.
2. Align the groove on the conversion cable plug with the sensor connector on the F/V unit and push inward until the connector locks into place.
3. Unlock the conversion cable connector and the power plug on the 3273 before unplugging the cable.
4. To unplug the cables, slide the lock ring on each plug outward to unlock it, then pull out the plug.

2.4.5 8947 CHARGE UNIT

⚠ WARNING

- **Never connect the connection cable to the unit while it is connected to the measurement object, to avoid electric shock.**
- **The BNC connectors for each channel and the miniature connection terminals share a common ground. Do not connect both types of terminals at the same time.**
- **When the PREAMP measurement mode is selected, voltage (15 V at 2 mA) is applied internally to the BNC connector when measurement starts. To avoid electric shock and damage to measurement objects, select a measurement mode other than PREAMP or turn the unit off when connecting a sensor or probe to the BNC terminals.**
- **Before using an Internal Preamp Type Acceleration Sensor, be sure that it conforms to the 8947 specifications (15 V at 2 mA). Using a non-conforming sensor could result in damage to the sensor.**

Acceleration sensors compatible with the 8947 are as follows:

Acceleration sensors with internal preamp (BNC connector with 15 V at 2 mA operating power)

Charge-output type accelerator sensors (miniature 10-32 connection terminal)

Connecting an Internal Preamp Type Acceleration Sensor (PREAMP and VOLTAGE modes)

Use a cable with BNC connector to connect the pickup sensor to the unit in PREAMP mode. We recommend the Model 9198 CONNECTION CORD for the VOLTAGE mode.

1. Align the BNC connector with the guide groove of the 8841/42 input connector, and turn clockwise while pressing in to lock the connector.
2. To remove from the unit, turn the BNC connector counterclockwise to release the lock, then pull it.

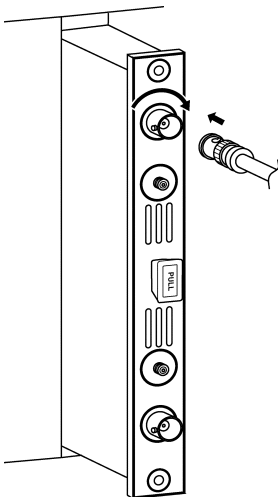

Connecting a Charge-Output Type Acceleration Sensor (CHARGE mode)

Use a cable with a plug to mate with the miniature connector to connect the pickup sensor to the unit in CHARGE mode (10-32 miniature connection terminal).

1. Insert the miniature connector plug into the miniature connector on the unit, and turn it clockwise until tight.
2. To remove the miniature connector, turn the plug counterclockwise.

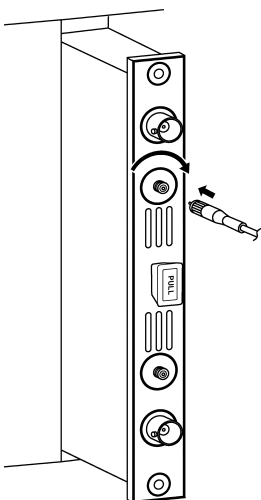

2.5 Logic Probe Connection



⚠ DANGER

The logic input and 8841/42 Unit share a common ground. Therefore, if power is supplied to the measurement object of the logic probe and to the 8841/42 from different sources, an electric shock or damage to the equipment may result.

Even if power is supplied from the same system, if the wiring is such that a potential difference is present between the grounds, current will flow through the logic probe so that the measurement object and 8841/42 could be damaged. We therefore recommend the following connection method to avoid this kind of result.

- (1) Before connecting the logic probe to the measurement object, be sure that power is supplied from the same outlet box to the measurement object and the 8841/42 using the supplied power cord.
- (2) Before connecting the logic probe to the measurement object, connect the ground of the measurement object to the 8841/42 ground terminal. Also in this case, power should be supplied from the same source. Refer to Section 2.2, "Power Supply and Ground Connections" for grounding terminal details.

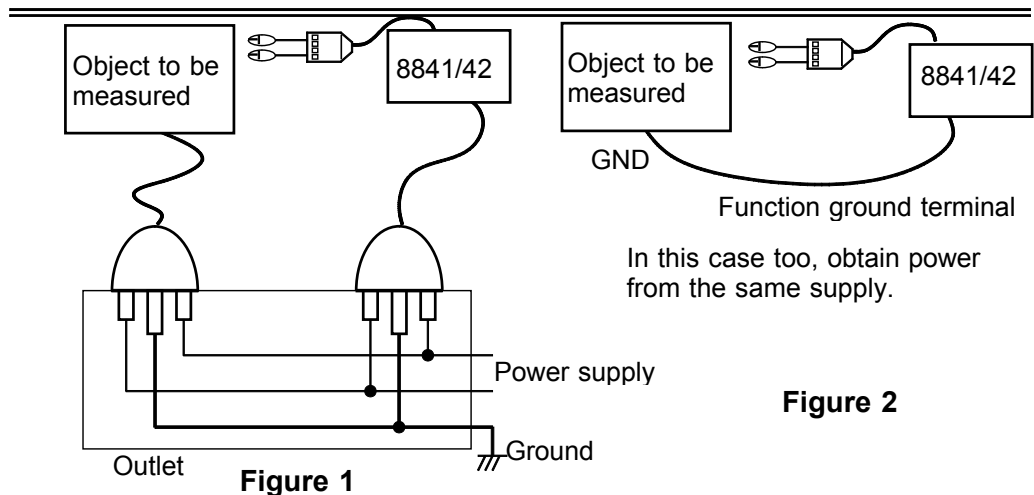
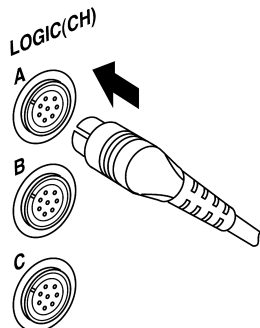

Figure 2



- The logic input is located on the rear of the unit. Up to four probes can be connected.
- Since one logic probe can record 4 channels, the combined maximum recording capability for logic waveforms is 16 channels.
- Connect the probe by aligning the groove on the plug with the ridge on the connector.

NOTE

- If no logic probe is connected, the corresponding logic waveform is displayed on the screen at high level.
- Carefully read the instruction manual supplied with the probe.
- Do not connect logic probes other than supplied by HIOKI to the logic inputs.

2.6 9018-10/9132-10 CLAMP ON PROBE



DANGER

- Clamp-on probe should only be connected to the secondary side of a breaker, so the breaker can prevent an accident if a short circuit occurs. Connections should never be made to the primary side of a breaker, because unrestricted current flow could cause a serious accident if a short circuit occurs.
- Before using the 9018-10/9132-10 CLAMP ON PROBE, be sure to carefully read its instruction manual and familiarize yourself with the operation principles of this product.

The HIOKI 9018-10/9132-10 CLAMP ON PROBE can be used to perform current measurement. This probe has a voltage output. The 8841/42 is designed for voltage input. It cannot be used to perform current measurements by itself.

Connections

Connect the BNC connector of the 9018-10/9132-10 CLAMP ON PROBE to the analog input of the 8841/42. Refer to "2.4 Connection of the Input Unit."

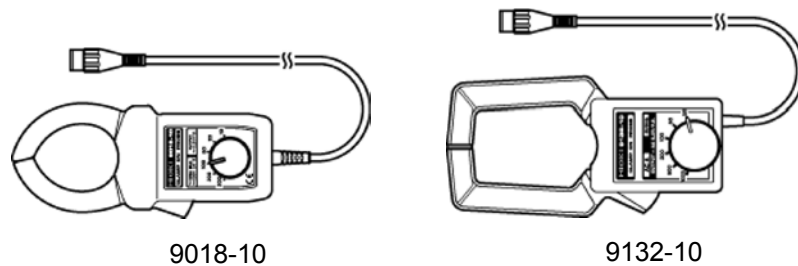

NOTE

- The 8841/42 will indicate measurement results as voltage.
- Using the scaling function, units can be converted to "A" for display.
- When the clamp-on probe is used for measurement, the measurement precision will be affected both by the 8841/42 precision and clamp-on probe precision ratings. The same is true for cases where other clamps are used.
- When using the 9018/9132 CLAMP ON PROBE, always use the 9199 CONVERSION ADAPTOR.

2.7 9322 DIFFERENTIAL PROBE Connection

⚠ DANGER

- When using grabber clips, the 9322's maximum rated voltage to earth is 1500 VAC/DC; when using alligator clips, it is 1000 VAC/DC. To avoid electrical shock and possible damage to the unit, never apply voltages greater than these limits between the input channel terminals and chassis, or across the inputs of two 9322s.
- Maximum input voltage is 1000 VAC/2000 VDC. Do not measure voltage in excess of these limitations, as doing so may damage the unit or cause an accident that might result in injury or death.

9322 is a differential probe that connects to input of 8841/42 MEMORY HiCORDER input unit. For more details, refer to its instruction manual.

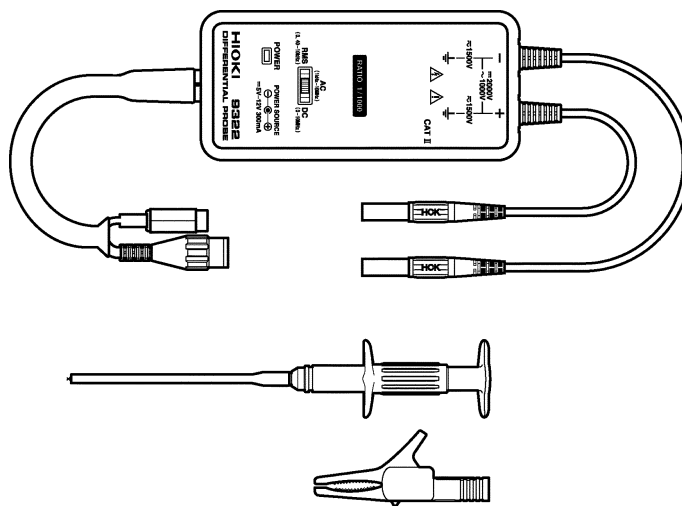

2.8 Loading Recoding Paper

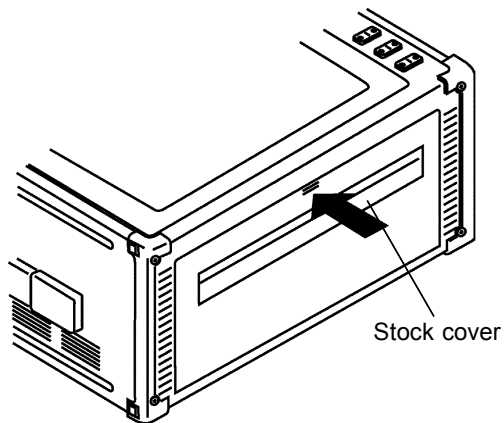

1. Press the stock cover and open it.

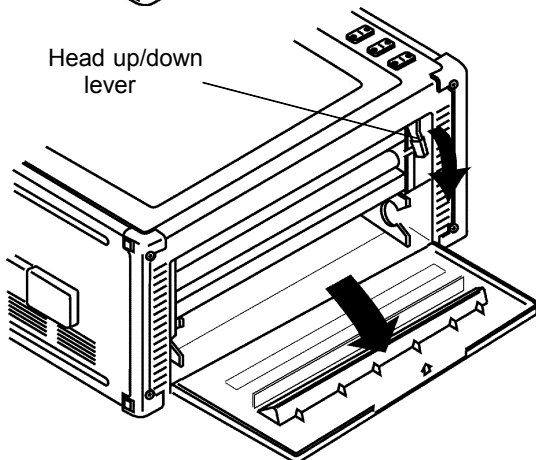

2. Put down the head up/down lever.

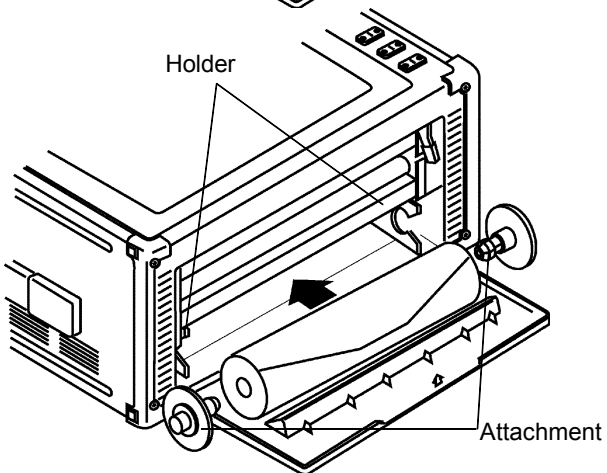

3. Insert the attachments into the ends of the roll of recording paper and set the paper into its holder.

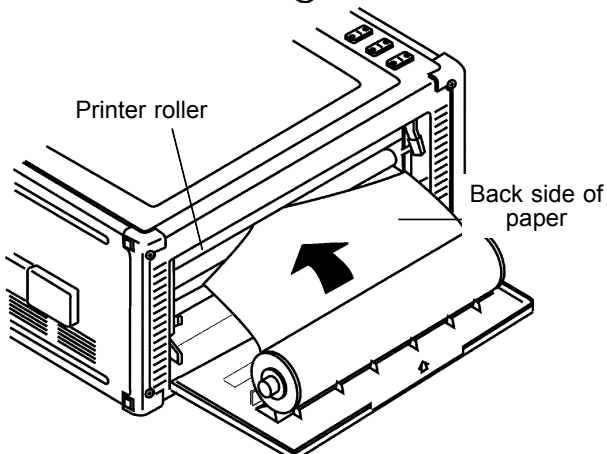

4. Insert the leading edge of the recording paper from above into the gap behind the printer roller, and pull it out to the other side.

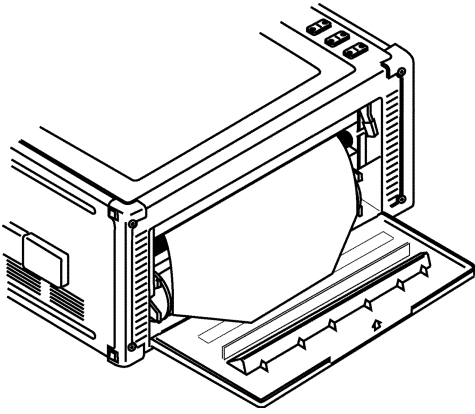

5. Align the edges of the recording paper you pulled out of the printer with the edges of the recording paper set into the holder. If the edges of the recording paper are not aligned exactly, the paper will come out crooked when printing.

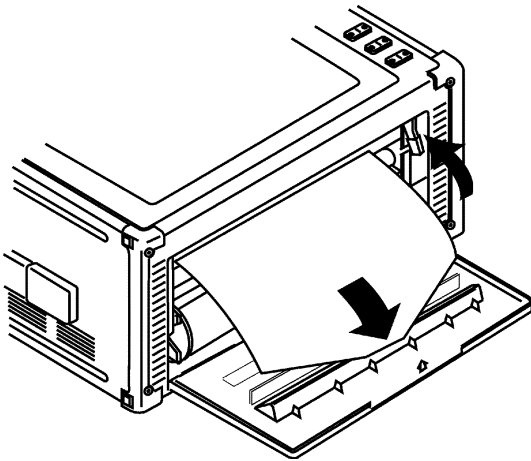

6. Raise the head up/down lever.
7. Pull the recording paper to the outside through the printer exit slot in the stock cover.

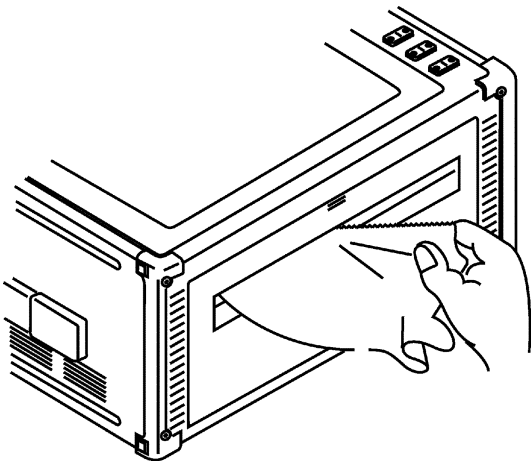

8. Close the stock cover, and finish by tearing off the recording paper against the edge of the printer exit slot.

NOTE

- Make sure that the recording papers positioned quite straight, if the recording paper is slanted with respect to the roller there is a danger that later a paper jam will occur.
- Always put the unit in the head up condition when it is to be transported or if it is to be stored for a long period of time. If the unit is left to lie in the state where the roller is being subjected to pressure by the head, then the roller may become deformed or the characters may become uneven.
- Particularly care should be taken not to put the recording paper in back to front by mistake, because if this happens the waveform cannot be drawn.

2.9 Care of Recording Paper

Care of recording paper

- While unopened, thermal paper will not be affected by the environment, provided that ambient temperature and humidity do not exceed normal levels. For long-term storage, temperature should be lower than 40°C. Low temperatures cause no problem.
- After opening, protect the paper from strong light, to prevent discoloration.

Storing data

The recording paper uses a thermochemical reaction. Note the following points:

- To avoid discoloration, do not leave recording paper in direct sunlight.
- Store at not more than 40°C and 90%RH.
- To keep definitive data, make photocopies of the recordings.
- Thermal paper will blacken when brought into contact with alcohol, ester, ketone, or other volatile organic substances.
- If the thermal paper absorbs an organic solvent such as alcohols or ketones it may no longer develop properly, and recorded information may fade. Soft PVC film and transparent contact adhesive tape contain such solvents, so avoid using them with recordings.
- Avoid interleaving the thermal recordings with damp diazo copies.

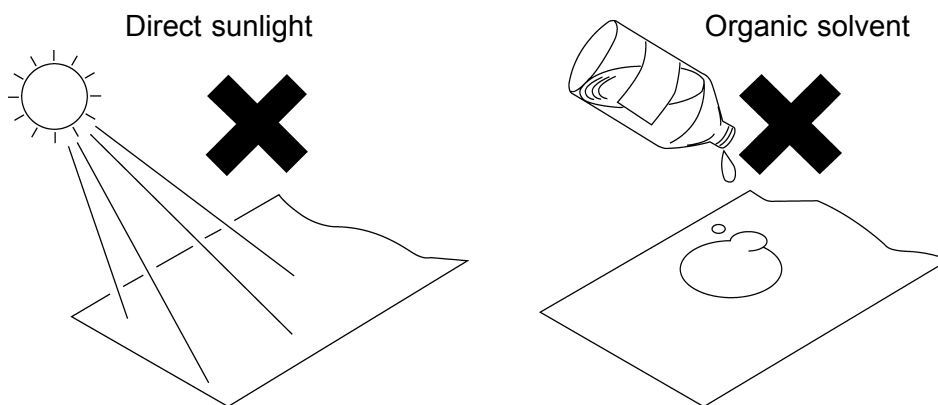

2.10 Notes on Measurement

⚠ DANGER

- **Maximum input voltage ratings for the input unit and the input terminals of the unit are shown below. To avoid the risk of electric shock and damage to the unit, take care not to exceed these ratings.**
- **The maximum rated voltage to earth of the input unit (voltage between input terminals and main unit frame ground, and between inputs of other analog units) is shown below. To avoid the risk of electric shock and damage to the unit, take care that voltage between channels and between a channel and ground does not exceed these ratings.**
- **The maximum rated voltage to earth rating applies also if an input attenuator or similar is used. Ensure that voltage does not exceed these ratings.**
- **When measuring power line voltages with the 8936 or 8938, always connect the probe to the secondary side of the circuit breaker. Connection to the primary side involves the risk of electric shock and damage to the unit.**

Input/output terminal	Maximum input voltage	Maximum rated voltage to earth
8936 (input)	400 VDC max.	370 VAC/DC
8937 (input)	30 Vrms or 60 VDC	30 Vrms or 60 VDC
8938 (input)	400 VDC max.	370 VAC/DC
8939 (input)	10 VDC max.	30 Vrms or 60 VDC
8940 (input)	30 Vrms or 60 VDC (BNC/sensor connector terminal)	30 Vrms or 60 VDC (BNC terminal) Not insulated (Sensor connector terminal)
8946 (input)	30 Vrms or 60 VDC	30 Vrms or 60 VDC
8947 (input) ^{*1}	30 Vrms or 60 VDC (BNC terminal)	30 Vrms or 60 VDC (BNC terminal)
9322	2000 VDC, 1000 VAC (CAT II) 600 VAC/DC (CAT III)	When using grabber clips 1500 VAC/DC (CAT II) 600 VAC/DC (CAT III) When using alligator clips 1000 VAC/DC (CAT II) 600 VAC/DC (CAT III)
EXT TRIG/ START · STOP/ PRINT/ EXT SMPL	-5 to +10 VDC	Not insulated
TRIG OUT/ GO/ NG	-20 V to +30 VDC 500 mA max./ 200 mW max.	

The maximum allowable charge that can be applied to the miniature connection terminals is 500 pC at the most sensitive of the six ranges, and 50,000 pC at the least

- **In order to avoid accidents from electric shock, before removing or replacing an input unit, check that the connector cables and thermocouple are disconnected, turn off the power, and remove the power cable.**
- **Normally keep all two input units installed permanently. If a unit is not fitted, it must be replaced by a blanking panel. If the unit is operated with an input unit not in place it poses a shock hazard.**

CAUTION

- Before using the unit, make sure that the sheathing on the input cables is not damaged and that no bare wire is exposed. If there is damage, using the unit could cause electric shock. Replace with the specified 9197 or 9198 CONNECTION CORD.
- When making measurements on an AC power line for example, using a voltage transformer, be sure to connect the voltage transformer ground terminal to ground.

NOTE

- Strong wind striking the input terminal can disrupt the thermal balance of the input circuit, resulting in incorrect readings. When taking measurements in windy environments, arrange the equipment to prevent wind from directly striking the input terminal of the 8937.
- Abrupt changes on ambient temperature can also disrupt the thermal balance of the input circuit. To prevent measurement error, allow the unit to adjust to the new temperature for about one hour before starting measurement.

Difference between "370 VAC/DC" and "400 VDC max." indication

370 VAC/DC: RMS value is displayed.

400 VDC max.: Instantaneous value is displayed.

The maximum input voltage (400 VDC max.) is defined as the superposition of DC component and AC peak, as shown in the figure below.

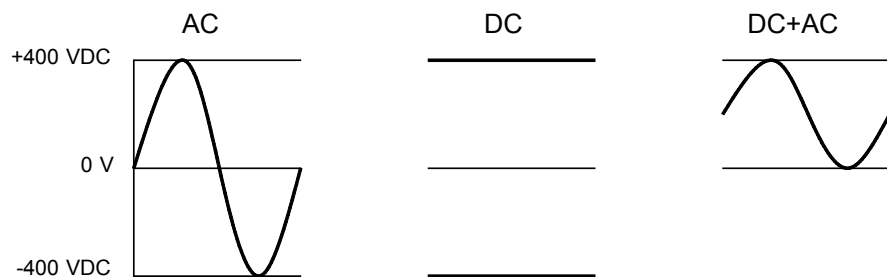

2.10.1 Maximum Input Voltage

8936 ANALOG UNIT, 8938 FFT ANALOG UNIT

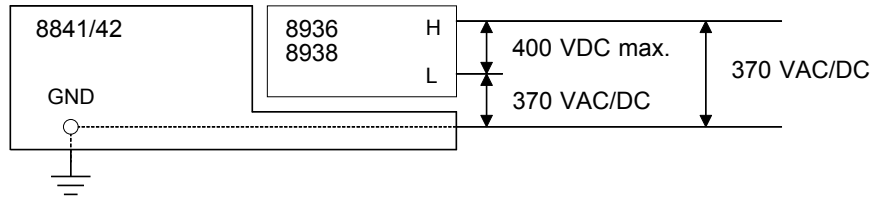

8937 VOLTAGE/TEMP UNIT

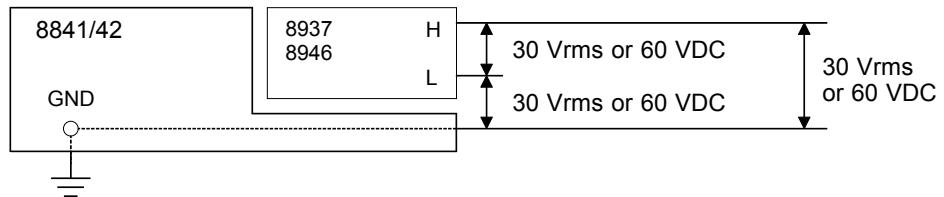

8939 STRAIN UNIT

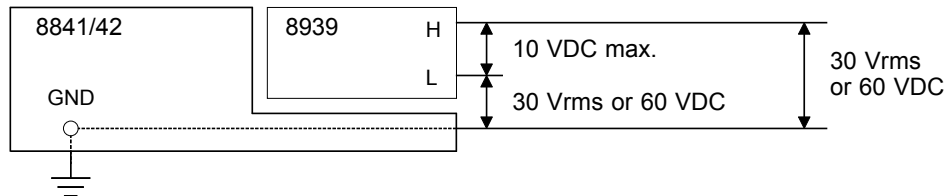

8940 F/V UNIT

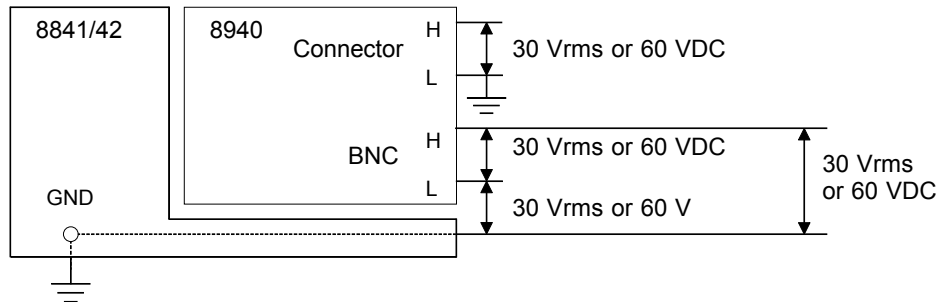

8947 CHARGE UNIT

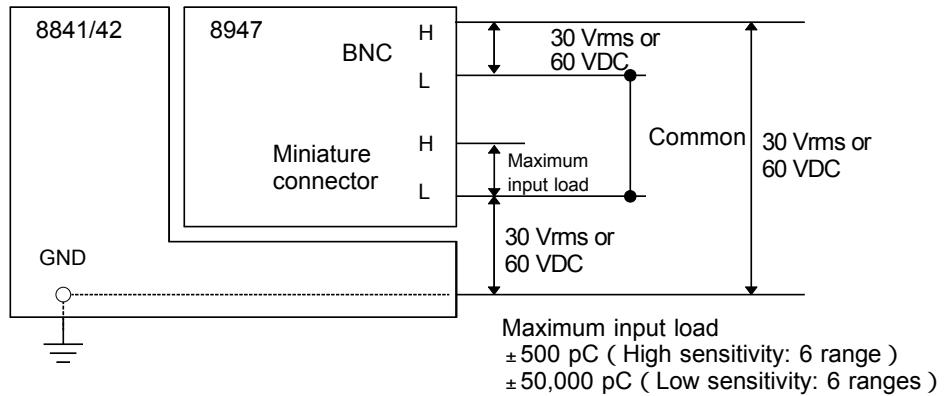

2.10.2 Using a Voltage Transformer

When making measurements on an AC power line for example, using a voltage transformer, be sure to connect the voltage transformer ground terminal to ground.

When the voltage transformer has a ground terminal

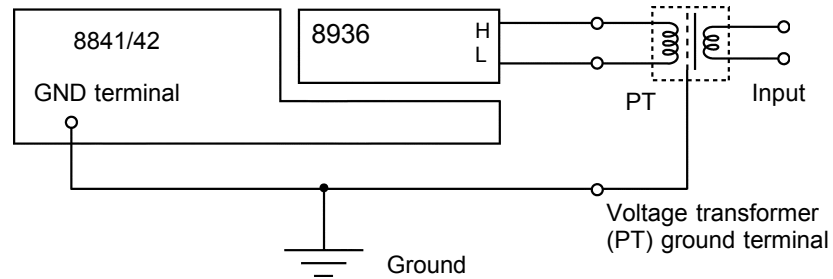

When the voltage transformer has no ground terminal

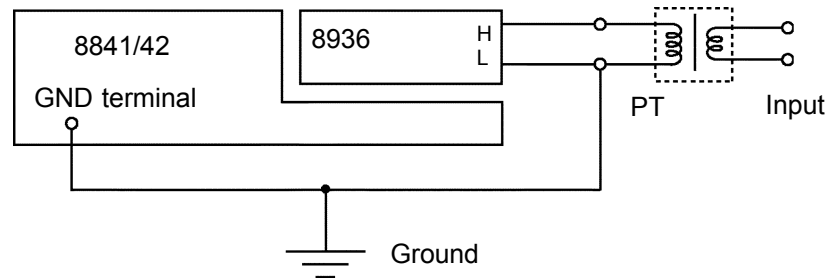





Chapter 3

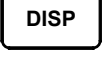
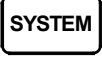
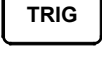

Basic Key Operation **3**

3.1 Basic Key Operation

3.1.1 Basic Display Operation (MENU)

	STATUS key	Displays the STATUS screen. Serves to switch pages of the STATUS screen. Serves to make main settings for various functions on the STATUS screen.
	CHAN key	Displays the CHANNEL screen. Serves to set measurement range, position, etc. for input channels. Serves to switch pages of the CHANNEL screen.
	DISP key	Displays the display screen. Serves to display and observe waveforms.
	SYSTEM key	Displays the SYSTEM screen. Serves to switch pages of the SYSTEM screen. Serves to make common settings for all functions (clock setting, comment input, etc.) on the SYSTEM screen.
	TRIG key	Displays the TRIGGER screen and serves to set trigger. Serves to switch pages of the trigger screen.
	FILE key	Displays the FILE screen. Serves to read and store waveform data on the FILE screen. See Chapter 14.

3.1.2 Printer Key Operation

	PRINT key	Serves to print out the waveform. Output destination by the PRINT key can be selected. See Section 12.5.2.
	COPY key	Produces a hard copy of the display content. Copy destination by the COPY key can be selected. See Section 12.5.1.
	FEED key	Forwards the paper while the key is held down.

3.1.3 Setting the Items

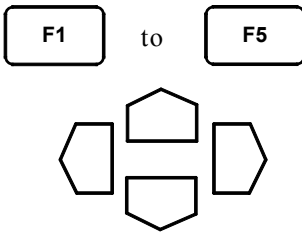

F1 to F5
(Function keys)

The respective items are shown in the function key display. Select and set the items.

CURSOR keys

Serve to move the flashing cursor or use the key lock function.

3.1.4 Jog/Shuttle Controls and Select Key

Use the select key when the screen is in measurement display mode. Selected key lights LED.

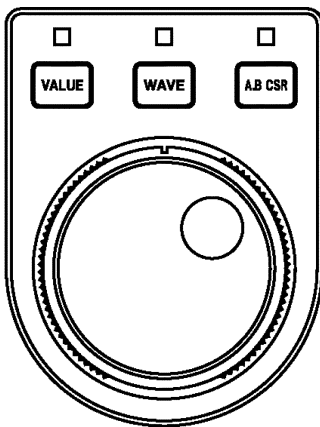

VALUE

Entering the numerical values.

WAVE

Waveform scrolling (See Section 11.1)

A.B CSR

Movement of A•B cursors (See Section 11.2)

When the LED "VALUE" is lit and the following function keys are displayed, values and items may be set with the Jog/Shuttle control.



Increases in number.

Move the item selection cursor up in the selection window.



Decreases in number.

Move the item selection cursor down in the selection window.



Increases in number, large step

Increases in number, 10-units



Increases in number, small step

Increases in number, 1-units



Decreases in number, small step

Decreases in number, 1-units



Decreases in number, large step

Decreases in number, 10-units

3.1.5 Basic Input Operation

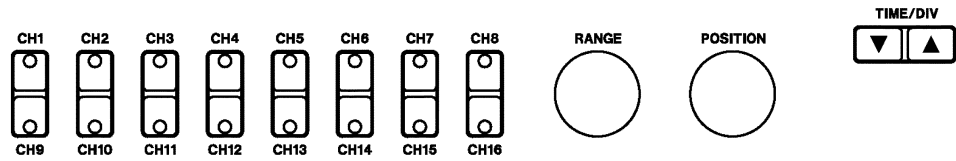

Set the basic settings for analog channels. See Chapter 9.

- CH1 - CH16 keys** Used to select channels and input values for connected input units
In the DISPLAY or CHANNEL screen, these keys are used to select channels or set channels directly by means of the **POSITION** and **RANGE** knobs.
In the value input, these keys are used to set values.
- RANGE knob** Serves to set the measurement range for the channel selected by the channel select key.
- POSITION knob** Serves to set the zero position for the channel selected by the channel select key.
- TIME/DIV key** Serves to set the input signal capture speed.

3.1.6 Measurement Start and Stop Operation

- LED: light during measurement
- START key** Press the **START** key to initiate measurement or set the unit to trigger standby.
- STOP key** Press the **STOP** key during measurement and trigger waiting to stop the measurement.

NOTE The measurement start/stop operation is separately determined by each measurement function. For details, see "Start and Stop Operation," which explains each measurement function.

3.2 Other Keys Operation

MANU TRIG	MANU TRIG key Manual trigger	When the unit is in trigger standby mode, pressing this key causes manual triggering. See Section 10.12.
CH.SET	CH.SET key Channel settings	Enables the measurement conditions for each channel on the display screen to be set or changed. Settings remain in effect even during startup. (Settings are not in effect during waveform parameter calculation setup.) The setup screen for "ch 1 to 16," or "logic A to D" can be selected on the channel and trigger screens. See Section 9.3.
LEVEL MONI	LEVEL MONI key	Displays the level monitor. See Section 11.5.
VIEW	VIEW key	Shows at the bottom of the screen the position with respect to the recording length of the displayed part of the waveform. Call up information about the status of memory block. See Section 11.6.
AUTO	AUTO key	Automatically sets time axis range, measurement range, and zero position of the input waveforms with the memory recorder function. See Section 4.6.
HELP	HELP key	An explanation of the display screen or the item currently selected by the cursor appears. Press the HELP key to bring up a Help window containing explanatory information. Pressing any key exits help screen.

On-line Help

A brief explanation of the item currently selected by the flashing cursor is displayed by pressing the **HELP** key.
Press any key to cancel the help screen.

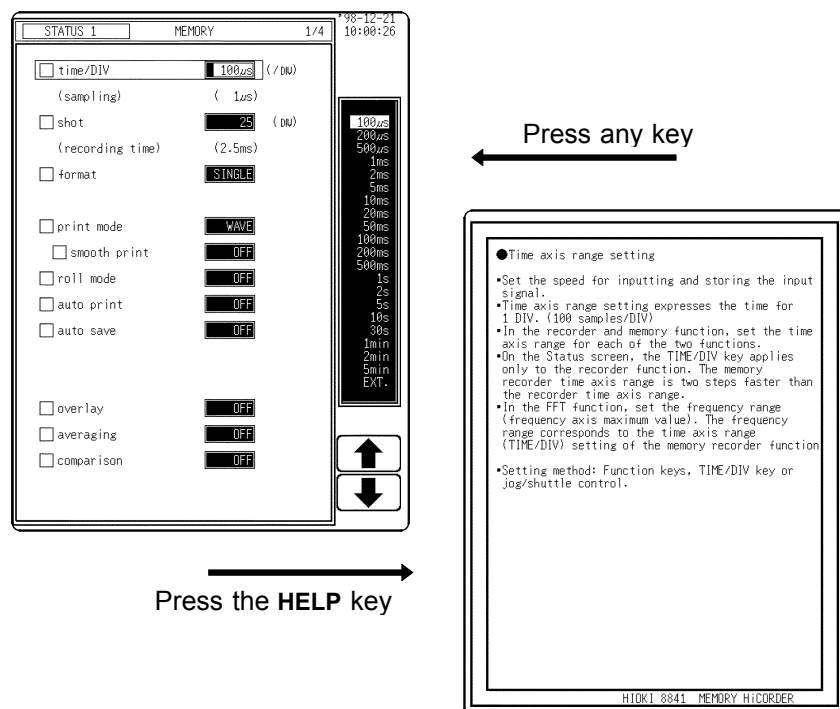

3.3 Screen Configuration

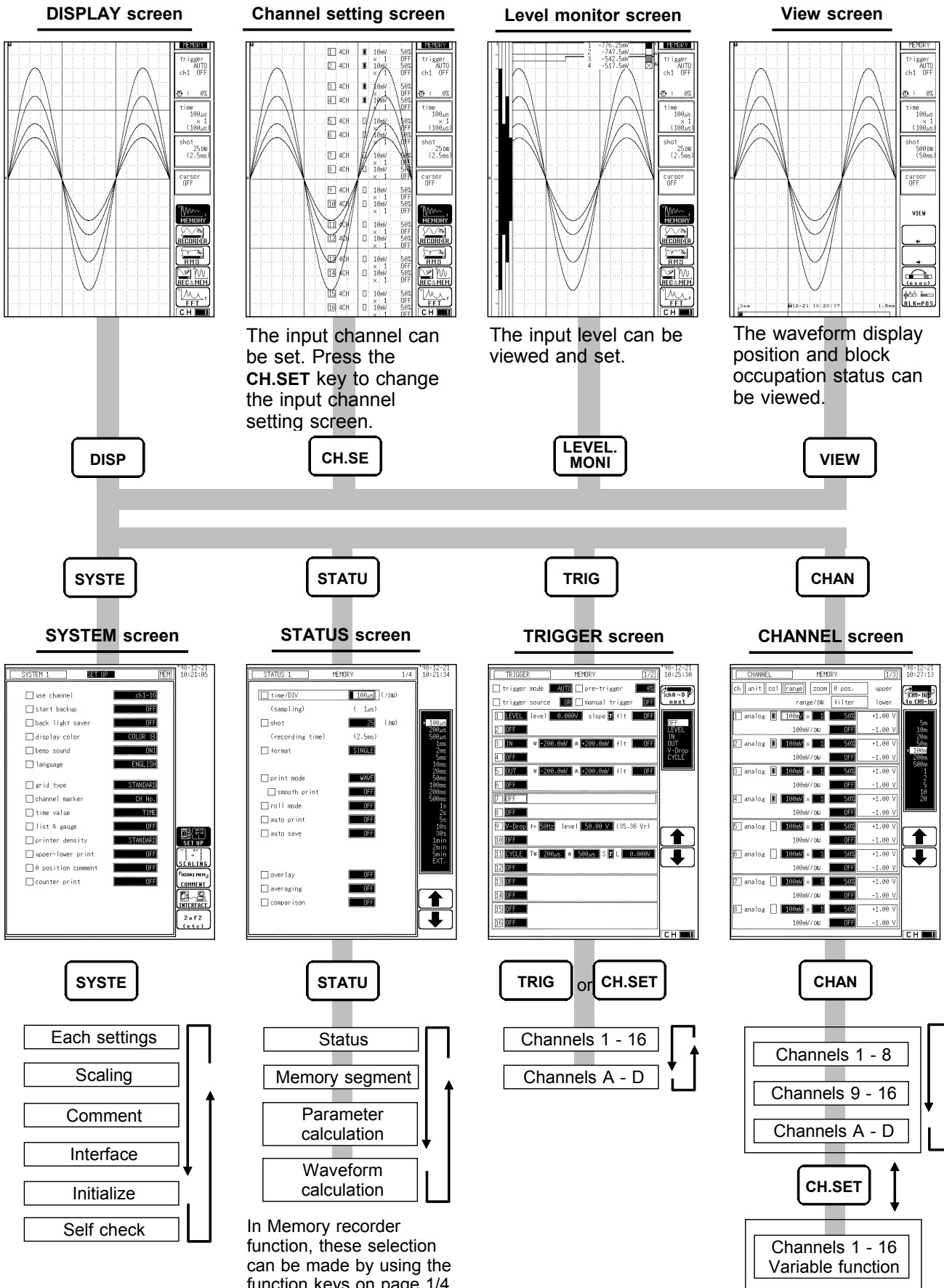

Chapter 4

Memory Recorder Function

4.1 Overview of the Memory Recorder Function

The memory recorder function has the following features.

- (1) After being stored in the internal memory, input signal data can be displayed and printed.
- (2) All input channel data are recorded on the same time axis.
Since data for all channels can be superimposed, the relative relationship between input signals can be observed visually.
- (3) Time axis setting
100 μ s/DIV to 5 min/DIV
- (4) Time axis resolution 100 points/DIV
- (5) Storage capacity

Number of channels	16	8	4	2
8 M words (DIV)	5000	10000	20000	40000
32 M words (DIV)	20000	40000	80000	160000

- (6) Waveform magnification/compression display and print
 - Time axis direction $\times 10$ to $\times 1/10000$ (16 steps)
 - Voltage axis direction $\times 10$ to $\times 1/2$ (single), $\times 5$ to $\times 1/4$ (2 to 8, X-Y single, dual screens) 5 steps
 - With the variable function, vernier function, zoom function
- (7) Display format
 - Time axis waveform: single, dual, quad, oct screen display (LCD), hex screen display (when printing)
 - X-Y waveform: single, dual screen display (dot, line)
- (8) Printing
 - Auto print, Manual print, Partial print, Report print, Screen hard copy.
 - Multiple printing possible.
- (9) High-quality print
Smooth print function approximates analog waveform.

(10) Logging function

Numeric printout of waveform data

(11) Memory segmentation function

- Helps to reduce dead time of continuous recording. (Sequential save function)
- Memory is divided into blocks which can freely selected by the user for storing measurement data. (Multi-block function)

(12) Processing function

- Waveform processing (arithmetic processing, differential processing etc.)
- Waveform parameter processing (frequency measurement, rms measurement etc.)

(13) Averaging

This makes it possible to eliminate noise and irregular signal components.

(14) Waveform evaluation function detects abnormal waveforms.

4.2 Operation Sequence (MEM)

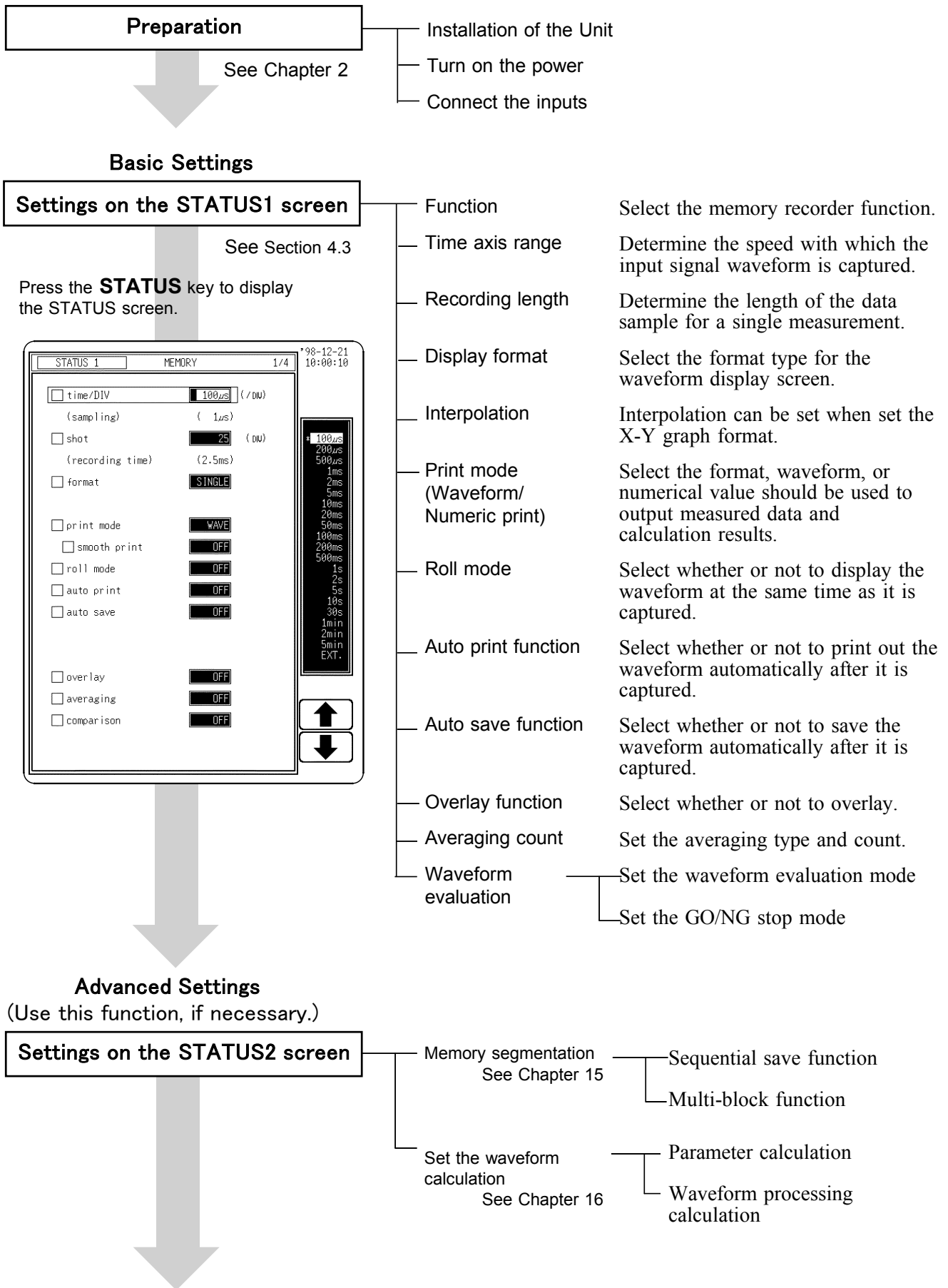

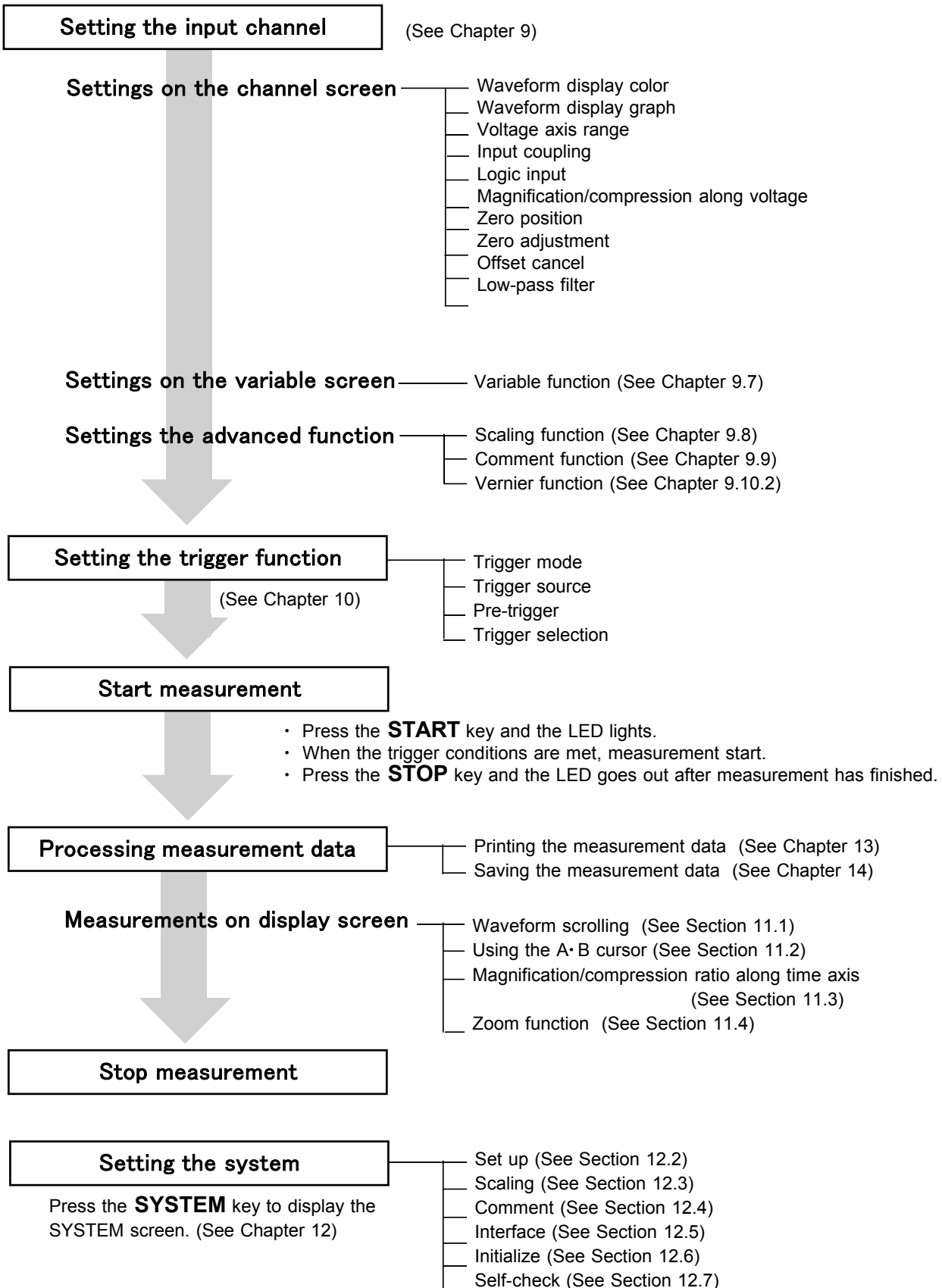

4.3 STATUS Settings (MEM)

Press the **STATUS** key to access the STATUS1 screen. This section explains how to set the STATUS screen of the memory recorder function. See the corresponding sections for items that can be set in the Waveform display or CHANNEL screens.

Waveform display screen: See Section 4.5

CHANNEL screen: See Section 9.3

Setting	Value	Section
STATUS 1	MEMORY	1/4
*00-01-05	13:52:45	See Sections 4.3.1
<input type="checkbox"/> time/DIV (sampling)	100 μ s (1 μ s)	4.3.2
<input type="checkbox"/> shot (recording time)	25 (2.5ms)	4.3.3
<input type="checkbox"/> format	X-Ysing	4.3.4
<input type="checkbox"/> dot-line	LINE	4.3.5
<input type="checkbox"/> print mode	LOGGING	4.3.6
<input type="checkbox"/> interval	0.01 DIV	
<input type="checkbox"/> roll mode	OFF	4.3.7
<input type="checkbox"/> auto print	OFF	4.3.8
<input type="checkbox"/> auto save (means)	FLOPPY SAVE	4.3.9
<input type="checkbox"/> type (file name)	TEXT AUTO	
<input type="checkbox"/> thin out	OFF	
<input type="checkbox"/> overlay	OFF	4.3.10
<input type="checkbox"/> averaging	OFF	4.3.11
<input type="checkbox"/> comparison	OUT	4.3.12
<input type="checkbox"/> stop mode	GO	

NOTE

The settings in Section 4.3.5 are displayed only when the display format has been set to "X-Y."





4.3.1 Setting the Function Mode

The 8841/42 has five function modes. Select the Memory recorder function.

Procedure

Screen: STATUS1, CHANNEL, TRIGGER, Waveform display

1. Use the Menu keys to display the desired screen.
2. Move the flashing cursor to the top position.
3. Select the **MEMORY** function key display.

Function display	Meaning
	: Memory recorder function
	: Recorder function
	: RMS recorder function
	: Recorder & Memory recorder function
	: FFT function

4.3.2 Setting the Time Axis Range

Set the speed for inputting and storing the waveform of the input signal. Time axis range setting expresses the time for 1 division. The sampling period is 1/100th of the set value for the time axis range. (100 samples/DIV)

Screen: STATUS1, Waveform display

Procedure 1

1. Use the Menu keys to display the desired screen.
2. Move the flashing cursor to the **time/DIV** item.
3. Use the Jog/Shuttle control, the function keys or the **TIME/DIV** key to make the selection. When "EXT." is selected, the external sampling can be used. For details, see Section 17.1.4.

Data points per division are set when external sampling is selected.

1. Move the flashing cursor to the **samples/DIV** item, as shown in the figure on the left.
2. Use the **JOG/SHUTTLE** control or the function keys to make the selection. Setting range is 10 to 1000.

Procedure 2

Using the TIME/DIV key

1. Use the Menu keys to display the desired screen.
2. Use the **TIME/DIV** key to make the selection.
The **TIME/DIV** key can be used regardless of where the flashing cursor is located.

NOTE

The symbol "*" in the selection window indicates the time axis of the data stored to current memory. (If no data is present in memory, this symbol is not displayed.)

4.3.3 Setting the Recording Length

The length of recording for one measurement operation (number of DIV) can be set.

SELECT Select the recording length.

ARBITRARY Variable recording length can be selected by the user.

Screen: STATUS1, Waveform display

Procedure 1 Constant recording length mode

1. Use the Menu keys to display the desired screen.
2. Move the flashing cursor to the **shot** item and select **SELECT**.
3. Use the Jog/Shuttle control or the function keys to make a setting.

Function
display

Meaning



: Move the cursor up in the selection window.



: Move the cursor down in the selection window.

Procedure 2 Variable recording length mode

1. Use the Menu keys to display the desired screen.
2. Move the flashing cursor to the **shot** item and select **ARBITRARY**.
3. Use the Jog/Shuttle control or the function keys to make a setting. To change the column, use the cursor keys (◀▶).

Function
display

Meaning



: Increases in number.



: Decreases in number.

NOTE

- Depending on the number of channels, the recording length is limited. (For setting the number of channels, see Section 12.2.1.)
- If the recording length is changed during measurement, measurement is restarted using the newly set recording length.
- In fixed-length recording mode, the symbol "*" in the selection window indicates the recording length of the data stored to current memory. (If no data is present in memory, this symbol is not displayed.) In any recording-length mode, the symbol "#" is displayed before the recording length.

The relation between number of channels and maximum recording length

Memory capacity (words)	Maximum recording length (DIV)			
	16 channels	8 channels	4 channels	2 channels
8 M	5000	10000	20000	40000
32 M	20000	40000	80000	160000

4.3.4 Setting the Display Layout

- The layout can be set for showing input signals on the screen display and recording them on the printer.
- The following layout is available: single, dual, quad, oct (Waveform display screen), hex (print only, oct graph on Waveform display screen) X-Y single, X-Y dual (dot/line).
- The voltage per division is automatically changed according to the display format.

Procedure

Screen: STATUS1

1. Press the **STATUS** key to display the STATUS1 screen.
2. Move the flashing cursor to the **format** item.
3. Use the function keys to select the display format.
4. Set the graph type when the display format is set to Dual, Quad, Oct or Hex screen display. For the setting of the X-Y screen, refer to Section 4.4.
5. Press the **CHAN** key to display the CHANNEL screen.
6. Move the flashing cursor to the point in the figure below.
The figure shows the setting for the channel 1 (CH1). Setting for the channel 2 to 16 should be made in the same way.

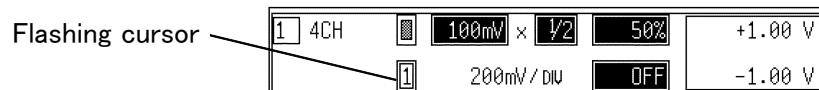

7. Use the function keys to select.

Function
display

Meaning



: Move the cursor up in the selection window.



: Move the cursor down in the selection window.

In the cases of HEX, as far as the printer recording output is concerned, the waveforms for each channel are automatically distributed on each graph according to the table below:

Graph	Analog channel	Graph	Analog channel
1	CH 1	9	CH 9
2	CH 2	10	CH 10
3	CH 3	11	CH 11
4	CH 4	12	CH 12
5	CH 5	13	CH 13
6	CH 6	14	CH 14
7	CH 7	15	CH 15
8	CH 8	16	CH 16

For details on logic channels, refer to Section 9.3.8.

Single graph

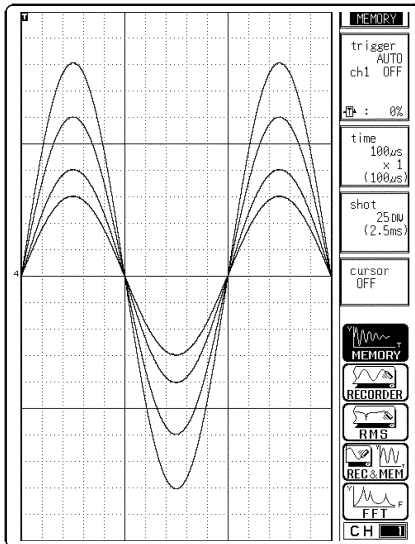

Display and record as one graph.
(At the most, 16 analog + 16 logic signals)

Dual graph

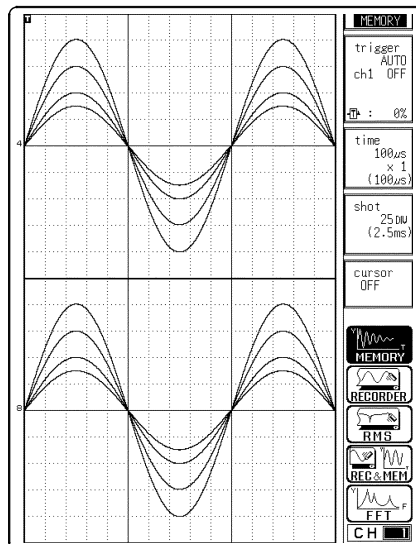

- Display and record as two graphs. (At the most, 16 analog + 16 logic signals)
- Specify which input channel to use for waveform graph display and recording.

Quad graph

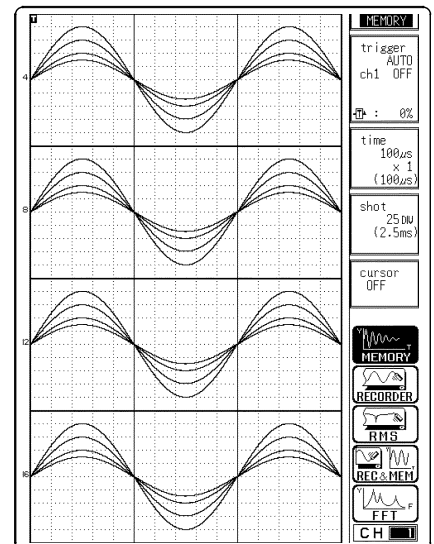

- Display and record as four graphs. (At the most, 16 analog + 8 logic signals)
- Specify which input channel to use for waveform graph display and recording.

Oct graph

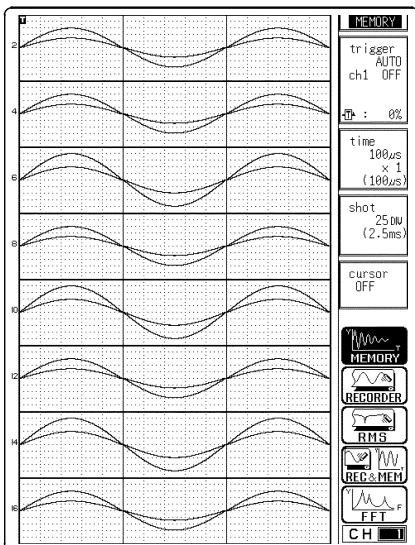

- Record as eight graphs. (At the most, 16 analog + 4 logic signals)
- Specify which input channel to use for waveform graph display and recording.

X-Y single graph (dot)

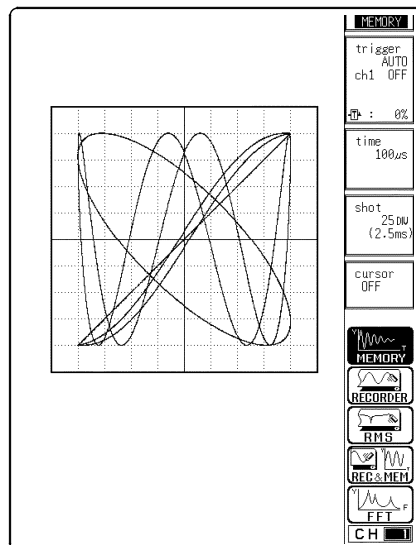

X-Y dual graph (line)

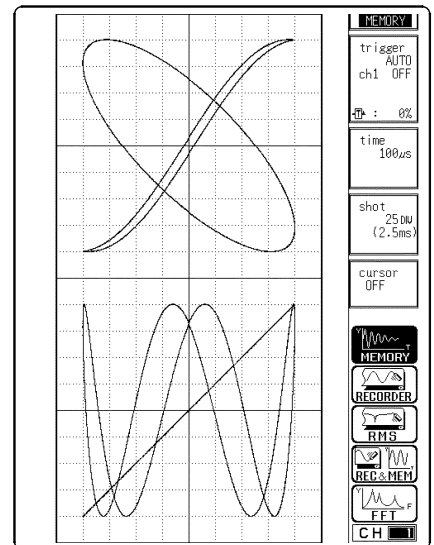

HEX graph

- Display is same as Oct screen display.
- Record as sixteen graphs. (At the most, 1 analog + 2 logic signals)
- Channel positions are automatically distributed.



4.3.5 Setting the Interpolation (dot-line)

- Interpolation can be set when set the X-Y graph format.
- This setting determines whether the input waveform (sampling data) is to be displayed and printed as a series of dots or a line using linear interpolation.

Procedure

Screen: STATUS1

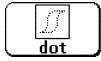
1. Press the **STATUS** key to display the STATUS1 screen.
2. Move the flashing cursor to the **dot-line** item.
3. Use the function keys to make a setting.

Function display	Meaning
	: Linear interpolation is not performed.
	: Linear interpolation is performed.

4.3.6 Setting the Print Mode

Select the format, waveform, or numerical value should be used to output measured data and calculation results.

Waveform The smooth print function can be used, but print speed will decrease.



Numerical value The data spacing interval also must be set.

Procedure

Screen: STATUS1

(1) Setting the printer format

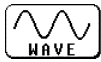
1. Press the **STATUS** key to display the STATUS1 screen.
2. Move the flashing cursor to the **print mode** item.
3. Use the function keys to make a setting.

Function display	Meaning
	: Measurement data and the result of calculation are printed as a waveform.
	: Measurement data and the result of calculation are printed as numeric data.

(2) Setting the smooth printing and print interval

1. When the waveform format is selected, determine whether to use the smooth printing or not. When the numerical value is selected, set the print interval. (unit: divisions)
2. Move the flashing cursor to **smooth print** or **interval**.
3. Use the function keys to make a setting.

Since 1 division represents 100 samples, the print interval "0.01" refers to a printout of every sample (no print interval). If the set print interval exceeds recording length, only the first point is printed.

NOTE

On X-Y screen, smooth printing cannot be specified.

4.3.7 Setting the Roll Mode

- This mode can be used at a time axis range setting of 10 ms/DIV or slower.
- In normal recording, the waveform is displayed only after all data of the recording length have been captured. At low sampling speed settings, this will cause a considerable delay between the start of measurement and the appearance of the waveform on the display.
- When roll mode is set to ON, the waveform is displayed immediately at the start of recording (the screen scrolls).
- When the time axis range of 10 ms/DIV or faster is set, normal recording is carried out even if roll mode is set to ON.

Procedure

Screen: STATUS1

1. Press the **STATUS** key to display the STATUS1 screen.
2. Move the flashing cursor to the **roll mode** item.
3. Use the function keys to make a setting.

Function
display

Meaning



: Normal recording is carried out.



: The waveform is displayed immediately at the start of recording.

NOTE

- Roll mode cannot be set together with the external sampling.
- When Roll Mode is set to ON, the settings for Overlay, Averaging, Sequential Saving, Calculating Waveform data, and Waveform evaluation are automatically turned OFF. (When the display format is set to "X-Y," you can turn ON Overlay with Roll Mode ON.)

4.3.8 Setting the Auto Print Function

When the function is enabled, printout is carried out automatically after a measurement data is captured.

Procedure

Screen: STATUS1

1. Press the **STATUS** key to display the STATUS1 screen.
2. Move the flashing cursor to the **auto print** item.
3. Use the function keys to make a setting.

Function
display

Meaning



: Auto print is disabled.



: Automatically printed to the internal printer.



: A LAN is used to transfer printing images to the 9333 LAN COMMUNICATOR.

NOTE

- When cursor A and B are enabled, partial printing is executed.
- When the roll mode is enabled and the time-axis range is lower than 10 ms/DIV, data is displayed and printed simultaneously.





4.3.9 Setting the Auto Save Function

When the function is enabled, measurement data are automatically stored on a floppy disk, PC card, MO disk or connected SCSI device after they are captured. The Auto Save function stores a file in the directory currently selected on the file screen. See Section 14.12.2.

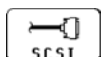

Procedure

Screen: STATUS1

1. Press the **STATUS** key to display the STATUS1 screen.
2. Move the flashing cursor to the **auto save** item.
3. Use the function keys, select the media for auto saving.

Function display	Meaning
	: Auto save is disabled.
	: Automatically stored on floppy disk
	: Automatically stored on PC card.
	: Automatically stored on connected SCSI device.
	: Automatically stored on MO disk.
	: (When using a LAN card) A LAN is used to transfer data to the 9333 LAN COMMUNICATOR.

4. When Media is selected, the Storage method item appears.

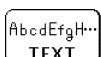

Function display	Meaning
	: When the media becomes full, automatic storage stops.
	: When the media becomes full, old files are deleted to make room for automatic storage.
	: With the binary format selected, the file with the extension 'MEM' is deleted, and if sequential save is selected, files with the extension 'SEQ' are also deleted. With the text format selected, files with the extension 'TXT' are deleted.

5. Move the flashing cursor to **type**, and select the format.

Function display	Meaning
	: Data are stored as binary data.
	: Data are stored as text data.

Data stored in the text format is not readable by the 8841/42.

6. When the data format to be saved is set to text data, the intermittent setting item is displayed. Use the function keys or Jog/Shuttle control to make a setting.

Function display	Meaning
	: Move the cursor up in the selection window.
	: Move the cursor down in the selection window.

7. Set the file name. For the input method, refer to Section 9.9.3.

When using auto-save, a number is appended to the name you specify as the file name. This then becomes the file name. If you start procedures before specifying a file name, AUTO is automatically enabled.

File names cannot contain the characters +, -,], or [. Please note that file names containing these characters will not be saved.

NOTE

- File names consist of 8 characters (or 4 double-byte characters). With auto-save, since numbers are attached to the end of file names, long file names are truncated when this number is appended to the end of the file name.
- When auto-save is enabled, the storage channel cannot be selected. Data for the channel for which the waveform is displayed is saved.
- When both auto-print and auto-save are enabled, auto-save usually takes precedence. However, if roll mode is enabled, auto-print will execute first.
- For details on connected SCSI device, refer to Section 14.4.
- When cursor A and B are enabled, partial saving is executed.
- During automatic storage, if the **STOP** key is pressed twice to interrupt measurement, waveforms taken prior to the interruption are stored automatically.
- The directory and the number of files that can be stored in the directory are limited. For details, see Section 14.7.
- When "COMMUNI" (communications) is selected as Media, Storage Method and Type are not displayed.



4.3.10 Setting the Overlay Function

- Overlay is performed without clearing the currently displayed waveform (if trigger mode is REPEAT or AUTO). This allows comparison to the immediately preceding waveform.
- If trigger mode is SINGLE, measurement terminates after one set of data has been collected. Therefore the overlay setting is invalid.

Procedure

Screen: STATUS1

1. Press the **STATUS** key to display the STATUS1 screen.
2. Move the flashing cursor to the **overlay** item.
3. Use the function keys to make a setting.

Function display	Meaning
	: Overlay is not performed.
	: Overlay is performed.

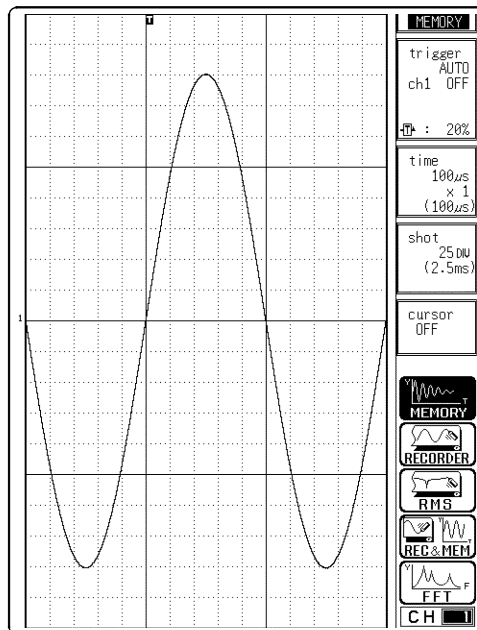

Normal Display

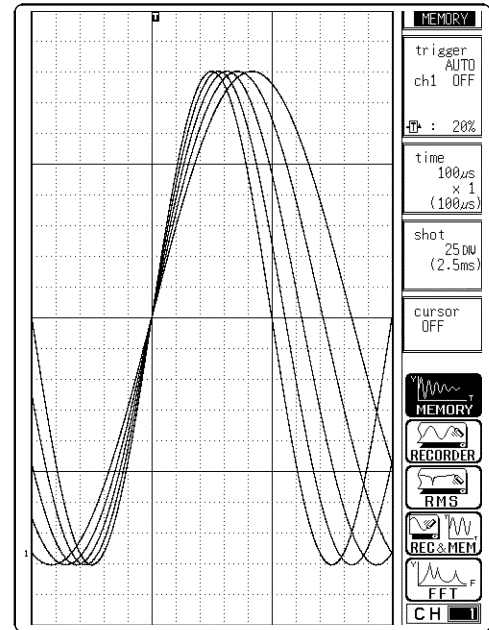

Overlaid Display

NOTE

- While overlay is being executed, operations on the display screen (waveform scrolling, change in time-axis magnification/compression ratio, change in zero position, and jumping to another display screen using VIEW function (see Section 11.6)) are disabled.
- When manual printing or trace cursor reading carried out, only the last waveform will be done.
- Use Report Print to print overlaid waveforms. (See Section 13.6.7, "Report Print.")
- If one of the following settings is changed, the overlay waveform display terminates and only the last waveform is shown:
 - STATUS1: Display format
 - CHANNEL: Input settings
- The overlay function cannot be set together with roll mode.

4.3.11 Setting the Averaging Function

- The averaging function allows capturing several instances of a waveform and determining the average.
- This makes it possible to eliminate noise and irregular signal components.
- The higher the number of averaging instances, the more effectively will noise be suppressed.

Procedure

Screen: STATUS1

1. Press the **STATUS** key to display the STATUS1 screen.
2. Move the flashing cursor to the **averaging** item.
3. Use the function keys or Jog/Shuttle control to make a setting.

Function
display Meaning



: Move the cursor up in the selection window.



: Move the cursor down in the selection window.

After starting the measurement, the averaging count and the current waveform data count are shown on the screen.

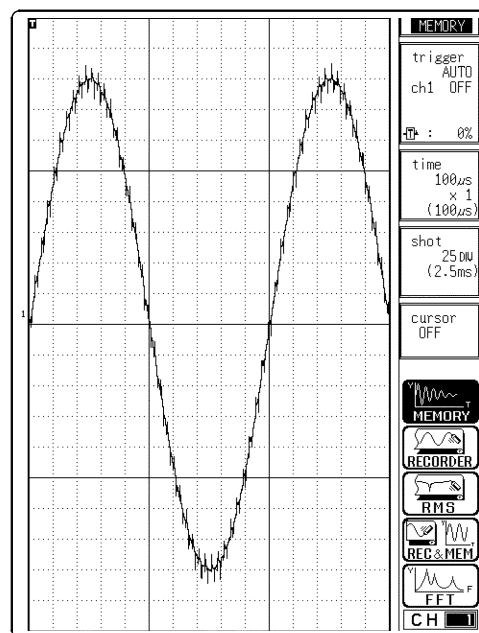

Before Averaging

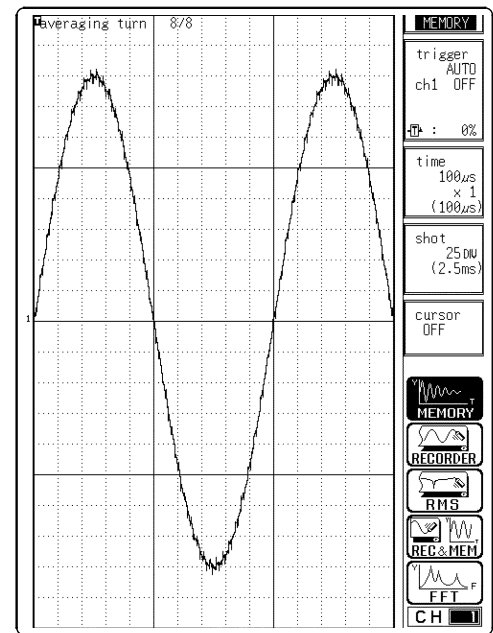

After Averaging

NOTE

- When the averaging function is used, logic waveform is not displayed.
- When the memory segmentation function is used, averaging is not available.
- Averaging and waveform processing cannot be carried out simultaneously.
- The averaged waveform becomes available for waveform processing when the averaging setting is turned OFF following measurement.
- When the averaging function is used, the maximum recording length is reduced to 25% of the normal value.

Averaging and trigger mode

(1) Trigger mode: SINGLE

1. After the **START** key was pressed, data are captured whenever the trigger conditions are fulfilled, and summing averaging is carried out.
2. When the specified number of data has been captured, measurement stops automatically.
3. If the measurement was stopped prematurely with the **STOP** key, the averaging result up to that point is displayed.

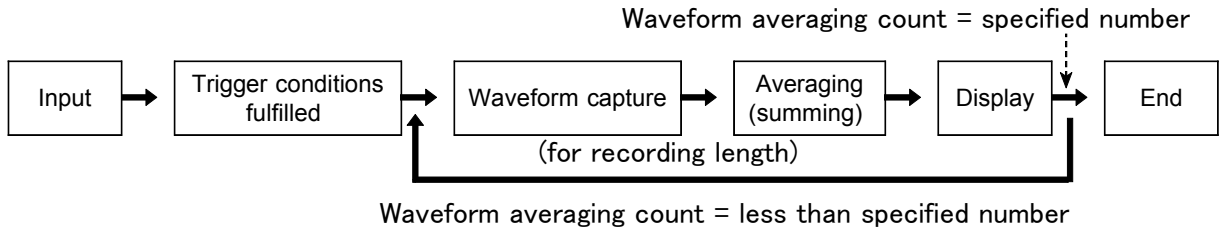

(2) Trigger mode: REPEAT

1. After the **START** key was pressed, data are captured whenever the trigger conditions are fulfilled, and summing averaging is carried out until the specified averaging count. The averaging result is shown on the display.
2. After the specified averaging count was reached, exponential averaging is carried out whenever data are captured, and the averaging result is shown on the display.
3. If the measurement was stopped prematurely with the **STOP** key, the averaging result up to that point is displayed.

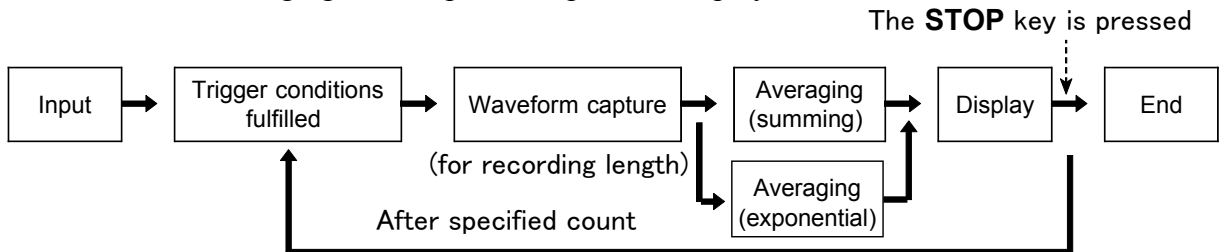

(3) Trigger mode: AUTO

When the **START** key is pressed, data are captured even if trigger conditions are not fulfilled after a certain interval. If averaging is applied to unsynchronized input signals, the result will be meaningless.

NOTE

For details on summing averaging and exponential averaging, refer to Appendix 3.6.

4.3.12 Setting the Waveform Evaluation

- Display format can be set on single screen or X-Y single screen.
- GO (pass) or NG (fail) evaluation of the input signal waveform can be performed using an evaluation area specified by the user. This can serve to detect irregular waveforms. After the evaluation result is generated, signals are output from the GO/NG terminal. All the channels being displayed are evaluated.

NOTE

- When a waveform evaluation area is created by the memory recorder function, the waveform evaluation area created by the FFT function is cleared.
- For details on the waveform evaluation, refer to Section 16.3.

4.4 Using the X-Y Waveform Plots (MEM)

- Setting the display format to X-Y in status screen allows X-Y waveforms to be combined. Any of channels 1 to 16 can be selected for each of the X and Y axis. Up to four X-Y plots can be made simultaneously.
- Voltage axis magnification/compression is active also when using X-Y combined plotting.
- Using the A·B cursors, it is possible to specify the data between the cursors for partial plotting.

X-Y Single

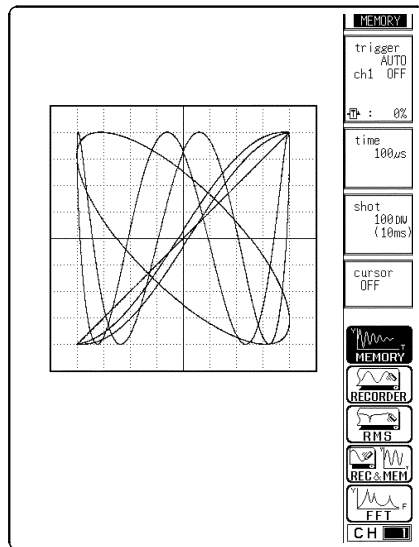

A single plot is displayed and recorded. X-Y waveforms of graphs 1 to 4 are displayed in one screen.

X-Y Dual

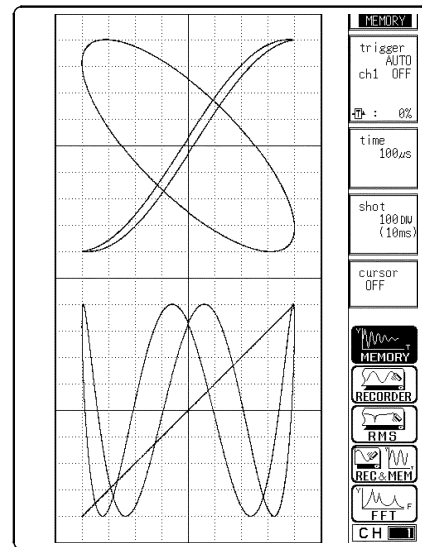

Two single plot is displayed and recorded. X-Y waveforms of graphs 1 and 3 are displayed in the upper section, and those of graphs 2 and 4 are displayed in the lower section.

X-Y(dot)

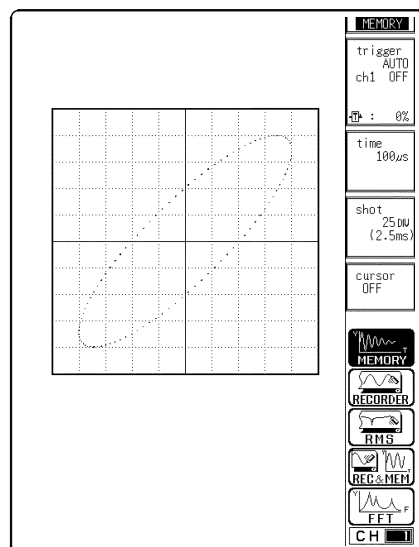

- The sampled data is displayed and recorded just as it comes.
- Linear interpolation is not performed.

X-Y(line)

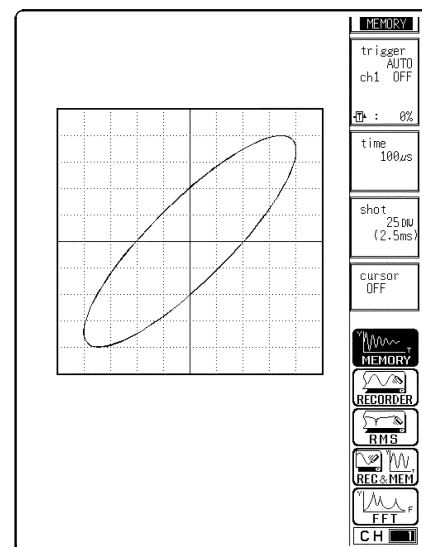

- Linear interpolation is performed.
- The display becomes easier to read, but display speed is slower compared to dot display.

ProcedureScreen: STATUS1

1. Press the **STATUS** key to display the STATUS1 screen.
2. Move the flashing cursor to the **format** item.
3. Use the function keys to select the **X-Y single** or **X-Y dual** format.
4. Set the interpolation. (See Section 4.3.5)
5. Press the **CHAN** key to display the CHANNEL screen.
6. Press the **CH.SET** key to display page 3/3.
7. Move the flashing cursor to desired channel, and use the function keys to set the waveform color (including displays waveform ON/OFF).

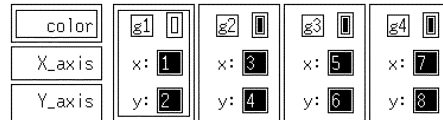

Function
display

Meaning



: Move the cursor up in the selection window.



: Move the cursor down in the selection window.



: Waveform is performed.



: Waveform is not performed.

8. Specify the X-axis channel.
Move the cursor to the channel to be used as X axis. And use the function keys or the Jog/Shuttle control to select X axis.
9. Specify the Y-axis channel.
This is done in the same way as the X-axis setting.
10. For graph 2 to graph 4, the settings are made in an identical.

Partial X-Y plot

Using the A·B cursors, it is possible to specify a range for partial X-Y plotting. (Normal X-Y plotting covers all data of the recording length.)

ProcedureScreen: Waveform display (excluding X-Ysingle and X-Ydual)

1. Display the captured waveform data, using a format other than X-Ysingle and X-Ydual.
2. Use the A·B cursors to specify the desired portion for plotting (see Section 11.2).
3. Press the **STATUS** key to display the STATUS1 screen.
4. Carry out combined plotting as described above.

In partial X-Y plot, the screen displays the period of time passed after the completion of the trigger specified using the cursors A and B.

Switching the X-Y1 Screen Display (Wide Display)

Setting the display format to X-Y1 in the STATUS1 screen allows you to switch between wide screen display and normal screen display each time you press the **DISP** key.

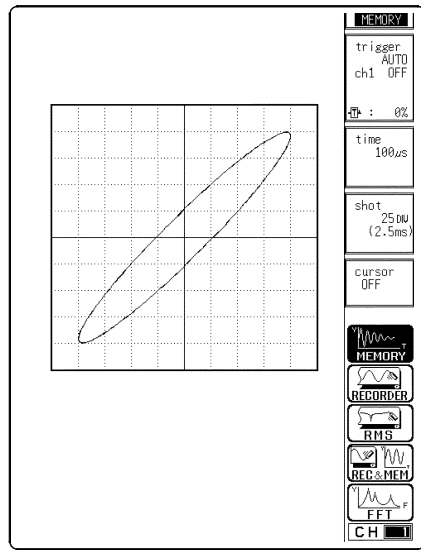

Normal Display Screen

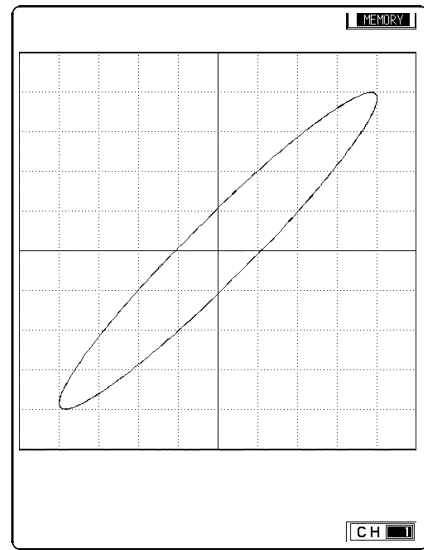

Wide Display Screen

4.5 Settings on the Waveform Display Screen (MEM)

Explains the setting items on the Waveform display screen.

For details on setting, refer to Section 4.3.

When want to use the Jog/Shuttle control, press the **VALUE** select key. (The selection window is not displayed.)

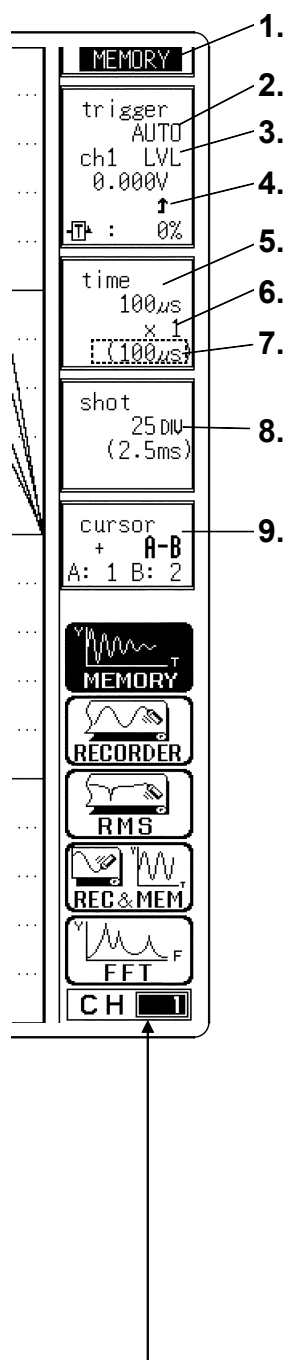

Setting items	Selection	Explanation
1. Function	MEM, REC, RMS, REC&MEM, FFT	Select function.
2. Trigger mode	SINGLE, REPEAT, AUTO	Select trigger mode.
3. Analog trigger	OFF, LEVEL, OUT, IN, V-DROP, CYCLE	Set the analog trigger.
4. Pre-trigger	0 to 100%, -95%	Set the Pre-trigger.
5. Time Axis Range	100 μs/DIV to 5 min/DIV, EXT	Set the speed for inputting and storing the waveform of the input signal. Time axis range setting expresses the time for 1 DIV.
6. Magnification/compression along the time axis	× 10 to × 1/10000	By magnifying the waveform, detailed observations can be made. By compressing the waveform, an entire change can be promptly apprehended.
7. Zoom function	Changes in the magnification in the range of × 1/5000 to × 10	Splits the Waveform display screen into two halves, upper and lower screens, expanding the waveform in the upper screen along the time axis and displaying the expanded waveform in the lower screen.
8. Recording Length	SELECT: 25 DIV to 5000 DIV ARBITRARY: 1 DIV to 5000 DIV	Using channels: 16 ch Capacity: 8 M words The length of recording for one measurement operation (the number of DIV) can be set.
9. Cursor Measurement	OFF, ↔, ↕, +	The A·B cursors can be used.
Input channel settings	Analog input Logic input X, Y axis (X-Y format)	Enables the measurement conditions for each channel on the display screen to be set or changed. See Section 9.10.
Input level monitor function		Press the LEVEL MONI key. See Section 11.5.
VIEW function		Press the VIEW key. See Section 11.6.

Channels that may be changed with the **RANGE** knob (measurement range) and **POSITION** knob (zero position). This channel display is selected with channel-select keys CH1 to CH16.

Changing the set channel in the CHANNEL or CH.SET screens modifies the setting accordingly.

4.6 Auto Range Function



This function automatically selects the time axis range, measurement range and zero position.

Taking the lowest numbered channel among the channels for which waveform display is on, 1 to 2.5 cycles are automatically set to be recorded as 15 divisions.

Procedure

Screen: Waveform display

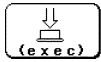
1. Press the **DISP** key to display the Waveform display screen.
2. Press the **AUTO** key.
3. Use the function keys to make a setting.

Function display	Meaning
	: Execute the Auto Range function.
	: Cancel the Auto Range function.

If measurement has started using the auto-range function:

- Conditions related to the input units (all channel)

Voltage axis range, zero position	Value set automatically
Magnification/compression ratio along the voltage axis	Single screen: × 1 Other screens: × 1/2
Low-pass filter, Input coupling	OFF, DC

- Trigger conditions (one channel only)

Trigger mode	AUTO
AND/OR for internal trigger and external trigger	OR
Pre-trigger	20%
Internal trigger	Enables only the waveform display channel with the lowest number. (If the difference between maximum and minimum is 2 divisions or less, the next channel is enabled.)
Trigger type : Level	Slope: \uparrow rising Trigger level: value set automatically Filter: OFF

- Status conditions

Time axis range (time/div)	Value set automatically Magnification/compression ratio: × 1
Memory segmentation	OFF

NOTE

- Because the auto-range function performs automatic setting for the input signal present at the time the function is executed, input a signal before executing the function.
- If for the input signal for this channel there is only a small difference between the maximum value and the minimum value in the range of highest sensitivity (5 mV/DIV), the setting is made by taking the next higher channel.
- If the range cannot be determined, for all channels for which the waveform display is on. A warning message appears, and measurement is abandoned.
- When the auto range function is activated by pressing the **AUTO** key, a trigger output signal is generated. This should be taken into consideration when using both the trigger output and the auto range function.
- The auto-range function does not operate on channels for which the CHARGE or PREAMP measurement mode is selected on the 8947 CHARGE UNIT.

4.7 Other Screen Settings

The status screen for the memory recorder function contains three more setup screens. For detailed setup procedures, see the associated sections.

STATUS2 screen: Memory Segmentation Screen (See Chapter 15)

STATUS3 screen: Parameter Calculation Screen (See Section 16.1)

STATUS4 screen: Calculating Waveform Data Screen (See Section 16.2)

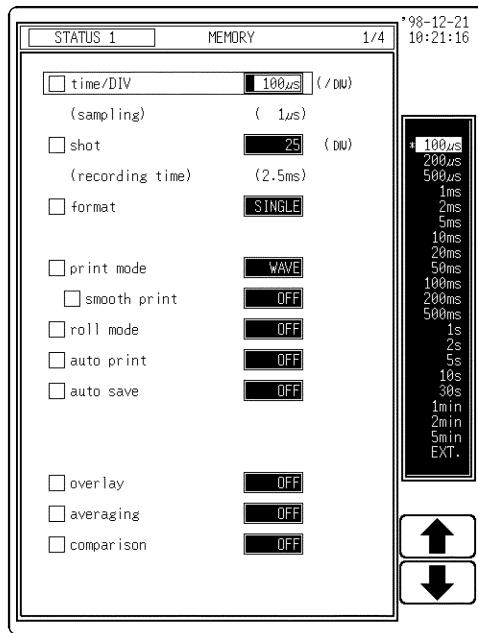

STATUS 1 Screen

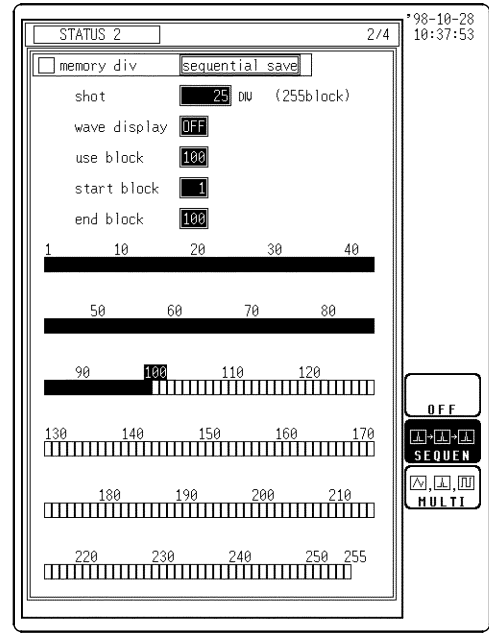

STATUS 2 Screen

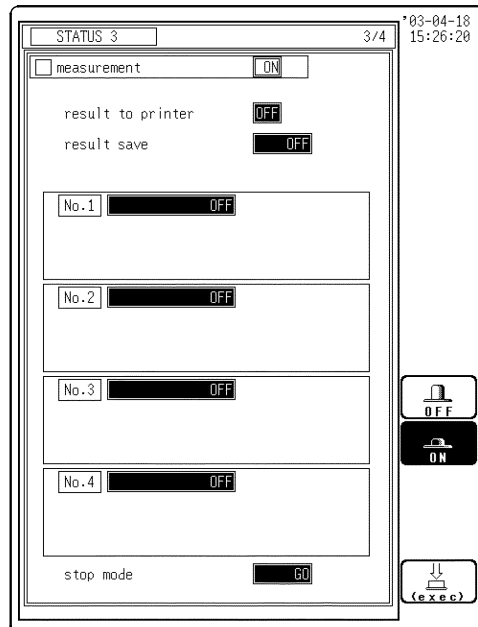

STATUS 3 Screen

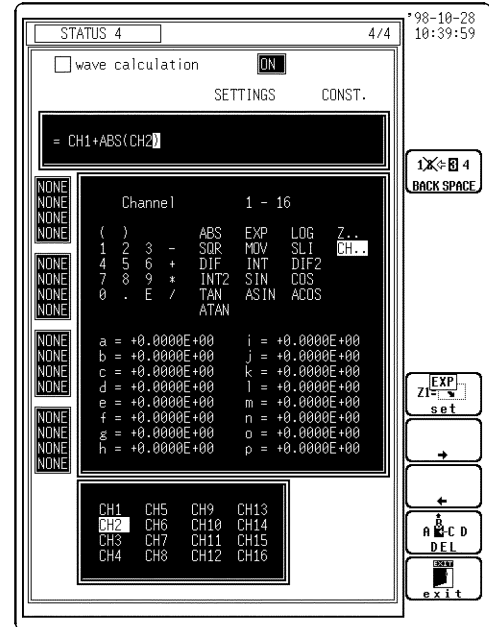

STATUS 4 Screen

NOTE

The STATUS screen can also be changed from the function display field "1/4" on the upper right of the STATUS screen.

4.8 Start and Stop Operation (MEM)

Setting the 8841/42
STATUS Settings
Channel Settings
Trigger Settings

See Section 4.3, "STATUS Settings", Chapter 9, "Input Channel Settings", Chapter 10, "Trigger Functions."

Measurement start

Press the **START** key and LED light.

When the pre-trigger is set, the trigger will not be registered for a certain period after the start of measurement. (During this interval, "Pre-trigger standby" is shown on the display.)

When the trigger can be registered, the indication "Waiting for trigger" is shown on the display.

Trigger condition
are met

Data recording starts when trigger condition are met.

When trigger mode selected AUTO, unit waits for about 1 second for trigger conditions to be met. After this interval, data recording starts, regardless of trigger state.

Recording start

Displays "Storing".

When roll mode is set to ON, the waveform is displayed (scrolling) immediately at the start of recording

Using the **VIEW** key to display the time (from measurement started time).

When the **STOP** key is pressed twice during measurement, the 8841/42 is forcibly stopped. Then the waveform data until the **STOP** key is pressed is displayed and saved. When the auto saving is set to ON, the data until a forced termination is automatically saved. (Auto printout is not executed.)

Recording end

Waveform displays after data corresponding to recording length have been stored in memory.

Auto printout and auto save are executed.

Measurement end

End of measurement

Trigger mode SINGLE
 REPEAT
 AUTO

Each time when trigger conditions are met, data are recorded and memory contents are overwritten.

End of measurement in REPEAT and AUTO trigger modes

When the **STOP** key is pressed once during measurement, the 8841/42 acquires measurement data in an amount corresponding to the set recording length, and the measurement is stopped. (Waveform display, auto printout, and auto save are executed.)

When the time axis range is set to the slow range (not more than 10 ms/DIV), the waveforms measured until the **STOP** key is pressed are displayed.

When the time axis range is set to the fast range (greater than 10 ms/DIV), waveforms are not displayed. (Waveforms are displayed only if measured data having recording length equal to the previous setting exist.)

Chapter 5

Recorder Function

5.1 Overview of the Recorder Function

The recorder function has the following features.

- (1) Real time display and printing of the input signal
- (2) Real time continuous recording of the input signal
- (3) All input channel data are recorded on the same time axis.
Since data for all channels can be superimposed, the relative relationship between input signals can be observed visually.
- (4) Time axis setting
20 ms/DIV to 1 h/DIV
- (5) Time axis resolution 100 points/DIV (printer)
- (6) Sampling period
1, 10, 100 μ s, 1, 10, 100 ms (Can be selected, from 1/100 of the time axis setting)
- (7) Memory capacity
 - 8 M words: 2000 DIV
 - 32 M words: 10000 DIV
 - Arbitrarily (Set from 1 division to the maximum number of divisions at 1-division intervals)
- (8) Waveform magnification/compression display and printout
 - Time axis direction: $\times 1$ to $\times 1/500$
 - Voltage axis direction: $\times 10$ to $\times 1/2$ (single)
 $\times 5$ to $\times 1/4$ (dual to hex, X-Y single/dual) 5 steps
 - With the variable function, vernier function
- (9) Display format
 - Time axis waveform: single, dual, quad, oct screen display (LCD), hex screen display (printer only)
 - X-Y waveform: single, dual

(10) Scrollable display

- The most recent 2000 (32 M words: 10000) divisions of the data are stored in memory.
- It is possible to scroll back for easy review.

(11) Additional recording function

- The first set of measurement data is preserved, and recording of the second set of measurement data starts after the first set.

(12) Logging function

Numeric printout of waveform data.

(13) Reprint function

The most recent 2000 (32 M words: 10000) divisions of the data stored in memory can be printed as many times as required.

(14) Print

Real-time print, manual print, partial print, report print, screen hard copy can be printed.

(15) X-Y CONT Recorder

This function allows X-Y plot between channels in real time.

5.2 Operation Sequence (REC)

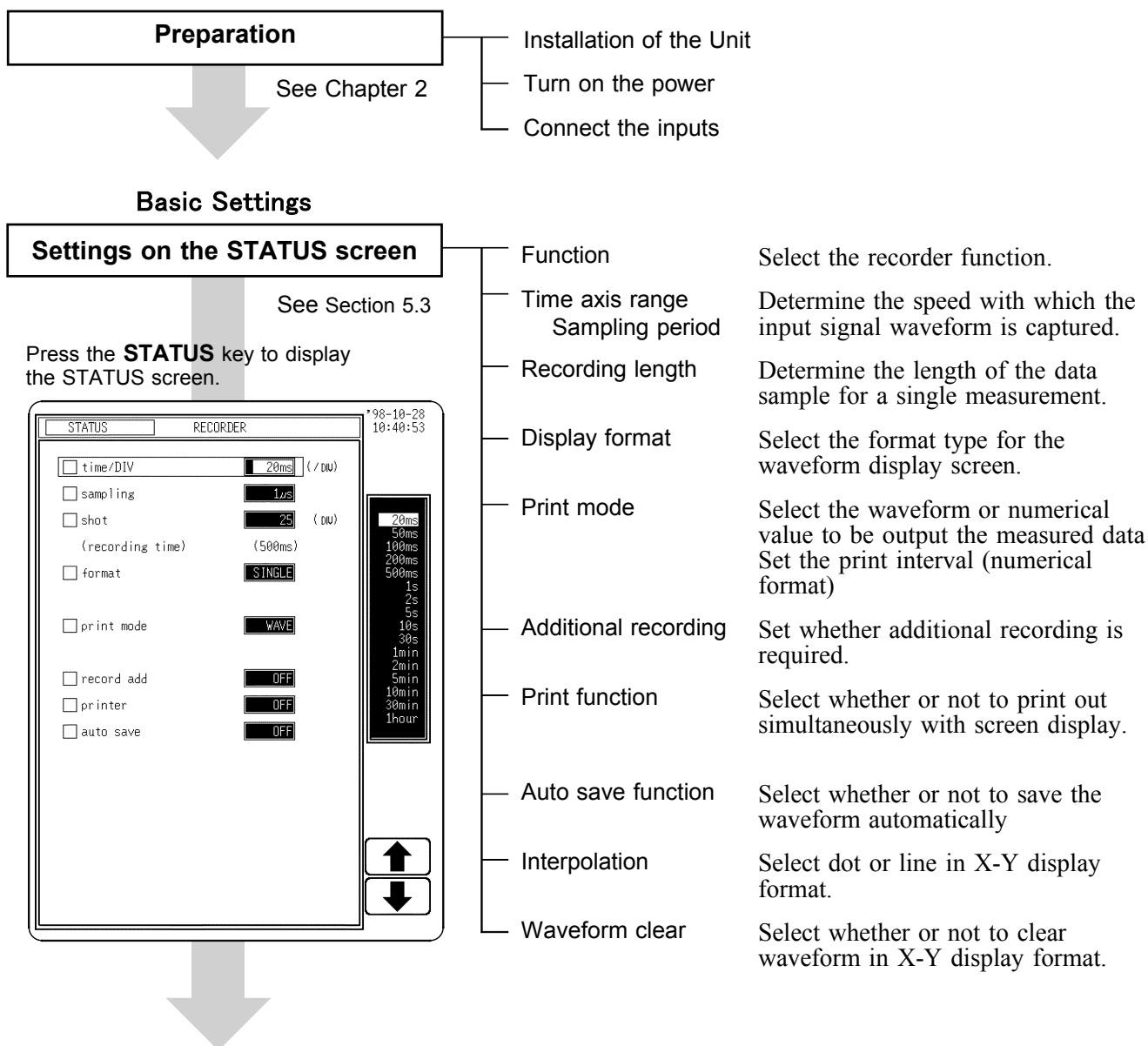

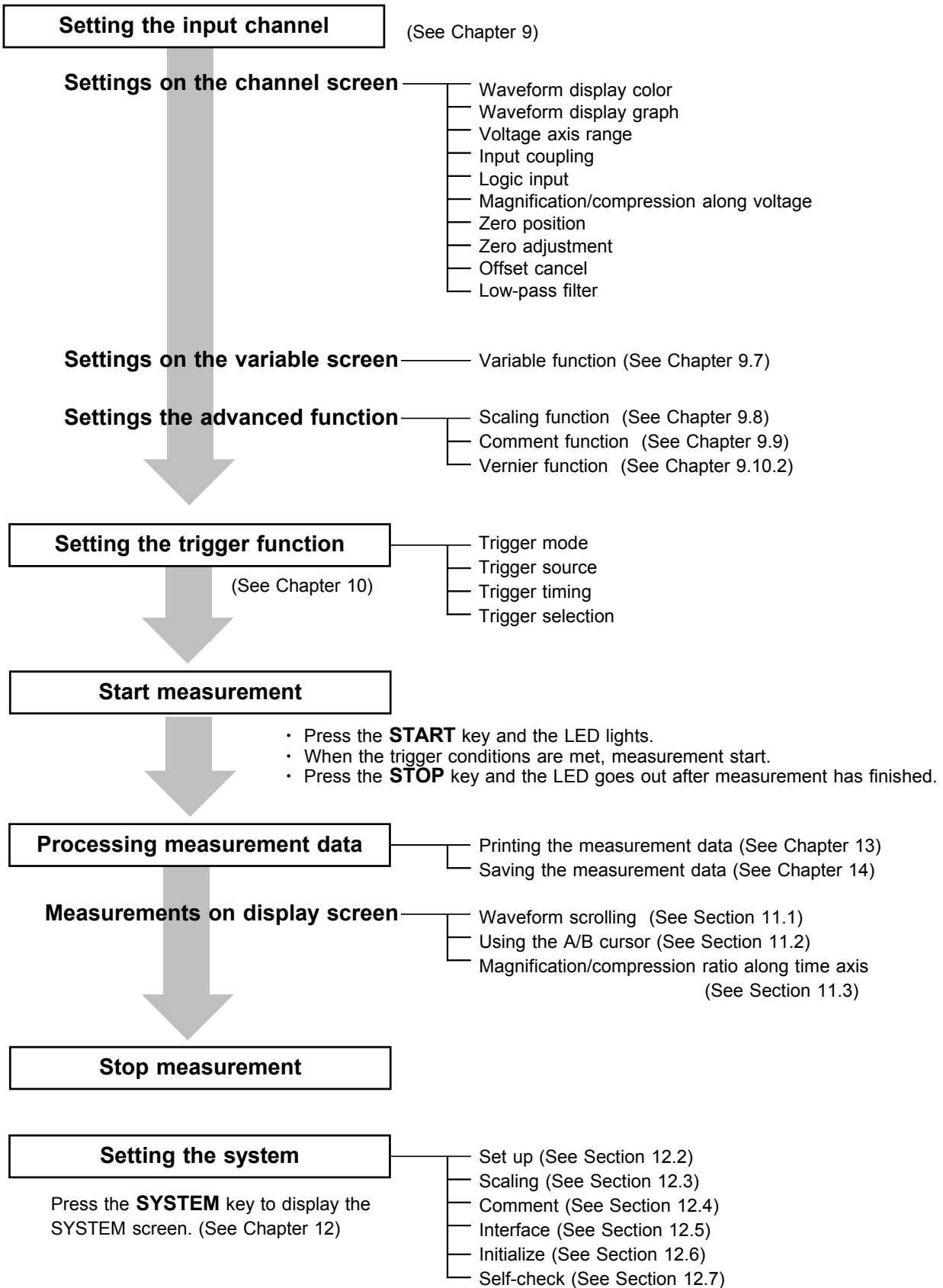

5.3 STATUS Settings (REC)

Press the **STATUS** key to access the STATUS screen. This section explains how to set the STATUS screen of the recorder function. See the corresponding sections for items that can be set in the Waveform display or CHANNEL screens.

Waveform display screen: see Section 5.5

CHANNEL screen: see Section 9.3

The screenshot shows the STATUS RECORDER screen with the following settings and callouts:

- STATUS RECORDER (top bar)
- *00-01-05 13:53:25 (top right)
- time/DIV: 20ms (-7DIV) (5.3.2)
- sampling: 1μs (5.3.3)
- shot: 25 (DIV) (5.3.4)
- (recording time) (500ms)
- format: SINGLE (5.3.5)
- print mode: LOGGING (5.3.6)
- interval: 1 DIV (5.3.6)
- record add: OFF (5.3.7)
- printer: OFF (5.3.8)
- auto save (means): FLOPPY SAVE (5.3.9)
- type (file name): TEXT AUTO (5.3.9)
- thin out: OFF (5.3.9)
- MEMORY (5.3.11)
- RECORDER (5.3.11)
- RMS (5.3.11)
- REC & MEM (5.3.11)
- FFT (5.3.11)

See Sections 5.3.1, 5.3.2, 5.3.3, 5.3.4, 5.3.5, 5.3.6, 5.3.7, 5.3.8, 5.3.9, 5.3.10 (when format:X-Y), 5.3.11 (when format:X-Y)

NOTE

The settings in Section 5.3.10 and 5.3.11 are displayed only when the display format has been set to "X-Y."





5.3.1 Setting the Function Mode

The 8841/42 has five function modes. Select the Recorder function.

Procedure

Screen: STATUS, CHANNEL, Waveform display, TRIGGER

1. Use the Menu keys to display the desired screen.
2. Move the flashing cursor to the top position.
3. Select the **RECORDER** function key display.

Function display	Meaning
	: Memory recorder function
	: Recorder function
	: RMS recorder function
	: Recorder & Memory recorder function
	: FFT function

5.3.2 Setting the Time Axis Range

Set the speed for inputting and storing the waveform of the input signal. Time axis range setting expresses the time for 1 division.

Screen: STATUS, Waveform display

Procedure 1

1. Use the Menu keys to display the desired screen.
2. Move the flashing cursor to the **time/DIV** item.
3. Use the Jog/Shuttle control, the function keys or the **TIME/DIV** key to make the selection.

Procedure 2

Using the TIME/DIV key

1. Use the Menu keys to display the desired screen.
2. Use the **TIME/DIV** key to make the selection.
The **TIME/DIV** key can be used regardless of where the flashing cursor is located.

NOTE

While the printer always outputs the data at the measurement magnification in recording mode, the waveform on the screen is reduced in size at the ratio shown in the table below, depending on the time-axis range.

50 ms/DIV × 1/2, 20 ms/DIV × 1/10

The symbol "*" in the selection window indicates the time axis of the data stored to current memory. (If no data is present in memory, this symbol is not displayed.)



5.3.3 Setting the Sampling Period

The available range depends on the selected time axis range (input signal waveform capture rate).

Procedure

Screen: STATUS

1. Use the Menu keys to display the desired screen.
2. Move the flashing cursor to the **sampling** item.
3. Use the Jog/Shuttle control or the function keys to make the selection.

Function display	Meaning
	: Increases in number.
	: Decreases in number.

NOTE

When a short sampling period is set and the input waveform changes slightly, a sudden disturbance such as noise will increase the difference between the maximum and minimum values. To eliminate this phenomenon, set a long sampling period. For details, see Appendix 3.4.

5.3.4 Setting the Recording Length

The length of recording for one measurement operation (number of DIV) can be set.

SELECT Select the recording length.



ARBITRARY Variable recording length can be selected by the user.

Screen: STATUS, Waveform display

Procedure 1



Constant recording length mode

1. Use the Menu keys to display the desired screen.
2. Move the flashing cursor to the **shot** item and select **SELECT**.
3. Use the Jog/Shuttle control or the function keys to make a setting.

Function display	Meaning
	: Move the cursor up in the selection window.
	: Move the cursor down in the selection window.

Procedure 2 Variable recording length mode

1. Use the Menu keys to display the desired screen.
2. Move the flashing cursor to the **shot** item and select **ARBITRARY**.
3. Use the Jog/Shuttle control or the function keys to make a setting. To change the column, use the cursor keys (◀ ▶).

Function display	Meaning
	: Increases in number.
	: Decreases in number.

NOTE

- When the recording length is set to **CONT.** in a range of 20 ms to 200 ms/DIV, the printer setting (real-time print) is automatically set to OFF.
- When the recording length is set to **CONT.**, auto-saving is automatically set to OFF.
- The maximum recording length is 2000 DIV when the memory capacity is 8 M words, and 10000 DIV when the memory capacity is 32 M words (when memory extended)
- In fixed-length recording mode, the symbol "*" in the selection window indicates the recording length of the data stored to current memory. (If no data is present in memory, this symbol is not displayed.) In any recording-length mode, the symbol "#" is displayed before the recording length.

5.3.5 Setting the Display Layout

- The layout can be set for showing input signals on the screen display and recording them on the printer.
- The following layout is available: single, dual, quad, oct (Waveform display screen), hex (Print only, Display oct style) X-Y single, X-Y dual (dot/line)
- The voltage per division is automatically changed according to the display format.

Procedure Screen: STATUS

1. Press the **STATUS** key to display the STATUS screen.
2. Move the flashing cursor to the **format** item.
3. Use the function keys to select the display format.
4. Set the graph type when the display format is set to DUAL, QUAD, OCT or HEX screen display.
5. Press the **CHAN** key to display the CHANNEL screen.
6. Move the flashing cursor to the point in the figure below.
The figure shows the setting for the channel 1 (CH1). Setting for the channel 2 to 16 should be made in the same way.

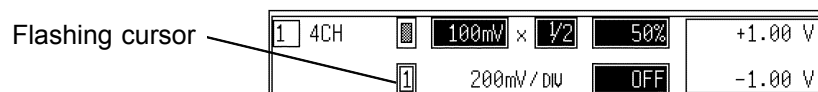

7. Use the function keys to select.

Function display	Meaning
------------------	---------



: Move the cursor up in the selection window.



: Move the cursor down in the selection window.

In the cases of HEX, as far as the printer recording output is concerned, the waveforms for each channel are automatically distributed on each graph according to the table below:

For details on logic channels, refer to Section 9.3.8.

Graph	Analog channel	Graph	Analog channel
1	CH 1	9	CH 9
2	CH 2	10	CH 10
3	CH 3	11	CH 11
4	CH 4	12	CH 12
5	CH 5	13	CH 13
6	CH 6	14	CH 14
7	CH 7	15	CH 15
8	CH 8	16	CH 16

Single graph

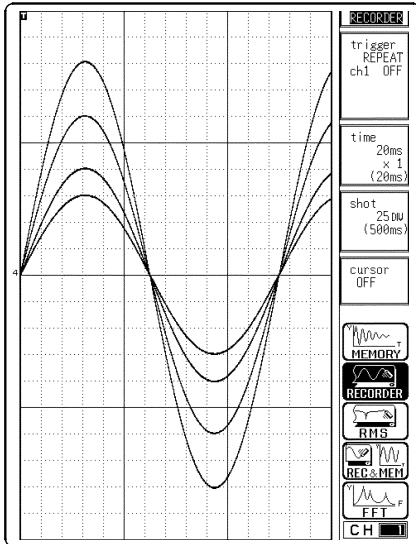

Display and record as one graph.
(At the most, 16 analog + 16 logic signals)

Dual graph

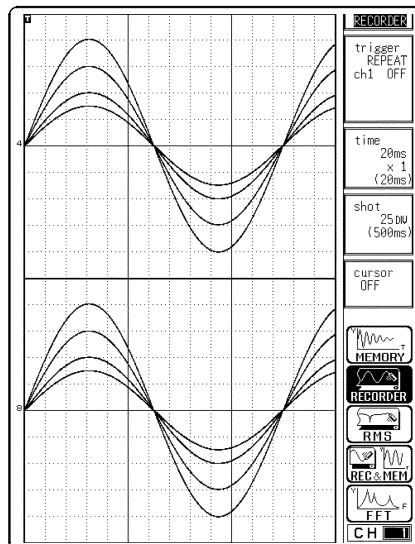

- Display and record as two graphs. (At the most, 16 analog + 16 logic signals)
- Specify which input channel to use for waveform graph display and recording.

Quad graph

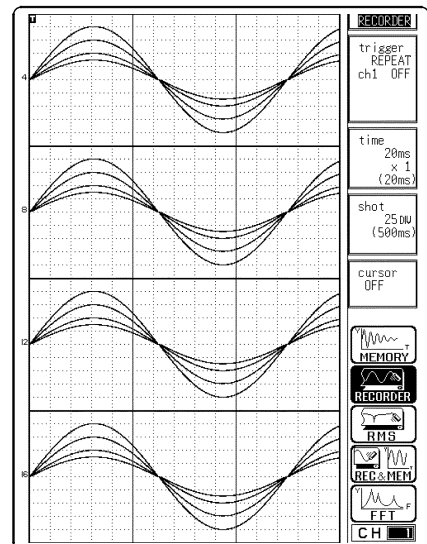

- Display and record as four graphs. (At the most, 16 analog + 8 logic signals)
- Specify which input channel to use for waveform graph display and recording.

Oct graph

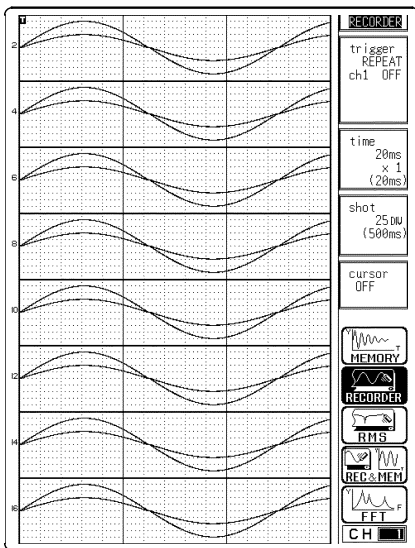

- Record as eight graphs. (At the most, 16 analog + 4 logic signals)
- Specify which input channel to use for waveform graph display and recording.

X-Y single graph (dot)

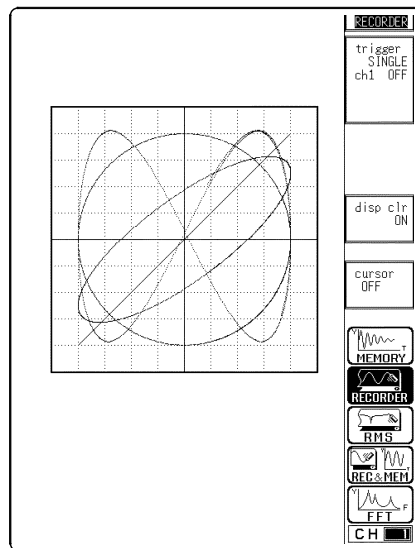

X-Y dual graph (line)

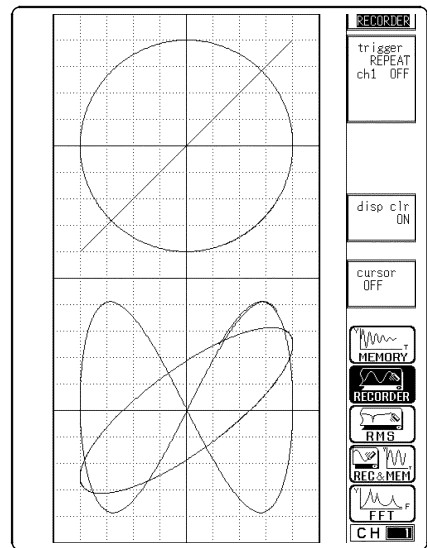

HEX graph

- Display is same as Oct screen display.
- Record as sixteen graphs. (At the most, 1 analog + 2 logic signals)
- Channel positions are automatically distributed.

5.3.6 Setting the Print Mode

Select the format, waveform, or numerical value should be used to output measured data.

Waveform The waveform is printed.

Numerical value The data spacing interval also must be set.

Procedure Screen: STATUS

(1) Setting the printer format

1. Press the **STATUS** key to display the STATUS screen.
2. Move the flashing cursor to the **print mode** item.
3. Use the function keys to make a setting.

Function
display

Meaning



: Measurement data and the result of calculation are printed as a waveform.



: Measurement data and the result of calculation are printed as numeric data.

(2) Setting the print interval

1. When the numerical value is selected, set the print interval. (unit: DIV)
2. Move the flashing cursor to the **interval** item.
3. Use the function keys to make a setting.
Since 1 division represents 100 samples, the print interval "0.01" refers to a printout of every sample (no print interval).
When the print interval longer than the recording length is set, only the first dot is printed.

Function
display

Meaning



: Move the cursor up in the selection window.



: Move the cursor down in the selection window.

NOTE

- The maximum and minimum values are printed (see Appendix 3.4).
- The print intervals of 0.01 to 0.5 DIV can be selected, only when there are waveform data present.
- When numerical values are output for real-time printing, the minimum print interval is 1 division.

5.3.7 Setting the Additional Recording Function

This records, regarding the memory as though it were recording paper.

The memory capacity of 8 M words can accommodate up to 2000 divisions of waveform data. With 32 M words (after optional memory expansion), waveform data of up to 10000 divisions can be saved.

The waveform can be scrolled and printed out.

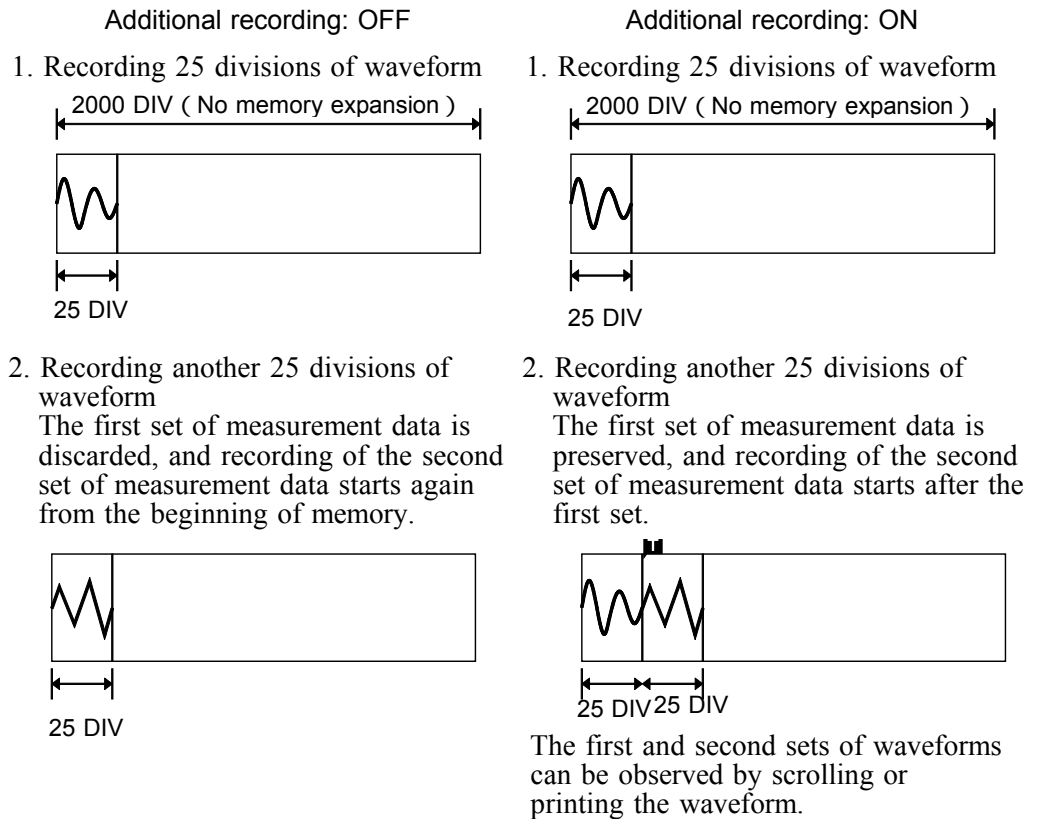

Switching the additional recording on and off affects the use of memory as shown below.



Procedure

Screen: STATUS

1. Press the **STATUS** key to display the STATUS screen.
2. Move the flashing cursor to the **record add** item.
3. Use the function keys to make a setting.

Function display	Meaning
	: Additional recording is disabled.
	: Additional recording is enabled.

NOTE

- Time values output to the printer and displayed on the screen with the additional recording function enabled are equal to those of the most recently acquired waveforms. Therefore, when measuring waveforms in a different time axis range, always take that difference into consideration.
- When the 2000 (32 M words: 10000) DIV has been reached, old data will be overwritten.
- In the recorder, the trigger mark (■) is written as the start position mark. In an additional recording, the trigger mark is displayed in front of the most recently entered data.
- If auto-save is enabled, only newly acquired waveforms are saved. Even when A and B cursors appear on the screen, no partial save is performed, because the setting is disabled when the **START** key is pressed.



5.3.8 Setting the Printer Function (Real Time Printing)

The input waveform is continuously printed in real time.

Procedure

Screen: STATUS

1. Press the **STATUS** key to display the STATUS screen.
2. Move the flashing cursor to the **printer** item.
3. Use the function keys to make a setting.

Function display	Meaning
	: Printing is disabled.
	: Printing is enabled.

NOTE







- At a time axis range setting of 200 ms/DIV or faster, the waveform data will be printed out later. See Section 18.5, "Recorder Function."
- While the printer always outputs the data at the measurement magnification in recording mode, the waveform on the screen is reduced in size at the ratio shown in the table below, depending on the time-axis range.
50 ms/DIV: $\times 1/2$, 20 ms/DIV: $\times 1/10$

5.3.9 Setting the Auto Save Function



- When the function is enabled, measurement data are automatically stored on a floppy disk, PC card, MO disk or connected SCSI device after they are captured.
- The Auto Save function stores a file in the directory currently selected on the file screen. See Section 14.12.2.

Procedure Screen: STATUS



1. Press the **STATUS** key to display the STATUS screen.
2. Move the flashing cursor to the **auto save** item.
3. Use the function keys, select the media for auto saving.

Function display	Meaning
	: Auto save is disabled.
	: Automatically stored on floppy disk
	: Automatically stored on PC card.
	: Automatically stored on connected SCSI device.
	: Automatically stored on MO disk.
	: (When using a LAN card) A LAN is used to transfer data to the 9333 LAN COMMUNICATOR.

4. When Media is selected, the Storage Method item appears.

Function display	Meaning
	: When the media becomes full, automatic storage stops.
	: When the media becomes full, old files are deleted to make room for automatic storage. With the binary format selected, the file with the extension 'REC' is deleted. With the text format selected, files with the extension 'TXT' are deleted.

5. Move the flashing cursor to **type**, and select the format.

Function display	Meaning
	: Data are stored as binary data.
	: Data are stored as text data.

Data stored in the text format is not readable by the 8841/42.

6. When the data format to be saved is set to text data, the intermittent setting item is displayed. Use the function keys or Jog/Shuttle control to make a setting.
7. Set the file name. For the input method, refer to Section 9.9.3.
When using auto-save, a number is appended to the name you specify as the file name. This then becomes the file name. If you start procedures before specifying a file name, AUTO is automatically enabled.

File names cannot contain the characters +, -,], or [. Please note that file names containing these characters will not be saved.

NOTE

- File names consist of 8 characters (or 4 double-byte characters). With auto-save, since numbers are attached to the end of file names, long file names are truncated when this number is appended to the end of the file name.
- With auto-save enabled, channel selection is disabled. Data for all channels is saved.
- For details on file name of auto saving, refer to Section 14.7.
- When the recording length is "CONT.", data are not stored.
- For details on connected SCSI device, refer to Section 14.4.
- When cursor A and B are enabled, partial saving is executed.
- If additional recording is enabled, only newly acquired waveforms are saved. Even when A and B cursors appear on the screen, no partial save is performed.
- During automatic storage, if the measurement is interrupted, waveforms taken prior to the interruption are stored automatically.
- The directory and the number of files that can be stored in the directory are limited. For details, see Section 14.7.
- When "COMMUNI" (communications) is selected as Media, Storage Method and Type are not displayed.

5.3.10 Setting the Interpolation (dot-line, X-Y only)

- Interpolation can be set when set the X-Y graph format.
- This setting determines whether the input waveform (sampling data) is to be displayed and printed as a series of dots or a line using linear interpolation.

Procedure

Screen: STATUS

1. Press the **STATUS** key to display the STATUS screen.
2. Move the flashing cursor to the **dot-line** item.
3. Use the function keys to make a setting.

Function
display

Meaning

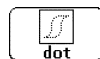

: Linear interpolation is not performed.



: Linear interpolation is performed.

5.3.11 Setting the Display Clear Function (X-Y only)

- It sets whether clear the waveform or not when pressing the **START** key to start measurement and the previous waveform is left.
- If the waveform is not cleared, overlay is performed.

Procedure

Screen: STATUS, Waveform display

1. Use the Menu keys to display the desired screen.
2. Move the flashing cursor to the **display clear** item.
3. Use the function keys to make a setting.

Function
display

Meaning



: Display clear is disabled.



: Display clear is enabled.

5.4 Using the X-Y CONT Recorder

Set "Display Format" to the X-Y single or X-Y dual screen in the STATUS screen to perform X-Y waveform plotting.

- (1) The same operation as a normal recorder is available to plot between channels (real-time X-Y recording).
- (2) Unlike an X-Y plot produced in the memory recorder function mode, the time axis information for each channel is not being recorded.
- (3) Any of channels can be selected for each of the X and Y axis. Up to four X-Y plots can be made simultaneously.
- (4) For dot display the sampling period is fixed at 300 μ s, while for line display the fastest sampling period is 300 μ s (unfixed).
- (5) There is no limit on the length of a recording because basically the operation is the same as that of a conventional recorder.
- (6) When the waveform clear is OFF, overlay can be performed.
- (7) Measurement data and setting data can be saved to media.

NOTE

- The waveforms with a display format that has been set to screens 1 to 16 cannot be subject to X-Y plotting following measurement. In addition, the waveforms measured by setting their display formats to the X-Y screen cannot be displayed on screens 1 to 16 following measurement.
- Trace cursor can not be used on the X-Y screen.
- Even if the interpolation type changes after completion of measurement, the dots and lines do not change.

X-Y Single

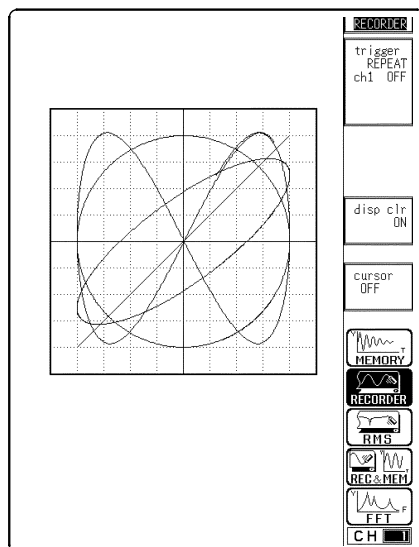

A single plot is displayed and recorded. X-Y waveforms of graphs 1 to 4 are displayed in one screen.

X-Y Dual

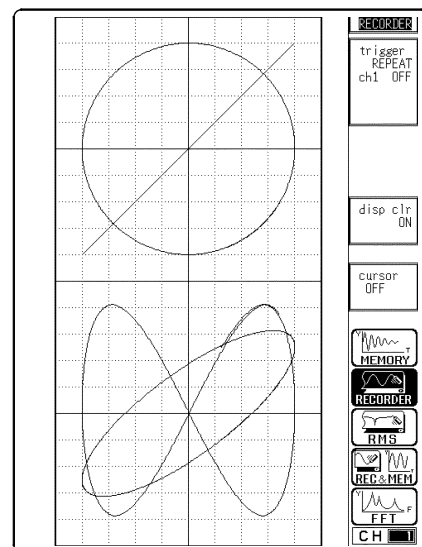

Two single plot is displayed and recorded. X-Y waveforms of graphs 1 and 3 are displayed in the upper section, and those of graphs 2 and 4 are displayed in the lower section.

5.4.1 Setting the Status Screen

(1) Setting the format

1. Press the **STATUS** key to display the STATUS screen.
2. Move the flashing cursor to the **format** item.
3. Use the function keys to make a setting. (See Section 5.3.5.)

(2) Setting the interpolation

1. Press the **STATUS** key to display the STATUS screen.
2. Move the flashing cursor to the **dot-line** item.
3. Use the function keys to make a setting. (See Section 5.3.10.)

(3) Setting the display clearing

1. Press the **STATUS** key to display the STATUS screen.
2. Move the flashing cursor to the **display clear** item.
3. Use the function keys to make a setting. (See Section 5.3.11.)

5.4.2 Setting the Channel Screen

Procedure

Screen: CHANNEL

1. Press the **CHAN** key to display the CHANNEL screen.
2. Press the **CH.SET** key to make a setting.
3. Move the flashing cursor to desired channel, and use the function keys to set the display waveform on/off and waveform color.

Function
display

Meaning



: Move the cursor up in the selection window.



: Move the cursor down in the selection window.

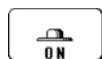

: Waveform is performed.



: Waveform is not performed.

4. Specify the X-axis channel.
Move the cursor to the channel to be used as X axis, and use the function keys or the Jog/Shuttle control to select X axis.
5. Specify the Y-axis channel.
This is done in the same way as the X-axis setting.
6. For graph 2 to graph 4, the settings are made in an identical.

5.4.3 Setting the Display Screen

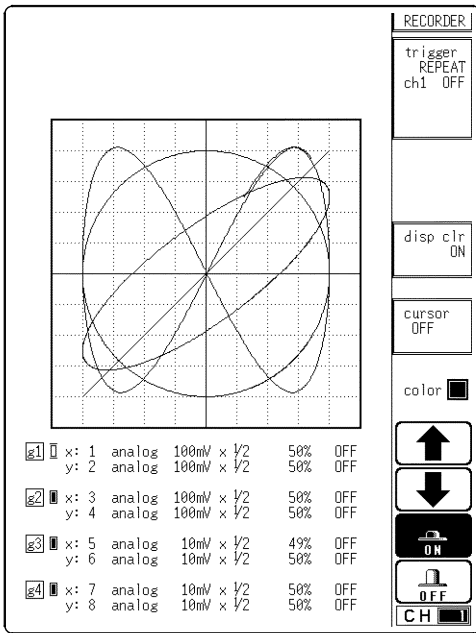

1. Press the **DISP** key to display the Waveform display screen.
2. Press the **CH.SET** key to make a setting.
 - Display clear setting (ON/OFF)
 - Display setting (ON/OFF), X-axis and Y-axis setting
 - Trigger setting
 - A and B cursors setting

5.5 Settings on the Waveform Display Screen (REC)

Explains the setting items on the Waveform display screen.

For details on setting, refer to Section 5.3.

When want to use the Jog/Shuttle control, press the **VALUE** select key.

(The selection window is not displayed.)

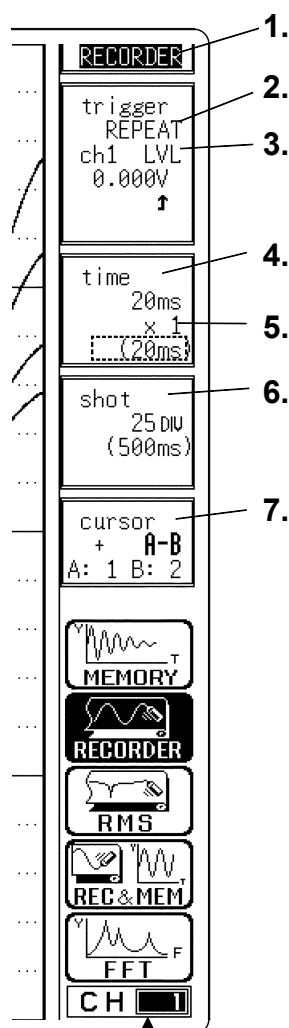

Setting items	Selection	Explanation
1. Function	MEM, REC, RMS, REC&MEM, FFT	Select function.
2. Trigger mode	SINGLE, REPEAT	Select trigger mode.
3. Analog trigger	OFF, LEVEL, OUT, IN, V-DROP, CYCLE	Set the analog trigger.
4. Time axis range	20 ms/DIV to 1 h/DIV 16 steps	Set the speed for inputting and storing the waveform of the input signal. Time axis range setting expresses the time for 1 DIV.
5. Compression along the time axis	× 1 to × 1/500 When the time axis is 20 to 50 ms/DIV, the waveforms are compressed and displayed during measurement.	By compressing the waveform, an entire change can be promptly apprehended.
6. Recording length memory capacity: 8M words	SELECT: 25 DIV to CONT ARBITRARY: 1 to 2000 DIV	The length of recording for one measurement operation (the number of DIV) can be set.
7. Cursor Measurement	OFF, ↔, ↕, +	The A·B cursors can be used.
Input channel settings	• Analog input • Logic input • X, Y axis (X-Y format)	Enables the measurement conditions for each channel on the display screen to be set or changed. See Section 9.10.
Input level monitor function		Press the LEVEL MONI key. See Section 11.5.
VIEW function		Press the VIEW key. See Section 11.6.

Channels that may be changed with the **RANGE** knob (measurement range) and **POSITION** knob (zero position). This channel display is selected with Channel-select keys CH1 to CH16.

Changing the set channel in the CHANNEL or CH.SET screens modifies the setting accordingly.

5.6 Start and Stop Operation (REC)

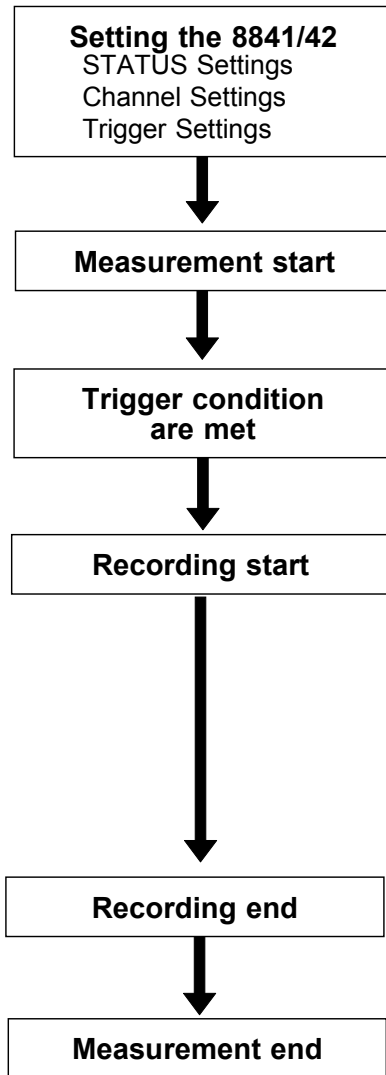

See Section 5.3, "STATUS Settings", Chapter 9, "Input Channel Settings", Chapter 10, "Trigger Functions."

Press the **START** key and LED light. When the trigger can be registered, the indication "Waiting for trigger" is shown on the display.

Data recording starts when trigger condition are met. (trigger timing: start, start&stop)

Displays "Storing". When the time axis is 20 to 50 ms/DIV, the waveforms are compressed and displayed. If the printer is on, printing initiates simultaneously with display. When the time axis is 20 to 200 ms/division, printing is performed as follows. Using the **VIEW** key to display the time (from measurement started time).

When automatic storage is enabled and measurement is interrupted in progress, measurement data taken prior to the interruption point is stored automatically.

Auto saving is executed.

Trigger mode: SINGLE
REPEAT

End of measurement

Each time when trigger conditions are met, data are recorded and memory contents are overwritten.

(Trigger timing: start / start&stop)

Data recording starts.

(Trigger timing: stop)

End of measurement in REPEAT trigger modes
When **STOP** key is pressed, measurement stops

Chapter 6

RMS Recorder Function

6.1 Overview of the RMS Recorder Function

The RMS recorder function has the following features.

- (1) The voltage value and DC signal for the commercial power supplies are displayed and recorded as the rms value.
- (2) Real time continuous recording
- (3) The 8841/42 is designed to measure commercial power supplies (50/60 Hz) and DC signal.
- (4) RMS accuracy: $\pm 3\%$ f.s.
- (5) Time axis setting
5 s/DIV to 1 h/DIV
- (6) Time axis resolution: 100 points/DIV (printer)
- (7) Sampling speed
20 rms data/s (200 μ s fixed)
- (8) Memory capacity
 - 8 M words: 2000 DIV
 - 32 M words: 10000 DIV
 - Arbitrarily (Set from 1 division to the maximum number of divisions at 1-division intervals)
- (9) Waveform magnification/compression display and printout
 - Time axis direction: $\times 1$ to $\times 1/500$ (9 steps)
 - Voltage axis direction: $\times 10$ to $\times 1/2$ (single)
 $\times 5$ to $\times 1/4$ (dual to hex) 5 steps
 - With the variable function and vernier function
- (10) Display format
Time axis waveform: single, dual, quad, oct screen display (LCD), hex screen display (print only)
- (11) Scrollable display
 - The most recent 2000 (32 M words: 10000) divisions of the data are stored in memory.
 - It is possible to scroll back for easy review.

- (12) Additional recording function
The first set of measurement data is preserved, and recording of the second set of measurement data starts after the first set.
- (13) Logging function
Numeric printout of waveform data
- (14) Reprint function
The most recent 2000 (32 M words: 10000) divisions of the data stored in memory can be printed as many times as required.
- (15) Print
Real-time print, manual print, partial print, report print, screen hard copy can be printed.

6.2 Operation Sequence (RMS)

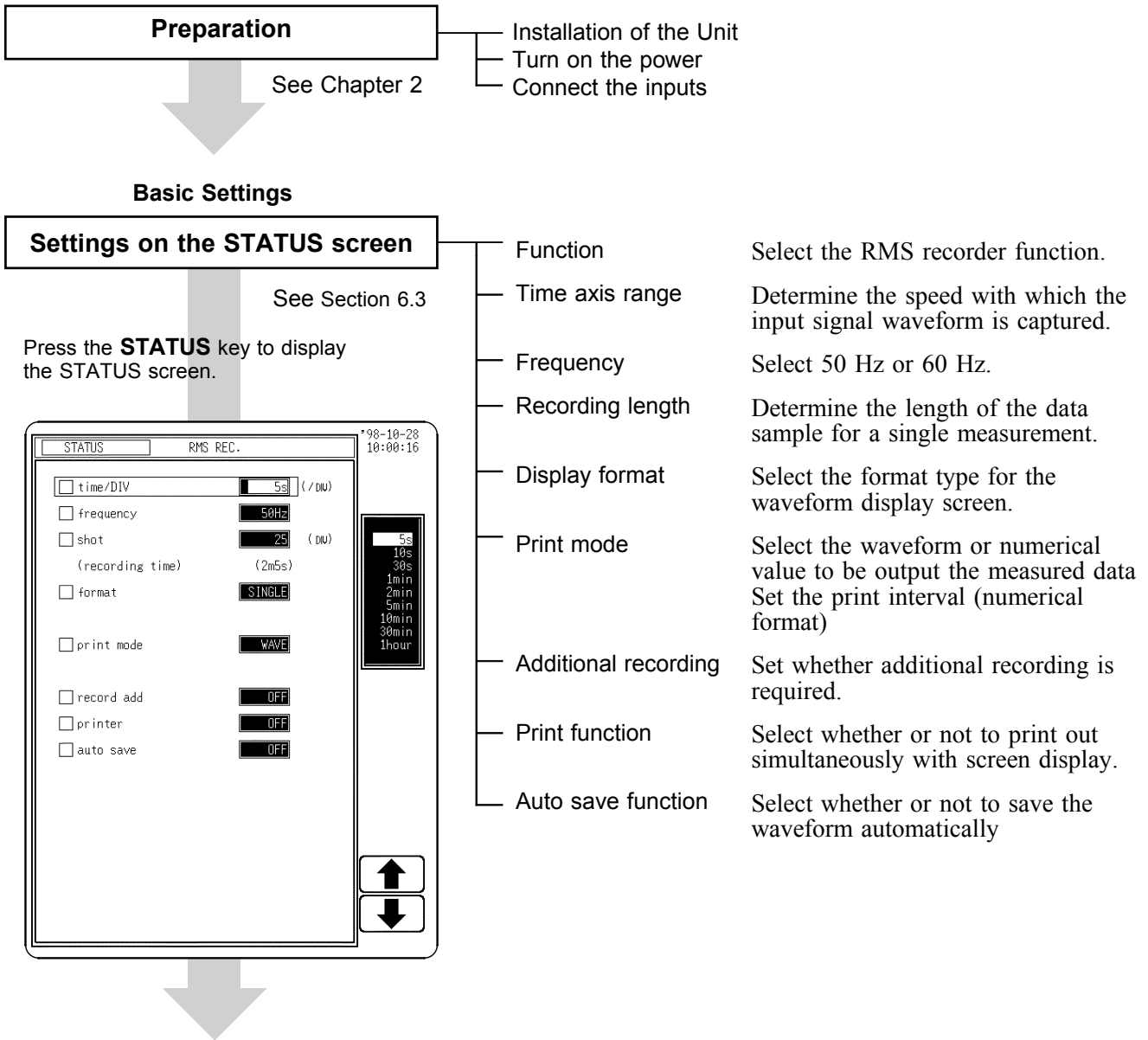

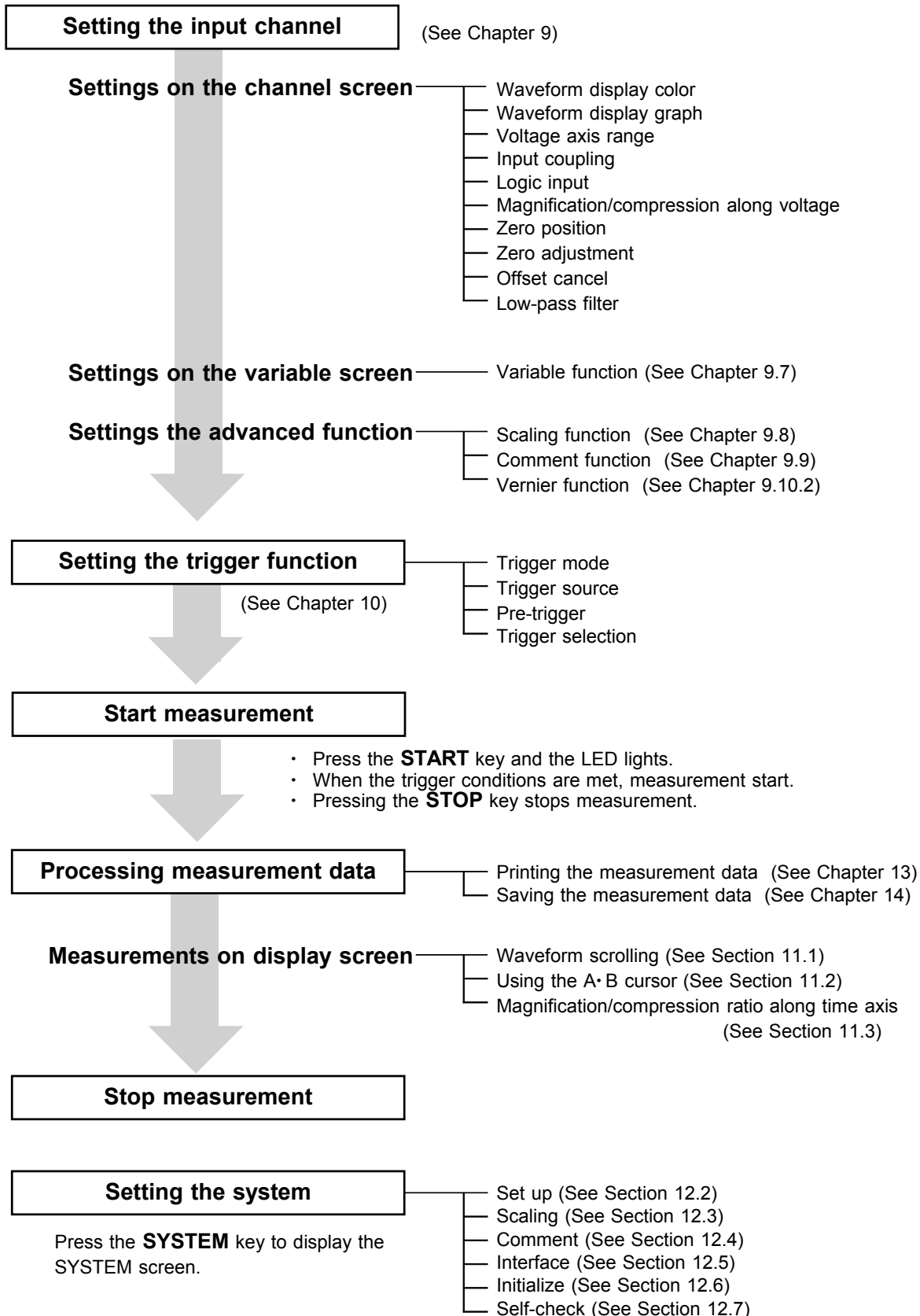

6.3 STATUS Settings (RMS)

Press the **STATUS** key to access the STATUS screen. This section explains how to set the STATUS screen of the RMS recorder function. See the corresponding sections for items that can be set in the Waveform display or CHANNEL screens.

Waveform display screen: see Section 6.4

CHANNEL screen: see Section 9.3

The screenshot shows the STATUS screen for the RMS REC. function. The screen is divided into two main sections: a top header and a main settings area. The top header displays the date and time: '00-01-05 13:53:50'. The main settings area contains a list of options, each with a checkbox and a corresponding value or setting. The settings are as follows:

- time/DIV: 5s (/DIV) — See Sections 6.3.2
- frequency: 50Hz — See Sections 6.3.3
- shot: 25 (DIV) — See Sections 6.3.4
- (recording time) (2m5s)
- format: SINGLE — See Sections 6.3.5
- print mode: LOGGING — See Sections 6.3.6
- interval: 1 DIV
- record add: OFF — See Sections 6.3.7
- printer: OFF — See Sections 6.3.8
- auto save (means): FLOPPY SAVE — See Sections 6.3.9
- type (file name): TEXT AUTO
- thin out: OFF

On the right side of the screen, there is a vertical stack of icons for navigation: MEMORY, RECORDER, RMS, REC & MEM, and FFT.





6.3.1 Setting the Function Mode

The 8841/42 has five function modes. Select the RMS recorder function.

Procedure

Screen: STATUS, CHANNEL, Waveform display, TRIGGER

1. Use the Menu keys to display the desired screen.
2. Move the flashing cursor to the top position.
3. Select the **RMS** function key display.

Function display	Meaning
	: Memory recorder function
	: Recorder function
	: RMS recorder function
	: Recorder & Memory recorder function
	: FFT function

6.3.2 Setting the Time Axis Range

Set the speed for inputting and storing the waveform of the input signal. Time axis range setting expresses the time for 1 division. The sampling interval is constant (200 μ s), regardless of the time axis range.

Screen: STATUS, Waveform display

Procedure 1

1. Use the Menu keys to display the desired screen.
2. Move the flashing cursor to the **time/DIV** item.
3. Use the Jog/Shuttle control, the function keys or the **TIME/DIV** key to make the selection.

Procedure 2

Using the TIME/DIV key

1. Use the Menu keys to display the desired screen.
2. Use the **TIME/DIV** key to make the selection.
The **TIME/DIV** key can be used regardless of where the flashing cursor is located.

NOTE

For details on sampling period, see Appendix 3.5.
The symbol "*" in the selection window indicates the time axis of the data stored to current memory. (If no data is present in memory, this symbol is not displayed.)



6.3.3 Setting the Frequency

Serves to set the frequency of the signal to be measured.

Procedure

Screen: STATUS

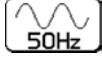
1. Use the Menu keys to display the desired screen.
2. Move the flashing cursor to the **frequency** item.
3. Use the function keys to make the selection.

Function display	Meaning
	: Measure rms value of 50 Hz signal
	: Measure rms value of 60 Hz signal

6.3.4 Setting the Recording Length

The length of recording for one measurement operation (number of DIV) can be set.

SELECT Select the recording length.



ARBITRARY Variable recording length can be selected by the user.

Screen: STATUS, Waveform display

Procedure 1



Constant recording length mode



1. Use the Menu keys to display the desired screen.
2. Move the flashing cursor to the **shot** item and select **SELECT**.
3. Use the Jog/Shuttle control or the function keys to make a setting.

Function display	Meaning
	: Move the cursor up in the selection window.
	: Move the cursor down in the selection window.

Procedure 2

Variable recording length mode

1. Use the Menu keys to display the desired screen.
2. Move the flashing cursor to the **shot** item and select **ARBITRARY**.
3. Use the Jog/Shuttle control or the function keys to make a setting. To change the column, use the cursor keys ( ).

Function display	Meaning
	: Increases in number.
	: Decreases in number.

NOTE

- The maximum recording length is 2000 divisions for a memory capacity of 8 M words or 10,000 divisions for 32 M words (with additional memory).
- When the recording length is set to **CONT.**, the auto-saving is automatically set to OFF.
- In fixed-length recording mode, the symbol "*" in the selection window indicates the recording length of the data stored to current memory. (If no data is present in memory, this symbol is not displayed.) In any recording-length mode, the symbol "#" is displayed before the recording length.

6.3.5 Setting the Display Layout

- The layout can be set for showing input signals on the screen display and recording them on the printer.
- The following layout is available: single, dual, quad, oct (Waveform display screen), and hex (Print only, Display oct).
- The voltage per division is automatically changed according to the display format.

Procedure

Screen: **STATUS**

1. Press the **STATUS** key to display the STATUS screen.
2. Move the flashing cursor to the **format** item.
3. Use the function keys to select the display format.
4. Set the graph type when the display format is set to DUAL, QUAD, OCT or HEX screen display.
5. Press the **CHAN** key to display the CHANNEL screen.
6. Move the flashing cursor to the point in the figure below.
The figure shows the setting for the channel 1 (CH1). Setting for the channel 2 to 16 should be made in the same way.

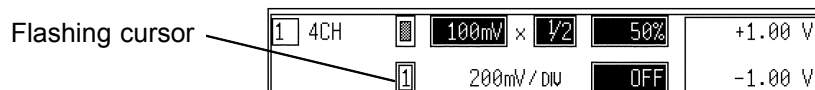

7. Use the function keys to select.

Function display Meaning



: Move the cursor up in the selection window.



: Move the cursor down in the selection window.

In the cases of HEX, as far as the printer recording output is concerned, the waveforms for each channel are automatically distributed on each graph according to the table below:

For details on logic channels, refer to Section 9.3.8.

Graph	Analog channel	Graph	Analog channel
1	CH 1	9	CH 9
2	CH 2	10	CH 10
3	CH 3	11	CH 11
4	CH 4	12	CH 12
5	CH 5	13	CH 13
6	CH 6	14	CH 14
7	CH 7	15	CH 15
8	CH 8	16	CH 16

Single graph

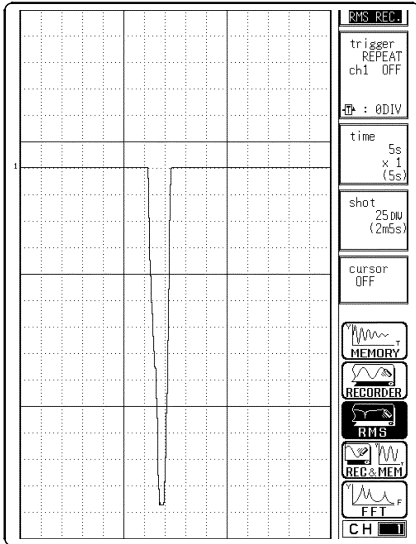

Display and record as one graph. (At the most, 16 analog + 16 logic signals)

Dual graph

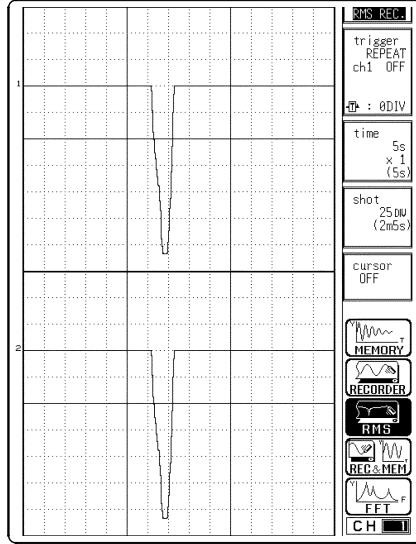

- Display and record as two graphs. (At the most, 16 analog + 16 logic signals)
- Specify which input channel to use for waveform graph display and recording.

Quad graph

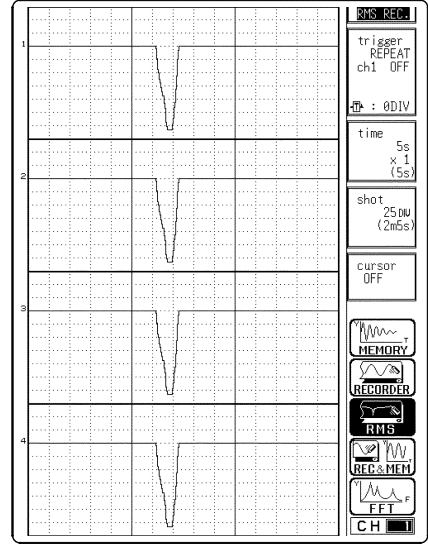

- Display and record as four graphs. (At the most, 16 analog + 8 logic signals)
- Specify which input channel to use for waveform graph display and recording.

Oct graph

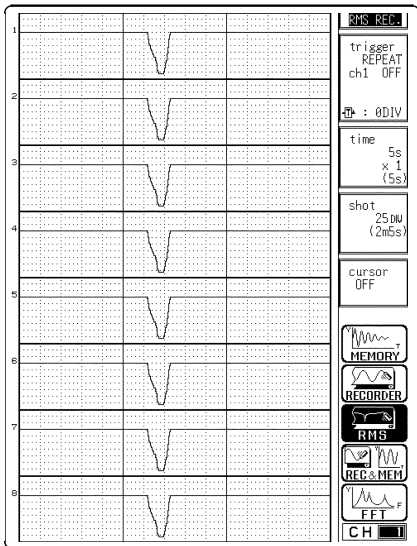

- Record as eight graphs. (At the most, 16 analog + 4 logic signals)
- Specify which input channel to use for waveform graph display and recording.

HEX graph

- Display is same as Oct screen display.
- Record as sixteen graphs. (At the most, 1 analog + 2 logic signals)
- Channel positions are automatically distributed.

6.3.6 Setting the Print Mode

Select the format, waveform, or numerical value should be used to output measured data.

Waveform The waveform is printed.

Numerical value The data spacing interval also must be set.

Procedure Screen: STATUS

(1) Setting the printer format

1. Press the **STATUS** key to display the STATUS screen.
2. Move the flashing cursor to the **print mode** item.
3. Use the function keys to make a setting.

Function
display

Meaning

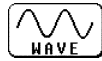

: Measurement data and the result of calculation are printed as a waveform.



: Measurement data and the result of calculation are printed as numeric data.

(2) Setting the print interval

1. When the numeric data is selected in step (1), set the print interval.
2. Move the flashing cursor to **interval**.
3. Use the function keys to make a setting.
 Since each division equals 100 samples, the print interval "0.01" indicates one sample (no print interval).
 When the print interval longer than the recording length is set, only the first dot is printed.

Function
display

Meaning



: Move the cursor up in the selection window.



: Move the cursor down in the selection window.

NOTE

- The maximum and minimum values are printed (excluding 5 s/DIV). See Appendix 3.5.
- The print intervals of 0.01 to 0.5 DIV can be selected, only when there are waveform data present.
- When numerical values are output for real-time printing, the minimum print interval is 1 division.

6.3.7 Setting the Additional Recording Function

This records, regarding the memory as though it were recording paper.

The memory capacity of 8 M words can accommodate up to 2000 divisions of waveform data. With 32 M words (after optional memory expansion), waveform data of up to 10000 divisions can be saved.

The waveform can be scrolled and printed out.

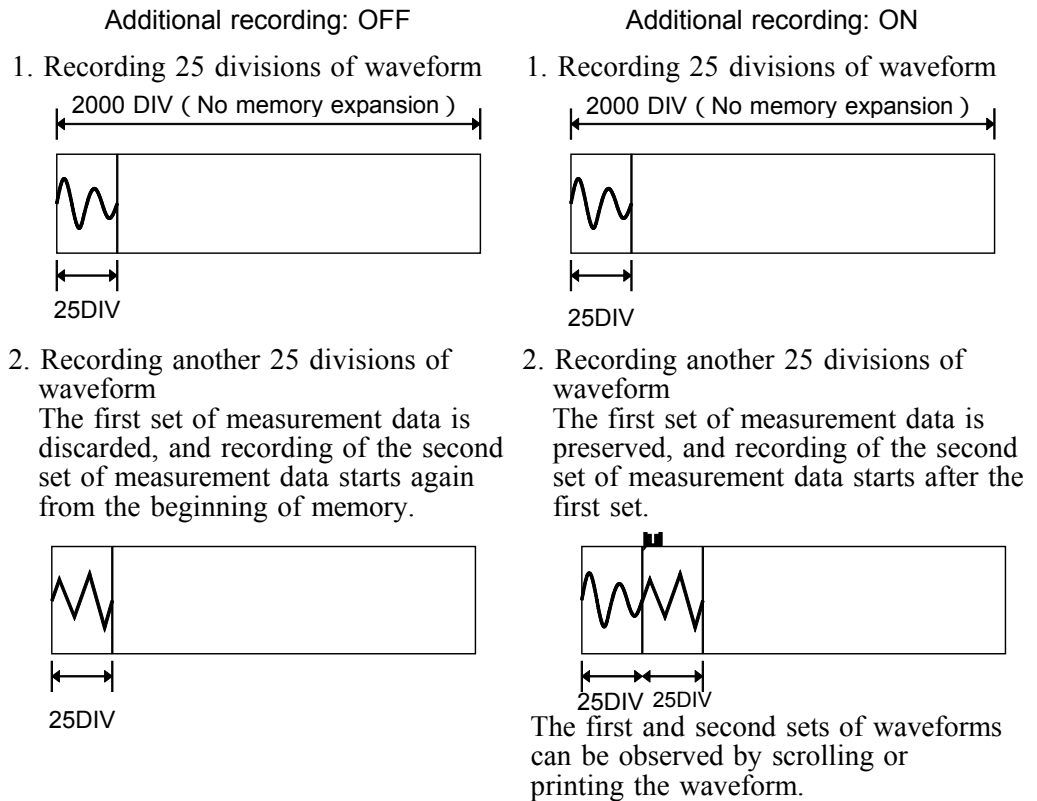

Switching the additional recording on and off affects the use of memory as shown below.



Procedure

Screen: STATUS

1. Press the **STATUS** key to display the STATUS screen.
2. Move the flashing cursor to the **record add** item.
3. Use the function keys to make a setting.

Function display	Meaning
	: Normal recording is carried out.
	: The waveform is displayed immediately at the start of recording.

NOTE



- Time values output to the printer and displayed on the screen with the additional recording function enabled are equal to those of the most recently acquired waveforms. Therefore, when measuring waveforms in a different time axis range, always take that difference into consideration.
- When the 2000 (32 M words: 10000) DIV has been reached, old data will be overwritten.
- If auto-save is enabled, only newly acquired waveforms are saved. Even when A and B cursors appear on the screen, no partial save is performed, because the setting is disabled when the START key is pressed.

6.3.8 Setting the Printer Function (Real Time Printing)

The input waveform is continuously printed in real time.

Procedure Screen: STATUS

1. Press the **STATUS** key to display the STATUS screen.
2. Move the flashing cursor to the **printer** item.
3. Use the function keys to make a setting.







Function display	Meaning
	: Printing is disabled.
	: Printing is enabled.

6.3.9 Setting the Auto Save Function



- When the function is enabled, measurement data are automatically stored on a floppy disk, PC card, MO disk or connected SCSI device after they are captured.
- The Auto Save function stores a file in the directory currently selected on the file screen. See Section 14.12.2.

Procedure Screen: STATUS

1. Press the **STATUS** key to display the STATUS screen.
2. Move the flashing cursor to the **auto save** item.
3. Use the function keys, select the media for auto saving.

Function display	Meaning
	: Auto save is disabled.
	: Automatically stored on floppy disk
	: Automatically stored on PC card.
	: Automatically stored on connected SCSI device.
	: Automatically stored on MO disk.
	: (When using a LAN card) A LAN is used to transfer data to the 9333 LAN COMMUNICATOR.

4. When Media is selected, the Storage method item appears.

Function display	Meaning
	: When the media becomes full, automatic storage stops.
	: When the media becomes full, old files are deleted to make room for automatic storage. With the binary format selected, the file with the extension 'RMS' is deleted. With the text format selected, files with the extension 'TXT' are deleted.

5. Move the flashing cursor to **type**, and select the format.

Function display	Meaning
	: Data are stored as binary data.
	: Data are stored as text data.

Data stored in the text format is not readable by the 8841/42.

6. When the data format to be saved is set to text data, the intermittent setting item is displayed. Use the function keys or Jog/Shuttle control to make a setting.

Function display	Meaning
	: Move the cursor up in the selection window.
	: Move the cursor down in the selection window.

7. Set the file name. For the input method, refer to Section 9.9.3.

When using auto-save, a number is appended to the name you specify as the file name. This then becomes the file name. If you start procedures before specifying a file name, AUTO is automatically enabled.

When the characters below are used in a file, the file cannot be handled on a PC running Windows 2000 or XP. Do not use these characters when handling a file on your PC.

Full-size lowercase letters a to z; full-size π , μ , ϵ ; and half-size +, =, [,]

NOTE

- File names consist of 8 characters (or 4 double-byte characters). With auto-save, since numbers are attached to the end of file names, long file names are truncated when this number is appended to the end of the file name.
- With auto-save enabled, channel selection is disabled. Data for all channels is saved.
- For details on file name when auto-saving, see Section 14.7.
- When the recording length is "CONT", data are not stored automatically.
- For details on connected SCSI device, refer to Section 14.4.
- When cursor A and B are enabled, partial saving is executed.
- If additional recording is enabled, only newly acquired waveforms are saved. Even when A and B cursors appear on the screen, no partial save is performed.
- During automatic storage, if the measurement is interrupted, waveforms taken prior to the interruption are stored automatically.
- The directory and the number of files that can be stored in the directory are limited. For details, see Section 14.7.
- When "COMMUNI" (communications) is selected as Media, Storage Method and Type are not displayed.

6.4 Settings on the Waveform Display Screen (RMS)

Explains the setting items on the Waveform display screen.

For details on setting, refer to Section 6.3.

When want to use the Jog/Shuttle control, press the **VALUE** select key. (The selection window is not displayed

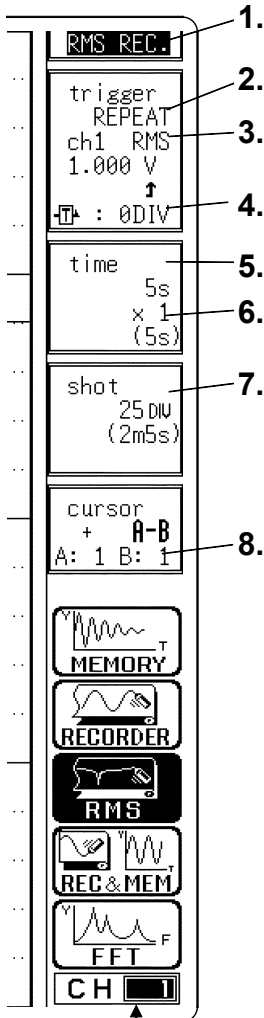

Setting items	Selection	Explanation
1. Function	MEM, REC, RMS, REC&MEM, FFT	Select function.
2. Trigger mode	SINGLE, REPEAT	Select trigger mode.
3. Analog trigger	RMS LEVEL	Set the analog trigger.
4. Pre-trigger	0, 5, 10 DIV	Set the Pre-trigger.
5. Time axis	5 s/DIV to 1 h/DIV	Set the time 1 scale (1 DIV).
6. Compression along the time axis	× 1 to × 1/500	By compressing the waveform, an entire change can be promptly apprehended.
7. Recording length (Capacity : 8 M words)	SELECT: 25 DIV to CONT ARBITRARY: 1 DIV to 2000 DIV	The length of recording for one measurement operation (the number of DIV) can be set.
8. Cursor Measurement	OFF, ↔, ↕, +	The A·B cursors can be used.
Input channel settings	<ul style="list-style-type: none"> • Analog input • Logic input • X, Y axis (X-Y format) 	Enables the measurement conditions for each channel on the display screen to be set or changed. See Section 9.10.
Input level monitor function		Press the LEVEL MONI key. See Section 11.5.
VIEW function		Press the VIEW key. See Section 11.6.

Channels that may be changed with the **RANGE** knob (measurement range) and **POSITION** knob (zero position). This channel display is selected with Channel-select keys CH1 to CH16.

Changing the set channel in the CHANNEL or CH.SET screens modifies the setting accordingly.

6.5 Start and Stop Operation (RMS)

Setting the 8841/42
 • STATUS Settings
 • Channel Settings
 • Trigger Settings

See Section 6.3, "STATUS Settings", Chapter 9, "Input Channel Settings", Chapter 10, "Trigger Functions."

Measurement start

Press the **START** key and LED light.
 When the trigger can be registered, the indication "Waiting for trigger" is shown on the display.

**Trigger condition
 are met**

Data recording starts when trigger condition are met.

Recording start

Displays "Storing".
 If the printer is on, printing initiates simultaneously with display.
 Using the **VIEW** key to display the time (from measurement started time).

Recording end

When automatic storage is enabled and measurement is interrupted in progress, measurement data taken prior to the interruption point is stored automatically.
 Auto save are executed.

Measurement end

Trigger mode: SINGLE
 REPEAT

End of measurement

Each time when trigger conditions are met, data are recorded and memory contents are overwritten.

When the **STOP** key is pressed, measurement stops after data corresponding to recording length have been stored in memory. (auto save are not executed.)

Chapter 7

Recorder & Memory Function

7.1 Overview of the Recorder & Memory Function

The recorder and memory function has the following features.

- (1) After being stored in the internal memory, input signal data can be displayed and printed.
- (2) All input channel data are recorded on the same time axis.
Since data for all channels can be superimposed, the relative relationship between input signals can be observed visually.
- (3) Time axis setting
20 ms/DIV to 1 h/DIV (recorder, 16 steps)
100 μ s/DIV to 5 min/DIV (memory, 20 steps)
- (4) Time axis resolution 100 points/DIV
- (5) Storage capacity

8 M words (DIV)	1000 (Recorder)	2000 (Memory)
32 M words (DIV)	5000 (Recorder)	10000 (Memory)
- (6) Display format
Single, dual, quad, oct screen display (LCD), hex screen display (when printing)
- (7) Printing
Real-time print (recorder only), manual print, partial print, report print, screen hard copy can be printed.
- (8) High-quality print
Smooth print function approximates analog waveform.
- (9) Additional recording function
The first set of measurement data is preserved, and recording of the second set of measurement data starts after the first set.
- (10) Logging function
Numeric printout of waveform data

7.2 Operation Sequence (REC&MEM)

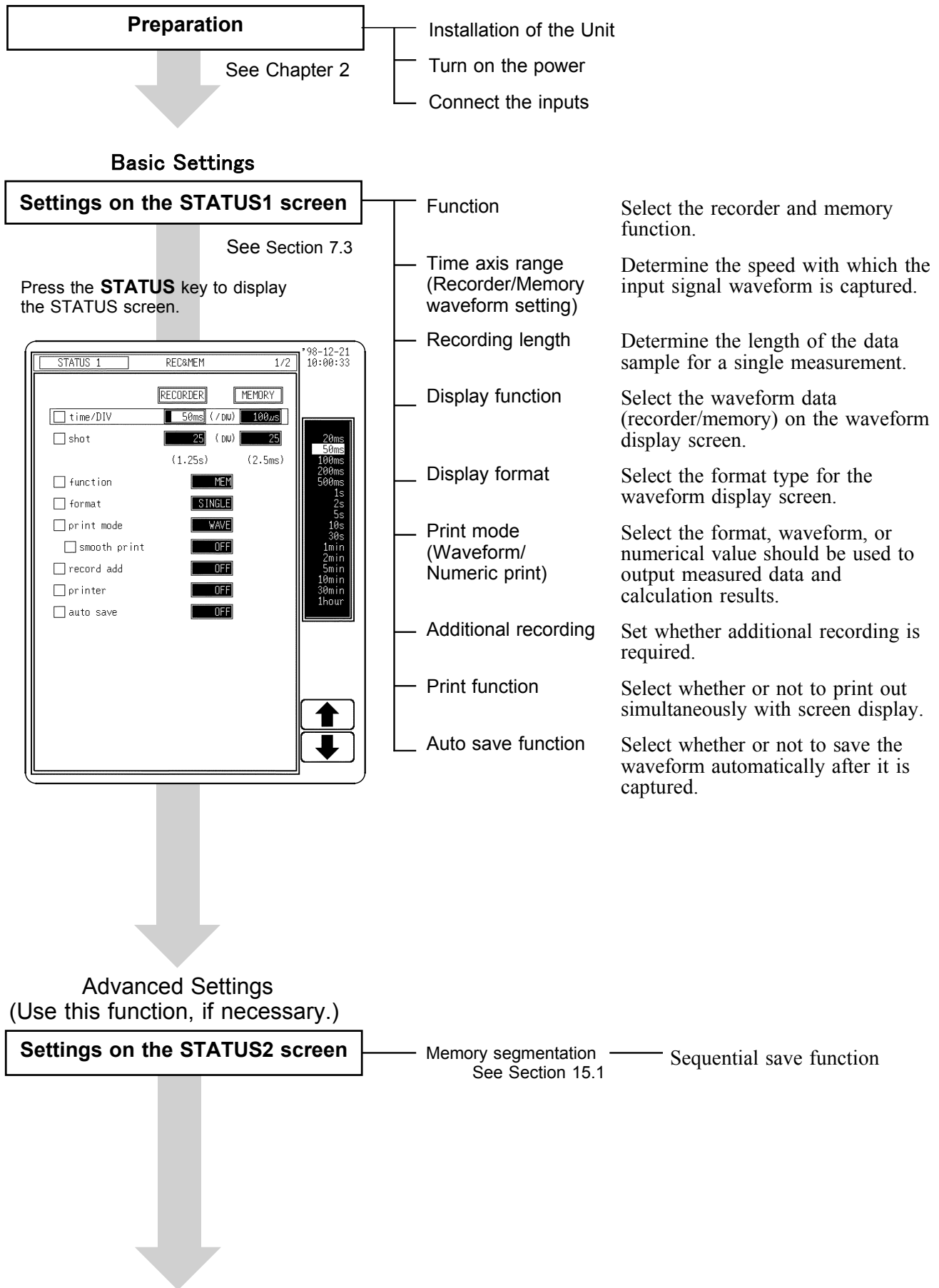

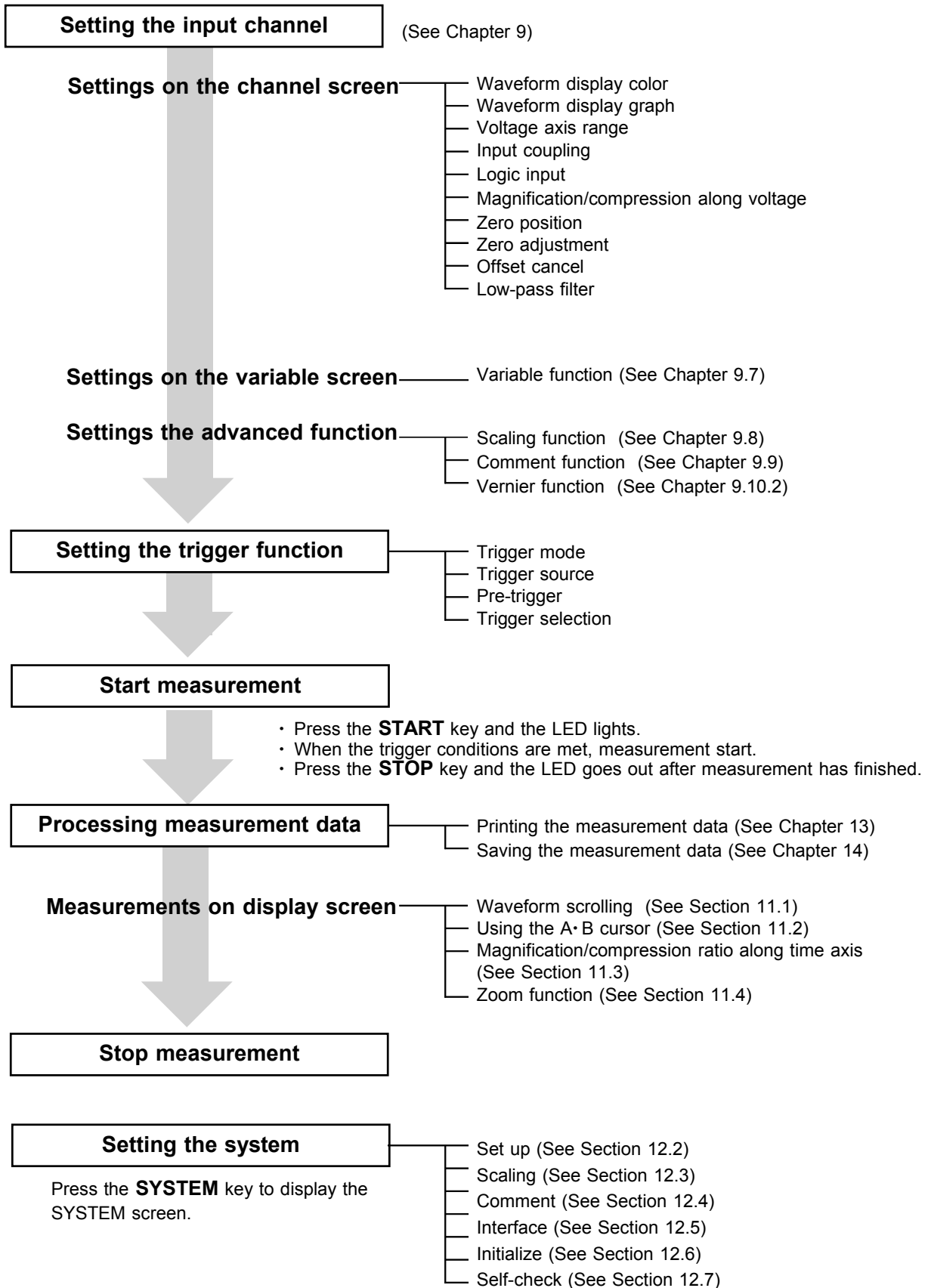

7.3 STATUS Settings (REC&MEM)

Press the **STATUS** key to access the STATUS1 screen. This section explains how to set the STATUS screen of the recorder and memory function. See the corresponding sections for items that can be set in the Waveform display or CHANNEL screens.

Waveform display screen: See Section 7.4

CHANNEL screen: See Section 9.3

The screenshot shows the STATUS 1 REC&MEM screen. At the top right, it displays the date '00-01-05' and time '13:54:22'. The screen is divided into two main sections: RECORDER and MEMORY. On the left, there are several checkboxes and their corresponding settings. On the right, there are several buttons and a vertical stack of icons. Dotted lines connect these elements to section references on the right side of the page.

Setting	Value	Section Reference
time/DIV	20ms (/DIV)	7.3.2
shot	25 (DIV)	7.3.3
function	MEM	7.3.4
format	SINGLE	7.3.5
print mode	WAVE	7.3.6
smooth print	ON	
record add	OFF	7.3.7
printer	OFF	7.3.8
auto save (means)	FLOPPY SAVE	7.3.9
type (file name)	TEXT AUTO	
thin out	OFF	
function	REC&MEM	
real time save	OFF	

Additional callouts on the right side of the screen point to the following icons:

- MEMORY (T)
- RECORDER
- RMS
- REC&MEM
- FFT (F)

NOTE

The settings of sequential save function on the STATUS 2 screen, see Section 15.1.





7.3.1 Setting the Function Mode

The 8841/42 has five function modes. Select the Recorder and Memory functions.

Procedure

Screen: STATUS1, CHANNEL, Waveform display, TRIGGER

1. Use the Menu keys to display the desired screen.
2. Move the flashing cursor to the top position.
3. Select the **REC&MEM** function key display.

Function display	Meaning
	: Memory recorder function
	: Recorder function
	: RMS recorder function
	: Recorder & Memory recorder function
	: FFT function

Recorder & Memory Function Operation

During real-time signal recording with the recorder function, if an abnormal phenomena latches the trigger, that period is recorded simultaneously by the high-speed sampling memory recorder. Normal recorder operation is not suspended during memory recording, so the real-time recording continues through the abnormal phenomena.

Low-speed Recorder recording

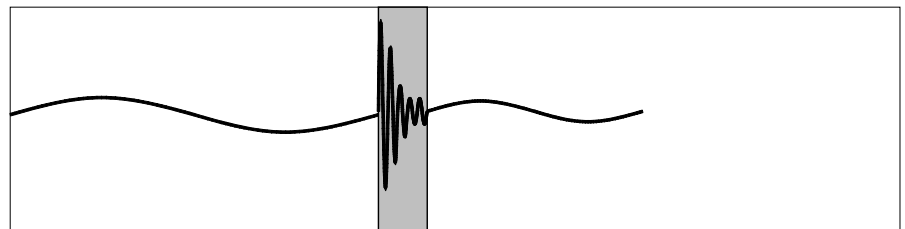

High-speed Memory recording

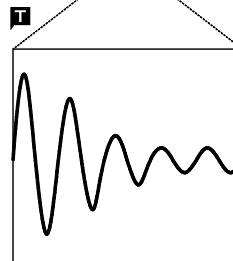

7.3.2 Setting the Time Axis Range

Set the speed for inputting and storing the waveform of the input signal. Time axis range setting expresses the time for 1 DIV. The sampling period is 1/100th of the set value for the time axis range. (100 samples/DIV)
(See Appendix 3)
The sampling period for the sampling recorder is set by the memory.

Screen: STATUS1

- Procedure 1**
1. Use the Menu keys to display the desired screen.
 2. Move the flashing cursor to the **time/DIV** item.
 3. Move the flashing cursor to the time axis range for recorder or memory to make the selection by using the Jog/Shuttle control, the function keys.
For the time axis range setting for the recorder, the **TIME/DIV** key can be also used. Pressing this key moves the flashing cursor to the time axis item, and pressing other keys returns the cursor to the previous position.

Screen: Waveform display

- Procedure 2**
1. Press the **DISP** key to display the Waveform display screen.
 2. Move the flashing cursor to **Function change** and select **REC&mem** or **rec&MEM** by using the **F4** function key.
 3. Move the flashing cursor to the **time axis range** item.
 4. Use the Jog/Shuttle control, the function keys, or **TIME/DIV** key to make the setting. The **TIME/DIV** key can be used regardless of where the flashing cursor is located.

NOTE

- The symbol "*" in the selection window indicates the time axis of the data stored to current memory. (If no data is present in memory, this symbol is not displayed.)
- The sampling period of the recorder is the same as that set for memory, so depending on the memory sampling period, the time axis may not be settable for the recorder.
- When the time axis range for recorder is set to the fast range (greater than 200 ms/division), the printer setting is automatically off.

Combination of the recorder and memory time axis range.

Vertical axis: time axis range of memory waveform (/DIV), horizontal axis: time axis range of recorder waveform (/DIV)

	20ms	50ms	100ms	200ms	500ms	1s	2s	5s	10s	30s	1min	2min	5min	10min	30min	1hour
100 μs																
200 μs																
500 μs																
1ms																
2ms																
5ms																
10ms	-															
20ms	-	-														
50ms	-	-	-													
100ms	-	-	-	-												
200ms	-	-	-	-	-											
500ms	-	-	-	-	-	-										
1s	-	-	-	-	-	-	-									
2s	-	-	-	-	-	-	-	-								
5s	-	-	-	-	-	-	-	-	-							
10s	-	-	-	-	-	-	-	-	-	-						
30s	-	-	-	-	-	-	-	-	-	-	-					
1min	-	-	-	-	-	-	-	-	-	-	-	-				
2min	-	-	-	-	-	-	-	-	-	-	-	-	-			
5min	-	-	-	-	-	-	-	-	-	-	-	-	-	-		

7.3.3 Setting the Recording Length

The length of recording for one measurement operation (number of DIV) can be set.

The recording lengths for the recorder and memory are set separately. Two setting methods are available.

SELECT Select the recording length.

ARBITRARY Variable recording length can be selected by the user.

Screen: STATUS1, Waveform display

Procedure 1 Constant recording length mode

1. Use the Menu keys to display the desired screen.
2. Move the flashing cursor to the **shot** item.
3. To set the recording length, move the flashing cursor to either Recorder or Memory, according to which is to be set, and select **SELECT**.
4. Use the Jog/Shuttle control or the function keys to make a setting.

Function display Meaning







: Move the cursor up in the selection window.



: Move the cursor down in the selection window.

Procedure 2 Variable recording length mode

1. Use the Menu keys to display the desired screen.
2. Move the flashing cursor to the **shot** item.
3. To set the recording length, move the flashing cursor to either Recorder or Memory, according to which is to be set, and select **ARBITRARY**.
4. Use the Jog/Shuttle control or the function keys to make a setting. To change the column, use the cursor keys ( ).

Function display	Meaning
	: Increases in number.
	: Decreases in number.

NOTE

- If the recording length is changed during measurement, measurement is restarted using the newly set recording length.
- When the recording length of the recorder is set to "CONT.", the auto-saving function is automatically set to off.
- The memory capacity of 8 M words can accommodate up to 1000 divisions (recorder) or 2000 divisions (memory) of waveform data. With 32 M words, waveform data of up to 5000 divisions (recorder) or 10000 divisions (memory) can be saved.
- In fixed-length recording mode, the symbol "*" in the selection window indicates the recording length of the data stored to current memory. (If no data is present in memory, this symbol is not displayed.) In any recording-length mode, the symbol "#" is displayed before the recording length.



7.3.4 Display Function

The type of display waveform can be selected.

During measurement, the recorder waveform is displayed.(automatically set to recorder)

Procedure Screen: STATUS1

1. Press the **STATUS** key to display the STATUS1 screen.
2. Move the flashing cursor to the **function** item.
3. Use the function keys to make a setting.

Function display	Meaning
	: Memory waveform is displayed
	: Recorder waveform is displayed

NOTE

- The type of display waveform can be set by pressing the **REC&MEM** function key on the Waveform display screen.
- The memory waveform in Recorder and Memory function can be also displayed in memory recorder function.

7.3.5 Setting the Display Layout

- The layout can be set for showing input signals on the screen display and recording them on the printer.
- The following layout is available: single, dual, quad, oct (Waveform display screen), hex (Print only, Display oct).
- The voltage per division is automatically changed according to the display format.

Procedure

Screen: STATUS1

1. Press the **STATUS** key to display the STATUS1 screen.
2. Move the flashing cursor to the **format** item.
3. Use the function keys to select the display format.
4. Set the graph type when the display format is set to DUAL, QUAD, OCT or HEX screen display.
5. Press the **CHAN** key to display the CHANNEL screen.
6. Move the flashing cursor to the point in the figure below.
The figure shows the setting for the channel 1 (CH1). Setting for the channel 2 to 16 should be made in the same way.

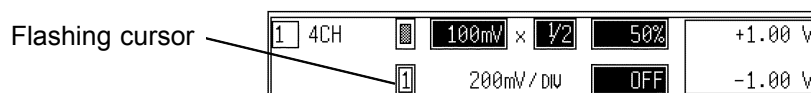

7. Use the function keys to select.

Function
display

Meaning



: Move the cursor up in the selection window.



: Move the cursor down in the selection window.

In the cases of HEX, as far as the printer recording output is concerned, the waveforms for each channel are automatically distributed on each graph according to the table below:

Graph	Analog channel	Graph	Analog channel
1	CH 1	9	CH 9
2	CH 2	10	CH 10
3	CH 3	11	CH 11
4	CH 4	12	CH 12
5	CH 5	13	CH 13
6	CH 6	14	CH 14
7	CH 7	15	CH 15
8	CH 8	16	CH 16

For details on logic channels, refer to Section 9.3.8.

7.3.6 Setting the Print Mode

Select the format, waveform, or numerical value should be used to output measured data and calculation results.



Waveform The smooth print function can be used, but print speed will decrease.

Numerical value The data spacing interval also must be set.

Procedure Screen: STATUS1

(1) Setting the printer format

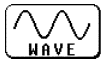
1. Press the **STATUS** key to display the STATUS1 screen.
2. Move the flashing cursor to the **print mode** item.
3. Use the function keys to make a setting.

Function display	Meaning
	: Measurement data and the result of calculation are printed as a waveform.
	: Measurement data and the result of calculation are printed as numeric data.

(2) Setting the smooth printing and print interval

1. When the waveform format is selected, determine whether to use the smooth printing or not. When the numerical value is selected, set the print interval. (unit: divisions)
2. Move the flashing cursor to the **smooth print** item or **interval**.
3. Use the function keys to make a setting.

Since 1 division represents 100 samples, the print interval "0.01" refers to a printout of every sample (no print interval). If the set print interval exceeds recording length, only the first point is printed.

NOTE

Smooth printing is available for memory waveform.

7.3.7 Setting the Additional Recording Function

This records, regarding the memory as though it were recording paper. As waveforms captured by the recorder are stored in the unit's memory, this machine can be operated as a paper recorder.

The memory capacity of 8 M words can accommodate up to 1000 divisions of waveform data. With 32 M words (after optional memory expansion), waveform data of up to 5000 divisions can be saved.

The waveform can be scrolled and printed out.

Switching the additional recording on and off affects the use of memory as shown below.

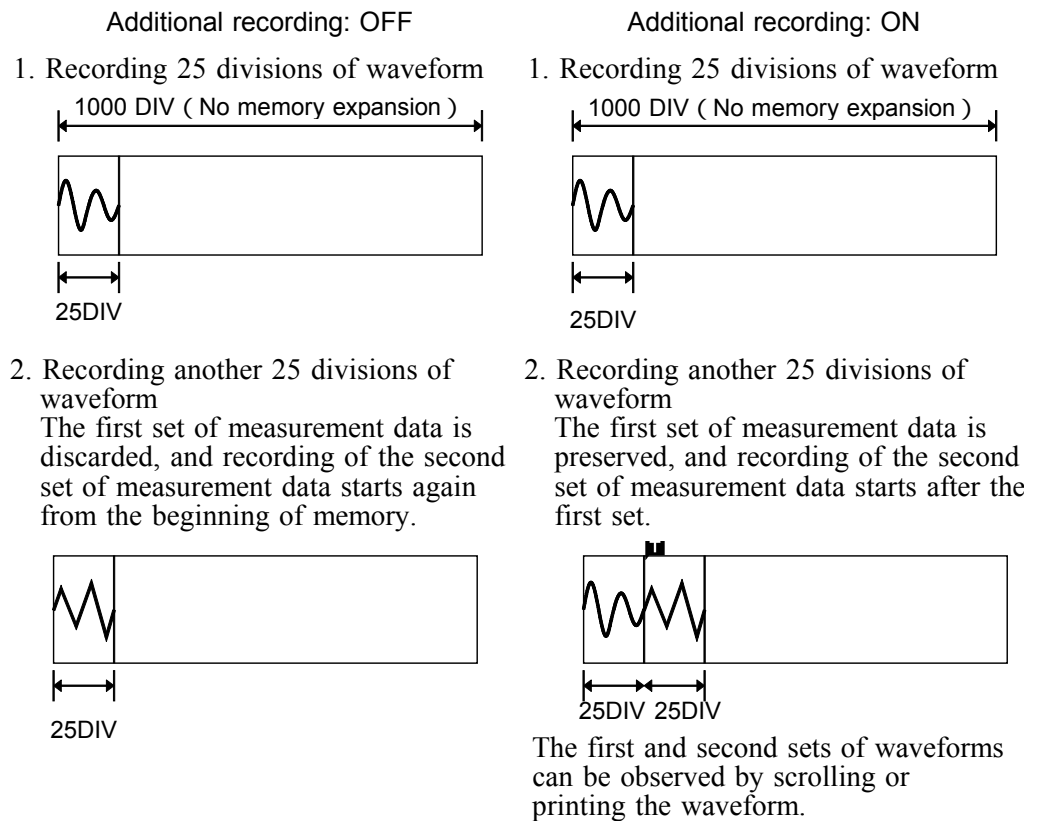

Procedure

Screen: STATUS1

1. Press the **STATUS** key to display the STATUS1 screen.
2. Move the flashing cursor to the **record add** item.
3. Use the function keys to make a setting.

Function
display

Meaning



: Additional recording is disabled.



: Additional recording is enabled.

NOTE

- Time values output to the printer and displayed on the screen with the additional recording function enabled are equal to those of the most recently acquired waveforms. Therefore, when measuring waveforms in a different time axis range, always take that difference into consideration.
- When the 1000 (32 M words: 5000) DIV has been reached, old data will be overwritten.
- In the recorder, the trigger mark (■) is written as the start position mark. In an additional recording, the trigger mark is displayed in front of the most recently entered data.
- If auto-save is enabled, only newly acquired waveforms are saved. Even when A and B cursors appear on the screen, no partial save is performed, because the setting is disabled when the **START** key is pressed.



7.3.8 Setting the Printer Function (Real-time Printing)

The input waveform (recorder waveform) is continuously printed in real time.

Procedure

Screen: STATUS1

1. Press the **STATUS** key to display the STATUS1 screen.
2. Move the flashing cursor to the **printer** item.
3. Use the function keys to make a setting.

Function display	Meaning
	: Printing is disabled.
	: Printing is enabled.

NOTE

- When the recorder's time axis is set to 200 ms/DIV or faster, the printer settings are automatically disabled.
- While the printer always outputs the data at the measurement magnification in recording mode, the waveform on the screen is reduced in size at the ratio shown in the table below, depending on the time-axis range.
100 ms/DIV × 1/2, 50 ms/DIV × 1/5, 20 ms/DIV × 1/10

7.3.9 Setting the Auto Save Function

When the function is enabled, measurement data are automatically stored on a floppy disk, PC card, MO disk or connected SCSI device after they are captured and the recording is completed. The Auto Save function stores a file in the directory currently selected on the file screen. See Section 14.12.2.

Procedure

Screen: STATUS1

1. Press the **STATUS** key to display the STATUS1 screen.
2. Move the flashing cursor to the **auto save** item.
3. Use the function keys, select the media for auto saving.

Function display	Meaning
------------------	---------



: Auto save is disabled.



: Automatically stored on floppy disk



: Automatically stored on PC card.

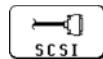

: Automatically stored on connected SCSI device.



: Automatically stored on MO disk.



: (When using a LAN card)
A LAN is used to transfer data to the 9333 LAN COMMUNICATOR.

4. When Media is selected, the Storage method item appears.

Function display	Meaning
------------------	---------



: When the media becomes full, automatic storage stops.



: When the media becomes full, old files are deleted to make room for automatic storage.

When 1 Block Save is selected with the Binary Format, the memory waveforms with the file extension 'MEM' are deleted. If sequential save is selected, files with the extensions 'SEQ' and 'MEM' are deleted, and the recorded waveforms in the 'REC' file is deleted.

When All Block Save is selected with the Binary Format, files with the extensions 'R-M', 'MEM' and 'REC' are deleted.

With the text format selected, files with the extension 'TXT' are deleted.

5. Move the flashing cursor to **type**, and select the format.

Function display	Meaning
------------------	---------



: Data are stored as binary data.

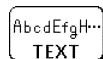

: Data are stored as text data.

Data stored in the text format is not readable by the 8841/42.

6. When the data format to be saved is set to text data, the intermittent setting item is displayed. Use the function keys or Jog/Shuttle control to make a setting.

Function display	Meaning
------------------	---------





: Move the cursor up in the selection window.



: Move the cursor down in the selection window.

7. Select the item to be stored.

Function display	Meaning
	: 1 block save of recorder data
	: 1 block save of memory data
	: All block save both recorder and memory data

8. Set the file name. For the input method, refer to Section 9.9.3.

When using auto-save, a number is appended to the name you specify as the file name. This then becomes the file name. If you start procedures before specifying a file name, AUTO is automatically enabled.

File names cannot contain the characters +, -,], or [. Please note that file names containing these characters will not be saved.

NOTE

- File names consist of 8 characters (or 4 double-byte characters). With auto-save, since numbers are attached to the end of file names, long file names are truncated when this number is appended to the end of the file name.
- When automatic storage is selected for both recorder and memory data, automatic storage is activated (an index file is created). If only recorder or memory is set for storage, 1 block save is performed.
- When auto-save is enabled, the storage channel cannot be selected. Data for the channel for which the waveform is displayed is saved. For details on auto saving file name, refer to Section 14.7.
- When the recording length of the recorder is set to "CONT.", the auto-saving cannot be made a setting.
- When cursor A and B are enabled, partial saving is executed. However, when All block save is selected, the partial saving cannot be executed.
- If additional recording is enabled, only newly acquired waveforms are saved. Even when A and B cursors appear on the screen, no partial save is performed.
- The same media is used for both the recorder and memory. Separate media cannot be selected.
- During automatic storage, if the STOP key is pressed to interrupt measurement, waveforms taken prior to the interruption are stored automatically.
- The directory and the number of files that can be stored in the directory are limited. For details, see Section 14.7.
- When "COMMUNI" (communications) is selected as Media, Storage Method and Type are not displayed.

7.3.10 Setting the Real-Time Save

Data can be saved to memory in real time, and afterwards compressed and stored on disk. Real-time save data is stored in binary format on the PC card or the internal MO drive.

Trigger settings are not applicable to the memory waveform, and the start of Memory waveform recording coincides with the start of the Recorder waveform.

The time axis of the Real-Time Save waveform may be 50 ms to 5 min/DIV for channels 1 to 8, and 100 ms to 5 min/DIV for channels 9 and above.

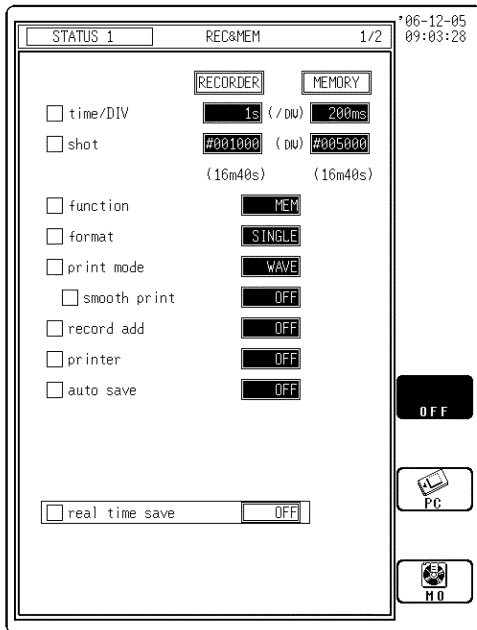

Procedure Screen: STATUS1

1. Press the **STATUS** key to call up the STATUS1 screen.
2. Move the flashing cursor to the **real time save** item, and use the function keys to make the selection. When Real-Time Save is selected, the time axis must be set to the valid range.

Function display

Meaning



: Real time save is disabled.



: Real time save data is stored on the PC card.



: Real time save data is stored on the Internal MO drive.

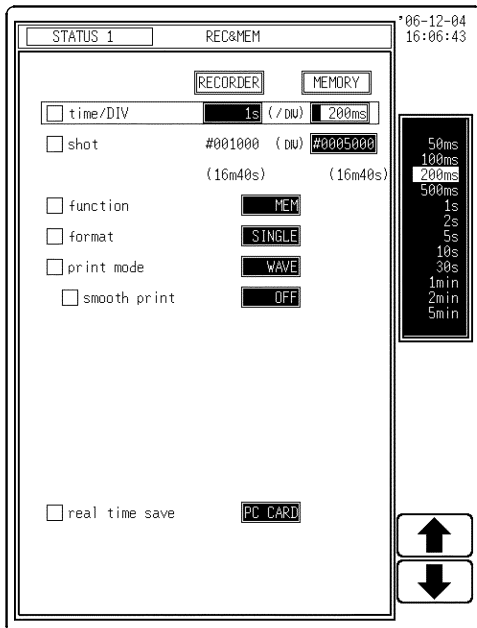

3. Move the flashing cursor to "Memory Time Axis", and select using the displayed function keys or jog control.
4. Select the "Recording Time Axis" at the same time.

Function display

Meaning



: Move the cursor up in the selection window.



: Move the cursor down in the selection window.

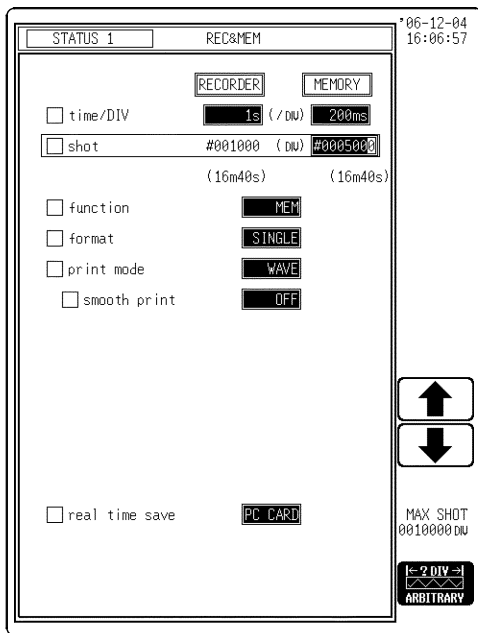

5. Move the blinking cursor to "Memory Recording Length", and select using the jog control or function keys.

Function display

Meaning



: Move the cursor up in the selection window.



: Move the cursor down in the selection window.

NOTE

- The sampling cycle of the recorder is the same as that set for the memory, so depending on the sampling cycle, there are some time axes that cannot be set for the recorder. Refer to Section 7.3.2, "Setting the Time Axis Range" for details.
- The recordable time (recording length) is determined by the space available on the media and the number of channels being saved and the recorder time axis range.
- The recording length of the recorder is determined automatically by the recorder time axis range, memory time axis range and memory recording length.
- Channels cannot be selected for real-time save (all displayed channel data waveforms are saved).
- Partial saving (only between cursors) is not possible even when the A-B cursors are displayed.
- When Real-Time Save is enabled, Auto Save, Auto Print, Additional Recording and Sequential Save settings are ignored.
- When measurement is aborted before the set recording length, the waveforms input prior to the abort are saved.
- Files with extensions MEM, REC and R_M are created during Real-Time Save. Refer to Section 14.7, "Saving the Data (SAVE)" for file name details.
- Real-Time Save cannot save data in text format ("Text Save").

Maximum Recording Time

The maximum settable recording time is determined by the space available on the media, the MEM and REC time axes and the selected recording length. However, the maximum REC recording length is limited to 1000 DIV (5000 with expanded memory), so the recording time cannot be set beyond this limit regardless of space available on the media.

The settable recording times for saving the 16 analog channels to PC card (1 GB) are shown below.

- (1) With the REC time axis set to the fastest values with respect to the MEM time axis (compression rate: small)

MEM time axis	MEM recording length	REC time axis	REC recording length	Maximum Recording Time
50 ms	4000	200 ms	1000	3m, 20s
100 ms	5000	500 ms	1000	8m, 20s
200 ms	5000	1 s	1000	16m, 40s
500 ms	4000	2 s	1000	33m, 20s
1 s	5000	5 s	1000	1h, 23m, 20s
2 s	5000	10 s	1000	2h, 46m, 40s
5 s	6000	30 s	1000	8h, 20m, 00s
10 s	6000	1 min	1000	16h, 40m, 00s
30 s	4000	2 min	1000	1d, 09h, 20m, 00s
1 min	5000	5 min	1000	3d, 11h, 20m, 00s
2 min	5000	10 min	1000	6d, 22h, 40m, 00s
5 min	6000	30 min	1000	20d, 20h, 00m, 00s

- (2) With memory expanded, and the REC time axis set to the fastest values with respect to the MEM time axis (compression rate: small)

MEM time axis	MEM recording length	REC time axis	REC recording length	Maximum Recording Time
50 ms	20000	200 ms	5000	16 m, 40 s
100 ms	25000	500 ms	5000	41 m, 40s
200 ms	25000	1 s	5000	1 h, 23 m, 20 s
500 ms	20000	2 s	5000	2 h, 46 m, 40 s
1 s	25000	5 s	5000	6 h, 56 m, 40 s
2 s	25000	10 s	5000	13 h, 53 m, 20 s
5 s	30000	30 s	5000	1 d, 17 h, 40 m, 00 s
10 s	30000	1 min	5000	3 d, 11 h, 20 m, 00 s
30 s	20000	2 min	5000	6 d, 22 h, 40 m, 00 s
1 min	25000	5 min	5000	17 d, 08 h, 40 m, 00 s
2 min	25000	10 min	5000	34 d, 17 h, 20 m, 00 s
5 min	30000	30 min	5000	104 d, 04 h, 00 m, 00 s

(3) With the REC time axis fixed at 1 h/DIV and any setting for the MEM time axis (compression rate: large)

MEM time axis	MEM recording length	REC time axis	REC recording length	Maximum Recording Time
50 ms	639680	1 h	8	8 h, 53 m, 04 s
100 ms	319830	1 h	8	8 h, 53 m, 03 s
200 ms	319810	1 h	17	17 h, 46 m, 02 s
500 ms	319750	1 h	44	1 d, 20 h, 24 m, 35 s
1 s	319670	1 h	88	3 d, 16 h, 47 m, 50 s
2 s	319490	1 h	177	7 d, 09 h, 29 m, 40 s
5 s	318960	1 h	443	18 d, 11 h, 00 m, 00 s
10 s	318070	1 h	883	36 d, 19 h, 31 m, 40 s

Memory not expanded:

MEM time axis	MEM recording length	REC time axis	REC recording length	Maximum Recording Time
30 s	120000	1 h	1000	41 d, 16 h, 00 m, 00 s
1 min	60000	1 h	1000	41 d, 16 h, 00 m, 00 s
2 min	30000	1 h	1000	41 d, 16 h, 00 m, 00 s
5 min	12000	1 h	1000	41 d, 16 h, 00 m, 00 s

Memory expanded:

MEM time axis	MEM recording length	REC time axis	REC recording length	Maximum Recording Time
30 s	314600	1 h	2621	109 d, 05 h, 40 m, 00 s
1 min	300000	1 h	5000	208 d, 08 h, 00 m, 00 s
2 min	150000	1 h	5000	208 d, 08 h, 00 m, 00 s
5 min	60000	1 h	5000	208 d, 08 h, 00 m, 00 s

Loading Real-Time Save Data

To load data saved by Real-Time Save, load the index file (R_M). Data loaded by the index file consists of all recorder waveforms and the header (2000 DIV, or 10,000 DIV when expansion memory is installed) of the memory waveform. Loading of the memory waveform is specified by use of the A-B cursors within the recorder waveform. Refer to Section 14.8, "Loading the Data (LOAD)" regarding loading data saved by Real-Time Save.

When Real-Time Save is finished, the recorder waveforms remain in memory, so it is not necessary to load the saved data.

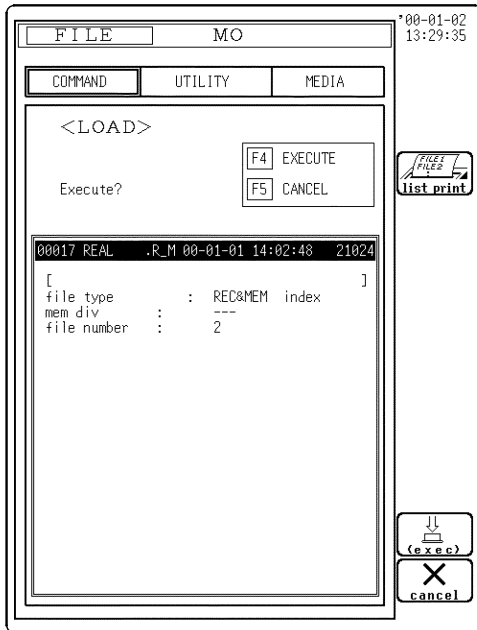

Procedure Screen: FILE

1. Press the **FILE** key to call up the FILE screen.
2. Move the flashing cursor to the **media** item, and use the function key to select the "PC card" or "MO".
3. Use the jog and shuttle controls or cursor keys to select the index file of the data to be loaded from the file list.
4. Move the flashing cursor to the **command** item, and use the function key to select the "LOAD".
5. Use the function keys to make selection.

Function display

Meaning



: Determines the data to load.



: Cancel the command to load.

Loading Memory Waveforms

The memory waveform is specified by use of the A-B cursors within the recorder waveform.

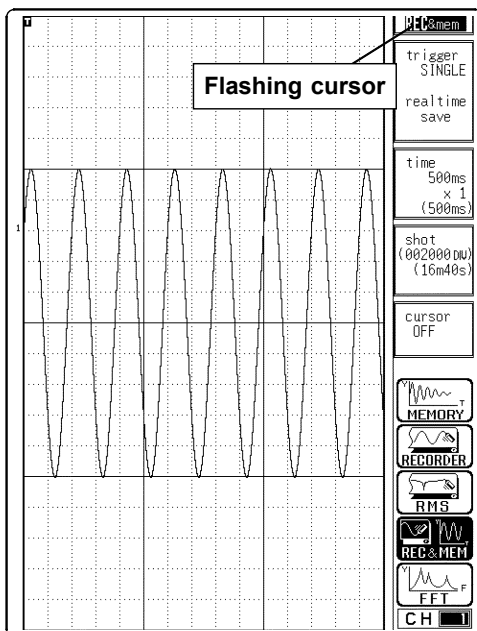

Procedure Screen: STATUS2

1. Press the **DISP** key to display the DISPLAY screen.
2. Move the blinking cursor to the location indicated in the figure.
Press function key F4 (Record & Memory) to display the recorder waveform screen (REC & mem).

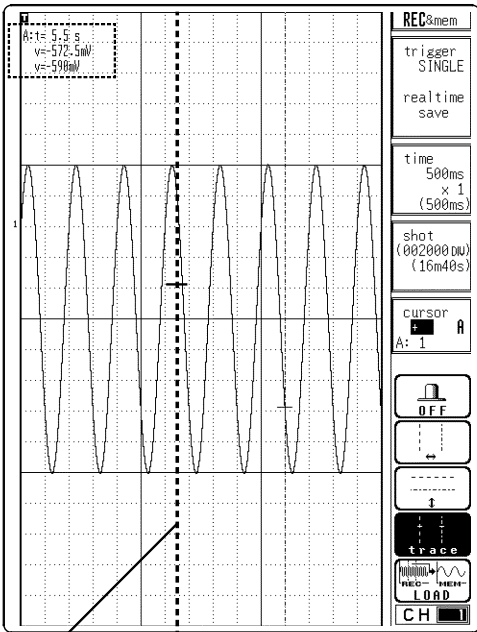

Cursor A Memory waveform loads

3. Specify the area to display as the memory waveform with the A-B cursors.
4. Use the function key to select the "LOAD".

Function display Meaning

 : Loads the memory waveform.

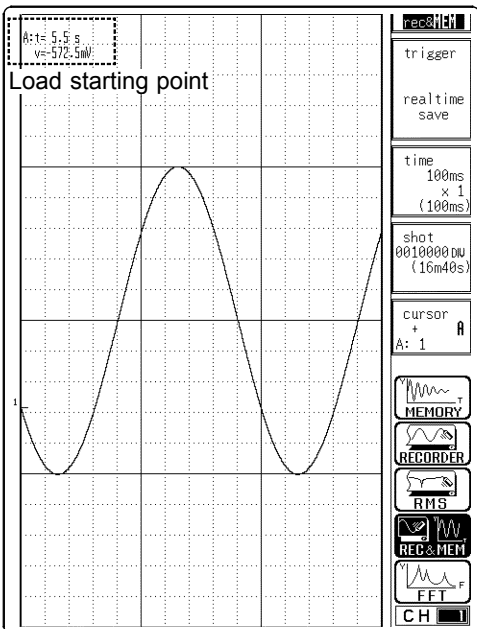

Memory Waveform Loading Example

In the figure at the left, cursor A marks the starting point for memory waveform loading at 5.5 s after trigger occurs. Pressing the LOAD function key loads the memory waveform.

The start of the loaded memory waveform screen is positioned 5.5 s after trigger.

NOTE

If the area specified by the A or A-B cursors exceeds the loadable area, 2000 DIVs are loaded from the head to the cursor position. (2000 DIV, or 10,000 DIV when expansion memory is installed)

7.4 Settings on the Waveform Display Screen (REC&MEM)

Explains the setting items on the Waveform display screen.

For details on setting, refer to Section 7.3.

When want to use the Jog/Shuttle control, press the **VALUE** select key. (The selection window is not displayed.)

Pressing the F4 function key "REC&MEM" on the Waveform display screen toggles screen between memory waveform and recorder waveform.

REC&mem Recorder waveform display in Recorder and Memory function

rec&MEM Memory waveform display in Recorder and Memory function

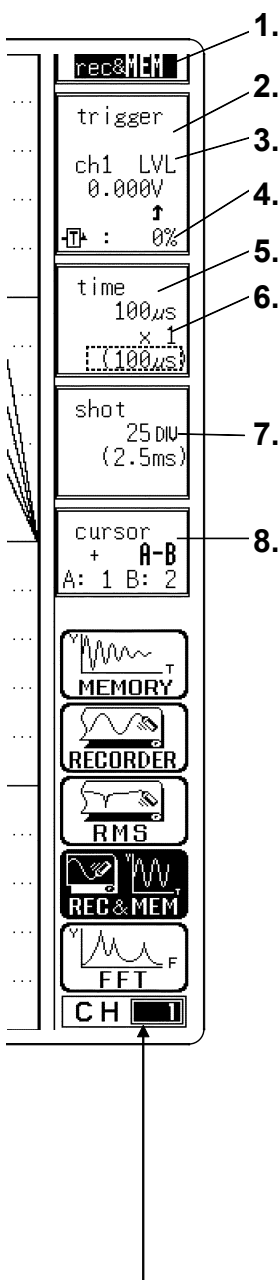

Setting items	Selection	Explanation
1. Function	MEM, REC, RMS, REC&MEM, FFT	Select function.
2. Trigger mode (recorder waveform)	SINGLE, REPEAT, TIMER	Select trigger mode.
3. Analog trigger (memory waveform)	OFF, LEVEL, OUT, IN, V-DROP, CYCLE	Set the analog trigger.
4. Pre-trigger	0 to 100%, -95%	Set the Pre-trigger.
5. Time Axis Range	20 ms/DIV to 1 h/DIV (REC) 100 µs/DIV to 5 min/DIV (MEM)	Set the speed for inputting and storing the waveform of the input signal. Time axis range setting expresses the time for 1 DIV.
6. Magnification /compression along the time axis	× 1 to × 1/500 (REC) × 10 to × 1/10000 (MEM)	By magnifying the waveform, detailed observations can be made. By compressing the waveform, an entire change can be promptly apprehended.
7. Recording Length	SELECT: 25 DIV to continuous (REC) 25 DIV to 2000 DIV (MEM) ARBITRARY: 1 DIV to 1000 DIV (REC) 1 DIV to 2000 DIV (MEM)	Using channels: 16 ch Capacity: 8 M words The length of recording for one measurement operation (the number of DIV) can be set.
8. Cursor Measurement	OFF, ↔, ↕, +	The A·B cursors can be used.
Input channel settings	• Analog input • Logic input	Enables the measurement conditions for each channel on the display screen to be set or changed. See Section 9.10.
Input level monitor function		Press the LEVEL MONI key. See Section 11.5.
VIEW function		Press the VIEW key. See Section 11.6.

Channels that may be changed with the **RANGE** knob (measurement range) and **POSITION** knob (zero position). This channel display is selected with Channel-select keys CH1 to CH16.

Changing the set channel in the CHANNEL or CH.SET screens modifies the setting accordingly.

7.5 Start and Stop Operation (REC&MEM)

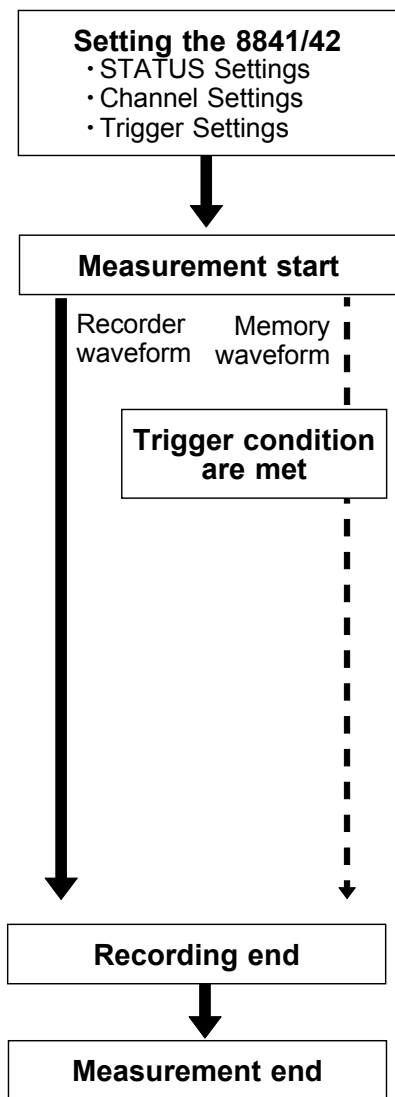

See Section 7.3, "STATUS Settings", Chapter 9, "Input Channel Settings", Chapter 10, "Trigger Functions."

Press the **START** key and LED light.

Setting the trigger to Timer causes a delay until the set time.

Displays "Storing" during storing the recorder waveform.

When the printer is enabled, the recording waveform is printed at the same time it is displayed.

Using the VIEW key to display the time (from measurement started time).

Data recording starts when trigger condition of memory waveform is met.

When Pre-Trigger is enabled during waveform storage, if the trigger conditions are met before the trigger point, data collection begins at that time.

When automatic storage is enabled and measurement is interrupted in progress, measurement data taken prior to the interruption point is stored automatically.

Auto save is executed.

End of measurement

Trigger mode	SINGLE	Starts measurement again.
	REPEAT	Waveform data stored in memory blocks is cleared. Automatic storage is not performed.
	TIMER	Measurement is repeated at the set time interval until the specified stop time.

NOTE A stored waveform read by the Recorder & Memory function can be subjected to waveform processing by the Memory function, but doing so erases the Recorder waveform.

During storing the waveform data, the following message is displayed:
 "MEMORY WAVE WAIT TRIG": Waiting for trigger
 "MEMORY WAVE STORING": Storing memory waveform
 "MEMORY WAVE STORE END": End of storing memory waveform
 When using the sequential save function:
 "MEMORY WAVE XXX/000": Displays stored block
 (XXX: the last stored block, 000: number of memory divisions)

Chapter 8

FFT Function

8.1 Overview of the FFT Function

The FFT function has the following features.

- (1) FFT (Fast Fourier Transform) processing can be performed on input signal data for frequency analysis.
- (2) Frequency range
133 mHz to 400 kHz
- (3) Frequency resolution
1/400, 1/800, 1/2000, 1/4000 of frequency range
- (4) 12 types of analysis functions
Storage waveform, linear spectrum, RMS spectrum, power spectrum, auto-correlation function, histogram, transfer function, cross-power spectrum, cross- correlation function, unit-impulse response, coherence function, octave analysis
- (5) Analysis modes
1-channel FFT, 2-channel FFT
- (6) Analysis of data stored with memory recorder function and recorder and memory function possible
- (7) Switchable antialiasing filter
Automatic selection of cutoff frequency to match frequency range (8938 FFT ANALOG UNIT)

NOTE

- We recommend using an input unit equipped with an anti-aliasing filter that can be enabled to minimize sampling distortions during FFT analysis.
- Refer to Appendix 3.10, "FFT Function" for more information about aliasing distortion and anti-aliasing filters.

8.2 Operation Sequence (FFT)

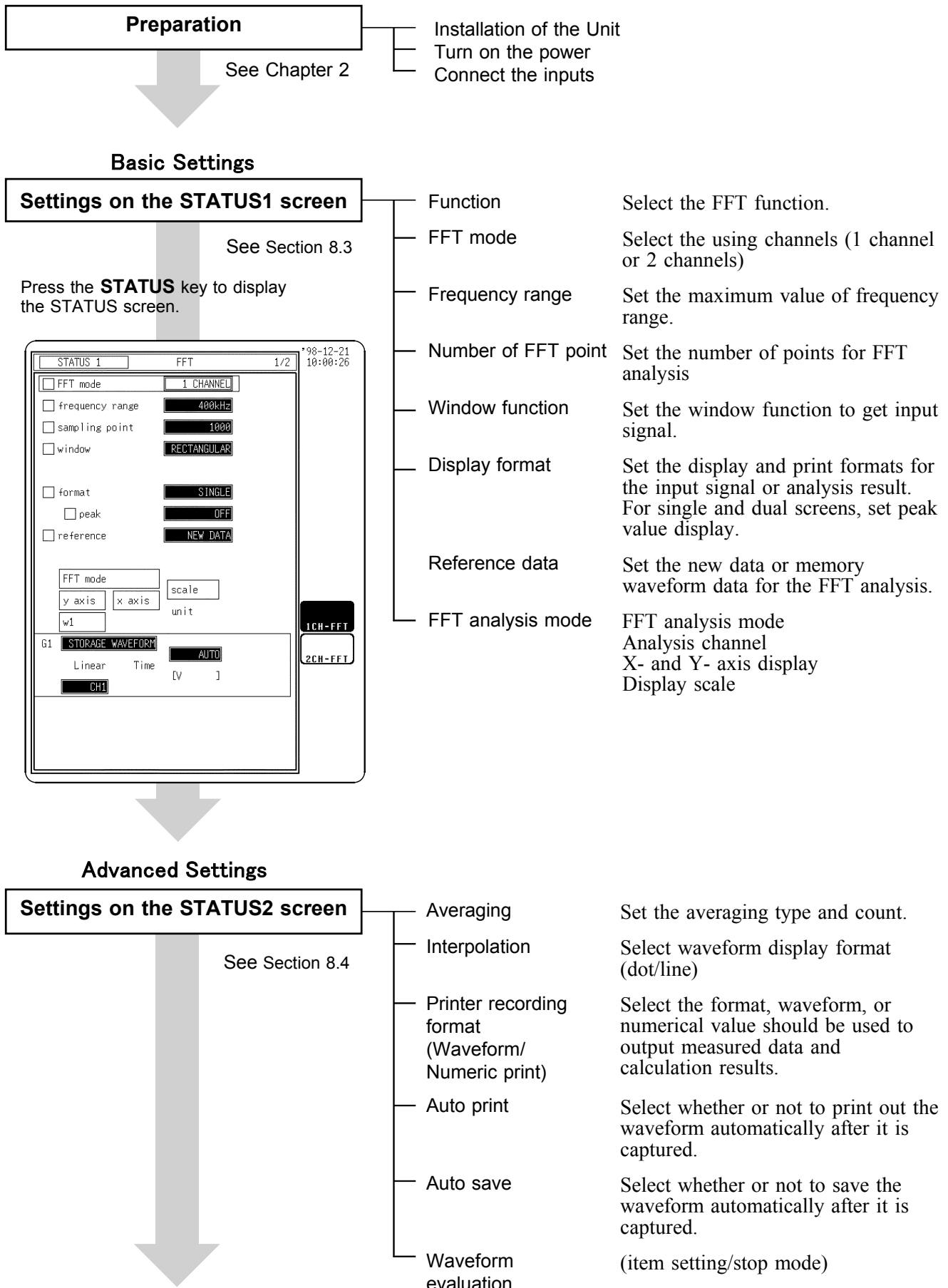

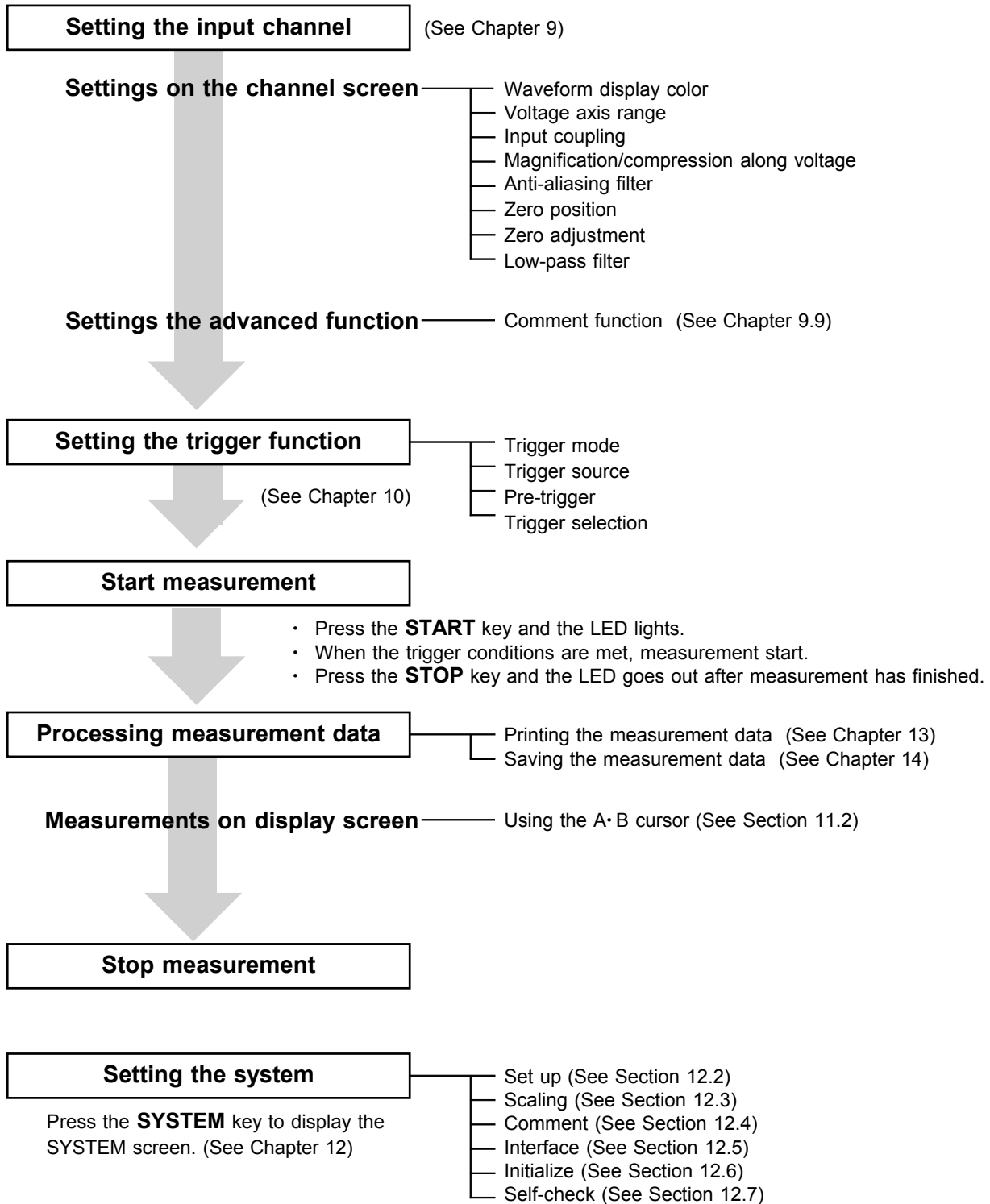

8.3 STATUS1 Settings (FFT)

Press the **STATUS** key to access the STATUS1 screen. This section explains how to set the STATUS1 screen of the FFT function. See the corresponding sections for items that can be set in the Waveform display or CHANNEL screens.

Waveform display screen: See Section 8.5

CHANNEL screen: See Section 9.3

The screenshot shows the STATUS1 screen for the FFT function. The top bar displays 'STATUS 1', 'FFT', and '1/2'. The date and time are '00-01-05' and '13:54:55'. The main menu items are: FFT mode (2 CHANNELS), frequency range (400kHz), sampling point (1000), window (EXPONENTIAL), coefficient (0%), format (DUAL), peak (PEAK), reference (NEW DATA), and octave filter (NORMAL). Below these are sub-menus for FFT mode, y axis, x axis, w1, w2, scale, upper, unit, and lower. The G1 section is TRANSFER FUNCTION (AUTO) with LIN-MAG, LIN-Hz, CH1, and CH2 options. The G2 section is OCTAVE ANALYSIS (MANUAL) with LIN-MAG, 1/3 OCT, CH2, and two numerical values (+1.0000E+00 and +0.0000E+00). On the right, there are icons for MEMORY, RECORDER, RMS, REC&MEM, and FFT, each with a corresponding section reference.

Item	Value	Section Reference
STATUS 1	FFT	8.3.1
FFT mode	2 CHANNELS	8.3.2
frequency range	400kHz	8.3.3
sampling point	1000	8.3.4
window	EXPONENTIAL	8.3.5
coefficient	0%	
format	DUAL	8.3.6
peak	PEAK	
reference	NEW DATA	8.3.7
octave filter	NORMAL	8.3.12
FFT mode		
y axis		
x axis		
w1		
w2		
scale		
upper		
unit		
lower		
G1 TRANSFER FUNCTION	AUTO	8.3.8
LIN-MAG		
LIN-Hz		
CH1		
CH2		
G2 OCTAVE ANALYSIS	MANUAL	8.3.11
LIN-MAG		
1/3 OCT		
CH2		
Value 1	+1.0000E+00	8.3.9
Value 2	+0.0000E+00	8.3.10
MEMORY		
RECORDER		
RMS		
REC&MEM		
FFT		





8.3.1 Setting the Function Mode

The 8841/42 has five function modes. Select the FFT function.

Procedure

Screen: STATUS1, CHANNEL, Waveform display, TRIGGER

1. Use the Menu keys to display the desired screen.
2. Move the flashing cursor to the top position.
3. Select the **FFT** function key display.

Function display	Meaning
	: Memory recorder function
	: Recorder function
	: RMS recorder function
	: Recorder & Memory recorder function
	: FFT function



8.3.2 Setting the FFT Channel Mode

This setting determines whether only one channel (1ch-FFT) or two channels (2ch-FFT) are used for FFT processing. When "1ch-FFT" is selected, certain FFT analysis modes will not be available.

Screen: STATUS1

Procedure

1. Use the Menu keys to display the desired screen.
2. Move the flashing cursor to the **FFT mode** item.
3. Use the function key to make the selection.

Function display	Meaning
	: One channel
	: Two channels

NOTE

The following analysis functions are not possible in 1-channel FFT mode: Transfer function (TRF), cross-power spectrum (CSP), cross-correlation function (CCR), unit impulse response (IMP), coherence function (COH)

8.3.3 Setting the Frequency Range

The frequency range (frequency axis maximum value) can be set as follows. The frequency range corresponds to the time axis range (TIME/DIV) setting of the memory function.

Screen: STATUS1, Waveform display

- Procedure**
1. Use the Menu keys to display the desired screen.
 2. Move the flashing cursor to the **frequency range** item.
 3. Use the function key to make the selection.

Function
display

Meaning



: Move the cursor up in the selection window.



: Move the cursor down in the selection window.

NOTE

- The antialiasing filter (8938) cutoff frequency is the same as the selected frequency range.
- When "EXT." was selected, octave analysis cannot be carried out.
- To use external sampling, see Section 17.1.4.

Frequency Range, Frequency Resolution, Window Width, Corresponding Time Axis Range (when the number of FFT points is 1000)

Frequency range [Hz]	Frequency resolution*3[Hz]	Window width*4	Time axis [/DIV]
400 k*1	1 k	1 ms	100 μs
200 k*1	500	2 ms	200 μs
80 k*1	200	5 ms	500 μs
40 k	100	10 ms	1 ms
20 k	50	20 ms	2 ms
8 k	20	50 ms	5 ms
4 k	10	100 ms	10 ms
2 k	5	200 ms	20 ms
800	2	500 ms	50 ms
400	1	1 s	100 ms
200	500 m	2 s	200 ms
80	200 m	5 s	500 ms
40	100 m	10 s	1 s
20	50 m	20 s	2 s
8 *2	20 m	50 s	5 s
4 *2	10 m	100 s	10 s
1.33 *2	3.33 m	5 min	30 s
667 m*2	1.67 m	10 min	1 min
333 m*2	0.83 m	20 min	2 min
133 m*2	0.33 m	50 min	5 min

The cutoff frequency of the antialiasing filter is the same as the selected frequency range, except for the cases listed below.

*1: Antialiasing filter is OFF.

*2: Cutoff frequency is 20 Hz.

*3: FFT Number of Points values of 2000, 5000 and 10,000 correspond to multiples of 1/2, 1/5 and 1/10, respectively.

*4: FFT Number of Points values of 2000, 5000 and 10,000 correspond to multiples of 2, 5 and 10, respectively.

8.3.4 FFT Number of Points Setup

This setting determines the sample count (Number of Points) used for FFT calculation. A higher setting increases the frequency analysis capability, but also increases the processing time required.

Screen: STATUS1, Waveform display

- Procedure**
1. Use the Menu keys to display the desired screen.
 2. Move the flashing cursor to the **sampling point** item.
 3. Use the function key to make the selection.

Function display	Meaning
	: 1000 points FFT calculation
	: 2000 points FFT calculation
	: 5000 points FFT calculation
	: 10000 points FFT calculation

8.3.5 Setting the Window Function





The window function defines the segment of the input signal that will be processed. Window processing can be used to minimize leakage error.

Screen: STATUS1, Waveform display

- Procedure**
1. Use the Menu keys to display the desired screen.
 2. Move the flashing cursor to the **window** item.
 3. Use the function key to make the selection.

Function display	Meaning
	: Rectangular (effective on discrete waveforms)
	: Hanning (effective on continuous waveforms)
	: Exponential (effective on decaying waveforms)

4. If **EXPO** was selected, the coefficient item is displayed. Select the attenuation ratio in percent, using the function keys or the Jog/shuttle controls. If coefficient (attenuation ratio) is set to 0%, processing will be carried out as 0.1%.

Function display	Meaning
	: Increases in number, large step
	: Increases in number, small step
	: Decreases in number, small step
	: Decreases in number, large step

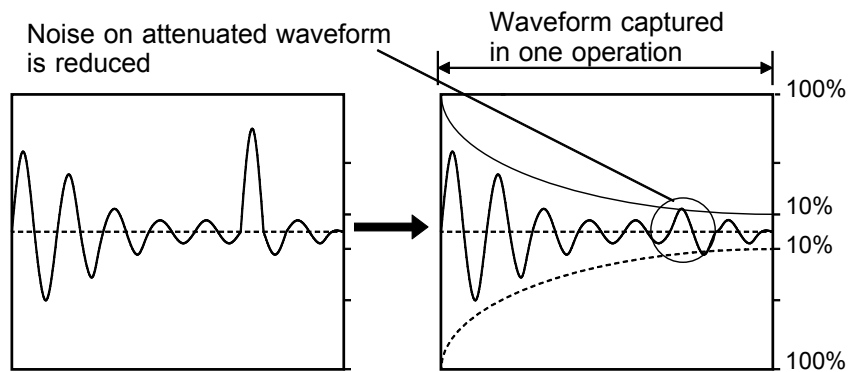

NOTE



When measurements are taken using the Hanning window or exponential window, note that the calculation results in the display of a value that is lower than the amplitude obtained when using a rectangular window.

8.3.6 Setting the Display Format



You can set the format for displaying input signal waveforms on the screen and recording them on the printer. The SINGLE, DUAL, and NYQUIST formats are available.

Screen: STATUS1

- Procedure**
1. Press the **STATUS** key to display the screen to be displayed.
 2. Move the flashing cursor to the **format** item.
 3. Use the function key to make the selection.

Function display	Meaning
	: Single screen
	: Dual screen
	: Nyquist screen

4. When the display format is set to single or dual, the **peak** item is displayed.

Function display	Meaning
 OFF	: OFF
 PEAK	: Peak value
 MAX	: Maximum value

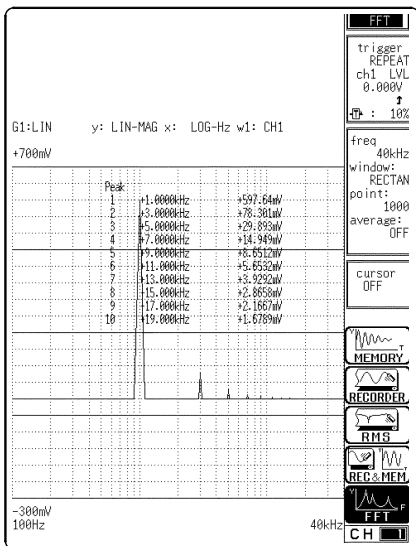

Peak value display

When data at one point are higher than data within the vicinity, the point is a peak. The 10 highest peaks are shown.

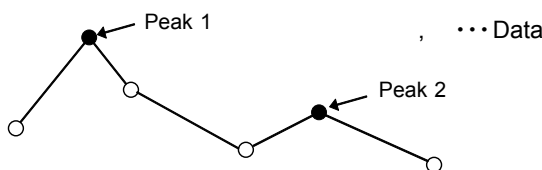

Maximum value display

Points with the 10 highest values are shown.

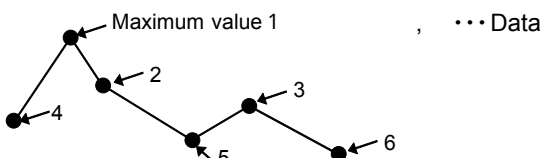

Single graph

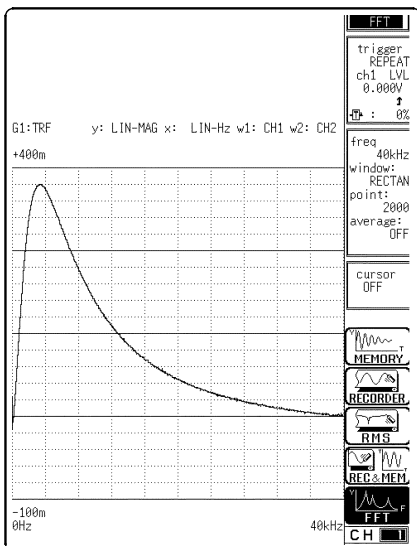

Displays the waveform on a single screen.

Dual graph

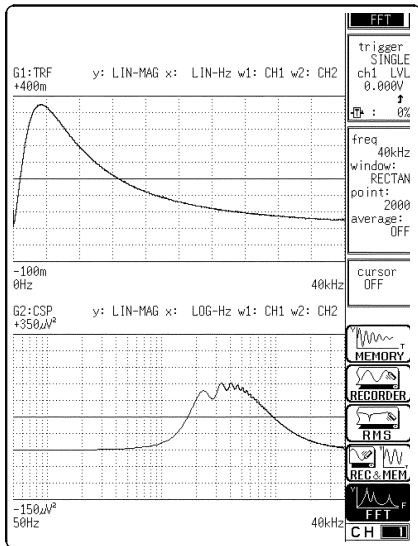

Divides the waveform display screen into upper and lower screens.

Nyquist graph

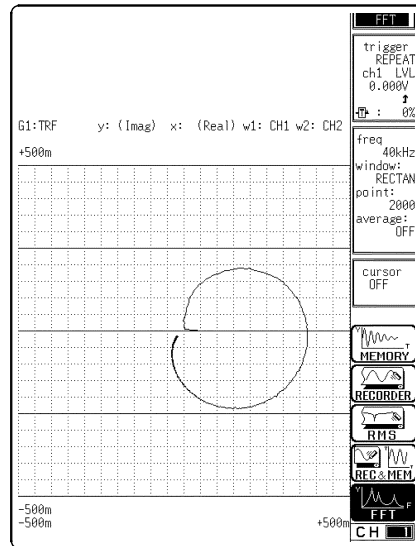

For the linear spectrum, cross power spectrum, and transfer function, displays the real-number portion of the data for the FFT calculation result on the X-axis, and the imaginary number portion of the data on the Y-axis.

NOTE

The peak value is displayed on the screen and printed out, but it is not recorded as the peak value in data storage.



8.3.7 Selecting Reference Data

Select data to be used for FFT processing.

Procedure

Screen: STATUS1

1. Press the **STATUS** key to display the STATUS1 screen.
2. Move the flashing cursor to the **reference** item.
3. Use the function keys to make a setting.

Function display	Meaning
	: Capture new waveform data for FFT processing
	: Use stored waveform data for FFT processing

New data

Pressing the **START** key initiates measurement, reads the number of samples specified as the FFT Number of Points, and FFT processing is performed.

Memory waveform

Pressing the **START** key initiates FFT processing of the specified FFT Number of Points, from the start of the data (Memory Recorder or memorized Recorder & Memory waveform) that has been stored in memory.

The starting point for calculation can be specified using the cursor on the screen with the stored Recorder & Memory waveform displayed.

If the A·B cursors are used, the FFT calculation is performed on the specified FFT Number of Points beginning with whichever cursor is foremost.

When a memory waveform is selected, the frequency is automatically set to correspond with the time axis as indicated in frequency range setup table in section 8.3.3.

NOTE

If a memory waveform is the reference data when the trigger mode is Continuous and Automatic, FFT processing is performed on the waveform data collected by the Memory Recorder function for the specified FFT Number of Points, and then shifted by that amount and processed again, until all data has been processed. (If the data is shorter than the FFT Number of Points, no processing occurs.)

8.3.8 Setting the FFT Analysis Mode

Used to select the FFT calculation method.

Procedure Screen: STATUS1, Waveform display

1. Use the Menu keys to display the desired screen.
2. Move the flashing cursor to the **FFT mode** item.
3. Use the function keys to make a setting.

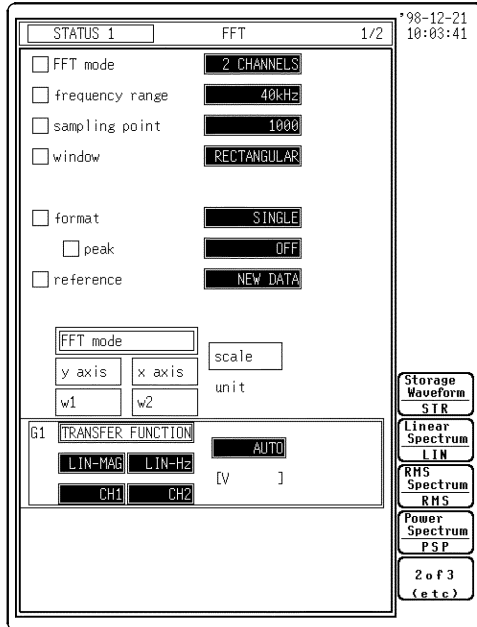

Function display	Meaning	Function display	Meaning
Storage Waveform STR	: Stored waveform	Transfer TRF	: Transfer function
Linear Spectrum LIN	: Linear spectrum	Cross Power Spectrum CSP	: Cross power spectrum
RMS Spectrum RMS	: RMS spectrum	Cross Correlation CCR	: Cross correlation function
Power Spectrum PSP	: Power spectrum	Impulse Response IMP	: Impulse response
Auto Correlation ACR	: Auto correlation function	Coherence COH	: Coherence function
Histogram HIS	: Histogram	Octave OCT	: Octave analysis

8.3.9 Setting the X-axis and Y-axis Displays





Set the X and Y axis for display of FFT calculation results. Different units can be selected for the X and Y axis. With some FFT analysis modes, one of the axis cannot be set.

When external sampling is used, the X-axis (horizontal axis) expresses the data count.



Procedure Screen: STATUS1, Waveform display

1. Use the Menu keys to display the desired screen.
2. Move the flashing cursor to the **y-axis** item.
3. Use the function keys or Jog control, select the channel. Set the x-axis in the same way.



Y-axis

Function display	Meaning
	: Real number part (linear display)
	: Imaginary number part (linear display)
	: Amplitude (linear display)
	: Amplitude (decibel display)
	: Phase (degree display)

X-axis

Function display	Meaning
	: Frequency (linear display)
	: Frequency (logarithm display)

(When octave analysis)

Function display	Meaning
	: 1/3 octave
	: 1/1 octave

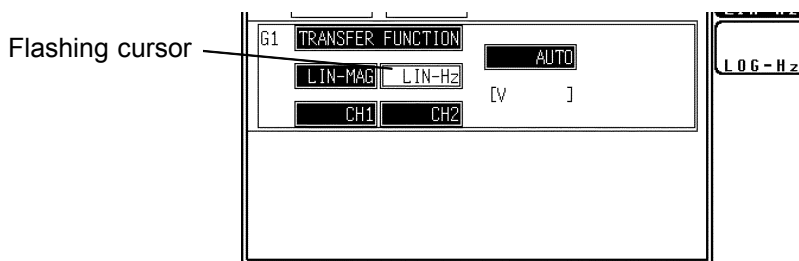

X and Y Axis Settings Available with each FFT Analysis Mode

FFT analysis mode		X-axis (horizontal axis)	Y-axis (vertical axis)
STR	Storage Waveform	(Time)	(Linear)
LIN	Linear Spectrum	LIN-Hz LOG-Hz	LIN-REAL LIN-IMAG LIN-MAG LOG-MAG PHASE
RMS	RMS Spectrum	LIN-Hz LOG-Hz	LIN-REAL LIN-IMAG LIN-MAG LOG-MAG PHASE
PSP	Power Spectrum	LIN-Hz LOG-Hz	LIN-MAG LOG-MAG
ACR	Auto Correlation Function	(Time)	(Linear)
HIS	Histogram	(Volt)	(Linear)
TRF	Transfer Function	LIN-Hz LOG-Hz	LIN-REAL LIN-IMAG LIN-MAG LOG-MAG PHASE
CSP	Cross Power Spectrum	LIN-Hz LOG-Hz	LIN-REAL LIN-IMAG LIN-MAG LOG-MAG PHASE
CCR	Cross Correlation Function	(Time)	(Linear)
IMP	Unit Impulse Response	(Time)	(Linear)
COH	Coherence Function	LIN-Hz LOG-Hz	(Linear)
OCT	Octave Analysis	1/3 OCT 1/1 OCT	LIN-MAG LOG-MAG



The item shown by brackets (), it is fixed.

8.3.10 Setting the Analysis Channel

Select the channel for FFT analysis.

Procedure Screen: STATUS1, Waveform display

1. Use the Menu keys to display the desired screen.
2. Move the flashing cursor to the **w1** or **w2** item.
3. Use the function keys or Jog/shuttle control, select the channel.

Function display	Meaning
	: Move the cursor up in the selection window.
	: Move the cursor down in the selection window.

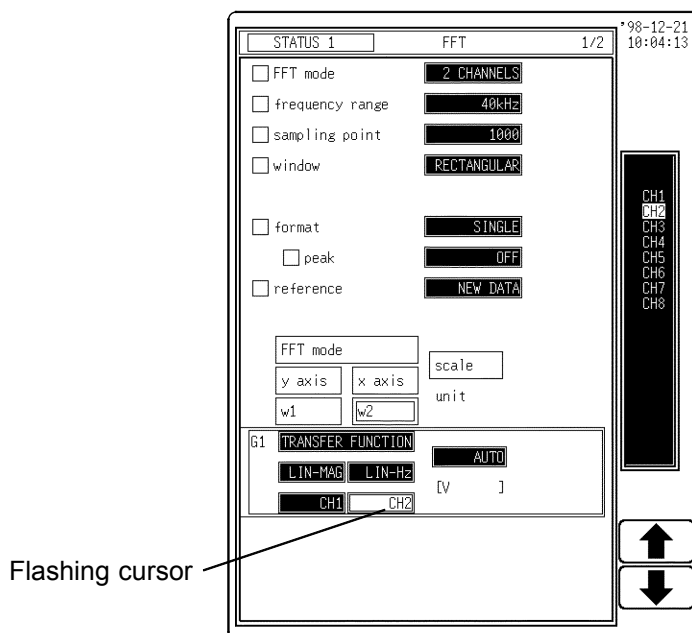

NOTE



- The values for transmission interval and single impulse response are calculated from $(W2)/(W1)$.
- To analyze data without aliasing distortion due to sampling, we recommend that you use a channel input unit that is capable of FFT analysis, such as the 8938 FFT ANALOG UNIT.

8.3.11 Setting the Display Scale

The display scale for showing the FFT processing result can either be set manually or automatically.

Procedure Screen: STATUS1

1. Press the **STATUS** key to display the STATUS1 screen.
2. Move the flashing cursor to the **scale** item.
3. Use the function keys to make a setting.

Function display	Meaning
	: The vertical axis (Y-axis) scale is set automatically, depending on the processing result.
	: The vertical axis (Y-axis) scale can be set as desired, to match the purpose of the measurement. This is useful for enlarging or reducing the amplitude and for shifting the waveform up or down.



4. When **MANUAL** is selected, set the upper and lower limits to display and record the processing result.

Setting range is $-9.9999\text{E}+29$ to $9.9999\text{E}+29$. (exponent is E-29 to E+29).

Numerical setting procedure

Procedure 1

1. Using the cursor keys, move the flashing cursor to the item (upper/lower limit value) to be input.
2. Move the flashing cursor to the digit to be input.
3. Use the function keys or Jog control to enter the numerical value. (To move the digit, use the function keys or Shuttle control.)

Function display	Meaning
	: Increases the number.
	: Decreases the number.

Procedure 2

1. Select the **use num.key** function key.
2. Enter the numerical value by using the numerical input key.

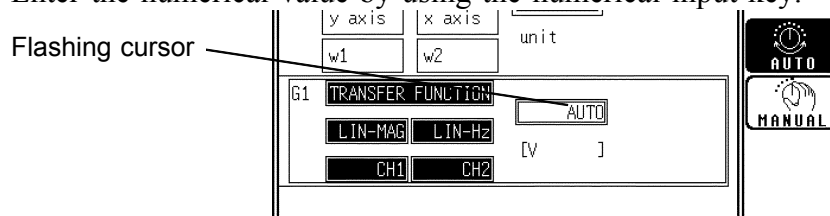

NOTE

- The unit (eu) setting is affected by the scaling setting. When scaling is turned off, a unit of measurement range is displayed.
- The selected unit is displayed for those channels for which the scaling function has been set.
- The X-axis setting for the histogram can be changed on the Waveform display screen or the CHANNEL screen. (If the upper or lower limit value is changed, the x-axis is changed.)

8.3.12 Octave Filter Setting



When octave analysis has been selected, two different filter types can be chosen.

The characteristics of both filter types are within ANSI CLASS 3 tolerance limits (1/3 octave only).

Procedure

Screen: STATUS1

1. Select "octave analysis" in FFT analysis mode, and the **octave filter** item is shown.
2. Move the flashing cursor to the **octave filter** item.
3. Use the function keys to make a selection.

Function display	Meaning
	: Filter characteristics approximate the characteristics used for conventional octave analyzers with analog filters.
	: Spectrum components outside the octave band are excluded totally and only the spectrum in the octave band is bundled and used for analysis.

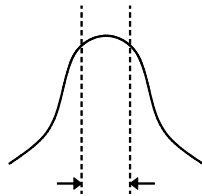

1/1-octave (1/3-octave)
normal filter characteristics

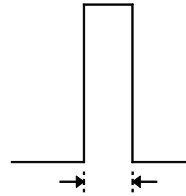

1/1-octave (1/3-octave)
sharp filter characteristics

NOTE

This unit does not use analog filters. It first determines the entire power spectrum and then uses weighting by bundling the spectrum to achieve the desired filter characteristics.

8.4 STATUS2 Settings (FFT)

Press the **STATUS** key to access the STATUS2 screen. This section explains how to set the STATUS2 screen of the FFT function. See the corresponding sections for items that can be set in the Waveform display or CHANNEL screens.

Waveform display screen: See Section 8.5

CHANNEL screen: See Section 9.3

STATUS 2		2/2	*99-10-18 16:51:28	See Sections
<input type="checkbox"/> averaging	TIME-LINEAR			8.4.1
<input type="checkbox"/> number	2			
<input type="checkbox"/> dot-line	LINE			8.4.2
<input type="checkbox"/> print mode	LOGGING			8.4.3
<input type="checkbox"/> interval	1 point			8.4.4
<input type="checkbox"/> auto print	OFF			8.4.4
<input type="checkbox"/> auto save (means)	FLOPPY SAVE			8.4.5
<input type="checkbox"/> type(file name)	BINARY AUTO			
<input type="checkbox"/> wave comparison	OUT			8.4.6
<input type="checkbox"/> stop mode	GO			

page 1 / 2







page 2 / 2

8.4.1 Setting the Averaging Function



- The averaging function allows capturing several instances of a waveform and determining the average.
- This makes it possible to eliminate noise and irregular signal components.
- Averaging for the time axis waveform and frequency axis waveform can be selected.

Procedure Screen: STATUS2, Waveform display

1. Use the Menu keys to display the desired screen.
2. Move the flashing cursor to the **averaging** item.
3. Use the function keys to make a setting.

Function display	Meaning
	: Disable averaging
	: Perform time axis waveform simple averaging
	: Perform time axis waveform exponential averaging
	: Perform frequency axis waveform simple averaging
	: Perform frequency axis waveform exponential averaging
	: Frequency axis waveform peak hold

4. Move the flashing cursor to the count item, and set the time of averaging count by using the Jog/Shuttle controls or function keys.

Function display	Meaning
	: Move the cursor up in the selection window.
	: Move the cursor down in the selection window.

Time axis waveform averaging

- (1) Averages collected waveform data
 - (2) FFT processing is then performed on the averaged values
- When the trigger mode is AUTO

When the **START** key is pressed, data are captured even if trigger conditions are not fulfilled after a certain interval. If averaging is applied to unsynchronized input signals, the result will be meaningless.

Frequency axis waveform averaging

Unlike time axis averaging, the results are valid also if no trigger synchronization is used. But if the characteristics of the input waveform allow triggering, using the trigger for synchronization is recommended.

- (1) Captured data first undergo FFT processing.
- (2) Averaging is performed and the result is displayed.

Frequency axis peak hold

The specified number of samples are captured, and the peak value is held (stored) for each frequency.

NOTE

- For details on summing averaging and exponential averaging, refer to Appendix 3.6.
- When averaging is used together with the waveform evaluation function, waveform evaluation is carried out after the specified averaging count is completed.
- After calculating the average, changing the analysis channel does not cause recalculation.

FFT analysis mode and averaging

- : Setting is valid
- : Setting is invalid (has no effect)

FFT analysis mode	Y-axis	Time axis averaging	Frequency axis averaging	Peak hold
Storage waveform	(Linear)			-
Linear spectrum	LIN-REAL LIN-IMAG LIN-MAG LOG-MAG PHASE		-	-
RMS spectrum	LIN-REAL LIN-IMAG LIN-MAG LOG-MAG PHASE		-	-
Power spectrum	LIN-MAG LOG-MAG			
Auto correlation function	(Linear)			
Histogram	(Linear)		-	-
Transfer function	LIN-REAL LIN-IMAG LIN-MAG LOG-MAG PHASE		-	-
Cross power spectrum	LIN-REAL LIN-IMAG LIN-MAG LOG-MAG PHASE		-	-
Cross correlation function	(Linear)			
Unit impulse response	(Linear)			
Coherence function	(Linear)			
Octave analysis	LIN-MAG LOG-MAG			

Same for linear spectrum, transfer function, and cross-power spectrum with Nyquist display.

Averaging and trigger mode

(1) Trigger mode: SINGLE

1. After the **START** key was pressed, data are captured whenever the trigger conditions are fulfilled, averaging is carried out, and then the waveform is displayed.

Collected waveform data is averaged with the FFT time axis waveform and FFT processing is performed. FFT processing is performed on the frequency axis and the calculated result is averaged.

2. Trigger occurs when the trigger conditions are fulfilled again.
3. When the specified number of data has been captured, measurement stops automatically. If the measurement was stopped prematurely with the **STOP** key, the averaging result up to that point is displayed.

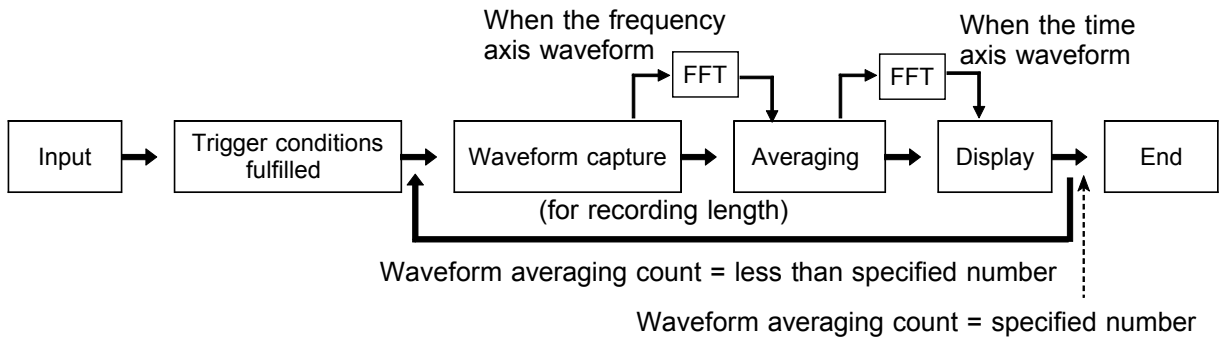

(2) Trigger mode: REPEAT

1. After the **START** key was pressed, data are captured whenever the trigger conditions are fulfilled, and averaging is carried out until the specified averaging count. The averaging result is shown on the display.
2. Trigger occurs when the trigger conditions are fulfilled again. The waveform data is cleared and the trigger occurs when the trigger conditions are fulfilled again
3. When the specified averaging count is reached, data up to that point are discarded, and new data are captured for averaging. If the measurement was stopped prematurely with the **STOP** key, the averaging result up to that point is displayed.

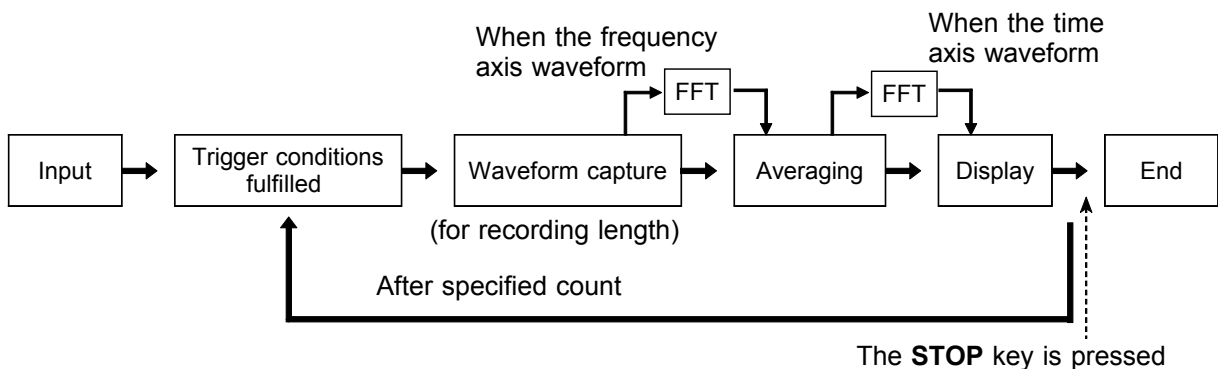

(3) Trigger mode: AUTO

(Time axis waveform)

When the **START** key is pressed, data are captured even if trigger conditions are not fulfilled after a certain interval. If averaging is applied to unsynchronized input signals, the result will be meaningless.

(Frequency axis waveform)

1. After the **START** key was pressed, data are captured whenever the trigger conditions are fulfilled, and averaging is carried out until the specified averaging count. The averaging result is shown on the display.
2. When the specified number of data has been captured, measurement stops automatically.
3. If the measurement was stopped prematurely with the **STOP** key, the averaging result up to that point is displayed.

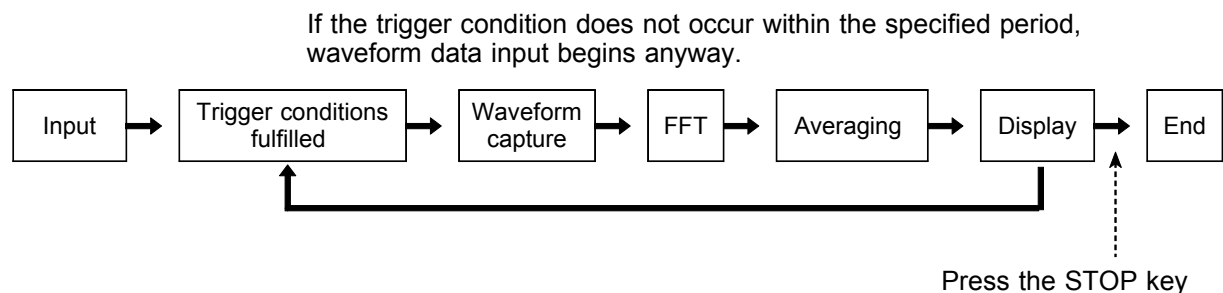

8.4.2 Setting the Interpolation (dot-line)

This setting determines whether the input waveform (sampling data) is to be displayed and printed as a series of dots or a line using linear interpolation.

Procedure Screen: STATUS2

1. Press the **STATUS** key to display the STATUS2 screen.
2. Move the flashing cursor to the **dot-line** item.
3. Use the function keys to make a setting.

Function display

Meaning



: Linear interpolation is not performed.



: Linear interpolation is performed.



8.4.3 Setting the Print Mode

Select the format, waveform, or numerical value should be used to output FFT processing results.

Procedure Screen: STATUS2



(1) Setting the printer format

1. Press the **STATUS** key to display the STATUS2 screen.
2. Move the flashing cursor to the **print mode** item.
3. Use the function keys to make a setting.

Function display	Meaning
	: The result of calculation are printed as a waveform.
	: The result of calculation are printed as numeric data.

(2) Setting the print interval

1. When the numerical value is selected, set the print interval. (unit: points)
2. Move the flashing cursor to the **interval** item.
3. Use the function keys to make a setting.



Function display	Meaning
	: Move the cursor up in the selection window.
	: Move the cursor down in the selection window.

8.4.4 Setting the Auto Print Function

Printout is automatically carried out after FFT analysis.

Procedure Screen: STATUS2

1. Press the **STATUS** key to display the STATUS2 screen.
2. Move the flashing cursor to the **auto print** item.
3. Use the function keys to make a setting.

Function display	Meaning
	: Auto print is disabled.
	: Automatically printed to the internal printer.
	: A LAN is used to transfer printing images to the 9333 LAN COMMUNICATOR.

8.4.5 Setting the Auto Save Function

The FFT analysis is carried out and measurement data are automatically stored on a floppy disk, PC card, MO disk or connected SCSI device after they are captured. The Auto Save function stores a file in the directory currently selected on the file screen. See Section 14.12.2.

Procedure Screen: STATUS2

1. Press the **STATUS** key to display the STATUS2 screen.
2. Move the flashing cursor to the **auto save** item.
3. Use the function keys, select the media for auto saving.

Function display	Meaning
------------------	---------



: Auto save is disabled.



: Automatically stored on floppy disk

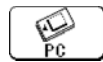

: Automatically stored on PC card.

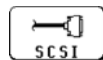

: Automatically stored on connected SCSI device.



: Automatically stored on MO disk.



: (When using a LAN card)
A LAN is used to transfer data to the 9333 LAN COMMUNICATOR.

4. When Media is selected, the Storage method item appears.

Function display	Meaning
------------------	---------



: When the media becomes full, automatic storage stops.



When the media becomes full, old files are deleted to make room for automatic storage.

: With the binary format selected, the file with the extension 'FFT' is deleted.
With the text format selected, files with the extension 'TXT' are deleted.

5. Move the flashing cursor to **type**, and select the format.

Function display	Meaning
------------------	---------



: Data are stored as binary data.

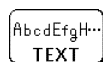

: Data are stored as text data.

Data stored in the text format is not readable by the 8841/42.

6. Set the file name. For the input method, refer to Section 9.9.3.
When using auto-save, a number is appended to the name you specify as the file name. This then becomes the file name. If you start procedures before specifying a file name, AUTO is automatically enabled.

File names cannot contain the characters +, -,], or [. Please note that file names containing these characters will not be saved.

NOTE





- File names consist of 8 characters (or 4 double-byte characters). With auto-save, since numbers are attached to the end of file names, long file names are truncated when this number is appended to the end of the file name.
- When auto-save is enabled, the storage channel cannot be selected. Data for the channel for which the waveform is displayed is saved.
- For details on auto saving file name, refer to Section 14.7.
- When both auto-print and auto-save are enabled, auto-save takes precedence.
- For details on connected SCSI device, refer to Section 14.4.
- The directory and the number of files that can be stored in the directory are limited. For details, see Section 14.7.
- Thinning is not applied with FFT data text format storage.
- When "COMMUNI" (communications) is selected as Media, Storage Method and Type are not displayed.

8.4.6 Setting the Waveform Evaluation

- Display format can be set on single screen or Nyquist screen.
- GO (pass) or NG (fail) evaluation of the input signal waveform can be performed using an evaluation area specified by the user. This can serve to detect irregular waveforms. After the evaluation result is generated, signals are output from the GO/NG terminal. All the channels being displayed are evaluated.

ProcedureScreen: STATUS2

1. Press the **STATUS** key to display the STATUS2 screen.
2. Move the flashing cursor to the **wave comparison** item.
3. Use the function keys to make a selection.

Function display	Meaning
	: Disable waveform evaluation
	: Return NG if any part of the waveform leaves the evaluation area
	: Return NG if the entire waveform leaves the evaluation area
	: Evaluation area is created.

NOTE

When a waveform evaluation area is created by the FFT function, the waveform evaluation area created by the memory recorder function is cleared. For details on the waveform evaluation, refer to Section 16.3.

8.5 Settings on the Waveform Display Screen (FFT)

Explains the setting items on the Waveform display screen.

For details, refer to Sections 8.3 and 8.4.

When want to use the Jog/Shuttle control, press the **VALUE** select key. (The selection window is not displayed.)

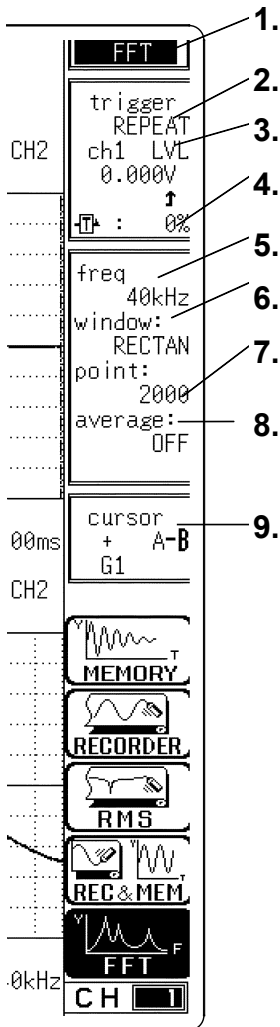

Setting items	Selection	Explanation
1. Function	MEM, REC, RMS, REC&MEM, FFT	Select function.
2. Trigger mode	SINGLE, REPEAT, AUTO	Select trigger mode.
3. Analog trigger	OFF, LEVEL, OUT, IN, V-DROP, CYCLE	Set the analog trigger.
4. Pre-trigger	0 to 100%, -95%	Set the Pre-trigger.
5. Frequency range	133 mHz to 400 kHz (20 steps), EXT	Set the maximum value of the frequency axis.
6. Window function	Rectangular, hanning, exponential	Set a window function that uses multiples when reading an input signal.
7. FFT point	1000, 2000, 5000, 10000	Sets the number of points for FFT analysis.
8. Averaging	Simple, exponent (time axis) Simple, exponent, peak hold (time axis)	Sets the averaging of time axis and frequency waveforms, and the number of times for averaging.
9. Cursor Measurement	OFF, +	The trace cursors can be used.
10. Analysis mode	Select from 12 items.	Selects the FFT analysis method. See Section 8.7.
11. X-, Y-axis	X axis Frequency (linear/logarithm display) When octave analysis: 1/3, 1/1 octave Y axis Real number part (linear), imaginary number part (linear), amplitude (linear/dB), phase (deg)	Sets the X-and Y- axis for display of FFT calculation results. With some FFT analysis mode, one of the axis cannot be set.
12. Analysis channel	Select from channel 1 to using channels	Selects the channel for FFT analysis.

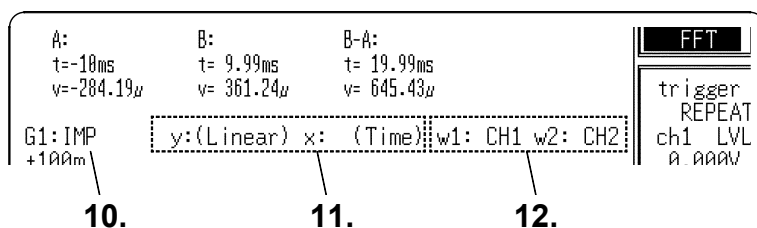

8.6 Start and Stop Operation (FFT)

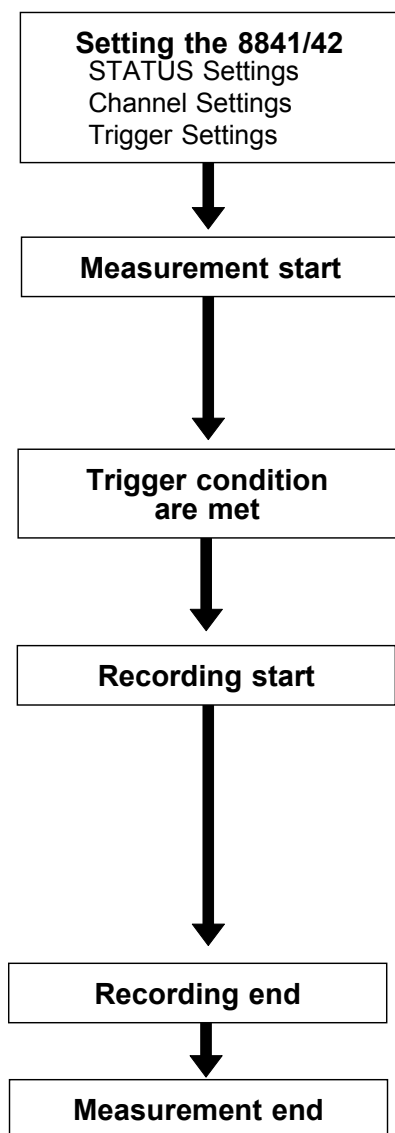

See Section 8.3, "STATUS1 Settings", Section 8.4, "STATUS2 Settings", Chapter 9, "Input Channel Settings", Chapter 10, "Trigger Functions".

Measurement start

Press the **START** key and LED light.
When the pre-trigger is set, the trigger will not be registered for a certain period after the start of measurement. (During this interval, "Pre-trigger standby" is shown on the display.)
When the trigger can be registered, the indication "Waiting for trigger" is shown on the display.

Trigger condition are met

Data recording starts when trigger condition are met.
When trigger mode selected AUTO, unit waits for about 1 second for trigger conditions to be met. After this interval, data recording starts, regardless of trigger state.

Recording start

Displays "Storing".
When the printer is enabled, the recording waveform is printed at the same time it is displayed.

When the **STOP** key is pressed twice during measurement, the 8841/42 is forcibly stopped.

The FFT calculation result display, auto-print, and automatic storage is not performed.

Recording end

After capturing measured data, the FFT analysis is carried out and then the result is displayed.
Auto printout and auto save are executed.

Measurement end

Trigger mode	SINGLE
	REPEAT
	AUTO

End of measurement

Each time when trigger conditions are met, data are recorded and memory contents are overwritten.

End of measurement in REPEAT and AUTO trigger modes
When the **STOP** key is pressed once during measurement, the 8841/42 acquires measurement data in an amount corresponding to the set recording length, and the FFT analysis is carried, and then the measurement is stopped. (FFT analysis result, auto printout, auto save are executed.)
When the **STOP** key is pressed twice, the measurement is stopped forcibly. (FFT analysis result, auto printout, auto save are not executed.)

8.7 FFT Analysis Function

8.7.1 Storage Waveform [STR]

Displays the time domain waveform of the input signal.

Function	fa	
Horizontal cursor	Time	Time axis display Indicates the value of the specified TIME/DIV frequency range. (Refer to the table of the frequency range and time axis in Section 8.3.3.)
Vertical cursor	Linear	Indicates the value of the measurement range of the input unit in voltage units.

Example Stored waveform

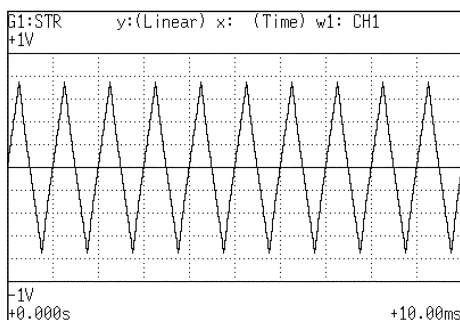

8.7.2 Linear Spectrum [LIN]

Displays the frequency domain waveform of the input signal, including magnitude and phase information.

Major applications include:

- Determining the peaks of waveform frequency components
- Determining the levels of high and low harmonics

Function	$F_a = \mathfrak{F}(f_a)$ $= F_a \exp(j \angle a)$ $= F_a (\cos \angle a + j \sin \angle a)$
Horizontal cursor	<p>LIN-Hz Frequency spectrum display as linear units. The range is from DC to the maximum frequency range value.</p> <p>LOG Hz Frequency spectrum display as logarithmic units. The range is from between 1/400 and 1/4000 of value to the frequency range value.</p> <p>Real Linear display of real-number part of the data as voltage (Nyquist mode)</p>
Vertical cursor	<p>LIN-REAL Linear display of real-number part of the data as voltage</p> <p>LIN-IMAG Linear display of imaginary-number part of the data as voltage</p> <p>LIN-MAG Linear display of analysis data as voltage</p> <p>LOG-MAG Logarithmic display of analysis data as dB (0dB reference value: 1 V peak=2V p-p)</p> <p>PHASE Degrees (deg) display of phase component of data</p> <p>Imag Linear display of imaginary-number part of the data as voltage (Nyquist mode)</p>

Examples Linear spectra waveforms

Stored waveform

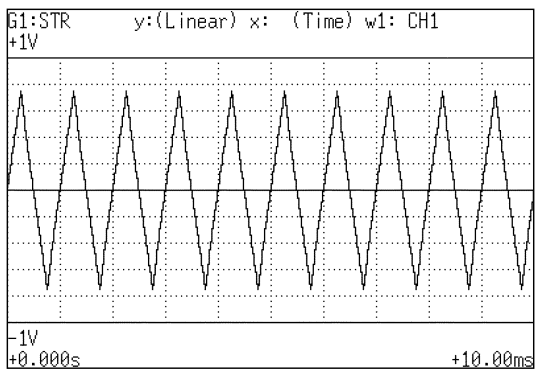

Y-axis: LIN-REAL (X-axis: LOG-Hz)

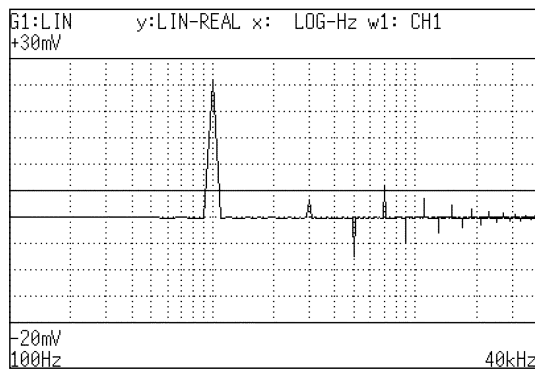

Y-axis: LIN-IMAG (X-axis: LOG-Hz)

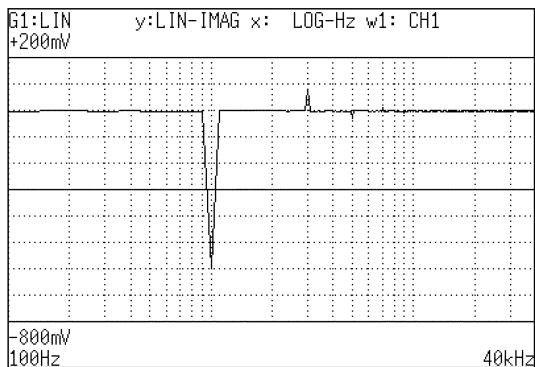

Y-axis: LIN-MAG (X-axis: LOG-Hz)

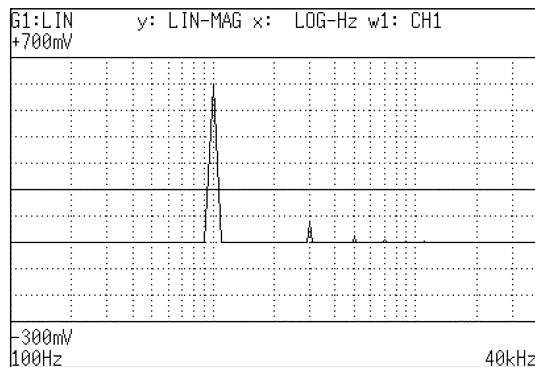

Y-axis: LOG-MAG (X-axis: LOG-Hz)

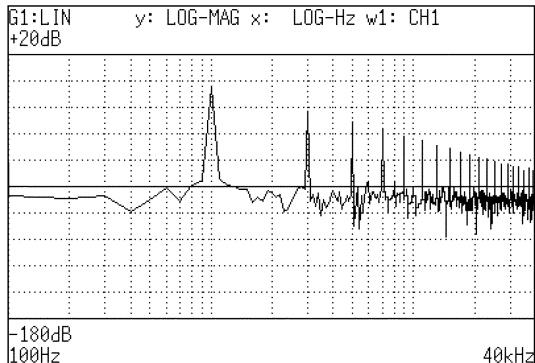

Y-axis: PHASE (X-axis: LOG-Hz)

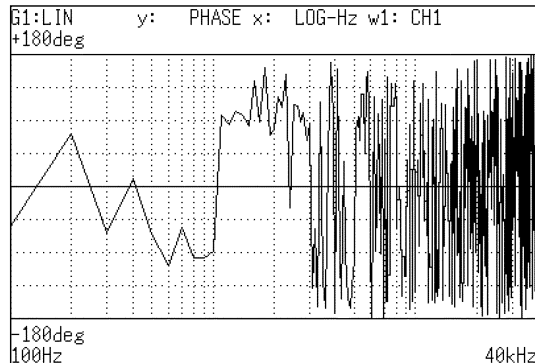

Nyquist

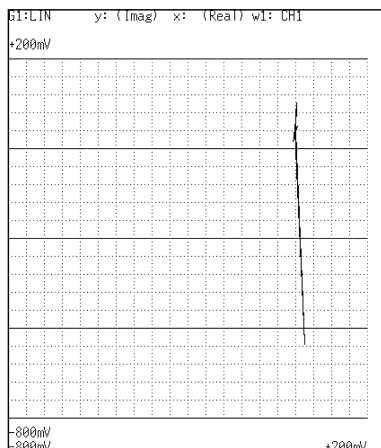

8.7.3 RMS Spectrum [RMS]

Displays the frequency domain waveform of the input signal, including magnitude (effective value) and phase information.

The LOG-MAG displays of RMS spectrum and Power spectrum express the same processing result.

Major applications include:

- Determining the peaks of waveform frequency components.
- Determining the effective values of frequency components.

Function	$R_a = \frac{1}{\sqrt{2}} F_a$ $= R_a \exp(j \quad a)$ $= R_a (\cos \quad a + j \sin \quad a)$	DC components: $R_a = F_a$
Horizontal cursor	LIN-Hz Frequency spectrum display as linear units. The range is from DC to the maximum frequency range value. LOG-Hz Frequency spectrum display as logarithmic units. The range is from between 1/400 and 1/4000 of value to the frequency range value.	
Vertical cursor	LIN-REAL Linear display of real-number part of the data as voltage LIN-IMAG Linear display of imaginary-number part of the data as voltage LIN-MAG Linear display of analysis data as voltage LOG-MAG Logarithmic display of analysis data as dB (0dB reference value: 1 Vrms) PHASE Degrees (deg) display of phase component of data	

Examples RMS spectra waveform

Stored waveform

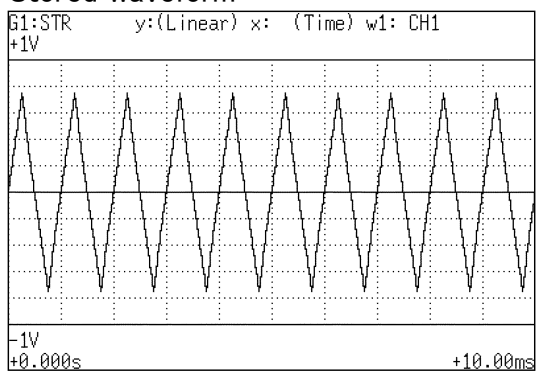

Y-axis: LIN-REAL (X-axis: LOG-Hz)

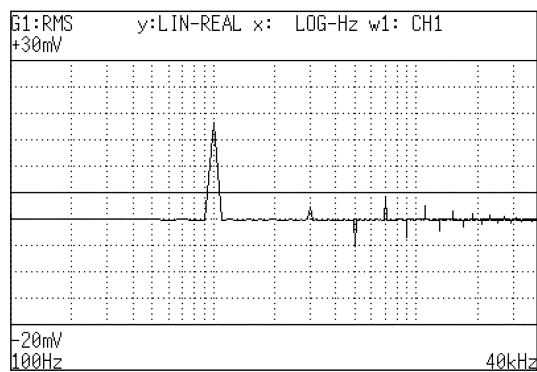

Y-axis: LIN-IMAG (X-axis: LOG-Hz)

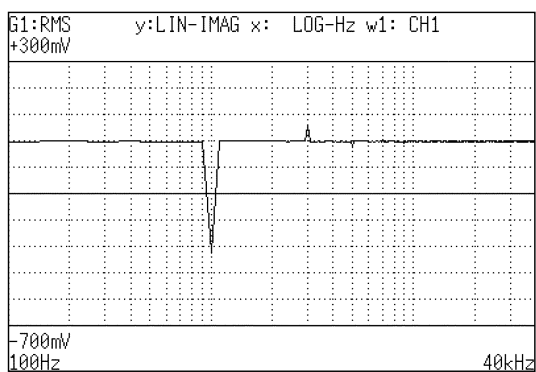

Y-axis: LIN-MAG (X-axis: LOG-Hz)

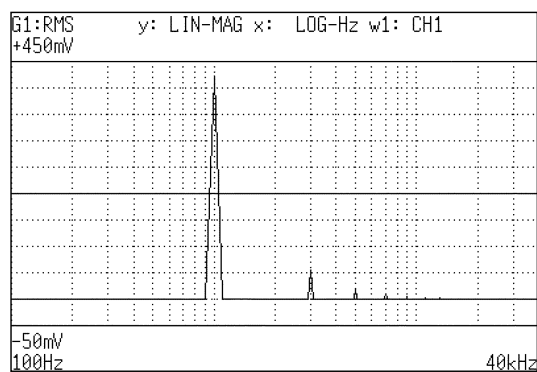

Y-axis: LOG-MAG (X-axis: LOG-Hz)

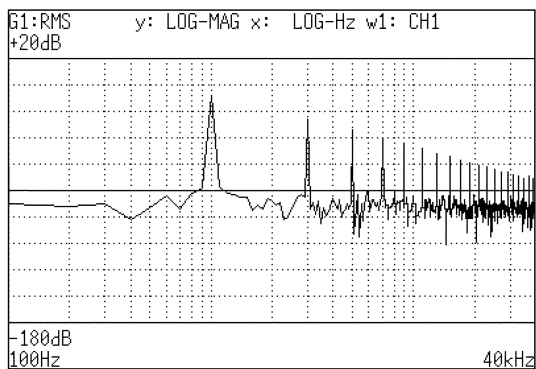

Y-axis: PHASE (X-axis: LOG-Hz)

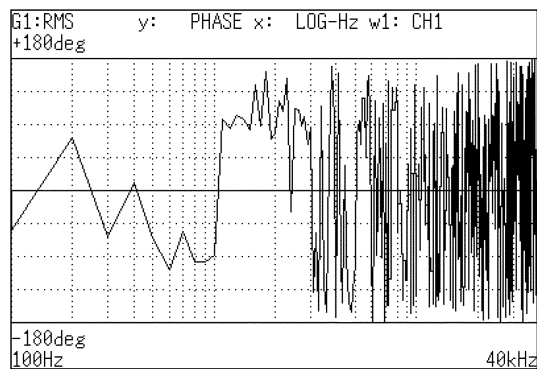

8.7.4 Power Spectrum [PSP]

Displays the energy spectrum of the input signal, consisting of only magnitude information.

Major applications include:

- Determining the peaks of waveform frequency components
- Determining the energy levels of high and low harmonics

Function	$G_{aa} = \frac{1}{2} F_a^* \cdot F_a$	F_a^* : complex conjugate of F_a
	$= \{ \text{Re}^2(F_a) + \text{Im}^2(F_a) \}$	$\text{Re}(F_a)$: real number component of F_a
	$= \frac{1}{2} F_a $	$\text{Im}(F_a)$: imaginary number component of F_a

DC component:

$$\begin{aligned} G_{aa} &= F_a^* \cdot F_a \\ &= \{ \text{Re}^2(F_a) + \text{Im}^2(F_a) \} \\ &= |F_a|^2 \end{aligned}$$

Horizontal cursor	LIN-Hz	Frequency spectrum display as linear units. The range is from DC to the maximum frequency range value.
	LOG Hz	Frequency spectrum display as logarithmic units. The range is from between 1/400 and 1/4000 of value to the frequency range value.
Vertical cursor	LIN-MAG	Linear display of analysis data as binary exponential voltage. This expresses the energy component.
	LOG-MAG	Logarithmic display of analysis data as dB (0dB reference value: 1 V ² rms)

Example Power spectra waveforms

Stored waveform

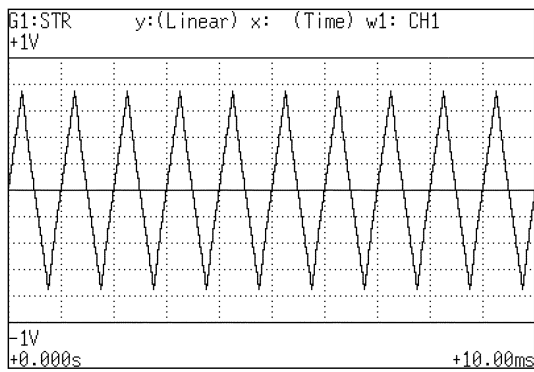

Y-axis: LIN-MAG (X-axis: LOG-Hz)

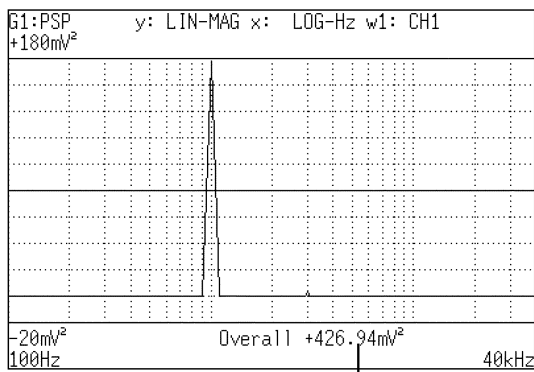

Overall value

Y-axis: LOG-MAG (X-axis: LOG-Hz)

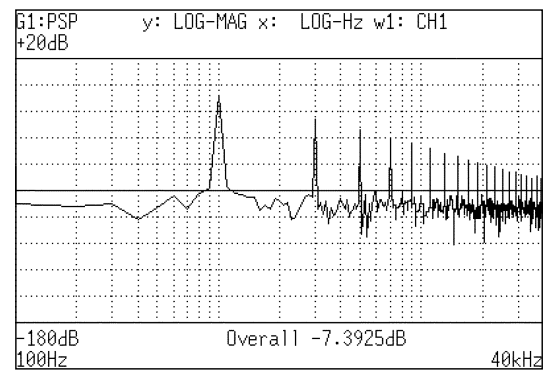

Overall value

The overall value is the total effective value obtained from the frequency spectrum contained in the input signal. It is obtained by taking the square root of the total of power spectra for all frequencies.

$$(\text{Overall value}) = \sqrt{PSP_0 + \sum_{i=1} PSP_i} \quad (\text{Vrms})$$

PSP₀ DC component

PSP_i ith AC component

Compensation is applied to data for specified points captured before starting FFT processing, to achieve the same overall value, also when a window function other than rectangular window is used.

Window compensation value:

Square wave: = 1

Hanning: = $\sqrt{\frac{8}{3}}$

Exponential: = $\sqrt{\frac{2 \log(\% / 100)}{(\% / 100)^2 - 1}}$

(% is a percentage with a range of 0 < 100.)

If % is set to 0 with the exponential window function, processing will be carried with = 0.1.

8.7.5 Auto Correlation [ACR]

Displays the degree of similarity between two points in the input signal separated by time difference ().

Major applications:

- Detecting a periodic signal contained in a noisy signal with an improvement in signal-to-noise ratio.
- Checking the periodic signal components contained in a noisy waveform, and periodic noise.

Function

$$R_{aa}(\tau) = \mathcal{F}^{-1} (G_{aa})$$

$$= \frac{1}{2\pi} \int_{-\infty}^{+\infty} G_{aa}(\omega) \exp(j\omega\tau) d\omega$$

Horizontal cursor Time Time display. The center indicates the reference ($\tau = 0$), the right side indicates time lag (+), and the left side indicates time lead (-).

Vertical cursor Linear Readings are between +1 and -1 (without units).
 +1: the highest similarity for time differential
 0: the lowest similarity, -1: the polarity is completely opposite.
 Due to the characteristics of the function, $\tau = 0$ always results in +1.

Example Auto correlation function waveforms

Stored waveform

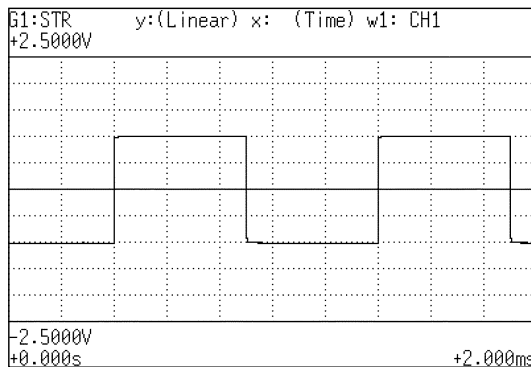

Auto correlation function

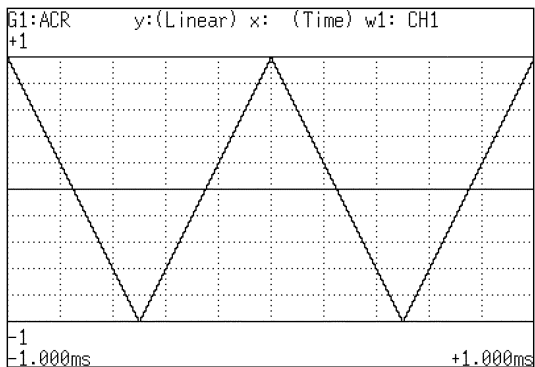

8.7.6 Histogram [HIS]

Displays the frequencies of the magnitudes of sampled points.

Major applications include:

- Determining waveform imbalance
- Determining whether a waveform is artificial or natural from the waveform distribution (most natural waveforms are regular sine waves).

Function	Pa	
Horizontal cursor	Volt	Linear display of the measurement range of the input unit.
Vertical cursor	Linear	Number of sample points for the time axis data (total: specified points).

Example Histogram function waveforms

Stored waveform

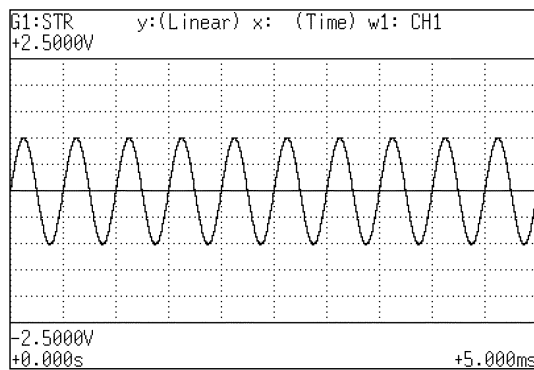

Histogram function

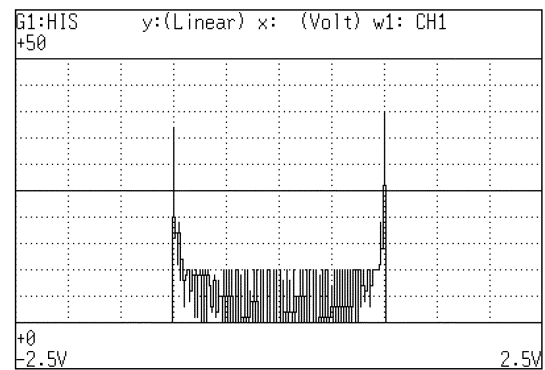

8.7.7 Transfer Function [TRF]

Displays the transfer function (frequency characteristics) of the system being measured calculated from input and output signals.

Nyquist diagrams can also be displayed, including magnitude and phase information.

Major applications include:

- Determining filter frequency characteristics.
- Determining feedback control system stability through Nyquist diagrams.
- Determining the physical resonant frequency using an impulse hammer and pick-up sensor.

Function	$H_{ab} = \frac{F_b}{F_a} = \frac{F_b \cdot F_a^*}{F_a \cdot F_a^*} = \frac{G_{ab}}{G_{aa}}$ $= \frac{ G_{ab} }{ G_{aa} } \{ \cos(\quad b - \quad a) + j \sin (\quad b - \quad a) \}$
----------	---

Horizontal cursor	<p>LIN-Hz Frequency spectrum display as linear units. The range is from DC to the maximum frequency range value.</p> <p>LOG-Hz Frequency spectrum display as logarithmic units. The range is from between 1/400 and 1/4000 of value to the frequency range value.</p> <p>Real Linear display of the real-number part of the input-to-output ratio (Nyquist mode)</p>
Vertical cursor	<p>RIN-REAL Linear display of the real-number part of the input-to-output ratio (no units).</p> <p>LIN-IMAG Linear display of the imaginary-number part of the input-to-output ratio (no units).</p> <p>LIN-MAG Linear display of input-to-output ratio (no units) This expresses the amplitude component.</p> <p>LOG-MAG Logarithmic display of input-to-output ratio as dB (no units) This expresses the amplitude component.</p> <p>PHASE Degrees (deg) display of phase component of data of input-to-output ratio</p> <p>Imag Linear display of the imaginary-number part of the input-to-output ratio (Nyquist mode).</p>

Example Transfer function spectra waveform

Stored waveform (input signal)

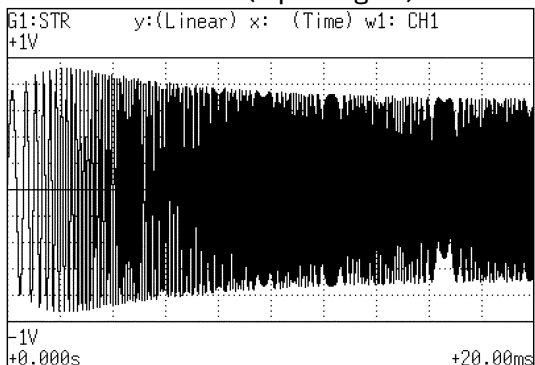

Stored waveform (output signal)

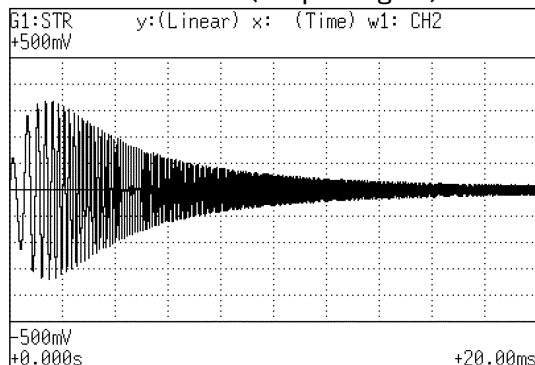

↑ After bandpass filter

Y-axis: LIN-REAL (X-axis: LOG-Hz)

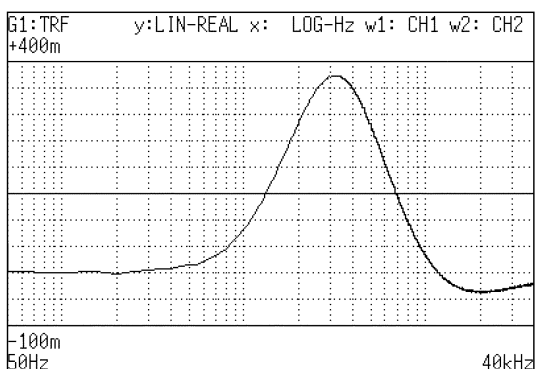

Y-axis: LIN-IMAG (X-axis: LOG-Hz)

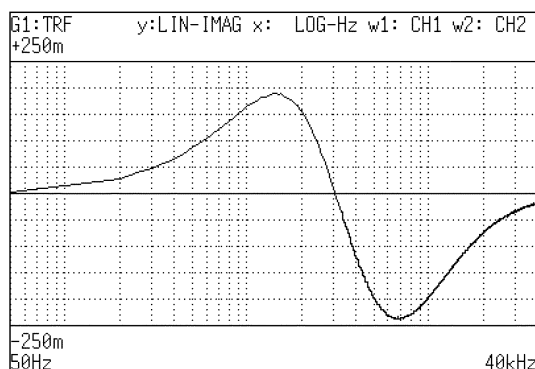

Y-axis: LIN-MAG (X-axis: LOG-Hz)

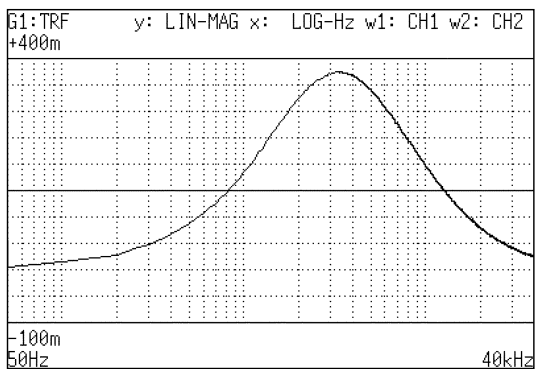

Y-axis: LOG-MAG (X-axis: LOG-Hz)

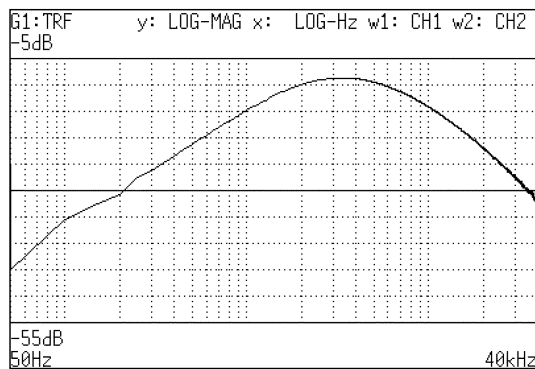

Y-axis: PHASE (X-axis: LOG-Hz)

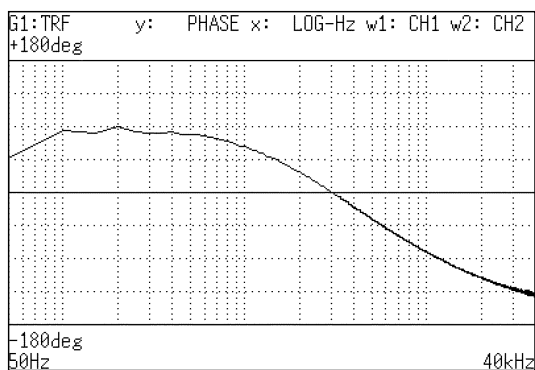

Nyquist

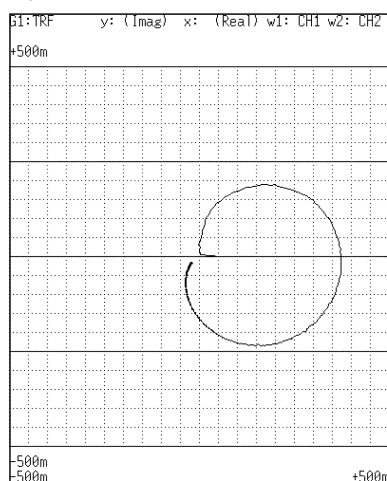

8.7.8 Cross Power Spectrum [CSP]

Displays the product of the spectra of two input signals.

The magnitude and phase information of the frequency components that are common to both signals can be displayed.

Major applications:

Obtaining frequency components common to two signals.

Function	$G_{ab} = \frac{1}{2} F_a^* \cdot F_b$ $= \frac{1}{2} F_a \cdot F_b \{ \cos(b - a) + j \sin(b - a) \}$
Horizontal cursor	<p>LIN-Hz Frequency spectrum display as linear units. The range is from DC to the maximum frequency range value.</p> <p>LOG Hz Frequency spectrum display as logarithmic units. The range is from between 1/400 and 1/4000 of value to the frequency range value.</p> <p>Real Linear display of real-number part of the data as voltage (Nyquist mode).</p>
Vertical cursor	<p>LIN-REAL Linear display of real-number part of the data as binary exponential voltage</p> <p>LIN-IMAG Linear display of imaginary-number part of the data as binary exponential voltage</p> <p>LIN-MAG Linear display of amplitude component as binary exponential voltage</p> <p>LOG-MAG Logarithmic display of the amplitude component as dB (0dB reference value; 1V_{2rms}.)</p> <p>PHASE Degrees (deg) display of phase component of data</p> <p>Imag Linear display of imaginary-number part of the data as binary exponential voltage (Nyquist mode)</p>

Example Cross power spectra waveforms

Stored waveform 1

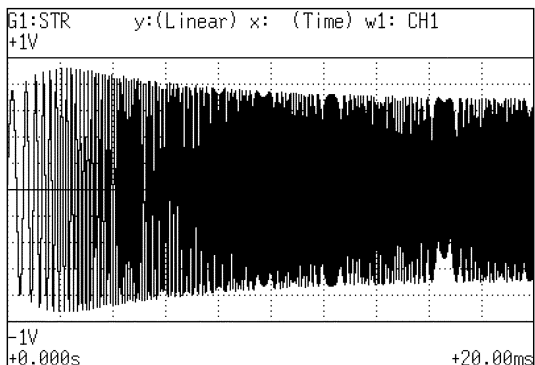

Stored waveform 2

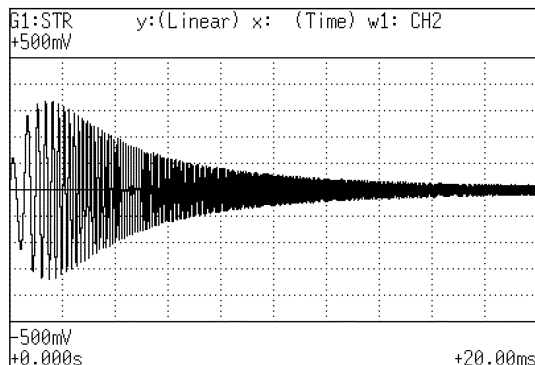

Y-axis: LIN-REAL (X-axis: LOG-Hz)

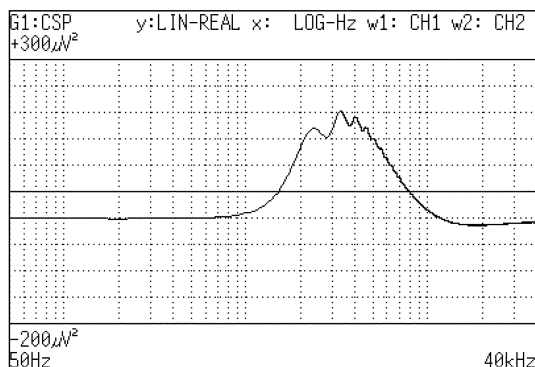

Y-axis: LIN-IMAG (X-axis: LOG-Hz)

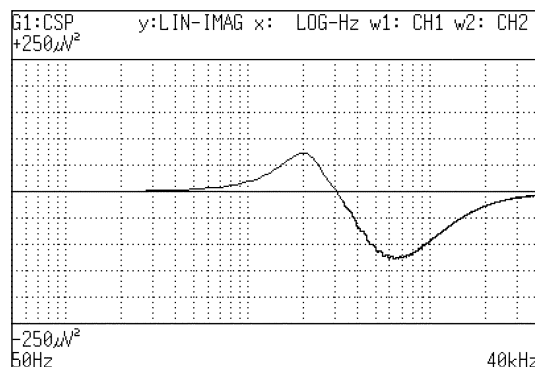

Y-axis: LIN-MAG (X-axis: LOG-Hz)

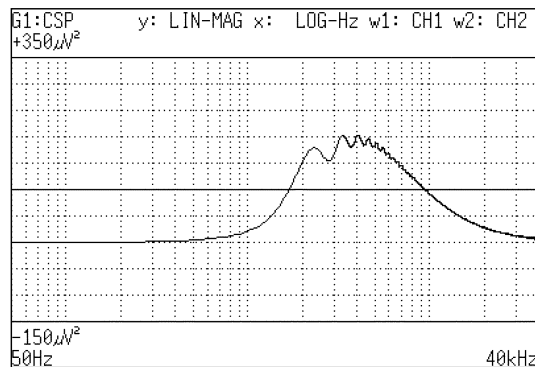

Y-axis: LOG-MAG (X-axis: LOG-Hz)

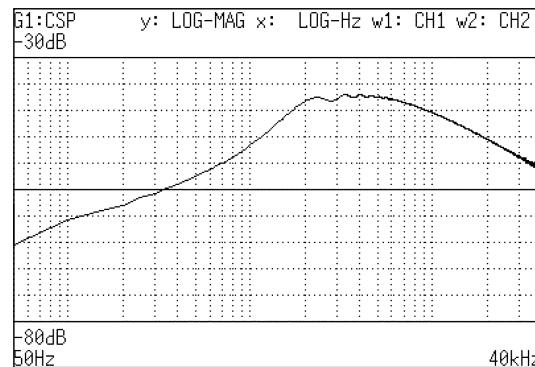

Y-axis: PHASE (X-axis: LOG-Hz)

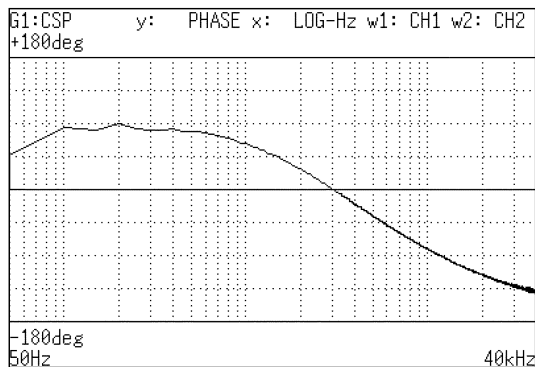

Nyquist

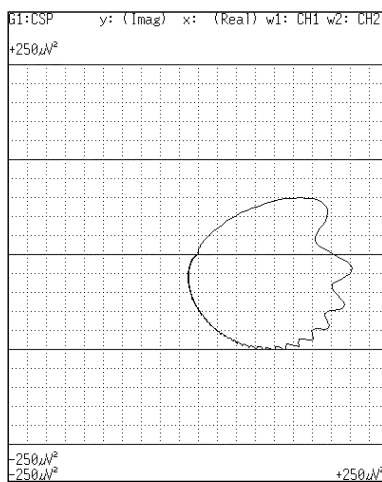

8.7.9 Cross Correlation [CCR]

Displays the degree of similarity between two points separated by a time difference () on two signals.

The degree of similarity is expressed as a function of the time difference ().

Major applications:

- Obtaining the phase difference between two signals in time units.
- Obtaining a speed or distance by measuring the time delay.

Function $R_{ab}(\tau) = \mathcal{F}^{-1}(G_{ab})$

$$= \frac{1}{2\pi} \int_{-\infty}^{+\infty} G_{ab} \cdot (\tau) \exp(j\omega\tau) d\omega$$

Horizontal cursor Time Time display. The center indicates the reference ($\tau = 0$), the right side indicates time lag (+), and the left side indicates time lead (-).

Vertical cursor Linear Readings are from +1 to -1 (no units).
 +1: the highest similarity between the input and output signals for time differential τ , 0: the lowest similarity, -1: the polarity is completely opposite

Example Cross correlation function waveforms

Stored waveform (input waveform)

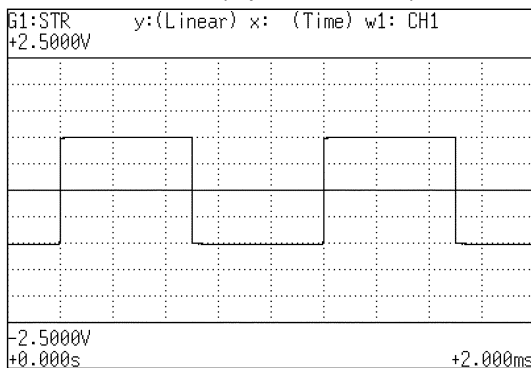

Stored waveform (output waveform)

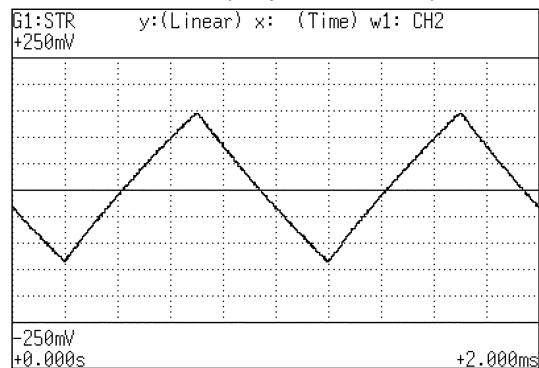

Cross correlation function

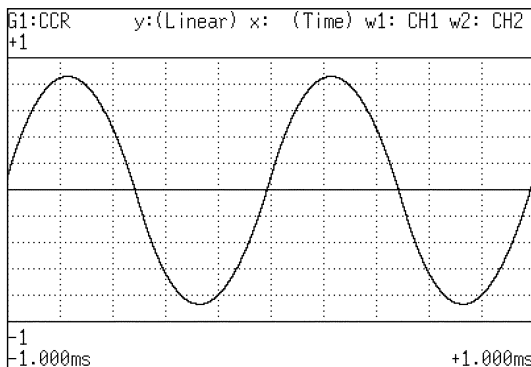

8.7.10 Unit Impulse Response [IMP]

Displays the frequency response of a system in the time domain.

A response waveform equivalent to the unit impulse function is obtained by analyzing the input and output signals of the system being measured.

Major applications

Checking circuit time constants.

Function	IMP = \mathcal{F}^{-1} (Hab)	
Horizontal cursor	Time	Time display. The center indicates the reference (=0), the right side indicates time lag (+), and the left side indicates time lead (-).
Vertical cursor	Linear	Inverse Fourier conversion value of the transfer function (Hab) (no units).

Example Unit impulse response waveforms

Stored waveform (input signal)

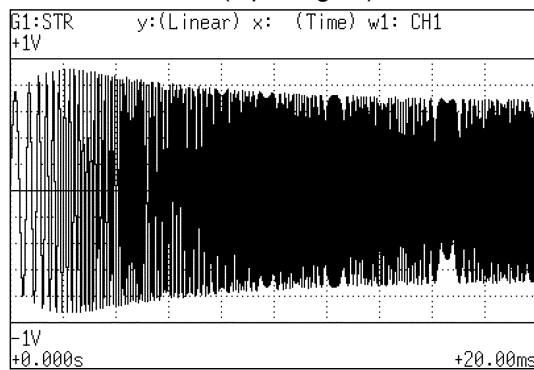

Stored waveform (output signal)

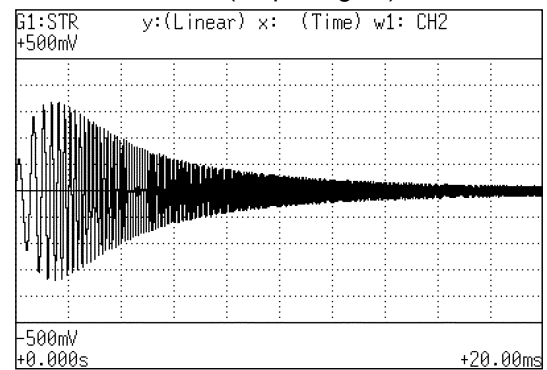

Unit impulse response

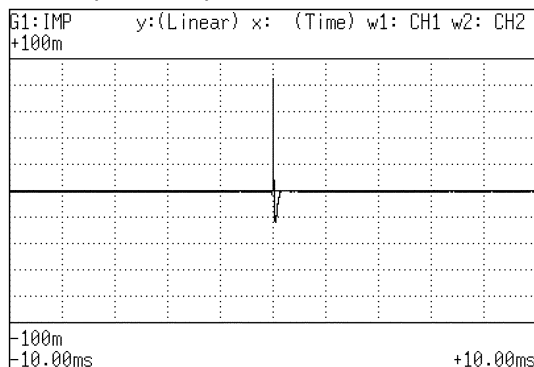

8.7.11 Coherence [COH]

Displays the output signal component that is coherent (interference possible) to the input signal, yielding a value from 0 to 1.

Major applications include:

- Evaluation of transfer functions.
- Determining the contribution of individual input lines to the output of multi-input systems.

Function

$$COH = \frac{G_{ab} \cdot G_{ab}}{G_{aa} \cdot G_{bb}}$$

Horizontal cursor	LIN-Hz	Frequency spectrum display as linear units. The range is from DC to the maximum frequency range value.
	LOG-Hz	Frequency spectrum display as logarithmic units. The range is from between 1/400 and 1/4000 of value to the frequency range value.
Vertical cursor	Linear	The relationship between the two input signals. The degree of relationship is indicated from 0 to 1 on a linear scale (no units).

NOTE

For a single measurement, the coherence function returns 1 for all frequencies. When measuring, be sure to use frequency averaging.

Example Coherence function waveforms

Stored waveform (input signal)

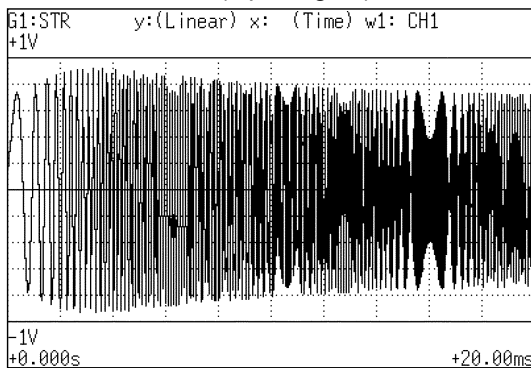

Stored waveform (output signal)

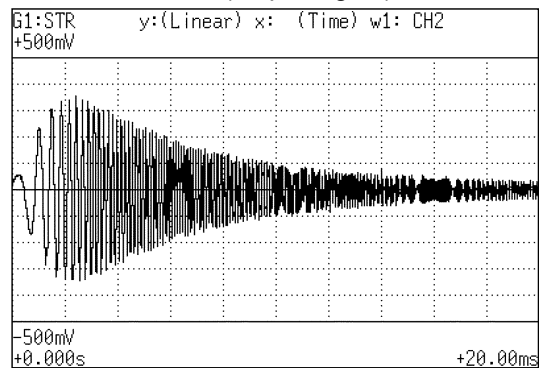

Coherence

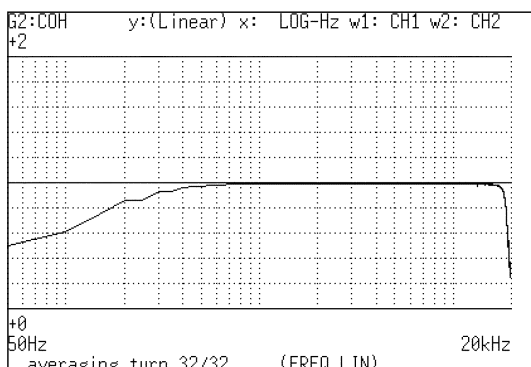

8.7.12 Octave Analysis [OCT]

This function displays the spectrum of a noise signal or other signal, using 1/1-octave or 1/3-octave band filters with fixed ratio.

Main uses

Frequency analysis of noise

Function	OCT	
Horizontal cursor	1/1 OCT	1/1-octave band filtering
	1/3 OCT	1/3-octave band filtering
Vertical cursor	LIN-MAG	Linear display of octave analysis value as voltage
	LOG-MAG	Logarithmic display of octave analysis value as dB

Vertical axis	Display
LIN-REAL (real number)	-
LIN-IMAG (imaginary number)	-
LIN-MAG (amplitude)	OCT
LOG-MAG (logarithmic amplitude)	10log (OCT)
PHASE	-

- For frequency analysis of a noise signal or similar, the signal is passed through fixed-ratio band filters with 1/1-octave or 1/3-octave bandwidth.
- As opposed to the power spectrum function, where the signal is divided into bands of identical width and the power in each band is displayed, octave analysis divides the frequency axis evenly on a logarithmic scale and expresses the level as a bar for each band.
- In analog octave analysis, the octave band center frequencies and filter characteristics are determined according to the ANSI CLASS 3 standard. In the 8841/42, the power spectrum is measured first and bundling is then used to perform 1/1-octave or 1/3-octave analysis. This allows the following analysis functions:
 - 5-band 1/1-octave analysis
 - 15-band 1/3-octave analysis
- 15-band 1/3-octave analysis and filter characteristics of the 8841/42 correspond to the ANSI CLASS 3 standard. However, in the upper bands of frequency analysis, there are no leak components from higher frequencies. For example, the 20 kHz band contains no leak components from the 25 kHz band or other bands.
- 15-band 1/3-octave analysis
In this mode, the 400 spectrum lines of regular frequency analysis are bundled into 1/3 octave bands and shown as a bar graph.
- 5-band 1/1-octave analysis
In this mode, the 400 spectrum lines of regular frequency analysis are bundled into 1/1 octave bands and shown as a bar graph.

Example Octave analysis waveforms

Stored waveform

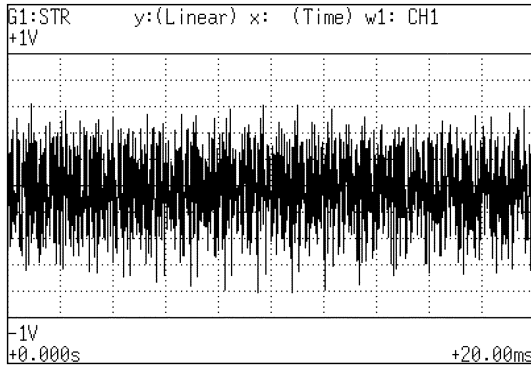

1/1 octave analysis

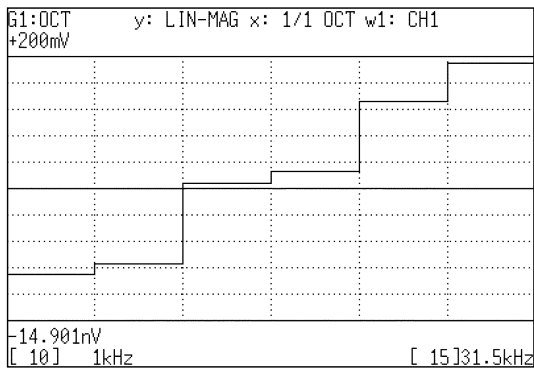

1/3 octave analysis

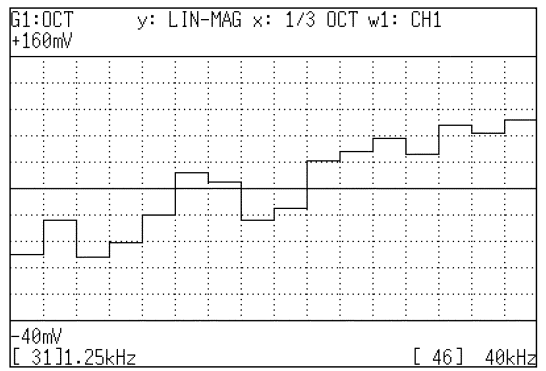

Frequency ranges and measurable range widths (0: 1/1 OCT, 1: 1/3 OCT)

0: 1/1 OCT, 1: 1/3 OCT

Band No.		Center frequency (Hz)	133	333	667	1.33	4	8	20	40	80	200	400	800	2k	4k	8k	20k	40k	80k	200k	400k	
1/1	1/3		m	m	m																		
-8	-24 -23	4 m 5 m	0 1																				
-7	-22 -21 -20	6.3 m 8 m 10 m	1 0 1	0 1																			
-6	-19 -18 -17	12.5 m 16 m 20 m	1 0 1	1 0 1	0 1																		
-5	-16 -15 -14	25 m 31.5 m 40 m	1 0 1	1 0 1	1 0 1	0 1																	
-4	-13 -12 -11	50 m 63 m 80 m	1 0 1	1 0 1	1 0 1	1 0 1	1 0 1																
-3	-10 -9 -8	100 m 125 m 160 m	1 0 1	1 0 1	1 0 1	1 0 1	1 0 1	0 1															
-2	-7 -6 -5	200 m 250 m 315 m		1 0 1	1 0 1	1 0 1	1 0 1	1 0 1	0 1														
-1	-4 -3 -2	400 m 500 m 630 m			1 0 1	1 0 1	1 0 1	1 0 1	1 0 1	0 1													
0	-1 0 1	800 m 1 1.25				0 1 1	0 1 1	0 1 1	0 1 1	0 1 1	0 1												
1	2 3 4	1.6 2 2.5					0 1 1	0 1 1	0 1 1	0 1 1	0 1 1	0 1											
2	5 6 7	3.15 4 5					0 1 1	0 1 1	0 1 1	0 1 1	0 1 1	0 1 1											
3	8 9 10	6.3 8 10						0 1 1	0 1 1	0 1 1	0 1 1	0 1 1	0 1 1										
4	11 12 13	12.5 16 20							0 1 1	0 1 1	0 1 1	0 1 1	0 1 1										
5	14 15 16	25 31.5 40								0 1 1	0 1 1	0 1 1	0 1 1	0 1 1									
6	17 18 19	50 63 80									0 1 1	0 1 1	0 1 1	0 1 1	0 1 1								
7	20 21 22	100 125 160										0 1 1	0 1 1	0 1 1	0 1 1	0 1 1							
8	23 24 25	200 250 315											0 1 1	0 1 1	0 1 1	0 1 1	0 1 1						
9	26 27 28	400 500 630												0 1 1	0 1 1	0 1 1	0 1 1	0 1 1	0 1 1				
10	29 30 31	800 1 k 1.25 k													0 1 1	0 1 1	0 1 1	0 1 1	0 1 1	0 1 1	0 1 1	0 1 1	0 1 1

Band No.		Center frequency (Hz)	133	333	667	1.33	4	8	20	40	80	200	400	800	2k	4k	8k	20k	40k	80k	200k	400k		
1/1	1/3		m	m	m																			
11	32	1.6 k													1	1	1	1	1					
	33	2 k													0	1	0	1	0	1	0			
	34	2.5 k														1	1	1	1	1				
12	35	3.15 k														1	1	1	1	1				
	36	4 k													0	1	0	1	0	1	0			
	37	5 k														1	1	1	1	1				
13	38	6.3 k															1	1	1	1	1			
	39	8 k														0	1	0	1	0	1	0	1	
	40	10 k														1	1	1	1	1	1			
14	41	12.5 k																1	1	1	1	1	1	
	42	16 k																0	1	0	1	0	1	
	43	20 k																1	1	1	1	1	1	
15	44	25 k																	1	1	1	1	1	
	45	31.5 k																0	1	0	1	0	1	
	46	40 k																1	1	1	1	1	1	
16	47	50 k																		1	1	1	1	
	48	63 k																	0	1	0	1	0	1
	49	80 k																	1	1	1	1	1	
17	50	100 k																			1	1	1	
	51	125 k																			0	1	0	1
	52	160 k																			1	1	1	
18	53	200 k																			1	1	1	
	54	250 k																			0	0	1	
	55	315 k																				1	1	
19	56	400 k																					1	
	57	500 k																					0	

Chapter 9

Input Channel Settings

9.1 Overview

Item	Screen	Channel	Display	Status	System
Waveform Display Color			*12	-	-
Measurement Range		*11	*12	-	-
Input Coupling		*11		-	-
Magnification/Compression Ratio Along the Voltage Axis				-	-
Zero Position				-	-
Zero Adjustment				-	-
Zero Offset ^{*1}				-	-
Anti-aliasing filter ^{*2}			*13	-	-
Auto Balancing ^{*3}				-	-
Digital Filter ^{*4}				-	-
Drift Compensation ^{*5}				-	-
Hold ^{*6}				-	-
Pull-up Resistor ^{*7}				-	-
Threshold Value ^{*8}			-	-	-
Clamp Check ^{*9}			-	-	-
Sensor Sensitivity ^{*10}			-	-	-
Low-Pass Filter				-	-
Logic Display Color				-	-
Logic Display Position				-	-
Variable Function ^{*14}				-	-
Selecting Functions					-
Format		-	-		-
Scaling Function		-	-	-	*11
Comment function		-	-	-	*11

*1: Only voltage and current measurement

*2: Can be set on the 8938 and 8947

*3: 8939 only

*4: Only voltage measurement on the 8937

*5: Only temperature measurement on the 8937

*6 Only frequency measurement on the 8940

*7 Only measurement of frequency, integration, pulse duty ratio, and voltage on the 8940

*8: Only measurement of frequency, integration, and pulse duty ratio on the 8940

*9: Only current measurement on the 8940

*10: Only measurement of Charge and Preamp on the 8947

*11: The settings can be copied.

*12: Channels can be set directly on the Waveform display screen.

*13: Setting is possible on the Waveform display screen on the 8938.

*14: Only numerical values can be changed on the display screen. On/off setting is not possible.

9.2 Operation Procedure (Input Channel Setting)

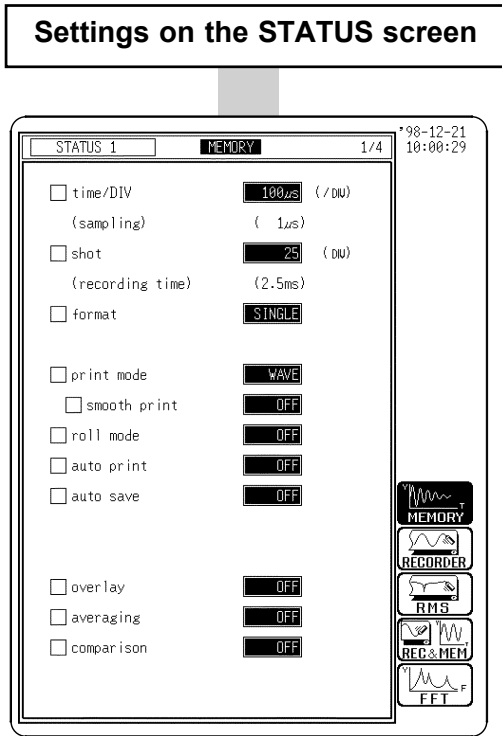

- Function
 - Memory recorder
 - Recorder
 - RMS recorder
 - Recorder&memory
 - FFT
- Waveform display format
 - Single
 - Dual
 - Quad
 - Oct
 - Hex
 - X-Y single
 - X-Y dual

Settings on the Channel screen

Pressing the **CHAN** key switches between CHANNEL screen and VARIABLE screen
 Pressing the **CH.SET** key switches Input CHANNEL screens

- Waveform display color
- Waveform display graph
- Voltage axis range
- Input coupling
- Magnification/compression along voltage
- Anti-aliasing filter
- Zero position
- Low-pass filter
- Logic input (CHA-CHD)

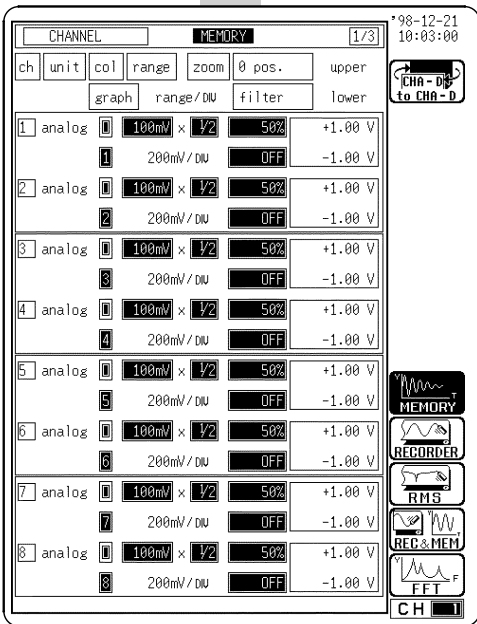

Settings for analog channels

Settings for logic channels

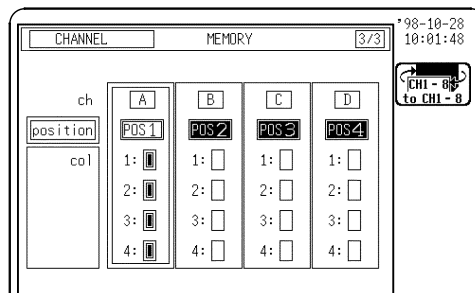

Setting on the VARIABLE screen

Use this function, if necessary.
Variable function refers to a function that allows the arbitrary setting of voltage axis display range, freely expanding or compressing the voltage axis.

For details see Section 9.7, "Setting the Variable Function".

Setting on the SYSTEM screen

SYSTEM 2: Scaling setting screen

Using the scaling function, the output voltage from the sensors can be measured in terms of the physical quantities of the object to be measured.

For details, see Section 9.8, "Scaling Function (SYSTEM2)".

SYSTEM 3: Comment setting screen

Comments superimposed on the graph are of two types: title comments and analog channel comments (analog and logic).

For details, see Section 9.9, "Comment Function (SYSTEM 3)".

Zero settings

Executing zero adjustment

After the power switch is turned on, wait approximately 30 min for the 8936, 8938, 8940, 8946, and approximately 1 hour for the 8937, 8939, 8947 to stabilize the inside temperature of the connected input unit in order to obtain accurate waveforms. Then, make a zero adjustment of the 8936, 8937, 8938, 8940, 8946, 8947 or perform an auto balancing of the 8939 prior to measurement.

Zero adjustment See Section 9.5.1

Auto balancing See Section 9.13

Offset cancel

Set the input voltage value to 0 V.

Setting on the VARIABLE screen

- Channels can be set directly using the (channel select) keys CH1 to CH16, the POSITION knob, and the RANGE knob.
- The vernier function can be set.
- Press the CH.SET key to set input channels in the Waveform display screen. See Section 9.10.

NOTE

Input settings differ among 8936 and 8946 4-channel. Settings for other units, see the following sections.

For the 8937 VOLTAGE/TEMP UNIT settings, see Section 9.11.

For the 8938 FFT ANALOG UNIT settings, see Section 9.12.

For the 8939 STRAIN UNIT settings, see Section 9.13.

For the 8940 F/V UNIT settings, see Section 9.14.

For the 8947 CHARGE UNIT settings, see Section 9.15.

9.3 Setting the CHANNEL Screen

Indicates the CHANNEL screen organization. Press the **CHAN** key to display the CHANNEL screen.

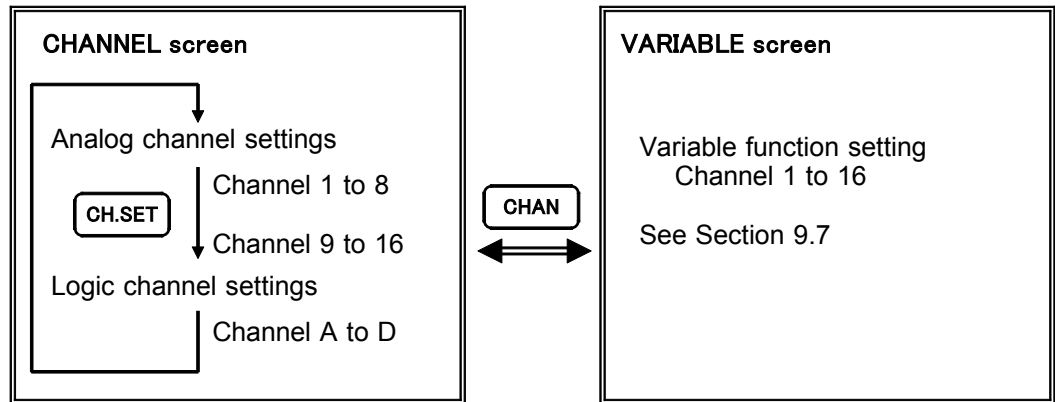

For the settings of logic channels, see Section 9.3.8.

ch	unit	col	range	zoom	θ pos.	upper	lower
1	analog	<input type="checkbox"/>	100mV × 1/2	50%		+1.00 V	-1.00 V
		<input type="checkbox"/>	200mV / DIV	OFF			
2	analog	<input type="checkbox"/>	100mV × 1/2	50%		+1.00 V	-1.00 V
		<input type="checkbox"/>	200mV / DIV	OFF			
3	analog	<input type="checkbox"/>	100mV × 1/2	50%		+1.00 V	-1.00 V
		<input type="checkbox"/>	200mV / DIV	OFF			
4	analog	<input type="checkbox"/>	100mV × 1/2	50%		+1.00 V	-1.00 V
		<input type="checkbox"/>	200mV / DIV	OFF			
5	analog	<input type="checkbox"/>	100mV × 1/2	50%		+1.00 V	-1.00 V
		<input type="checkbox"/>	200mV / DIV	OFF			
6	analog	<input type="checkbox"/>	100mV × 1/2	50%		+1.00 V	-1.00 V
		<input type="checkbox"/>	200mV / DIV	OFF			
7	analog	<input type="checkbox"/>	100mV × 1/2	50%		+1.00 V	-1.00 V
		<input type="checkbox"/>	200mV / DIV	OFF			
8	analog	<input type="checkbox"/>	100mV × 1/2	50%		+1.00 V	-1.00 V
		<input type="checkbox"/>	200mV / DIV	OFF			

Additional screen elements: CHANNEL, MEMORY, 1/3, *98-12-21, 10:03:41, CHA-D to CHA-D, MEMORY, RECORDER, RMS, REC&MEM, FFT, CH 1

9.3.1 Setting the Waveform Display Color

Set the display color for the waveform.

Procedure

Screen: CHANNEL, Waveform display

1. Use the Menu keys to display the desired screen.
2. Press the **CH.SET** key to display channel to be set.
3. Move the flashing cursor to **color** item. (**col** on the CHANNEL screen)
4. Use the function keys or Jog/Shuttle control to make a setting.

Function
display

Meaning



: Move the cursor up in the selection window.



: Move the cursor down in the selection window.



: When outputting data with the internal printer, you may set for line type. (See Section 13.3.1)



: Waveform is performed.



: Waveform is not performed.

9.3.2 Setting the Waveform Display Graph Position

Sets the position at which the waveform is displayed. The waveform display position can be set when settings other than Single screen are selected in Display format setup on STATUS screen.

Procedure

Screen: CHANNEL, Waveform display

1. Use the Menu keys to display the desired screen.
2. Press the **CH.SET** key to display channel to be set.
3. Move the flashing cursor to **graph** item.
4. Use the function keys or Jog/Shuttle control to make a setting.

Function
display

Meaning



: Move the cursor up in the selection window.



: Move the cursor down in the selection window.

NOTE



For the X-Y screen (memory recorder and recorder) display format, see the X-Y recorder setting for each function.

9.3.3 Setting the Voltage Axis Range

- The measurement range for each channel is set.
- The set value denotes the voltage value for 1 DIV along the measurement range (vertically).

Procedure Screen: CHANNEL, Waveform display

1. Use the Menu keys to display the desired screen.
2. Press the **CH.SET** key to display channel to be set.
3. Move the flashing cursor to **range** item.
4. Use the function keys, Jog/Shuttle control, or **RANGE** knob to make a setting.

Function display	Meaning
	: Move the cursor up in the selection window.
	: Move the cursor down in the selection window.

NOTE

- The **RANGE** knob can be used regardless of where the flashing cursor is located.
- If the variable function is enabled, the size of a waveform on the screen does not change, even if the measurement range is changed.
- The symbol "*" in the selection window indicates the time axis of the data stored to current memory. (If no data is present in memory, this symbol is not displayed.)
- When the waveform is out of range, the color of the displayed waveform on the screen is changed.
- When using the RMS recorder function, you cannot set the lowest sensitivity range of each unit (20 V/DIV for the 8936).

9.3.4 Setting the Input Coupling



The input coupling for the input signal is set.

Procedure Screen: CHANNEL, Waveform display

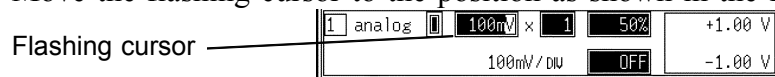
1. Use the Menu keys to display the desired screen.
2. Press the **CH.SET** key to display channel to be set.
3. Move the flashing cursor to the position as shown in the figure below.



4. Use the function keys to make a setting.

Function display	Meaning
	: DC coupling
	: AC coupling
	: The input signal is not connected. This allows the zero position to be checked.

NOTE

It is not possible to select AC couplings for the 8946.

9.3.5 Setting the Magnification/Compression Ratio Along the Voltage Axis

- Specifies the magnification/compression ratio for each channel to be used for display and recording.
- Performs magnification/compression using the center of the screen as reference.

Procedure Screen: CHANNEL, Waveform display

1. Use the Menu keys to display the desired screen.
2. Press the **CH.SET** key to display channel to be set.
3. Move the flashing cursor to the **zoom** item.
4. Use the function keys or the Jog/Shuttle control to make a setting.

Function display	Meaning
---------------------	---------



: Move the cursor up in the selection window.



: Move the cursor down in the selection window.

NOTE

- The measurable area for each voltage range is about ± 1.25 times the full-scale voltage axis (20 DIV). The display area on the waveform screen depends on the magnification and compression settings, but the measurable area is not affected. So even if seemingly displayable on the screen, any part of a waveform that exceeds the measurable area of the voltage range cannot be read.
- Magnification/compression along the measurement range is performed using the center of the screen as reference, if the Magnification/compression ratio is changed.
- Depends on display format, magnification/compression ratio is changed as below:
 - Single screen: $\times 1/2, \times 1, \times 2, \times 5, \times 10$
 - Dual, quad, oct, hex, X-Ysingle/dual screens: $\times 1/4, \times 1/2, \times 1, \times 2.5, \times 5$





9.3.6 Setting the Zero Position

The position of the zero voltage is set.

Procedure

Screen: CHANNEL, Waveform display

1. Use the Menu keys to display the desired screen.
2. Press the **CH.SET** key to display channel to be set.
3. Move the flashing cursor to the **0 pos.** item.
4. Use the function keys, the Jog/Shuttle control, or **POSITION** knob to make a setting.

Function display	Meaning
	: Changes the +10% zero position
	: Changes the +1% zero position.
	: Changes the -1% zero position.
	: Changes the -10% zero position.

NOTE

- The **POSITION** knob can be used regardless of where the flashing cursor is located, if the CHANNEL or Waveform display screen is displayed.
- Magnification/compression along the measurement range is performed using the center of the screen as reference, even if the magnification/compression ratio is changed.
- The zero positions are shown in the figure below. It is possible to display the hidden portion of the waveform by setting "0 V" to a proper percentage on the display.
- Values that can be measured in each range are about 1.25 times the full-scale voltage axis (20 DIV). Data falling outside of the possible voltage measurement range is not read and is considered to be out of range.
- The voltage range displayed on the Waveform display screen changes according to the zero position and voltage axis magnification/compression, but the possible measurement range does not change.

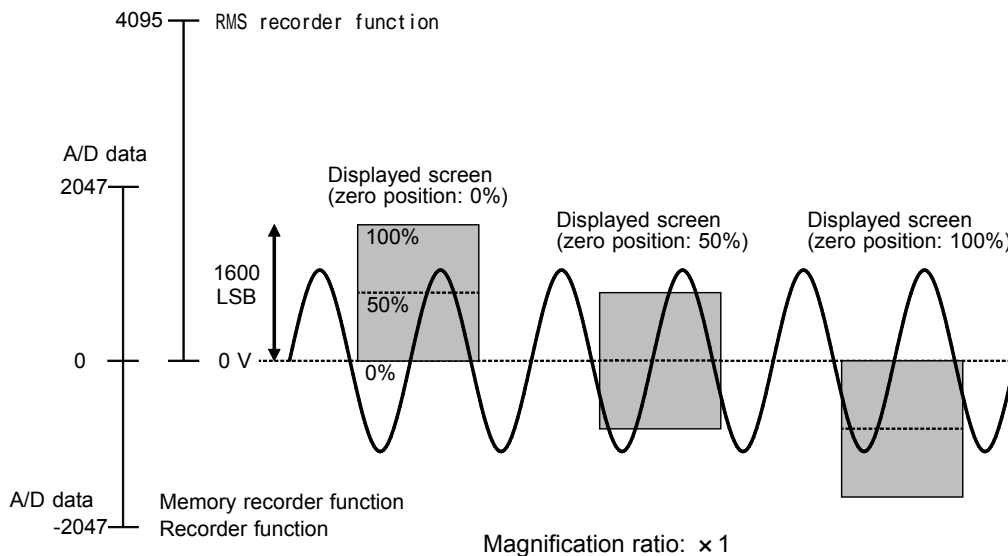

Single screen format	× 1/2	× 1	× 2	× 5	× 10
2 to 16, X-Y 1,2 screen format	× 1/4	× 1/2	× 1	× 2.5	× 5
No. of full-scale LSBs	3200	1600	800	320	160
Zero position adjustment area (MEM, REC, and REC&MEM)	0 to 100	-50 to 150	-150 to 250	-450 to 550	-950 to 1050
Zero position adjustment area (RMS)	-50 to 100	-150 to 150	-350 to 250	-950 to 550	-1950 to 1050

9.3.7 Setting the Low-pass Filter

Low-pass filters internal to the input units are set. Effective for removing unneeded high-frequency components.

Procedure

Screen: CHANNEL, Waveform display

1. Use the Menu keys to display the desired screen.
2. Press the **CH.SET** key to display channel to be set.
3. Move the flashing cursor to the **filter** item.
4. Use the function keys to make a setting.

Function display Meaning (When using the 8936 ANALOG UNIT)

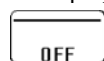

: No low-pass filter is connected.

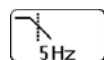

: Connect a filter with a cutoff frequency of 5 Hz

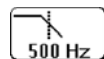

: Connect a filter with a cutoff frequency of 500 Hz



: Connect a filter with a cutoff frequency of 5 kHz

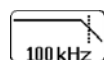

: Connect a filter with a cutoff frequency of 100 kHz

Low-pass filter for the units

Unit	Low-pass filter [Hz]
8936	OFF, 5, 500, 5 k, 100 k
8937	OFF, 5, 500, 5 k, 100 k (voltage) OFF, 5, 500 (temperature)
8938	OFF, 5, 500, 5 k, 100 k
8939	OFF, 10, 30, 300, 3 k
8940	OFF, 5, 500, 5 k, 100 k
8947	OFF, 5, 500, 5 k, 100 k (voltage) OFF, 500, 5 k (acceleration)

NOTE

The cutoff frequency of low-pass filter varies depending on the input unit type.

9.3.8 Setting the Logic Inputs

- Select the display positions for CHA - CHD (1 probe).
- Select the display color for the logic waveform.

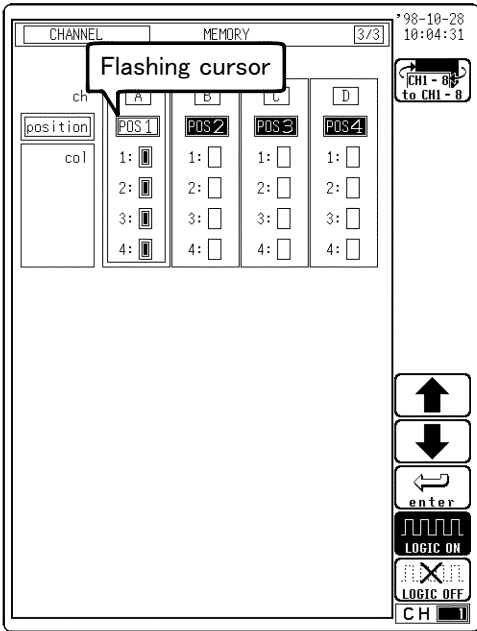

Procedure Screen: CHANNEL, Waveform display

1. Use the Menu keys to display the desired screen. Then press the **CH.SET** key to display the logic channel setting screen.
2. Move the flashing cursor to the **Position** point of the channel to be set, as shown in the figure on the left.
3. Use the function keys to set the position.
4. Select the **enter** function key or move the flashing cursor to change the display position.

Function display	Meaning
	: Change the display position.
	: Change the display position.
	: Set to the displayed position number.
	: All logic waveforms are displayed.
	: Logic waveforms are not displayed.

The logic waveform display positions are as follows.

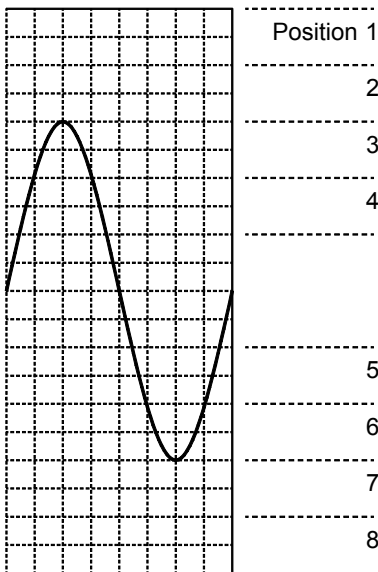

5. Move the flashing cursor to the "1" to "4" item of the channel for which the display color is to be set.
6. Use the the function keys to make the selection.

Function display	Meaning
	: Move the cursor up in the selection window.
	: Move the cursor down in the selection window.
	: Waveform is performed.
	: Waveform is not performed.

9.4 Copying Channel Settings

- Copies any of input channel settings (voltage axis range, input coupling, and low-pass filter), variable function settings, scaling function settings, or comment function settings to another channel.
- Copying channel settings cannot be carried out between different units.

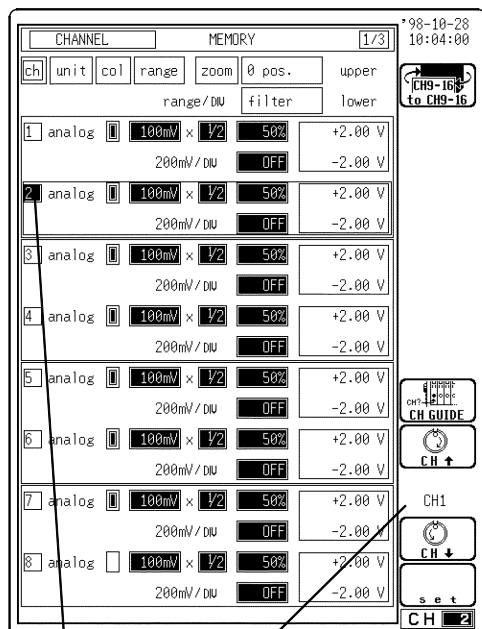

Copy target Copy source

Procedure Screen: CHANNEL

1. Press the **CHAN** key to display the CHANNEL screen.
2. Move the flashing cursor to the number of the channel to be used as copy source.
3. Use the function keys or the Jog/Shuttle control to specify the copy target channel.

Function display	Meaning
	: Increase channel number
	: Decrease channel number

Selection of "for ALL" enables the settings (comments) for the channel with the flashing cursor to be copied to all channels

4. When **set** is pressed, the settings of the copy source channel are copied to the copy target channel. For variable function and scaling function, the settings are copied in an identical.

NOTE

Magnification and zero position are copied to the desired destination only when the copy source is set to "for ALL" when copying is performed in the input channel settings.

It is not possible to copy the settings of input channels and variable function in a single operation.

9.5 Zero Settings

9.5.1 Zero Adjustment

- This function calibrates the 0 V position (ground position) to the selected zero position. Use it to assure precise results.
- Allow the unit to warm up for at least 30 minutes to ensure that the internal temperature of the input units has stabilized.
- Compensation for the measurement range is performed.

Procedure

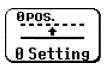

Screen: CHANNEL, Waveform display

1. Use the Menu keys to display the desired screen.
2. Move the flashing cursor to the **0 pos.** item to be set, and use the function key to select **0 Setting**.

Function display	Meaning
	: Displays the Zero Offset and Zero Adjust setup screen.

3. Select the **0 adjust** function key.

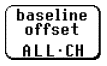
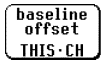
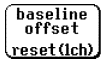
Zero adjustment can be performed for all channels at once.

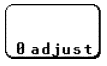
Function display	Meaning
	: Activates zero offset on all channels.
	: Activates zero offset on specified channels.
	: Disables zero offset on specified channels.
	: Exits Zero setup.
	: Performs zero adjustment. Disables zero offset on all channels.

NOTE

- Zero adjustment cannot be performed during measurement.
- Repeat the zero adjustment when the input unit was changed, when the power is on/off, or when the system is set to reset, when the measurement range is change.
- When there is a sudden change in ambient temperature the zero position may drift. To assure continued measurement precision, perform the zero adjustment again.

9.5.2 Zero Offset Setup

This function offsets the input voltage measurement to 0 V to compensate for an actual non-zero input voltage. If the actual input voltage exceeds ± 10 divisions, zero offset cannot be performed. This function is for the voltage and current measurement only.

The zero offset is active when power is off, but if the input unit configuration is changed while power is on, the zero offset must be reset.

Procedure

Screen: CHANNEL, Waveform display

1. Use the Menu keys to display the desired screen.
2. Move the flashing cursor to the **0 pos.** item to be set, and use the function key to select **0 Setting**. (When setting all channels, the channel selection is irrelevant.)

Function
display

Meaning

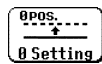

: Displays the Zero Offset and Zero Adjust setup screen.

3. Use the function key to make a setting.

Function
display

Meaning

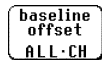

: Activates zero offset on all channels.

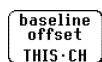

: Activates zero offset on specified channels.

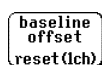

: Disables zero offset on specified channels.



: Exits Zero setup.

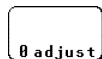

: Performs zero adjustment.
: Disables zero offset on all channels.

Input Voltage During Zero Offset

To set the zero offset, the input voltage must be stable. Otherwise, the zero offset depends on the timing of the zero offset setting.

With Fixed Input Voltage

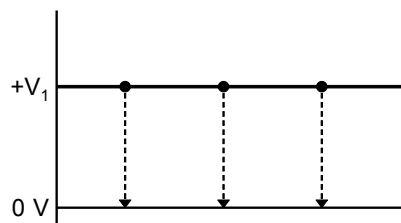

+V1 is set to 0V regardless of timing.

With Variable Input Voltage

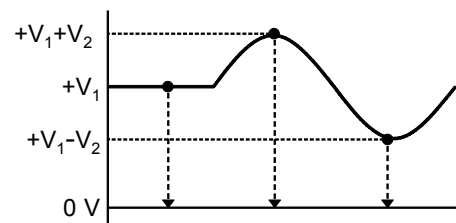

The setting value to establish the 0V level is determined at the moment of setting.

NOTE

- The zero offset function can be performed only for the input voltage measurement.
- The input voltage will be set to 0V, so before executing zero offset setting, apply the signal that is to be offset to zero.
- When the input voltage is offset to 0V by the zero offset function, the maximum input voltage and maximum constant voltage relative to ground are unaffected, so care should be observed to ensure that the limits of these voltages are not exceeded.
- When zero offset on all channels is performed, 'Warning' is displayed if zero offset cannot be set on any channel (the input voltage exceeds ± 10 divisions). In this case, the zero offset on channels which can be performed is active.

Difference Between Zero Offset and Zero Adjust

The zero offset function forces the actual input voltage to be offset to 0V for measurement purposes. That is, if there is a potential difference between the standard potential of the measurement object and the standard potential of this device (0V), this function causes the standard potential of the measurement object to be interpreted as 0V.

The zero-adjust function compensates for the difference between the input unit potential and 0V, so that it appears as 0V. This function causes the basic potential of this device to be 0V.

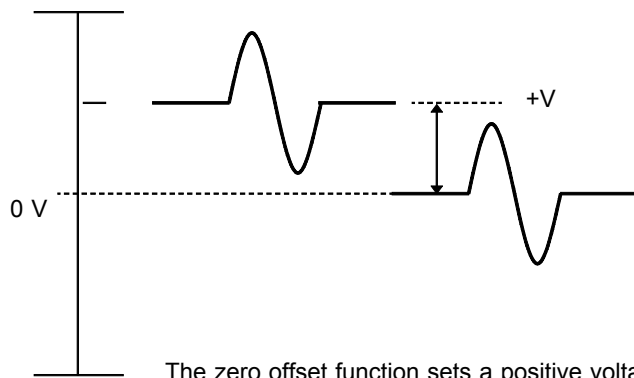

How to Determine the Zero Offset

Shows that the zero offset is enabled.

Channel screen

	graph	range/DIV	filter	lower
1	analog	100mV × 1/2	* 50%	+1.00 V
		200mV/DIV	OFF	-1.00 V
2	analog	100mV × 1/2	* 50%	+1.00 V
		200mV/DIV	OFF	-1.00 V

Shows that the zero offset is enabled.

Display screen

1	analog	200mV*	50%
		× 1	OFF
2	analog	500mV*	50%
		× 1	OFF
3	analog	200mV*	50%
		× 1	OFF

MEMORY

trigger AUTO

ch1 LVL 0.000V

↑

⏏ : 0%

9.6 Channel Guide Function

Indicates the relation of the input channel position to the channel indicated by the flashing cursor.

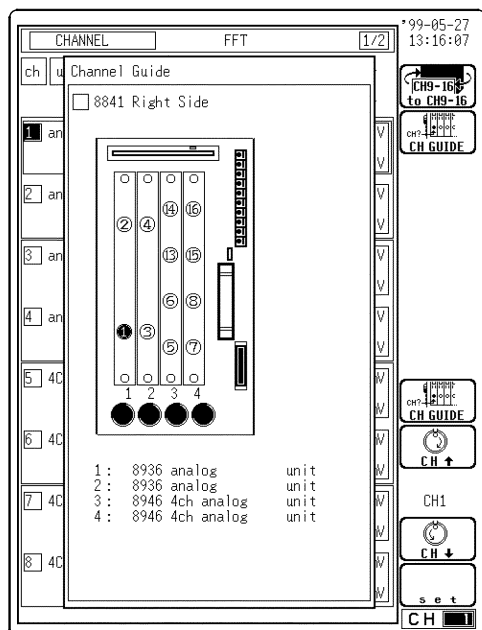

Procedure Screen: CHANNEL, Waveform display

1. Press the **CH.SET** key to display the CHANNEL screen or Waveform display screen to display the input channel setting screen.
2. Select the **CH GUIDE** function key.
The input terminal associated with the channel having the flashing cursor changes color.
3. Press the any key to exit the channel guide screen.
4. You can also check the status of CH2 to CH16.

Set the channels of the 8946 4ch ANALOG UNIT (only for the 8841 unit).

When the 8946 4ch ANALOG UNIT is used, input channels 1 to 4 are not set in this customary sequence on the 8841. The slot position at which the 8946 is mounted determines the set input channel (see the illustration below). When the 8946 is mounted in the topmost slot, channels 1, 2, 9, and 10 are defined as active channels. Thus, "Active Channel" is set to channels 1 to 8 in the system, and channel 2 of the 8946 is disabled.

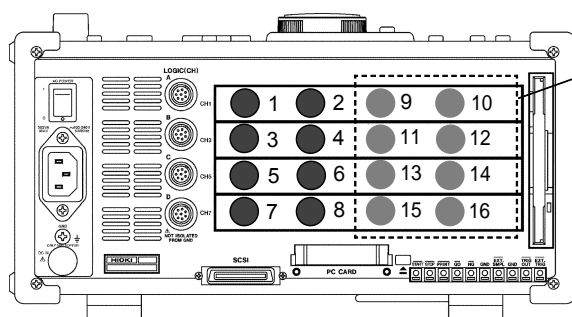

Illustrates active channels when the 8946 is mounted in each slot.

9.7 Setting the Variable Function

- The variable function allows the user to modify the waveform position and size.
- The variable screen serves for setting the lower and upper limit of the waveform display range.
- The allowable waveform display range between the upper and lower limits is 10000 times larger or smaller the currently set range. If the variable function is used, the magnification is limited to 1000 times.
- The variable function can be set to ON or OFF for each channel individually.
- If the variable auto-calibration function (refer to Section 12.2.16) is enabled, the size of a waveform on the screen does not change, even if the measurement range is changed.

The function can also be combined with the scaling function.

This is useful when wishing to display the sensor output over the full range (full-span display).

Example:

Output from sensor	Scaling	After conversion
1.23 V min, 5.78 V max.		0 [eu] min, 10 [eu] max.

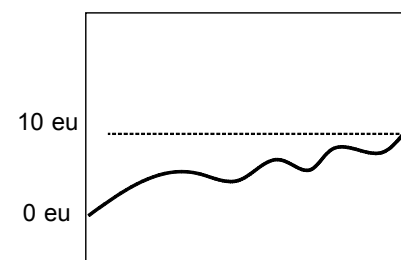
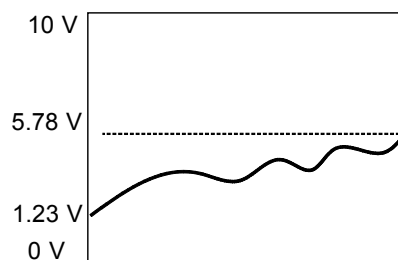

The scaling function allows conversion of the voltage output by the sensor into a desired physical quantity.

But unless the setting is changed as shown below, the display will continue to show the waveform of the sensor output voltage (with the measurement range and zero position as set on the channel screen). To use the full-span display, make the following setting:

Lower limit: 0 [eu], Upper limit: 10 [eu]

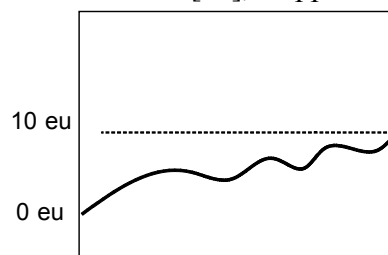

Variable function
ON

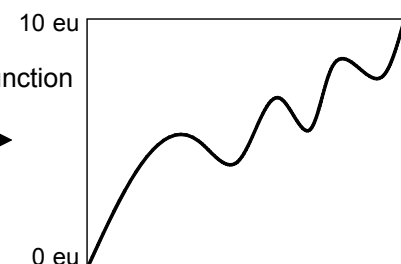

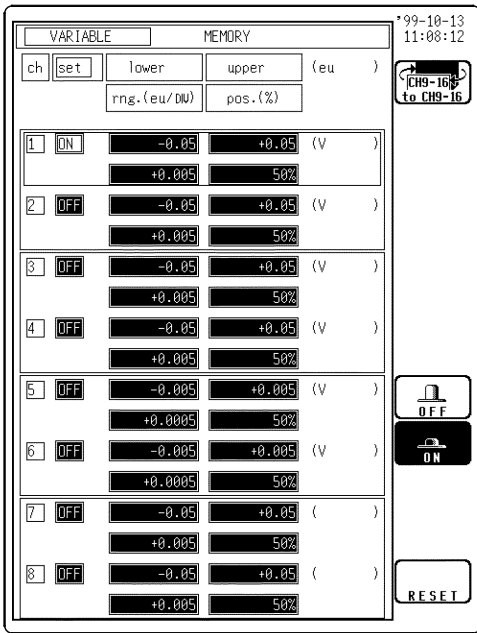

Procedure Screen:VARIABLE

1. Press the **CHAN** key to display the VARIABLE screen.
2. Move the flashing cursor to the channel to be set.
3. Use the function keys to make a setting.

Function display

Meaning



: Variable function is disabled.



: Variable function is enabled.



: Reset. The reset value is determined by the voltage axis range, zero position, and magnification ratio.

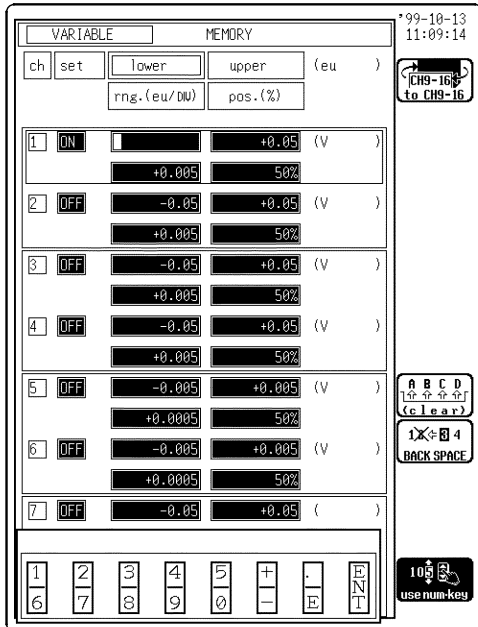

Setting the value

Method Screen:VARIABLE, Waveform display

1. Select the **use num-key** function key.
2. Enter the value using the numerical input keys.
The unit (eu) is setting on the SYSTEM2 (SCALING) screen.

NOTE

- Variable function and scaling function processing can be carried out simultaneously.
- Settings made for one channel can be copied to another channel. See Section 9.4.
- Although the variable function cannot be enabled or disabled on the display screen, the values of the enabled channels can be changed.

9.8 Scaling Function (SYSTEM2)

- The scaling function can be used to convert an output voltage from a sensor or similar into a physical quantity.
- The gauge scale (maximum and minimum values of vertical axis) and A•B cursor measurement values are displayed in the scaled units.
- Scaling can be performed for every channel.
- Two types of scaling functions are available.

Conversion ratio method

Scaling is performed by specifying a physical quantity to correspond to a 1V input signal (conversion ratio: eu/v), an offset value, and the unit (eu: engineering units). This will cause the measurement voltage to be converted into the selected units.

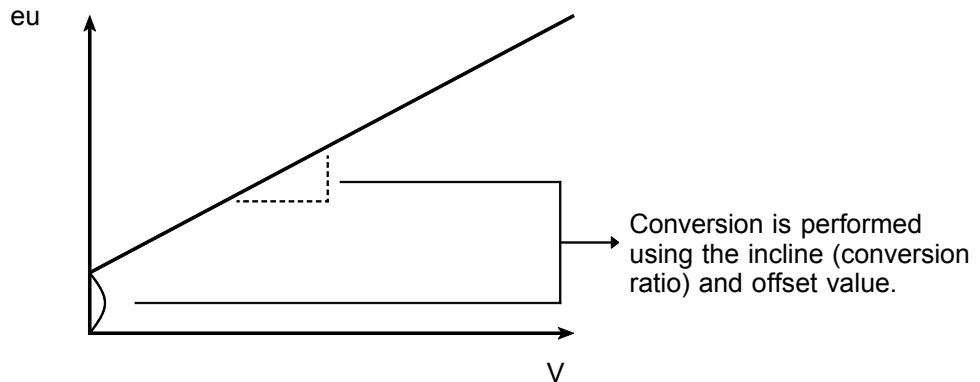

2-point method

Scaling is performed by specifying two input signal points (voltage values) and the conversion values for these two points in engineering units (eu). This will cause the measurement voltage to be converted into the selected units.

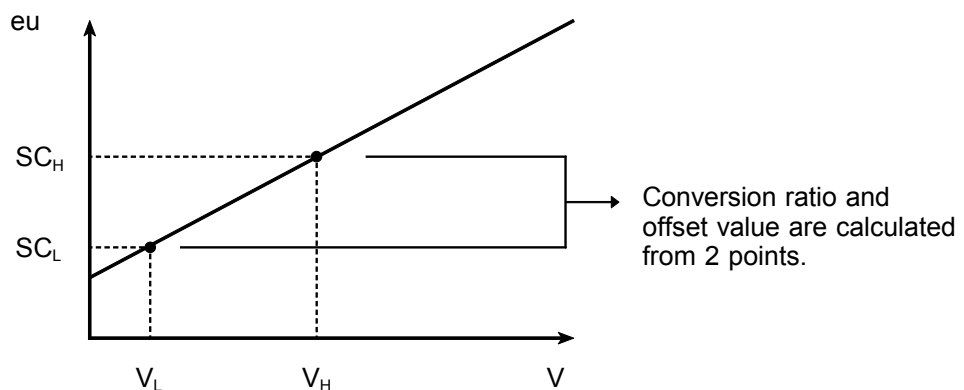

V_H : Voltage high point
 V_L : Voltage low point

SC_H : Scaling high point
 SC_L : Scaling low point

9.8.1 Setting the Scaling Function

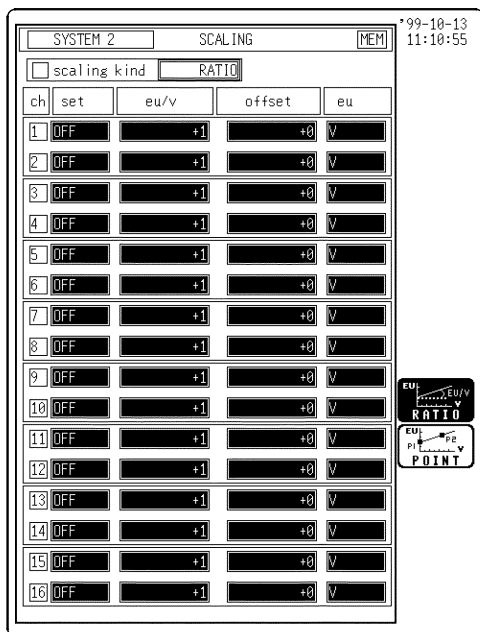



Procedure Screen: SCALING (SYSTEM2)

(1) Selecting the scaling method

1. Press the **SYSTEM** key to display the scaling setting screen.
2. Move the flashing cursor to the position **scaling kind**.
3. Use the function keys to make the selection.

Function display Meaning

 : Use conversion ratio method

 : Use 2-point method

(2) Setting the scaling function

1. Move the flashing cursor to the desired channel.
2. Use the function keys to make the selection.

Function display Meaning

 : Scaling not used

 : Scaling used (specify exponent as integer)

 : Scaling used (specify exponent as multiple of 3)

 : Initializes the conversion ratio

The conversion ratio is 1 and the offset is 0 when "Use conversion ratio method" is selected.

The value before and after conversion are the same when "Use 2-point method" is selected.

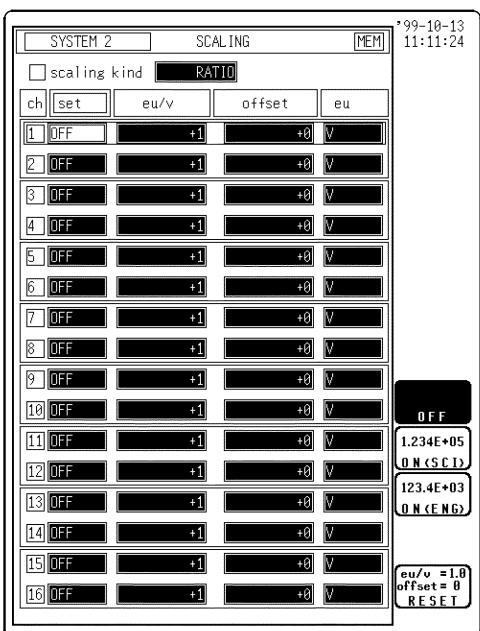

NOTE

If the scaling function is used to display and print out the exponents of data in integer form, values that fall in the range between 0.0001 and 100000 are expressed as they are, rather than in exponential form.

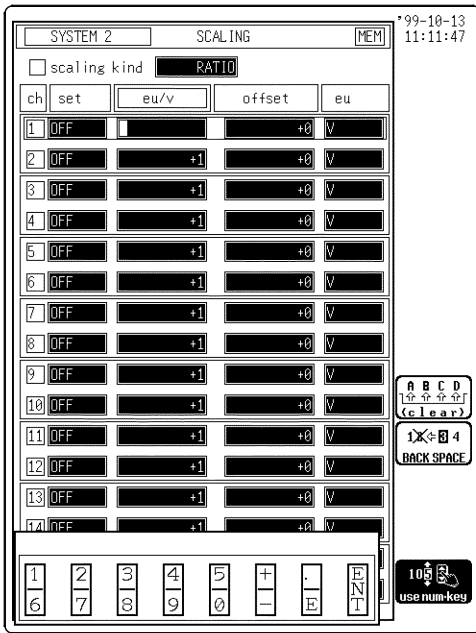

(3) Entering the numerical value Method

1. Use the function key to select **use num•key**.
2. Use the numerical input key to enter the numerical value.

Conversion ratio method (conversion ratio: eu/v, offset)

The setting range: $-9.9999E+9$ to $+9.9999E+9$.

2-point method (voltage value: volts, values after conversion: scale)

The setting range: $-9.9999E+29$ to $+9.9999E+29$.

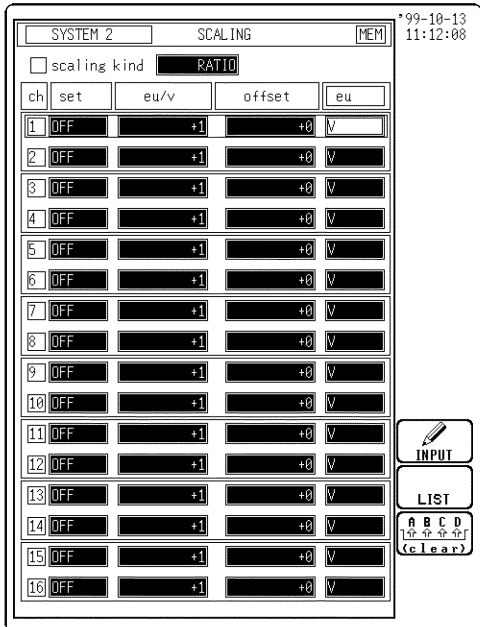

(4) Enter the unit

The unit name can be up to 7 characters long.

1. Move the flashing cursor to **eu**.
2. Select the **INPUT** function key. (See Section 9.9.3)
If you select List, you can select the unit from the unit list.

NOTE

- Settings made for one channel can be copied to another channel. See Section 9.4.
- When the scaling and waveform processing are simultaneously specified, the scaling function is not applied to the results of the waveform processing stored in the internal memory.

Combination of the scaling and variable functions

The scaling function can be combined with the variable function. When using the scaling and variable functions together:

With variable auto-calibration off (refer to Section 12.2.16):

Set the scaling first. If set in the sequence "Variable" "Scaling," the upper and lower limits must be set with physical values after conversion in the variable settings (after scaling).

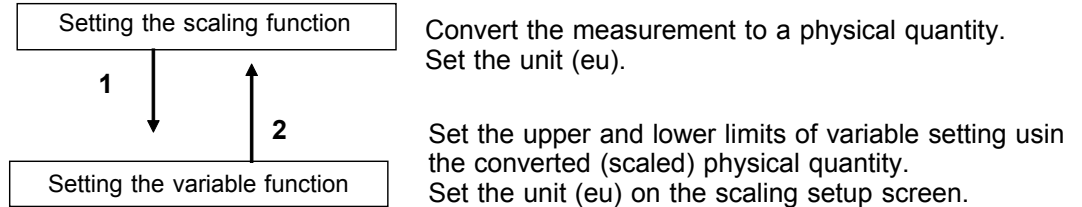

With variable auto-compensation on (refer to Section 12.2.16):

Even if the scaling settings are altered later, the waveform appearance will not change significantly, since the variable settings are calibrated automatically.

How to identify scaled data output

The gauge unit indication [] is widened (when the gauge is set to ON.)

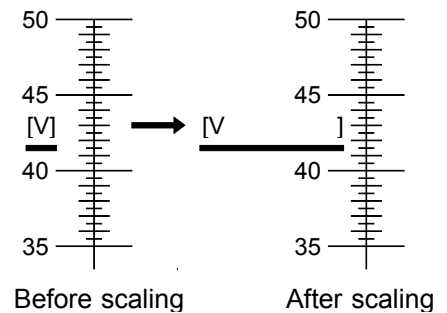

The input channel is represented in full-span mode instead of full-scale mode, and the unit is displayed in []

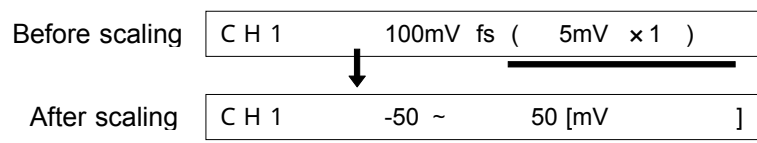

9.8.2 Scaling Setting Example

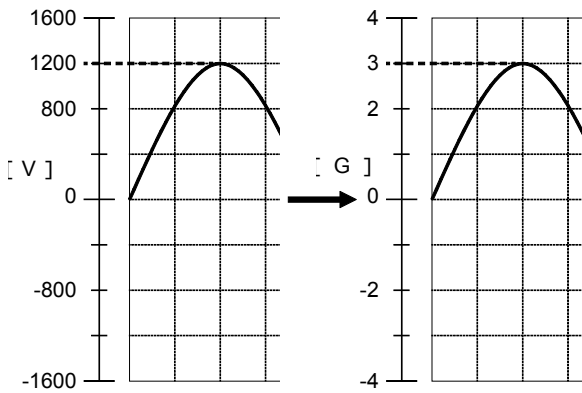
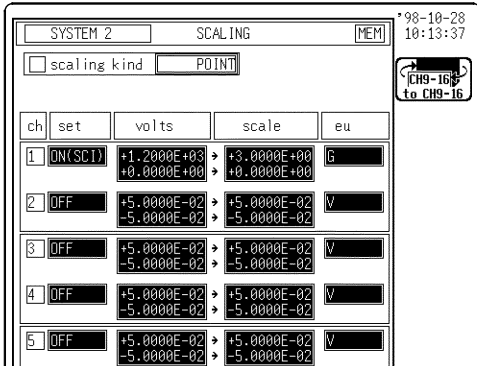

The example below shows the scaling function of the strain unit.

When a sensor (the conversion ratio is characterized as "3G = 1200 μ (micro strain)") is used:

Scaling method: 2-point method

Setting: SCI or ENG

Converting value: 1200 (μ) 3 (scale),

0 (μ) 0 (scale)

unit (eu): G

Through the use of the scaling function, the signal from the sensor can be obtained in the form of a physical quantity.

Cursor values A and B, respectively, show the physical quantities.

If the gauge is turned on before the printout is made, the gauge is output in a physical quantity.

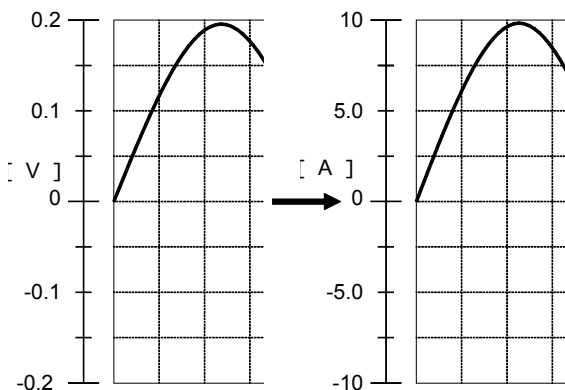
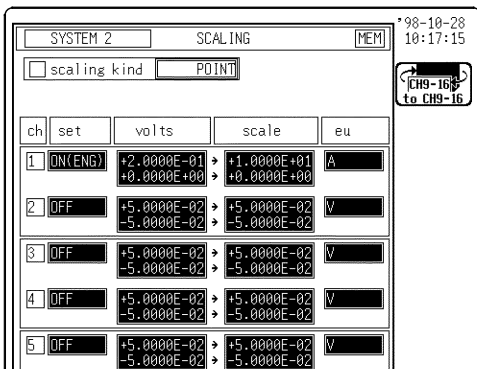

The example below shows the type of scaling when the measurement range is set to 10 A using the 9018 CLAMP ON PROBE.

Scaling method: 2-point method

Setting: SCI or ENG

Converting value: 0.2 (V) 10 (scale),

0 (V) 0 (scale)

unit (eu): A

Through the use of the scaling function, the signal from the sensor can be obtained in the form of a current value.

Cursor values A and B, respectively, show the current values.

If the gauge is turned on before the printout is made, the gauge is output in a current value.

9.9 Comment Function (SYSTEM 3)

9.9.1 Title Comment Entry

Title comments of up to 40 characters can be included on the recording paper.

Enabling title comment input prints the title on recording paper for all functions. "SET & COM" prints setup conditions (function, time axis range, magnification of time axis, and trigger time) along with the title.

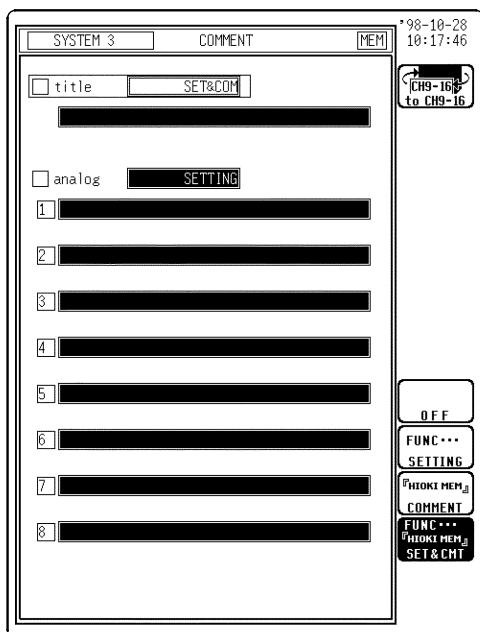

Procedure Screen: COMMENT (SYSTEM 3)

1. Press the **SYSTEM** key to display the SYSTEM3 screen.
2. Move the flashing cursor to **title**.
3. Use the function keys to make the selection.

Function display	Meaning
OFF	: Standard printout is performed.
FUNC... SETTING	: Setting item is printed.
HIOKI MEM.d COMMENT	: Comment is printed.
FUNC... HIOKI MEM.d SET & CMT	: Both item and comment are printed.

4. Enter the comment when **COMMENT** or **SET&COM** is selected.
5. Move the flashing cursor to the position shown in the figure on the left.
6. Select the function key.

Function display	Meaning
COMME COMMENT	: Input comment.
A B C D ↑ ↑ ↑ ↑ (c l e a r)	: Clear comment.

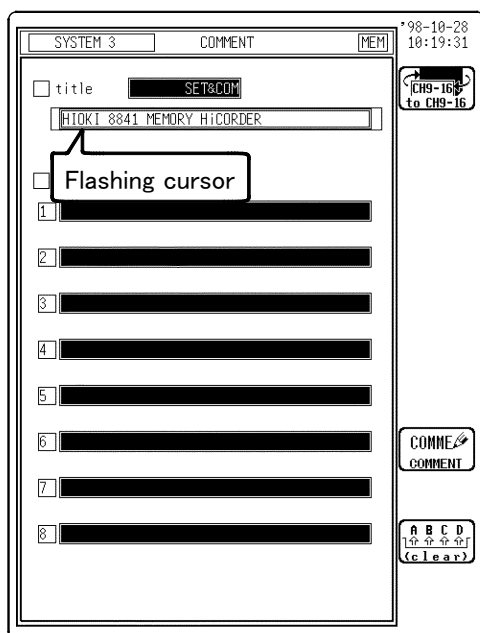

For details on comment input, see Section 9.9.3.
For the print examples, see Section 13.5.

9.9.2 Analog/Logic Channel Comment Entry

Comments of up to 40 characters can be included on the recording paper on each channel. If "COMMENT" or "SET & COM" is selected, this comment will be included on the recording paper in all functions.

"SET & COM" prints the settings for each channel (voltage axis range, magnification of voltage axis, zero position, low-pass filter, and full span voltage range), along with comments.

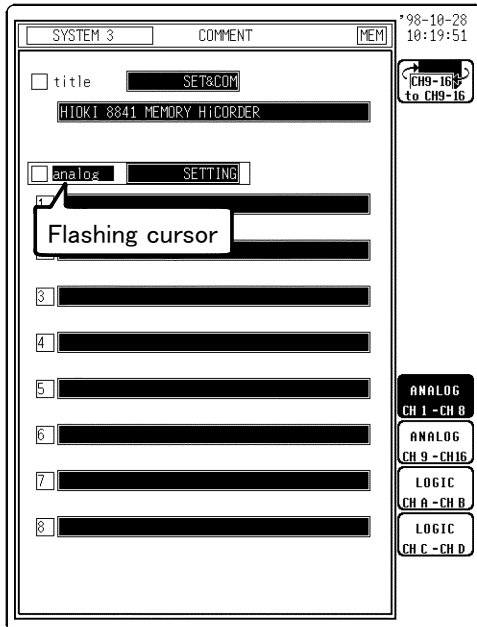

Procedure Screen: COMMENT (SYSTEM3)

1. Press the **SYSTEM** key to display the comment setting screen.
2. Move the flashing cursor to the position shown in the figure on the left, and use the function keys to select the desired channel screen.

Function display Meaning

ANALOG CH 1 - CH 8	: Analog channels 1 to 8
ANALOG CH 9 - CH 16	: Analog channels 9 to 16
LOGIC CH A - CH B	: Logic channels A and B
LOGIC CH C - CH D	: Logic channels C and D

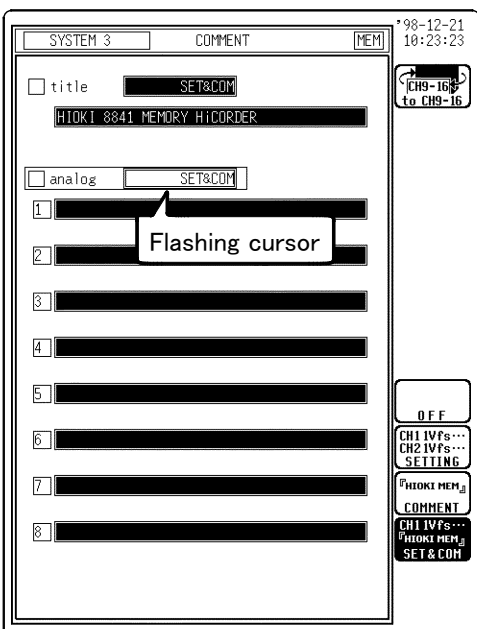

3. Move the flashing cursor to the position shown in the figure on the left.

Use the function keys to make the selection.

Function display Meaning

OFF	: Standard printout is performed.
CH1 IVFs... CH2 IVFs... SETTING	: Setting item is printed.
HIOKI MEM COMMENT	: Comment is printed.
CH1 IVFs... HIOKI MEM SET & CMT	: Both item and comment are printed.

4. Move the flashing cursor to the channel to be input and use the function keys to make the selection.

Function display Meaning

COMME COMMENT	: Input comment.
A B C D (clear)	: Clear comment.

For details on comment input, see Section 9.9.3, and for the example of printing, see Section 13.5.

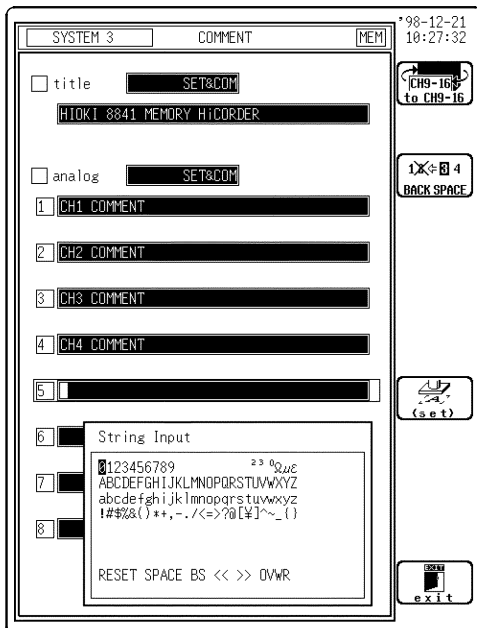
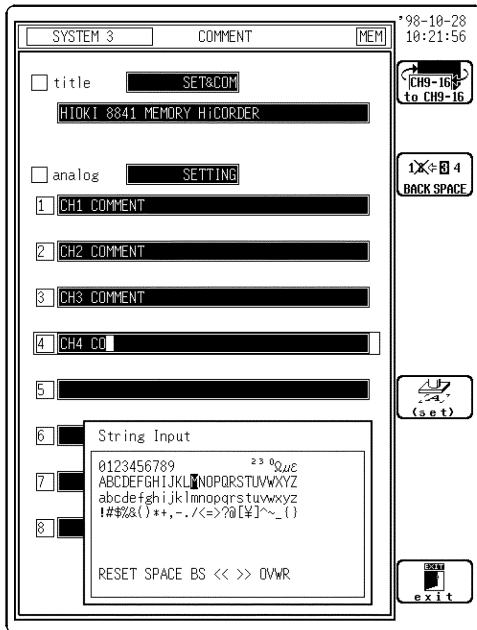

9.9.3 Character Entry Procedure

The procedure for entering the characters for the comments, units, etc. is described.





Procedure Screen: COMMENT (SYSTEM3)

1. Move the flashing cursor to the position in which you want to enter the comment. Move the flashing cursor to the desired position.
2. Use the function keys to make the selection.

Function display	Meaning
	: Enter comment.
	: Enter character.
	: Clear comment.

3. Use the cursor keys to select the character.

Function display	Meaning
	: Enter a character at the position of the cursor.
	: Execute the command at the cursor.
	: Exit

4. Use the cursor keys to move the cursor to the selection window, and select **(set)** on the character to be input.
5. Repeat Steps 3 and 4 to enter a comment (using characters).

The file and directory names cannot include spaces.

Comment Copy

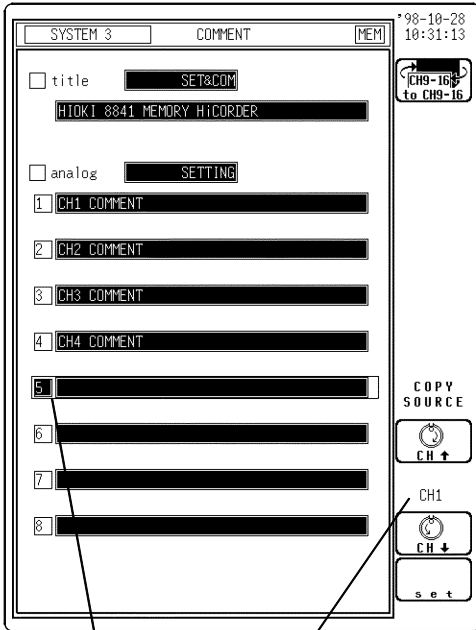

Copy target Copy source

Procedure Screen: COMMENT (SYSTEM3)

1. Press the **SYSTEM** key to display the SYSTEM3 screen.
2. Move the flashing cursor to the channel for which you want to copy the comment.
3. Use the function keys or Jog/Shuttle control to select the channel to be copied.

Function display Meaning



: Increase channel number



: Decrease channel number

Selection of "for ALL" enables the comments for the channel with the flashing cursor to be copied to all channels.

4. Press the **set** function key to copy.

Description of Window Contents

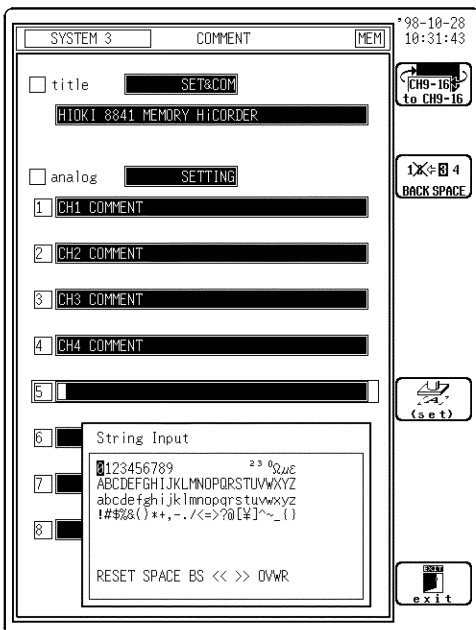

RESET Recalls an unedited comment in comment input mode. Recalls the default units in unit input mode.

SPACE Enter a space.

BS Performs backspacing (same as the BACK SPACE key).

<< Moves the input position to the left (same as the Jog/Shuttle control).

>> Moves the input position to the right (same as the Jog/Shuttle control).

OVR/INS Switches the mode between overwrite and insert.

9.10 Setting the Waveform Display Screen

9.10.1 Entering by CH.SET Key

Pressing the **CH.SET** key, enables the measurement conditions for each channel on the Waveform display screen to be set or changed.

It is possible to make the settings, while monitoring the waveforms in real time on the Waveform display screen. For details on settings, refer to Section 9.3.

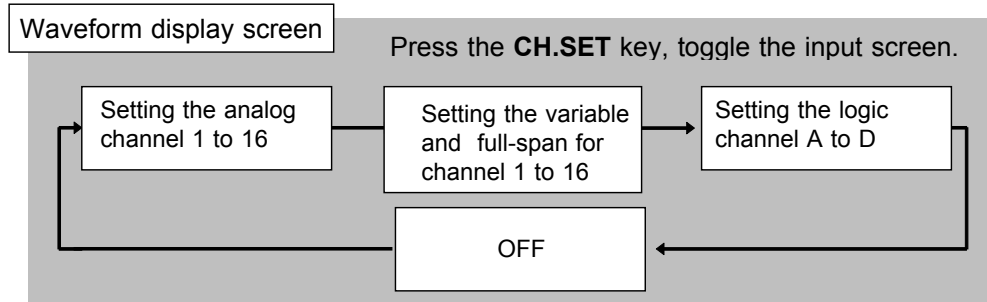

Setting the analog channels

- Waveform display color
- Waveform display graph position
- Unit name
- Measurement range
- Magnification/compression ratio, Vernier function
- Zero position
- Low-pass filter
- Full span

(Channel copy can not be carried out)

Setting the full span /variable

- Full span
- Variable function
(can not be set to ON/OFF)

Setting the logic channels

- Waveform display color
- Waveform display graph position

NOTE

In FFT function, the **CH.SET** key cannot be used to input.

9.10.2 Setting the Vernier Function

With the vernier function, input voltage can be minutely adjusted to the desired value. When recording various physical quantities using noise, temperature, and acceleration sensors, this vernier function allows you to adjust amplitudes to assist with calibration. For example, use the vernier function when you want to convert an input voltage of 1.2 V to 1.0 V and display the converted value.

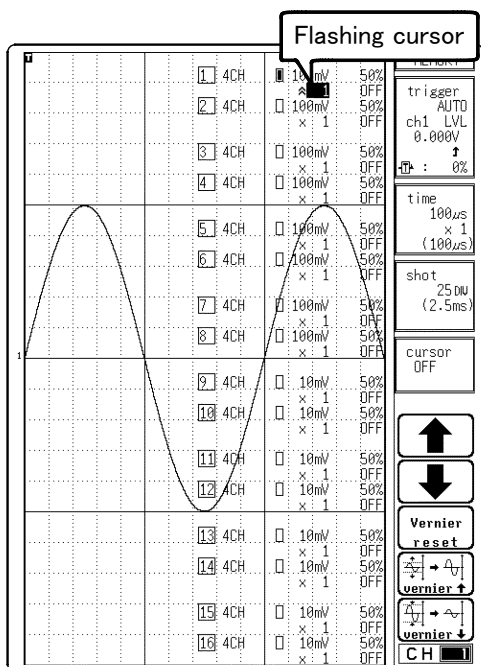

1. Press the **DISP** key to display the Waveform display screen.
2. Press the **CH.SET** key and move the flashing cursor to the channel to be set shown in the figure on the left.
3. Use the function key to select the vernier function.

⤴ is observed in its expanded state while ⤵ is observed compressed. The adjustable range is 50 to 200% of the original waveform.

Function display	Meaning
	: Cancel the vernier function (restores the waveform to its original size)
	: Magnifies the waveform.
	: Compresses the waveform.

NOTE

- The vernier function is not applicable to a waveform after waveform processing.
- The ratio of the waveform's enlargement or compression is not displayed.
- The vernier function ON/OFF setting can be checked after the **CH.SET** key is pressed to display each channel setting on the screen. This setting cannot be checked using the printout or list print function.

9.10.3 Direct Channel Setting

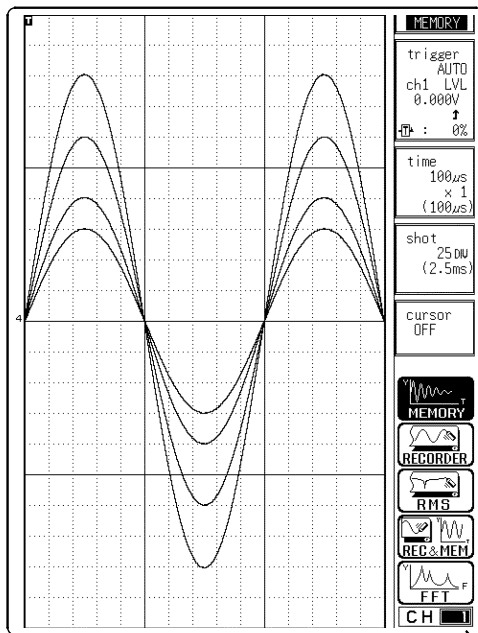

1. Press the **DISP** key to call the Waveform display screen.
The channels that can be set currently using the **RANGE** knob (measurement range) and **POSITION** knob (zero position) are displayed at the bottom right of the screen.
2. Use channel-select keys CH1 to CH16 to select a channel. Only the channel associated with the input unit connected to the 8841/8842 can be selected.
3. The zero-position and voltage-axis range of the channel selected with the **POSITION** knob and **RANGE** knob can be set.
4. The Jog control allows you to display or hide the waveform, or set the waveform color.
5. To make a setting for other channels, use the channel select key.
Press any key to exit the direct-channel setting function.

Selected channel is displayed

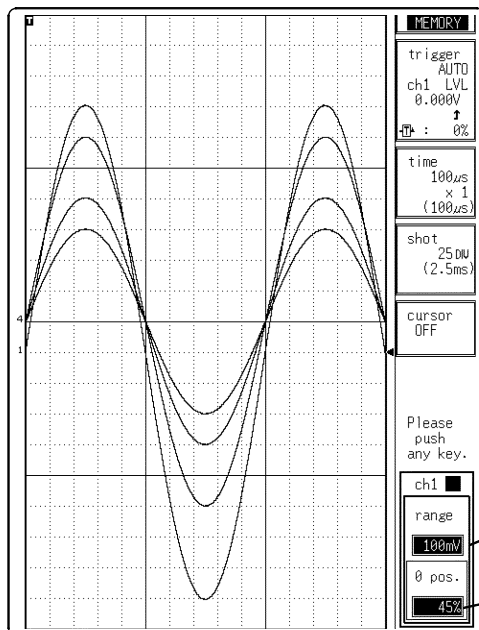

Setting of the voltage axis range

Setting of the zero position

NOTE

- The settings by using the **CH.SET** key, the following operations cannot be provided:

Copying channel settings

Variable function: ON/OFF (Input value can be changed)

- While channel setting can be performed using the **CH.SET** key, direct channel setting on the display screen allows channels to be selected and set up. This direct channel setting is enabled even in the startup process.

9.11 Setting the 8937 VOLTAGE/TEMP UNIT

⚠ WARNING

A common GND is used for voltage and temperature input on all channels. Never input voltage and temperature simultaneously, since doing so could result in damage to the sample being tested.

NOTE

- Digital filter and drift compensation settings cannot be determined from the Waveform display or CHANNEL screen. Check through the function display that appears when the flashing cursor is moved to the "range" item.
- Measurement conditions for the measured waveform data can be determined from the printed listing. The settings for the digital filter, drift compensation, reference contact compensation and the type of thermocouple can be determined. See Section 13.5.

The 8937 VOLTAGE/TEMP UNIT allows measurement of voltage or temperature on any channel. See Section 9.3, "Setting the CHANNEL Screen" for the common settings.

9.11.1 Making the Settings of Voltage Measurement

The digital filter can be configured when the measurement range is $500\ \mu\text{V}$ to 2 mV. The digital filter is a function which eliminates the noise component by additive averaging inside the amplifier. This results in a data update rate of about $100\ \mu\text{s}$.

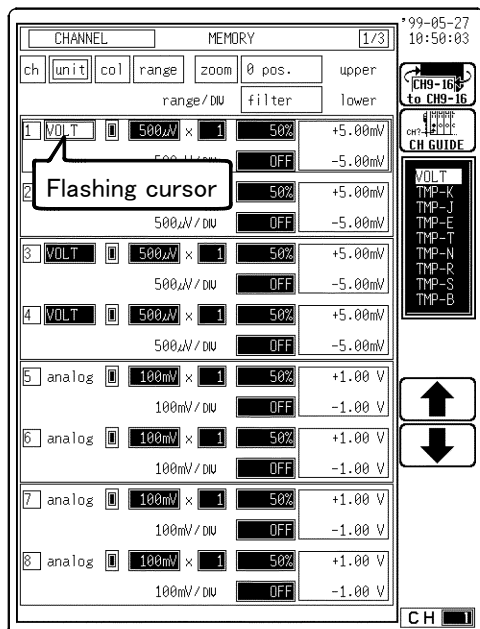

Procedure Screen: CHANNEL, Waveform display

(1) Set the measurement mode.

1. Display the CHANNEL or Waveform display screen.
2. Press the **CH.SET** key to display channel screen to be set.
3. Move the flashing cursor to the **unit** item. Use the function keys or the Jog/Shuttle control to select **VOLT** (voltage).

Function display Meaning



: Move the cursor up in the selection window.



: Move the cursor down in the selection window.

NOTE

The symbol "*" in the selection window indicates the settings of the data stored to current memory. (If no data is present in memory, this symbol is not displayed.)

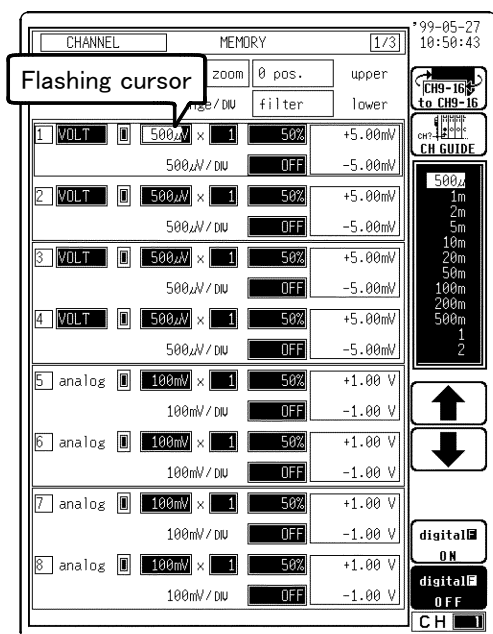

(2) Set the measurement range and digital filter.

1. Move the flashing cursor to the point shown in the figure on the left.
2. Use the Jog/Shuttle control, the function keys or the **RANGE** knob to set the measurement range.

Function display	Meaning
	: Move the cursor up in the selection window.
	: Move the cursor down in the selection window.



: Move the cursor up in the selection window.



: Move the cursor down in the selection window.

3. Set the digital filter.

Function display	Meaning
	: Digital filter is enabled. (Measurement range: 500 μ V to 2 mV/DIV)
	: Digital filter is disabled.

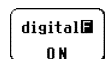

: Digital filter is enabled.
(Measurement range: 500 μ V to 2 mV/DIV)



: Digital filter is disabled.

NOTE

- When the digital filter has been set to ON and the measurement range is changed to one other than 500 μ V/DIV to 2 mV/DIV, the digital filter is automatically turned off. To turn on the digital filter, perform the setup procedure from the beginning.
- Zero adjustment cannot be performed during measurement.
- Repeat the zero adjustment when the voltage axis range was changed, when the input unit was changed, when the power is on/off, or when the system is set to reset.
- When there is a sudden change in ambient temperature, the zero position may drift. To assure continued measurement precision, perform the zero adjustment again.

9.11.2 Making the Settings of Temperature Measurement

Select the thermocouple type, drift correction and standard contact compensation to be used.

Procedure Screen: CHANNEL, Waveform display

(1) Set the measurement mode.

1. Display the CHANNEL or Waveform display screen.
2. Press the **CH.SET** key to display the channel screen to be set.
3. Move the flashing cursor to the **unit** item. Use the function keys, or Jog/Shuttle control to select **TMP** (temperature).

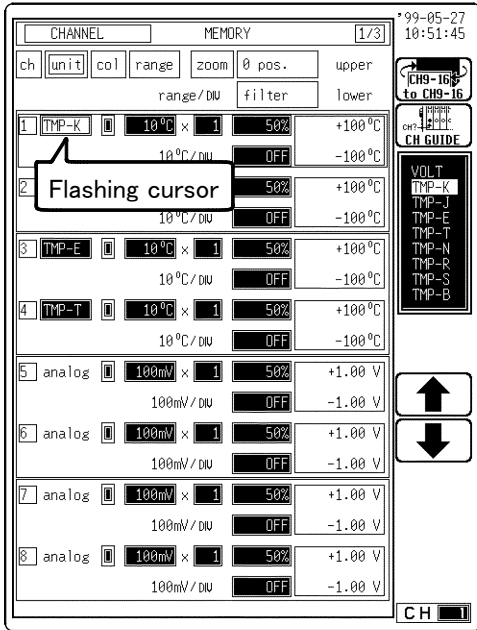

Function display Meaning



: Move the cursor up in the selection window.



: Move the cursor down in the selection window.

TMP	Measurement range	TMP	Measurement range
K	-200°C to 1350°C	N	-200°C to 1300°C
E	-200°C to 800°C	R	0°C to 1700°C
J	-200°C to 1100°C	S	0°C to 1700°C
T	-200°C to 400°C	B	300°C to 1800°C

(2) Set the measurement range and Drift compensation. Drift compensation is a function that periodically (about once per second) cancels the variances in the reference voltage that accumulate over time.

1. Move the flashing cursor to the position shown in the figure on the left.
2. Use the function keys or the Jog/Shuttle control to set the measurement range.

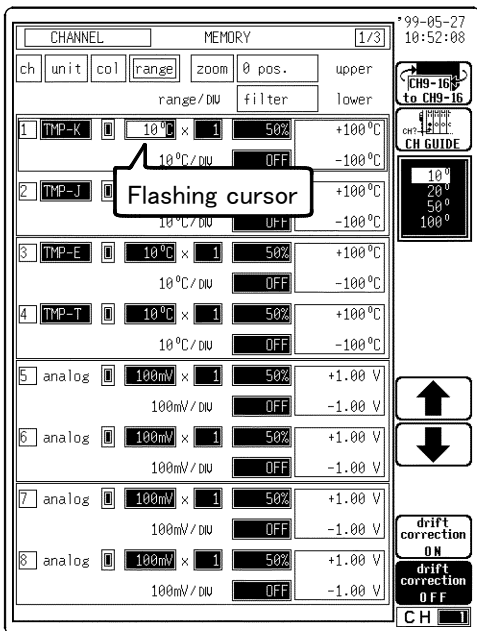

Function display Meaning



: Move the cursor up in the selection window.



: Move the cursor down in the selection window.

3. Use the function keys to set the drift compensation.

Function display Meaning



: Drift compensation is enabled.



: Drift compensation is disabled.

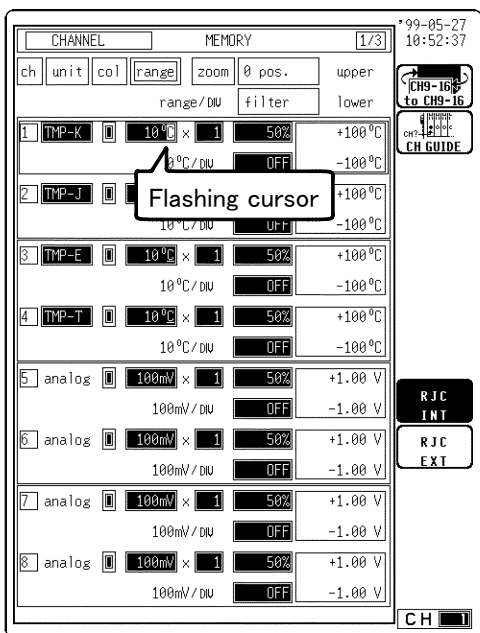

(3) Set the reference junction compensation.

1. Move the flashing cursor to the point shown in the figure on the left.
2. Use the function keys to make a setting.

Function display	Meaning
R J C I N T	Reference junction compensation is performed internally by the 8937. (Measurement accuracy is the sum of the accuracy of temperature measurement plus reference junction compensation accuracy.)
R J C E X T	Reference junction compensation is not performed by the 8937. Select this option when using an external reference junction compensation unit. (Measurement accuracy refers only to the accuracy of temperature measurement.)

Discriminating between internal and external reference junction compensation

10°C : Internal: No underline appears below C.

10°C : External: The underline appears below C.

Measurement range and upper and lower limits of measurement input

Note that the upper and lower limits of measurement input vary according to measurement range. Waveform saturation will result if the limits indicated in the table below are exceeded.

Measurement range	10°C/DIV	20°C/DIV	50°C/DIV	100°C/DIV
Upper limit of measurement input	400°C	800°C	2000°C	4000°C
Lower limit of measurement input	-92°C	-184°C	-460°C	-920°C

Examples of waveform display measurement according to measurement range (Position: 50%, magnification/compression ratio: × 1, NORMAL screen, thermocouple: T)

When thermocouple measurement range is exceeded

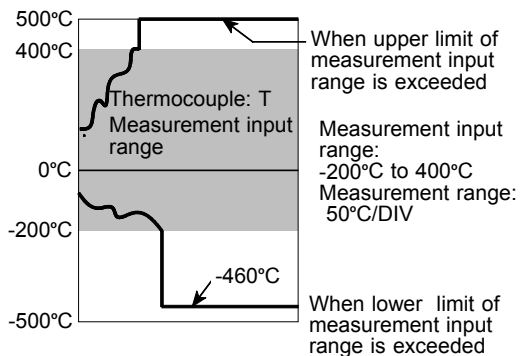

When lower limit of measurement input is exceeded

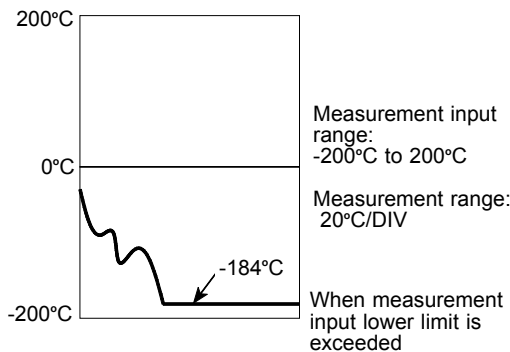

NOTE

- If ambient temperature changes suddenly, loss of thermal equilibrium can result in measurement error. When this occurs, allow the unit to acclimate to the new temperature for about one hour, then take measurements after thermal equilibrium is reached.
- It is recommended that drift compensation be turned ON when using a thermocouple with small thermoelectromotive force (sensor R, S or B) to record over an extended period of time in an environment where ambient temperature fluctuates.
- If the temperature input terminal is exposed to a strong draft, loss of thermal equilibrium at the input may result in measurement error. When taking measurements under such conditions, arrange the unit in such a manner that the input terminal is protected for direct exposure to drafts.
- Upon resetting the system, the "unit" item is set to Voltage.

9.12 8938 FFT ANALOG UNIT

The 8938 FFT ANALOG UNIT contains an internal anti-aliasing filter required for FFT analysis. Enable the anti-aliasing filter when doing FFT analysis.

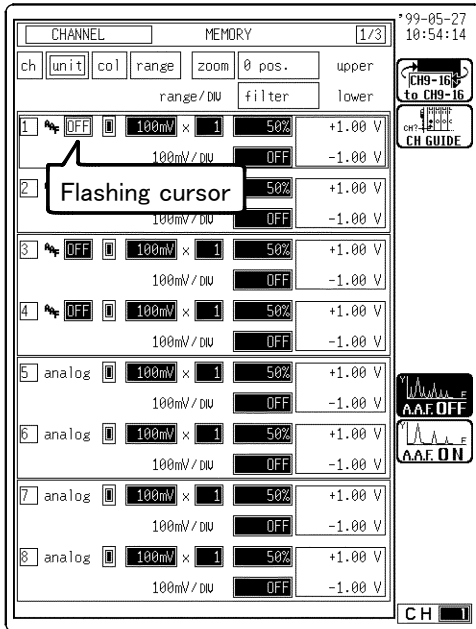

Procedure Screen: CHANNEL, Waveform display
Set the antialiasing filter.

1. Display the CHANNEL or Waveform display screen.
2. Press the **CH.SET** key to display the channel screen to be set.
3. Move the flashing cursor to the position shown in the figure on the left.
4. Use the function keys to select.

Function
display

Meaning



: Anti-aliasing filter is disabled.



: Anti-aliasing filter is enabled.

NOTE

- We recommend using an input unit equipped with an anti-aliasing filter that can be enabled to minimize sampling distortions during FFT analysis.
- Refer to Appendix 3.10, "FFT Function" for more information about aliasing distortion and anti-aliasing filters.
- If the anti-aliasing filter is on, "A" is printed at the end of the filter settings page during list printing. Refer to Section 13.5, "Example of Printer Output".
- Refer to Section 8.3.3, "Setting the Frequency Range" for details about the relationship between the anti-aliasing filter cutoff frequency and the frequency range and time axis range.

9.13 Setting the 8939 STRAIN UNIT

For the channel to which the 8939 STRAIN UNIT is assigned, an auto balancing must be executed through the range setup menu.

Auto balancing is a function by which the reference output level of the converter is adjusted to the specified zero position.

Before the auto balancing is performed, the strain unit must be warmed up for approximately 1 hour after power-on to stabilize its internal temperature. The scaling function can be used to convert an output voltage from a sensor or similar into a physical quantity. See Section 9.8.2.

See Section 9.3, "Setting the CHANNEL Screen" for the common settings.

Procedure

Screen: CHANNEL, Waveform display

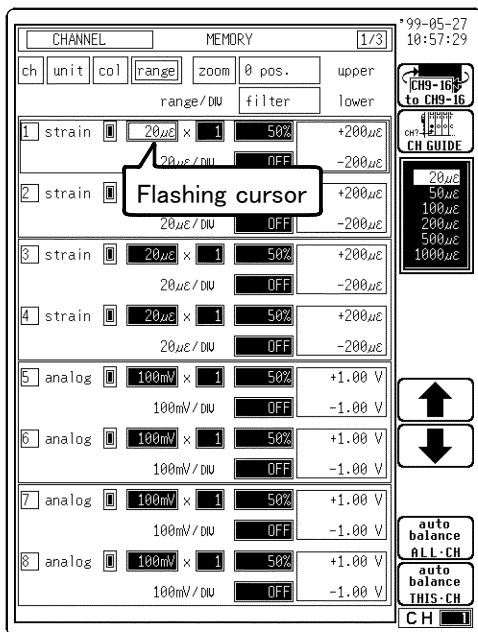

(1) Set the measurement range.

1. Display the CHANNEL or Waveform display screen.
2. Press the **CH.SET** key and move the flashing cursor to desired channel.
3. Move the flashing cursor to the **range** item.
4. Use the function keys, the Jog/Shuttle control or **RANGE** knob to set the measurement range.

Function display	Meaning
	: Move the cursor up in the selection window.
	: Move the cursor down in the selection window.

(2) Perform auto-balance.

Set for selected channels only, or for all channels.

Function display	Meaning
	: All strain channels execute the auto balancing.
	: Only selected channel execute the auto balancing.

NOTE

- Connect the sensor, make sure there is no input, and execute auto balancing.
- Auto balancing is disabled during measurement.
- The key manipulation is rejected during measurement.
- Repeat the auto balancing when the input unit was changed, when the power is on/off, when the system is set to reset, when the measurement range is change, when the strain gauge adapter is change.
- When there is a sudden change in ambient temperature the zero position may drift. To assure continued measurement precision, perform the auto balancing again.

9.14 8940 F/V UNIT

The 8940 F/V UNIT can measure frequency, count, pulse duty ratio, voltage and current on each channel (with one measurement type per channel). See Section 9.3, "Setting the CHANNEL Screen" for the common settings.

Frequency	Obtains the frequency of the input pulse corresponding to the measured waveform.
Count	Counts the number of input pulses.
Pulse Duty Ratio	Obtains the duty ratio of the measured waveform.
Voltage	Measures the waveform voltage.
Current	Measures the waveform current.

Probe checking with the 9322 DIFFERENTIAL PROBE

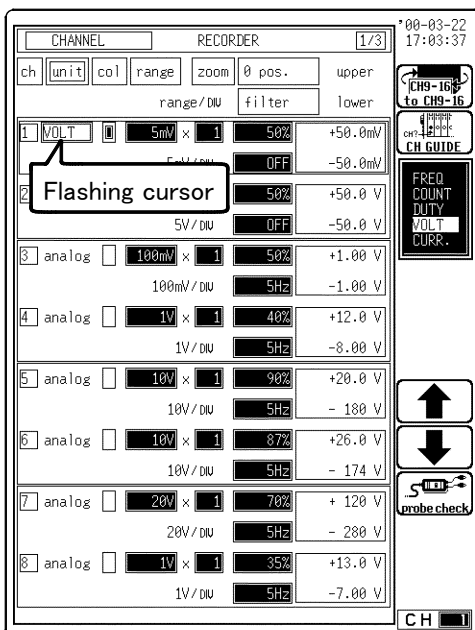

With the 8940 F/V UNIT, scaling for the probe check input range can be set automatically. You must set the scaling for all other input units manually.

Move the flashing cursor to the illustrated position for the channel you want to check, then select Probe Check from the function key display. The scaling for voltage mode is 1/1000. The threshold values for frequency, duty ratio, and integration mode are 100 times, and the ideal input range for frequency mode is P50/P60. For details, refer to the 9322 DIFFERENTIAL PROBE User*s Manual.

NOTE

- Hold and pull up settings cannot be determined from the Waveform display or CHANNEL screen. Check through the function display that appears when the flashing cursor is moved to the "range" item.
- During list printing, Hold and Pull-Up on/off selections are printed. Refer to Section 13.5, "Example of Printer Output" for details.
- The input coupling is fixed at DC for Frequency, Count and Pulse Duty Ratio measurement modes.
- Measurement results may differ depending on the threshold setting. To obtain the correct measurement, set the threshold to match the input waveform.

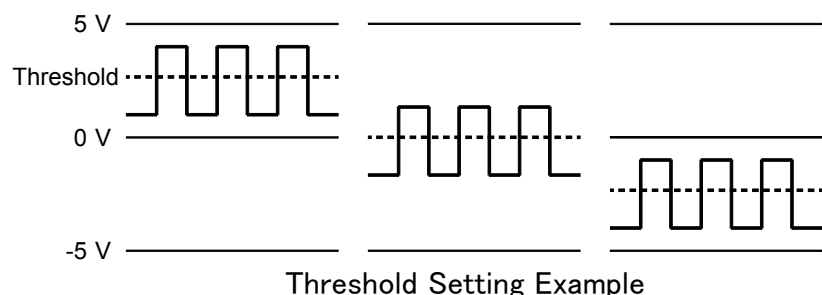

9.14.1 Frequency Measurement

Select the measurement range. For the Frequency mode, three types of measurement can be performed depending on the measurement range. Frequency can be measured from 0.05 Hz to 5 kHz, RPM can be measured from 5 to 500 r/min, or commercial power can be measured at P50 or P60 Hz.

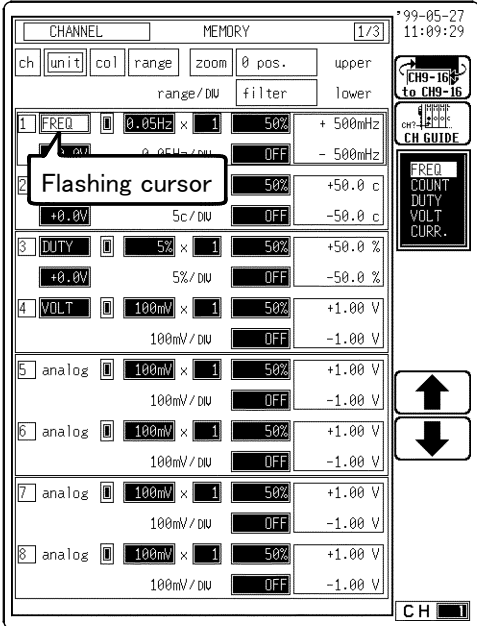

Procedure Screen: CHANNEL, Waveform display

- (1) Set the measurement mode.
 1. Display the CHANNEL or Waveform display screen.
 2. Press the **CH.SET** key and move the flashing cursor to desired channel.
 3. Move the flashing cursor to the **unit** item.
 4. Use the function keys, the Jog/Shuttle control to select **FREQ** (frequency).

Function display Meaning



: Move the cursor up in the selection window.



: Move the cursor down in the selection window.

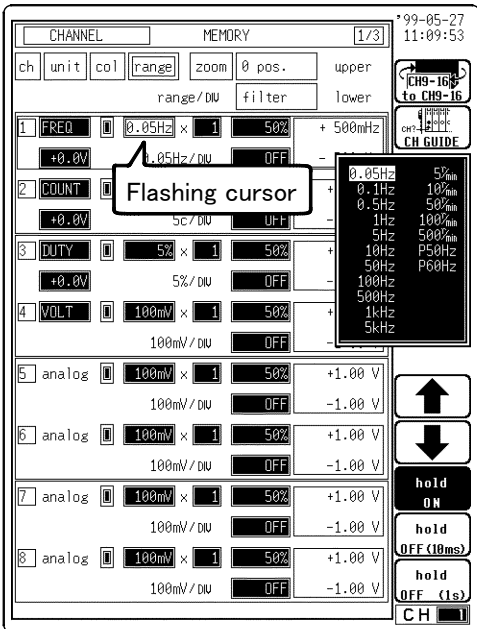

(2) Set the measurement range.

1. Move the flashing cursor to the position shown in the figure on the left.
2. Use the function keys, Jog/Shuttle control, or **RANGE** knob to set the measurement range. With the **RANGE** knob, settings can be made regardless of the position of the flashing cursor in the channel being set.

Measurement range

0.05 Hz to 5 kHz (frequency)

5 r/min to 500 r/min (number of rotation)

P50 Hz / P60Hz (commercial power supply)

Function display Meaning



: Move the cursor up in the selection window.



: Move the cursor down in the selection window.

NOTE

In the Frequency mode, the measurement range can be set to P50Hz or P60Hz for commercial power. Although 0 Hz is the usual zero position, in this case 50 or 60 Hz becomes the zero position.

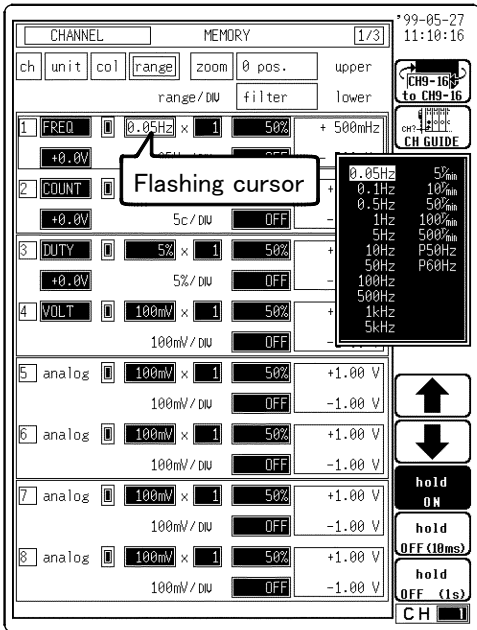

(3) Set the Hold function.

1. Move the flashing cursor to the position shown in the figure on the left.
2. Use the function keys to set.

Function display Meaning

- : The last value is displayed until the next frequency measurement is confirmed.
- : Half of the last value is displayed if the next frequency measurement is not confirmed within 10 ms.
- : Half of the last value is displayed if the next frequency measurement is not confirmed within 1 s.

(4) Set the pull-up resistance

Set the pull-up resistance on or off. Pull-up resistance is used when connecting to an open collector output signal. For normal measurements, disable the pull-up resistance (set to OFF).

1. Move the flashing cursor to the position shown in the figure on the left.
2. Use the function keys to set.

Function display Meaning

- : Pull-up resistance is enabled (ON). (for connection to open collector output)
- : Pull-up resistance is disabled (OFF).

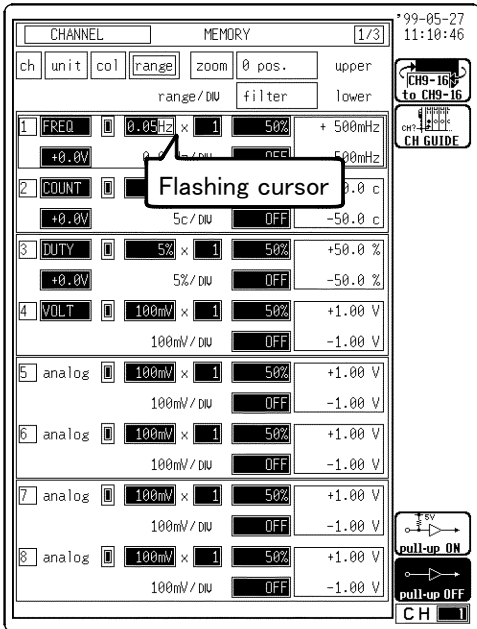

(5) Set the threshold level.

1. Move the flashing cursor to the position shown in the figure on the left.
2. Use the function keys, or the Jog/Shuttle control to set the threshold value.

Function display Meaning

- : Increases in number, large step
- : Increases in number, small step
- : Decreases in number, small step
- : Decreases in number, large step

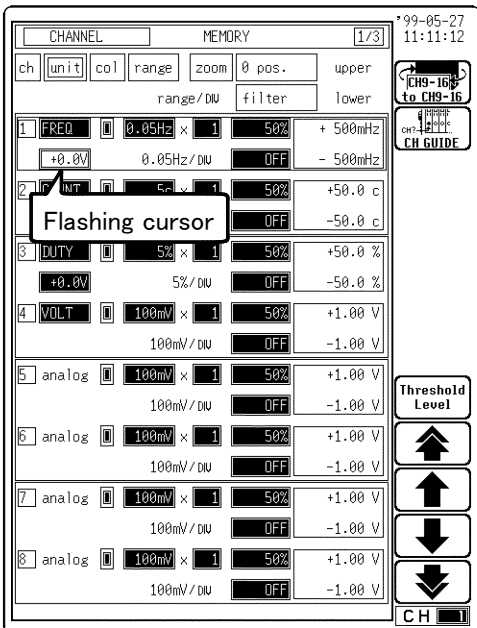

About Hold ON/OFF

(1) Difference by ON and OFF of hold in stopping condition.

For Frequency and RPM measurement, results are displayed after one confirmation cycle.

When measuring phenomena such as stopping of a rotating body, if Hold is ON, stopping cannot be detected because there is no confirmation cycle.

When Hold is OFF, half of the previous measurement value is displayed if the confirmation cycle does not occur within the specified time (10 ms or 1 s). Therefore, a condition such as stopping can be estimated by gradually approaching zero.

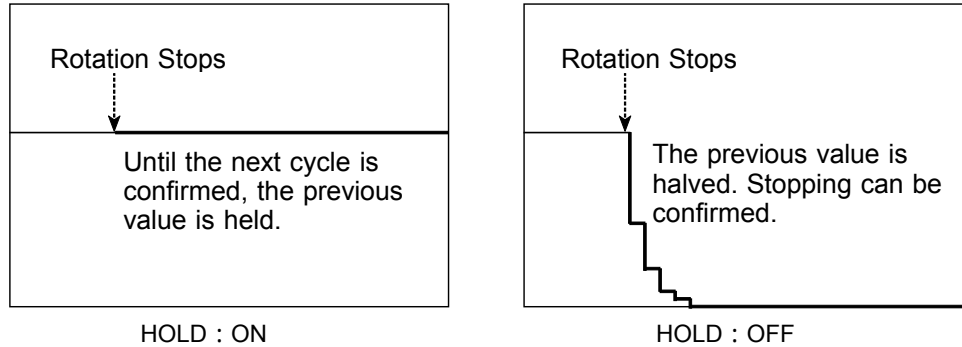

(2) The following are differences depending on whether Hold is ON or OFF when the frequency drops to 0 Hz from a certain frequency, then increases from that point.

Actual Event
Frequency drops to 0Hz from a certain frequency, then increases from that point

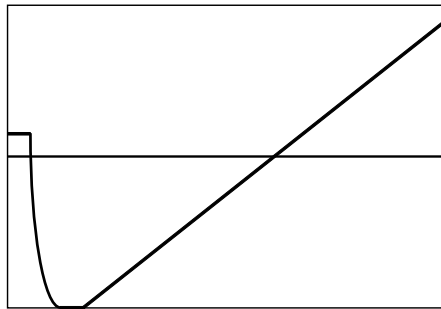

When Hold is ON
The initial value is held (the signal is not halved), so the result is as shown in the diagram below.

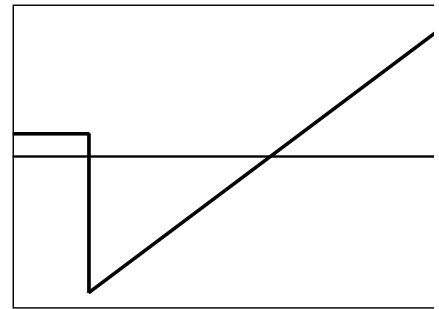

When Hold is OFF (10 ms)
At frequencies of less than 100 Hz, the signal is halved.

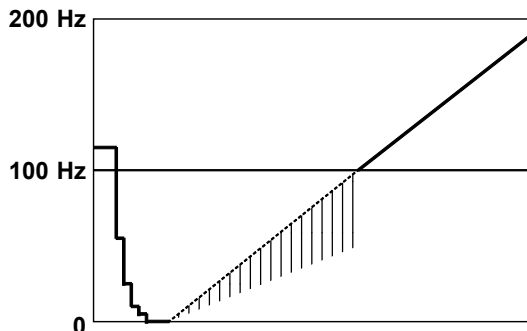

When Hold is OFF (1 s)
At frequencies of less than 1 Hz, the signal is halved.

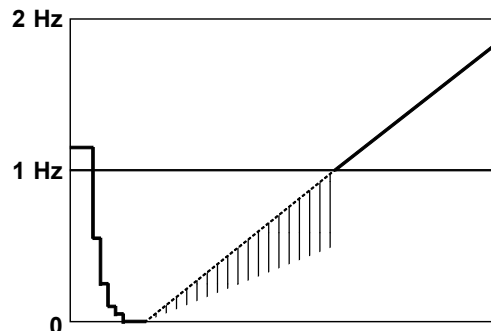

9.14.2 Setting the Count Mode

For count mode, the unit of measurement is 'c' (counts).

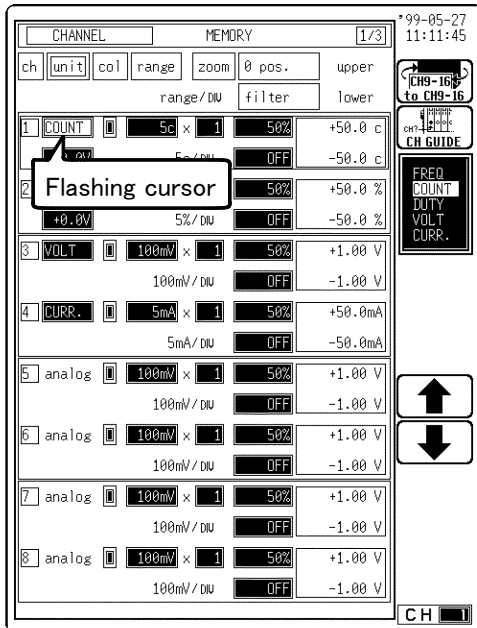

Procedure Screen: CHANNEL, Waveform display

(1) Set the measurement mode.

1. Display the CHANNEL or Waveform display screen.
2. Press the **CH.SET** key and move the flashing cursor to desired channel.
3. Move the flashing cursor to the **unit** item and select.
4. Use the function keys, the Jog/Shuttle control to set **COUNT**.

Function display Meaning



: Move the cursor up in the selection window.



: Move the cursor down in the selection window.

(2) Set the measurement range.

1. Move the flashing cursor to the position shown in the figure on the left.
2. Use the function keys, Jog/Shuttle control, or **RANGE** knob to set the measurement range. With the **RANGE** knob, settings can be made regardless of the position of the flashing cursor in the channel being set.

Function display Meaning



: Move the cursor up in the selection window.



: Move the cursor down in the selection window.

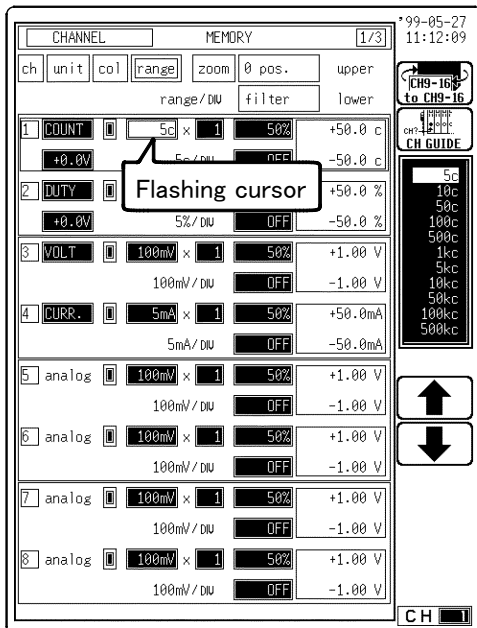

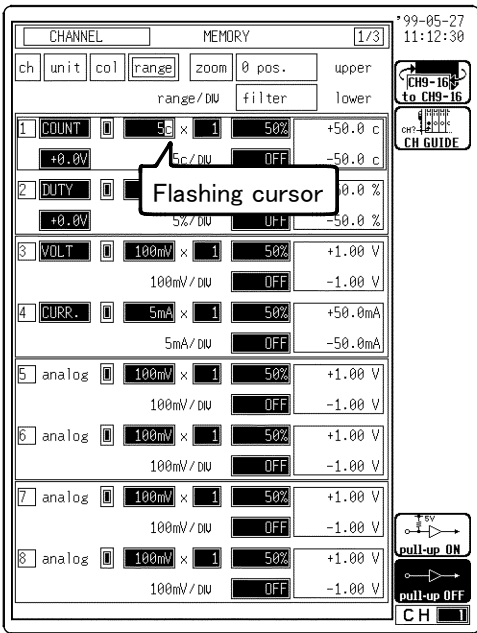

(3) Set the pull-up resistance

Set the pull-up resistance on or off. Pull-up resistance is used when connecting to an open collector output signal. For normal measurements, disable the pull-up resistance (set to OFF).

1. Move the flashing cursor to the position shown in the figure on the left.
2. Use the function keys to set.

Function display Meaning

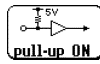

: Pull-up resistance is enabled (ON).
(for connection to open collector output)

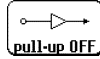

: Pull-up resistance is disabled (OFF).

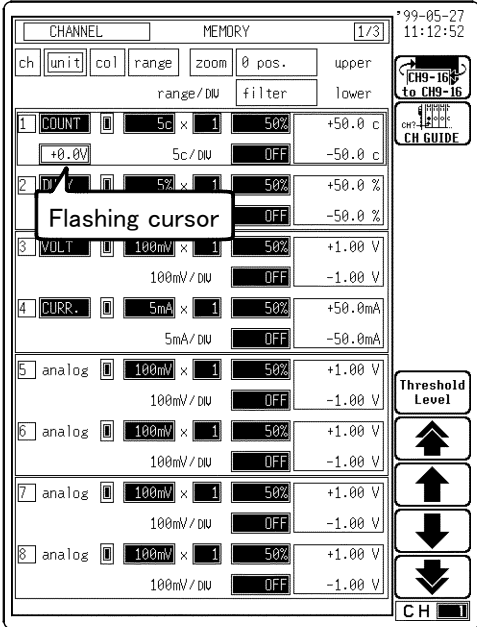

(4) Set the threshold level.

1. Move the flashing cursor to the position shown in the figure on the left.
2. Use the function keys, or the Jog/Shuttle control to set the threshold value.

Function display Meaning



: Increases in number, large step



: Increases in number, small step



: Decreases in number, small step



: Decreases in number, large step

9.14.3 Setting the Pulse Duty Ratio Mode

The pulse duty ratio measures the ratio of single High pulses.

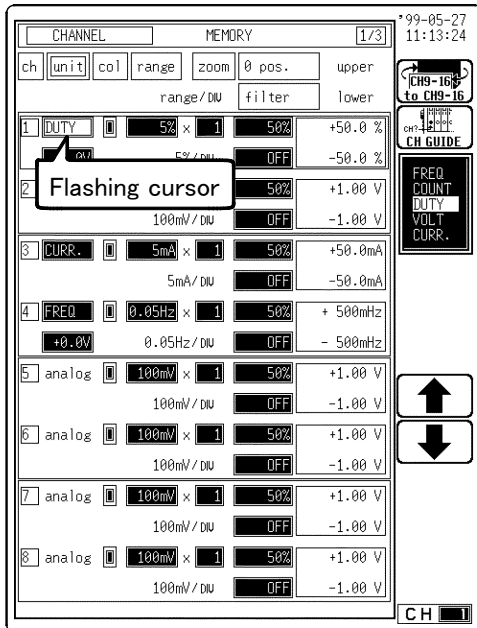

Procedure Screen: CHANNEL, Waveform display

(1) Set the measurement mode.

1. Display the CHANNEL or Waveform display screen.
2. Press the **CH.SET** key and move the flashing cursor to desired channel.
3. Move the flashing cursor to the **unit** item.
4. Use the function keys, the Jog/Shuttle control to select **DUTY**.

Function display Meaning



: Move the cursor up in the selection window.



: Move the cursor down in the selection window.

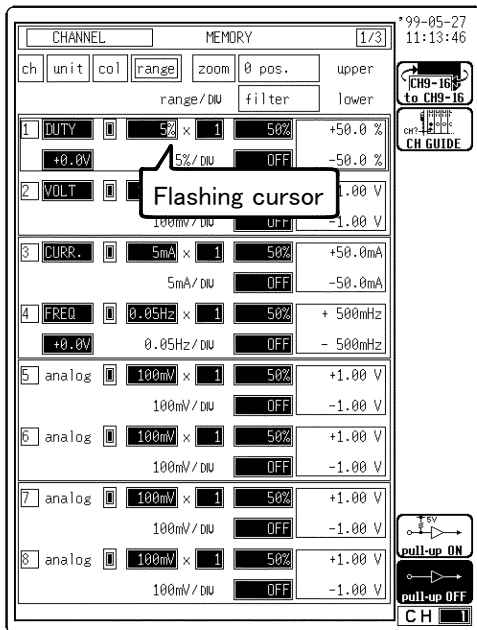

(2) Set the pull-up resistance

Set the pull-up resistance on or off. Pull-up resistance is used when connecting to an open collector output signal. For normal measurements, disable the pull-up resistance (set to OFF).

1. Move the flashing cursor to the position shown in the figure on the left.
2. Use the function keys to make a setting.

Function display Meaning

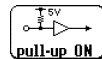

: Pull-up resistance is enabled (ON).
(for connection to open collector output)

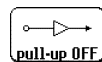

: Pull-up resistance is disabled (OFF).

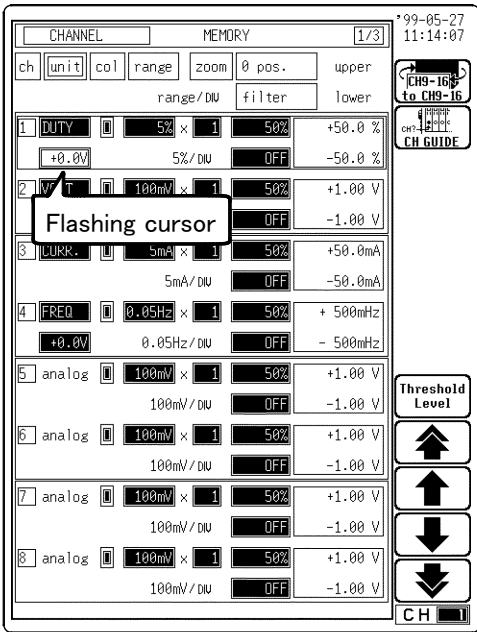

(3) Set the threshold level.

1. Move the flashing cursor to the position shown in the figure on the left.
2. Use the function keys, or the Jog/Shuttle control to set the threshold value.

Function display	Meaning
	: Increases in number, large step
	: Increases in number, small step
	: Decreases in number, small step
	: Decreases in number, large step

NOTE

Upon measurement of pulses that rise during dead time, the duty ratio is determined from pulses that follow the dead time; the duty ratio of dead time pulses is not measured.

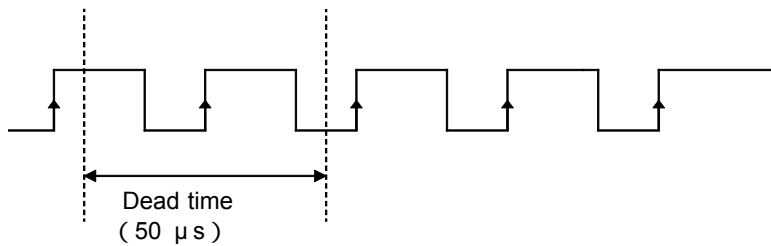

9.14.4 Setting the Voltage Mode

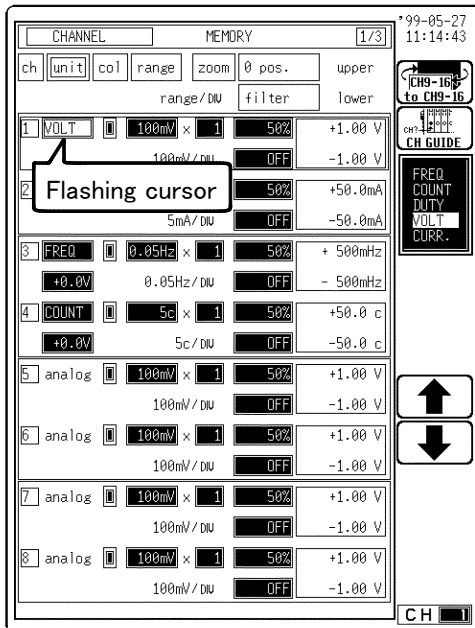

Procedure Screen: CHANNEL, Waveform display

(1) Set the measurement mode.

1. Display the CHANNEL or Waveform display screen.
2. Press the **CH.SET** key and move the flashing cursor to desired channel.
3. Move the flashing cursor to the **unit** item.
4. Use the function keys, the Jog/Shuttle control to select **VOLT** (voltage).

Function display	Meaning
------------------	---------



: Move the cursor up in the selection window.



: Move the cursor down in the selection window.

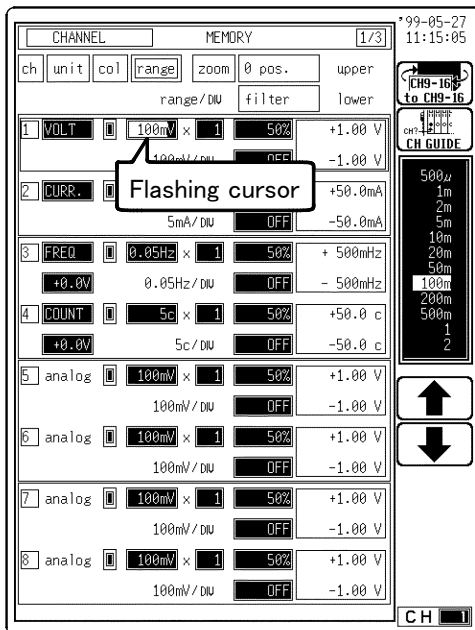

(2) Set the measurement range.

1. Move the flashing cursor to the position shown in the figure on the left.
2. Use the function keys, Jog/Shuttle control, or **RANGE** knob to set the measurement range. With the **RANGE** knob, settings can be made regardless of the position of the flashing cursor in the channel being set.

Function display	Meaning
------------------	---------



: Move the cursor up in the selection window.



: Move the cursor down in the selection window.

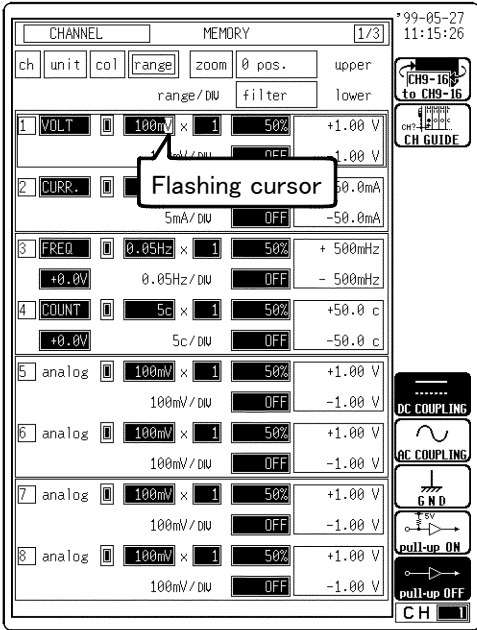



(3) Set the input coupling.

1. Move the flashing cursor to the position shown in the figure on the left.
2. Use the function keys or Jog/Shuttle control to select the input coupling.

Function display Meaning

 : DC coupling

 : AC coupling

 : The input signal is not connected.

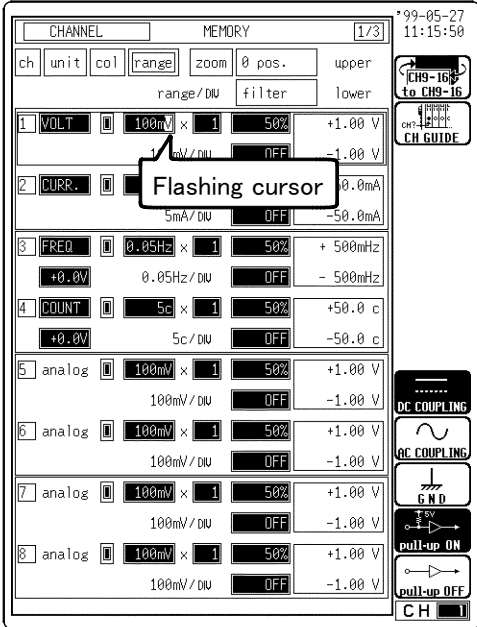



(4) Set the pull-up resistance.

Set the pull-up resistance on or off. Pull-up resistance is used when connecting to an open collector output signal. For normal measurements, disable the pull-up resistance (set to OFF).

1. Move the flashing cursor to the position shown in the figure on the left.
2. Use the function keys to make a setting.

Function display Meaning

 : Pull-up resistance is enabled (ON).
(for connection to open collector output)

 : Pull-up resistance is disabled (OFF).

9.14.5 Setting the Current Measurement

Current measurement is possible by connecting a clamp-on sensor/probe using the Model 9318 or 9319 CONVERSION CABLE. The following table shows which Cable to use with each sensor/probe model. Refer to Section 2.4.4 for connection methods.

9318: 9270, 9271, 9272, 9277, 9278, 9279

9319: 3273

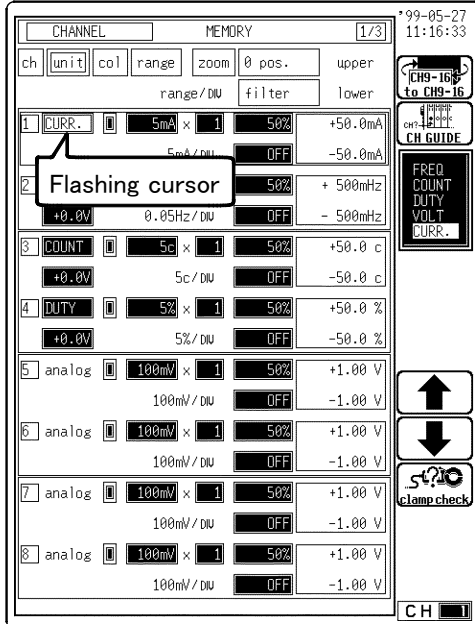

Procedure Screen: CHANNEL, Waveform display

(1) Set the measurement mode.

1. Display the CHANNEL or Waveform display screen.
2. Press the **CH.SET** key and move the flashing cursor to desired channel.
3. Move the flashing cursor to the **unit** item.
4. Use the function keys, the Jog/Shuttle control to select **CURR.** (current).

Function display	Meaning
------------------	---------



: Move the cursor up in the selection window.



: Move the cursor down in the selection window.

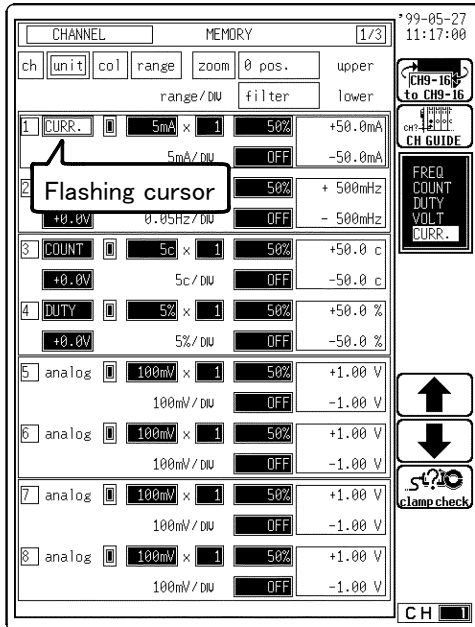

(2) Execute the clamp check.

The clamp check identifies the clamp sensor (probe) for use. It must be performed before current measurement. Up to 4 channels can be selected for current measurement at the same time on the 8841/42.

1. Move the flashing cursor to the position shown in the figure on the left.
2. Connect the clamp sensor and select **clamp check** by using the function keys.

Function display	Meaning
------------------	---------



: Clamp check is carried out.

NOTE

Up to four channels can be selected for current measurement at the same time on the 8841/42. However, the clamp check does not work correctly when more than four clamps are installed. Remove any extra clamps so that no more than four are installed before attempting the clamp check.

9.15 Setting the 8947 CHARGE UNIT

The 8947 CHARGE UNIT can measure either voltage or acceleration on each channel (one channel per measurement type). Refer to Section 9.3 "Setting the CHANNEL Screen" for the common settings.

Charge	Measures using charge-output type voltage acceleration pickup sensor
Preamp	Measures using internal-preamp type acceleration pickup sensor
Voltage	Measures voltage waveforms

Notes regarding measurement

Auto-ranging cannot be used on a channel set for Charge or Preamp measurement mode.

In the following cases, five to six seconds should be allowed for input to stabilize:

- (1) In the Charge measurement mode, after switching between the six high-sensitivity ranges and the six low-sensitivity ranges.
- (2) When starting a new measurement after selecting the Preamp measurement mode.

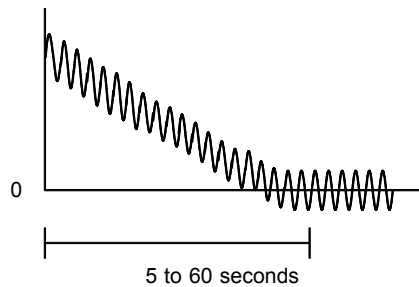

9.15.1 Acceleration Measurement (Charge/Preamp) Selection

⚠ WARNING

When the PREAMP measurement mode is selected, voltage (15 V at 2 mA) is applied internally to the BNC connector when measurement starts. To avoid electric shock and damage to measurement objects, select a measurement mode other than PREAMP or turn the unit off when connecting a sensor or probe to the BNC terminals.

When the Preamp measurement mode is selected, or when power is turned on with the Preamp mode previously selected, a message appears to confirm whether the first operation is initiated by pressing the **START** key. Press the (exec) function key on the display to proceed.

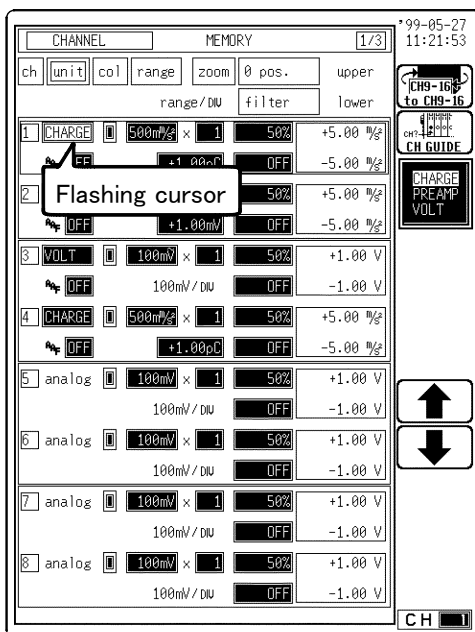

Procedure Screen: CHANNEL, Waveform display

(1) Set the measurement mode.

1. Display the CHANNEL or Waveform display screen.
2. Press the **CH.SET** key and move the flashing cursor to desired channel.
3. Move the flashing cursor to the **unit** item.
4. Use the function keys, the Jog/Shuttle control to select **CHARGE** or **PREAMP**.

Function display	Meaning
------------------	---------



: Move the cursor up in the selection window.



: Move the cursor down in the selection window.

(2) Set the sensor sensitivity

Sensor sensitivity is the value of the acceleration sensor. The measurement range varies according to sensor sensitivity. Set the sensor sensitivity before you set the measurement range. See Section 9.15.2

1. Move the flashing cursor to the position shown in the figure on the left.
2. Use the function keys or Jog/Shuttle control to set the measurement range.

Function display	Meaning
------------------	---------



: Increases in number, large step



: Increases in number, small step



: Decreases in number, small step



: Decreases in number, large step

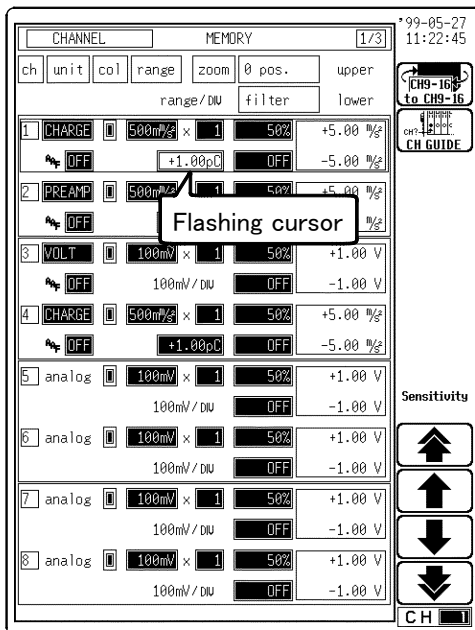

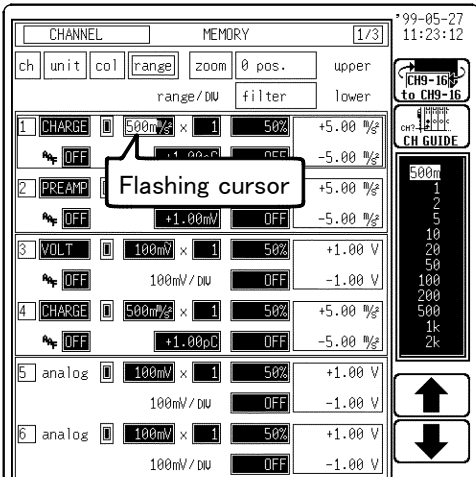

(3) Set the measurement range

The measurement range varies according to sensor sensitivity. Set the sensor sensitivity before you set the measurement range.

1. Move the flashing cursor to the position shown in the figure on the left.
2. Use the function keys to set the measurement range.

Function display Meaning

: Increases in number, large step

: Increases in number, small step

: Decreases in number, small step

: Decreases in number, large step

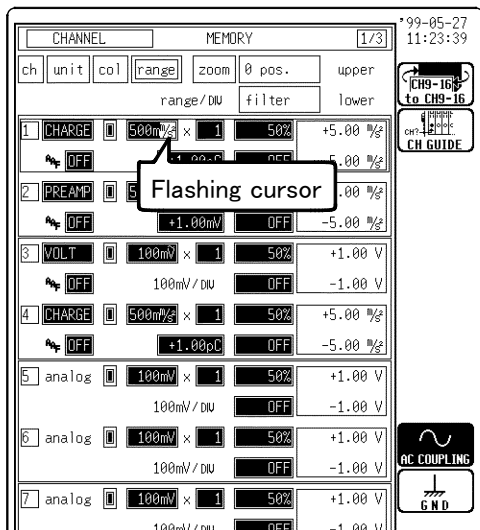

(4) Set the input coupling

DC coupling is not available in the Charge and Preamp modes.

1. Move the flashing cursor to the position shown in the figure on the left.
2. Use the function keys to set the input coupling.

Function display Meaning

: AC coupling

: The input signal is not connected. This allows the zero position to be checked.

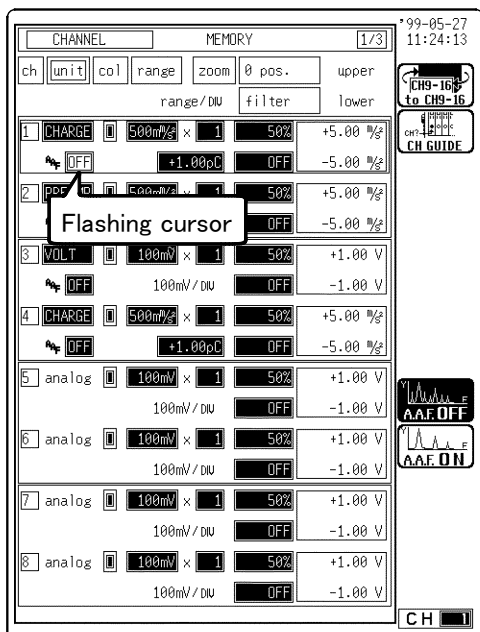

(5) Set the anti-aliasing filter

Enable the anti-aliasing filter to prevent aliasing distortion. The cut-off frequency changes automatically when setting the frequency and time axis ranges. The anti-aliasing filter can only be selected from the CHANNEL screen.

1. Move the flashing cursor to the position shown in the figure on the left.
2. Use the function keys to make a setting.

Function display Meaning

: Anti-aliasing filter is not used.

: Anti-aliasing filter is used.

NOTE

Refer to Section 8.3.3, "Setting the Frequency Range" for details about the relationship between the anti-aliasing filter cutoff frequency and the frequency range and time axis range.

9.15.2 Setting the Sensor Sensitivity

Sensor sensitivity is set in meters-per-second squared (m/s^2) units. However, some acceleration sensors use G (gravitational constant) units, in which case the read value should be divided by 9.8 (m/s^2).

Example 1 If specified sensor sensitivity is written as 1.08 ($pC/(m/s^2)$); sensor sensitivity level should be set to 1.08.

Example 2 If specified sensor sensitivity is written as 64.0 (pC/G);
 $64.0/9.8 = 6.53$ ($pC/(m/s^2)$)
 sensor sensitivity level should be set to 6.53.

About Units

This device normally measures in units of charge level per m/s^2 , but the units can be changed to charge level per G by the scaling function. Scaling can be set as follows:

Specify by conversion ratio	Specify by 2-point	
EU/V : $1/9.8 = 0.1020E+00$	9.8000E+00	1.0000E+00
Offset : 0.0000E+00	0.0000E+00	0.0000E+00
EU : G	EU : G	

Using a sensor outside of the setting range

The setting range of sensor sensitivity is 0.1 to 10 $pC/(m/s^2)$ or 0.1 to 10 $mv/(m/s^2)$, but a sensor operating outside of this range can be used by enabling scaling.

- (1) Display the CHANNEL1 screen, and set the sensor sensitivity. Multiply the actual sensor sensitivity to be used by the appropriate factor to produce a settable number (0.1 to 10), and enter that factor.
- (2) Display the SCALING screen, and turn on Charge or Preamp mode for the channel using the sensor that is outside of the setting range.
- (3) Set the same conversion ratio as the sensor sensitivity factor.

Example 1 Sensor sensitivity is 23.4 $pC/(m/s^2)$:
 Multiply sensor sensitivity by $1/2.34$ and set 10 $pC/(m/s^2)$ as the sensor sensitivity.
 Set the scaling.

Specify by conversion ratio	Specify by 2-point	
EU/V : $10/23.4 = 0.4274E+00$	2.3400E+01	1.0000E+01
Offset : 0.0000E+00	0.0000E+00	0.0000E+00
EU : m/s^2	EU : m/s^2	

Example 2 Sensor sensitivity is 0.05 $pC/(m/s^2)$:
 Multiply sensor sensitivity by 2 and set 0.1 $pC/(m/s^2)$ as the sensor sensitivity.
 Set the scaling.

Specify by conversion ratio	Specify by 2-point	
EU/V : $0.1/0.05 = 2.0000E+00$	0.0500E+00	0.1000E+00
Offset : 0.0000E+00	0.0000E+00	0.0000E+00
EU : m/s^2	EU : m/s^2	

9.15.3 Setting the Voltage Measurement

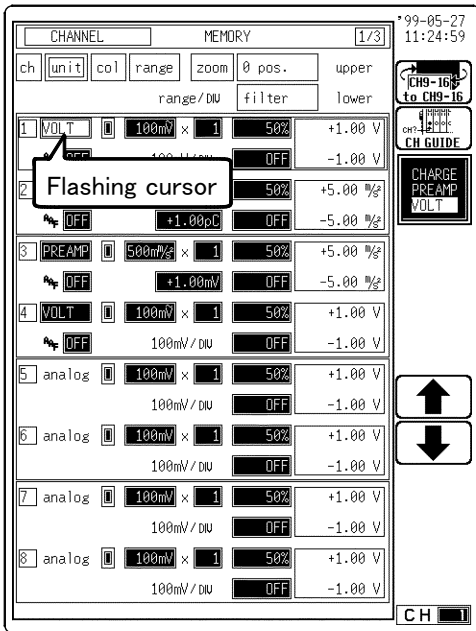

Procedure Screen: CHANNEL, Waveform display

- (1) Set the measurement mode.
 1. Display the CHANNEL or Waveform display screen.
 2. Press the **CH.SET** key and move the flashing cursor to desired channel.
 3. Move the flashing cursor to the **unit** item.
 4. Use the function keys, the Jog/Shuttle control to select **VOLT** (voltage).

Function display Meaning



: Move the cursor up in the selection window.



: Move the cursor down in the selection window.

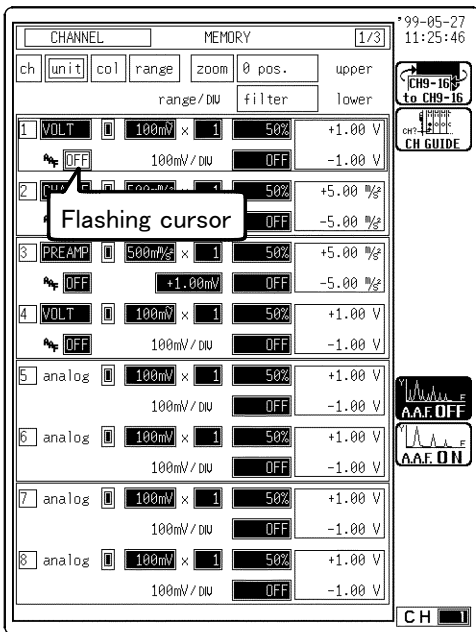

(2) Set the anti-aliasing filter

Enable the anti-aliasing filter to prevent aliasing distortion. The cut-off frequency changes automatically when setting the frequency and time axis ranges. The anti-aliasing filter can only be selected from the CHANNEL screen.

1. Move the flashing cursor to the position shown in the figure on the left.
2. Use the function keys to set.

Function display Meaning



: Anti-aliasing filter is not used.



: Anti-aliasing filter is used.

NOTE

- We recommend using an input unit equipped with an anti-aliasing filter that can be enabled to minimize sampling distortions during FFT analysis.
- Refer to Appendix 3.10, "FFT Function" for more information about aliasing distortion and anti-aliasing filters.
- If the anti-aliasing filter is on, "A" is printed at the end of the filter settings page during list printing. Refer to Section 13.5, "Example of Printer Output".
- Refer to Section 8.3.3, "Setting the Frequency Range" for details about the relationship between the anti-aliasing filter cutoff frequency and the frequency range and time axis range.

Chapter 10

Trigger Functions

10.1 Overview of the Trigger Functions

- The term "trigger" refers to a signal which is used to control the timing for recording start or stop.
- The term "triggering has occurred" refers to the state when such a signal has activated recording start or stop.
- Trigger parameters for the various functions are set using the TRIGGER screen or the Waveform display screen.

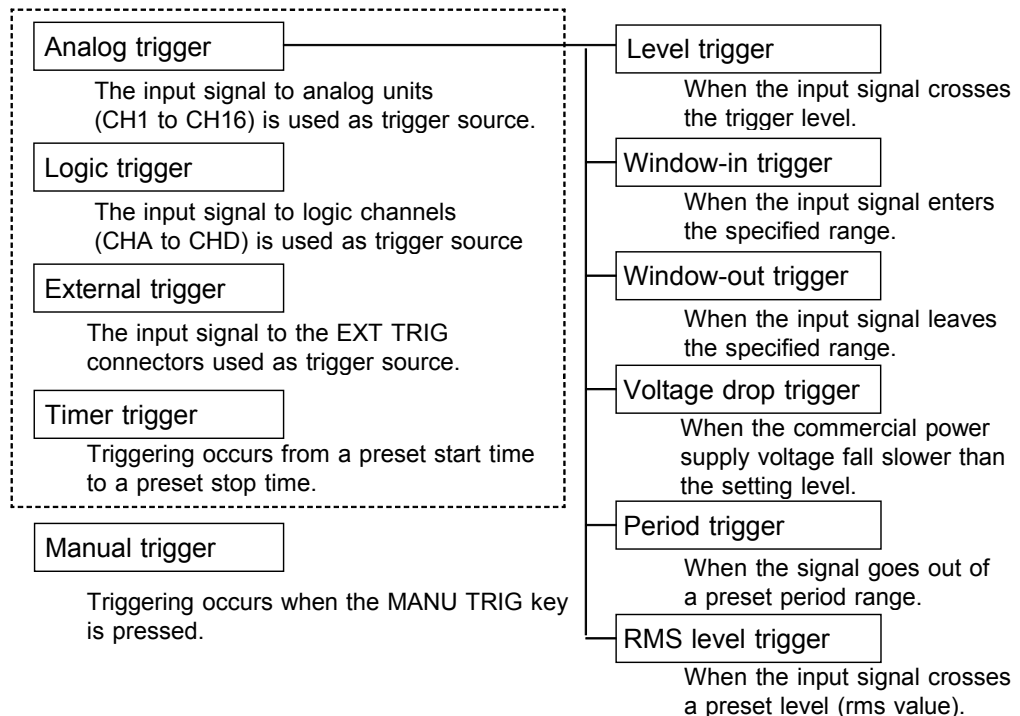

NOTE

- The manual trigger is always activated when the **MANU TRIG** key is pressed, regardless of other trigger source settings.
- If the trigger settings (trigger source parameters, pre-trigger) are changed during recording, the measurement is restarted, using the new settings.

10.2 Operation Sequence (Trigger mode setting)

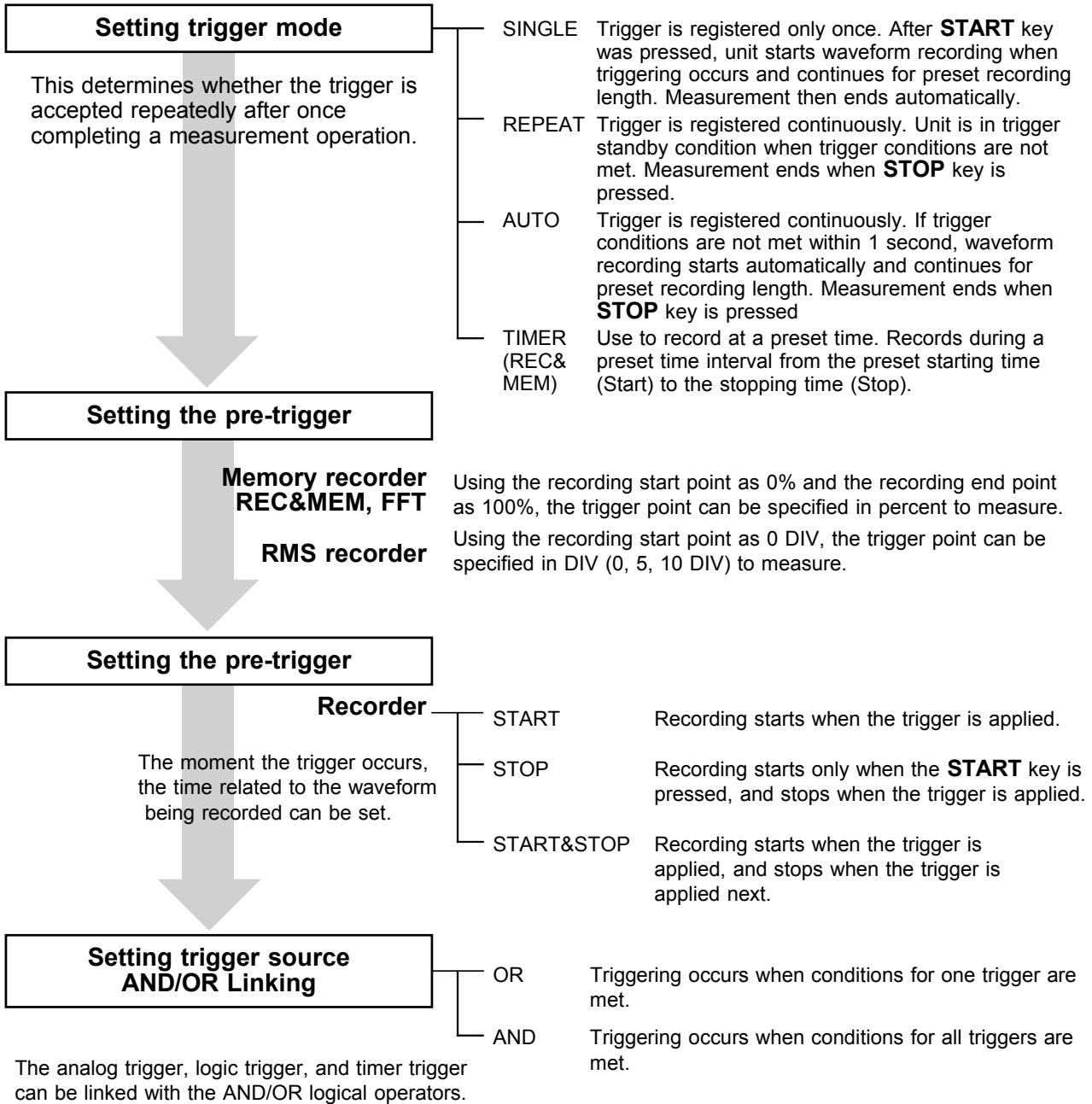

Selecting trigger type

- **Analog trigger** · The analog signal input channels can be used as trigger source.
- The type of trigger that can be used for the various functions is limited.

Level trigger (MEM, REC, REC&MEM, FFT)
 Triggering occurs when the input signal crosses the preset trigger level (voltage) with the preset trigger slope (↕, ↗).

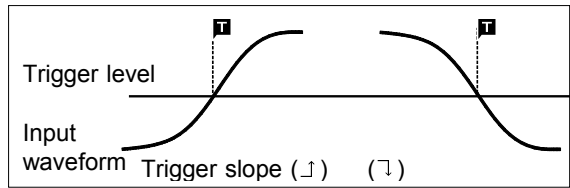

Window-in Trigger (MEM, REC, REC&MEM, FFT)
 Set upper limit level and lower limit level and activated when the input signal enters the range between these limits.

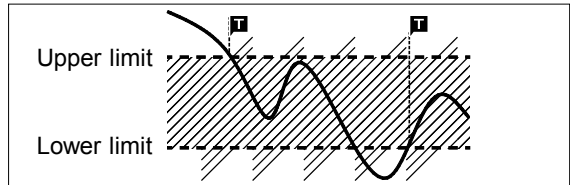

Window-out Trigger (MEM, REC, REC&MEM, FFT)
 Set upper limit level and lower limit level and activated when the input signal leaves this range.

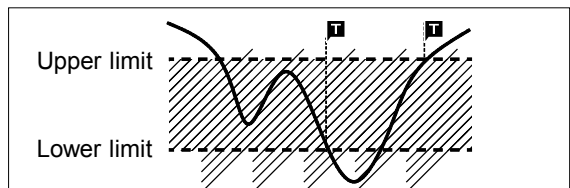

Voltage drop Trigger (MEM, REC, REC&MEM, FFT)
 This unit designed to measure commercial power supplies (50/60 Hz). This unit detects momentary voltage drops in commercial power supplies. When the peak of the voltage falls lower than the setting level, the trigger will occur.

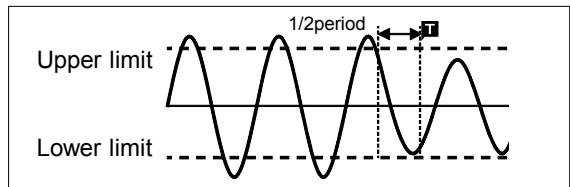

Period Trigger (MEM, REC, REC&MEM, FFT)
 This function sets both the period reference voltage and the period range, and measures the rise (fall) period of the set voltage. When the measured period deviates from the specified range, triggering occurs.

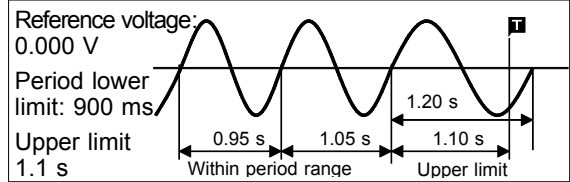

RMS level Trigger (rms value)
 The commercial power supplies, 50/60 Hz and the DC signals can be measured. This trigger occurs when the input signal crosses a predetermined trigger level (rms value) in a particular direction ("slope": ↕ or ↗).

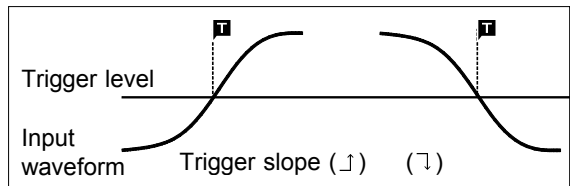

- **Logic trigger** The signal of a logic channel can be used as trigger source. A trigger pattern and logical operator (AND/OR) are specified, and triggering occurs when the trigger conditions are met.
- **External Trigger** An external signal can be used as trigger source. The external trigger is activated by either shorting the EXT TRIG terminal or applying a falling edge signal going below 2.5 V.
- **Timer Trigger** This function serves to activate recording at preset times. Triggering can be performed at constant intervals within a preset start time and end time.
- **Manual Trigger** The manual trigger is always activated when the **MANU TRIG** key is pressed, regardless of trigger source AND/OR linking setting.

Start measurement

- Press the **START** key and the LED lights. When the trigger conditions are met, measurement start.
- Pressing the **STOP** key stops measurement.

10.3 TRIGGER Screen Organization

Indicates the TRIGGER screen organization. Press the **TRIG** key to display the TRIGGER screen.

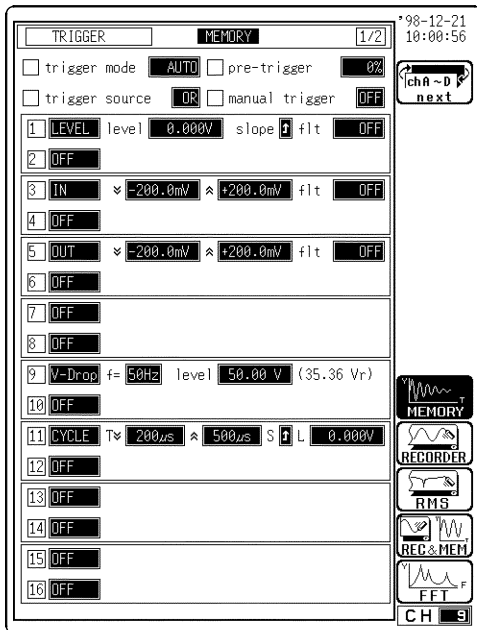

Setting items:

- Trigger mode
- Pre-trigger (for recorder function, trigger timing)
- Trigger source
- Manual trigger
- Analog trigger (channels 1 to 16)

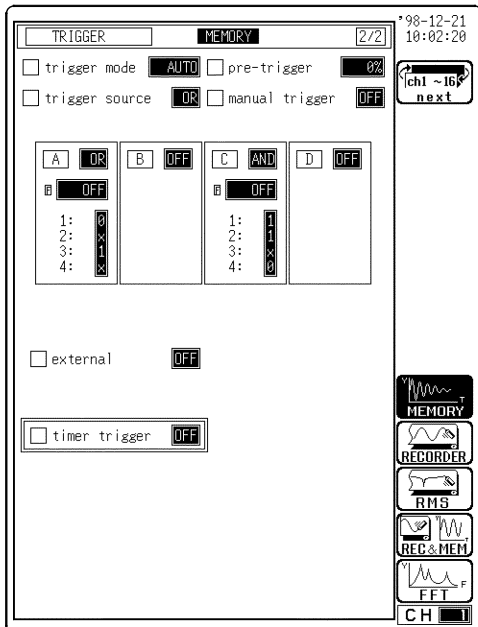
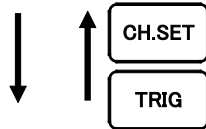

Setting items

- Trigger mode
- Pre-trigger
- Trigger source
- Manual trigger
- Logic channel (CHA to CHD)
- External trigger
- Timer trigger

10.4 Trigger Mode

The trigger mode determines the way triggering is used to control operation of the unit. When all trigger sources are OFF, a recording operation begins immediately (free-run operation).

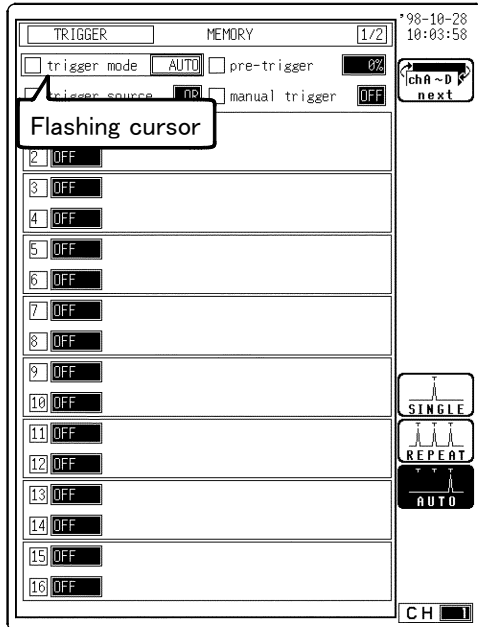

Procedure Screen: TRIGGER, Waveform display

1. Display the TRIGGER or Waveform display screen.
2. Move the flashing cursor to the **trigger mode** item.
3. Use the function keys to make the selection.

Function display

Meaning

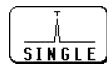

: Trigger is registered only once. After **START** key was pressed, unit starts waveform recording when triggering occurs and continues for preset recording length. Measurement then ends automatically.



: Trigger is registered continuously. Unit is in trigger standby condition when trigger conditions are not met. Measurement ends when STOP key is pressed.



: Trigger is registered continuously. If trigger conditions are not met within 1 second, waveform recording starts automatically and continues for preset recording length. Measurement ends when STOP key is pressed (memory recorder function only).



: Use to record at a preset time. Records during a preset time interval from the preset starting time (Start) to the stopping time (Stop).

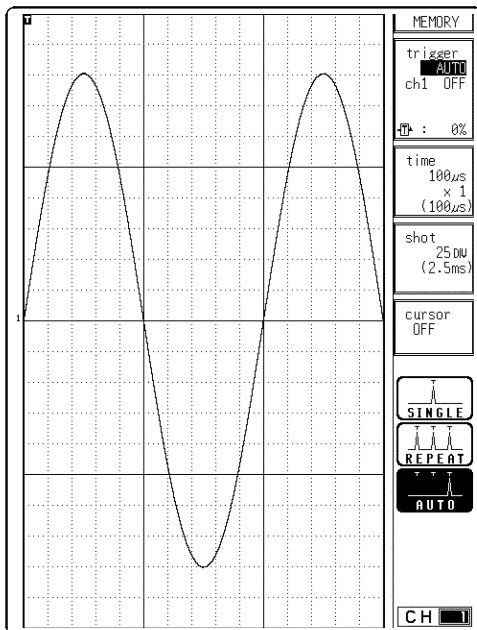

NOTE

- The trigger mode setting of the recorder and memory function (REC&MEM) is available on the recorder waveform screen (REC&mem).
- When the trigger mode is set to [Repeat], triggering is disabled during the end of recording processing (auto save, auto print, waveform display processing and calculation) before going to the next trigger standby status. Therefore, it is not triggered if the trigger condition occurs during this processing period.

10.5 Pre-trigger

The pre-trigger function serves to record the waveform not only after but also before triggering has occurred.

Memory Recorder, Recorder&Memory, and FFT Functions

In the memory recorder function, recorder&memory, and FFT Functions, using the recording start point as 0% and the recording end point as 100%, the trigger point can be specified in percent. When all trigger sources are set to OFF, the pre-trigger setting is invalid.

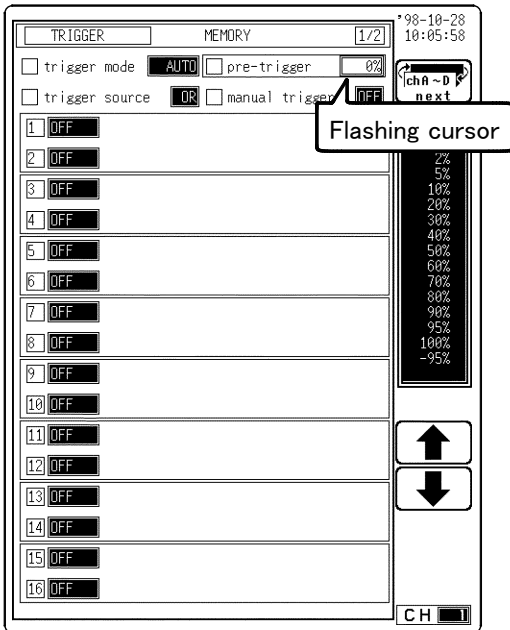

Procedure Screen: TRIGGER, Waveform display

1. Display the TRIGGER or Waveform display screen.
2. Move the flashing cursor to the **pre-trigger** item, as shown in the figure on the left.
3. Use the Jog/Shuttle control or the function keys to make a setting.

Function display Meaning



: Move the cursor up in the selection window.



: Move the cursor down in the selection window.

- The selection window is not displayed on the Waveform display screen.
- The pre-trigger cannot be set to "-95%" at a recording length of 160,000 DIV. In addition, if the recording length is set to 160,000 DIV after the pre-trigger is set to "-95%," the pre-trigger is automatically reset to "0%."



recording range (recording length)

[95%] : 95% of the recording in the recording length is before the trigger

[50%] : 50% before and 50% after the trigger

[-95%] : Recording is about one recording length after the trigger

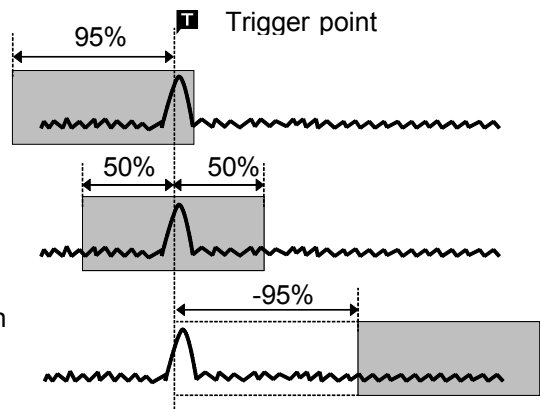

NOTE

- When the pre-trigger is set, the trigger will not be registered for a certain period after the start of measurement. (During this interval, "Pre-trigger standby" is shown on the display.)
- When the trigger can be registered, the indication "Waiting for trigger" is shown on the display.
- If the time axis range is set to "EXT." in memory recorder or FFT function, the pre-trigger can not be set.
- A stored Recorder & Memory waveform can be triggered simultaneously with the start of the Recorder waveform, in which case the preset trigger level for recording is ignored.

RMS Recorder Function

In the RMS recorder function, using the recording start point as 0 DIV, the trigger point can be specified in DIV (0, 5, 10 DIV).

When all trigger sources are set to OFF, the pre-trigger setting is invalid.

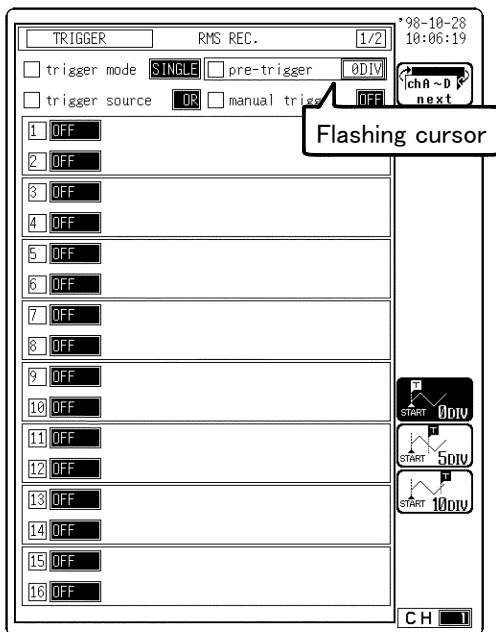

Procedure Screen: TRIGGER, Waveform display

1. Display the TRIGGER or Waveform display screen.
2. Move the flashing cursor to the **pre-trigger** item, as shown in the figure on the left.
3. Use the function keys to make a setting.

Function display Meaning



: Record from the trigger.



: Record from 5 DIV before the trigger.



: Record from 10 DIV before the trigger.

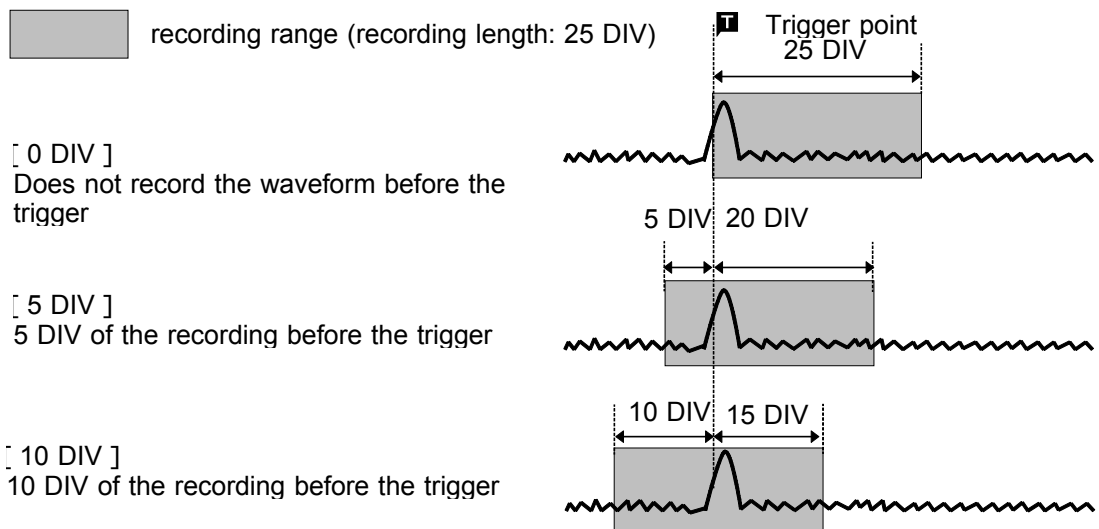

NOTE

- In the RMS recorder function, a trigger can be accepted immediately from the start time. In some cases, therefore, the pre-trigger portion of a recording may not be available.
- In the RMS recorder function, pre-trigger cannot be carried out, because the additional recording sets ON.

10.6 Trigger Timing (REC only)

- The moment the trigger occurs, the time related to the waveform being recorded can be set.
- Not only the waveform after the trigger but also the waveform before the trigger can be recorded.

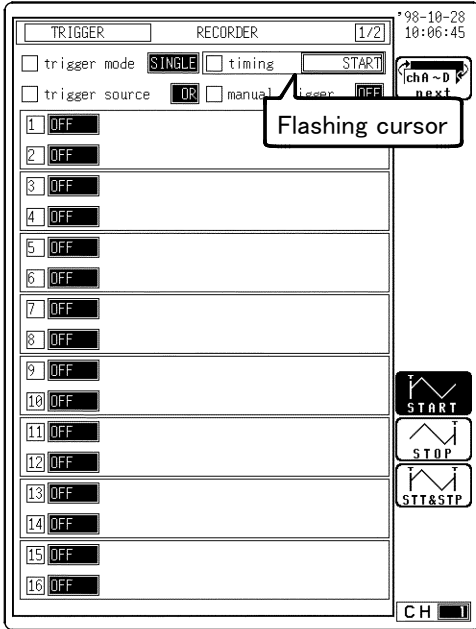

Procedure Screen: TRIGGER

1. Press the **TRIG** key to display the TRIGGER screen.
2. Move the flashing cursor to the **timing** item.
3. Use the function keys to make a setting.

Function display

Meaning



: Recording starts when the trigger is applied.



: Recording starts only when the START key is pressed, and stops when the trigger is applied.



: Recording starts when the trigger is applied, and stops when the trigger is applied next.

NOTE

When the trigger timing is set to **Stop** or **Start & Stop**, measured waveform data equivalent to the recording length is saved if the stop triggering is not generated between the initiation of measurement and the end of the set recording length.

Trigger mode:

SINGLE: Stop measurement.

REPEAT (STOP): Start measurement again.

REPEAT (START&STOP): Wait for trigger.

Example: Trigger setting; level trigger, 0.000 V (┘)

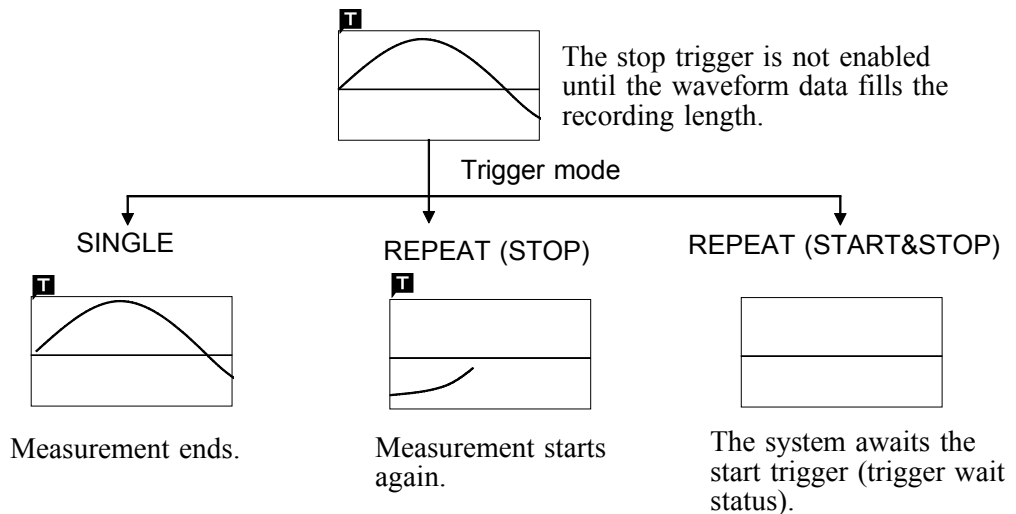

10.7 Trigger Source AND/OR Linking

The analog trigger, logic trigger, external trigger, and timer trigger can be linked with the AND/OR logical operators.

OR: Triggering occurs when conditions for one trigger are met.

AND: Triggering occurs when conditions for all triggers are met.

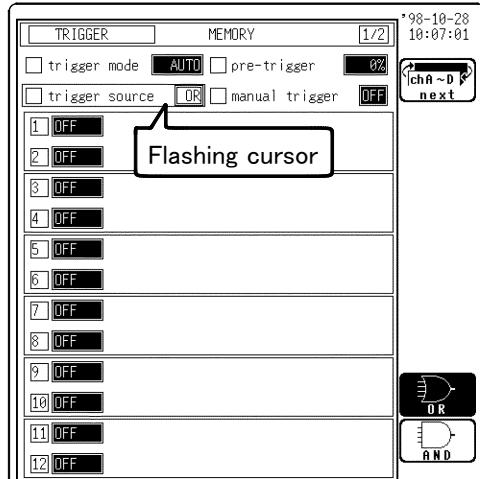

Procedure Screen: TRIGGER

1. Press the **TRIG** key to display the TRIGGER screen.
2. Move the flashing cursor to the **trigger source** item.
3. Use the function keys to make a setting.

Function
display

Meaning



: Link trigger sources with logical operator OR



: Link trigger sources with logical operator AND.

NOTE

If the trigger source is set to AND, and the trigger source setting conditions have already been met when the **START** key is pressed, triggering does not occur. When the conditions are not met once but met subsequently, triggering occurs.

Example

The figures below show the difference between the effect of AND/OR linking.

Channel	Trigger	Trigger level	Slope	Filter
CH1	Level	0.00 V	↑	OFF
CH2	Level	0.00 V	↑	OFF

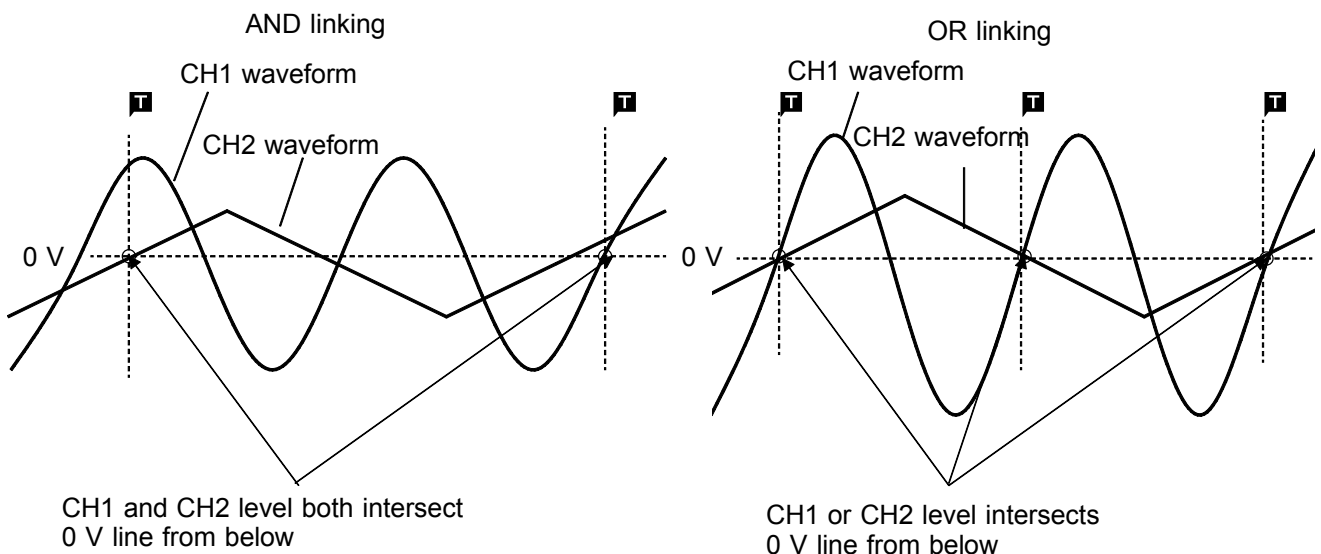

10.8 Analog Trigger

The analog signal input channels can be used as trigger source. The type of trigger that can be used for the various functions is limited.

Available trigger types for each function

Function \ Trigger	Memory recorder	Recorder	RMS recorder	Recorder & Memory	FFT
Level			-		
Window			-		
Voltage drop		-	-		
Period			-		
RMS level	-	-		-	-

10.8.1 Level Trigger

- Triggering occurs when the input signal crosses the preset trigger level (voltage) with the preset trigger slope (↑, ↓).
- When a trigger filter is used, triggering occurs only within the filter width. This is useful to exclude noise.

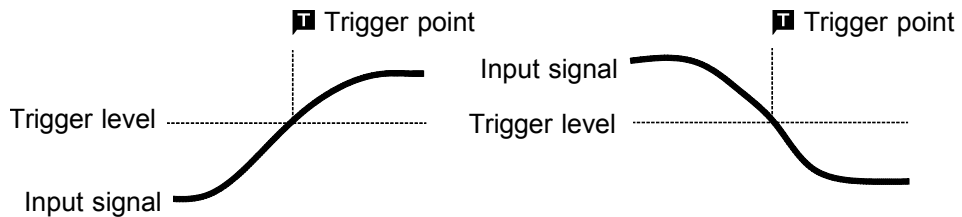

Upward trigger direction (slope : ↑) Downward trigger direction (slope : ↓)

Trigger Filter

- Triggering occurs when the trigger conditions are met within the filter width. This is useful to prevent spurious triggering by noise.
- The filter width is specified by the number of divisions of the memory recorder function, recorder&memory recorder function, or FFT function, while it is fixed to 10 ms, which is enabled and disabled using the **ON/OFF** keys, for the recorder function.

Rising trigger slope : ↑

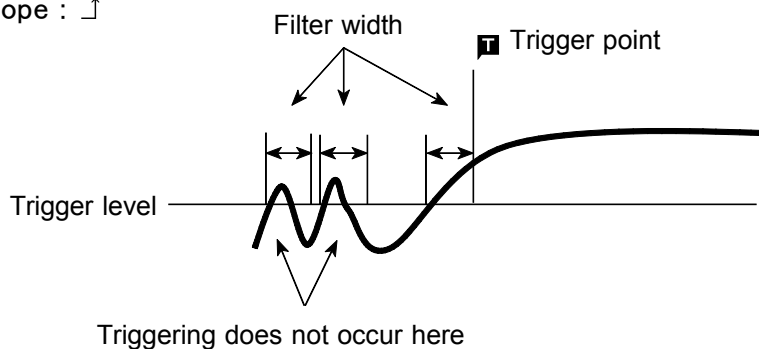

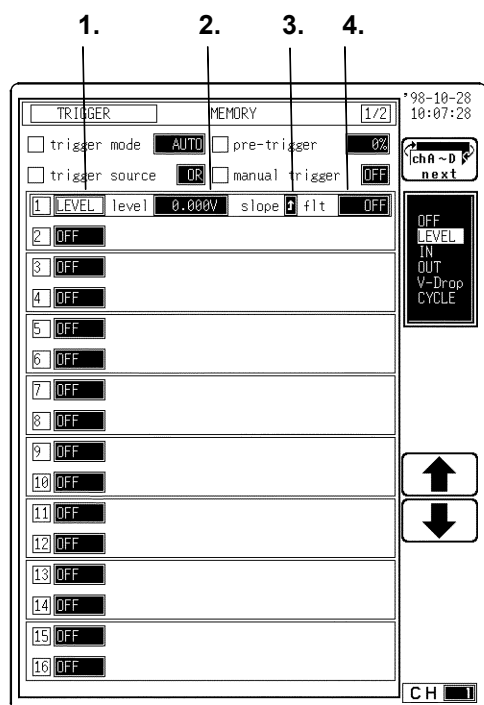

Procedure Screen: TRIGGER, Waveform display

(1) Select the level trigger

1. Display the TRIGGER or Waveform display screen.
2. Move the flashing cursor to position **1**. shown in the figure.
3. Use the function keys to select **LEVEL**.

(2) Set the trigger level

1. Move the flashing cursor to position **2**. shown in the figure.
2. Use the Jog/Shuttle control or the function keys to make the selection.

Function
display

Meaning



: Increases in number, large step



: Increases in number, small step



: Decreases in number, small step



: Decreases in number, large step

(3) Select the trigger direction (slope).

1. Move the flashing cursor to position **3**. shown in the figure.
2. Use the function keys to make the selection.

Function
display

Meaning

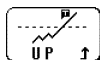

: Enables triggering on the rising edge.

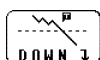

: Enables triggering on the falling edge.

(4) Set the trigger filter

1. Move the flashing cursor to position **4**. shown in the figure.
2. Use the Jog/Shuttle control or the function keys to make the selection.

In Memory Recorder, Recorder&Memory (memory waveform), FFT Functions

OFF Trigger filter is disabled

0.1 to 10 Trigger filter is enabled. Filter width is specified using divisions

In the Recorder Function

Function
display

Meaning



: Trigger filter is disabled.

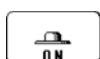

: Trigger filter is enabled.
Filter width is 10 ms.

Settings on the Waveform display screen

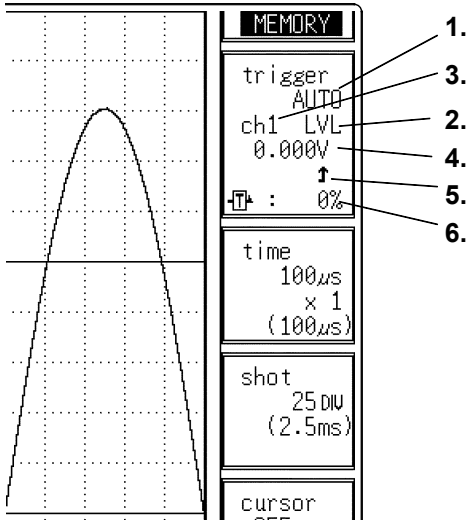

Setting items	Operation	
	Function	Jog/Shuttle
1. Trigger mode		-
2. Trigger type		-
3. Channel		-
4. Trigger level		-
5. Trigger slope		-
6. Pre-trigger		-

Restriction:

The trigger filter cannot be set.

The selected window is not displayed in the pre-trigger setting.

To set the numerical value by using the Jog/Shuttle control, press the **VALUE** key.

Example for Level Trigger

To cause triggering at point A or point B with the sine wave shown below, make the following settings.

1. Point A trigger level: 200 mV, trigger direction (slope): rising (↗)
2. Point B trigger level: -600 mV, trigger direction (slope): falling (↘)

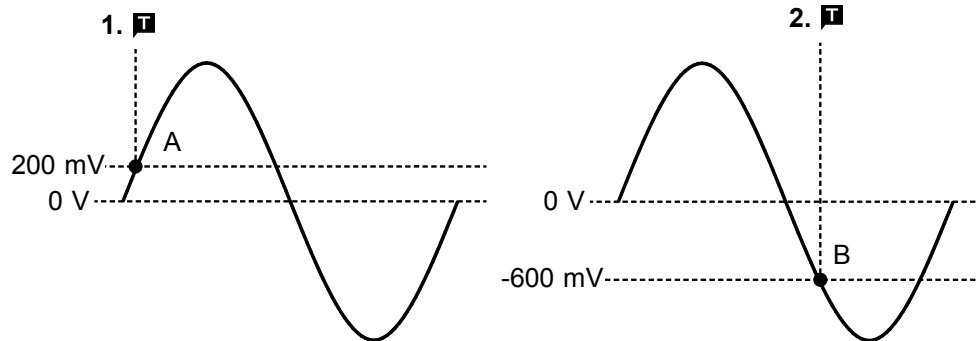

When the trigger source is set to "AND," triggering occurs when the voltage is above or below the trigger level. With this setting, triggering will not occur when the trigger slope crosses the set trigger level.

10.8.2 Window Trigger

Window-In Trigger

Set upper limit level and lower limit level and activated when the input signal enters the range between these limits.

Window-Out Trigger

Set upper limit level and lower limit level and activated when the input signal leaves this range.

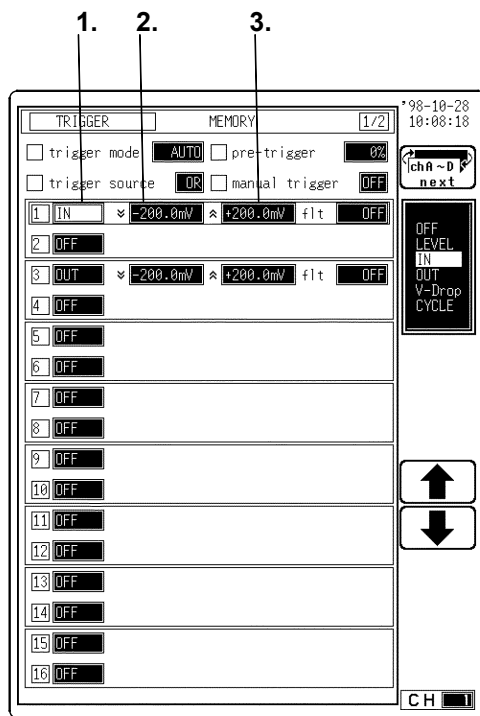
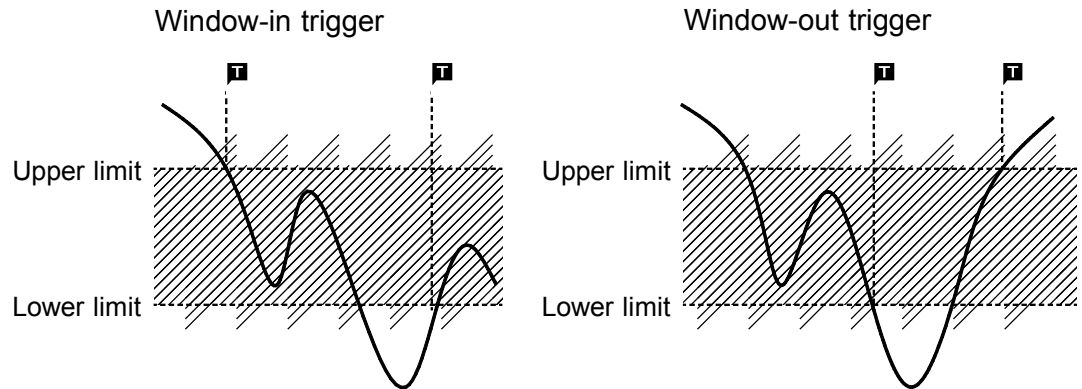

Procedure

Screen: TRIGGER, Waveform display

(1) Select the window-in or window-out trigger.

1. Display the TRIGGER or Waveform display screen.
2. Move the flashing cursor to position **1.** shown in the figure.
3. Use the function keys to make a selection.

(2) Set the lower and upper trigger levels.

1. Move the flashing cursor to position **2.** shown in the figure, and use the function keys or the Jog/Shuttle control to set the lower trigger level.
2. Move the flashing cursor to position **3.** shown in the figure, set the upper trigger level.

The upper limits must not be smaller than the lower limits, or the lower limits must not be larger than the upper limits.

Function display

Meaning



: Increases in number, large step



: Increases in number, small step



: Decreases in number, small step



: Decreases in number, large step

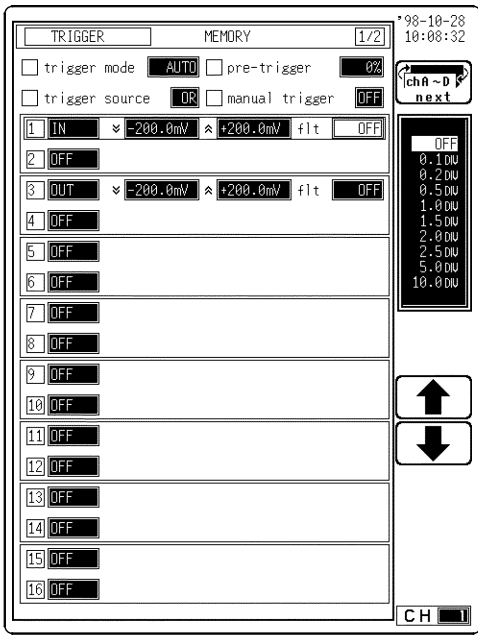

(3) Set the trigger filter

1. Move the flashing cursor to position shown in the figure on the left.
2. Use the Jog/Shuttle control or the function keys to make the selection.

In the Memory recorder, Recorder& Memory, FFT Functions

OFF Trigger filter is disabled
 0.1 to 10 Trigger filter is enabled. Filter width is specified using divisions.

In the Recorder Function

Function display	Meaning
	: Trigger filter is disabled.
	: Trigger filter is enabled. Filter width is 10 ms.

Settings on the Waveform display screen

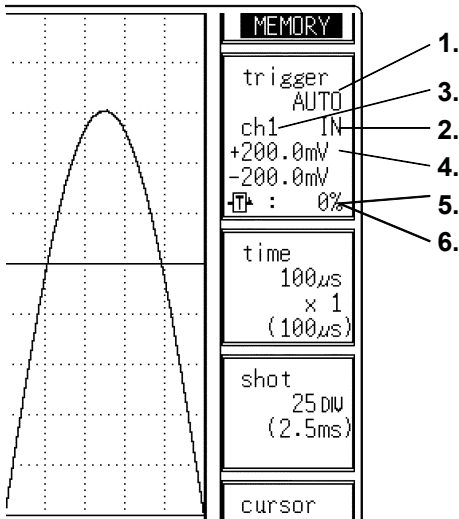

Setting items	Operation	
	Function	Jog/Shuttle
1. Trigger mode		-
2. Trigger type		-
3. Channel		-
4. Upper limit		
5. Lower limit		
6. Pre-trigger		

Restriction: The trigger filter cannot be set.
 To set the numerical value by using the Jog/Shuttle control, press the **VALUE** key.
 The selected window is not displayed in the pre-trigger setting.

Example for Window-out Trigger

In order to cause triggering when the signal as shown in the figure below leaves the hatched area, the following settings are made:

Window-out trigger Upper limit : 1 V, lower limit: -1 V

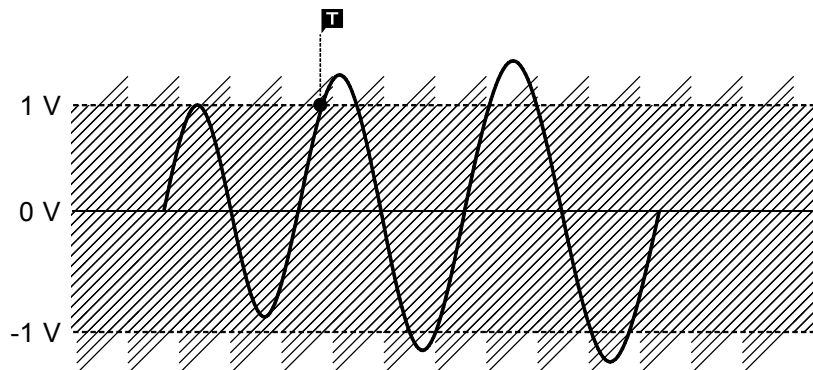

10.8.3 Voltage Drop Trigger

- The time axis ranges that can be used are 100 μ s to 50 ms/DIV. In FFT function, 800 Hz to 400 kHz of the frequency axis range.
- The 8841/42 is designed to measure commercial power supplies (50/60 Hz), and detects momentary voltage drops in commercial power supplies.
- When the peak of the voltage falls lower than the setting level, the trigger will occur.

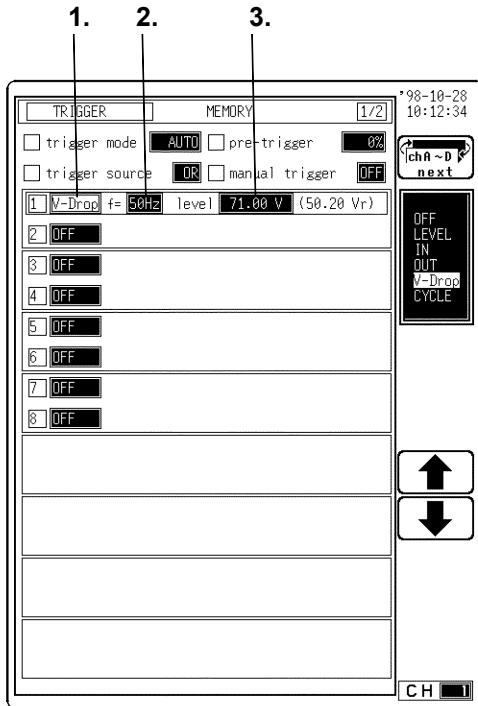

Procedure Screen: TRIGGER, Waveform display

(1) Select the voltage drop trigger.

1. Display the TRIGGER or Waveform display screen.
2. Move the flashing cursor to position **1.** shown in the figure.
3. Use the function keys to select **V-Drop**.

(2) Select the frequency of the measuring object

1. Move the flashing cursor to position **2.** shown in the figure.
2. Use the function keys to select the frequency.

Function
display

Meaning

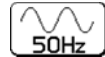

: This measurement is made using a 50-Hz commercial power supply.

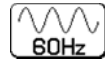

: This measurement is made using a 60-Hz commercial power supply.

(3) Set the trigger level

1. Move the flashing cursor to position **3.** shown in the figure.
2. Use the function keys or the Jog/Shuttle control to set the trigger level. The rms value as well as the trigger level are displayed.

Function
display

Meaning



: Increases in number, large step



: Increases in number, small step



: Decreases in number, small step



: Decreases in number, large step

Settings on the Waveform display screen

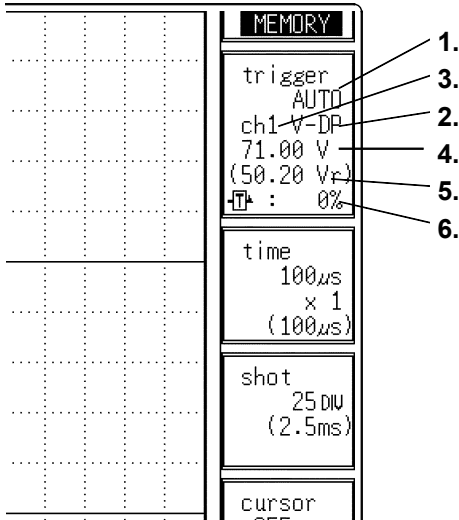

Setting items	Operation	
	Function	Jog/Shuttle
1. Trigger mode	-	-
2. Trigger type	-	-
3. Channel	-	-
4. Trigger level	-	-
5. RMS value	-	-
6. Pre-trigger	-	-

Restriction:

The frequency cannot be selected.

To set numerical value by using the Jog and Shuttle controls, press the **VALUE** key.

The selected window is not displayed in the pre-trigger setting.

Example for Voltage Drop Trigger

For a signal such as shown in the illustration (frequency 50 Hz), the following applies:

$$V \text{ max.} < 1.000 \text{ V} \quad (\text{RMS} < 707.1 \text{ mV rms})$$

To perform trigger measurement under the above conditions, make the following setting.

$$\text{Voltage drop } f = 50 \text{ Hz} \quad \text{Level} = 1.000 \text{ V (707.1 mV rms)}$$

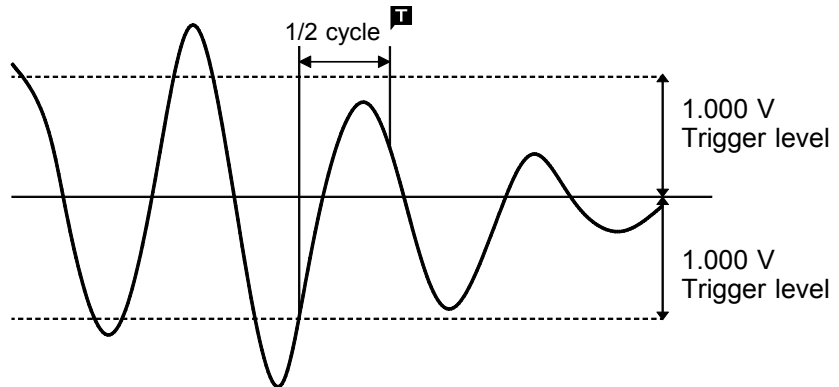

NOTE

If the conditions are met already when measurement is started, triggering does not occur. Triggering only occurs if the conditions are removed and then met again.

10.8.4 Period Trigger

This function sets both the period reference voltage and the period range, and measures the rise (fall) period of the reference voltage. When the measured period deviates from the specified range, triggering occurs.

Procedure Screen: TRIGGER, Waveform display

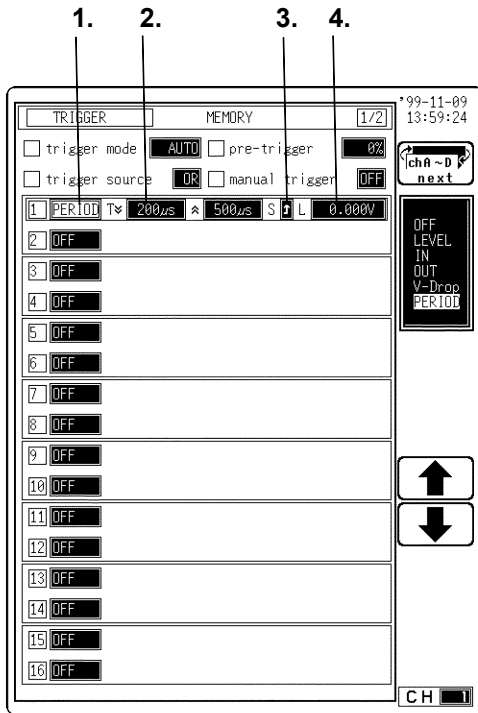

(1) Select the period trigger.

1. Display the TRIGGER or Waveform display screen.
2. Move the flashing cursor to position **1.** shown in the figure.
3. Use the function keys to select **PERIOD.**

(2) Set the period range

1. Move the flashing cursor to position **2.**
2. Use the Jog/Shuttle control or the function keys to make a setting.
The setting for the period range of the period trigger changes depending on the sampling period.
Lower limit: More than 10 times the sampling period.
Upper limit: Less than 20000 times the sampling period.
The upper trigger level must not be smaller than the lower trigger level, or the lower trigger level must not be larger than the upper trigger level.

Function display	Meaning
	: Increases in number, large step
	: Increases in number, small step
	: Decreases in number, small step
	: Decreases in number, large step

(3) Select the trigger direction (slope).

1. Move the flashing cursor to position **3.** shown in the figure.
2. Use the function keys to select the trigger direction (slope).

Function display	Meaning
	: Enables triggering on the rising period.
	: Enables triggering on the falling period.

(4) Set the reference voltage value

1. Move the flashing cursor to position **4.** shown in the figure.
2. Use the Jog/Shuttle control or the function keys to make the setting.

Function display	Meaning
	: Increases in number, large step
	: Increases in number, small step
	: Decreases in number, small step
	: Decreases in number, large step

Settings on the Waveform display screen

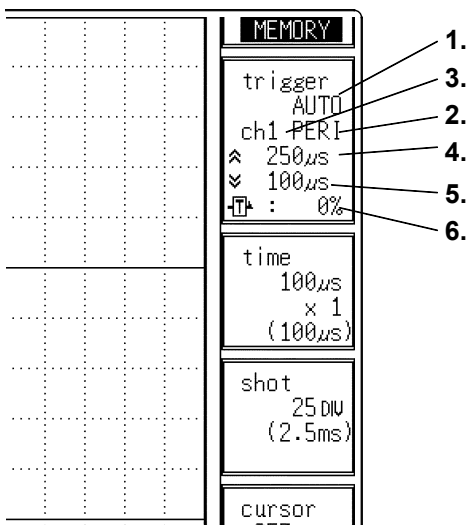

Setting items	Operation	
	Function	Jog/Shuttle
1. Trigger mode		-
2. Trigger type		-
3. Channel		
4. Upper limit		
5. Lower limit		
6. Pre-trigger		

Restriction:

The trigger slope and reference voltage value cannot be set.

To set numerical value by using the Jog and Shuttle controls, press **VALUE** key.

The selected window is not displayed in the pre-trigger setting.

NOTE

Since a trigger filter is not prepared for the period trigger, triggering may mistakenly occur due to noise (see the figure below).

To prevent such an event, use an appropriate low-pass filter.

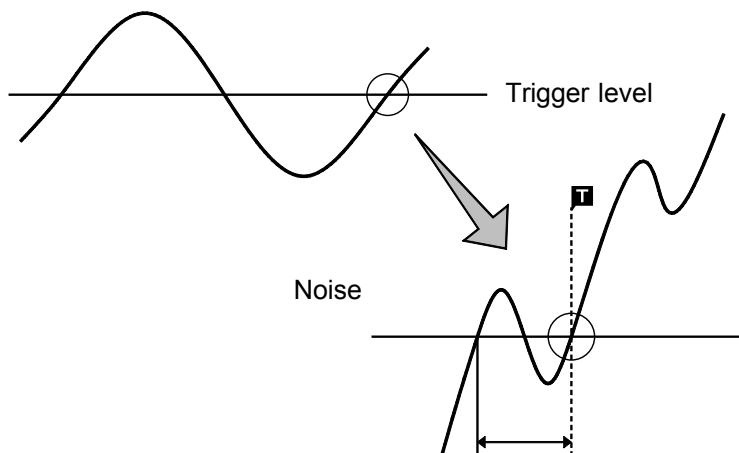

Triggering occurs, since the system judges that the period deviates from the specified range.

Triggering position of the period trigger

The system monitors the period of the signal that crosses the set reference voltage. When the monitored period deviates from the set range, triggering occurs. The trigger position is determined by the set period range and the measurement signal period.

Signal with a period to be measured that is smaller than the lower limit of the period trigger (trigger slope: \downarrow):

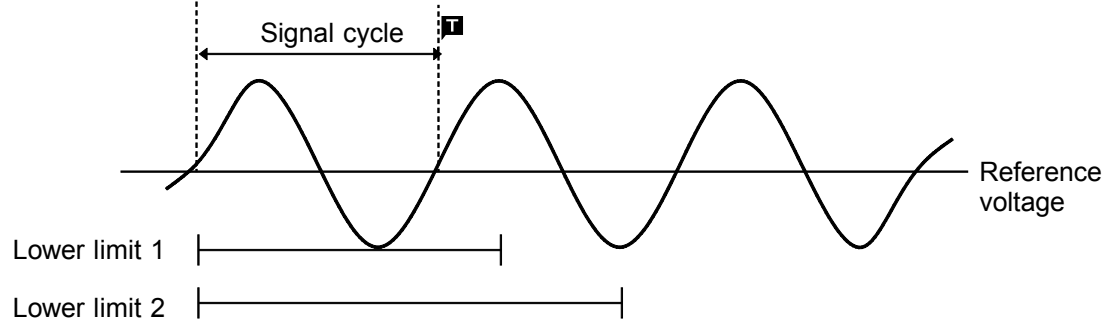

When the signal crosses the reference voltage at the set trigger slope before the lower limit of the set period range appears on the screen, the intersection is always defined as the triggering position.

Signal with a period to be measured that is larger than the upper limit of the period trigger (trigger slope: \downarrow):

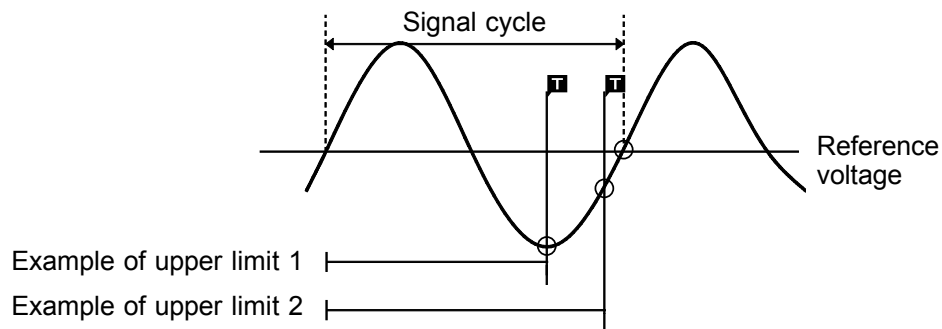

When the upper limit of the set period range appears on the screen before the signal crosses the reference voltage at the set trigger slope, the upper limit is defined as the triggering position. The triggering position is determined by the position of the upper limit in the period range, as shown in the figure above.

Example for Period Trigger

In order to cause triggering when the signal as shown in the figure below leaves the period range of 0.9 to 1.1 s, the following settings are made:
 Lower limit of the period: 900 ms, Upper limit of the period: 1.1 s,
 Reference voltage : 0.000 V

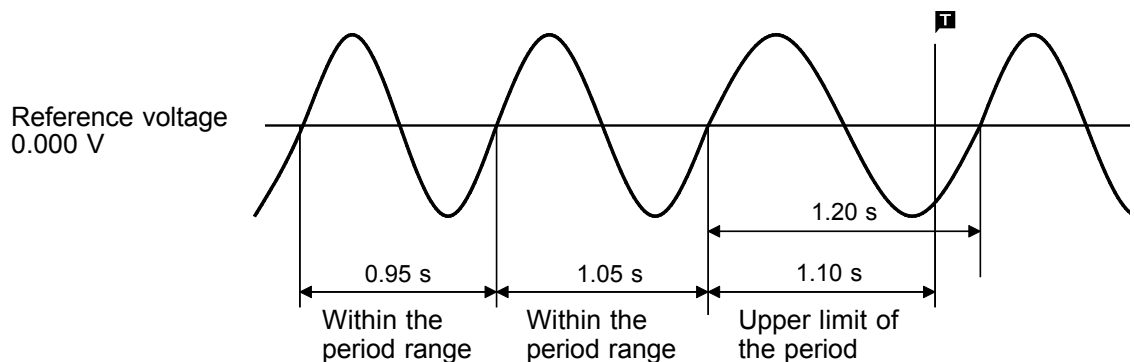

10.8.5 RMS Level Trigger

- The commercial power supplies, 50/60 Hz and the DC signals can be measured.
- This trigger occurs when the input signal crosses a predetermined trigger level (rms value) in a particular direction ("slope": \uparrow or \downarrow).

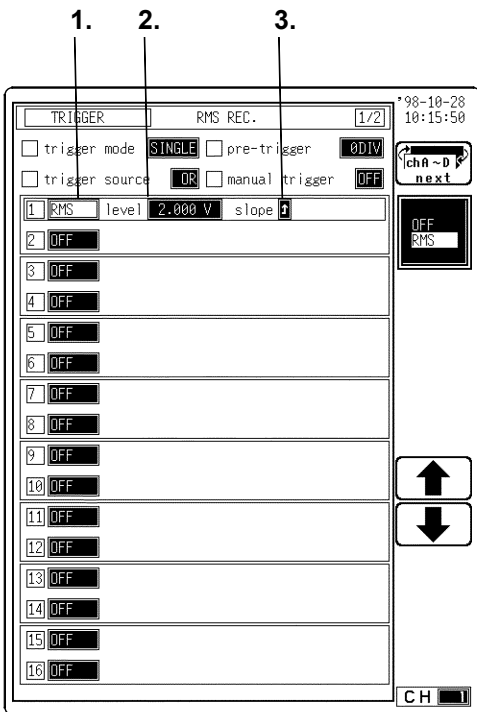
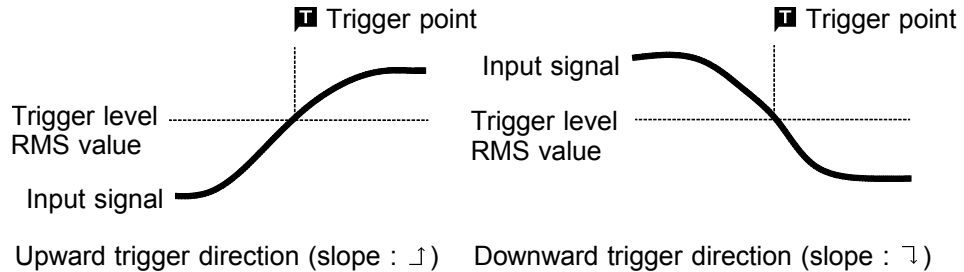

Procedure Screen: TRIGGER, Waveform display

(1) Select the RMS level trigger

1. Display the TRIGGER or Waveform display screen.
2. Move the flashing cursor to position **1.** shown in the figure.
3. Use the function keys to select **RMS LEVEL.**

(2) Set the trigger level

1. Move the flashing cursor to position **2.** shown in the figure.
2. Use the Jog/Shuttle control or the function keys to make the selection.

Function display	Meaning
	: Increases in number, large step
	: Increases in number, small step
	: Decreases in number, small step
	: Decreases in number, large step

(3) Select the trigger direction (slope).

1. Move the flashing cursor to position **3.** shown in the figure.
2. Use the function keys to select the trigger direction (slope).

Function display	Meaning
	: Enables triggering on the rising period.
	: Enables triggering on the falling period.

NOTE

- Set the frequency of the measuring object on the STATUS screen.
- 'AND' cannot be set between the trigger sources using the RMS level trigger and the logic trigger. When a shift is made from "OR" to "AND," the logic trigger setting is turned OFF.
- When the trigger source is set to "AND," triggering occurs simultaneously with startup when the trigger slope rises (\uparrow) and the input signal rises above the trigger level, or when the trigger slope falls (\downarrow) and the input signal sinks below the trigger level.

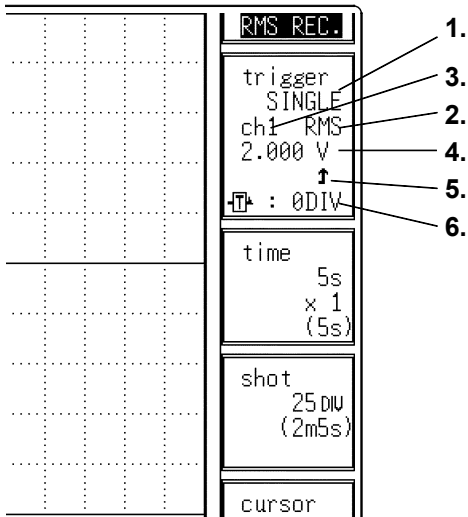
Settings on the Waveform display screen

Setting items	Operation	
	Function	Jog/Shuttle
1. Trigger mode		-
2. Trigger type		-
3. Channel		-
4. Trigger level		-
5. Trigger slope		-
6. Pre-trigger		-

Restriction:

To set numerical value by using the Jog/Shuttle control, press **VALUE** key.

Example for RMS Level Trigger

To cause triggering at point A with the signal as shown in the figure below, make the following settings.

RMS level: 1.000 V, trigger direction (slope): (\downarrow)

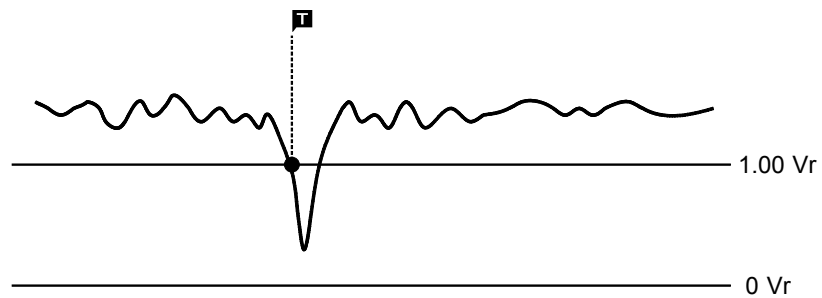

10.9 Logic Trigger

- The signal of a logic channel can be used as trigger source.
- A trigger pattern and logical operator (AND/OR) are specified, and triggering occurs when the trigger conditions are met.
- A trigger filter can be specified, so that triggering occurs only when the trigger conditions are met within the filter width.

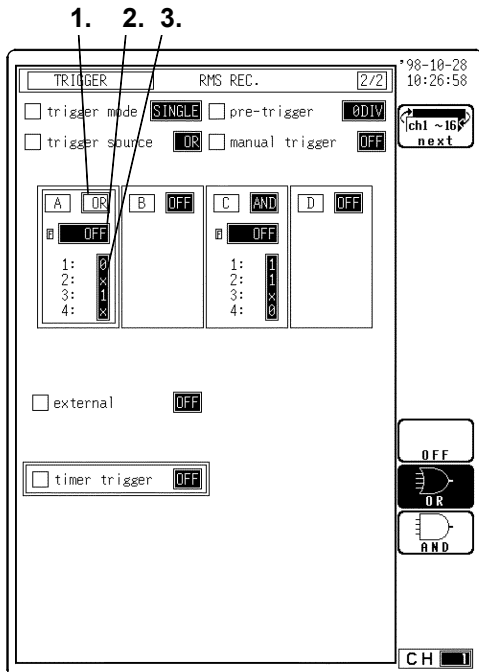

Procedure Screen: TRIGGER

(1) Set the logic trigger AND/OR linking

1. Use the **TRIG** key and the **CH.SET** key to display the screen shown in the figure.
2. Move the flashing cursor to position **1.** shown in the figure.
3. Use the function keys to select the setting.

Function
display

Meaning

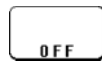

: Logic trigger is not used.



: Triggering occurs if any one of the logic input signals conforms to the trigger pattern.



: Triggering only occurs if all of the logic input signals conforms to the trigger pattern.

(2) Set the trigger filter

1. Move the flashing cursor to position **2.** shown in the figure.
2. Use the Jog/Shuttle control or the function keys to make the selection.

In the Memory recorder, Recorder&Memory, FFT Functions

OFF Trigger filter is disabled

0.1 to 10.0 Trigger filter is enabled. Filter width is specified using divisions

In the Recorder and RMS recorder functions

Function
display Meaning





: Trigger filter is disabled.



: Trigger filter is enabled.
Filter width is 10 ms.

(3) Set the trigger pattern

1. Move the flashing cursor to position **3**.
2. Select 1 - 4 with the function key display. Make the setting with the function keys.

Function display	Meaning
	: Signal disregarded
	: Low level signal
	: High level signal

NOTE

- If the conditions are met already when measurement is started (AND: all trigger patterns are met, OR: one trigger pattern is met), triggering does not occur. Triggering only occurs if the conditions are removed and then met again.
- "AND" cannot be set between the trigger sources when the logic trigger and the RMS level trigger are enabled. Shifting from "OR" to "AND" turns off the logic trigger setting.

Setting example of the Logic Trigger

- (1) If the trigger pattern has been set to "10 x x" with the operator OR, then triggering occurs as shown in the figure below.

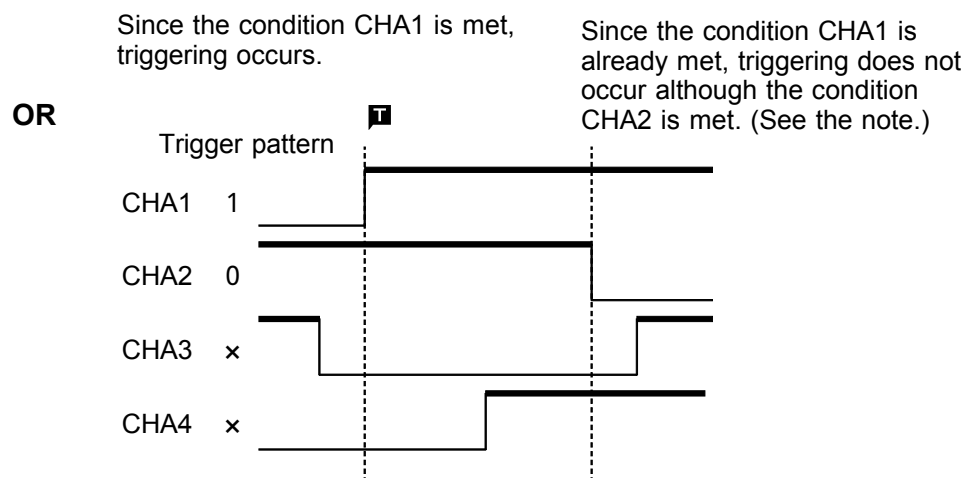

- (2) If the trigger pattern has been set to "10 x x" with the operator AND, then triggering occurs as shown in the figure below.

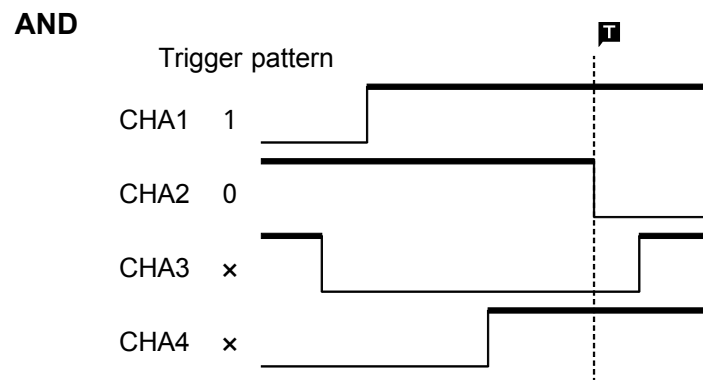

10.10 External Trigger Function

- An external signal can be used as trigger source.
- The external trigger is activated by either shorting the EXT TRIG terminal and GND terminal or applying a falling edge signal going below 2.5 V.
- The external trigger facility can be used to synchronize a number of the 8841/42 units for parallel operation.
- For details for connection, refer to 17.1.

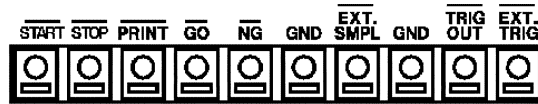

External trigger terminal

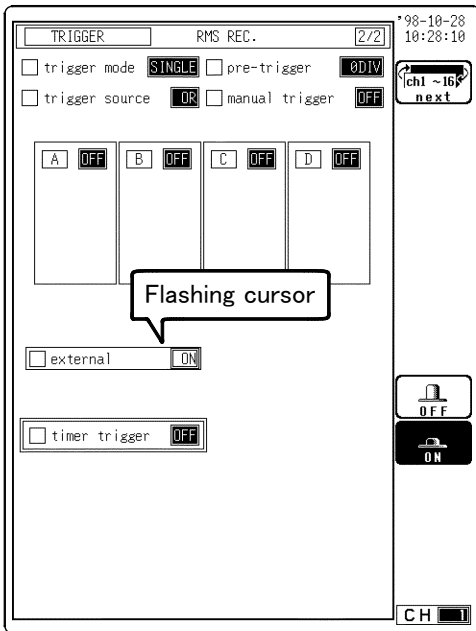

Procedure Screen: TRIGGER

1. Use the **TRIG** key and the **CH.SET** key to display the screen shown in the figure.
2. Move the flashing cursor to **external**.
3. Use the function keys to make the selection.

Function display

Meaning



: External trigger is not used



: External trigger is used.

10.11 Timer Trigger Function

- This function serves to activate recording at preset times.
- Triggering can be performed at constant intervals within a preset start time and end time.

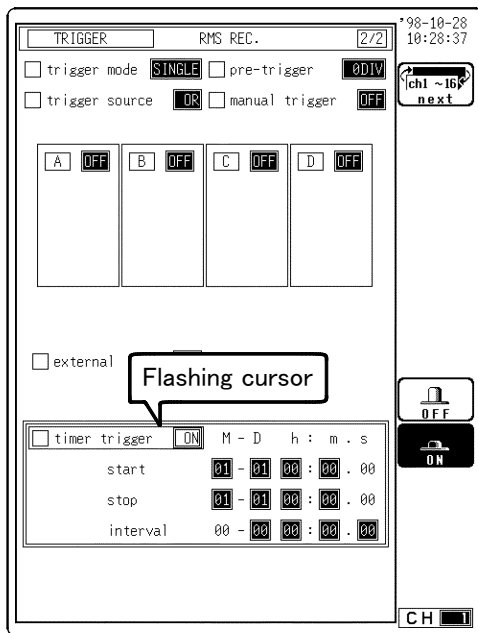
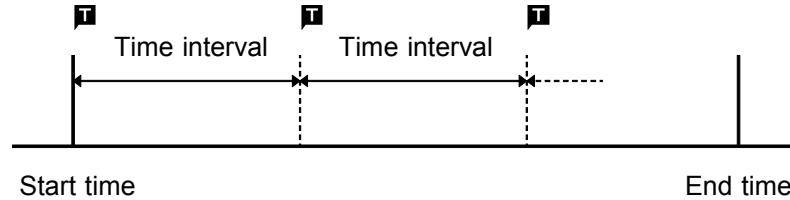

Procedure Screen: TRIGGER

(1) Set the timer trigger.

1. Use the **TRIG** key and the **CH.SET** key to display the screen shown in the figure.
2. Move the flashing cursor to **timer trigger**.
3. Use the function keys to select the setting.

Function

display Meaning



: Timer trigger is disabled.



: Timer trigger is enabled.

(2) Set the start and end time.

1. Move the flashing cursor to the **start** item.
2. Use the function keys or the Jog/Shuttle control to make the setting.

Function

display Meaning



: Increases in number, 10-unit



: Increases in number, 1-unit



: Decreases in number, 1-unit



: Decreases in number, 10-unit



: The current time is set to the start or stop time.

3. Move the flashing cursor to the **stop** item.
4. Use the function keys or the Jog/Shuttle control to make the setting.

(3) Set the interval.

1. Move the flashing cursor to the **interval** item.
2. Use the function keys or the Jog/Shuttle control to make the setting.

Note on use for the timer trigger

- (1) Set the present time on the SYSTEM screen first, then set the timer trigger.
- (2) Set the start time and end time to a point after the pressing of the **START** key.
- (3) When the trigger mode is set to **SINGLE**, only one trigger event is valid for the start time. The settings for time interval and end time are invalid (when timer trigger only is ON).
- (4) To perform recording at regular intervals, establish the following settings.
Trigger mode: repeat. Other trigger sources: all OFF
Between end of recording and standby, triggers are invalid while processing is taking place (auto save, auto print, waveform display, calculation, etc.) and therefore data may not be recorded at regular intervals with some measurement setting.
- (5) When trigger sources have been linked with OR
All trigger sources are valid. Therefore triggering may occur even before the start time, and trigger standby and measurement may continue even after the stop time.
- (6) When trigger sources have been linked with AND
 - Trigger standby is enabled at the measurement start time and at each interval, and triggering will occur when all trigger conditions other than timer trigger are met simultaneously.
 - Setting the interval to 0 can be made active for the preset time interval only.
 - When the recording length (recording time) is longer than the time interval:
 1. Timer trigger, which is determined from the time interval during recording, is disabled.
 2. End time
MEM, FFT: Retrieve measured data equivalent to the recording length and discontinue measurement.
REC, RMS: Stop retrieving measured data at the set stop time.

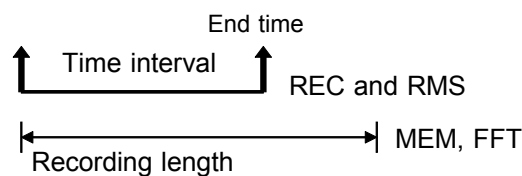

Relation between timer trigger and AND/OR linking

When trigger sources are set to OR:

All trigger sources are valid. If other trigger sources have been set, triggering can also occur before the start time or after the end time.

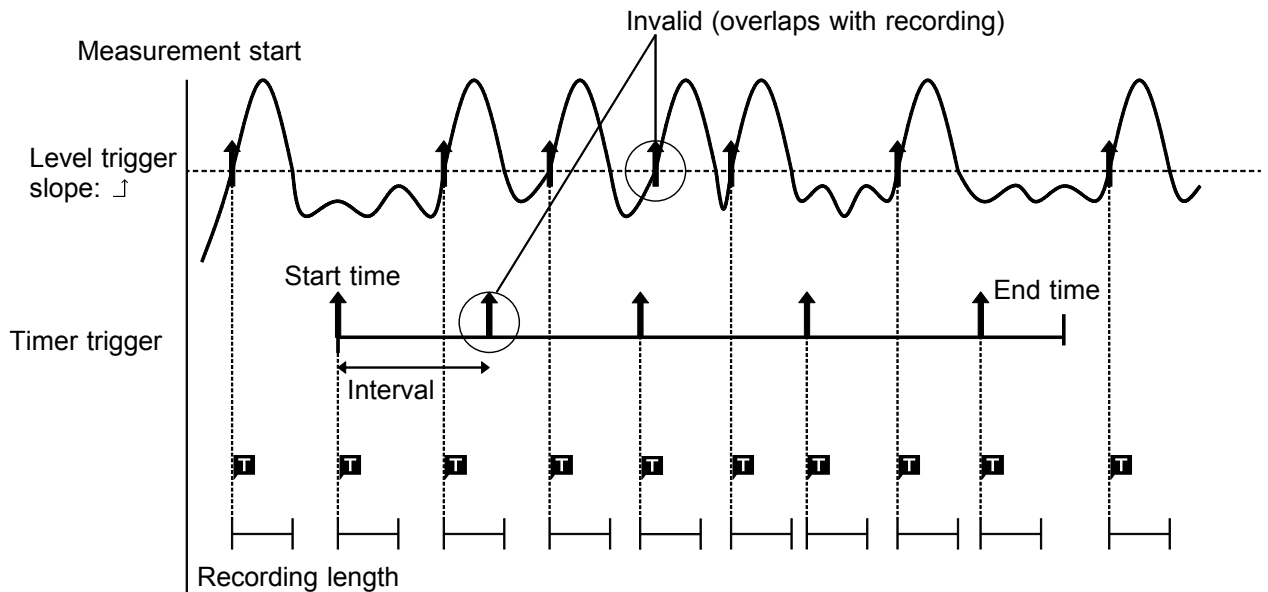

When trigger sources are set to AND:

- Measurement is carried out from the start time to the end time. Triggering occurs at the preset intervals if the conditions for the other trigger sources are also met at these points.
- If the interval has been set to 0s, triggering occurs at any point between the start and end time, if the conditions for the other trigger sources are met.

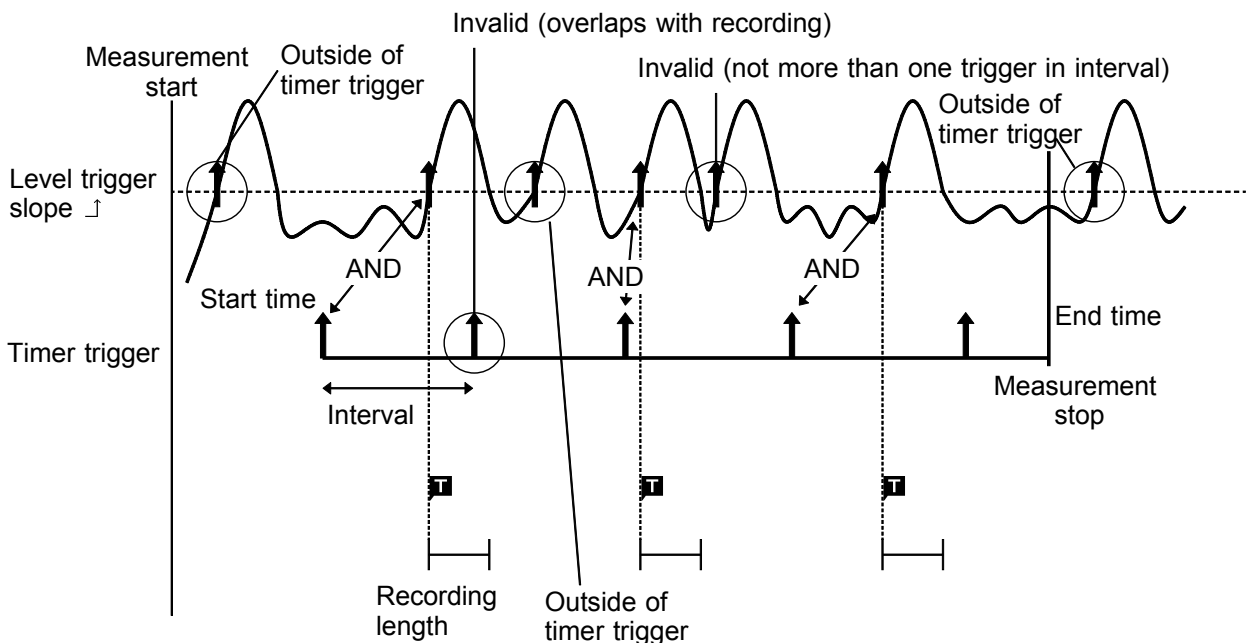

10.12 Manual Trigger

- Triggering occurs when the **MANU TRIG** key is pressed.
- The manual trigger is always activated when the **MANU TRIG** key is pressed, regardless of trigger source AND/OR linking setting.

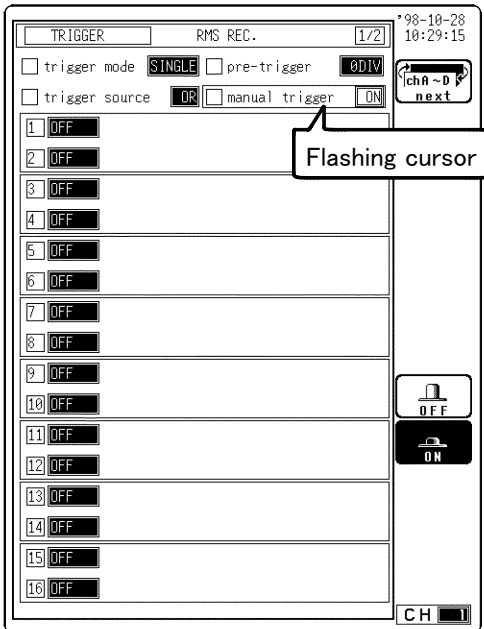

Procedure Screen: TRIGGER

1. Press the **TRIG** key to display the TRIGGER screen.
2. Move the flashing cursor to **manual trigger**.
3. Use the function keys to make the selection.

Function
display

Meaning



: Manual trigger is disabled.



: Manual trigger is enabled.

10.13 Trigger Output Terminal

- When triggering occurs, a signal is output from the TRIG OUT terminal.
- This can be used to synchronize several 8841/42 units.
- For details, see Section 17.1.3.

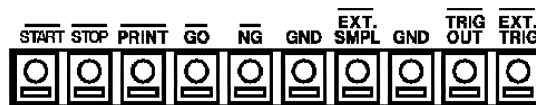

Trigger output terminal

NOTE

Pressing the **AUTO** key to use the auto ranging function causes a trigger signal to be output. Care is therefore required when using the auto ranging function when the trigger output terminal is in use. (Only a memory recorder function)

Chapter 11

Waveform Display Screen Operation

Indicates the Waveform display screen operation.

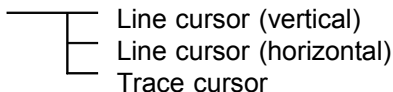
- Setting the Input channel** To set a numerical value using the Jog/Shuttle control on the Waveform display screen, press the **VALUE** select key. (The selection window is not displayed.) Pressing the **CH.SET** key, enables the measurement conditions for each channel on the Waveform display screen to be set or changed. See Section 9.10.
- Scrolling the Waveform** To scroll the waveform on the Waveform display screen, press the **WAVE** select key. Use the Jog/Shuttle control to scroll the waveform.
- Using the A·B Cursors**  Line cursor (vertical)
Line cursor (horizontal)
Trace cursor
- When want to use the A·B Cursors, press the **A·B CSR** select key.
- Magnification/compression ratio along the time axis** MEM, memory waveform in REC&MEM: magnification and compression
REC, RMS, recorder waveform in REC&MEM: compression only
- Zoom function** This function divides the memory recorder function Waveform display screen into upper and lower windows, so that the regular-size waveform is displayed in the upper window and the waveform enlarged in the time axis direction is displayed in the lower window.
- Input level monitor function** Press the **LEVEL MONI** key on the Waveform display screen, waveform input level can be monitored.
- View function** Pressing the VIEW key shows the position of the currently displayed waveform within the entire recording length, and shows the memory segmentation status.

11.1 Scrolling the Waveform

The waveform on the display can be scrolled horizontally.

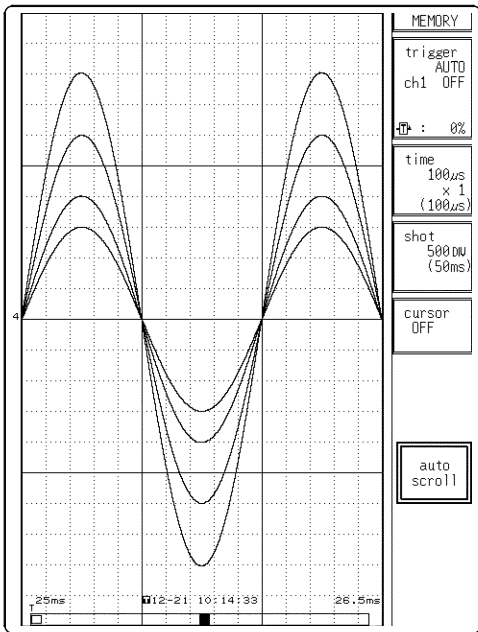

Procedure Screen: Waveform display

1. Press the **WAVE** select key.
2. Use the Jog/Shuttle control to scroll the waveform

Auto-scroll

If turning the the Shuttle control fully and holding the control for about five seconds, the indication "auto scroll" appears on the function key display and the waveform continues to scroll even if releasing the control.

Auto-scroll is canceled by pressing any key.

When the waveform is scrolled, the screen status and waveform position are as illustrated below.

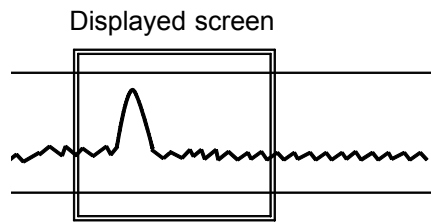

Position display by the VIEW key

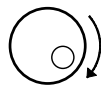

Scrolling the waveform to the right

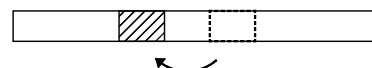
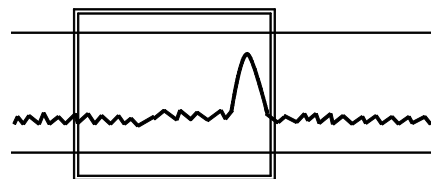

11.2 Using the A·B Cursors

The A·B cursors can be used to read a time difference, frequency, or potential difference on screen. (When scaling is used, the difference is displayed in the scaling value. See Section 9.8.)

Line Cursor (vertical, horizontal)

The value at cursor A and cursor B, and the value between the two cursors can be determined.

Trace Cursor

- Memory recorder, memory waveform in REC&MEM, FFT
The value at the point where the cursor crosses the waveform can be determined. The trace point moves on the waveform of the specified channel.
- Recorder, RMS recorder, recorder waveform in REC&MEM
The intersection between the cursor and the waveform is displayed midway between of the maximum and minimum values.

Cursor Value	A or B	B - A
Vertical	t Time from the trigger point (MEM, RMS, memory waveform in REC&MEM) Time from recording start (REC, recorder waveform in REC&MEM) 1/t Frequency taking t as the period	t Time interval between the A and B cursors 1/t Frequency taking t as the period
Horizontal	v Voltage value for channel selected	v Potential difference between the A and B cursors.
Trace	t Time from trigger point (MEM, RMS, FFT, memory waveform in REC&MEM) Time from recording start (REC, recorder waveform in REC&MEM) v Voltage value for channel selected (MEM, FFT, memory waveform in REC&MEM) Maximum and minimum values for channel selected (REC, RMS, recorder waveform in REC&MEM) f Analysis frequency (FFT)	t Time difference between the trace points v Potential difference between the trace points f Frequency difference between the trace points (FFT)

MEM: memory recorder function, REC: recorder function, RMS: rms recorder function

NOTE

- When the time-axis range of the RMS recorder is 5 s/division, the trace cursor value of "v" is the voltage value of the selected channel.
- When external sampling is being performed, a "t" is included in the sampling number.
- While the settings are made on the Waveform display screen (displaying the input channel), the value between A and B cursors is no displayed.
- A·B cursor measurements are enabled even if the line cursor (vertical) or trace cursor are off the screen. When the cursor is set to A&B and either the A or B cursor is moved, both A and B cursors are shifted onto the screen.

11.2.1 Using the Line Cursors (Vertical)

The line cursor (vertical) displays the time and period starting from the trigger position. On the recorder, the line cursor (vertical) displays the time and period starting from the initiation of recording.

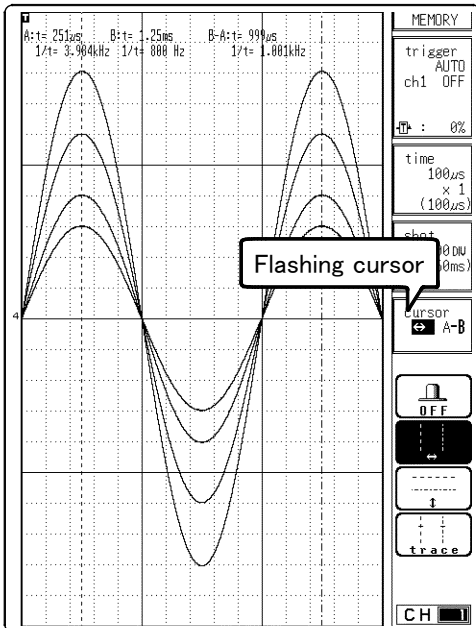

Procedure Screen: Waveform display

1. Move the flashing cursor to the **cursor** item
2. Use the function keys to select the Line cursor (vertical).

Function display	Meaning
------------------	---------



: Disable A·B cursors



: Line cursor (vertical: t, 1/t)



: Line cursor (horizontal: v)



: Trace cursor (the point where the cursor crosses the waveform)

3. Use the function keys to select the cursor to be moved.

Function display	Meaning
------------------	---------



: Use the cursor A only



: Move the cursor A only



: Move the cursor B only



: Move both cursors A and B

4. Press the **A·B CSR** select key.

5. Rotate the Jog/Shuttle control to move the cursor.

NOTE

- When the **A·B CSR** select key is used to activate the A·B cursor mode, the trace cursor (X-Y CONT: line cursor) can be used, also if it was set to OFF.
- A·B cursor measurements are enabled even if the line cursor (vertical) or trace cursor are off the screen. When the cursor is set to A&B and either the A or B cursor is moved, both A and B cursors are shifted onto the screen. The **VIEW** key can be used to check the cursor position within the total recording length.
- When the cursor is moved to the edge of the screen, the waveform is scrolled.
- If turning the the Shuttle control fully and holding the control for about five seconds, the indication "auto scroll" appears on the function key display and the waveform continues to scroll even if releasing the control. Auto-scroll is canceled by pressing any key.
- In additional recording (recorder, rms recorder, recorder waveform in REC&MEM), the junction between data is invalid data.

11.2.2 Using the Line Cursors (Horizontal)

Used to read a voltage value of the specified channel. A•B cursor can be specified a different channel.

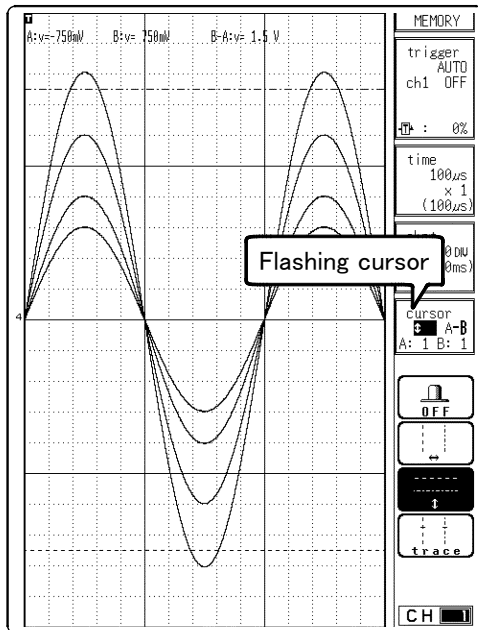

Procedure Screen: Waveform display

1. Move the flashing cursor to the **cursor** item
2. Use the function keys to select the Line cursor (horizontal).

Function display

Meaning



: Disable A•B cursors



: Line cursor (vertical: t, 1/t)



: Line cursor (horizontal: v)



: Trace cursor (the point where the cursor crosses the waveform)

3. Use the function keys to select the cursor to be moved.

Function display

Meaning

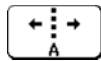

: Use A cursor only

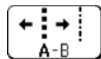

: Move the A cursor only

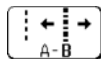

: Move the B cursor only



: Move both the A and B cursors

4. The channel setup items for each cursor (A•B) are displayed under "cursor". Move the flashing cursor to set the waveform channels from which you want to read voltages, using the function keys or the Jog/Shuttle control (VALUE select key).
5. Press the **A•B CSR** select key.
6. Rotate the Jog/Shuttle control to move the cursor.

NOTE

- When the **A•B CSR** select key is used to activate the A•B cursor mode, the trace cursor (X-Y CONT: line cursor) can be used, also if it was set to OFF.
- Only channels for which a waveform is being displayed can be specified.
- By specifying a different channel for the A and B cursors, a potential difference between the waveforms in the respective channels can be determined.

11.2.3 Using the Trace Cursors

Used to read the value at point where the cursor crosses the waveform of the specified channel. A•B cursor can be specified a different channel.

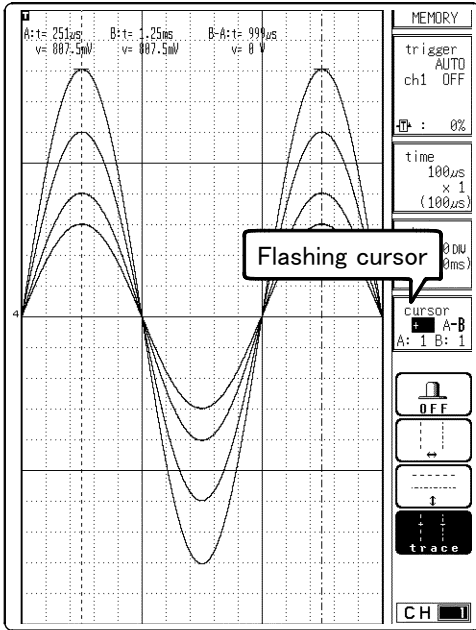

Procedure Screen: Waveform display

1. Move the flashing cursor to the **cursor** item
2. Use the function keys to select the Trace cursor.

Function display	Meaning
	: Disable A•B cursors
	: Line cursor (vertical: t, 1/t)
	: Line cursor (horizontal: v)
	: Trace cursor (the point where the cursor crosses the waveform)

3. Use the function keys to select the cursors to be moved.

Function display	Meaning
	: Use the A cursor only
	: Move the A cursor only
	: Move the B cursor only
	: Move both A and B cursors

4. The channel setup items for each cursor (A•B) are displayed under "cursor". Move the flashing cursor to set the waveform channels from which you want to read value, using the function keys or the Jog/Shuttle control (VALUE select key).
(When A cursor only)

Function display	Meaning
	: Read the values of all the channels.

5. Press the **A•B CSR** select key.
6. Rotate the Jog/Shuttle control to move the cursor.

NOTE

- When the **A•B CSR** select key is used to activate the A•B cursor mode, the trace cursor can be used, also if it was set to OFF.
- Trace cursor can not be used on the X-Y CONT recorder.
- A•B cursor measurements are enabled even if the line cursor (vertical) or trace cursor are off the screen. When the cursor is set to A&B and either the A or B cursor is moved, both A and B cursors are shifted onto the screen.
- The **VIEW** key can be used to check the cursor position within the total recording length.
- Only channels for which a waveform is being displayed can be specified.
- By specifying a different channel for the A and B cursors, a potential difference between the waveforms in the respective channels can be determined.
- When the cursor is moved to the edge of the screen, the waveform is scrolled.
- If turning the the Shuttle control fully and holding the control for about five seconds, the indication "auto scroll" appears on the function key display and the waveform continues to scroll even if releasing the control. Auto-scroll is canceled by pressing any key.
- Even if the one of the cursors A and B is out of the screen, the measurement between cursors can be made.

11.2.4 Using the A·B Cursors (X-Y Screen)

The cursor can be used on the X-Y screen. Partial X-Y plotting enables operation of the A·B cursors.

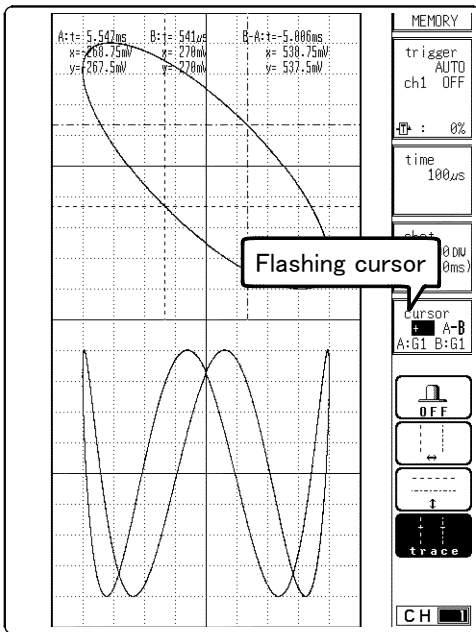

Procedure Screen: X-Y Waveform display

1. Move the flashing cursor to the **cursor** item
2. Use the function keys to make selection.

Function display

Meaning

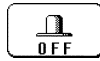

: Disable A·B cursors



: Line cursor (vertical: t, 1/t)

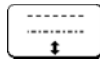

: Line cursor (horizontal: v)

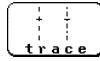

: Trace cursor (the point where the cursor crosses the waveform)

3. Use the function keys to select the cursor to be moved.

Function display

Meaning

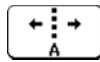

: Use A cursor only

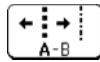

: Move the A cursor only

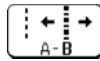

: Move the B cursor only



: Move both the A and B cursors

4. The graph setup menu appears below the cursor. Using the function keys or the Jog/Shuttle control, move the flashing cursor to set the graph of the waveform for which the voltage is to be read. This channel setting must be performed for both cursors A and B.
5. Press the **A·B CSR** select key.
6. Rotate the Jog/Shuttle control to move the cursor.

NOTE

By specifying a different graph for the A and B cursors, a potential difference between the waveforms in the respective channels can be determined.

11.3 Magnification/compression Ratio Along the Time Axis

- The magnification/compression ratio along the time axis can be set.
- By magnifying the waveform, detailed observations can be made. By compressing the waveform, an entire change can be promptly apprehended.
- Magnification/compression of the screen uses the left edge as reference, regardless of the status of the A•B cursor.
- The magnification/compression factor can be changed also after measurement is completed.

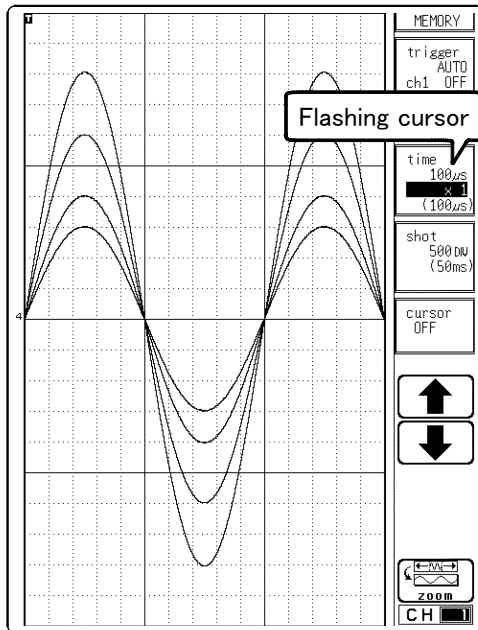

Procedure Screen: Waveform display, CHANNEL

1. Move the flashing cursor to the position shown in the figure on the left.
2. Use the function keys or the Jog/Shuttle control to select the magnification/compression ratio.

Function display	Meaning
	: Increases in number.
	: Decreases in number.

Function	Magnification/Compression ratio
MEM, memory waveform in REC&MEM	× 10, × 5, × 2, × 1, × 1/2, × 1/5, × 1/10, × 1/20, × 1/50, × 1/100, × 1/200, × 1/500, × 1/1000, × 1/2000, × 1/5000, × 1/10000
REC, RMS, recorder waveform in REC&MEM	× 1, × 1/2, × 1/5, × 1/10, × 1/20, × 1/50, × 1/100, × 1/200, × 1/500

NOTE

Set the magnification or compression ratio along the voltage axis on the CHANNEL screen or Waveform display screen. For details, see Section 9.3.5, "Setting the Magnification/Compression Ratio Along the Voltage Axis".

11.4 Zoom Function (MEM only)

This function divides the memory recorder function display screen into upper and lower windows, so that the regular-size waveform is displayed in the upper window and the waveform enlarged in the time axis direction is displayed in the lower window.

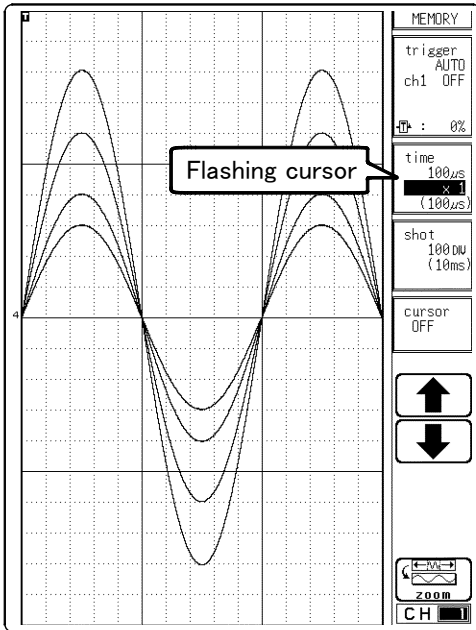



Procedure Screen: Waveform display

1. Press the **DISP** key to display the Waveform display screen.
2. Move the flashing cursor to the position shown in the figure on the left.
3. Use the function keys to select the **zoom** item. When the zoom function is selected, the display is split into two horizontally tiled screens. The waveform before the zoom mode was activated is displayed on the upper screen. The lower screen shows the zoomed waveform.

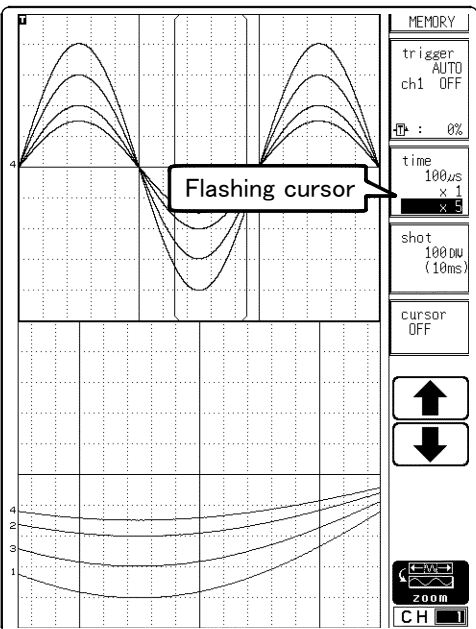
When the logic waveform is set so as to be displayed in a position from 5 to 8, it is not displayed.



4. Move the flashing cursor to the position shown in the figure on the left.
5. Use the function keys or the Jog/Shuttle control to set the magnification ratio. The brackets [] on the upper screen indicate the waveform range displayed on the lower screen. The position of bracket can be move by using the Jog/Shuttle control with the **WAVE** select key. The A•B cursors are applicable to the waveform on the lower screen.

Function display	Meaning
	: Increases in number.
	: Decreases in number.

6. To exit the zoom function, press **zoom**.

NOTE

- During the zoom function, pressing the **PRINT** key prints the waveform on the lower screen. (The waveform becomes that of the one screen display. If the A•B cursors are used, partial print is applied.)
- To zoom a stored REC&MEM waveform, switch to the Memory recorder function.

11.5 Input Level Monitor Function

- The levels of all input waveforms can be monitored in real time.
- Levels are displayed separately for CH1 - CH16 and logical CHA - CHD.
- To select the input channel, use the **CH.SET** key. See Section 9.10.
- The level monitor function can not be used in RMS record function during measurement.

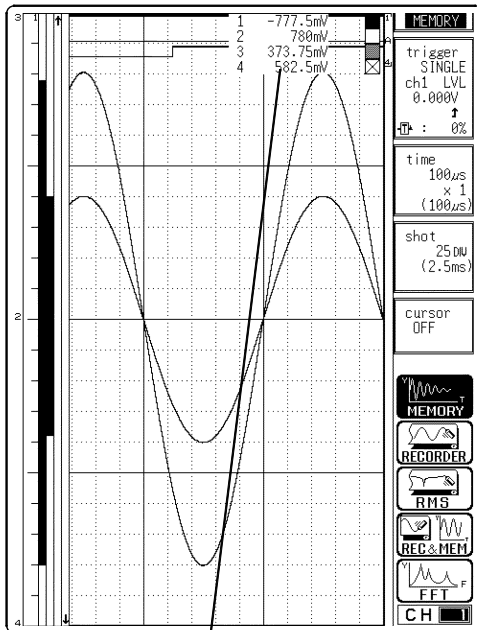

An instantaneous value for the analog channel is displayed. In RMS recorder function, however, the RMS value is not displayed.

Display of current measurements is hidden when displaying the CH.SET screen, and reappears when exiting the CH.SET screen.

Procedure Screen: Waveform display



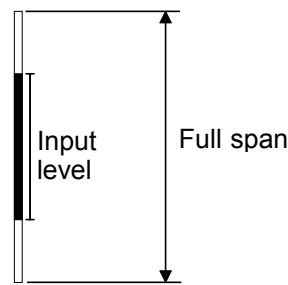

1. Press the **LEVEL MONI** key.
2. The **CH.SET** key can be used to select the input channel while using the input level monitor function.
3. Press the **LEVEL MONI** key once more to terminate the function.

The screen displays depend on settings of display format on the STATUS screen in each function. When the X-Y screen has been set, only those channels assigned to graphs 1 to 4 are displayed.

Analog channels



Logic channels

-  : The input is stabilized at the HI level.
-  : The input varies drastically between the HI and LOW levels.
-  : The input is stabilized at the LOW level.
-  : The display is disabled.

When the input level is not displayed on the screen display range

- ↑ The input level exceeds the upper limit.
- ↓ The input level exceeds the lower limit.

NOTE

For the following channels, analog input level is not displayed:

- Channels where no unit is installed.
- A channel that deviates from the set active channel range (example: channel 5 or subsequent channels when the number of set active channels is four).

11.6 View Function (VIEW key)

11.6.1 Position Display

Indicates the position of the currently displayed waveform within the entire recording length.

The trigger time, trigger position and A•B cursor position are displayed when using the vertical or trace cursors. There is no particular view for the FFT function.

When the recording length is 200 divisions:

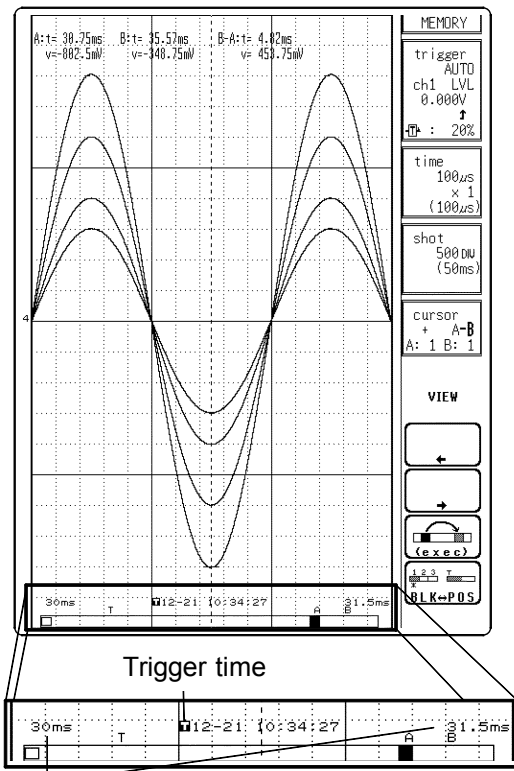
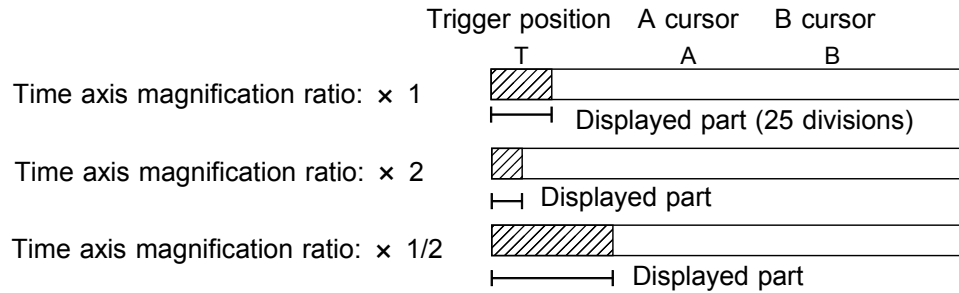

Time from trigger point
(MEM, RMS, memory waveform in REC&ME)

Time from starting record
(Recorder, recorder waveform in REC&MEM)

Procedure Screen: Waveform display

1. Press the **VIEW** key on the Waveform display screen. The position is displayed at lower of the screen.
2. Use the function keys to move the () mark to the desired point with function key. Slide the bar graph cursor to select from 0, 25, 50, 75, and 100% of full recording length, trigger point, and A and B cursors.

Function display	Meaning
	: Shifts the destination to the left.
	: Shifts the destination to the right.
	: Executes the dislocation.
	: Toggles block display.

3. Select the **(exec)** function key. The high-speed shift is carried out and the display position changes.

NOTE

- While the view function is active, the flashing cursor is not displayed and the settings cannot be changed.
- Even during measurement, the position of the waveform can be displayed by pressing the **VIEW** key.
- When the view function is displayed, settings with the **CH.SET** key are disabled.
- When the recording length is set to "CONT." on the recorder or RMS recorder and at least 2000 divisions (10,000 divisions for 32 M words) are recorded, the time displayed does not represent the value counted from the trigger point.
- When the recording length of recorder waveform in REC&MEM is set to "CONT." and at least 1000 divisions (5000 divisions for 32 M words) are recorded, the time displayed does not represent the value counted from the recording start point.

11.6.2 Block Display (MEM only)

When memory segmentation is being used, the memory block status is shown. Sequential save and multi-block function can be used block display. Any block in which an input signal is recorded can be called up on the display.

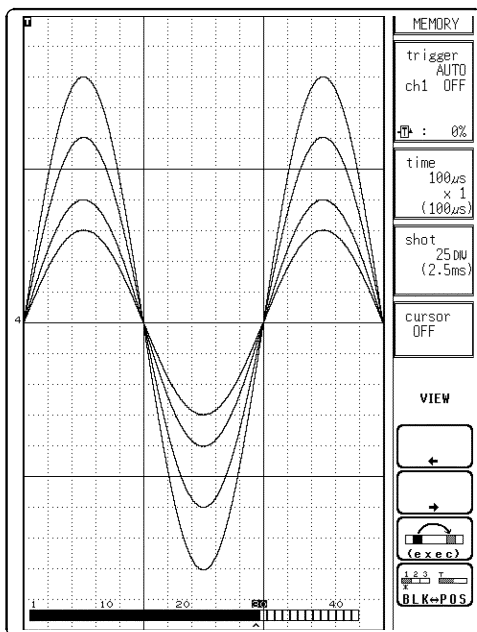

Procedure Screen: Waveform display

1. Press the **VIEW** key on the Waveform display screen.
2. The position is displayed.
3. Using the function key to select **block display**.

Function display

Meaning



: Shifts the destination to the left.



: Shifts the destination to the right.



: Executes the dislocation.



: Toggles block display.

4. When the number of divisions is 31 or over, change the bar graph using the up and down cursor keys.
5. Use the function keys to move the " " mark and specify the memory block you wish to display.
6. Using the function key to select **(exec)**.

NOTE

- While the view function is active, the flashing cursor is not displayed and the settings cannot be changed.
- The memory segmentation function can be used in memory recorder function.
- Sequential save of memory blocks is possible only with the Record & Memory function.

Chapter 12

SYSTEM Screen Settings

12.1 Overview

The SYSTEM screen serves to set the following items which are common to all functions.

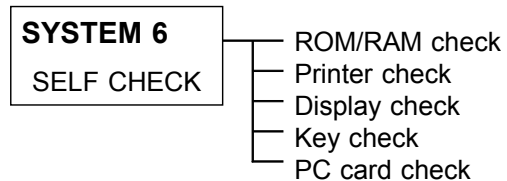
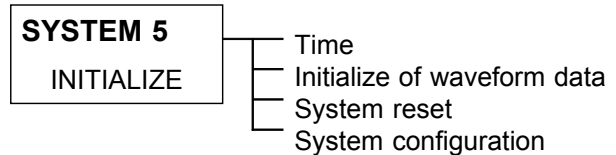
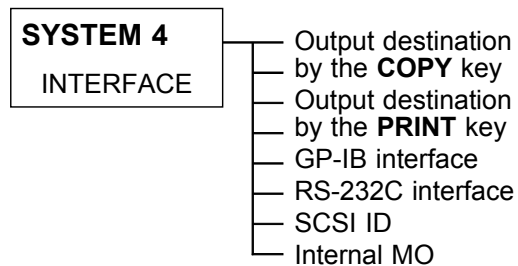
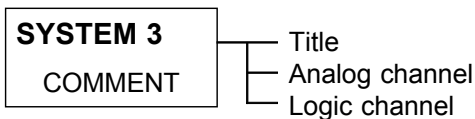
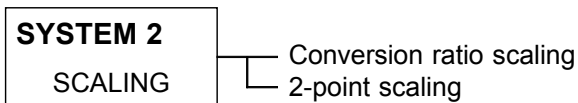
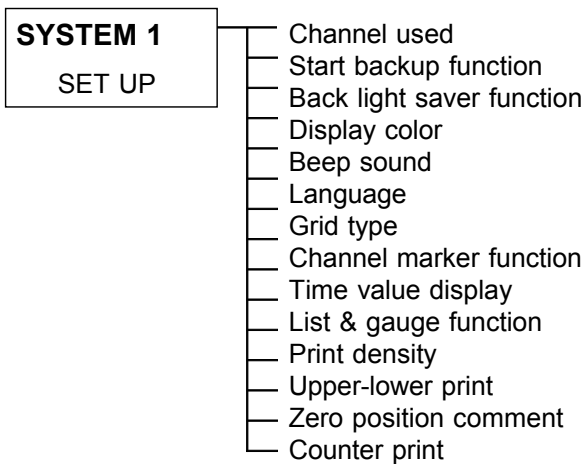

12.2 SET UP Screen (SYSTEM 1)

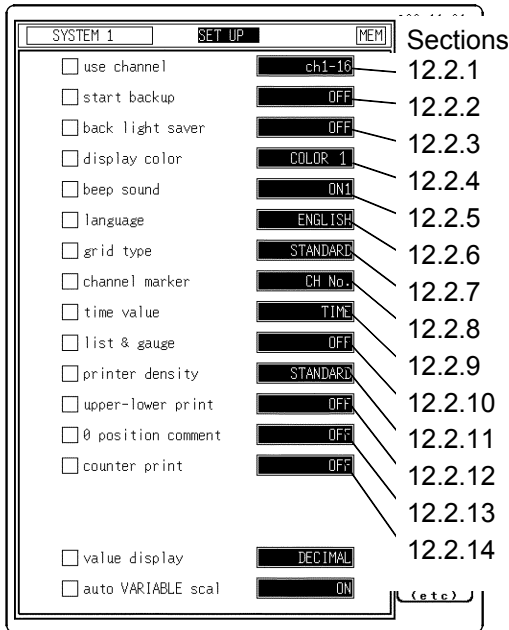

Procedure Screen: SET UP (SYSTEM1)

1. Press the **SYSTEM** key to display the SET UP screen.
2. Move the flashing cursor, want to set the item.
3. Use the function keys to make the selection.

The item of channel marker, time value display, upper and lower limits of printer, zero position comment, counter printing cannot be used in FFT function.

12.2.1 Using Channel (MEM only)

- Select whether the memory for measurement data is used by being divided up.
- The smaller the number of channels in use, the longer will be settable recording length.

Function display

Meaning

- ch1-2** : Allocates memory for measurement data to two channels. Channels 3 to 16 and logic CHC to CHD can not be used.
- ch1-4** : Allocates memory for measurement data to four channels. Channels 5 to 16 can not be used.
- ch1-8** : Allocates memory for measurement data to eight channels. Channels 9 to 16 can not be used.
- ch1-16** : Allocates memory for measurement data to 16 channels.



NOTE

Settings for the use channel are displayed only when the Memory recorder function has been set.

For the 8841, if the 8946 4ch ANALOG UNIT is not connected, "ch1-8" is set after system reset.



12.2.2 Start Backup

- When this function is enabled, the unit will operate as follows: If the power supply is interrupted during recording operation (while the **START** key LED is lit), and then the power supply is restored, the 8841/42 goes back into the measurement operation mode, and recording is restarted immediately.
- If the trigger function is used, the unit goes into trigger standby mode. (However, this is disabled with the timer trigger.)

Function display	Meaning
	: The start key backup function is not used.
	: The start key backup function is used.



12.2.3 Backlight Saver

- When this function is enabled, LCD back lighting is turned off automatically if no key is pressed for the preset interval.
- Pressing any key will turn the display on again.
- This increases the service life of the backlight.

Function display	Meaning
	: Increase time (1 to 30). The display automatically goes off after the preset interval (minutes).
	: Decrease time (1 to 30).
	: The display is shown continuously.



12.2.4 Display Color

- Serves to set the display color.
- The display color can be selected from among the display colors 1 to 8 and the customer color 9 which can be set as desired.

Function display	Meaning
	: Increase the color number.
	: Decrease the color number.
	: Change the setting color



Customize Screen Colors

Change the R.G.B. setting values of each item on the screen. The setting values inside the window applies to the colors of the particular window. When a value is changed, the color of the area corresponding to this item changes. When system reset is executed, set colors are initialized and become the same color as that of display color 1.

Function display	Meaning
	: Increases in number.
	: Decreases in number.
	: Exit from the custom setting screen.



12.2.5 Beep Sound

This function indicates the operating status by a beep sound. The beep can be selected from two types. Performing a system reset sets the ON1 beep type.

Function display	Meaning
	: Beep is not heard.
	: The beep sounds with error messages (error or warning display) and when a waveform is evaluated as NG.
	: The beep sounds upon start, trigger, stop and when data storage finished, as well as with error messages (error or warning display) and when a waveform is evaluated NG.

12.2.6 Display Language

Serves to set the display language.

Function display	Meaning
	: Displays in Japanese.
	: Displays in English.

12.2.7 Grid Type

- Selects the type of grid shown on the Waveform display screen and drawn on the recording paper.
- On the Waveform display screen, the standard and fine grids are defined as the standard, and the standard (dark) and fine (dark) grids are defined as the standard (dark) grids.
- "Time" and "Time (dark)" can be set only during printing.





NOTE

In printing in the X-Y screen format or FFT function, the standard time axis and the standard time axis (dark) are applied.



12.2.8 Channel Marker

The channel numbers or the comments are printed together with the waveform on the recording paper.

Function display	Meaning
	: Channel numbers will not be printed for the waveform on the recording paper.
	: Channel numbers will be printed for the waveform on the recording paper.
	: Comments will be printed for the waveform on the recording paper.



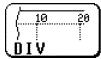
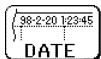

12.2.9 Time Value

The time from the trigger point and other information can be printed.

Function display	Meaning
	: Displays the time from the trigger point (unit: fixed)
	: Displays the time from the trigger point (unit: base 60).
	: Displays the number of DIV from trigger point.
	: Displays the time when a waveform is captured.

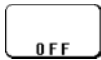
12.2.10 List & Gauge

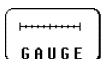
When a waveform is printed out (except for screen hard copies), the gauge can be printed out at the beginning, and a listing can be printed out at the end.

Function display	Meaning
	: No gauges or listing
	: Print listing only
	: Print gauges only
	: Print both gauges and listing



12.2.11 Printer Density

Serves to set the printer density. Select the setting which yields the most easy to read printout.





12.2.12 Upper-lower Values Print

In waveform printing, the upper and lower values of each channel are printed first. When the scaling function is being used, the scaled values are printed.

Function display	Meaning
	: Upper-lower print is not used.
	: Upper-lower print is used.



12.2.13 0 Position Comment

In waveform printing, comments are printed out in the zero position of each channel. This comment printing is valid only for the analog channels. Comments can be set on SYSTEM3 (COMMENT) screen.

Function display	Meaning
	: 0 position comment is not used.
	: 0 position comment is used.

12.2.14 Counter Print

In waveform printing, the counter can be printed out. This function is useful to distinguish between similar waveforms.



Function display	Meaning
	: Counter Print is not printed.
	: Counter Print is printed with date.
	: Counter Print is printed with counter name.

- A counter name of up to ten characters can be specified. For information on how to enter the counter name, see Section 9.9.3.
- After the unit is turned on, the counter is reset to 0 (zero), and the counter value is increased each time a waveform is retrieved. (The maximum counter value is 9999.)

To start from an arbitrary count, move the flashing cursor to the count value and provide the setting using the function keys or the Jog/Shuttle control.



12.2.15 Numerical Input

This specifies the method for entering and displaying numerical values entered in the scaling setting window and variable setting window.

Function display	Meaning
	: Use the numeric keypad to enter values directly, including the decimal point.
	: Enter by selecting the real part or the exponent and increasing or decreasing its value. The value is then displayed in exponential form.

12.2.16 Variable Auto Calibration

This automatically calibrates the variable settings in conjunction with changes to the scaling and voltage axis range settings.

Function display	Meaning
	The variable settings are not changed even if the scaling or voltage axis range settings are altered.
	The variable settings are changed in conjunction with changes to the scaling or voltage axis range settings.

12.3 SCALING Screen (SYSTEM 2)

- The scaling function can be used to convert an output voltage from a sensor or similar into a physical quantity.
- Two types of scaling functions are available.
- The gauge scale (maximum and minimum values of vertical axis) and A•B cursor measurement values are displayed in the scaled units.
- Scaling can be performed for every channel.

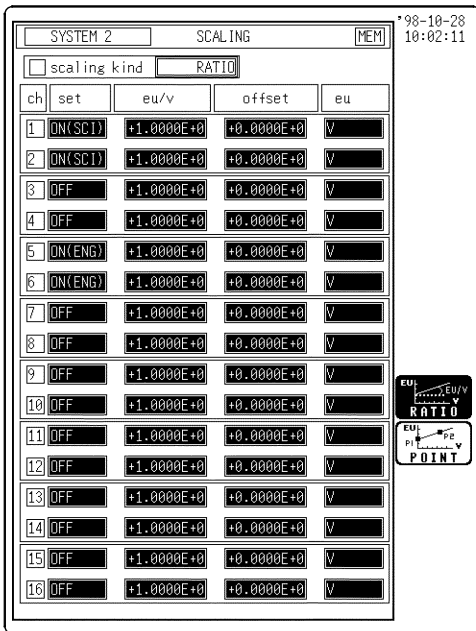

(1) Conversion ratio method

Scaling is performed by specifying a physical quantity to correspond to a 1 V input signal (conversion ratio: eu/v), an offset value, and the unit (eu: engineering units). This will cause the measurement voltage to be converted into the selected units.

(2) 2-point method

Scaling is performed by specifying two input signal points (voltage values) and the conversion values for these two points in engineering units (eu). This will cause the measurement voltage to be converted into the selected units.

For details, see Section 9.8.

12.4 COMMENT Screen (SYSTEM 3)

Three types of comment are available.
If "COMMENT" or "SET & COM" is selected, this comment will be included on the recording paper in all functions.

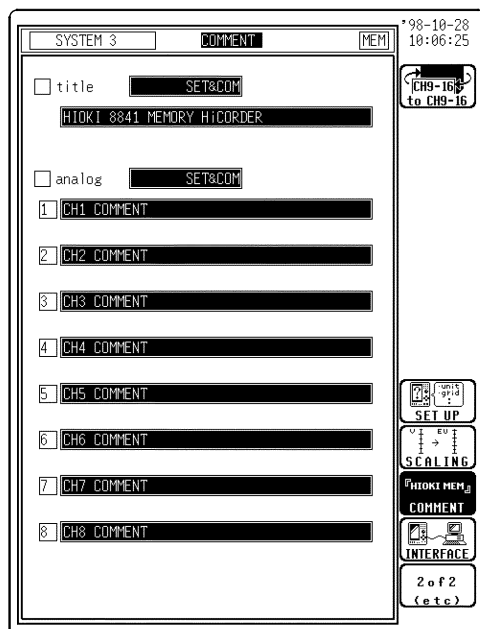

- (1) Title comment input
Title comments of up to 40 characters can be included on the recording paper.
- (2) Input of comments for analog channel
Comments of up to 40 characters can be included on the recording paper on each channel.
- (3) Input of comments for logic channel
Comments of up to 40 characters can be included on the recording paper on each channel.

For details, see Section 9.9.

12.5 INTERFACE Screen (SYSTEM 4)

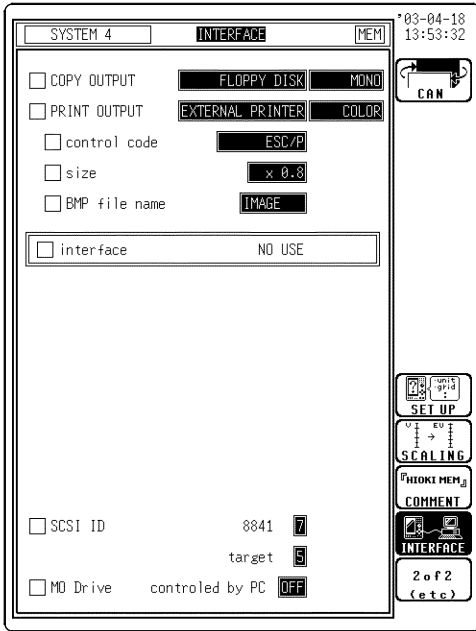

Procedure Screen: INTERFACE (SYSTEM4)

1. Press the **SYSTEM** key or function key to display the INTERFACE screen.
2. Move the flashing cursor to set the item.
3. Use the function keys to make the selection.

Interface Setting Screen

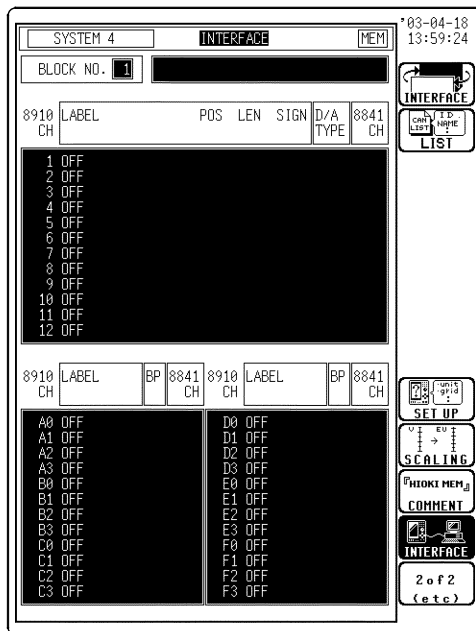

Setting the 8910 CAN ADAPTER

You can edit the 8910 CAN ADAPTER setting when the 8910 CAN ADAPTER is connected via the RS-232C interface.

Press the **CH.SET** key to switch between the interface and 8910 setting screens.

For details, refer to the instruction manual provided with the 8910 CAN ADAPTER.

8910 Setting Screen

12.5.1 Output Destination by the COPY Key

The screen data output destination when the **COPY** key is pressed and the color of the output destination can be specified.

NOTE

- When the output destination is specified other than internal and external printers and the color of output destination is set to monochrome, the screen is displayed in monochrome while data saving is in progress.
- Stores a file in the directory currently selected on the file screen. See Section 14.12.2.

12.5.2 Output Destination by the PRINT Key

The measurement data output destination when the **PRINT** key is pressed and the color of the output destination can be specified.

NOTE

Even if the information that has been input using the **PRINT** key is to be output to the external printer, automatic printing or real-time printing is performed on the internal printer rather than the external printer.

12.5.3 Interface Settings

When the GP-IB interface, RS-232C interface, or LAN interface is used, the following items must be set.

GP-IB

Mode	ADDRESSABLE / TALK ONLY / DISABLE
Address	0 to 30
Header	OFF/ON

RS-232C

Transfer rate	1200/ 2400/ 4800/ 9600/ 19200/ 38400/ 57600/ 115200
Data word length	8 bit/ 7 bit
Parity	NONE/ EVEN/ ODD
Stop bit	1 bit/ 2 bit
Delimiter	LF/ CR + LF
Header	OFF/ ON
Flow control	NONE/ Xon/Xoff/ HARD

LAN

Refer to Section 12.5.6, "Setting the LAN"

NOTE

For details, refer to the "9558 GP-IB CARD" or "9557 RS-232C CARD" Instruction Manual.

12.5.4 Setting the SCSI ID

Set the SCSI interface. For details, refer to 14.4.

8841/42

Set the ID number of the 8841 or 8842 on the SCSI bus.
The available value range is 0 to 7.

Target

Set the ID number of the MO drive, which will be connected to the 8841/42, on the SCSI bus. The ID number of the internal MO drive (optional) is set to 4. Therefore, if the internal MO drive has been mounted, the ID number 4 cannot be specified. The available value range is 0 to 7.

NOTE

- Do not set the SCSI ID of the 8841/42 and target to the same number.
- When "SCSI" or "MO" is selected as the output destination, separate destinations cannot be set for the auto save, parameter calculation result save, and **COPY** key output.

12.5.5 Setting the Internal MO (when the 9607 is installed)

Selects the internal MO drive. The internal MO drive can be treated as a drive in the PC. Refer to "14.2.1. Setting the Internal MO" for details.

OFF: The MO drive is not treated as a drive in the PC.

ON: The MO drive is treated as a drive in the PC.

NOTE

- This can be selected only when the optional 9607 MO UNIT is installed.
- When the internal MO setting is enabled (ON) and the storage destination for automatic storage is set to Internal MO, automatic storage setup is disabled.
- When the internal MO setting is enabled (ON), the internal MO media selection cannot be selected.
- The ID of the internal MO is fixed at 4.

12.5.6 Setting the LAN

(1) LAN interface

The 8841/42 MEMORY HiCORDERs provide the LAN functions below by using a LAN card inserted in the PC card slot.

Supporting the 9333

When using the HIOKI 9333 LAN COMMUNICATOR, you can remotely control the 8841 or 8842 on a PC or use the Auto Save function to save 8841/42 data on a PC via the 9333. For details, refer to the instruction manual provided with the 9333.

FTP Server

Both the 8841 and 8842 use an FTP (File-Transfer-Protocol, compliant with the RFC959) server. You can access files on 8841/42 internal media from a PC by using FTP client software.

Each medium appears as a directory on the FTP server as shown below.

```
/FD ..... Floppy disk
/MO ..... Internal MO drive
/SCSI ..... External MO drive
/STORAGE/MEM ..... binary files in storage memory
/STORAGE/TEXT ..... text files in storage memory
```

By accessing STORAGE, you can access measurement data in storage memory, such as binary/text files. (/STORAGE is read-only.)

For example, to access from an IE or other browsers (assuming a recorder IP of 192.168.0.2), enter "ftp://192.168.0.2" in the Location field. When the data is protected by a user name and password, enter the user name in NAME and the password in PASS of "ftp://NAME:PASS@192.168.0.2."

Please note that there are some restrictions.

- You cannot access a file while the 8841/42 is conducting measurement or standing by for a trigger. In such case, you must first stop measurement operation. Use one of the methods below.
 - a. Wait until measurement is completed.
 - b. Use the 9333 to stop measurement by remote control.
 - c. Use one of the following SITE commands of FTP:
 - SITE START: Starts measurement.
 - SITE STOP: Stops measurement.
 - SITE ABORT: Aborts measurement.
 - SITE STAT: Responds with the status.

("211 START" is returned when measurement is in progress and "211 STOP" when measurement is not in progress.)

Use of the SITE commands requires an FTP client that can directly send arbitrary commands to a sever.

For example, with a command-line FTP from a Windows command prompt, you can send a SITE command by using a literal command (e.g., FTP> literal SITE STOP).

- Only one connection at a time is allowed. Therefore, do not use a high-speed download tool that employs multiple connections.

- File exchange format is not specified for FTP. With some FTP clients, data in a file may not be displayed correctly or correct date and time information may not be obtained.
- The 8841/42 only support generally used FTP commands. Thus, the function of any other command used by an FTP client may not be available.

Communications Command

The 8841/42 can be operated using common RS/GPIB communications commands. The 8802 port is set as the command input port by default. To control the 8841/42, create a program and connect TCP via this port. See the Application Disk (CD-R) for details of the communications commands. Descriptions of the commands are provided in both text and HTML format.

Use the following procedure to view the HTML format descriptions:

1. When you insert the CD-R into the CD-ROM drive, the opening page should appear automatically. If it does not appear, open the "index.htm" file with your Web browser.
2. Select the language to display (click the English icon).
3. Click [INTERFACE MANUAL].
4. Click the icon for your model.

(2) Compatible LAN Card

The LAN cards below are compatible with the 8841/42. (As of April 2003)

HIOKI 9578 10BASE-T LAN CARD *1

NETGEAR FA411

For the latest information, visit the HIOKI website.

*1: Sales of the HIOKI 9578 10BASE-T LAN CARD have been discontinued. Please use the commercially available LAN cards recommended by HIOKI.

(3) Setting

This section describes the setting procedure.

Set up the 8841/42 and connect the cable in the sequence below.

1. Insert a LAN card.
2. Set up the LAN parameters in "SYSTEM 4." (Do not connect the cable yet.) For details, see "Setting Individual Parameters" below.

The screenshot shows a configuration window titled 'Interface LAN (1/2)'. It contains the following fields and controls:

- Use DHCP: OFF
- Host Name: [Redacted]
- IP Address: 0. 0. 0. 0
- Subnet Mask: 255.255.255. 0
- Gateway: OFF 0. 0. 0. 0
- Use DNS: OFF 0. 0. 0. 0
- Data Server: 0. 0. 0. 0
- Name: [Redacted]

3. After setting all the parameters, press F5 [Enter].
4. Connect the LAN cable to the 8841/42 and the network.
Be sure to make the settings above before connecting the 8841/42 to the network. Note that making these settings with the 8841/42 connected to the network may result in illegal information being sent to the network—for example, if the same IP address as that of another device on the network is selected.

Preparations for Setting Parameters

When connecting to an existing network, the following parameters must be set up. Ask the administrator (department) of the network system to assign the following in advance:

-
- DHCP: Used/not used
 - Host name and address of the 8841/42
 Host name (up to 12 characters): _____
 IP address: _.:_.:_.:_
 Subnet mask: _.:_.:_.:_
 (When using DHCP, the IP address and subnet mask are not needed.)
 - DNS setting
 DNS: Used/not used
 IP address (when using DNS): .. _.:_.:_.:_
 (The setting that can be obtained from DHCP has priority.)
 - Gateway
 Gateway: Used/not used
 IP address (when using gateway): .. _.:_.:_.:_
 (The setting that can be obtained from DHCP has priority.)
 - TCP/IP Port No.: __X (default: 880X)
 (Specify the three leftmost digits of the four digits. Numbers 0 to 9 in the least significant digit are used by the 8841/42 or reserved. Specify the port No. when default numbers 8800 to 8809 are not available.)

When setting up a network when only using a PC and recorders, not connecting to an existing network, for example, set the parameters as shown below.

IP address of PC: 192.168.0.1
 IP address of 1st recorder: .. 192.168.0.2
 2nd: 192.168.0.3
 3rd: 192.168.0.4
 4th: 192. 168.0.5

Host name: Enter the desired name (each host name must be unique).
 Subnet mask: 255.255.255.0
 Gateway: OFF
 DHCP: OFF
 DNS: OFF
 Port No.: 880x

Setting Individual Parameters

Once the LAN card is inserted, setting parameters appear on the SYSTEM 4 INTERFACE screen as shown below. Move the cursor to a parameter you want to set up. After making all necessary setting changes, press F5 [Enter] to confirm. Otherwise, the changes will not be reflected.

The screenshot shows a window titled 'interface LAN (1/2)'. It contains several configuration fields:

- Use DHCP: OFF
- Host Name: [Redacted]
- IP Address: 0. 0. 0. 0
- Subnet Mask: 255. 255. 255. 0
- Gateway: OFF 0. 0. 0. 0
- Use DNS: OFF 0. 0. 0. 0
- Data Server: 0. 0. 0. 0
- Name: [Redacted]

SYSTEM 4 INTERFACE 1/2 screen

- **DHCP ON/OFF**

Set whether to use DHCP.

DHCP enables a device to obtain its IP address or other information automatically.

When DHCP is ON and a DHCP server is running on the same network, the 8841/42 obtains its IP address and subnet mask, then is automatically set up. Any available DNS and gateway information are also obtained. (The information obtained from DHCP has priority over manually entered settings.)

- **Host Name**

Set the name to represent the 8841/42 on the network. Choose a unique name that is different from those of other devices on the network. When using the 9333 LAN COMMUNICATOR, note that the host name is used to identify a directory on the PC.

Dynamic DNS is not supported and therefore the set host name will not be registered in DNS.

- **IP Address**

Set the IP address of the 8841/42.

The IP address is used to identify individual devices on a network. Set a unique address that is different from those of other devices on the network. When DHCP is ON, it automatically sets the IP address.

- **Subnet Mask**

Subnet mask is used to divide an IP address into a network address and host address. Set the subnet mask the same way that subnet masks of other devices on the network are set up.

When DHCP is ON, it automatically sets the subnet mask.

- **Gateway ON/OFF and IP Address**

Set the default gateway (default router).

Turn this ON and specify the IP of the device serving as a gateway when the 8841/42 communicates with a device (PC) on a network other than its own network. When the PC is on the same network, use the default gateway of the PC. When the 8841/42 is connected one-to-one with a PC or both are connected to the same hub, a gateway is not necessary. Turn it off.

When DHCP is ON, any gateway information obtained from DHCP has priority.

- **DNS ON/OFF and IP Address**

Set DNS.

The IP address is a series of numbers that may be difficult to remember.

Thus, it would be easier to use a name to represent the address.

In a network with a server that searches IP addresses from names, you can request this server to look up an IP address from a name and thus specify a device by name and not by address.

There are two such servers: DNS and WINS. The 8841/42 only supports DNS. However, these units cannot perform the dynamic registration of names and IP addresses with DNS.

When DNS is ON, you can specify a device you communicate with by using a name.

When DHCP is ON, any DNS information obtained from DHCP has priority.

- **Data Acquisition Server IP and Name**

Specify the PC that runs the 9333 LAN COMMUNICATOR, with which the 8841/42 communicates. This setting is required for acquiring data using the 9333 LAN COMMUNICATOR.

When specifying with the IP address (when not using DNS), use the IP address of the PC.

When DNS is ON and you specify the PC with a name, set IP to 0.0.0.0, enter the host name of the device for which data is being collected in the name field. When the host name is "collect.hioki.co.jp," for example, do not omit ".hioki.co.jp." Otherwise, your request may not be granted. (Note that the part shown as ".hioki.co.jp" may vary depending on your network environment.)

When acquiring data using the 9333:

- To send measurement data (saved by using the Auto Save function) to the 9333, set Media on Status 1 screen to COMMUNI (LAN). (Real-time transfer of measurement data is not available.)
- To send an Auto Print image to the 9333, set Auto Print destination on Status 1 screen to COMMUNI (LAN).
- To send parameter calculation results to the 9333, set Result Save on Status 3 screen to COMMUNI (LAN).
- To send a screen image by using the **COPY** key, set Copy Destination on System 4 screen to COMMUNI (interface).
- To send a print image by using the **PRINT** key, set Output Destination on System 4 screen to COMMUNI (interface).

SYSTEM 4 INTERFACE 2/2 screen

- **Port No.**

The 8841/42 uses TCP/IP for communications. TCP/IP allows multiple connections for different types of communications. A port number identifies each connection. The 8841/42 uses port numbers 8800 to 8809.

- 8800 (8841/42 as the server.): Used by the 9333 remote control application.
- 8801 (8841/42 as the client): Used by the 9333 data acquisition application.
- 8803 (8841/42 as the server): Used with communications commands.
- 8802 to 8809: Reserved

You need not edit the port number setting, unless some ports are not available due to security reasons or not available on the PC with which the 8841/42 communicates.

This sets the three leftmost digits only. The rightmost digit (from 0 to 9) is used by the 8841/42 or reserved.

- **Delimiter and Header ON/OFF**

Used when applying control by using communications commands.

Header ON/OFF sets whether to add a header in the response to a command.

Delimiter sets whether to use LF or CR+LF for the response to a command.

Both LF and CR+LF are accepted in command transmission.

Communications commands are transmitted by connecting to port 8802 (default) of the 8841/42 using TCP and sending a character string.

- **FTP User Name and Password**

Used for authentication when logging into FTP of the 8841/42. When a user name and password are set, you cannot log in unless the user name and password are correct.

If you leave these settings blank, authentication will not be performed and anyone can log in.

Also leave both settings blank when using an anonymous FTP client.

- **FTP Access Control**

This controls access from an external source. Select from the following:

"Read-only": An external device can only read files.

"Read/write-enable": An external device can read, write, or delete files.

(4) Connecting

After completing the setting above, connect the devices.

- Connecting the 8841/42 to an existing network
Connect the LAN connector of the 8841/42 to the hub using a straight LAN cable or the 9642 LAN cable.
- Connecting the 9941/42 to a PC one-to-one

A cross cable or straight cable and a cross connector are required. (The 9642 straight cable is supplied with a cross connector.)

A 100BASE cable is required for connecting to a 100BASE network using the 100BASE card.

12.6 INITIALIZE Screen

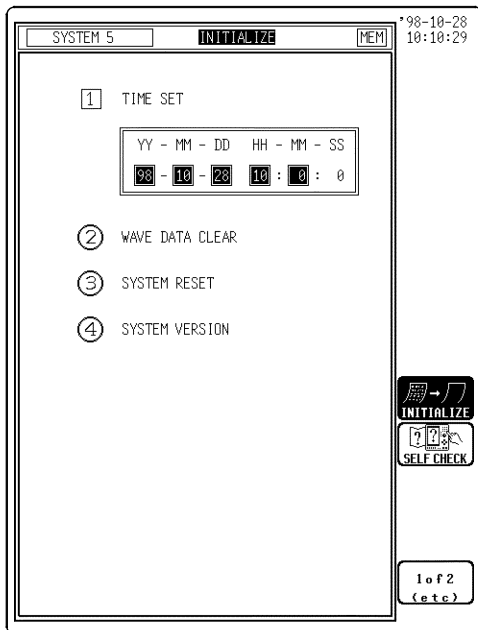

Procedure Screen: INITIALIZE (SYSTEM5)

1. Press the **SYSTEM** key to display the INITIALIZE screen.
2. Move the flashing cursor, want to set the item.
3. Use the function keys to make the selection.

TIME SET	See Section 12.6.1
WAVE DATA CLEAR	See Section 12.6.2
SYSTEM RESET	See Section 12.6.3
SYSTEM VERSION	See Section 12.6.4

12.6.1 Setting the Clock

This unit incorporates a calendar with automatic leap year compensation and 24-hour clock. The clock is used for the following functions:

- Timer trigger function
- Trigger time list printout

Procedure

1. Move the flashing cursor to the year, month, day, hour, minute items of **TIME SET**, and use the Jog/Shuttle control or the function keys to make the settings.
2. Press the **(exec)** function key to start the clock. Seconds are reset to 00.
3. For correcting errors of less than 1 minute.
Press **30 sec adjust** to make the setting.
When 30 s adjustment is pressed, the seconds are handled as follows.
00 to 29 seconds: Minutes are unchanged and seconds are reset to 00.
30 to 59 seconds: Minutes are advanced by 1 and seconds are reset to 00.

12.6.2 Clearing the Waveform Data

Clears and initializes waveform data stored in memory.

Procedure

1. Move the flashing cursor to **WAVE DATA CLEAR**, and make the setting.
2. Press the **(exec)** function key.

12.6.3 System Reset

- Resets all settings (except communication settings; GP-IB, RS-232C, SCSI, LAN) the factory default values.
- The same effect can be achieved by turning power to the unit on while holding down the **STOP** key.

Procedure

1. Move the flashing cursor to the **SYSTEM RESET** item, and make the setting.
2. Press the **(exec)** function key.

All Reset:

To return all settings including communications settings to the original factory settings, turn on power while holding down both the **START** key and **STOP** key.

12.6.4 List System Configuration

- The programmed optional configurations and software versions are displayed.
- You can also view each system configuration from the opening screen.

Procedure

1. Move the flashing cursor to the **SYSTEM VERSION** item, and make the setting.
2. Press the **(exec)** function key.

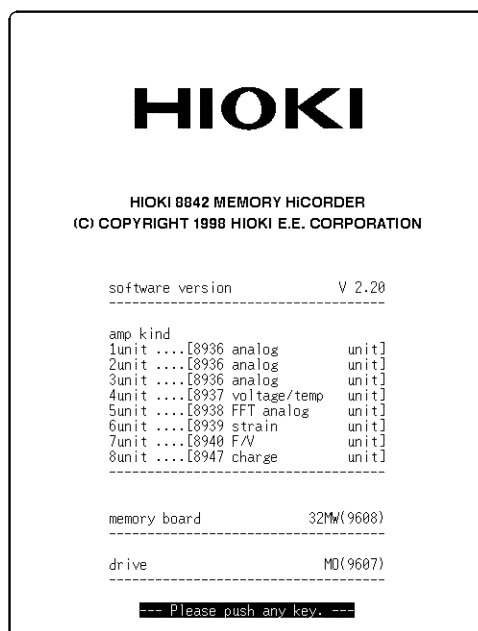

NOTE

The 8946 4ch ANALOG UNIT is designed for use with the 8841. If this channel is used with the 8842 powered on, "ERR" appears in the opening screen, indicating that the position at which the channel is connected is incorrect, while the system configuration list screen displays "none."

12.7 Self-check

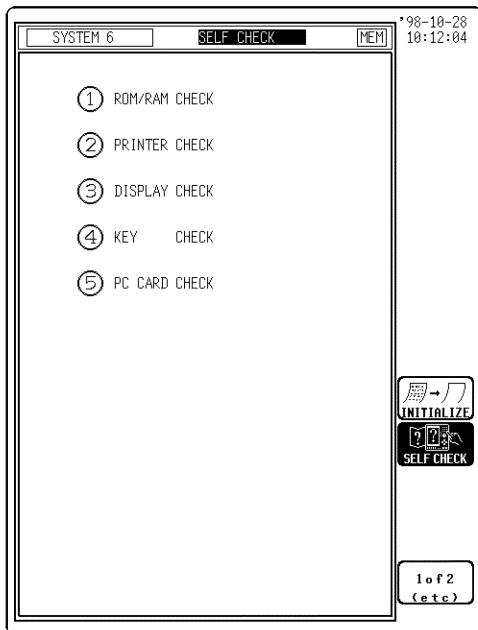

Procedure Screen: SELF CHECK (SYSTEM6)

1. Press the **SYSTEM** key to display the SELF CHECK screen.
2. Move the flashing cursor to set the item.
3. Use the function keys to make the selection.

12.7.1 ROM/RAM Check

- This test checks the internal memory (ROM and RAM) of the 8841/42.
- The test is non-destructive; it does not affect the contents of RAM.
- The result is displayed as follows. OK: Passed, NG: Failed

Procedure Screen: SELF CHECK

1. Move the flashing cursor to the **ROM/RAM CHECK** item.
2. Press the **(exec)** function key to check the ROM and RAM. During the test, all keys are disabled.
The device version is displayed at the upper right of the screen during ROM/RAM check.
3. When the test is completed, press any key to return to the self-test setting screen.

12.7.2 Printer Check

- This test checks the printer operation.
- The printer head is cleaned.

- #### Procedure
1. Move the flashing cursor to the **PRINTER CHECK** item.
 2. Press the **(exec)** function key to check the check the printer operation.
To cancel the test pattern printout, press the **STOP** key.
 3. Press the **cleaning** function key to clean the printer head. Hold down this key for about five seconds.

12.7.3 Display Check

- This test checks the display.
- Two check patterns (solid-color display check and gradation check) are available.

- Procedure**
1. Move the flashing cursor to the **DISPLAY CHECK** item.
 2. Press the **(exec)** function key to check the display.
Press any key to move to the next check.
 3. When the test is completed, press any key to return to the self-test setting screen.

12.7.4 Key Check

This test checks the key operation.

- Procedure**
1. Move the flashing cursor to the **KEY CHECK** item.
 2. Press the **(exec)** function key to start the test.
 3. Press any key on the front panel, and the corresponding field on the display changes to reverse. Turn the Jog/Shuttle control at least one turn fully clockwise and counterclockwise and press each of the keys at least once, and the test is completed.

NOTE

- If any key is defective, the key test cannot be completed normally.
- In this case, press the **START** key and the **STOP** key together to return to the self-test setting screen.
- The **START** key and Select key serve for testing the LED function.

12.7.5 PC Card Check

This test checks the PC card.

- Procedure**
1. Move the flashing cursor to the **PC CARD CHECK** item.
 2. Press the **(exec)** function key to check the PC card.
Check the type, capacity, and battery condition of the card.
OK (normal): The data is still in memory. The battery does not need replacement.
 3. When the test is completed, press any key to return to the self-test setting screen.

NOTE

- In the case of the interface card, its identification is displayed.

Chapter 13

Printout of Measurement Data

Waveform data can be printed out in two formats: waveform or numeric. Seven different procedures can be used to print out the measured waveforms. On the printer, the print density can be changed in five steps.

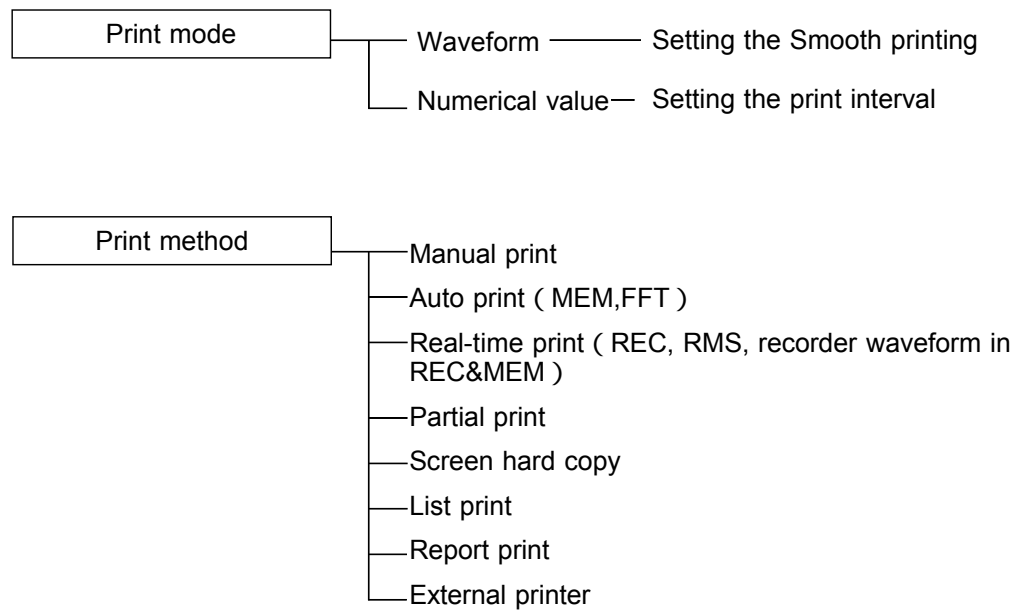

NOTE

- For an example of printout, see Section 13.5.
- The device from which the screen data is printed out can be selected using Interface (SYSTEM4).

13.1 Printout of Measurement Data Operating Procedure

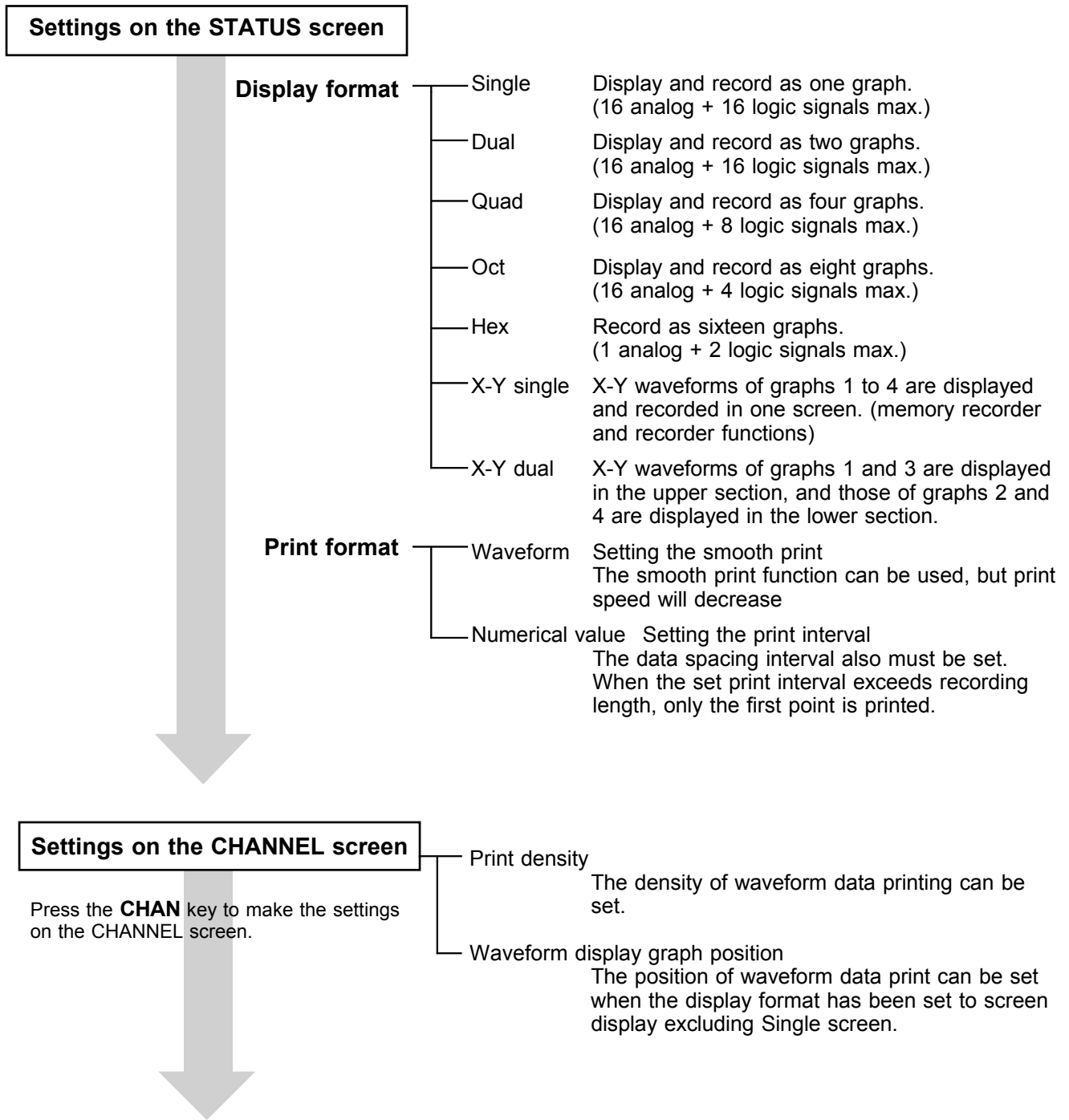

Settings on the SYSTEM screen

Press the **SYSTEM** key to make the settings on the SYSTEM screen.



- SETUP
 - Grid type
 - Channel marker
 - Time value
 - List & Gauge
 - Printer density
 - Upper-lower print
 - 0 position comment
 - Counter print
- SCALING — The printout will use the scaled gauge. See Section 9.8.
- COMMENT — Two types of comments - title comments and channel-by-channel comments - may be superimposed on a graph. See Section 9.9.
- INTERFACE
 - Output destination by COPY
 - Output destination by PRINT
 Output destination is set by PRINT or COPY. To print with the unit, set to "INTERNAL PRINTER".

Printing

- Manual print — This mode serves to print waveform data from the internal memory.
- Auto print — Printout is carried out automatically after a waveform has been captured for the specified recording length. (MEM,FFT)
- Real-time print — The input waveform and data are printed out continuously in real time. (REC and RMS, recorder waveform in REC&MEM)
- Partial print — This function prints the waveform between the A and B cursors (vertical or trace cursors).
- Screen hard copy — The display contents of the all screens can be printed out as is.
- List print — The settings for the various functions made with the STATUS screen, CHANNEL screen etc. can be printed out in list format.
- Report print — This function prints the waveform range shown on the display, upper-lower value, analog channel along with the active settings.
- External printer — Using the 9559 PRINTER CARD, waveform data can be output on A4-size sheets from the external printer in color or monochrome.

13.2 Setting the STATUS Screen (printout)





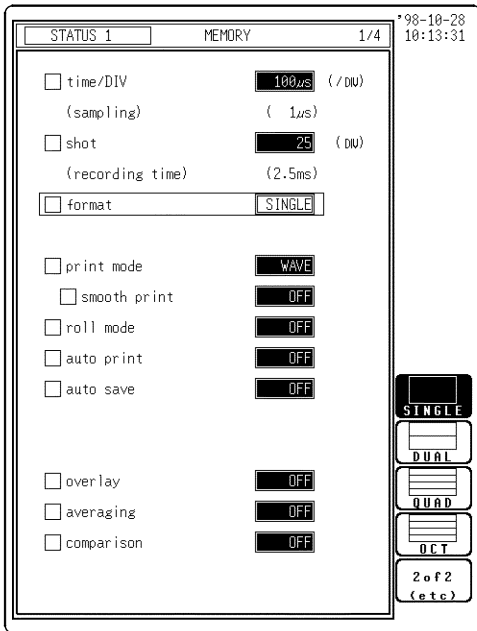

13.2.1 Setting the Display Format

- The style can be set for showing input signals on the screen display and recording them on the printer.
- The styles single, dual, quad, oct (Waveform display screen), hex (Print only, Display oct style) X-Y single, X-Y dual (dot/line) are available.



Procedure Screen: STATUS

1. Press the **STATUS** key to display the STATUS screen.
2. Move the flashing cursor to the **format** item, as shown in the figure on the left.
3. Use the function keys to select the display format.

Function display	Meaning
	: Display and record the waveform in one graph.
	: Display and record the waveform in two graphs.
	: Display and record the waveform in four graphs.
	: Display and record the waveform in oct graphs.
	: The display format is the same as for an 8-part screen, but waveforms may be printed from 16 graphs.
	: X-Y waveforms of graphs 1 to 4 are displayed in one screen.
	: X-Y waveforms of graphs 1 and 3 are displayed in the upper section, and those of graphs 2 and 4 are displayed in the lower section.

NOTE

X-Y screen can be set the memory recorder function and Recorder function.

13.2.2 Setting the Print Mode

Select the format, waveform, or numerical value should be used to output measured data and calculation results.

Waveform The smooth print function can be used, but print speed will decrease. (MEM, memory waveform in REC&MEM)

Numerical value The data spacing interval also must be set.

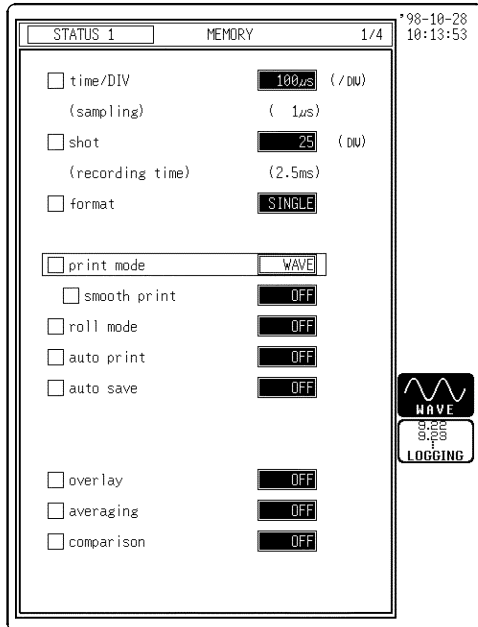

Procedure

Screen: STATUS (in Recorder/RMS function),
STATUS1 (in Memory recorder/REC&MEM function),
STATUS2 (FFT)

(1) Set the Print mode.

1. Press the **STATUS** key to display the STATUS screen.
2. Move the flashing cursor to the **print mode** item.
3. Use the function keys to make a setting.

Function display

Meaning



: Measurement data and the result of calculation are printed as a waveform.

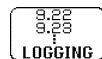

: Measurement data and the result of calculation are printed as numeric data.

(2) Set the Smooth printing and print interval.

1. When "WAVE" is selected in step (1), determine whether to use the smooth printing or not. (in Memory recorder function, memory waveform in REC&MEM function)
 When "LOGGING" is selected, set the print interval. (unit: DIV, in FFT number of points)
2. Move the flashing cursor to the "smooth print" or "interval" item.
3. Use the function keys to make the selection.
 Since 1 division represents 100 samples, the print interval "0.01" refers to a printout of every sample (no print interval). If the set print interval exceeds recording length, only the first point is printed.

NOTE

- On X-Y screen, smooth printing cannot be specified.
- In recorder function and recorder waveform in REC&MEM function, the trigger mark (T) is written as the start position mark. In an additional recording, the trigger mark is displayed in front of the most recently entered data.
- When recorder function or RMS recorder function (excluding 5 s/DIV) and recorder waveform in REC&MEM function, the maximum and minimum values are printed (see Appendix 3.4 or 3.5).
 The print intervals of 0.01 to 0.5 DIV can be selected, only when there are waveform data present.

13.3 Setting the CHANNEL Screen (printout)

13.3.1 Setting the Print Density

If the data is to be output on the internal printer, any of four print densities may be set for twelve waveform display colors. The set print density determines waveform density on printouts or hard copies.

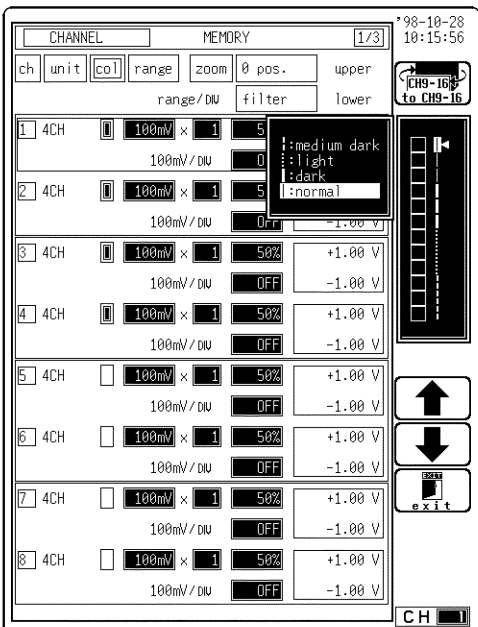
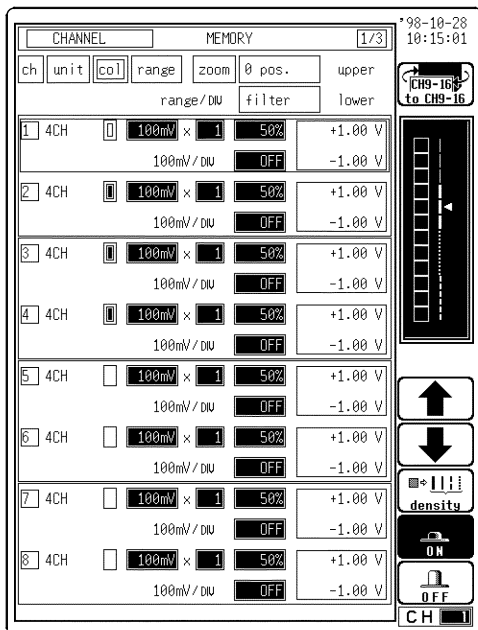

Procedure Screen: CHANNEL

1. Press the **CHAN** key to display the CHANNEL screen.
2. Use the **CH.SET** key to display desired channel screen.
3. Move the flashing cursor to the position of color to be set.
4. Use the function keys to select **density**.

Function display Meaning



: Move the cursor up in the selection window.



: Move the cursor down in the selection window.

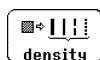

: Enter the print density setting screen.



: Waveform is performed.



: Waveform is not performed.

5. Use the function keys or Jog/Shuttle control, set print density

Function display Meaning



: Select the print density.

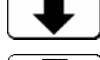

: Exit from the print density mode.

6. Set the channels 2 to 16 in the same way.

- If the system is reset, print density returns to its previous setting.
- If the analog channel comment is set to "SETTING" or "SET & COM," the analog channel print density () is output during printing.

13.3.2 Setting the Waveform Display Graph Position

Set which graph type to use when display format has been set to DUAL, QUAD, OCT or HEX screen display on the STATUS screen.

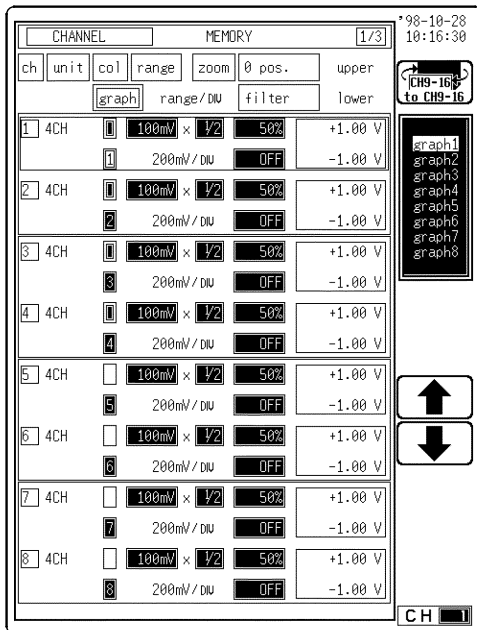

Procedure Screen: CHANNEL

1. Press the **CHAN** key to display the CHANNEL screen.
2. Use the **CH.SET** key to display the desired channel screen.
3. Move the flashing cursor to the position of the graph to be set.
4. Use the function keys or Jog/Shuttle control to make the selection.

Function display	Meaning
	: Move the cursor up in the selection window.
	: Move the cursor down in the selection window.



: Move the cursor up in the selection window.



: Move the cursor down in the selection window.

NOTE

For the X-Y screen (memory recorder and recorder) display format, see the X-Y recorder setting for each function.

13.4 Setting the SYSTEM Screen (printout)

13.4.1 SET UP Screen (SYSTEM 1)

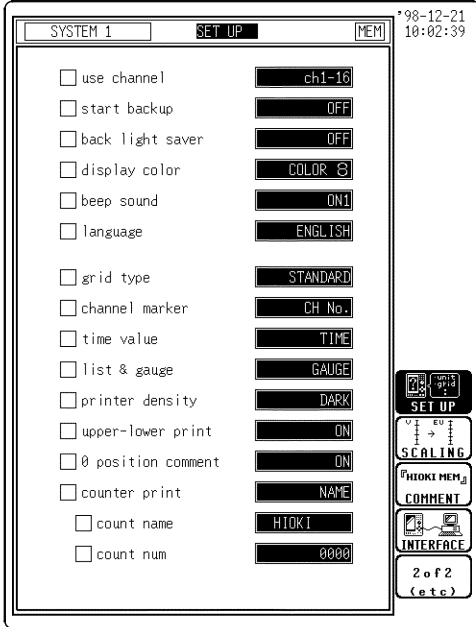

Procedure Screen: SETUP (SYSTEM1)

1. Press the **SYSTEM** key to display the SET UP screen.
2. Move the flashing cursor to desired item.
3. Use the function keys to make the selection.

For details, see Section 13.5.

In FFT function, the setting of the channel marker, time axis display, upper and lower limits of printing, zero position comment, and counter printing cannot be made.



- Grid Type**
- Selects the type of grid shown on the Waveform display screen and drawn on the recording paper.
 - On the waveform display screen, the standard and fine grids are defined as the standard, and the standard (dark) and fine (dark) grids are defined as the standard (dark) grids.
 - "Time" and "Time (dark)" can be set only during printing.







In printing in the X-Y screen format or FFT function, the standard time axis and the standard time axis (dark) are applied.

Channel Marker





The channel numbers or the comments are printed together with the waveform on the recording paper. Comments can be set on SYSTEM3 (COMMENT) screen.

Function display	Meaning
	: Channel numbers will not be printed for the waveform on the recording paper.
	: Channel numbers will be printed for the waveform on the recording paper.
	: Comments will be printed for the waveform on the recording paper.

Time Value The time from the trigger point and other information can be printed.

Function display	Meaning
	: Displays the time from the trigger point (unit: fixed).
	: Displays the time from the trigger point (unit: base 60).
	: Displays the number of DIV from trigger point.
	: Displays the time when a waveform is captured.



List & Gauge When a waveform is printed out (except for screen hard copies), the gauge can be printed out at the beginning, and a listing can be printed out at the end.

Function display	Meaning
	: No gauges or listing
	: Prints listing only.
	: Prints gauges only.
	: Prints both gauges and listing.

Printer Density Serves to set the printer density. Select the setting which yields the most easy to read printout.





Upper-lower Values Print In waveform printing, the upper and lower values of each channel are printed first. When the scaling function is being used, the scaled values are printed.

Function display	Meaning
	: Upper-lower values are not printed.
	: Upper-lower values are printed.

0 position Comment



In waveform printing, comments are printed out in the zero position of each channel. This comment printing is valid only for the analog channels.

Comments can be set on SYSTEM3 (COMMENT) screen.

Function display	Meaning
	: 0 position comment is not used.
	: 0 position comment is used.

Counter Print

In waveform printing, the counter can be printed out. This function is useful to distinguish between similar waveforms.

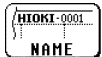
Function display	Meaning
	: Counter Print is not printed.
	: Counter Print is printed with date.
	: Counter Print is printed with counter name.

- A counter name of up to ten characters can be specified. For information on how to enter the counter name, see Section 9.9.3.
- After the unit is turned on, the counter is reset to 0 (zero), and the counter value is increased each time a waveform is retrieved. (The maximum counter value is 9999.) To initiate waveform acquisition from an arbitrary count value, move the flashing cursor to the counter-value entry field and specify the desired value using the function keys or the Jog/Shuttle control.

13.4.2 SCALING Screen (SYSTEM 2)

- The scaling function can be used to convert an output voltage from a sensor or similar into a physical quantity.
- Two types of scaling functions are available.
- The gauge scale (maximum and minimum values of vertical axis) and A•B cursor measurement values are displayed in the scaled units.
- Scaling can be performed for every channel.

NOTE

For details, see Section 9.8.

13.4.3 COMMENT Screen (SYSTEM 3)

Three types of comment are available.

If "COMMENT" or "SET & COM" is selected, this comment will be included on the recording paper in all functions.

NOTE

For details, see Section 9.9.

13.4.4 Setting the Output Destination by the COPY Key

To output data with the 8841/8842 printer, set destination to "Internal Printer". When the external printer, see Section 13.7, "External Printer".

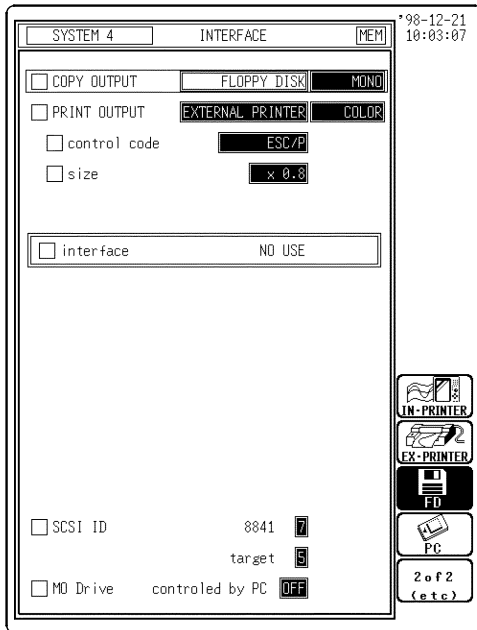

Procedure Screen: INTERFACE (SYSTEM4)

1. Press the **SYSTEM** key or function key to display the INTERFACE screen.
2. Move the flashing cursor to the position shown in the figure on the left.
3. Use the function key to make a setting.

▪ Selecting the copy destination

Function display

Meaning



: Output to internal printer.



: Output to external printer.



: Save bitmap file to FD.

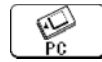

: Save bitmap file to a PC card.



: Send the data displayed on-screen to the interface.

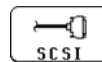

: Save the data displayed on-screen in BMP format to an external storage device attached to the SCSI port.



: Save bitmap file to the internal MO.

▪ Selecting the control code.

(When the output destination is set to external printer)

Function display

Meaning

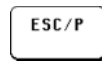

: Use the ESC/P as a control code.



: Use the ESC/P raster as a control code.

▪ Selecting the color of the output destination

(When the output destination is set to other than internal printer)

Function display

Meaning



: Output data in color.



: Output data in gray scale. (This setting is disabled for external printers.)



: Output data in monochrome.



: Output data in inverted monochrome.

NOTE

- If the files are output to floppy disks or PC cards and the output is in monochrome, the screen displays in monochrome during data storage.
- Using the **COPY** key, output may be set to the internal printer, external printer, floppy disk, PC card, interface, MO disk, or external SCSI storage device.
- Refer to the printer operating manual for the control codes.
- Files stored in BMP format cannot be read by the 8841/42.

13.4.5 Setting the Output Destination by the PRINT Key

To output data with the 8841/8842 printer, set destination to "Internal Printer". To use the external printer to output, see Section 13.7, "External printer."

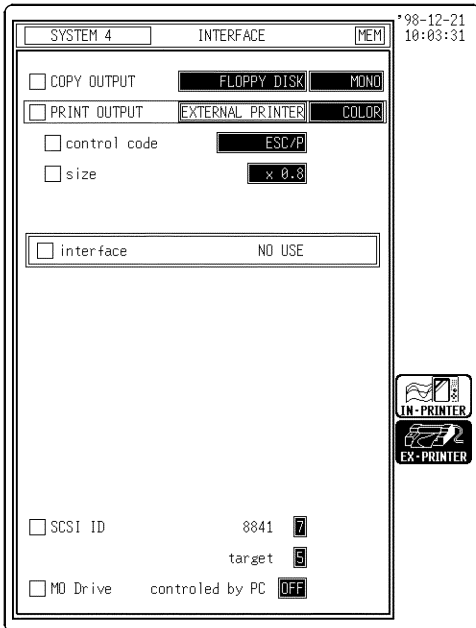

Procedure Screen: INTERFACE (SYSTEM4)

1. Press the **SYSTEM** key or function key to display the INTERFACE screen.
2. Move the flashing cursor to the position shown in the figure on the left.

3. Use the function key to make a setting.

- Selecting the output destination

Function display Meaning



: Output to the internal printer.



: Output to the external printer.

- Selecting the control code.

(When the output destination is set to external printer)

Function display Meaning



: Use the ESC/P as a control code.



: Use the ESC/P raster as a control code.

- Selecting the color of the output destination
(When the output destination is set to external printer)

Function display Meaning



: Output data in color.



: Output data in monochrome.

- Selecting the print size

(When the output destination is set to external printer)

Function display Meaning

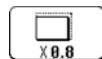

: Data is printed in the 0.8 size

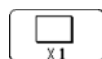

: Data is printed in the 1 size

- **Setting the indent width (when external printer setting)**

When the output destination is set to external printer, and data is printed in the $\times 1.0$ setting, the top of the waveforms may not be printed by some printers. In this case, set the size to $\times 0.8$. However, if you would still like to print in the $\times 1.0$ setting, adjust the indent width between 0 and 10 mm to print either the upper or lower portion, whichever you consider more important.

NOTE

- Even if the **PRINT** key sets output to an external printer, auto-print and real-time printing will be unavailable. Use the internal printer.
- Refer to the printer operating manual for the control codes.

13.5 Example of Printer Output

This section explains the printer type and how to read the printout (in the case of a SINGLE format display screen).

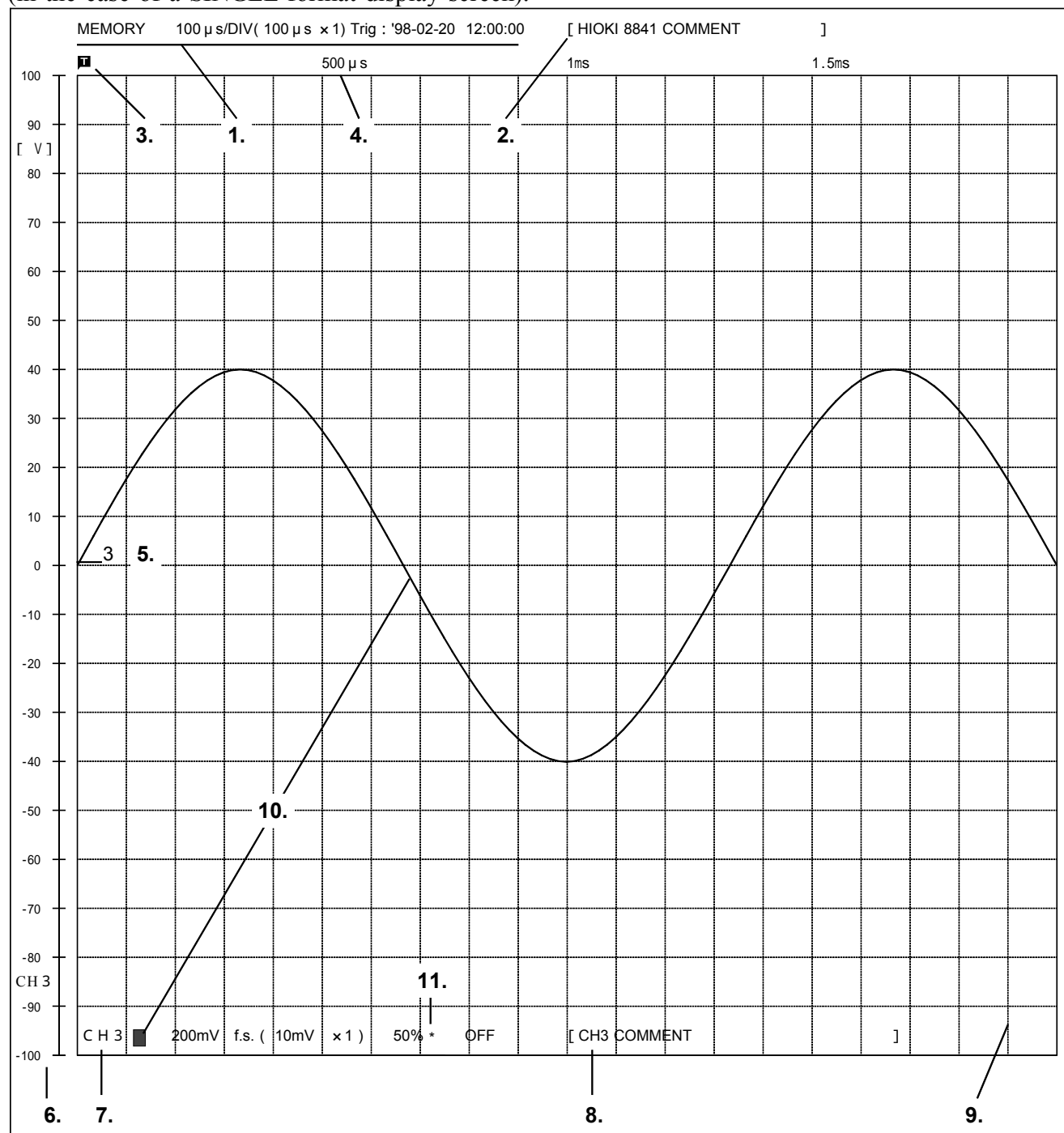

- | | |
|---|--|
| 1. Title (SETTING) (See Section 9.9) | 6. Gauge (List & gauge) (See Section 13.4.1) |
| 2. Title (COMMENT) (See Section 9.9) | 7. Analog (SETTING) (See Section 9.9) |
| 3. Trigger mark (See Section 10.5) | 8. Analog (COMMENT) (See Section 9.9) |
| 4. Time value (TIME) (See Section 13.4.1) | 9. Grid type (STANDARD) (See Section 13.4.1) |
| 5. Channel marker (CH.No.) (See Section 13.4.1) | 10. Print density (See Section 13.3.1) |
| | 11. Offset cancel (ON) (See Section 9.5.2) |

Advanced settings

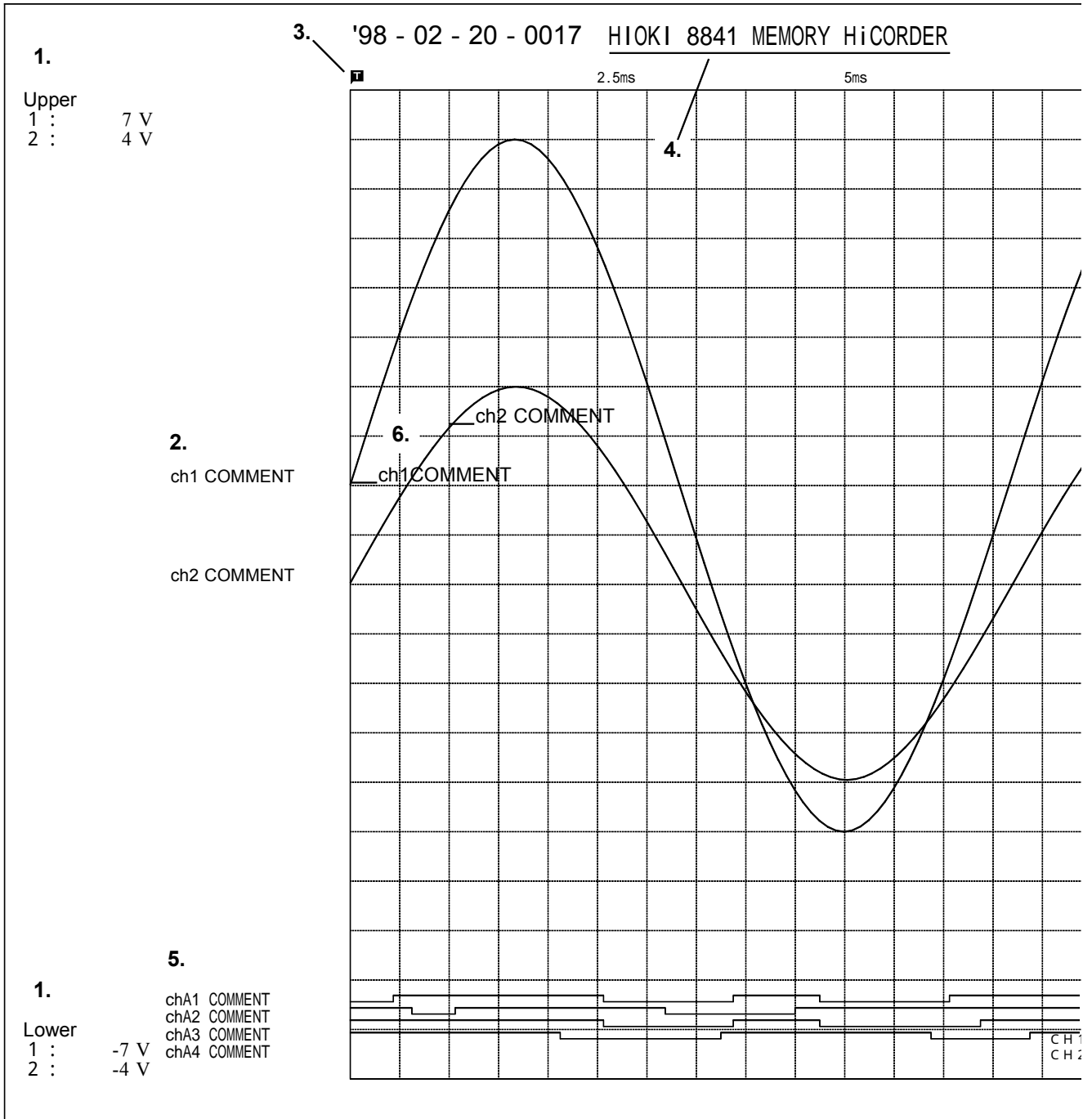

1. Upper-lower print (ON) (See Section 13.4.1)
2. 0 position comment (ON) (See Section 13.4.1)
3. Counter print (DATE) (See Section 13.4.1)
4. Title (COMMENT) (See Section 9.9)
5. Logic (COMMENT) (See Section 9.9)
6. Channel marker (COMMENT) (See Section 13.4.1)

NOTE

- The gauge, upper and lower limits, and 0 position comments are printed out in this order. Since the 0 position and logic channel comments are printed out in the same space, the positions must be specified so that these comments will not overlap each other.
- If 0 position comments are printed on channels having the same 0 position, the printed comments will overlap each other.

Printing the List (MEM)

HIOKI 8841MEMORY HiCORDER

Trig-time: ' 9 8-0 9-2 3 12:00:00

STATUS			
Function :	MEMORY	Memory div :	OFF
Time/DIV :	100 μs		
Shot :	20DIV	Averaging :	OFF
Format :	SINGLE	Wave comparison :	OFF
Roll mode :	OFF	Measurement :	OFF
Print mode :	WAVE	Wave calculation :	OFF
Smooth print :	OFF		
Auto print :	OFF		
Auto save :	OFF		
Overlay :	OFF		

SYSTEM			
Use channel :	ch1-16	Grid type :	STANDARD
Start back up :	OFF	Channel maker :	COMMENT
Back light saver :	OFF	Time value :	TIME
Display color :	COLOR 8	List & Gauge :	OFF
Beep sound :	ON		
Language :	ENGLISH	Print density :	STANDARD
		Upper-lower print :	OFF
		0 position comment :	OFF
		Counter print :	OFF

CHANNEL						
ch.	draw graph	range	zoom (/DIV)	zero pos.	filter	(lower ~ upper)
1 : C 1 -		500 μV	×1(500 μV)	50%	500Hz	(-5mV ~ 5mV)
2 : C 2 -		500 μV	×1(500 μV)	50%	500Hz	(-5mV ~ 5mV)
3 : C 3 -		10mV	×1(10mV)	50%	OFF	(-100mV ~ 100mV)
4 : C 4 -		10mV	×1(10mV)	50%	OFF	(-100mV ~ 100mV)
5 : C 5 -		10	×1(10mV)	50% K	OFF	(-100mV ~ 100mV)
6 : C 6 -		10	×1(10mV)	50% J	OFF	(-100mV ~ 100mV)
7 :	OFF					
8 : C 6 -		10mV	×1(10mV)	50%*	OFF	(-100mV ~ 100mV)
9 :	OFF					
10 :	OFF					
11 :	OFF					
12 :	OFF					
13 :	OFF					
14 :	OFF					
15 :	OFF					
16 :	OFF					

Offset cancel function
Offset cancel: ON

Logic	position	display color	Logic	position	display color
A :	POS. 1	- - - -	B :	POS. 2	- - - -
C :	POS. 3	- - - -	D :	POS. 4	- - - -

TRIGGER	
Trig-mode :	AUTO Pre-trig: 0%
Trig-source :	OR
1 :	OFF
2 :	OFF
3 :	LEVEL level:0.000V slope: filter:OFF
4 :	OFF
8937 UNIT	
Digital filter: ON	
8937 UNIT	
Drift compensation: ON	
8938 UNIT	
Anti-aliasing filter: ON	
A : OFF B : OFF	
C : OFF D : OFF	
External : OFF Manual : OFF	
Timer-trig : OFF	

Dual Screen

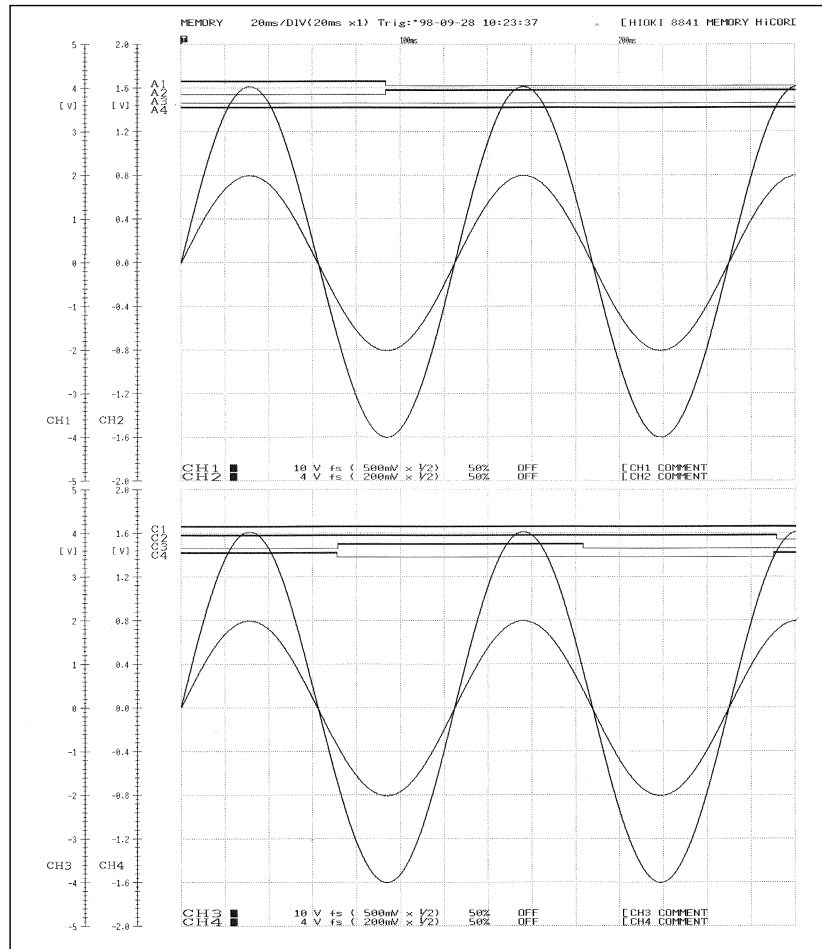

Quad Screen

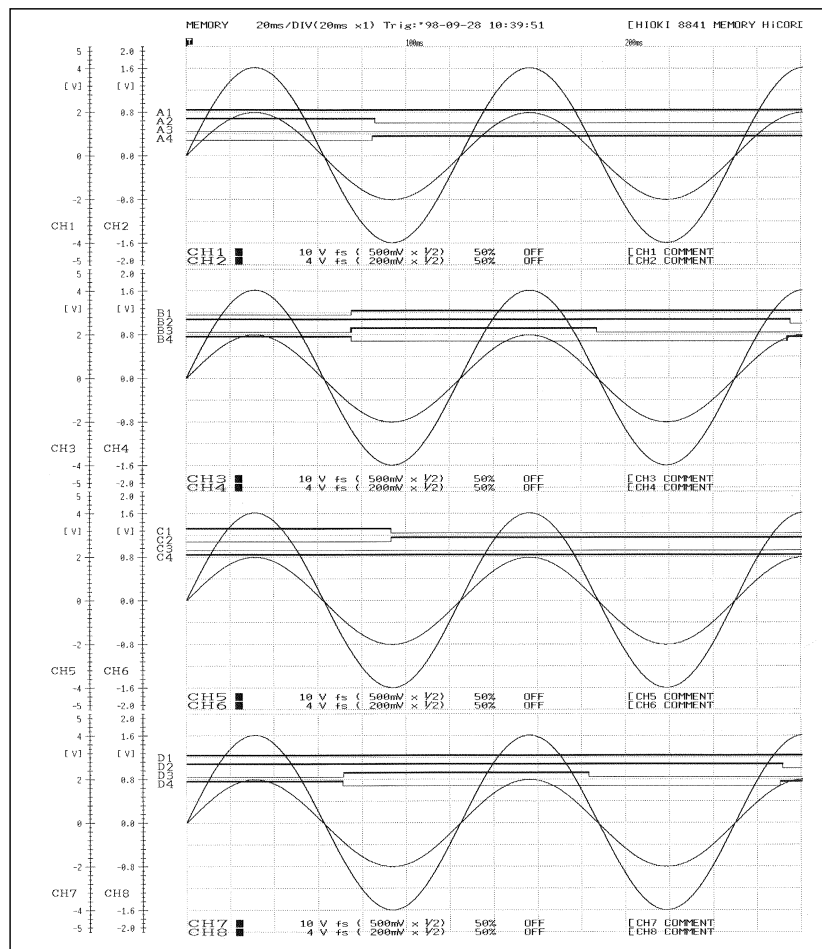

Oct Screen

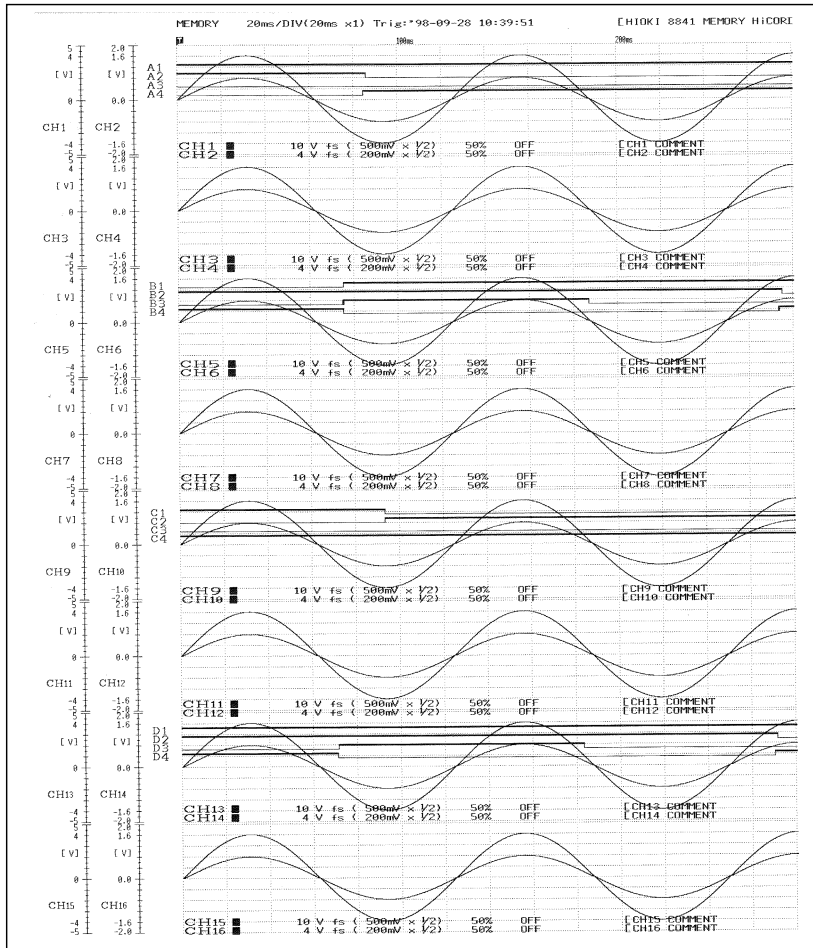

Hex Screen

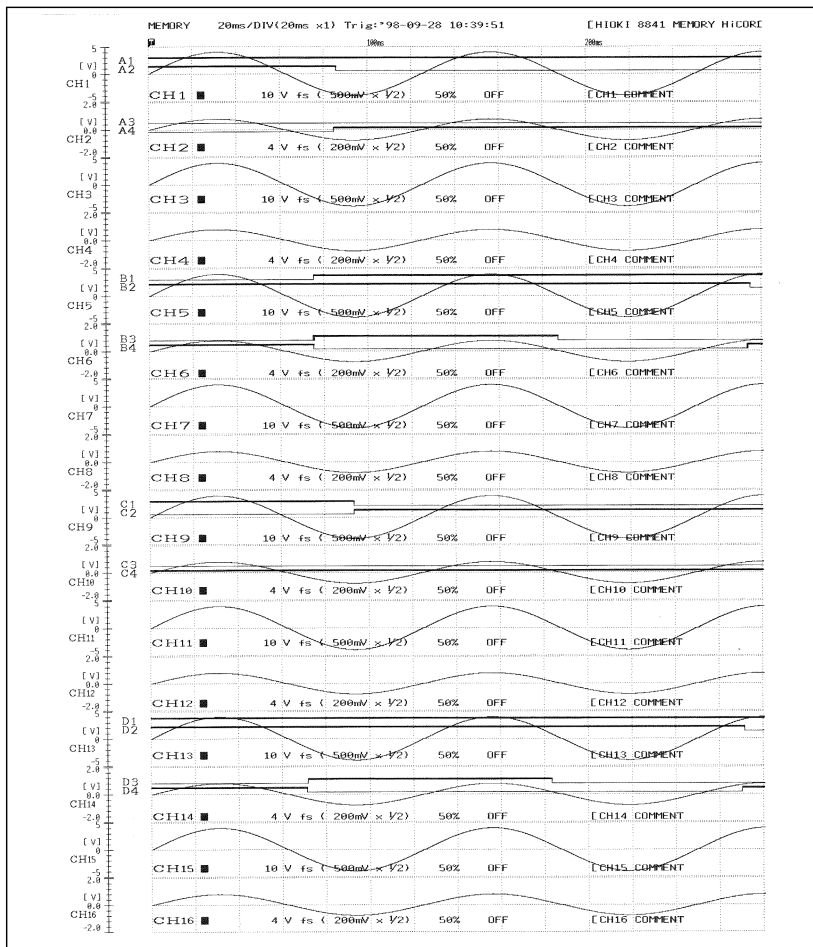

X-Y Single Screen

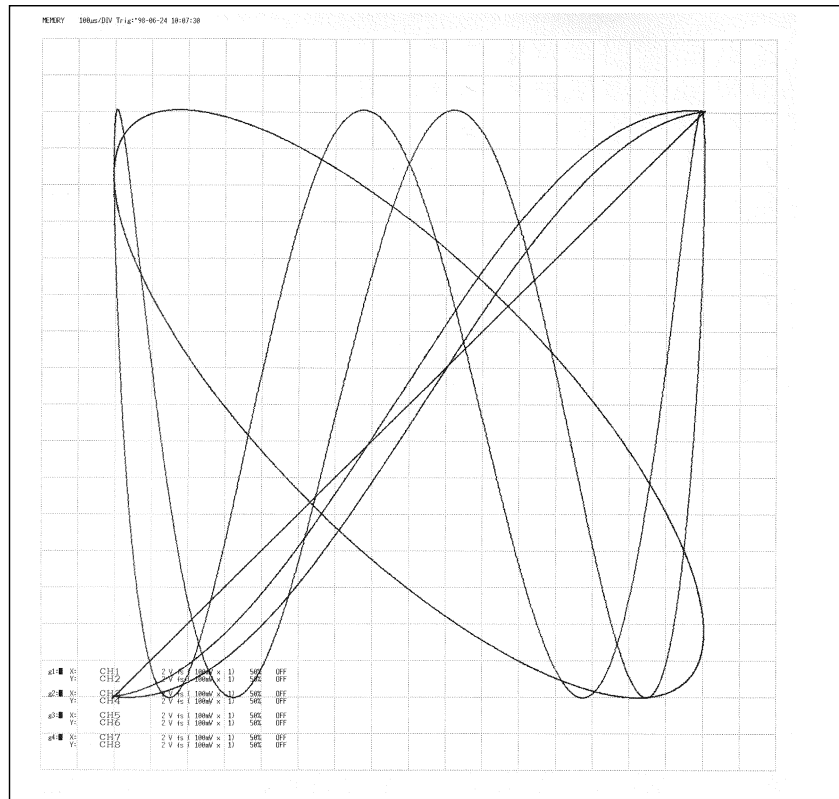

X-Y Dual Screen

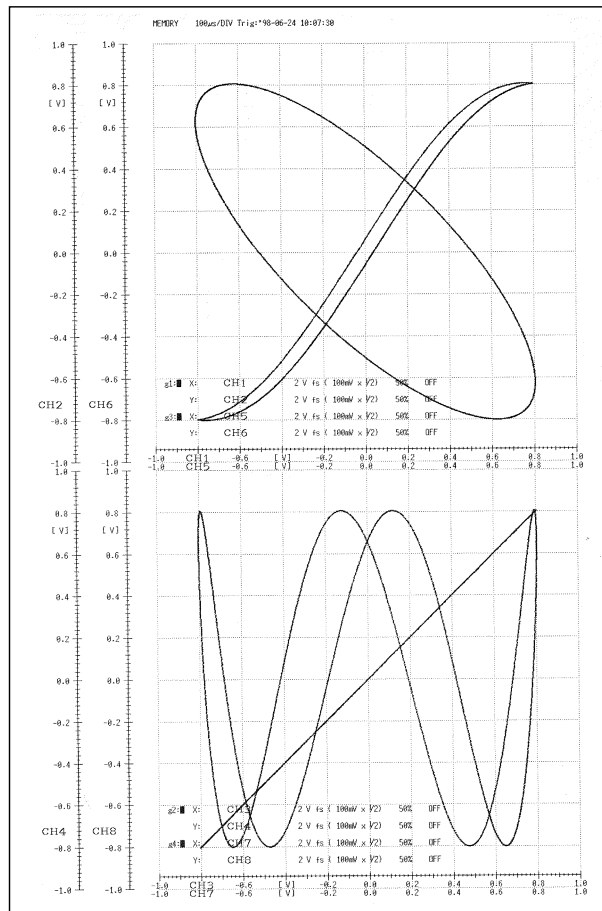

Print mode: LOGGING (MEM)

Trig: time: *98-09-28 10:39:51
 Title: HICK1 8841 MEMORY RECORDER
 Comment: CH1: CH1 COMMENT CH2: CH2 COMMENT CH3: CH3 COMMENT CH4: CH4 COMMENT CH5: CH5 COMMENT CH6: CH6 COMMENT CH7: CH7 COMMENT CH8: CH8 COMMENT CH9: CH9 COMMENT CH10: CH10 COMMENT CH11: CH11 COMMENT CH12: CH12 COMMENT CH13: CH13 COMMENT CH14: CH14 COMMENT CH15: CH15 COMMENT CH16: CH16 COMMENT

(time)	CH1 CH9	CH2 CH10	CH3 CH11	CH4 CH12	CH5 CH13	CH6 CH14	CH7 CH15	CH8 CH16	1A4	1B4	1C4	1D4
0 s	31.25mV 31.25mV	0 V 0 V	37.5mV 37.5mV	0 V 0 V	12.5mV 12.5mV	-5mV -5mV	31.25mV 31.25mV	0 V 0 V	1100	0101	1001	1101
10.0ms	1.975 V 1.975 V	387.5mV 387.5mV	1.9625 V 1.9625 V	382.5mV 382.5mV	1.95 V 1.95 V	380mV 380mV	1.9688 V 1.9688 V	385mV 385mV	1100	0101	1001	1101
20.0ms	3.425 V 3.425 V	675mV 675mV	3.425 V 3.425 V	672.5mV 672.5mV	3.4062 V 3.4062 V	677.5mV 677.5mV	3.4188 V 3.4188 V	677.5mV 677.5mV	1100	0101	1001	1101
30.0ms	4.8312 V 4.8312 V	797.5mV 797.5mV	4.8375 V 4.8375 V	797.5mV 797.5mV	4.825 V 4.825 V	795mV 795mV	4.8188 V 4.8188 V	797.5mV 797.5mV	1100	0101	1001	1101
40.0ms	3.6563 V 3.6563 V	720mV 720mV	3.6563 V 3.6563 V	717.5mV 717.5mV	3.65 V 3.65 V	722.5mV 722.5mV	3.6375 V 3.6375 V	715mV 715mV	1100	0101	1001	1101
50.0ms	2.3688 V 2.3688 V	460mV 460mV	2.375 V 2.375 V	460mV 460mV	2.3813 V 2.3813 V	465mV 465mV	2.35 V 2.35 V	460mV 460mV	1100	0101	1001	1101
60.0ms	506.25mV 506.25mV	85mV 85mV	580mV 580mV	87.5mV 87.5mV	512.5mV 512.5mV	92.5mV 92.5mV	493.75mV 493.75mV	87.5mV 87.5mV	1100	0101	1001	1101
70.0ms	-1.4688 V -1.4688 V	-387.5mV -387.5mV	-1.4688 V -1.4688 V	-387.5mV -387.5mV	-1.4688 V -1.4688 V	-385mV -385mV	-1.4875 V -1.4875 V	-385mV -385mV	1100	0101	1001	1101
80.0ms	-3.8875 V -3.8875 V	-630mV -630mV	-3.8812 V -3.8812 V	-630mV -630mV	-3.8812 V -3.8812 V	-625mV -625mV	-3.1 V -3.1 V	-627.5mV -627.5mV	1100	1110	1001	1110
90.0ms	-3.9313 V -3.9313 V	-797.5mV -797.5mV	-3.9313 V -3.9313 V	-795mV -795mV	-3.9438 V -3.9438 V	-797.5mV -797.5mV	-3.9438 V -3.9438 V	-797.5mV -797.5mV	1001	1110	1001	1110
100.0ms	-3.7938 V -3.7938 V	-770mV -770mV	-3.8 V -3.8 V	-770mV -770mV	-3.8125 V -3.8125 V	-770mV -770mV	-3.8063 V -3.8063 V	-770mV -770mV	1001	1110	0101	1110
110.0ms	-2.7125 V -2.7125 V	-552.5mV -552.5mV	-2.725 V -2.725 V	-552.5mV -552.5mV	-2.7438 V -2.7438 V	-555mV -555mV	-2.7313 V -2.7313 V	-550mV -550mV	1001	1110	0101	1110
120.0ms	-968.75mV -968.75mV	-200mV -200mV	-962.5mV -962.5mV	-200mV -200mV	-993.75mV -993.75mV	-202.5mV -202.5mV	-975mV -975mV	-197.5mV -197.5mV	1001	1110	0101	1110
130.0ms	1.8312 V 1.8312 V	200mV 200mV	1.8375 V 1.8375 V	200mV 200mV	1.8063 V 1.8063 V	195mV 195mV	1.8312 V 1.8312 V	202.5mV 202.5mV	1001	1110	0101	1110
140.0ms	2.7875 V 2.7875 V	547.5mV 547.5mV	2.7875 V 2.7875 V	550mV 550mV	2.7625 V 2.7625 V	545mV 545mV	2.7812 V 2.7812 V	547.5mV 547.5mV	1001	1110	0101	1110
150.0ms	3.8563 V 3.8563 V	757.5mV 757.5mV	3.85 V 3.85 V	760mV 760mV	3.8312 V 3.8312 V	760mV 760mV	3.8375 V 3.8375 V	757.5mV 757.5mV	1001	1110	0101	1110
160.0ms	3.9688 V 3.9688 V	780mV 780mV	3.9688 V 3.9688 V	780mV 780mV	3.9625 V 3.9625 V	782.5mV 782.5mV	3.9438 V 3.9438 V	780mV 780mV	1001	1110	0101	1110
170.0ms	3.1063 V 3.1063 V	610mV 610mV	3.1125 V 3.1125 V	607.5mV 607.5mV	3.1125 V 3.1125 V	615mV 615mV	3.0937 V 3.0937 V	612.5mV 612.5mV	1001	1110	0101	1110
180.0ms	1.4875 V 1.4875 V	282.5mV 282.5mV	1.4875 V 1.4875 V	282.5mV 282.5mV	1.5 V 1.5 V	287.5mV 287.5mV	1.475 V 1.475 V	285mV 285mV	1001	1110	0101	1110
190.0ms	-500mV -500mV	-112.5mV -112.5mV	-500mV -500mV	-115mV -115mV	-487.5mV -487.5mV	-110mV -110mV	-518.75mV -518.75mV	-112.5mV -112.5mV	1001	1100	0101	1100
200.0ms	-2.3563 V -2.3563 V	-485mV -485mV	-2.35 V -2.35 V	-485mV -485mV	-2.3437 V -2.3437 V	-480mV -480mV	-2.3625 V -2.3625 V	-485mV -485mV	1001	1100	0101	1100
210.0ms	-3.625 V -3.625 V	-735mV -735mV	-3.625 V -3.625 V	-735mV -735mV	-3.625 V -3.625 V	-732.5mV -732.5mV	-3.6313 V -3.6313 V	-737.5mV -737.5mV	1001	1100	0101	1100
220.0ms	-3.9938 V -3.9938 V	-805mV -805mV	-3.9938 V -3.9938 V	-810mV -810mV	-4 V -4 V	-807.5mV -807.5mV	-4 V -4 V	-805mV -805mV	1001	1100	0101	1100

Print mode: LOGGING (REC)

Start-time: *98-09-28 12:32:03 Stop-time: *98-09-28 12:32:04
 Title: HICK1 8841 MEMORY RECORDER
 Comment: CH1: CH1 COMMENT CH2: CH2 COMMENT CH3: CH3 COMMENT CH4: CH4 COMMENT CH5: CH5 COMMENT CH6: CH6 COMMENT CH7: CH7 COMMENT CH8: CH8 COMMENT CH9: CH9 COMMENT CH10: CH10 COMMENT CH11: CH11 COMMENT CH12: CH12 COMMENT CH13: CH13 COMMENT CH14: CH14 COMMENT CH15: CH15 COMMENT CH16: CH16 COMMENT

(time)	CH1 CH9	CH2 CH10	CH3 CH11	CH4 CH12	CH5 CH13	CH6 CH14	CH7 CH15	CH8 CH16	1A4	1B4	1C4	1D4
0 s	231.25mV 143.75mV	-1.9188 V -2.025 V	-1.5625 V -1.6 V	-2.35 V -2.3625 V	-118.75mV -206.25mV	1.8875 V 1.7875 V	1.0562 V 1.025 V	2.05 V 2.0312 V	1100	1011	1001	1011
25.0ms	-2.8188 V -2.8625 V	-3.8625 V -3.9125 V	-1.6625 V -1.6938 V	-2.0187 V -2.0563 V	912.5mV 831.25mV	1.1625 V 1.05 V	1.3563 V 1.3313 V	2.0312 V 2.0863 V	1001	1011	1001	1011
50.0ms	2.9687 V 2.9437 V	2.975 V 2.8875 V	431.25mV 381.25mV	-180mV -468.75mV	-2.3562 V -2.4438 V	-3.025 V -3.3375 V	-906.25mV -256.25mV	187.5mV 125mV	1001	1011	1001	1011
75.0ms	1.2187 V 1.1375 V	3.2375 V 3.1625 V	1.3563 V 1.3375 V	1.925 V 1.8938 V	-1.1938 V -1.275 V	-3.375 V -3.45 V	-1.8938 V -1.9688 V	-2.1938 V -2.225 V	1001	1011	1001	1011
100.0ms	-2.3937 V -2.45 V	-1.5188 V -1.625 V	-175mV -218.75mV	1.1125 V 1.0625 V	2.4125 V 2.35 V	1.3938 V 1.2813 V	-350mV -400mV	-1.4 V -1.4563 V	1001	1001	1001	1001
125.0ms	1.7313 V 1.6625 V	2.7438 V 2.715 V	1.4438 V 1.4312 V	2.1437 V 2.125 V	1.8125 V 937.5mV	1.2563 V 1.1438 V	-1.2563 V -1.2875 V	-1.4688 V -1.525 V	1001	1001	1001	1001
150.0ms	-2.2938 V -2.3563 V	-4.0625 V -4.0937 V	-1.85 V -1.8687 V	-1.6187 V -1.6688 V	2.3625 V 2.3063 V	3.9188 V 3.8875 V	1.3862 V 1.2875 V	1.325 V 1.2813 V	1001	1001	1001	1001
175.0ms	-1.8062 V -1.8813 V	-2.4813 V -2.5688 V	250mV 200mV	550mV 493.75mV	3.0863 V 2.9938 V	3.9438 V 3.925 V	750.25mV 712.5mV	1.2187 V 1.1688 V	1001	1001	1001	1001
200.0ms	1.9625 V 1.2875 V	-406.25mV -518.75mV	-1.0688 V -1.1125 V	-2.075 V -2.1125 V	-1.2688 V -1.3437 V	393.75mV 281.25mV	587.5mV 543.75mV	1.8125 V 1.775 V	1001	1001	1001	0101
225.0ms	-2.8188 V -2.8625 V	-3.8625 V -3.9125 V	-1.6625 V -1.6938 V	-2.0187 V -2.0563 V	912.5mV 831.25mV	1.1563 V 1.0438 V	1.3563 V 1.3313 V	2.0312 V 2.0863 V	1001	1001	0101	0101
250.0ms	2.9438 V 2.9125 V	3.7438 V 3.6938 V	950mV 912.5mV	456.25mV 393.75mV	-2.9375 V -2.9887 V	-3.8563 V -3.9688 V	-1.4438 V -1.475 V	-675mV -737.5mV	1001	1001	0101	0101
275.0ms	118.75mV 31.25mV	56.25mV -50mV	-1.625 V -1.6563 V	-1.9688 V -2.0125 V	-2.4438 V -2.5 V	-3.3438 V -3.4125 V	-256.25mV -306.25mV	-131.25mV -193.75mV	1001	0101	0111	0101
300.0ms	-1.8875 V -1.1688 V	656.25mV 537.5mV	1.1187 V 1.0875 V	2.0625 V 2.05 V	-43.75mV -131.25mV	-2.2375 V -2.3375 V	-1.85 V -1.8813 V	-2.3625 V -2.3688 V	1001	0101	0111	0101
325.0ms	-2.9375 V -2.9938 V	-4.0937 V -4.15 V	-1.8687 V -1.925 V	-1.6688 V -1.725 V	2.3063 V 2.175 V	3.8875 V 3.6888 V	1.2875 V 1.3563 V	1.2187 V 1.1688 V	0111	0101	0111	0101
350.0ms	2.2938 V 2.225 V	1.0375 V -3.9125 V	-456.25mV -506.25mV	-1.5125 V -1.5625 V	-2.2125 V -2.275 V	-1.1625 V -1.275 V	-18.75mV -68.75mV	1.275 V 1.225 V	0111	0101	0111	0101
375.0ms	2.4813 V 2.4188 V	3.9375 V 3.9125 V	1.2813 V 1.2563 V	1.225 V 1.175 V	-2.4625 V -2.5125 V	-4.1 V -4.125 V	-1.7938 V -1.8188 V	-1.4563 V -1.5125 V	0111	0101	0111	0101
400.0ms	-1.8875 V -1.1688 V	656.25mV 537.5mV	1.1187 V 1.0875 V	2.0625 V 2.05 V	-43.75mV -131.25mV	-2.2375 V -2.3375 V	-1.85 V -1.8813 V	-2.3625 V -2.3688 V	0111	0101	0111	0101

13.6 Printing Procedure

Print item	Internal printer	External printer	See Section
Manual Print			13.6.1
Auto Print		-	13.6.2
Real Time Print		-	13.6.3
Partial Print			13.6.4
Screen Hard Copy			13.6.5
List Print		-	13.6.6
Report Print		-	13.6.7
Color print	-		13.7

13.6.1 Manual Print

This mode serves to print waveform data from the internal memory.

- Memory recorder, memory waveform in Recorder&Memory
Measurement data from one measurement (entire recording length) are printed.
- Recorder, RMS recorder, recorder waveform in Recorder&Memory
Measurement data stored in memory before the end of measurement are printed (2000 divisions^{*1} max.).
^{*1}: Expanded to 32 M words : 10000 DIV
- FFT
Measurement data from one measurement (entire FFT analysis results) are printed.

Procedure

Screen: Waveform display

After the measurement is completed, press the **PRINT** key.

- Since data are stored, they can be printed as often as desired.
- When magnification/compression was used, the printout reflects this condition.
- If you want to stop the printing, press the **STOP** key.
- When cursors A and B are enabled, partial printing is executed in function other than FFT.
- If the record length is set to "CONT." and the time value display on the "SET UP (SYSTEM1)" screen is set to "Time", the displayed time is not the elapsed time from the trigger point (Recorder Start) when recording over 2,000 DIVs (10,000 in the case of 32 M words) with the Recorder and RMS Recorder, and over 1,000 DIVs (5,000 in the case of 32 M words) with REC&MEM recording. When "Date" is selected, the time printed is the time when printing starts.
- In waveform evaluation setting, printing is performed for a single display screen (15 DIV). To print a waveform with a recording length of over 15 DIV, compress the time axis. See Section 11.3.

NOTE

13.6.2 Auto Print

Printout is carried out automatically after a waveform has been captured for the specified recording length. (MEM, FFT)

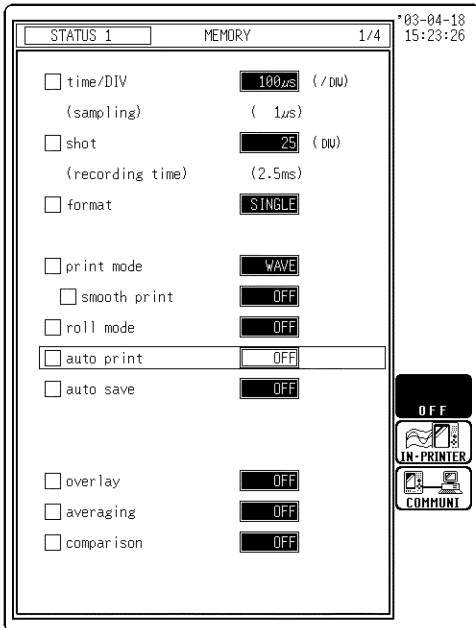

Procedure Screen: STATUS1 (MEM), STATUS2 (FFT)

1. Press the **STATUS** key to display the STATUS1(STATUS 2 in FFT) screen.
2. Move the flashing cursor to the **auto print** item.
3. Use the function keys, and select **IN-PRINTER**.
When COMMUNI is selected, a LAN is used to transfer printing images to the 9333 LAN COMMUNICATOR.
4. Press the **START** key to start the measurement.
Printout is carried out automatically after a waveform has been captured for the specified recording length.

NOTE

- When cursors A and B are enabled in memory recorder function, partial printing is executed .
- When the roll mode is enabled in memory recorder function and the time-axis range is lower than 10 ms/division, data is displayed and printed simultaneously.
- When both auto-print and auto-save are enabled in

memory recorder function, auto-save usually takes precedence. However, if roll mode is enabled, auto-print will execute first.

13.6.3 Real Time Print

The input waveform and data are printed out continuously in real time. (in recorder and RMS recorder functions, recorder waveform in REC&MEM)

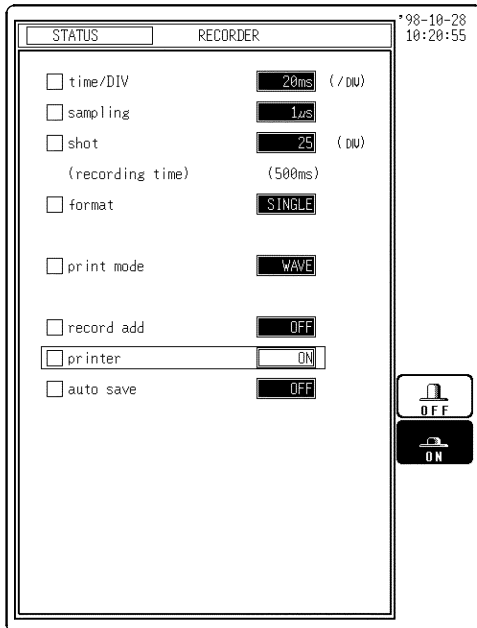

Procedure

Screen: STATUS (REC, RMS), STATUS1 (recorder waveform in REC&MEM)

1. Press the **STATUS** key to display the STATUS screen.
2. Move the flashing cursor to the **printer** item.
3. Use the function keys, and select **ON**.
4. When measurement starts, waveform appears on screen and printout starts.

NOTE

- At a time axis range setting of 200 ms/DIV or faster, the waveform data will be printed out later. (See Section 18.5)
- While the printer always outputs the data at the measurement magnification in recording mode, the waveform on the screen is reduced in size at the ratio shown below, depending on the time-axis range. (REC)
 - 50 ms/DIV \times 1/2, 20 ms/DIV \times 1/10 (Recorder waveform in REC&MEM)
 - 100 ms/DIV \times 1/2, 50 ms/DIV \times 1/5, 20 ms/DIV \times 1/10
- With REC&MEM waveforms, real-time printing cannot be selected in the time axis range of 20 to 200 ms/DIV.

13.6.4 Partial Print

This function prints the waveform between the A and B cursors (vertical or trace cursors). The function is available also when the A•B cursors are currently outside the range displayed on screen. Printing is possible also when the print format is currently set to "numeric". For details regarding the use of the A•B cursors, refer to Section 11.2.

- Memory recorder, memory waveform in REC&MEM
Specified range (out of entire data recorded from a measurement) is printed.
- Recorder, RMS recorder, recorder waveform in REC&MEM
Specified range (out of last 2,000 (expended 32 M is 10,000) divisions (magnification: $\times 1$) of data in memory) is printed.
The recorder waveform in REC&MEM is maximum 1000 divisions (expended 32 M is 5000)

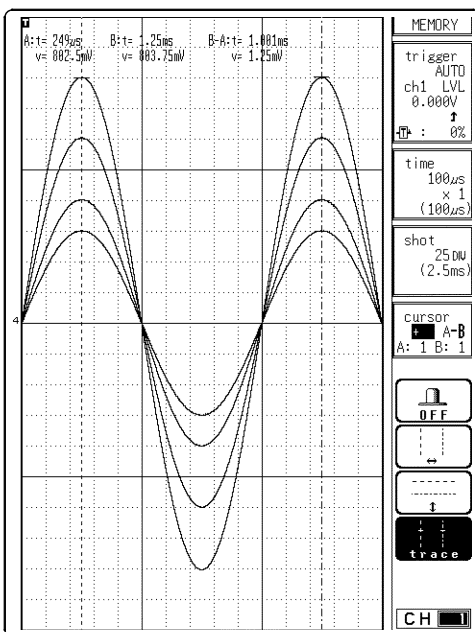

Procedure Screen: Waveform display

1. Press the **DISP** key to display the Waveform display screen.
2. Position cursor A at the start point of the range to be printed.
3. Specify the end point of the range with cursor B. (Move cursor B (or A) to the right. When the cursor is at the rightmost edge of the screen, the waveform scrolls to the left, and cursor A (or B) scrolls with it.)
4. Then press the **PRINT** key. The specified range is printed, also if cursor A (or B) is currently off screen. When only the cursor A is used, the waveform data from the position of cursor A to the end of the data is printed.

NOTE

- On the waveform evaluation screen, cursors A and B are available, but partial printing cannot be performed.
- On the X-Y screen and in FFT function, the partial printing cannot be performed.

13.6.5 Screen Hard Copy

The display contents of the all screens can be printed out as is.

Procedure Screen: All

1. Display the desired screen.
2. Press the **COPY** key.

NOTE

- Even if the gauge is set to the List & Gauge function, the gauge is not printed out in the screen copy mode. The screen hard copy function is not available during measurement.
- Output destination by the **COPY** key can be selected. See Section 13.4.4.

13.6.6 List Print

The settings for the various functions made with the STATUS screen, CHANNEL screen etc. can be printed out in list format.

Procedure Screen: Excluding Waveform display

Press the **PRINT** key on the screen excluding Waveform display.

NOTE

The list to be printed contains the setup conditions for the acquired waveforms. Even if the settings are changed following wave acquisition, the contents of the list remain unchanged.

13.6.7 Report Print

Prints the waveform (in the range displayed on the Waveform display screen), upper and lower values, and analog channel settings on A4 size paper.

- If the A and B cursors are displayed on the screen, they are also printed.
- When "COMMENT" or "SET & COM" is set, the comments are also printed (see Section 9.9).

Procedure Screen: Waveform display

1. Display the Waveform display screen.
2. Press the **FEED** key and **COPY** key simultaneously.
(Press and hold the **FEED** key and then press the **COPY** key.)

NOTE

In FFT function, this function is not available.

13.7 External Printer (color print)

Using the 9559 PRINTER CARD, waveform data can be output on A4-size sheets from the external printer in color or monochrome.

PRINT key: Prints out equivalent to 25 divisions waveform data or numerical data.

COPY key: Prints out the screen hard copy.

Connecting the PRINTER CARD

Connect the printer card to the unit.
See Section 14.3.1.

Setting the external printer

Turn on the external printer.
Load A4-size sheets and prepare the printer for printing.

Setting the interface

For details on settings, see Sections 13.4.4 and 13.4.5.

Output destination

Set the output destination by **PRINT** key and **COPY** key to external printer.

Output color

Select the color of the output.

Print driver

Set the control code ("ESC/P" or "ESC/P Raster") according to the printer to be used

Print size

Set the print size to $\times 0.8$ or $\times 1$

Indent width

Adjust the indent width (margin) within the range of 0 to 10 mm from the upper edge of the screen.

Saving the data in memory

Save "newly measured data" or "data saved to the media" in the internal memory of the unit.
For details on load, see Section 14.8.

Specifying the printout range

Press the **DISP** key; the Waveform display screen will appear. Using cursors A and B, the print range can be specified. For information on how to use cursors A and B, see Section 11.2.

Printing starts
PRINT key
COPY key

When the **PRINT** key is pressed, the waveform data is printed out at a rate of 25 divisions.
When the **COPY** key is pressed, the data shown on the screen is printed out.

NOTE

With respect to the following items, the external printer differs from the internal printer:

- For the list and gauge functions, the list is printed out but the gauge is not output. If the display format is the X-Y screen, however, the gauge is also printed out.
- The upper and lower limits are printed out for every page.
- When both the upper-lower print function and 0 position comment function are enabled, the upper-lower print function is performed first.

Waveform print

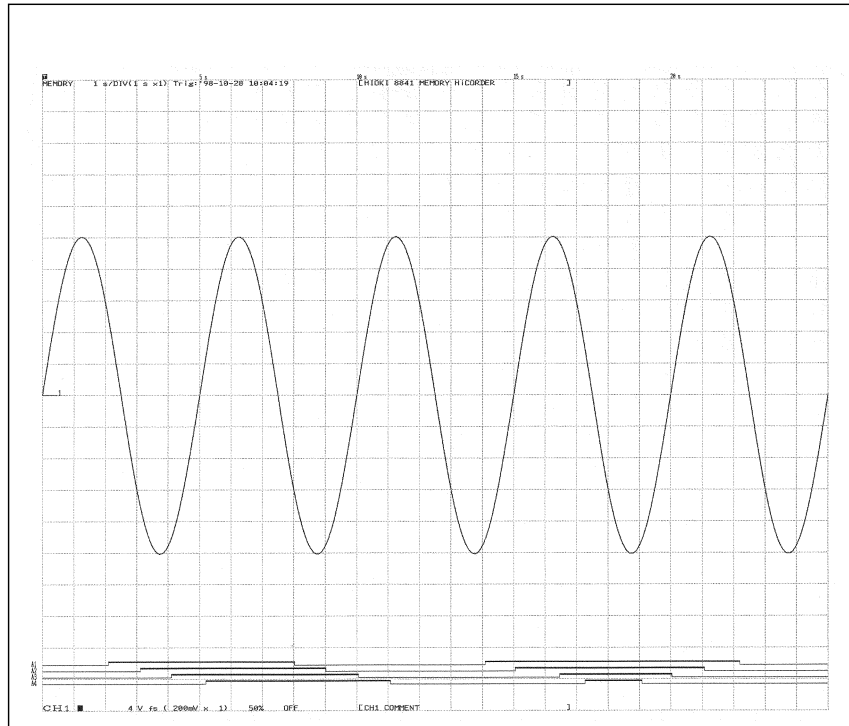

Screen hard copy

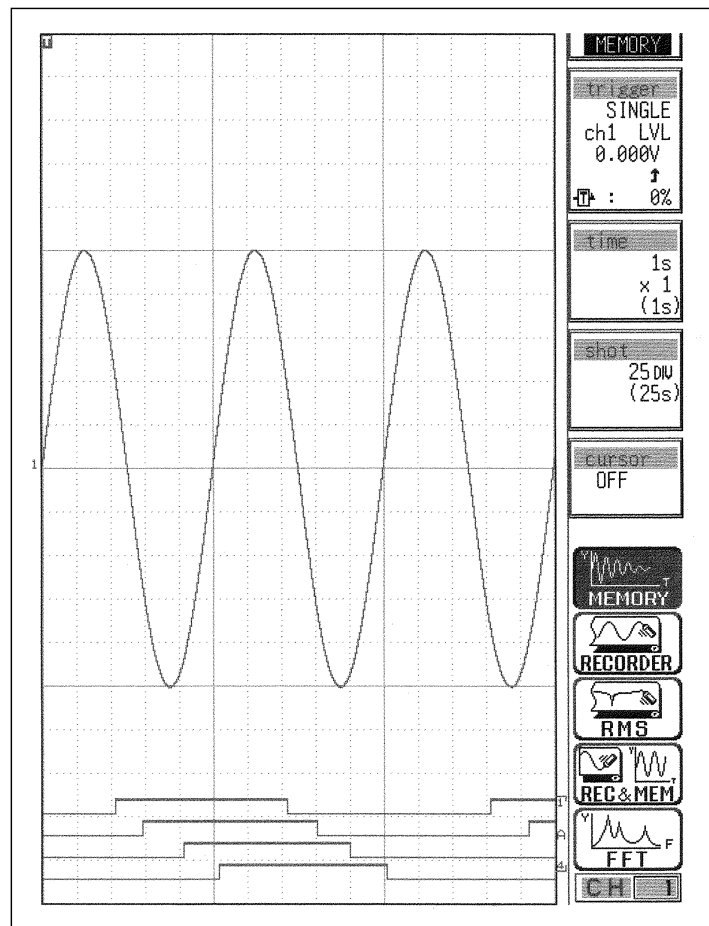

Chapter 14

Storing Measurement Data

A floppy disk, PC card, MO disk, or connected SCSI device can be used to store and retrieve measurement and setting data.

This chapter explains how to operate these devices, save measured and setup data (SAVE), load data (LOAD), get information on data (INFO), delete data (DELETE), initialize devices (FORMAT), work with directories, create startup files, and remove MO disks.

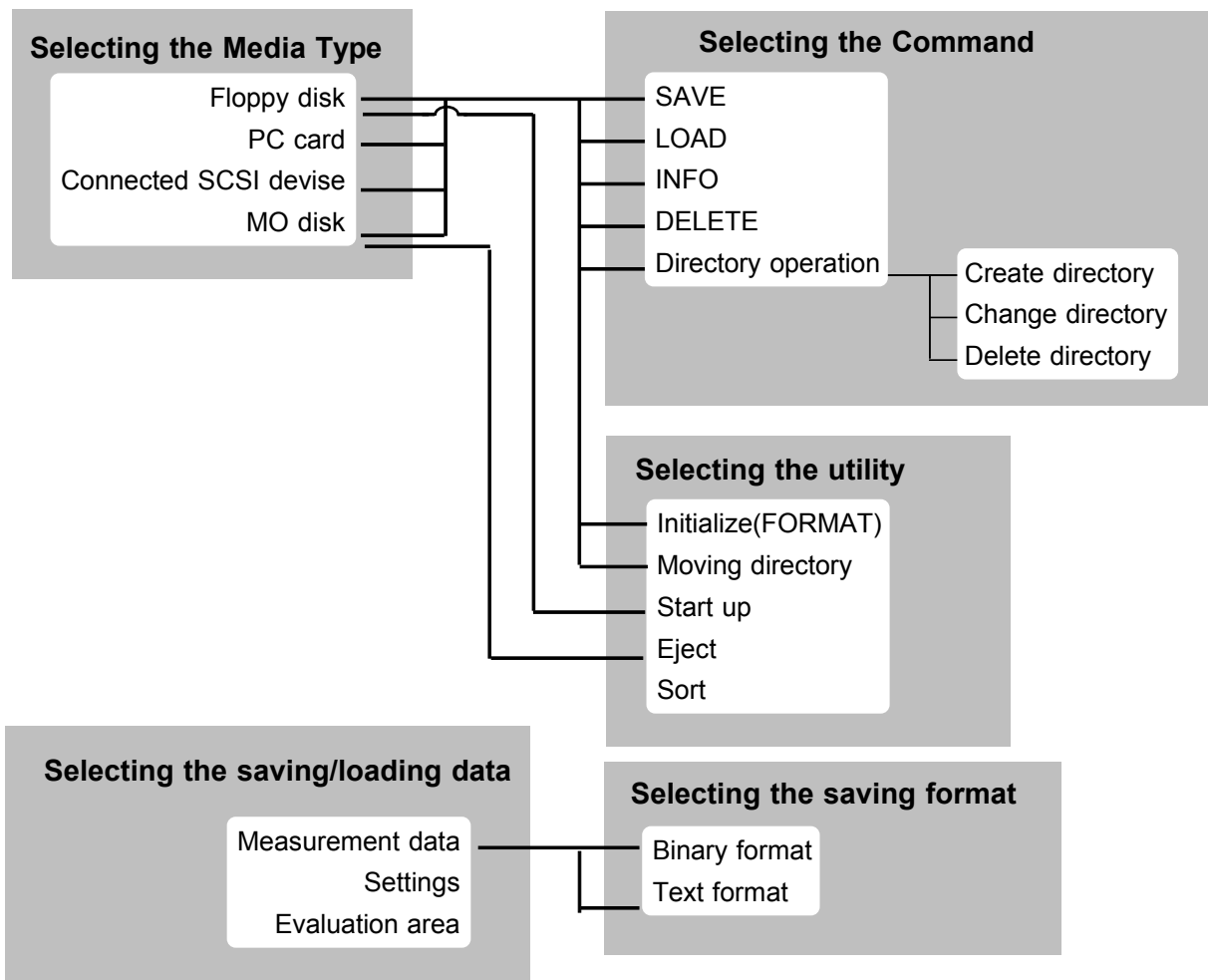

While the memory segmentation enabled, it can be specified whether one or all blocks are to be saved.

14.1 Floppy Disk

CAUTION

- If a floppy disk is inserted upside down, backwards, or in the wrong direction, the floppy disk or the unit may suffer damage. Before shipping the unit, always remove the floppy disk.
- 2DD floppy disks formatted in PC9801 640 KB format cannot be used.
- Do not remove the floppy disk while the floppy disk unit is operating (the LED on the floppy disk unit is on).
- The number of bytes depends on the floppy disk format.
- If the write-protect tab on the floppy disk is in the set position, the operations can not be performed.
- The floppy disk must be initialized (formatted) before using it.

3.5 inch 2HD or 2DD floppy disks can be used.

The following floppy disk formats can be used:

720 KB (IBM PC/AT compatible), 1.2 MB (NEC PC-9801 series), 1.44 MB (IBM PC/AT compatible or NEC PC-9801 series with 3-mode drive)

Write protection

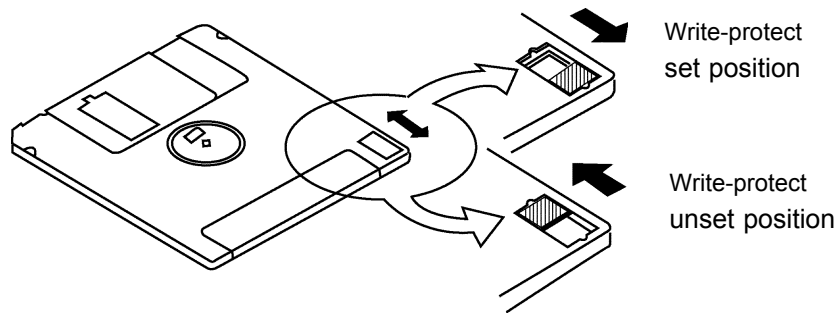

How to set a floppy disk:

For horizontal installation of the unit, insert the floppy disk into the drive with the disk label facing toward you. For vertical installation, insert the floppy disk into the drive with the disk label facing downward.

To remove the floppy disk, press the eject button.

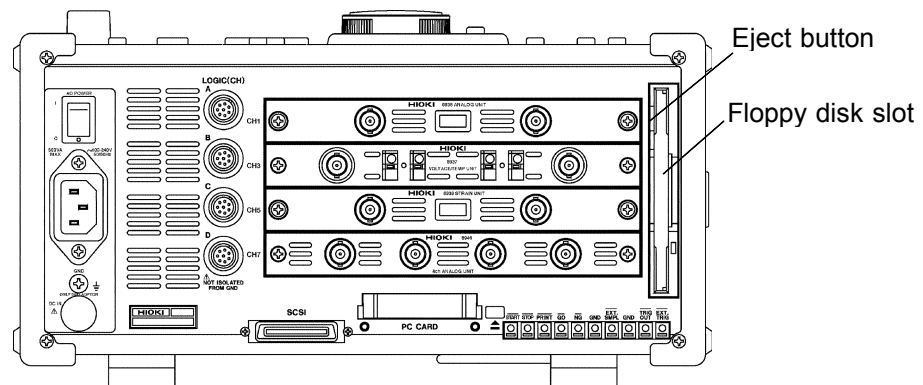

14.2 9607 MO UNIT (Option)

CAUTION

- If a MO disk is inserted upside down, backwards, or in the wrong direction, the MO disk or the unit may suffer damage. Before shipping the unit, always remove the MO disk.
- Do not remove the MO disk while the MO disk unit is operating (the LED on the MO disk unit is on).
- The number of bytes depends on the MO disk format.
- If the write-protect tab on the MO disk is in the set position, the operations can not be performed.
- The MO disk must be initialized (formatted) before using it.
- Do not use the MO drive when the unit is propped up using the stand.

MO type

Use 3.5-inch MO disks (128, 230, 540, 640 MB: rewritable and overwrite) with this unit.

Write protection

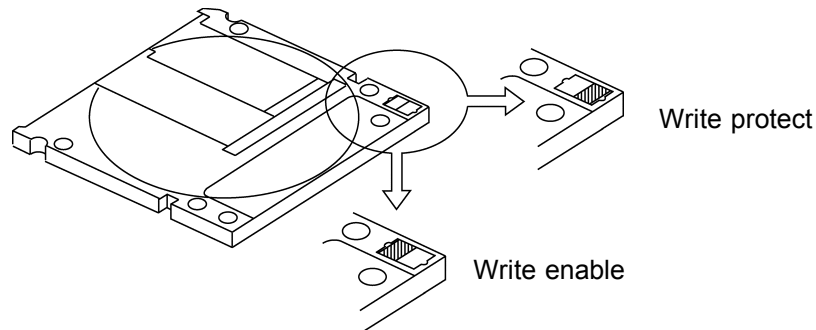

Inserting/ Removing

For horizontal installation of the unit, insert the MO disk into the drive with the disk label facing up. For vertical installation, insert the MO disk into the drive with the disk label facing toward you. To remove the MO disk, press the eject button, or use the associated function in the FILE screen utility.

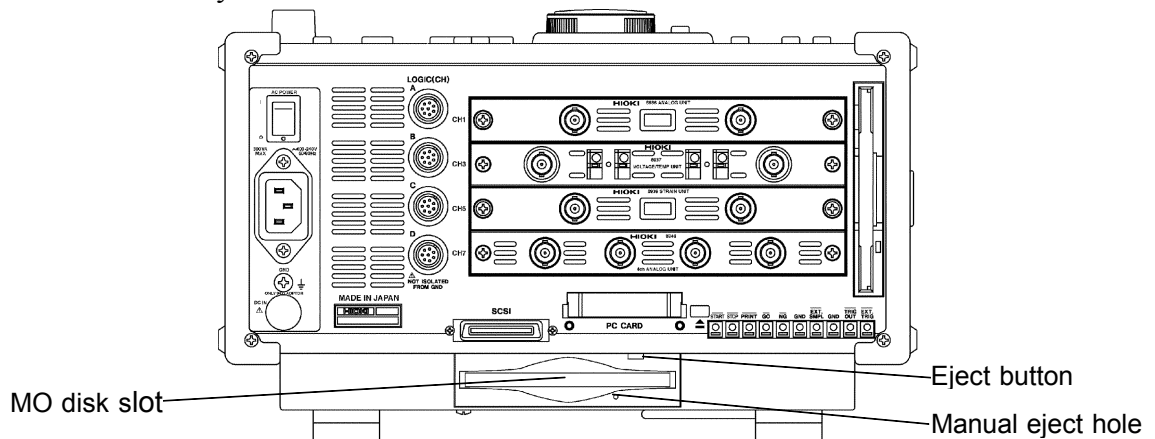

NOTE

If for any reason it should be impossible to remove the disk, use the following procedure.

- During powering on, press continuously the eject button of the MO drive to eject the disk.
- Power off the unit and insert a pin of diameter approximately 1 mm into the manual eject hole of the MO drive, to eject the disk.

14.2.1 Setting the Internal MO

(When the 9607 is installed)

The internal MO drive can be treated as an MO drive in the PC.

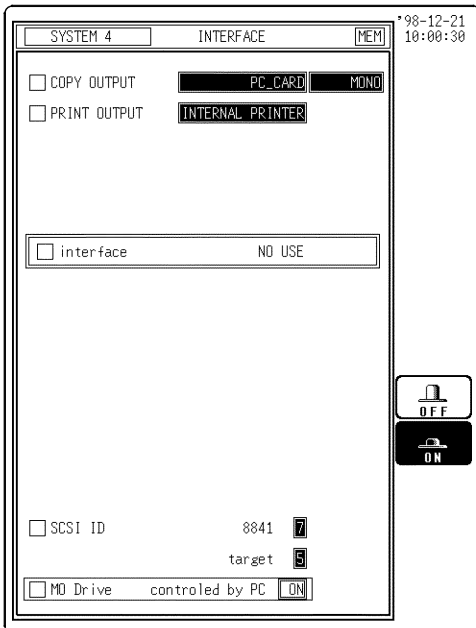

Procedure Screen: INTERFACE (SYSTEM4)

1. Press the **SYSTEM** key or function keys to display the INTERFACE screen.
2. Move the flashing cursor to the **MO Drive** item.
3. Use the function keys to make the selection.

Function
display

Meaning



: The MO drive is not treated as a drive in the PC.



: The MO drive is treated as a drive in the PC.

NOTE

- This can be selected only when the optional 9607 MO UNIT is installed.
- When the internal MO setting is enabled (ON) and the storage destination for automatic storage is set to Internal MO, automatic storage setup is disabled.
- When the internal MO setting is enabled (ON), the internal MO media selection cannot be selected.
- The ID of the internal MO is fixed at 4.

14.3 PC Card

⚠ WARNING

Use only PC Cards sold by HIOKI.

Compatibility and performance are not guaranteed for PC cards made by other manufacturers. You may be unable to read from or save data to such cards.

⚠ CAUTION

- For horizontal installation of the unit, insert the PC card slowly into the slot with the card label facing up. For vertical installation, insert the PC card into the slot with the card label facing toward you.
 - Forcing the card in all at once or inserting it upside down, backwards, or in the wrong direction may cause damage to the PC card or the unit.
 - Before shipping the unit, always remove the PC card.
 - Do not remove the PC card while the PC card unit is operating.
 - The number of bytes depends on the PC card format.
 - The PC card must be initialized (formatted) before using it. Some types of PC cards are not acceptable.
 - When formatting a PC card on a PC, use the FAT-16 format. Formatting a card in FAT-32 format may result in incompatibility problems.
-
- The following five PC card types can be used in the 8841/42: flash ATA card, RS-232C interface card, GP-IB card, printer card, and LAN card.
 - Flash ATA cards can be used as external storage.

HIOKI options

PC cards (includes adapter)

9626 PC CARD 32M

9627 PC CARD 64M

9726 PC CARD 128M

9727 PC CARD 256M

9728 PC CARD 512M

9729 PC CARD 1G

Important:

When inserting a PC card, be sure to orient the card horizontally and side it into the slot along the grooves. Do not force the card into the drive diagonally. Doing so may damage the internal connectors and cause malfunction.

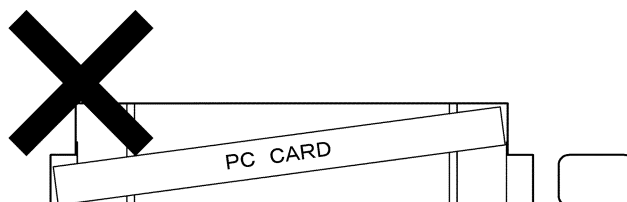

14.3.1 Using the PC Card Slot (PC Card with a Cable Only)

CAUTION

- If a PC card is inserted upside down, backwards, or in the wrong direction, the PC card or the unit may suffer damage. To avoid damage to the PC card or connector, observe the cautions listed below.
- Inserting the card with the wrong orientation or in other ways than described above.
- Inserting the card while attached to the connection cable.
- Moving the 8841/42 while the connection cable is connected to the card.
- Pulling the card out by the cable or exerting excessive force on the connector.
- Placing objects on the connection cable connector.

Cable and PC card connection

1. Pass the PC card protector through the connection cable, as shown below.
2. Plug the PC card end of the connection cable into the PC card. The top side of the cable connector (marked with a) should match the top side of the PC card, as shown below.

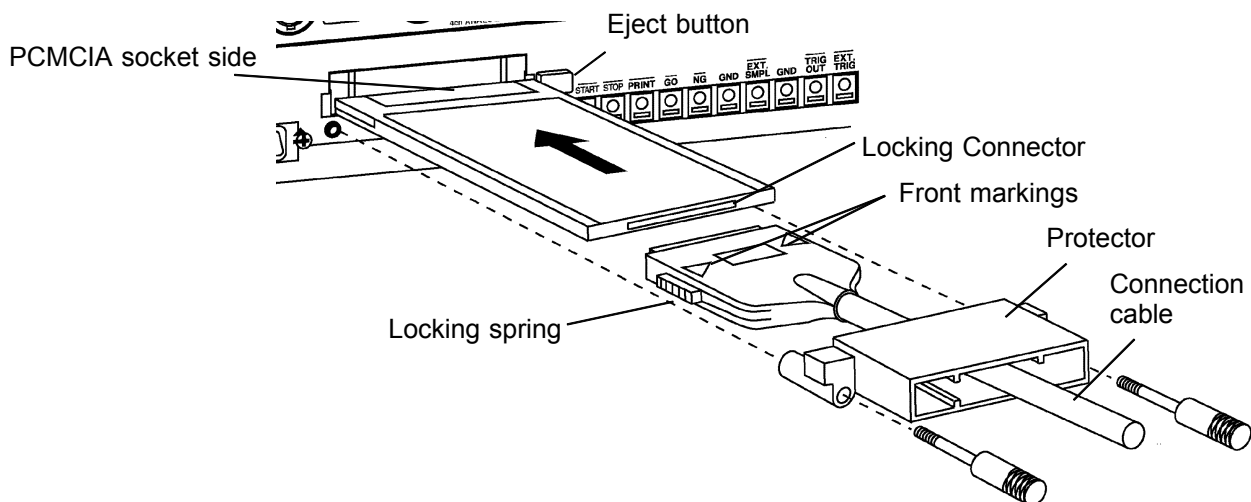

3. Insert the PC card in the PC card slot on the 8841/42. Verify that the mark on the card points in the correct direction, and make sure that the card is properly seated in the slot. The PC card is keyed to prevent wrong insertion, but exerting excessive force may damage the card or the slot.
4. Attach the PC card protector to the 8841/42.

Removing the PC card

1. Remove the PC card protector.
2. To remove the PC card, press the eject button. Do not press the eject button before removing the PC card protector.

NOTE

To avoid damage to the 8841/8842, always remove the PC card protector before pressing the eject button.

14.4 SCSI Interface

14.4.1 SCSI Interface Specifications

General specifications

See Section 18.2.

Electrical specifications

Input signals

Receiver	CMOS receiver with hysteresis
Input signal levels	Low level: 0 to 0.8 VDC, High level: 2.0 to 5.25 VDC
Maximum load current	$\pm 10 \mu\text{A}$ (excluding terminator)
Minimum hysteresis	0.2 VDC

Output signals

Driver	Open-drain CMOS driver
Output signal levels	Low level: 0 to 0.8 VDC, High level: 2.0 to 5.25 VDC
Driver sink current	48 mA

Terminator power signal

Output voltage	4 to 5.25 VDC
Maximum output current	1.2 A

Connector

Recommended connector:

Socket used: High density (pin type) (D-Sub half-pitch 50 P)

SCSI connector pin outs

Pin	Signal	Pin	Signal	Pin	Signal	Pin	Signal	Pin	Signal
1	GND	11	GND	21	GND	31	-DB5	41	-ATN
2	GND	12	GND	22	GND	32	-DB6	42	GND
3	GND	13	GND	23	GND	33	-DB7	43	-BSY
4	GND	14	GND	24	GND	34	-DBP	44	-ACK
5	GND	15	GND	25	GND	35	GND	45	-RST
6	GND	16	GND	26	-DB0	36	GND	46	-MSG
7	GND	17	GND	27	-DB1	37	GND	47	-SEL
8	GND	18	GND	28	-DB2	38	TERMPWR	48	-C/D
9	GND	19	GND	29	-DB3	39	GND	49	-REQ
10	GND	20	GND	30	-DB4	40	GND	50	-I/O

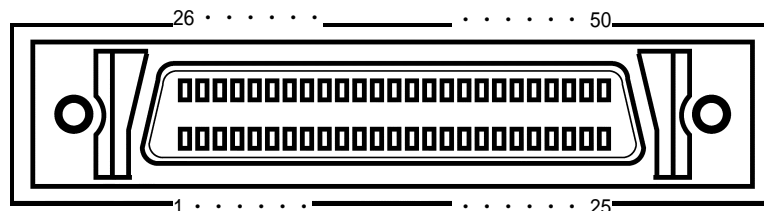

NOTE

- The SCSI cable is not supplied.
- Check the connection types on both the 8841/8842 and the connected device. Use commercially-available SCSI cables.

14.4.2 Setting the MO Disk Drive

CAUTION

Do not power off while the MO disk is being accepted.

Connection to a MO disk drive

- Select a SCSI cable with a connector corresponding to that of the disk drive.
- Check that both the 8841/42 and the MO disk drive are powered off.
- Connect firmly the SCSI connector on the right side panel of the 8841/42 and the MO disk drive.

Powering on

- Always power on the MO disk drive before powering on the 8841/42.
- Always power off the MO disk drive after powering off the 8841/42.

System configuration

- A maximum of seven SCSI interfaces can be connected, but the 8841/42 can only access either of one MO disk drive.
- It is not possible to operate more than one SCSI initiator (a personal computer for example) on the same SCSI bus. In the worst case this could lead not only to bus collisions and data loss, but also to damage to one or other SCSI controller.
- Ensure that all devices on the SCSI bus have different address IDs.
- Fit a terminator on the last SCSI device on the daisy-chain.

MO disk drive

- Within the SCSI standard, some commands are left for manufacturer-dependent use. A MO disk drive which requires such commands cannot be used with the 8841/42.
- Depending on the operating environment and any impedance mismatch of the interface cable, it is possible for timing discrepancies on the SCSI bus to prevent the MO disk drive from operating normally.

MO type

Use 3.5-inch MO disks (128, 230, 540, 640 MB: rewritable and overwrite) with this unit.

The following MO drives have been used satisfactorily by HIOKI. (As of April 2001)

230 MB	I O Data	RM-MO230F-L, MOF-230, MOF-230W
	Olympus	230MO TURBO
	TEAC	MO-230S
	Midori Elec.	UM-323R
640 MB	Logitec	LMO-230
	I O Data	RM-MO640F, MOF-640, MOF-S640, MOF-H640, MOF-R640, MOF-RM640, MOF-SM640
	Olympus	640MO TURBO
	Mitsubishi Chemical Corp.	MK640F
	Midori Elec.	UM-640F
	Logitec	LMO-640, LMO-640S2, LMO-640F, LMO-S640F, LMO-S645F, LMO-A636S
	Fujitsu	SMB-640WF, FMO-640W3, FMO-640WL3

NOTE

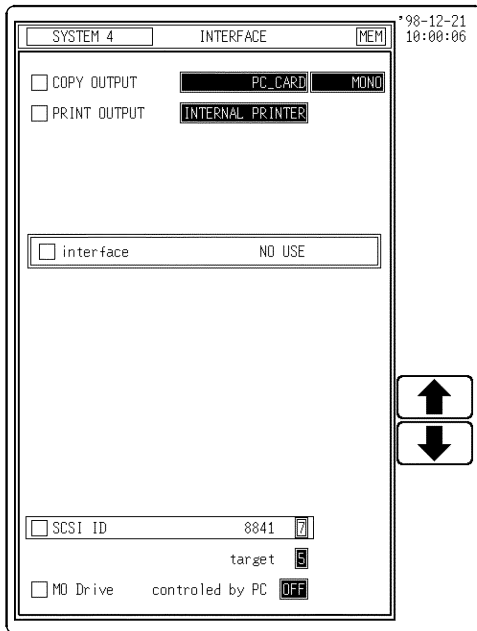

Note that the MO may not be compatible should the MO drive specifications be changed, even if the model No. remains the same.

14.4.3 Setting the SCSI ID



Procedure Screen: INTERFACE (SYSTEM4)

1. Press the **SYSTEM** key to display the INTERFACE screen.
2. Move the flashing cursor to the **SCSI ID** item.
3. Use the function keys or Jog/Shuttle control to make the setting.

Function display	Meaning
	: Increases in number.
	: Decreases in number.

8841/42

Set the ID number of the 8841/42 on the SCSI bus. The available value range is 0 to 7.

Target

Set the ID number of the MO drive, which will be connected to the 8841/42, on the SCSI bus. The ID number of the internal MO drive (optional) is set to 4. Therefore, if the internal MO drive has been mounted, the ID number 4 cannot be specified. The available value range is 0 to 7.

NOTE

- Do not set the SCSI ID of the 8841/42 and target to the same number.
- When "SCSI" or "MO" is selected as the output destination, separate destinations cannot be set for the auto save, parameter calculation result save, and the **COPY** key output.

14.5 Selecting the Media Type

The media type is specified.

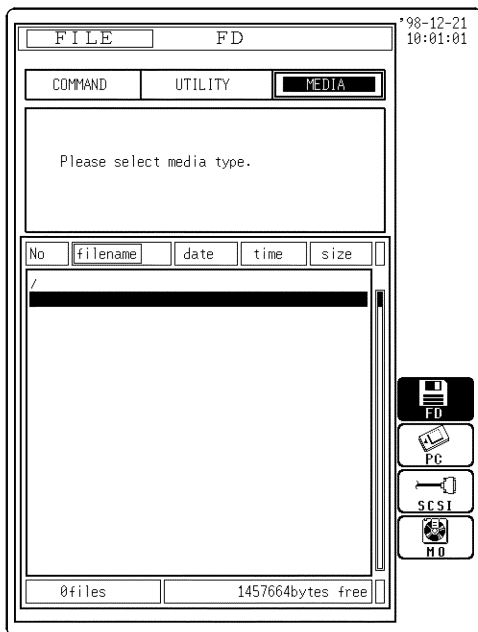

Procedure Screen: FILE

1. Press the **FILE** key to display the FILE screen.
2. Move the flashing cursor to the **MEDIA** item.
3. Use the function keys to make the selection.

Function
display

Meaning



: Floppy disk media are used.



: PC card media are used.

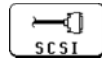

: Select the external storage connected to the SCSI interface as the recording medium.



: MO disk media are used.

14.6 Initializing (FORMAT)

Initialization (formatting) method is described below.



Procedure Screen: FILE

1. Press the **FILE** key to display the FILE screen, and use the function keys to select the media.
2. Move the flashing cursor to the **UTILITY** item.
3. Use the function keys to select **FORMAT**(logical format).
4. Select the format type.
(when using the floppy disk)

Function display Meaning

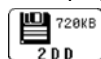
 : Format in 2DD (720 KB) format

 : Format in 2HD (1.2 MB) format.

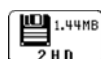
 : Format in 2HD (1.44 MB) format

(when using the MO)

For normal use, use **FORMAT**. Use the **FORMAT(phy)** (logical format and physical format) only for disks that cannot be read by the 8841/8842.

Function display Meaning

 : Logical format is used.

 : Logical format and physical format are used.

5. Select **enter** after selecting a format.
6. Use the function keys to select (**exec**).

Function display Meaning

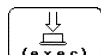
 : Execute the format procedure.

 : Cancel the format procedure.

Formatting time (approx.) the MO disk (physical format)

	REWITABLE	OVERWRITE
128 MB	7 min	
230 MB	10 min	6 min
640 MB	11 min	8 min

NOTE

- Use the MS-DOS format for floppy disks and PC cards.
- The MO-disk format conforms to the super floppy format.
- Waveforms that are displayed by the recorder function in X-Y format cannot be saved in text format.

14.7 Saving the Data (SAVE)

The settings of the unit and measurement data are saved in the current directory selected on the FILE screen.

The data can be saved in binary or text format.

(1) Setting state (SET)

- It is possible to record the setting state for each of the functions.
When a multiblock is used, the setup conditions of the use blocks are stored.
- When a setting state is read into the 8841/42, it is restored in the unit.
Size of recording in each function: 512 bytes \times 41 = 20992 bytes

(2) Measurement data (MEM, REC, XYC, RMS, FFT, TXT)

- It is possible to save the measurement data of a waveform which has been captured.
- Use of cursors A and B enables partial saving. (excluding XYC, FFT)
- When measurement data is read into the 8841/42, the waveform data recorded on the media and the FFT analysis result are put into the designated memory channel.
- When the measurement data of a waveform is recorded, its setting state (the recording length, time axis, measurement range, scaling and comments) is also simultaneously recorded. Because when this is loaded the unit is set to the condition when the measurement data was recorded, it can be checked by being listed. (See Section 13.6.6.)
- The logic memorizes one probe as one channel.
- For the file size, see Appendix 4, "Size of a Waveform File (Binary data)", and 5, "Size of a Waveform File (Reference value of text data) ."

(3) Recorder&Memory (R_M)

- In this function, the recorder waveform and memory waveform can be saved.
- These waveforms can be saved in a single operation.

(4) Memory block (SEQ: sequential, MUL: multiblock)

- Using the memory segmentation function, the recorded waveform data can be saved to the memory block.
- Batch saving of all blocks can be selected.

(5) Evaluation area (AREA)

- The area created using the waveform evaluation editor can be saved.
- The setup conditions are saved together with the evaluation area.
- The recording capacity varies depending on the evaluation area.

(6) Hard copy (BMP)

The each screen display of the 8841/42 can be stored in the bit map file (BMP) format.

Color setting	File size
Color, Gray	308278 bytes
Mono, Mono (rev)	38462 bytes

- The bit map file is one of the standard graphic type of the Windows*¹, therefore by using the graphic software, this file format can be used.
- For details on saving the hard copy, refer to 13.4.4.

(*1): The Windows is a registered trademark of Microsoft Corporation.

(7) Partial saving

- When the A cursor is used to specify, the data from the position specified by the A cursor to the end is saved.
- When the A and B cursors are used to specify, the data between A and B cursors is saved.

Number of directories and files to be saved

Media	Format	Limit	
		Root	Sub
FD	720 K	112	5000
	1.2 M	192	5000
	1.44 M	224	5000
PC	Flash ATA	512 to 1024	5000
MO	—	512	5000

NOTE

- Data stored in the text format is not readable by the 8841/42.
- In FFT function, the partial saving is not possible.

14.7.1 Setting the Data to Store

Stores data after the recording media is selected and formatted.

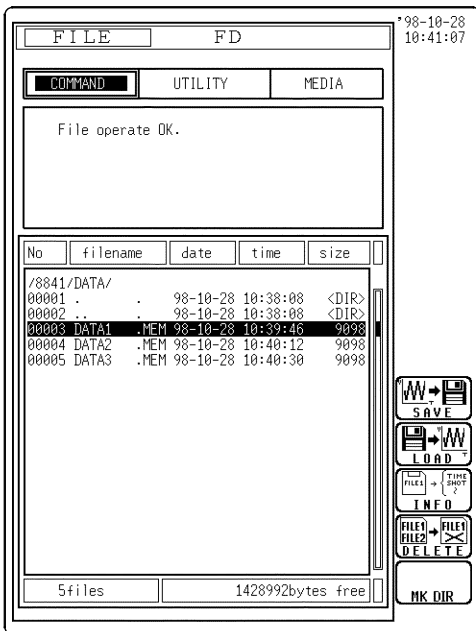

Procedure Screen: FILE

(1) Select the Command.

1. Press the **FILE** key to display the FILE screen.
2. Move the flashing cursor to the **COMMAND** item.
3. Use the function keys to select **SAVE**.

(2) Select the store format.

1. Move the flashing cursor to the **type** item.
2. Use the function keys or the Jog/Shuttle control to select the format.

BINARY The waveform data or FFT analysis result is saved in binary format.

TEXT The waveform data or FFT analysis result is saved in text format.

Data stored in the text format is not readable by the 8841/42.

SET The settings are saved.

AREA The evaluation area in memory is saved.

Function display Meaning

 : Determines the data to store.

 : Cancel the command to be saved.

(3) Select the channel for storing data.

1. Move the flashing cursor to the **ch** item.
2. Use the function keys or the Jog/Shuttle control to select the channel.

ALL Store data for all displayed channels.

CH1 Store waveform data for channel 1.

:

CH16 Store waveform data for channel 16.

LOGIC Store logic waveform data (displayed data only).

Function display Meaning

 : Determines the data to store.

 : Cancel the command to be saved.

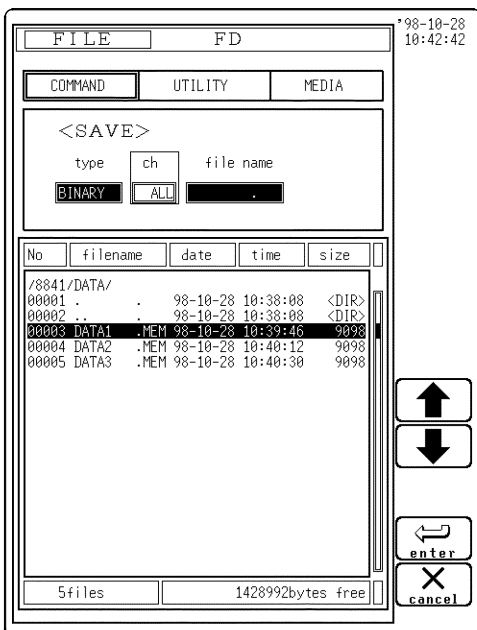

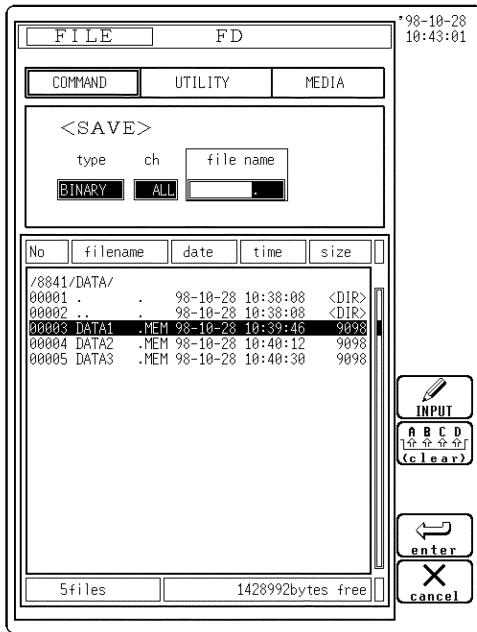



(4) Enter the file name.

1. Move the flashing cursor to the **file name** item.
2. Use the function keys to select **INPUT**.

Function display Meaning

 : Enter a file name.

 : Clear the file name.

 : Determines the data to store.

 : Cancel the command to be saved.

3. Use the function key to enter characters.

Function display Meaning

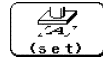
 : Enter a character on the cursor.

 : Execute command on the cursor.

 : End

4. Use the cursor keys to move the cursor to the selection window, and select (**set**) on the character to be input.

5. Repeat Steps 3 and 4 to enter a comment (using characters).

The file and directory names cannot include spaces. For the explanations in window, see Section 9.9.3.

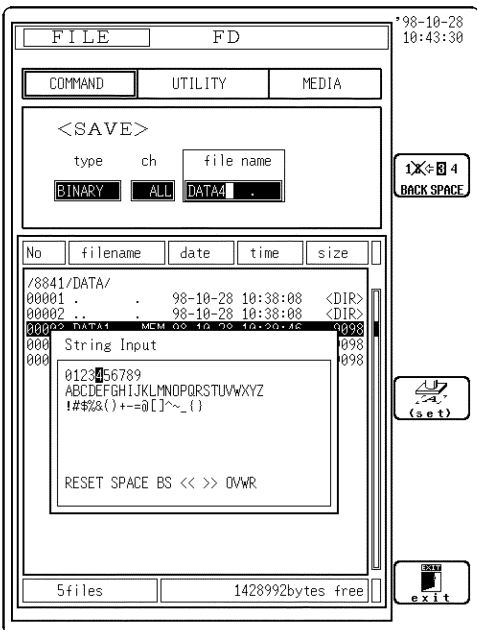

NOTE

File names cannot contain the characters +, -,], or [. Please note that file names containing these characters will not be saved.

File name extension

If no file name extension (3 characters after period) is entered, the following extensions are automatically assigned, according to the stored data type.

MEM	Memory recorder binary data file	●
REC	Recorder binary data file	●
RMS	RMS recorder binary data file	●
XYC	X-Y CONT recorder binary data file	●
SEQ	Sequential save index file	●
MUL	Multiblock index file	●
TXT	Text data file	—
SET	Setting data file	●
ARE	Evaluation are	●
BMP	Bit map (.bmp) file	—
FFT	FFT binary data file	●
R_M	REC&MEM index file	●
CMU	Setting file of the 8910 CAN ADAPTER(read only)	●

: Files can be read into the unit. : Reading is not possible

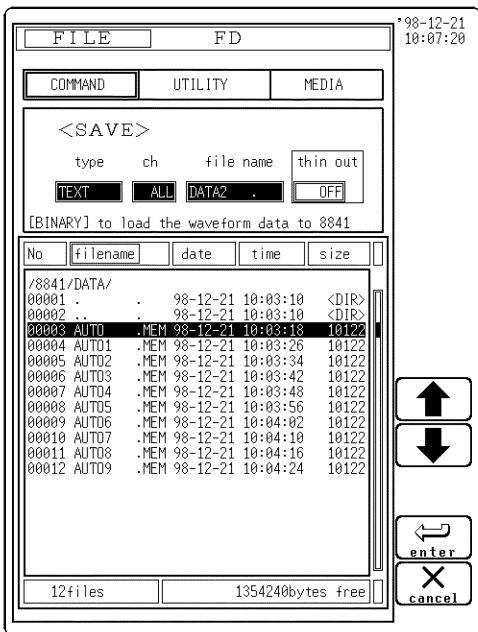

(5) Set the text data thinning.

If the settings call for data to be saved in text format, the file size can be compressed in terms of the data quantity.

1. Using the cursor keys, move the flashing cursor to **thin out**
2. Use the function key or Jog/Shuttle control to make a setting.

Function display

Meaning



: Move the cursor up in the selection window.



: Move the cursor down in the selection window.



: Determines the data to store.



: Cancel the command to be saved.

NOTE

Data stored in the text format is not readable by the 8841/42. Thinning is not applied with FFT data text format storage.

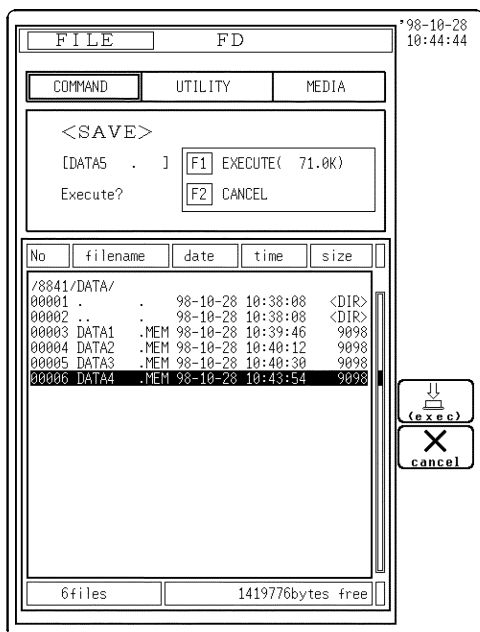

(6) Execute saving.

1. Use the function key to select **enter** to confirm the setting.

Function display	Meaning
	: Determines the data to store.
	: Cancel the command to be saved.

2. Select the **(exec)** function key.

Function display	Meaning
	: Save the file data.
	: Cancel saving

3. When the waveform data is selected and the memory segmentation function is used, select block saving.

Function display	Meaning
	: In sequential saving, all data, from the starting block through the ending block, are saved.
	: Save the waveform data on the selected blocks (displayed block, use block)
	: Cancel

4. Select the data storage type for the Recorder & Memory function:

Function display	Meaning
	: Save the REC&MEM index files.
	: Save the display waveform data.
	: Cancel

NOTE

- When "R&M wave" is selected with the Recorder & Memory function, a directory with the same name as the filename is created and in the directory, and then the data files and an index (R_M) file to read the composite data are created.
- When "ALL BLOCKS" is selected, a directory with the same name as the filename is created and in the directory, the files for all blocks as well as an index file for reading the data in one operation are created.
- The directory and the number of files that can be stored in the directory are limited. For details, see Section 14.7.
- For purposes of bulk storage (all blocks of memory division, or in REC&MEM function), partial saves are disabled even when A and B cursors are shown on the Waveform display screen.
- When the "Enter" function key is selected, the file size to be saved is displayed.

Automatic file name assignment

If the file name is entered as a blank [.], it is assigned automatically according to the following principle.

Auto save	Real time save	Waveform data, screen data	Parameter calculation result
[AUTO .EXT]	[REAL .EXT]	[NONAME .EXT]	[MEASURE .TXT]
[AUTO0001.EXT]	[REAL0001.EXT]	[NONAME01.EXT]	[MEASURE1.TXT]
[AUTO0010.EXT]	[REAL0010.EXT]	[NONAME10.EXT]	[MEASUR10.TXT]
[AUTO0100.EXT]	[REAL0100.EXT]	[NONAM100.EXT]	[MEASU100.TXT]
[AUTO5000.EXT]	[REAL5000.EXT]	[NONA5000.EXT]	[MEAS5000.TXT]

File contents

The file contents depend on the file type.

Screen	WAVE (Binary)				SET
	MEM	REC	RMS	FFT	
STATUS1 screen	*1	/	/		
STATUS2 screen					
STATUS3 screen					
STATUS4 screen					
STATUS screen	/				
TRIGGER screen					
CHANNEL screen					
Variable screen					
Scaling settings					
Comment settings					
SET UP (SYSTEM1)	-	-	-	-	

The data is saved to the file. Settings for the 8841/42 are always enabled during reading.

- The data is not saved to the file.
- *¹ The data is saved to the index file.

Text data store example

The text data are stored as follows. Depending on the function, the saving method varies.

```

"COMMENT", "8841 MEM DATA" *1           : Comment character string
"DATE", "01-01-1999"                     : Date ( month - day - year )
"TIME", "10:10:00"                       : Time
"NUM_SIGS", 3                            : Number of signals
"INTERVAL", 1.000E-06                    : Horizontal axis interval
"HORZ_UNITS", "S"                        : Horizontal axis unit
"VERT_UNITS", "S", "V", "V"              : Vertical axis unit
"SIGNAL", "TIME", "ACH 1", "ACH 2" *2     : Signal name
"DATA"                                     : Data start
+0.000000E+00, -5.9375E-03, +9.3750E-04
+1.000000E-06, -5.6875E-03, +7.5000E-04

```

*1: Any set title comments are shown.

*2: Any set comment on each channel is shown.

Example 1

When the data for analog 4 channels and logic 4 channels is stored in Memory recorder function (Memory recorder function, memory data in Recorder&memory function, FFT function)

```

"COMMENT", "8841 MEM DATA"
"DATE", "01-01-1999"
"TIME", "10:10:00"
"NUM_SIGS", 9
"INTERVAL", 1.000E-06
"HORZ_UNITS", "S"
"VERT_UNITS", "S", "V", "V", "V", "V", "Bit", "Bit", "Bit", "Bit"
"SIGNAL", "TIME", "ACH 1", "ACH 2", "ACH 3", "ACH 4", "LCHA1", "LCHA2",
"LCHA3", "LCHA4"
"DATA"
+0.000000E+00, -5.9375E-03, +9.3750E-04, +2.3500E-03, -9.3750E-04, 1,1,1,1
+1.000000E-06, -5.6875E-03, +7.5000E-04, +2.4125E-03, -1.0312E-03, 1,1,1,1
+2.000000E-06, -5.5000E-03, +6.2500E-04, +2.3688E-03, -1.0437E-03, 1,1,1,1
+3.000000E-06, -5.5000E-03, +6.2500E-04, +2.4000E-03, -1.1750E-03, 1,1,1,1
+4.000000E-06, -5.3750E-03, +4.3750E-04, +2.4000E-03, -1.1687E-03, 1,1,1,1
+5.000000E-06, -5.6250E-03, -5.1875E-03, +1.0250E-03, -1.2187E-03, 1,1,1,1
+6.000000E-06, +4.3750E-04, -7.6875E-03, -1.1250E-03, -9.3750E-05, 1,1,1,1
+7.000000E-06, +2.1875E-03, -6.1875E-03, -1.6875E-03, +8.0000E-04, 1,1,1,1
+8.000000E-06, +1.5625E-03, -6.5000E-03, -2.0687E-03, +1.1687E-03, 1,1,1,1
+9.000000E-06, +1.3750E-03, -6.3750E-03, -2.2500E-03, +1.3125E-03, 1,1,1,1
+1.000000E-05, +1.3750E-03, -6.2500E-03, -2.2875E-03, +1.4250E-03, 1,1,1,1

```

Example 2

When the data is stored in Recorder function (Recorder function, RMS recorder function, recorder data in Recorder&memory function)

```
"COMMENT","8841 REC DATA"
"DATE","01-01-1999"
"TIME","10:10:00"
"NUM_SIGS",13
"INTERVAL", 1.000E-04
"HORZ_UNITS", "S"
"VERT_UNITS", "S", "V", "V", "V", "V", "Bit", "Bit", "Bit", "Bit", "Bit", "Bit", "Bit", "Bit"
"SIGNAL","TIME", "ACH 1(Max)", "ACH 1(Min)", "ACH 2(Max)", "ACH 2(Min)",
"LCHA1(Max)", "LCHA2(Max)", "LCHA3(Max)", "LCHA4(Max)", "LCHA1(Min)", "LCHA2(Min)",
"LCHA3(Min)", "LCHA4(Min)"
"DATA"
+0.000000E+00, +2.5000E-03, -8.5000E-03, +1.8125E-03, -8.9375E-03, 1,1,1,1, 0,0,0,0
+1.000000E-04, +2.2500E-03, -8.8125E-03, +1.8750E-03, -9.1250E-03, 1,1,1,1, 0,0,0,0
+2.000000E-04, +2.5000E-03, -8.7500E-03, +1.8125E-03, -9.2500E-03, 1,1,1,1, 0,0,0,0
+3.000000E-04, +2.4375E-03, -8.5000E-03, +2.0000E-03, -9.1250E-03, 1,1,1,1, 0,0,0,0
+4.000000E-04, +2.5625E-03, -8.6875E-03, +1.9375E-03, -9.3125E-03, 1,1,1,1, 0,0,0,0
+5.000000E-04, +2.3750E-03, -8.3750E-03, +1.9375E-03, -8.9375E-03, 1,1,1,1, 0,0,0,0
+6.000000E-04, +2.5000E-03, -8.8750E-03, +2.0625E-03, -8.8750E-03, 1,1,1,1, 0,0,0,0
+7.000000E-04, +2.3750E-03, -8.8125E-03, +1.8750E-03, -9.0625E-03, 1,1,1,1, 0,0,0,0
+8.000000E-04, +2.5000E-03, -8.6250E-03, +2.0625E-03, -9.3125E-03, 1,1,1,1, 0,0,0,0
+9.000000E-04, +2.3750E-03, -8.3750E-03, +2.0000E-03, -9.1875E-03, 1,1,1,1, 0,0,0,0
```

NOTE

The recorder, RMS recorder, and recorder & memory functions sample waveforms at a rate that exceeds that indicated by the time axis on the screen. Data captured is converted to sampling data for display according to the range being displayed on screen, and the maximum and minimum values during the sampling period are stored in memory. However, if data is thinned out, the thinned data is simply saved in thinned form.

14.8 Loading the Data (LOAD)

- The unit settings or the measurement data are transferred from the media to the memory of the unit.
- When loading measurement data, the channel can be specified.

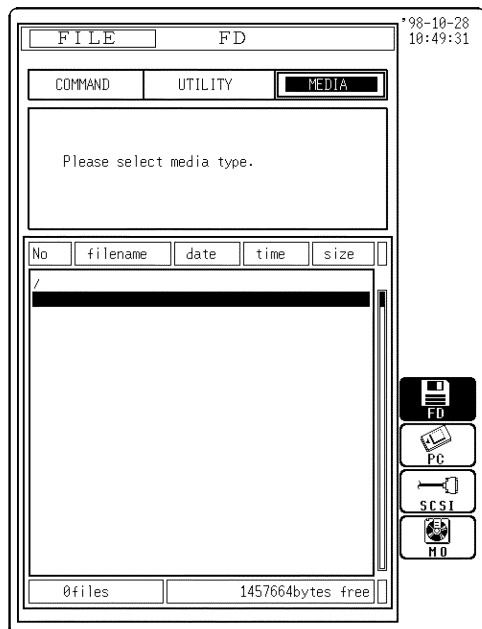

Procedure Screen: FILE

(1) Select the media to load.

1. Press the **FILE** key to display the FILE screen.
2. Move the flashing cursor to **MEDIA**.
3. Use the function keys to make selection.

Function display

Meaning



: Floppy disk media are used.



: PC card media are used.



: Select the external storage connected to the SCSI interface as the recording medium.



: MO disk media are used.

(2) Select the Command.

1. Use the Jog/Shuttle control or cursor key to select the desired file.
To load all the files stored in the batch save mode at once, select the index file.

2. Move the flashing cursor to **COMMAND**.

3. Use the function keys to select **LOAD**.

Function display

Meaning



: Save the data



: Load the data



: Information

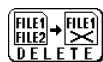

: Delete the data



: Make a directory

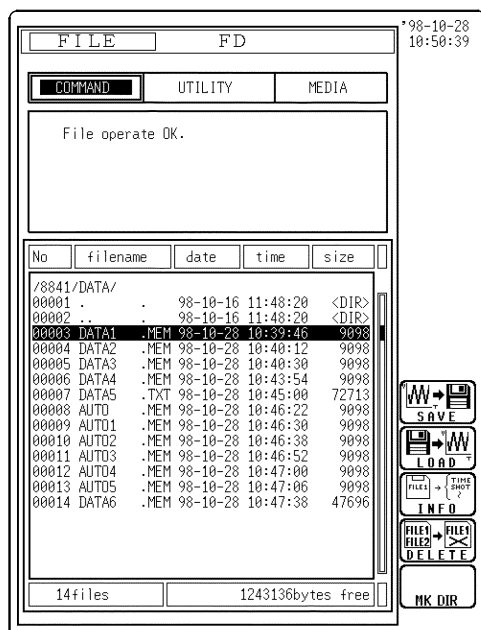

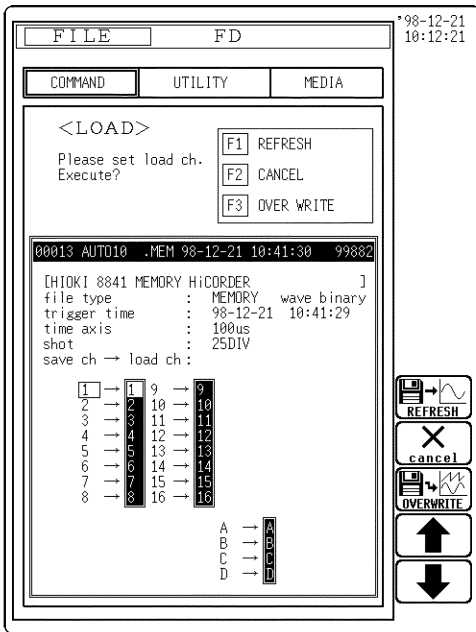

(3) Select the channel for loading data.

Select the channel for loading data.

Moving the cursor: use the cursor keys

Changing the channel no.: use the function keys or Jog/Shuttle control

(4) Execute the loading.

Select either of the following loading methods

Function display

Meaning



: Deletes the waveform data from the unit and load the new data.



: Cancel



: Load the new data by overwriting the waveform data already in the unit.



: Channel number up



: Channel number down.

NOTE

- In case of "OVERWRITE," the settings in the unit are given preference. When the data in the unit differs from the file functions or time-axis range, the data cannot be loaded.
- In FFT function, "OVERWRITE" cannot be used.
- "OVERWRITE" is not possible with data measured using external sampling.
- The data loading turn: CH1 16, CHA D
- If the plural data are loaded in the same channel, the data most recently sent remains in the memory.
- For correct execution of bulk-loading in an index file, do not change the name of the waveform file (which is created together with the index file), or move the waveform file to another directory, or erase the waveform file.
- The data can also be loaded from the INFORMATION screen.
- During ALL BLOCKS save with the Recorder & Memory function, files for the measurement data (extensions 'REC' and 'MEM') and an index file (R_M) are created. If only measurement data is read, it is read to each function. To read the data recorded by the recorder and memory functions, the index file must be read.
- Data stored in the text format is not readable by the 8841/42.

Auto Setup Function

When the power is switched on with a floppy disk or a PC card inserted, the setting up of the 8841/42 is performed automatically by reading the setting data file called "STARTUP.SET" and the evaluation area file called "STARTUP.ARE" on the floppy disk.

Waveform evaluation settings depend on "STARTUP.ARE"

The same measurement conditions can be simply established by using this function.

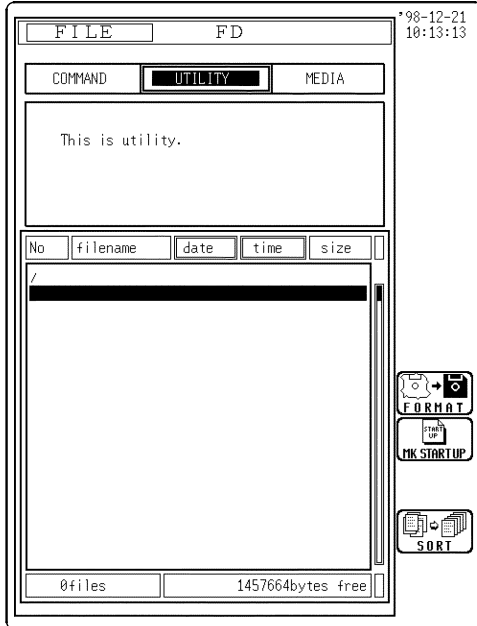

Procedure 1 Screen: FILE

1. Press the **FILE** key to display the FILE screen.
2. Move the flashing cursor to **MEDIA** and select the **FD** or **PC** function key.
3. Move the flashing cursor to **UTILITY**.
4. Select the **MK START UP** function key.
5. Select the **SETTING** function key.

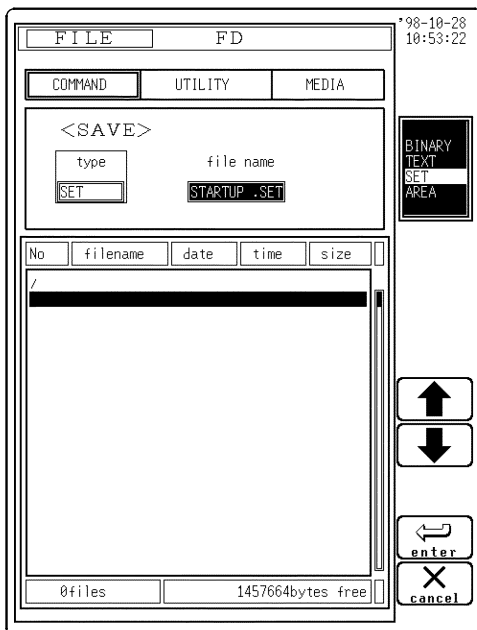

Procedure 2 Screen: FILE

1. Press the **FILE** key to display the FILE screen.
2. Move the flashing cursor to **MEDIA** and select the **FD** or **PC** function key.
3. Move the flashing cursor to **COMMAND**.
Move to the root directory, if the current directory is not the root.
4. Select the **save** function key and save the setup data file name as "STARTUP.SET" and area data file name as "STARTUP.ARE".

NOTE

- The file saved to the root directory is found, then setup is performed. The auto-setup file must be located in the root directory.
- If "STARTUP.SET" is present on both the FD and PC cards, the FD file is used.

Note on Overwrite loading

To load the measured data file into the 8841/42 when it already contains previously measured data, the previous data takes precedence over the new data (in such an event, "Partly").

Therefore, to reflect all the settings for the waveform data to be loaded, select "REFRESH." When the functions of the new data differ from those of the previous data (i.e., when the data exists in the memory recorder but you want to load the recorder data), the above operation is unnecessary.

Screens	WAVE (Binary)				SET
	MEM	REC	RMS	FFT	
STATUS1 screen STATUS2 screen STATUS3 screen STATUS4 screen	Partly *1 Partly -	/	/	- -	
STATUS screen	/	Partly	Partly	/	
TRIGGER screen	Partly*2	Partly*2	Partly*2	-	
CHANNEL screen	Partly*3	Partly*3	Partly*3	-	
Variable screen	Partly*3	Partly*3	Partly*3	-	
Scaling settings	Partly*3	Partly*3	Partly*3	-	
Comment settings	Partly*3	Partly*3	Partly*3	-	
SET UP (SYSTEM1)	-	-	-	-	

- : Set by the saving data Partly : Set by the unit setting
- : No data
- *1: When the index file is loaded, overwrite load is disabled.
- *2: While the trigger setting of each channel (internal trigger) is reflected, other trigger settings (such as the pre-trigger and external trigger) are not reflected.
- *3: In the case of "OVERWRITE," only the settings of loaded channels are reflected.

When the recording length of stored data and the recording length of the 8841/42 differ:

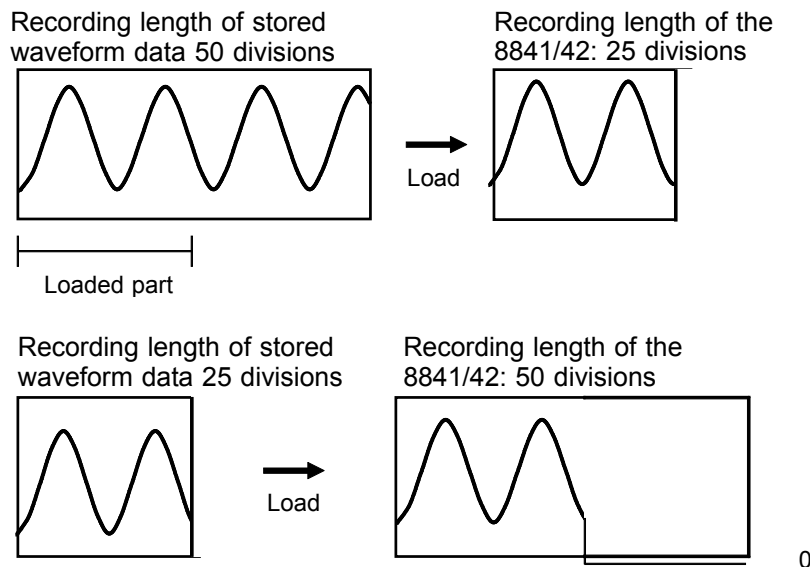

(0 : Bottom edge data value when no zoom function is applied to the voltage axis.)

14.9 File Information (INFO)

File information is displayed.

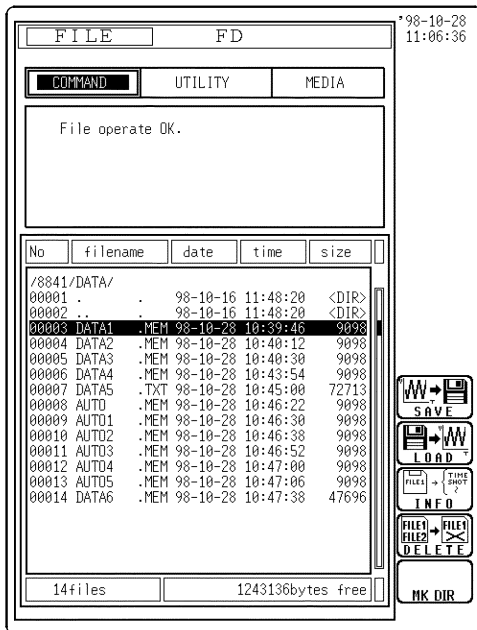





Procedure Screen: FILE

1. Press the **FILE** key to display the FILE screen.
2. Select **MEDIA**.
3. Use the Jog/Shuttle control or the cursor keys to select the desired file name.
4. Move the flashing cursor to **COMMAND**.

5. Use the function keys to select **INFO**.



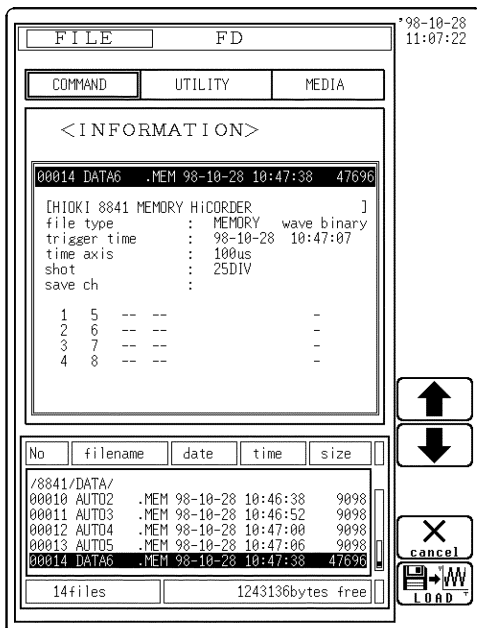

Information about the selected file is displayed.

From these files, only information that can be loaded to the 8841/8842 is displayed.

Function display	Meaning
	: Save the data
	: Load the data
	: Information
	: Delete the data
	: Make a directory



6. Display file information by moving the bar cursor in the FILE screen, using the function keys or Jog control.

Function display	Meaning
	: Bar cursor in the file list moves up.
	: Bar cursor in the file list moves down.
	: Exits file-information mode.
	: Loads the file at the line cursor.

14.10 Deleting the Data (DELETE)

Unit settings or measurement data are deleted from the file on selected media.

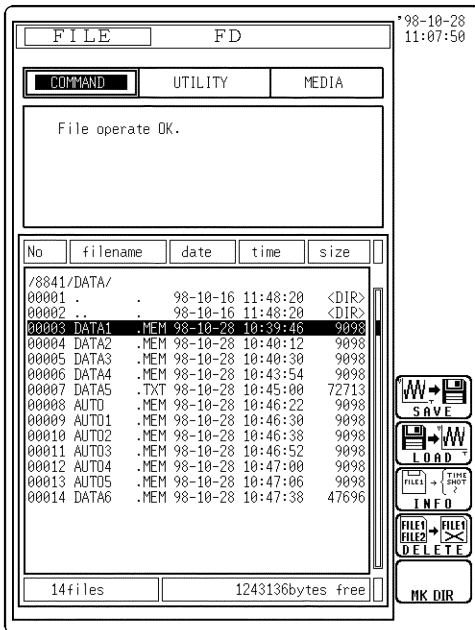

Procedure Screen: FILE

1. Press the **FILE** key to display the FILE screen.
2. Select **MEDIA**.
3. Move the bar cursor to the file to be deleted.
4. Move the flashing cursor to **COMMAND**.
5. Use the function keys to select **DELETE**.

Function display	Meaning
	: Save the data
	: Load the data
	: Information
	: Delete the data
	: Make a directory

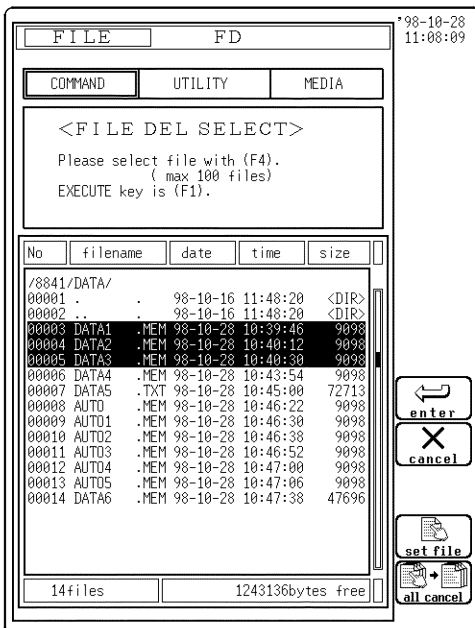

6. Use the cursor keys or Jog/Shuttle control to move the bar cursor to the file to be deleted, and select the **set file** function key.

Function display	Meaning
	: Determines a file to delete.
	: Cancels
	: Specifies a file to delete. Press the key once again to cancel selection.
	: Deletes all specified files.

7. Select the **enter** function key.
8. Select the **(exec)** function key. The window selected is displayed.

Function display	Meaning
	: Deletes the selected file.
	: Cancels

NOTE

- Up to 100 files may be deleted at a time.
- When files are selected with the bar cursor, a delete mark is displayed on the function key.

14.11 Sorting Files (SORT)

The file screen is sorted by type. The sort order can be selected from file name, date, file size and type (file extension).

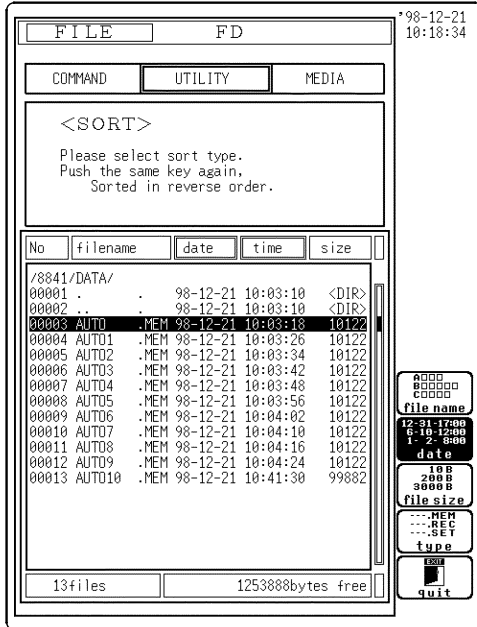

Procedure Screen: FILE

1. Press the **FILE** key to display the FILE screen.
2. Select **MEDIA**.
3. Move the flashing cursor to **UTILITY**.
4. Select the **Sort files** function key.
5. Use the function keys to make a selection.

Selecting the reverse display function key reverses the sort order.

Function display

Meaning

: Sorted in file name order

: Sorted in date order

: Sorted in file size order

: Sorted in file type (extension) order

: End

NOTE

- When directories and files are mixed, directories are always displayed before files.
- In the file list screen, sorted types are separated by !.

14.12 Operating the Directory

14.12.1 Making a Directory (MK DIR)

Creates a subdirectory on the selected medium.

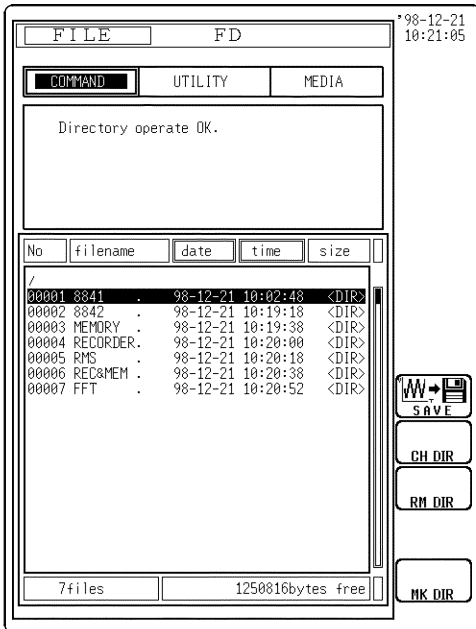





Procedure Screen: FILE

1. Press the **FILE** key to display the FILE screen.
2. Select **MEDIA**.
3. Move the flashing cursor to **COMMAND**.
4. Use the function keys to select **MK DIR**.
5. Use the function keys to select **INPUT**. Enter the directory name.

For character entry procedure, see Section 9.9.3.

Function display Meaning

-  : Enter a directory name.
-  : Delete a directory name.
-  : Make a directory.
-  : End

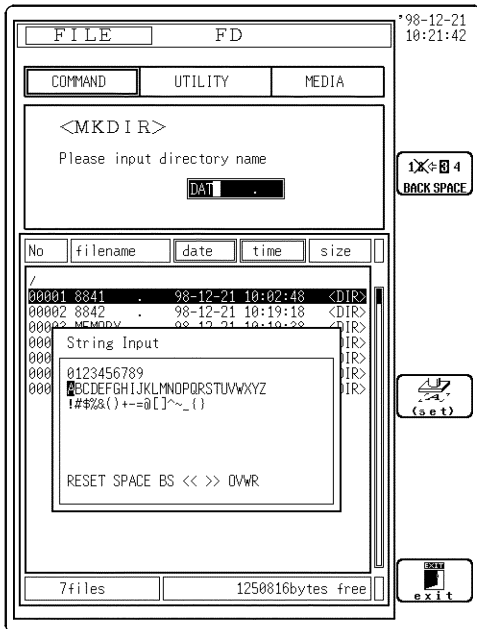

14.12.2 Changing a Directory (CH DIR)

A directory is changed. The 8841/42 provides direct movement only one layer up or down in the directory hierarchy.

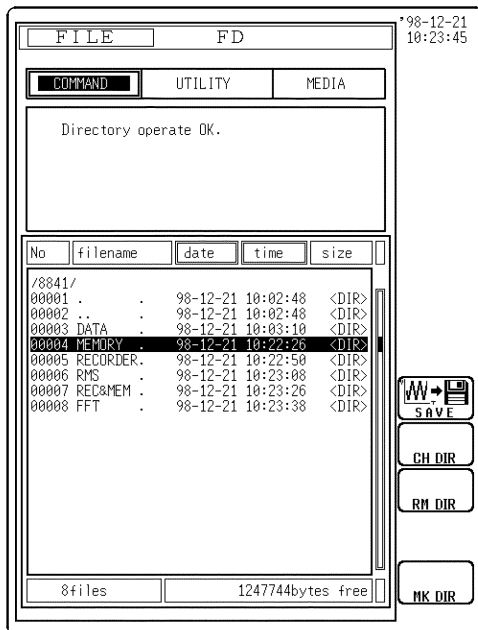

Procedure 1 Screen: FILE

1. Press the **FILE** key to display the FILE screen.
2. Select **MEDIA**.
3. Move the bar cursor.
4. Move the flashing cursor to **COMMAND**.
5. Select **CH DIR** function key.

To move to the lower directory:

Using the Jog/Shuttle control, or the cursor key, select the target directory on the bar cursor from the file list.

To move to the upper directory:

Using the Jog/Shuttle control, or the cursor key, select the target file name with "." on the bar cursor from the file list.

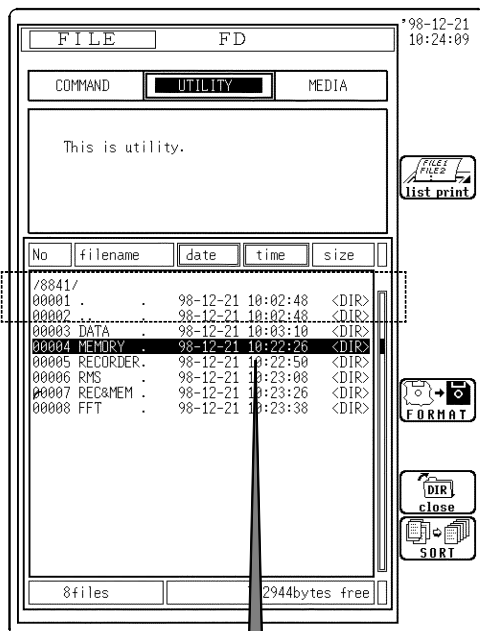

Procedure 2 (To move to the upper directory)

1. Press the **FILE** key to display the FILE screen.
2. Select **MEDIA**.
3. Move the flashing cursor to **UTILITY**.
4. Select the **close** function key.

You can move the bar cursor to the nearest upper-directory irrespective of the position of the cursor.

Directory organization

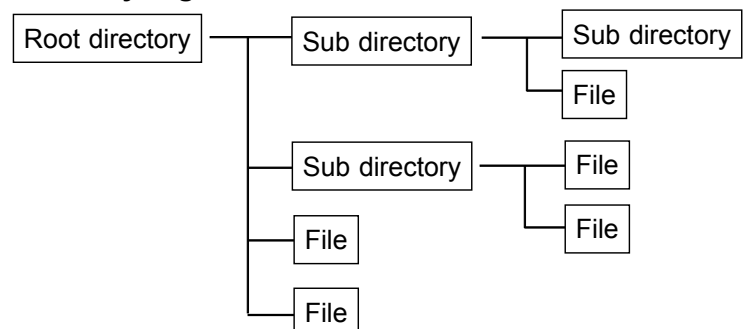

NOTE

- Stores a file in the directory currently selected on the FILE screen.
- The directory and the number of files that can be stored in the directory are limited. (See Section 14.7)

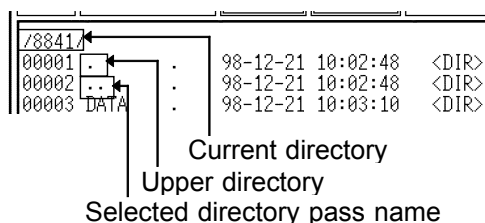

14.12.3 Deleting a Directory (RM DIR)

A directory is deleted. Even if there are files and directories in a directory, the directory can be deleted.

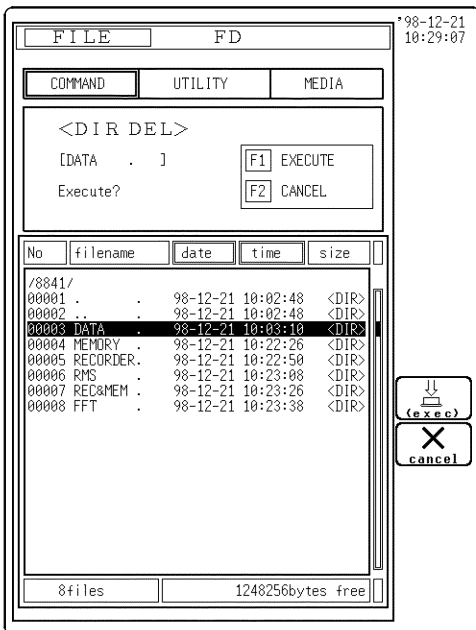

Procedure Screen: FILE

1. Press the **FILE** key to display the FILE screen.
2. Select **MEDIA**.
3. Using the Jog/Shuttle control, or the cursor key, select the target directory on the bar cursor from the file list.
4. Move the flashing cursor to **COMMAND**.
5. Select the **dir delete** function key, and then select (**exec**).
If a file is contained in the directory to be deleted, you are asked to confirm deletion.
6. Use the function keys to select (**exec**).

Function display Meaning

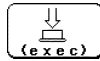

: Delete a directory.



: Cancel the deletion procedure.

14.13 Printing the File List

Prints a list of files (including directories) displayed on the file screen. The printing destination is selected by the "PRINT OUTPUT" setting.

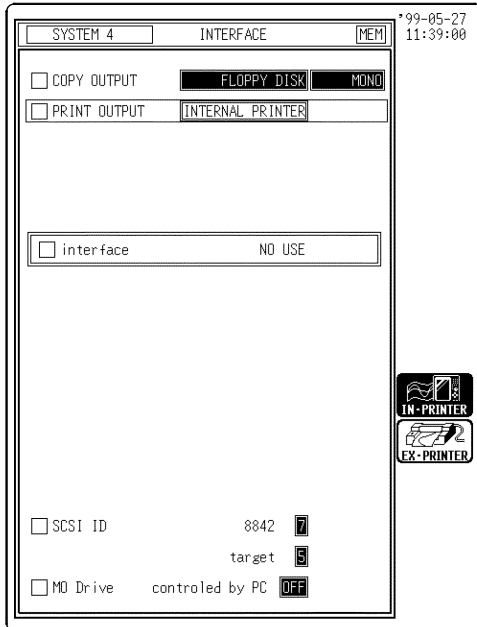

Procedure 1 Screen: SYSTEM - FILE

(1) Set the output destination by PRINT key.

1. Press the **SYSTEM** key to display the INTERFACE screen and select the **PRINT OUTPUT** item.
2. Select **INTERNAL PRINTER** or **EXTERNAL PRINTER**. See Section 12.5.2.

(2) Print the File List.

1. Press the **FILE** key to display the FILE screen.
2. Select **MEDIA**.
3. Display the list to be printed. If you want to print sub-directory contents, move to the directory to be printed (see Section 14.12.2).
4. Press the **VIEW** key to print.

NOTE

The data to be printed is that displayed on the file screen. Only directory names are printed; not their contents.

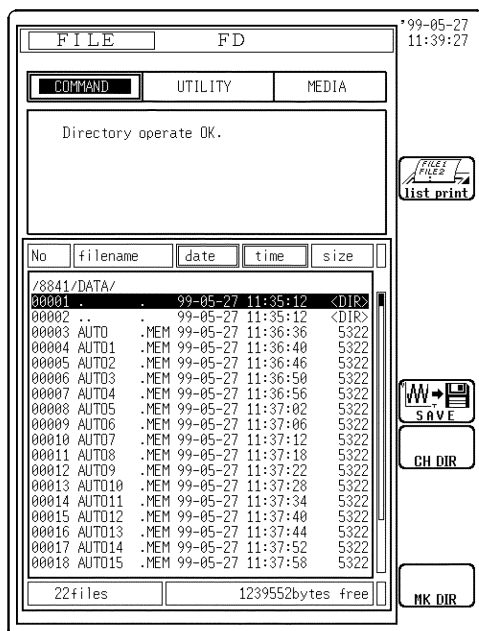

Chapter 15

Memory Segmentation Function

- This function divides the memory into separate blocks, each of which can be used for waveform recording.
- The memory segmentation function has two modes: sequential save and multi-block.

Sequential save function

- The recording length (DIV) has priority over the number of memory blocks.
- Input signal capture is carried out continuously using the trigger, storing waveform data successively in each block.
- During recording, no display or printout is carried out.
- This reduces dead time (non-sensitivity periods due to display and printing delays).
- Data from different blocks can be overlaid on screen for easy comparison. (it can be printed out)

Multi-block function

- The number of memory blocks has priority over the recording length (DIV).
- Waveform data can be stored in a selected block.
- Data from different blocks can be overlaid on screen for easy comparison. (it can be printed out)

Settings the Memory segmentation function

Setting the Sequential save function

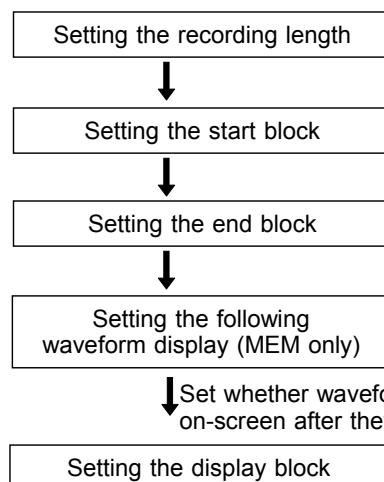

Set whether waveforms are displayed on-screen after they are recorded to the respective blocks.

Set the memory blocks to display on the screen after measurement is completed.

Setting the Multi-block function

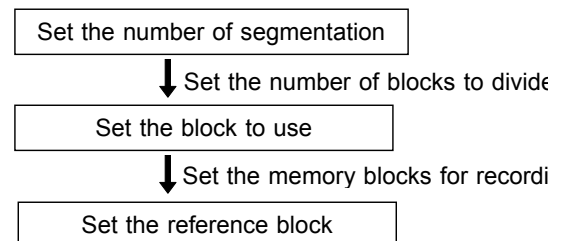

Set the block for reference to superimpose two memory blocks.

15.1 Using the Sequential Save Function

Input signal capture is carried out continuously using the trigger, storing waveform data successively in each block. Any block in which an input signal is recorded can be called up on the display. During measurement, displaying, printing, and saving cannot be carried out until the recording data in all block is completed.

When continuous print (auto print) is being performed in REPEAT trigger mode

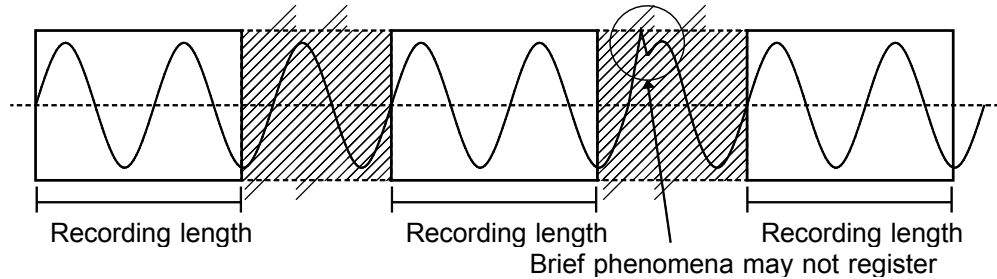

Using sequential save

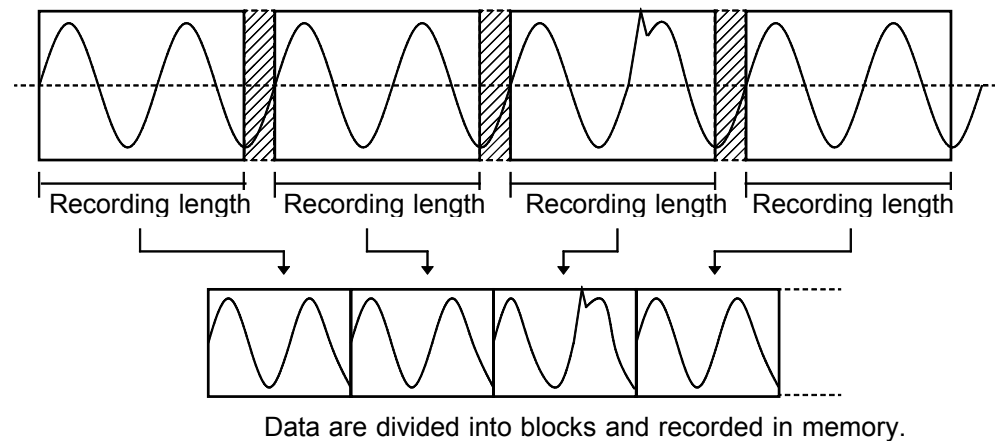

▨ ... Dead time: approx. 5 ms min.
(interval in which no sampling occurs due to display and print processing)

NOTE

- Down time during which no further data is sampled, in order to permit display and recording after the acquired data is recorded to one block, is set to about 15 ms when the view function is enabled by the memory recorder function, and to about 4 ms when the view function is disabled.
- The Recorder & Memory function is active within the range of $[2.5 \text{ ms} + \text{the recorder sampling cycle } (1/100 \text{ of the time axis range})]$ to $[2.5 \text{ ms} + \text{the recorder sampling cycle} \times 2]$.
- While the sequential save function is being used, the waveform processing calculation and averaging functions are disabled.
- While the roll mode is being used in memory recorder function, the sequential save function in the status is disabled.

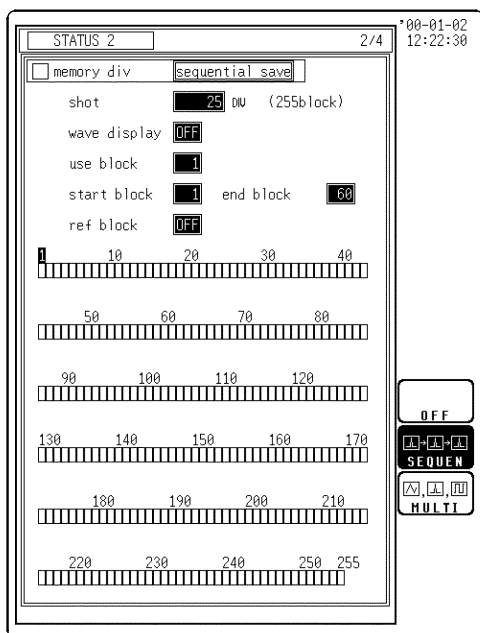

Procedure Screen: STATUS2

(1) Select the Memory Segmentation

1. Press the **STATUS** key to display the STATUS2 screen.
2. Move the flashing cursor to the position shown in the figure.
3. Select the **SEQUEN** function key.

Function display	Meaning
	: Disable memory segmentation
	: Enable sequential save function.
	: Enable multi-block function.

(2) Set the Recording Length.

1. Move the flashing cursor to the **shot** item.
2. Use the Jog/Shuttle control or the function keys to make the selection.

Function display	Meaning
	: Move the cursor up in the selection window.
	: Move the cursor down in the selection window.

When the recording length is set to the arbitrary recording-length mode, recording-length setting cannot be performed on the memory segmentation screen, and the symbol "#" is displayed before the recording length. When the recording length is changed to one for which memory segmentation is not permitted on the STATUS1 or the Waveform display screen, sequential saving is automatically set to OFF.

Maximum number of divisions

The recording length and maximum number of divisions are automatically determined according to the set memory capacity and number of available channels, as shown in the tables below. (See Section 12.2.1)

8 M words

Recording length (DIV)	Number of channels				Memory waveform in REC&MEM
	16	8	4	2	
25	127	255	255	255	63
50	63	127	255	255	31
100	31	63	127	255	15
200	15	31	63	127	7
500	7	15	31	63	3
1000	3	7	15	31	-
2000	-	3	7	15	-
5000	-	-	3	7	-
10000	-	-	-	3	-

32 M words

Recording length (DIV)	Number of channel				Memory waveform in REC&MEM
	16	8	4	2	
25	255	255	255	255	255
50	255	255	255	255	127
100	127	255	255	255	63
200	63	127	255	255	31
500	31	63	127	255	15
1000	15	31	63	127	7
2000	7	15	31	63	3
5000	3	7	15	31	-
10000	-	3	7	15	-
20000	-	-	3	7	-
40000	-	-	-	3	-

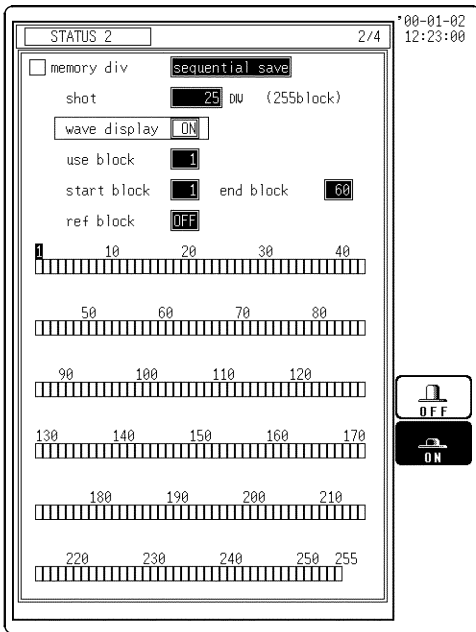

(3) Set the follow-up waveform display (MEM only).

Waveforms acquired for each block by triggering during the sequential saving process are displayed one by one. As a result, the dead time is increased.

1. Move the flashing cursor to the **wave display** item, as shown in the figure on the left.
2. Use the Jog/Shuttle control or the function keys to make the selection.

Function display	Meaning
	: After all blocks are recorded, the waveform of the last block only is displayed.
	: Each block is recorded and displayed.

(4) Display block setting

Set the block to be displayed. The recording start time and time axis range are displayed on the window.

1. Move the flashing cursor to the **use block** item, as shown in the figure on the left.
2. Use the Jog/Shuttle control or the function keys to make the selection.

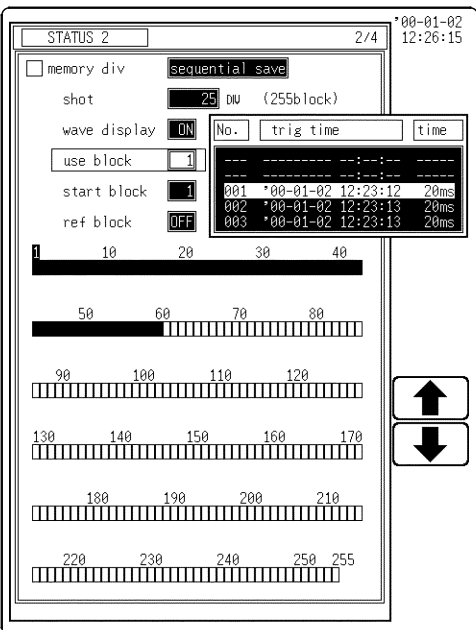

Function display	Meaning
	: Increases in number.
	: Decreases in number.

After measurement starts, the displayed block is updated by the recorded block.

When measurement is completed, the most recently recorded block is displayed.

(5) Start/end block setting

1. Move the flashing cursor to the **start block** or **end block** item.
2. Use the Jog/Shuttle control or the function keys to make the selection.

Function display	Meaning
	: Increases in number.
	: Decreases in number.

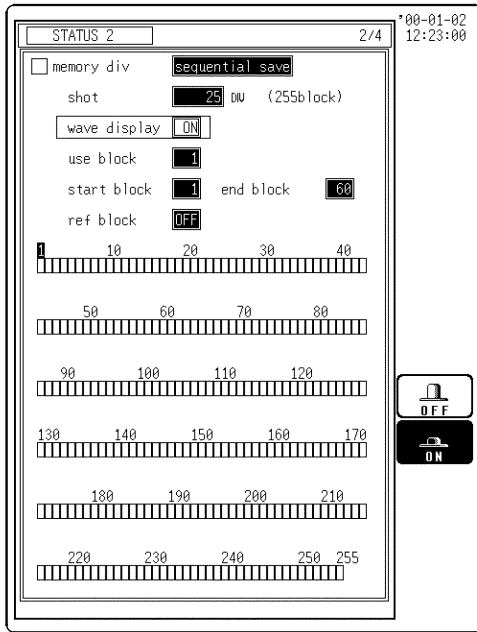

(6) Setting ref blocks

Waveform data recorded in multiple blocks can be displayed in a composite display.

1. Move the flashing cursor to the **ref block** item.
2. Use the function keys to make the selection.

Function display

Meaning



: Disable ref block



: Enable ref block

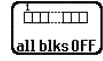

: Turns off all ref block settings.

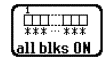

: Sets all blocks as ref blocks.

3. Move the flashing cursor to the numerical value item (ref block). Ref block settings can be made one block at a time. Blocks set as ref blocks are marked with an asterisks.

NOTE

- The colored blocks indicate that measured data has been saved to the blocks.
- The displayed block settings and block status are shown on the display screen. (See Section 11.6.)

Relation between trigger mode and sequential save function

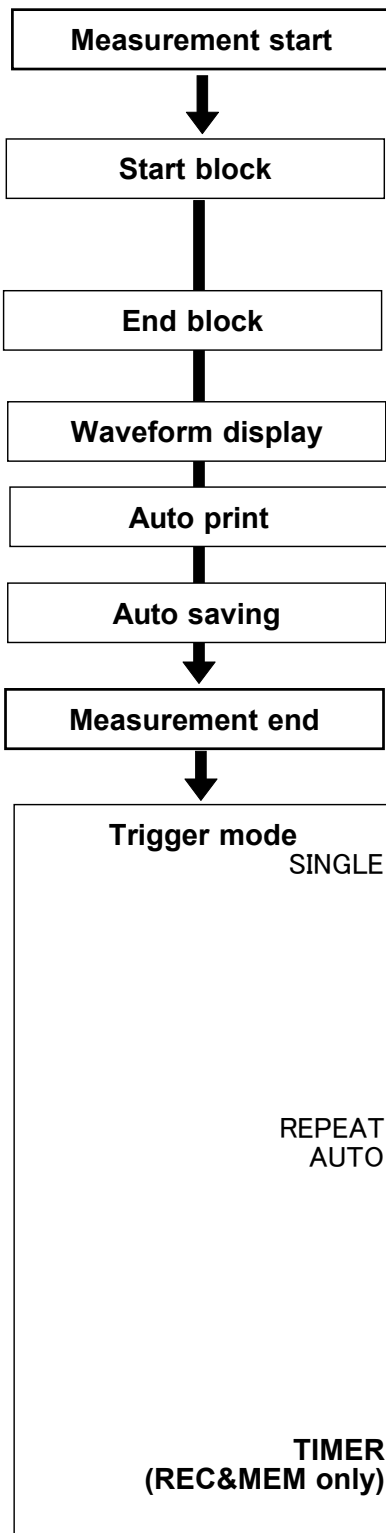

Press the **START** key and LED light.

Data recording starts when trigger condition are met.

Measurement start

Start block

Start block is stored by trigger setting.

The following waveform display ON:
waveform is displayed.

The following waveform display OFF:
waveform is not displayed.

End block

End block is stored by trigger setting.

The following waveform display ON:
waveform is displayed.

The following waveform display OFF:
waveform is not displayed.

Waveform display

Auto print

Displays end block waveform.

Auto saving

When auto printing is enabled, all blocks are printed from the start block while individual blocks are displayed.

Measurement end

When auto saving is enabled, waveforms in all blocks are saved in a batch.

Trigger mode

SINGLE

• End of measurement

(MEM) When the **STOP** key is pressed twice during measurement, the 8841/42 is forcibly stopped. (Auto printout and auto save are not executed.)

(REC&MEM) When the **STOP** key is pressed once during measurement, the 8841/42 is forcibly stopped.

(MEM) Each time when trigger conditions are met, data are recorded and memory contents are overwritten.

REPEAT
AUTO

• End of measurement

If the **STOP** key is pressed during recording, recording continues until the end of the current block.

(Waveform display, auto printout and auto save are executed.)

When the **STOP** key is pressed twice during measurement, the 8841/42 is forcibly stopped. (Auto printout and auto save are not executed.)

(REC&MEM) Measurement is started again. The memory waveform data is cleared.

TIMER
(REC&MEM only)

• End of measurement

When the **STOP** key is pressed once during measurement, the 8841/42 is forcibly stopped.

When recording with a preset time interval, recording continues until the preset stop time.

If the **STOP** key is pressed during measurement, measurement is terminated.

The memory waveform is cleared after each preset time period.

NOTE

When the following waveform display (memory recorder) is on and the view function is on, the dead time becomes very large.

15.2 Using the Multi-Block Function (MEM)

- Memory is divided into blocks which can be freely selected by the user for storing measurement data.
- Data stored in any block can be called up on the display.
- Data from different blocks can be overlaid on screen for easy comparison. (it can be printed out)

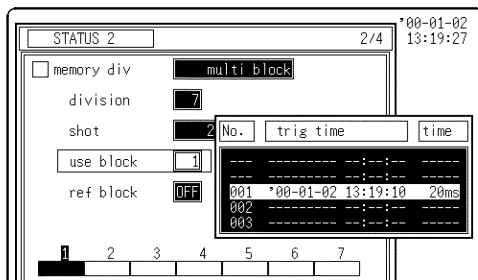
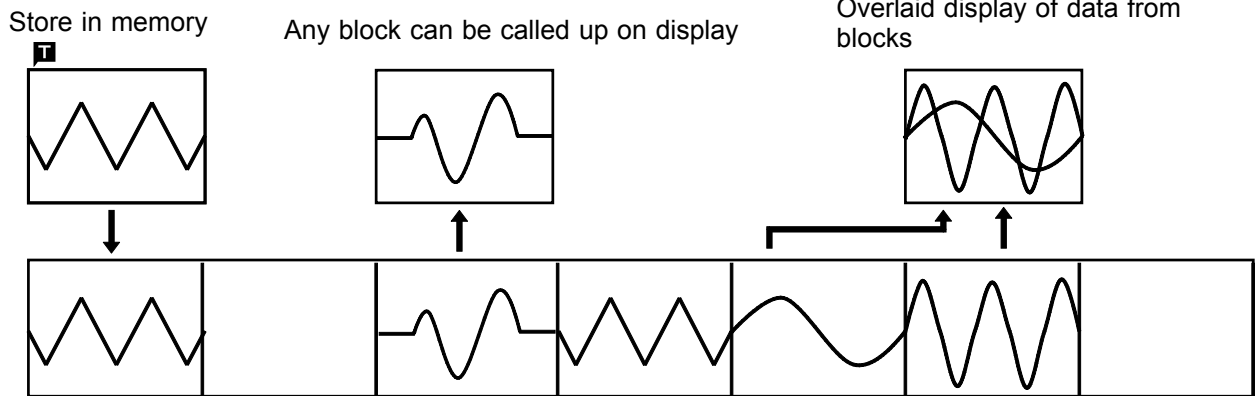

(1) Recording the waveform data in an arbitrary block

1. Set the number of memory divisions.
2. Select the block to be used for saving the waveform data, from among the divided blocks on the **use block** menu.
3. Press the **START** key to conduct measurement and save waveform data to the specified block.

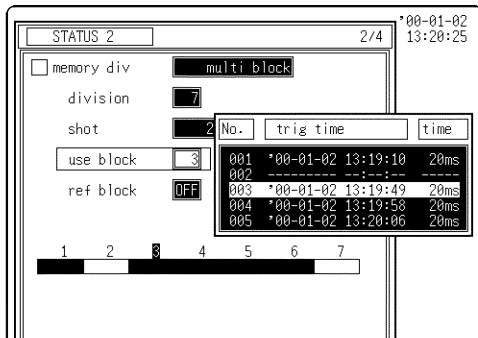

(2) Displaying an arbitrary block

Select the block to be used to display the waveform data, from among the recorded blocks on the **use block** menu.

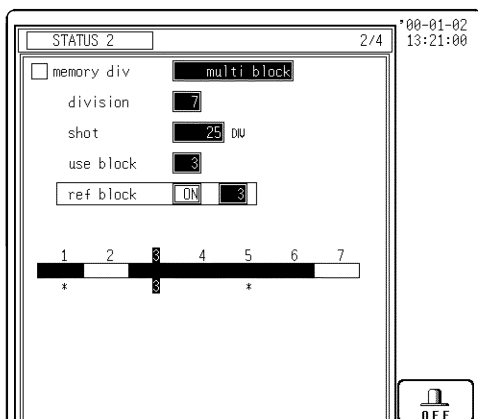

(3) Displaying arbitrary blocks in duplicate

1. Save at least two waveform data items.
2. Select the block to be used to display waveform data, from among the recorded blocks on the **use block** menu.
3. Select the block to be displayed in duplicate on the **ref block** menu.
4. Display the block selected from the **use block** menu and the block selected from the **ref block** menu, in duplicate. Note that waveform data cannot be saved while blocks are overlapping.

NOTE

- While the multi-block function is being used, the waveform processing calculation and averaging functions are disabled.
- If the blocks have different recording lengths, the overlap block display is disabled.
- The **VIEW** key can be used to change the displayed memory block or to display information about the usage status of memory blocks. See Section 11.6.

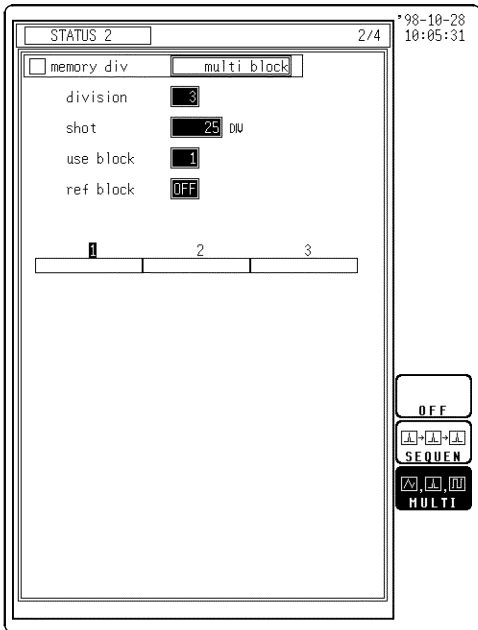

Procedure Screen: STATUS2 (memory recorder)

(1) Select the Memory segmentation.

1. Press the **STATUS** key to display the STATUS2 screen.
2. Move the flashing cursor to **memory div**.
3. Select **MULTI** function key.

Function display

Meaning



: Disable memory segmentation

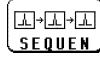

: Enable sequential save function.



: Enable multi-block function.

(2) Set the number of memory block.

1. Move the flashing cursor to the **division** item, as shown in the figure.
2. Use the Jog/Shuttle control or the function keys to make the selection.

Function display

Meaning



: Move the cursor up in the selection window.



: Move the cursor down in the selection window.

(3) Set the recording length.

1. Move the flashing cursor to **shot**.
2. Use the Jog/Shuttle control or the function keys to make the selection.

Function display

Meaning



: Move the cursor up in the selection window.



: Move the cursor down in the selection window.

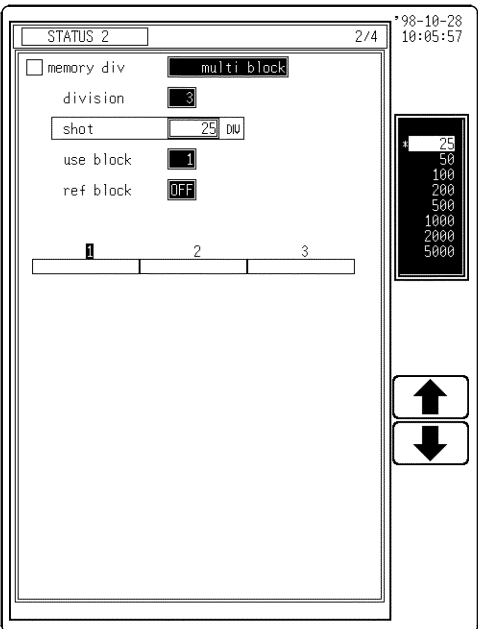

When the recording length is set to the arbitrary recording-length mode, recording-length setting cannot be performed on the memory segmentation screen. The symbol "#" is displayed before the recording length. When the recording length is changed to one for which memory segmentation is not permitted on the STATUS1 or the Waveform display screen, multi-block saving is automatically set to OFF.

Maximum number of divisions

The maximum number of divisions and the maximum recording length are automatically determined according to the set memory capacity and number of available channels, as shown in the tables below.

8 M words

32 M words

Number of divisions	Number of channels				Number of divisions	Number of channels			
	16	8	4	2		16	8	4	2
3	1000	2000	5000	10000	3	5000	10000	20000	40000
7	500	1000	2000	5000	7	2000	5000	10000	20000
15	200	500	1000	2000	15	1000	2000	5000	10000
31	100	200	500	1000	31	500	1000	2000	5000
63	50	100	200	500	63	200	500	1000	2000
127	25	50	100	200	127	100	200	500	1000
255	-	25	50	100	255	50	100	200	500

NOTE

When using the multi-block function, the number of memory blocks has priority over the recording length (DIV). When the number of memory blocks is changed, the recording length may automatically be adjusted.

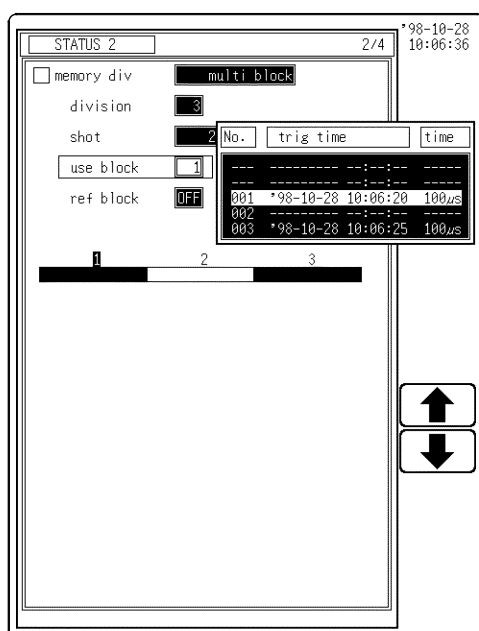

(4) Set the using block.

Select the number of the memory block for display and recording of the input signal waveform. Specify the block to be displayed on the Waveform display screen.





1. Move the flashing cursor to the **use block** item, as shown in the figure on the left.
2. Use the Jog/Shuttle control or the function keys to make the selection.

Function display	Meaning
	: Increases in number.
	: Decreases in number.





(5) Set the ref block.

Select a memory block whose waveform data are to be overlaid on screen with the memory block selected for display. The recording start time and time axis range are displayed on the window.

1. Move the flashing cursor to the **ref block** item.
2. Use the function keys to make the selection.

Function display	Meaning
	: Disable ref block
	: Enable ref block
	: Turns off all ref block settings.
	: Sets all blocks as ref blocks.

3. Move the flashing cursor to the numerical value item (ref block).
Ref block settings can be made one block at a time. Blocks set as ref blocks are marked with an asterisks.

Function display	Meaning
	: Increases in number.
	: Decreases in number.
	: Enable ref block
	: Disable ref block

Chapter 16

Waveform Operation Function

16.1 Waveform Parameter Calculation (MEM)

- Available for memory recorder function and REC&MEM function.
The Memory waveform for the Record & Memory function is performed with the Memory recorder function.
- Parameters that were used for captured waveform data and for data after waveform processing can be determined. The result is shown in numeric form.
- The A•B cursors (vertical, trace) can be used to determine the parameters of a certain range.
- The following 14 types of calculations are possible:
 - (1) Average value, (2) RMS value, (3) peak-to-peak value
 - (4) Maximum value, (5) time to maximum value, (6) minimum value,
 - (7) time to minimum value, (8) period, (9) frequency, (10) rise time,
 - (11) fall time, (12) standard deviation, (13) area value, (14) X-Y area value

Waveform parameter calculation Operating Sequence

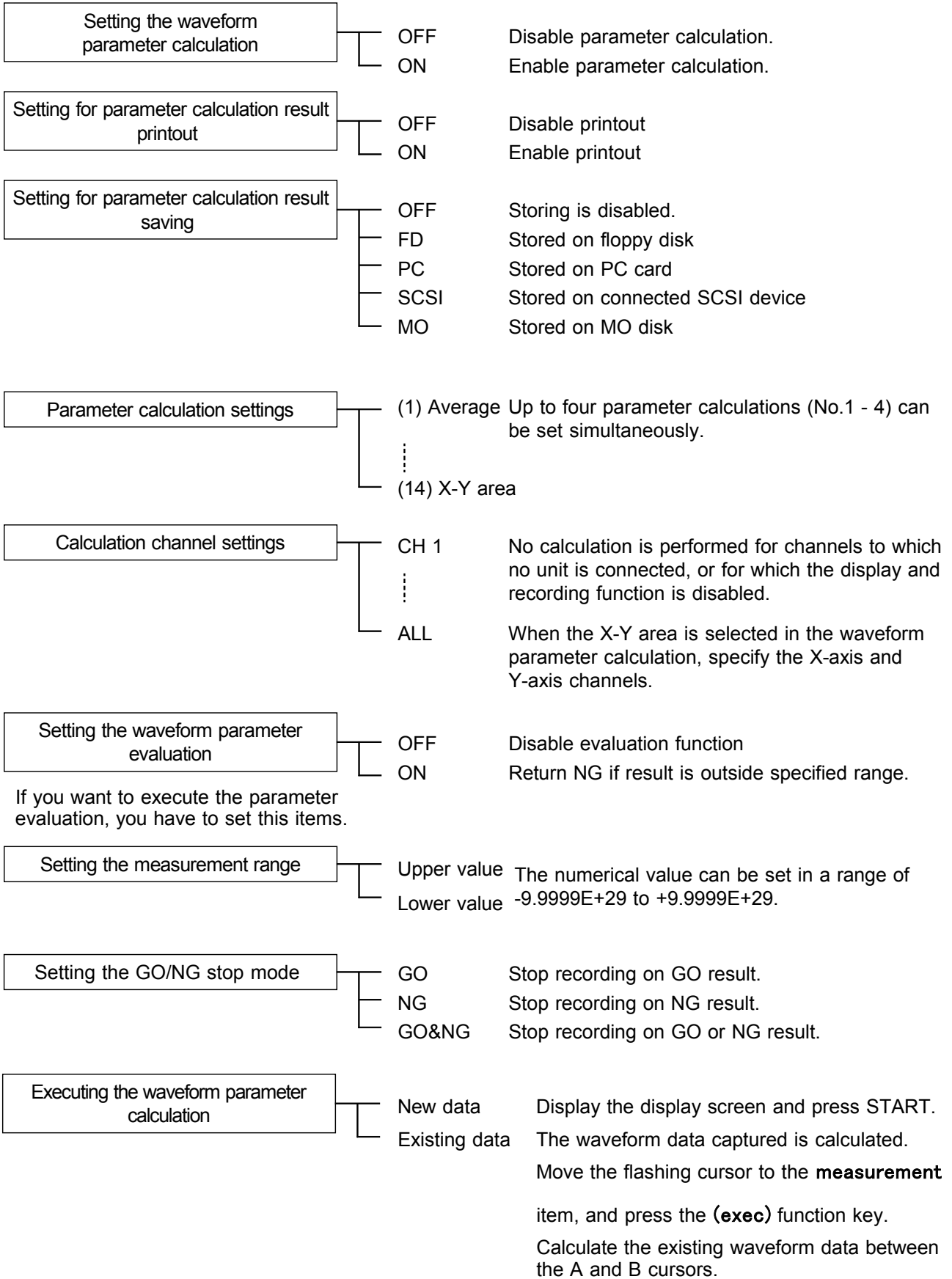

16.1.1 Making Settings for Waveform Parameter Calculation

Waveform parameter calculations results can be printed on the internal printer.

Waveform parameter calculations results can be saved in text format to the current directory selected in the FILE screen.

For the file name to be saved, see Section 14.7, "Saving the Data."

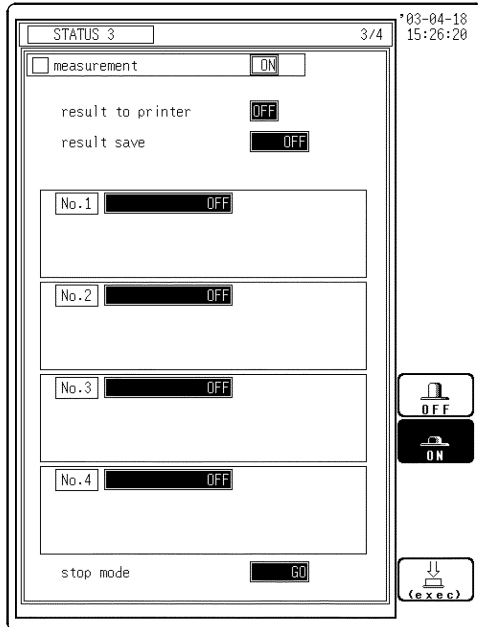

Procedure Screen: STATUS3

(1) Set the waveform parameter calculation.

1. Press the **STATUS** key to display the STATUS3 screen.
2. Move the flashing cursor to **measurement**.
3. Use the function keys to make the selection.

Function display	Meaning
	: Disable parameter calculation
	: Enable parameter calculation. The various setting items are displayed.
	: Execute Waveform Parameter Calculation.

(2) Set for parameter calculation result printout and saving

1. Move the flashing cursor to **result to printer**
2. Use the function keys to make the selection.

Function display	Meaning
	: Disable printout of parameter calculation results
	: Enable printout of parameter calculation results

3. Move the flashing cursor to **result save**.
4. Use the function keys to make the selection.



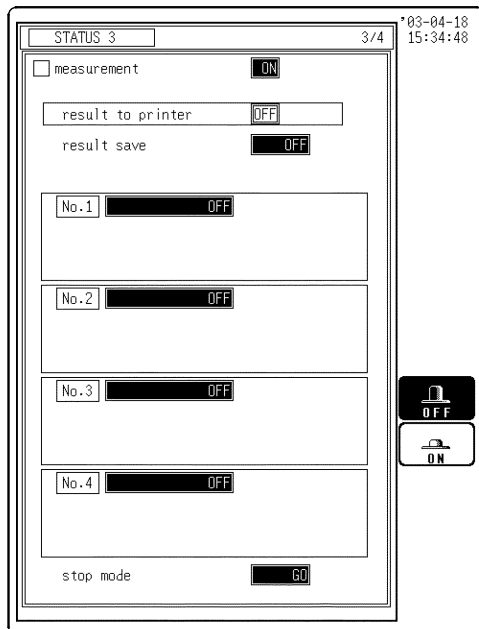

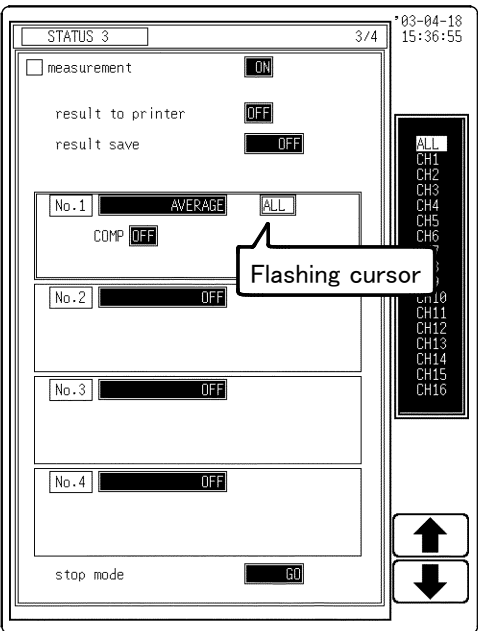
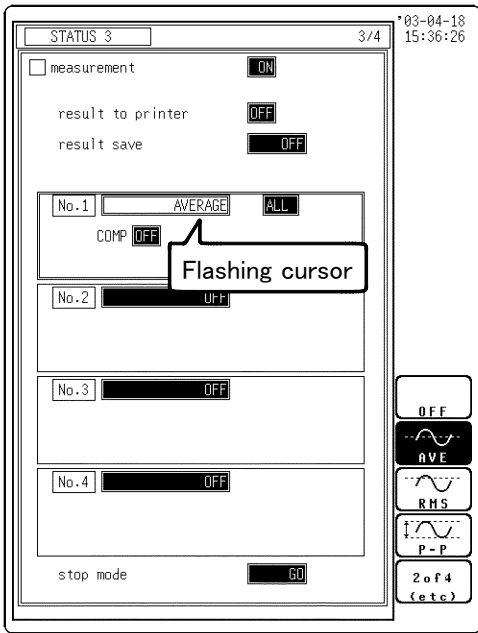









Function display	Meaning
	: Storing is disabled.
	: Stored on floppy disk.
	: Stored on PC card
	(When using the LAN card) : A LAN is used to transfer data to the 9333 LAN COMMUNICATOR.
	: Stored on connected SCSI device
	: Stored on MO disk







(3) Select parameter calculation

1. Move the flashing cursor to the position shown in the figure on the left.
2. Use the function keys to make the selection.
Up to four parameter calculations (No. 1 - 4) can be set simultaneously.

 : Disable calculation	 : Period
 : Average value	 : Frequency
 : RMS value	 : Rise time
 : Peak-to-peak value	 : Fall time
 : Maximum value	 : Standard deviation
 : Time to maximum value	 : Area value
 : Minimum value	 : X-Y area value
 : Time to minimum value	

(4) Set the calculation channel

1. Move the flashing cursor to the position shown in the figure on the left.
2. Use the function keys or the Jog/Shuttle control to make the selection.

Function display	Meaning
	: Increase channel number.
	: Decrease channel number.

NOTE

- The channels where no units are installed, a channel that deviates from the set active channel range and channels for which display/record is set to "OFF" will not be calculated.
- When the X-Y area value is selected in parameter calculation, channels on the X and Y axes should be specified. "ALL" cannot be selected.
- Even if the display format is not the X-Y screen, the X-Y area value can be selected.

16.1.2 Making Settings for Waveform Parameter Evaluation

- Depending on the results of the waveform parameter calculation, a GO (pass) or NG (fail) result is returned.
- Evaluation criteria can be set independently for each of the calculation sets No. 1 - No. 4.

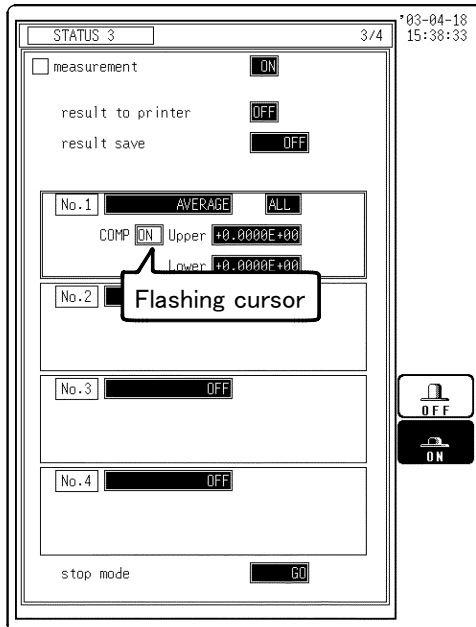

Procedure Screen: STATUS3

1. Make the settings for waveform parameter calculation.
2. Move the flashing cursor to **COMP**, and use the function key to select.

Function display Meaning



: Disable evaluation function.



: Return NG if result is outside specified range.

3. Set the upper and lower limits.
Use the cursor keys or the Shuttle control to move the flashing cursor and make a setting. The settings can be made by using the numerical value input key. The setting range is $-9.9999E+29$ to $+9.9999E+29$ (exponent: -29 to +29).
The upper limits must not be smaller than the lower limits, or the lower limits must not be larger than the upper limits.

- When waveform parameter measurement and waveform evaluation are carried out simultaneously, the both evaluation results are displayed on the screen. Check the results of parameter evaluation using "*" (NG decision) accompanying the figure. Alternatively, a beeping sound can be used for the evaluation instead of the "*" mark; the machine beeps if the result of either parameter or waveform evaluation is NG.
- When the evaluation result is NG, the calculation value for that channel is marked with an "*" (on the display and the printout).
The result of the evaluation is NG if any of the values is NG.

Evaluation result

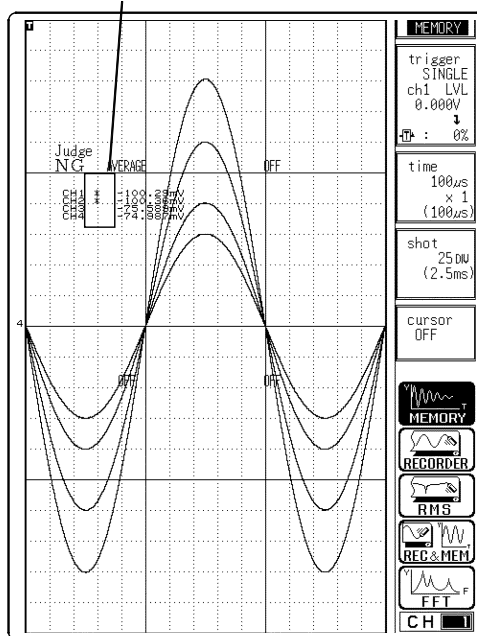

NOTE

- While all evaluation results appear on the display screen, the evaluation results are printed out for each parameters in the print mode.
- When the evaluation result is NG, an NG output signal can be obtained between the NG terminal and the GND terminal. For details, please refer to the Section 17.1.6.
- The waveform parameter calculation is set to ON, the settings by using the **CH.SET** key are automatically set to OFF.

16.1.3 Setting the Waveform Parameter GO/NG Stop Mode

Specify which evaluation option, GO or NG, should be used to stop the recording.

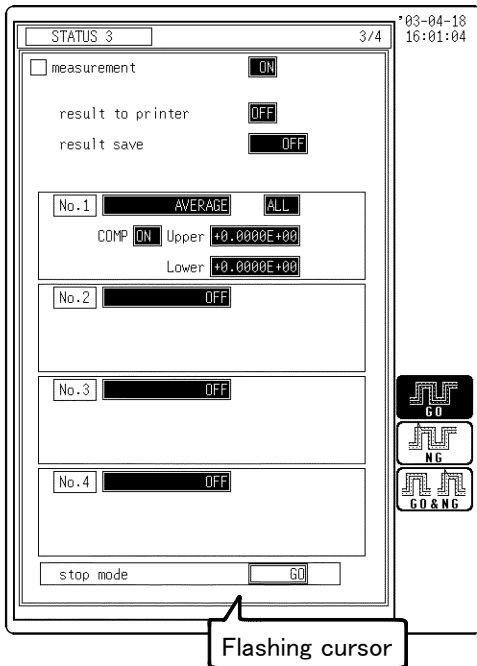

Procedure Screen: STATUS3

1. Move the flashing cursor to the position "stop mode".
2. Make the setting with the function keys.

Function display

Meaning



: Stop recording on GO result.



: Stop recording on NG result.



: Stop recording on GO or NG result.

16.1.4 Executing Waveform Parameter Calculation

- Calculation is carried out in the order No.1 through No.4.
- Also for channels where no input unit is installed, parameter calculation is carried out if waveform processing results or data loaded from media are stored in the channel.
- The scaling setting has effect. (RMS value and area value are calculated after scaling.)
- When "wave calculation" is set to ON, waveform data after waveform processing are used for parameter calculation.

Parameter calculation while capturing the waveform

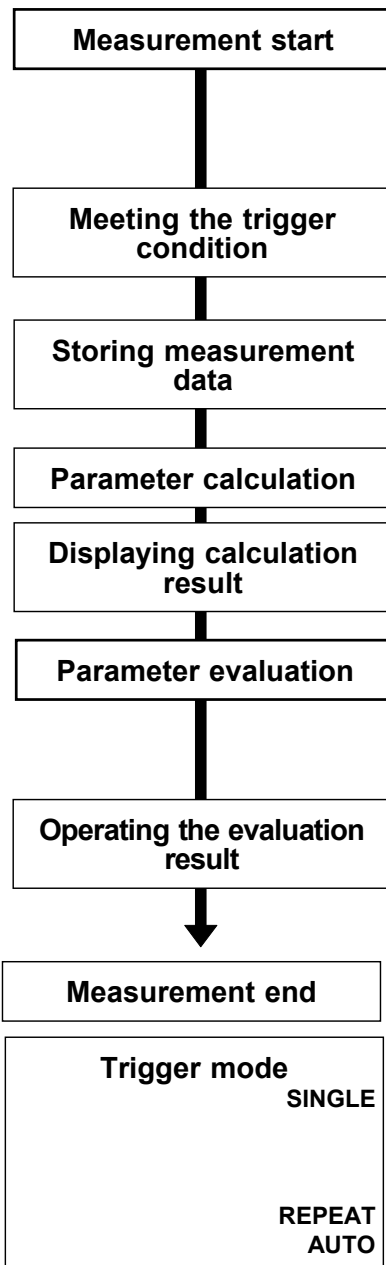

- Press the **START** key and LED light.
 - When the pre-trigger is set, the trigger will not be registered for a certain period after the start of measurement. (During this interval, Pre-trigger standby is shown on the display.)
 - When the trigger can be registered, the indication Waiting for trigger is shown on the display.
 - Data recording starts when trigger condition are met.
 - When trigger mode selected AUTO, unit waits for about 1 second for trigger conditions to be met. After this interval, data recording starts, regardless of trigger state.
 - Displays "Storing". Waveform displays after data corresponding to recording length have been stored in memory.
 - When the **STOP** key is pressed twice during measurement, the 8841 is forcibly stopped. (Parameter calculation are not executed.)
- Displays "Calculating".
- Displays parameter calculation result on the screen.
- Depending on the results of the waveform parameter calculation, a GO (pass) or NG (fail) result is returned.
- When the evaluation result is GO:
- Outputs GO signal.
- When the evaluation result is NG:
- Outputs NG signal.
 - The calculation value for that channel is marked with an "*" (on the display and the printout).
 - Measurement is repeated until the stop conditions are met.
- | | |
|----------------------|--------------------------------|
| Result to printer ON | Prints the evaluation results. |
| Result save ON | Saves the evaluation results. |
| Auto print ON | Prints the measurement data. |
| Auto save ON | Saves the measurement data. |

End of measurement.

Each time when trigger conditions are met, data are recorded and memory contents are overwritten.

End of measurement in REPEAT and AUTO trigger modes
When the **STOP** key is pressed once during measurement, the 8841/42 acquires measurement data in an amount corresponding to the set recording length, and the measurement is stopped. (Waveform display, Parameter calculation are executed.)

NOTE

When waveform parameter evaluation and waveform evaluation are carried out simultaneously, measurement stops when either of the stop conditions is met.

Calculation of data stored in memory

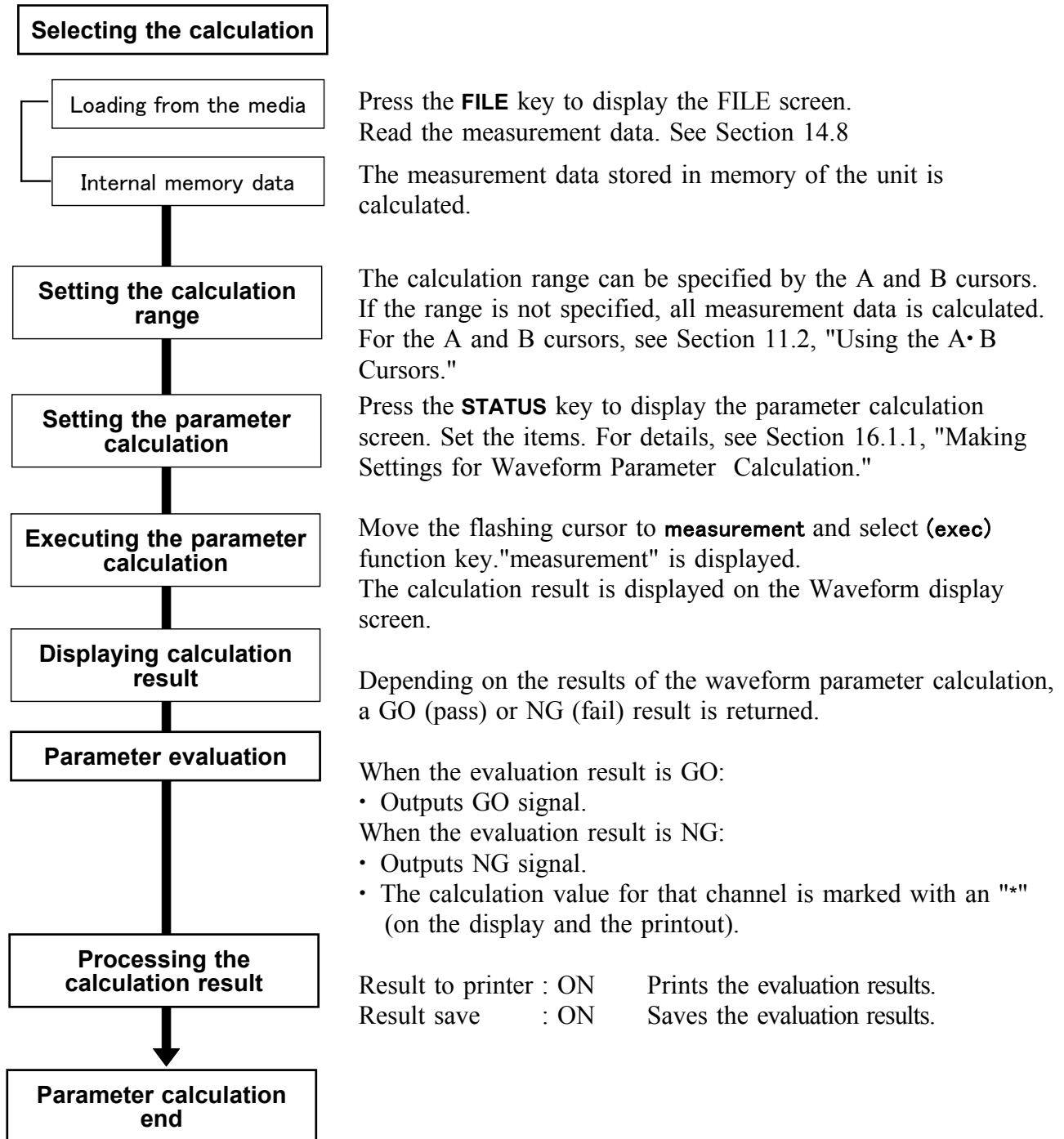

NOTE

- Line cursor (horizontal) can not be set calculating ranges.
- When only the cursor A is used, the waveform data from the position of cursor A to the end of the data is calculated.
- The result can be recalculated by altering the calculation process.

16.2 Calculating Waveform Data

- Waveform processing is possible only for the memory recorder function and REC&MEM function.
The Memory waveform for the Record & Memory function is performed with the Memory Recorder function.
- Processing result are displayed as a waveform.
- The maximum recording length allowing waveform processing calculation is 1000 divisions (5000 divisions for 32 M words).
- Use the A·B cursors to specify the processing range for the waveform data within the maximum recording length .
- The following operators can be used to define processing equations.
 - (1) Arithmetic operators (+, -, *, /)
 - (2) Absolute value (ABS)
 - (3) Exponent (EXP)
 - (4) Logarithm (LOG)
 - (5) Square root (SQR)
 - (6) Displacement average (MOV)
 - (7) Parallel displacement on time axis (SLI)
 - (8) 1st and 2nd differential (DIF, DIF2)
 - (9) 1st and 2nd integral (INT, INT2)
 - (10) Trigonometric functions (SIN, COS, TAN)
 - (11) Reverse trigonometric functions (ASIN, ACOS, ATAN)

Waveform Processing procedure

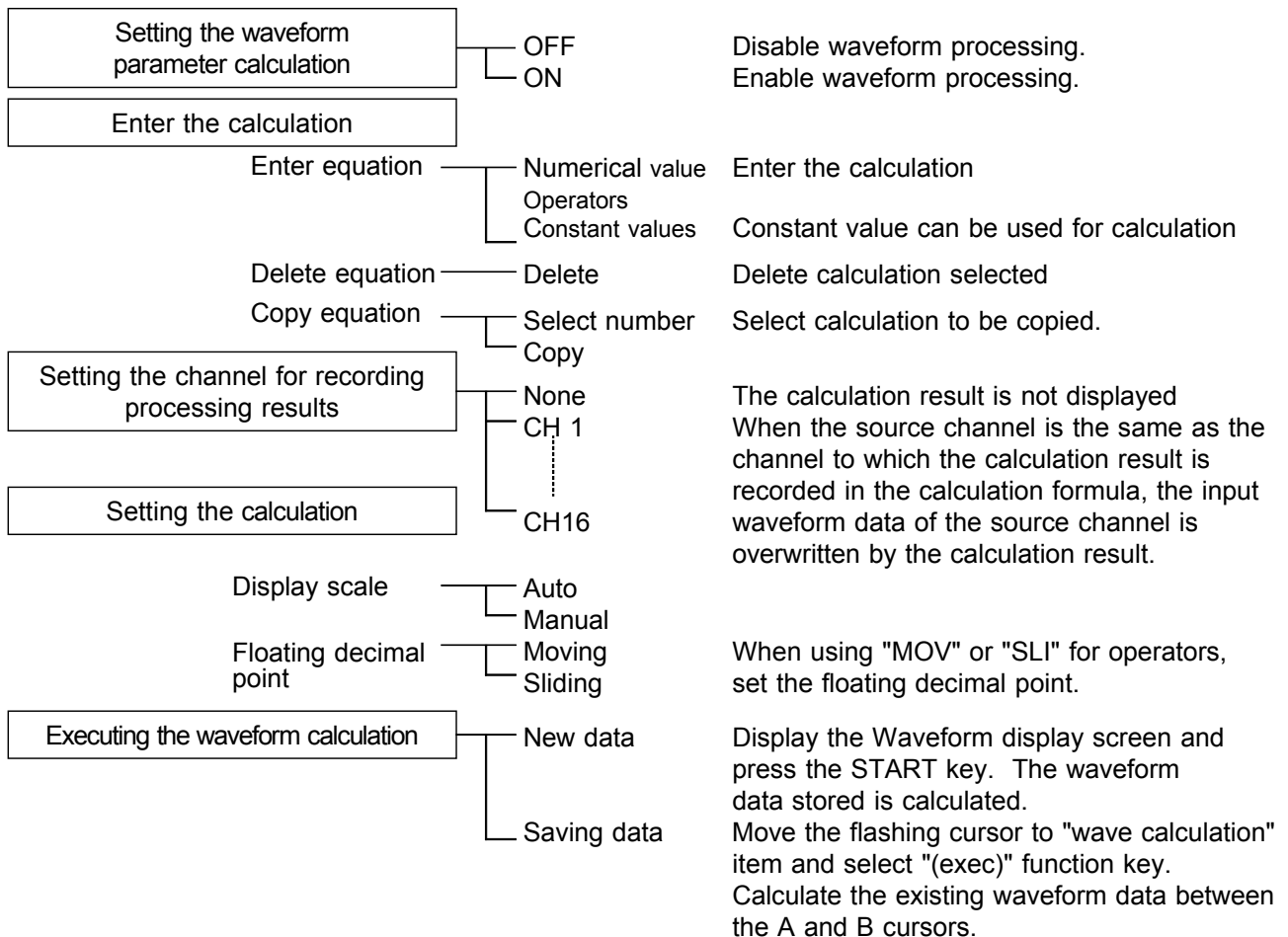

16.2.1 Preparing for Waveform Processing

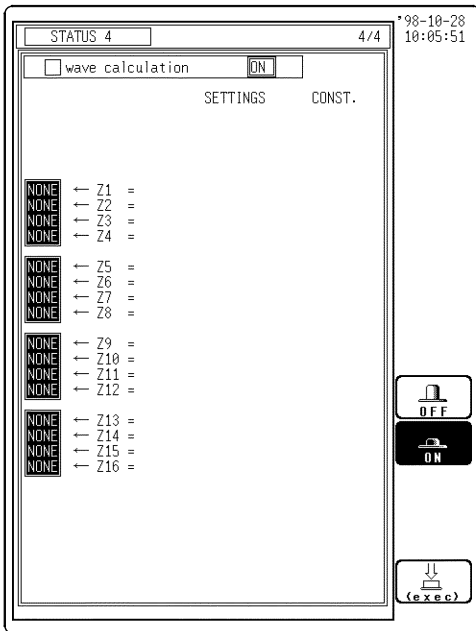

Procedure Screen: STATUS4

1. Press the **STATUS** key to display the STATUS4 screen.
2. Move the flashing cursor to **wave calculation**.
3. Make the setting with the function keys.

Function display Meaning



: Disable waveform processing.



: Enable waveform processing.
The various setting items are displayed.



: Execute Waveform Processing

NOTE

- The maximum recording length at which waveform processing calculation is possible is 1000 divisions (5000 divisions for 32 M words). If the recording length exceeds this limit, the waveform processing calculation is disable.
- When the memory segmentation function or roll mode is used, waveform processing is not possible.
- The averaged waveform becomes available for waveform processing when the averaging setting is turned OFF following measurement.
- When scaling is set for the channel in which the processing result is to be stored, scaling is not carried out and only the unit is valid. (See Section 9.8)
- When the waveform processing calculation executes simultaneously with data acquisition, a forced termination displays the results being calculated. In such cases, press the function key **RUN** to reexecute the calculation.

16.2.2 Defining the Processing Equation

Sixteen processing equations (Z1 - Z16) can be defined.

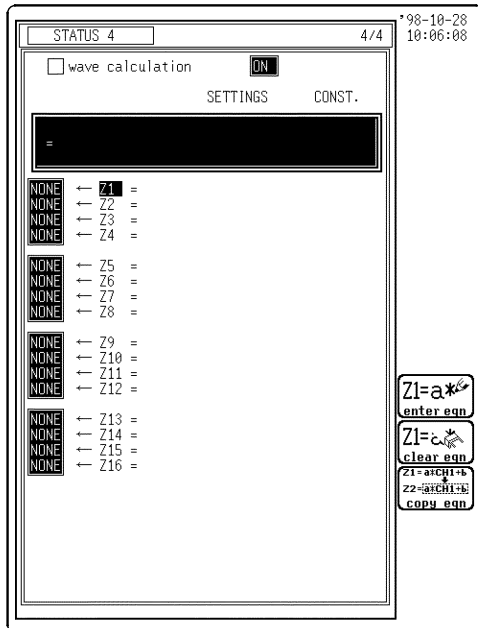

Procedure Screen: STATUS4

Making the processing equation

1. Press the **STATUS** key to display the STATUS4 screen.
2. Move the flashing cursor to Z1 to Z16.
3. Use the function keys to select the **enter eqn.**

Function display Meaning

: Enter equation

: Delete equation

: Copy equation

4. Move the cursor to the desired item with the Jog/Shuttle control or the cursor key. Use the function key to move the cursor.

Function display Meaning

: Enter the item into selected equation.

: Move the equation cursor right.

: Move the equation cursor left.

: Delete character under cursor in equation.

: Terminate equation input.

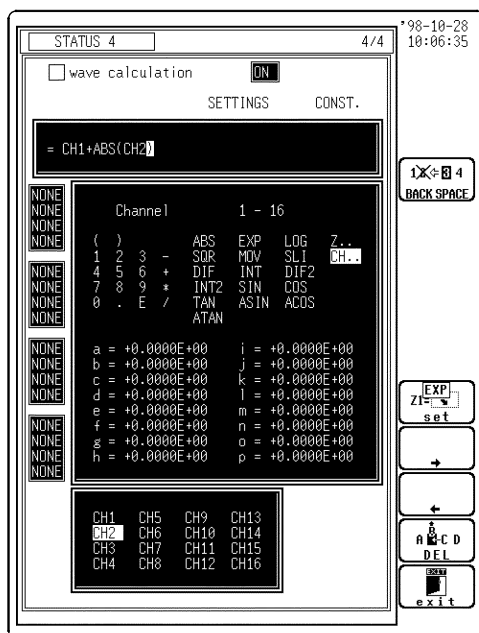

5. When the equations have been input, select **exit** function key. If there are any syntax errors in the equations (incomplete bracketing, missing "*", more than four MOV, SLI, DIF, DIF2, INT, INT2 operators, etc.), a "?" is displayed, and the cursor rests on the error, so that the problem can be corrected. When there are no syntax errors, a "=" is displayed.

6. Make settings for Z2 to Z16 as for Z1.

Operators (For details, see Section Appendix.3.9.)

ABS	Absolute value	DIF2	2nd differential
EXP	Exponential	INT2	2nd integral
LOG	Logarithm	SIN	Sine
SQR	Square root	COS	Cosine
MOV	Displacement average	TAN	Tangent
SLI	Parallel displacement on time axis	ASIN	Arc-sine
DIF	1st differential	ACO	Arc-cosine
INT	1st integral	ATA	Arc-tangent

NOTE

- If the calculable maximum recording length is set, calculation formulas Z1 to Z8 are enabled. If recording length is less than half the calculable maximum recording length, calculation formulas Z1 to Z16 are enabled.
- For multiplication, always use the "*" sign.
- Out of the MOV, SLI, DIF, DIF2, INT, and INT2 operators, up to four can be used in the same equation (for example four MOV operators or two MOV and two SLI operator, etc.).
- The maximum number of digits for a constant is 30.
- If division by 0 is specified (1/0), an overflow value is output.
- Equations are calculated in ascending order, from Z1 to Z16.
- The data that can be used in an operational equation (channel data and results of operation) must be smaller than in the preset operation numbers (for example, Z10 cannot be used on Z8).
- Up to eighty characters can be entered in an operational equation. However, only the first line of the expression is displayed on the waveform operation screen.

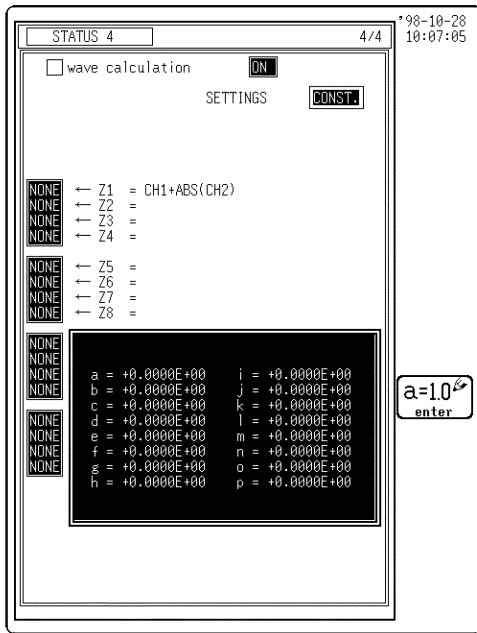

Entering the constant values

1. Move the flashing cursor to **CONST.**
2. Use the function keys to select **enter**.
The setting range is $-9.9999E+29$ to $+9.9999E+29$ (exponent: -29 to +29).

Function display Meaning

 **enter** : Enter the constant values.

3. Use the cursor keys or Shuttle key to move the cursor. Enter the constant value with the function key, the Jog control or the numerical input key.

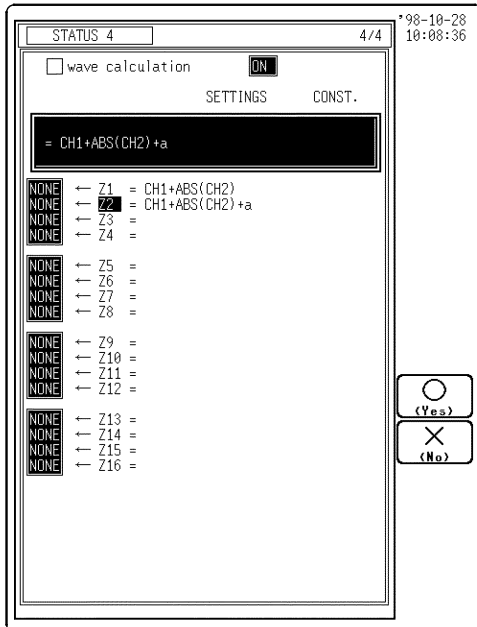

Deleting an Equation

1. Move the flashing cursor to one of the Z1 - Z16 items.
2. Select **clear eqn.**
3. Make the setting with the function keys.

Function display Meaning

 **(Yes)** : Clear equation

 **(No)** : Do not clear equation

16.2.3 Copying an Equation



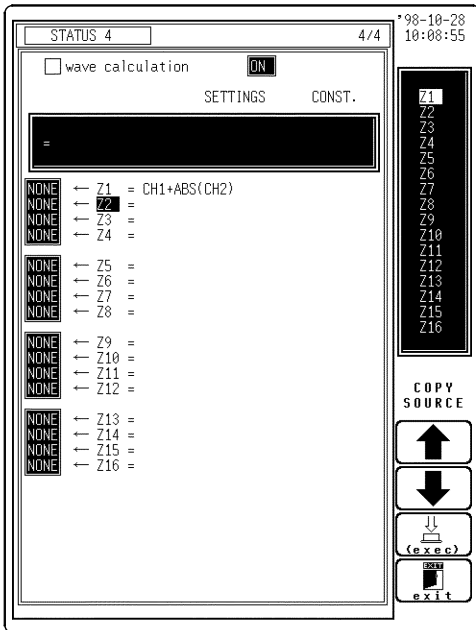

An equation to which an equation number has been assigned (copy source) can be copied to another equation number (copy target).



Procedure Screen: STATUS4

1. Move the flashing cursor to one of the Z1 - Z16 items.
2. Select the **copy eqn** function key.
3. Use the function keys or the Jog/Shuttle control to specify the number of the equation to be copied.

Function display Meaning

- | | |
|---|-----------------------------|
|  | : Increase equation number. |
|  | : Decrease equation number. |
|  | : Execute copy. |
|  | : Quit copy mode. |

4. Select **(exec)** function key. The copy source equation is copied to the copy target.

NOTE

The calculation result output destination and calculation formula settings (display scale and number of moved points) are not copied.

16.2.4 Setting the Channel for Recording Processing Results

- The calculation result of equations Z1 - Z16 can be recorded and displayed in a specified channel.
- Processing results can be recorded also in channels where no input unit is installed (but the range of the "number of channels in use" setting cannot be exceeded).

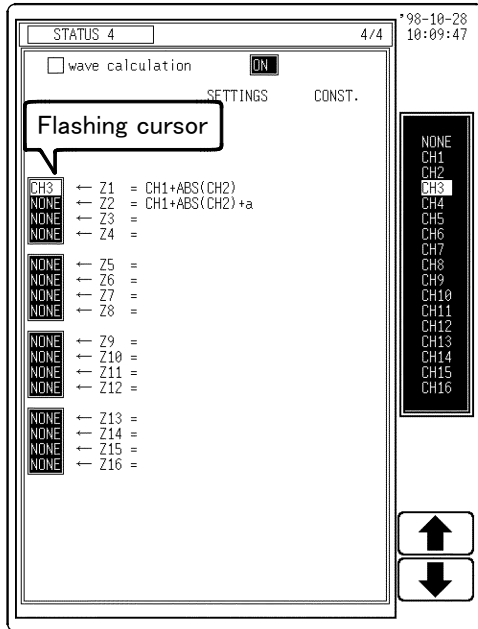

Procedure Screen: STATUS4

1. Press the **STATUS** key to display the STATUS4 screen.
2. Move the flashing cursor to the position shown in the figure on the left.
3. Use the function keys or the Jog/Shuttle control to make a setting.

Function display	Meaning
------------------	---------



: Increase channel number.



: Decrease channel number.

Equations not to be used should be set to **NONE** (calculation result is not recorded).

NOTE

- If the same channel is selected as source in the equation and as target for recording, the waveform data in the source channel are overwritten by the equation calculation result.
- In the following cases, the calculation result is displayed with in the same color set as the channel number for the first processing run:
 1. If results are recorded in a channel where no input unit is installed.
 2. If the display color for the channel selected for recording is set to OFF. When wishing to change the display color set, perform calculation once and then use the CHANNEL screen or Waveform display screen to make the setting.
- The channel selected for recording is automatically set to variable display.

16.2.5 Setting the Display Scale and Number of Moved Points

- Display scale can be set automatically or manually.
- The channel selected for recording is automatically set to variable display. (See Section 9.7)
- If MOV or SLI was used, the number of moved points must be specified.

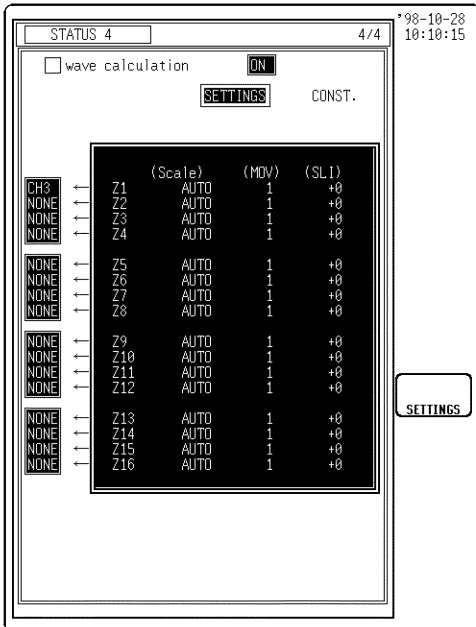

Procedure Screen: STATUS4

1. Press the **STATUS** key to display the STATUS4 screen.
2. Move the flashing cursor to **SETTINGS**.
3. Select the **SETTINGS** function key.

Function display Meaning

 : Set the scale and floating decimal point.

Setting the display scale

1. Move the cursor to **Scale**.
2. Make the setting with the function keys.

Function display Meaning

 : Set display scale automatically.

 : Set display scale manually.

 : End

▪ Automatic setting

After calculation, the upper and lower limit is determined from the result, and the variable display settings are made accordingly.

Depending on the type of calculation, automatically display scale setting may not be satisfactory. In such a case, use the manual setting procedure.

▪ Manual setting

Use the variable display setting function on the VARIABLE screen to set the upper and lower limit. (See Section 9.7.)

▪ Calculation result with overflows

The values shown using cursors A and B and the printed values obtained when the printer recording type is set to "numerical value" are not accurate.

If the display scale is set to "AUTO," the waveform is shown at the top or bottom of the screen. This indicates that the calculation result has overflowed.

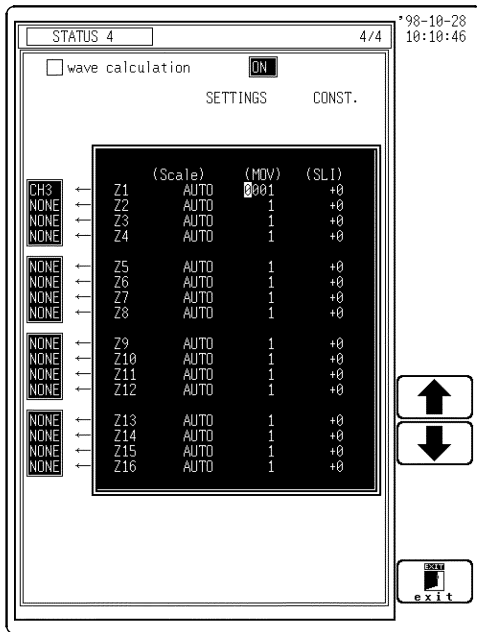

Setting the number of moved point

1. Move the cursor to the position of the number of moved point setting (MOV or SLI).
2. Move the cursor to each digits and make the setting with the function keys or the Jog/Shuttle control.

To move the digit, use the cursor keys (◀ ▶).

For MOV (moving average): 1 to 4000

For SLI (parallel displacement): -4000 to +4000

Function display Meaning

 : Increase value.

 : Decrease value.

 : End

16.2.6 Perform Waveform Processing

Waveform processing while capturing the waveform

Measurement start

Press the **START** key and LED light.

When the pre-trigger is set, the trigger will not be registered for a certain period after the start of measurement. (During this interval, "Pre-trigger standby" is shown on the display.)

When the trigger can be registered, the indication "Waiting for trigger" is shown on the display.

Meeting the trigger condition

Data recording starts when trigger condition are met.

When trigger mode selected AUTO, unit waits for about 1 second for trigger conditions to be met. After this interval, data recording starts, regardless of trigger state.

Storing measurement data

Displays "Storing".

Waveform displays after data corresponding to recording length have been stored in memory.

When the **STOP** key is pressed twice during measurement, the 8841/42 is forcibly stopped. (Waveform calculation are not executed.)

Waveform calculation

Displays **Waveform calculating**.

When the waveform processing calculation is forcibly terminated, a forced termination displays the results being calculated.

Displaying calculation result

Select (**exec**) function key to calculate again.

Operating the result

Displays waveform calculation result on the screen.

Auto print: ON Prints the measurement data.

Auto save: ON Saves the measurement data.

Measurement end

Trigger mode
SINGLE
REPEAT
AUTO

End of measurement.

Each time when trigger conditions are met, data are recorded and memory contents are overwritten.

End of measurement in REPEAT and AUTO trigger modes

When the **STOP** key is pressed once during measurement, the 8841/42 acquires measurement data in an amount corresponding to the set recording length, and the measurement is stopped. (Waveform display, Waveform calculation are executed.)

NOTE

The maximum recording length allowing waveform processing calculation is 1000 divisions (5000 divisions for 32 M words).

Waveform processing of data in internal memory or media

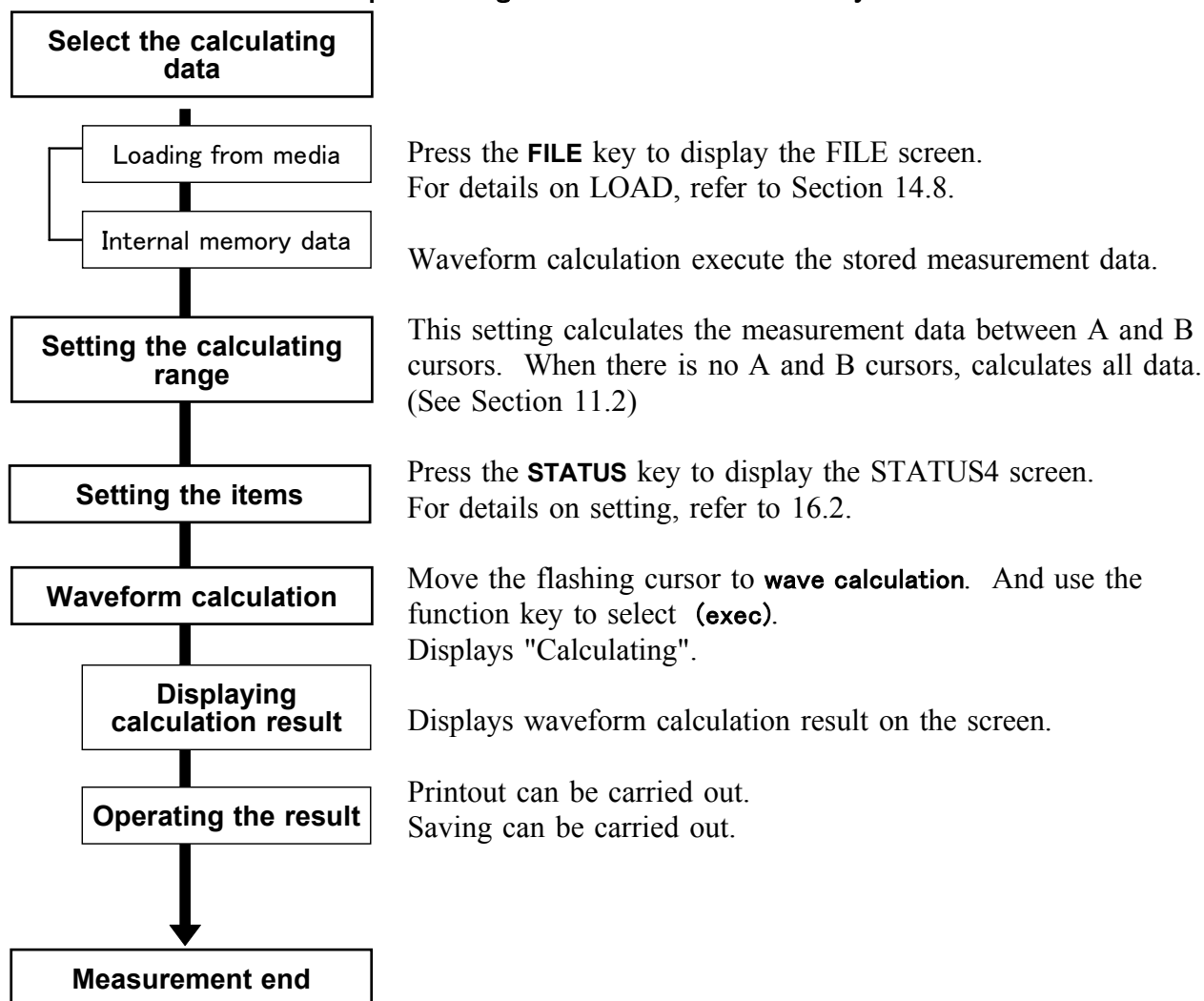

NOTE

- The maximum recording length allowing waveform processing calculation is 1000 divisions (5000 divisions for 32 M words).
- When using the trace cursor, the trace point value is displayed as processed value.
- When the cursors overlap, processing is carried out for that point.
- Line cursor (horizontal) can not be set calculating ranges.
- When only the cursor A is used, the waveform data from the position of cursor A to the end of the data is calculated.
- The result can be recalculated by altering the calculation process.
- A stored waveform read by the Recorder & Memory function can be subjected to waveform processing by the Memory function, but doing so erases the Recorder waveform.

16.3 Waveform GO/NG Evaluation (MEM, FFT)

- The waveform evaluation function can be used from the Memory recorder (single screen, X-Y single screen), FFT (single screen, Nyquist screen).
- GO (pass) or NG (fail) evaluation of the input signal waveform can be performed using an evaluation area specified by the user.
- This can serve to detect irregular waveforms.
- Depend on evaluation result, GO and NG terminal output the signal.
- Displaying all channels can be used for GO/NG evaluation.

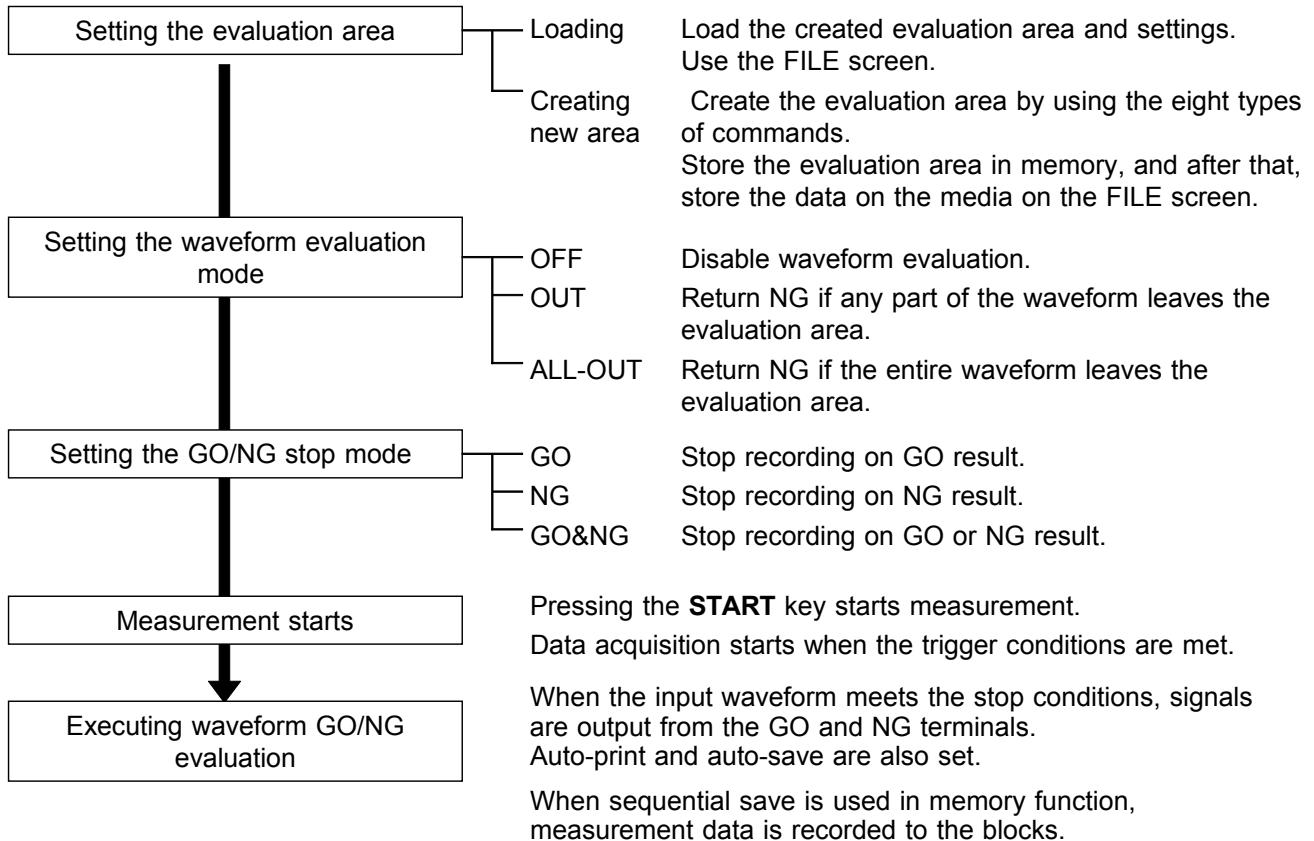

NOTE

- Trigger mode: SINGLE
Measurement continues until stop mode conditions are fulfilled and then stops.
Trigger mode REPEAT, AUTO
Recording and waveform evaluation is carried out continuously. Press the **STOP** key to terminate the measurement.
- When "auto print" is set to ON, the waveform is printed out when operation stops.
- When "auto save" is set to ON, data are stored on media when operation stops.
- When memory segmentation (sequential save) is ON, data are stored in the memory block only when operation stops.
- Waveform evaluation consists of two actions, namely capturing data and performing the evaluation. These two actions are carried out in sequence, not simultaneously. "Processing time" is needed for the FFT case. Therefore data are not captured while the evaluation is in progress, which means that the input signal is not being continuously monitored. The time required for evaluation is on the order of 20 ms.

NOTE

- If a high setting is chosen for recording length or if compression is used, the evaluation cycle becomes slower.
- On the waveform evaluation screen, A•B cursors can be used, but a partial printout cannot be made.
- When the waveform evaluation is specified, data equivalent to one screen (15 divisions) is printed out. When waveform data having a recording length of more than 15 divisions is to be printed out, the time axis should be compressed. See Section 11.3.

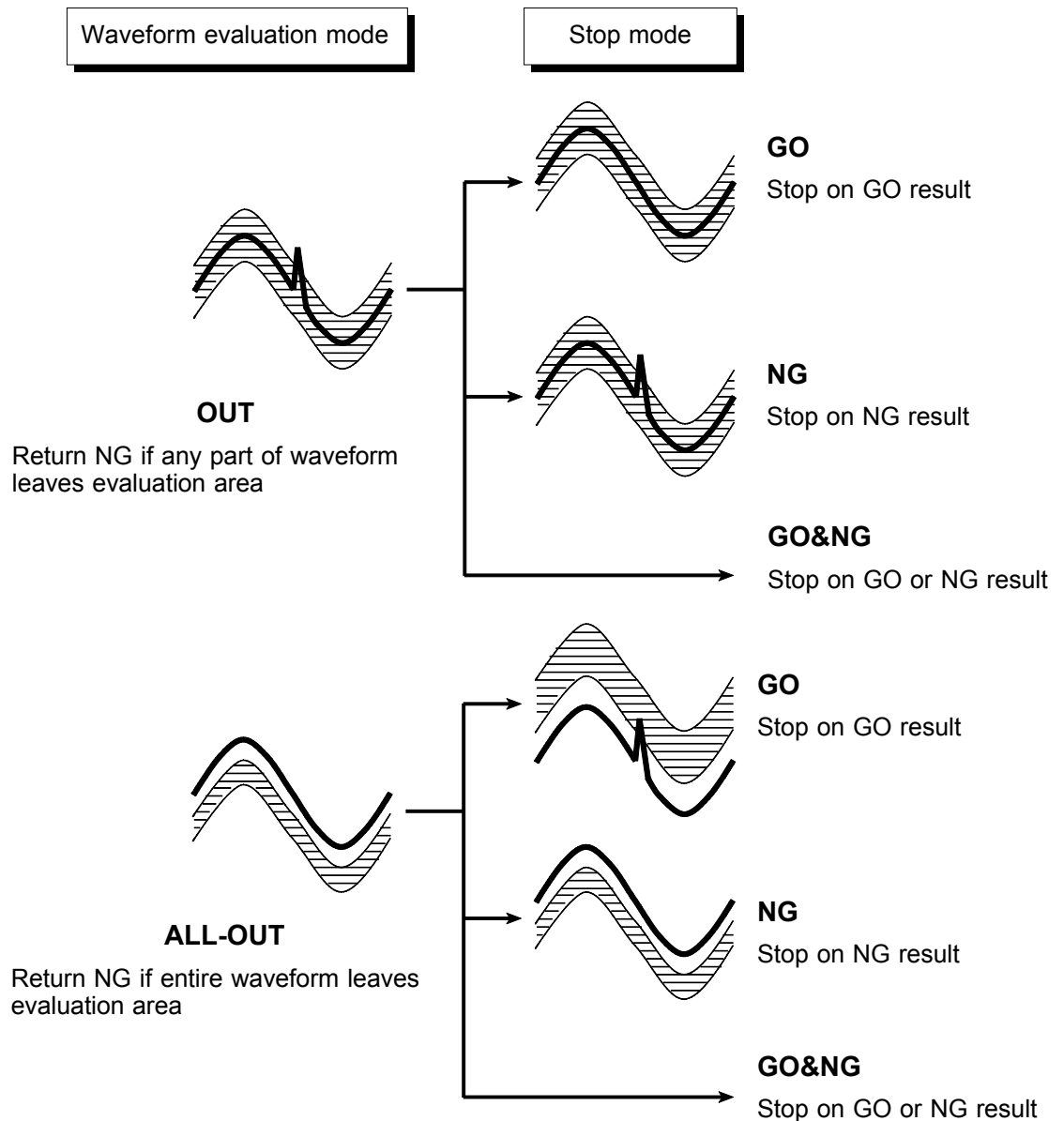
Waveform evaluation mode and stop mode

16.3.1 Setting the Waveform Area

To evaluate the waveforms, an evaluation area is required. Two methods are available: one is to load the already created evaluation area and settings, and the other is to create a new evaluation area.

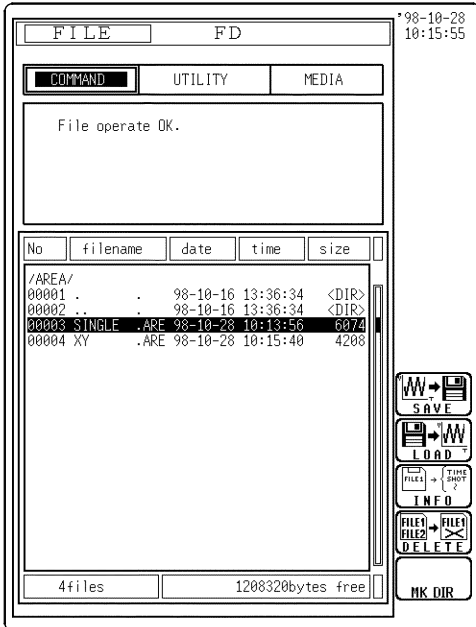

(1) Loading the already created evaluation area

Screen: FILE

1. Press the **FILE** key to call the FILE screen.
2. Select the media for loading.
3. Use the bar cursor to select the desired file.
4. Use the function key to select **LOAD**.
5. Use the function key to select (**exec**).
6. When no more changes need be made to the loaded settings, press the **DISP** key to make the Waveform display screen appear, and then press the **START** key to initiate measurement.

To change the settings, first change the contents, press the **DISP** key to make the Waveform display screen appear, and then press the **START** key to initiate measurement.

For details on load, see Section 14.8.

(2) Creating a new evaluation area

Screen: STATUS1 (MEM), STATUS2 (FFT)

1. Press the **STATUS** key to call the STATUS1 screen (STATUS2 in FFT).
2. Move the flashing cursor to **comparison**.
3. Use the function key to select **Edit**.
4. Make the new evaluation area.
See Section 16.3.4.
5. Store the new evaluation area in the internal memory.
6. After setting the parameters for "comparison" and "stop mode," press the **DISP** key to make the Waveform display screen appear, and then press the **START** key to initiate measurement.
7. Save the evaluation area on the FILE screen, if it is necessary. See Section 14.7.

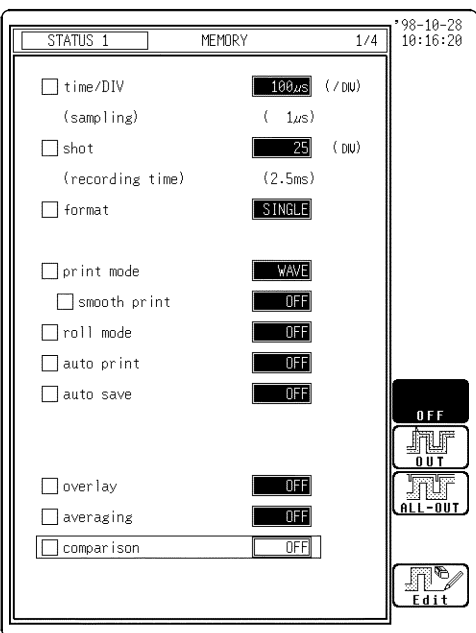

NOTE

Only one waveform evaluation area is stored in internal memory. For example, when operation is changed from the Memory recorder function to the FFT function and the FFT waveform evaluation area is stored, the waveform evaluation area created for the Memory recorder function is lost.

16.3.2 Setting the Waveform Evaluation Mode

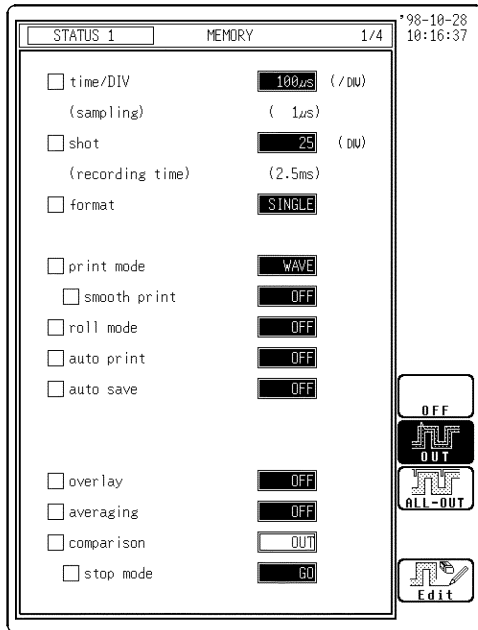

Procedure Screen: STATUS1 (MEM), STATUS2 (FFT)

1. Move the flashing cursor to **comparison**.
2. Make the setting with the function keys.

Function display

Meaning



: Disable waveform evaluation.



: Return NG if any part of the waveform leaves the evaluation area.



: Return NG if the entire waveform leaves the evaluation area.



: Activate editor for setting up evaluation area.

16.3.3 Setting the GO/NG Stop Mode

When waveform evaluation is enabled (OUT or ALL OUT is selected), the "Stop mode" menu appears. Specify which evaluation option, GO or NG, should be used to stop the recording.

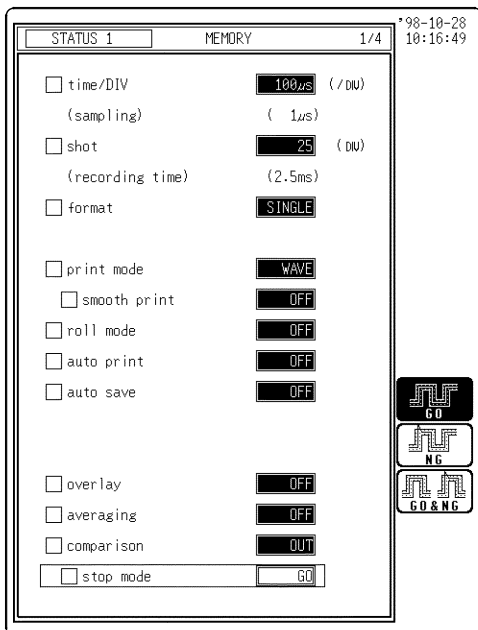

Procedure Screen: STATUS1 (Memory recorder)
STATUS 2(FFT)

1. Move the flashing cursor to the position "stop mode".
2. Make the setting with the function keys.

Function display

Meaning



: Stop recording on GO result.



: Stop recording on NG result.



: Stop recording on GO or NG result.

NOTE

In memory recorder function, when waveform parameter evaluation and waveform evaluation are carried out simultaneously, the both evaluation results are displayed on the screen. Check the results of parameter evaluation using "*" (NG decision) accompanying the figure. Alternatively, a beeping sound can be used for the evaluation instead of the "*" mark; the machine beeps if the result of either parameter or waveform evaluation is NG.

16.3.4 Creating the Evaluation Area

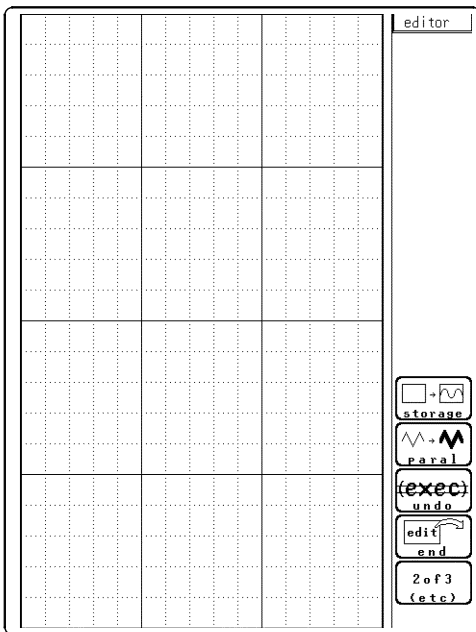

Procedure Screen: STATUS1 (MEM), STATUS2 (FFT)

1. Move the flashing cursor to the **comparison** item. Select the **Edit** function key.
2. Use these commands to create the evaluation area.
3. When the area has been stored in memory, it can be used for waveform evaluation.
4. Select the **end** function key to terminate the editor.
5. Serves to store the created area in memory.
6. Save the evaluation area through the FILE screen, if necessary. See Section 14.7.

16.3.5 Editor Command Details

storage



Function key display: 1/3

Loads a waveform already stored in memory into the editor.

Press this key and the waveform that was displayed on the screen is loaded into the editor.

The imported waveform is shown in a different color from the original setting.

parallel



Function key display: 1/3

Shifts the line pattern in parallel direction, to create an area.

1. Press this key.
2. Set the amount of shift.
 - Use the function keys or the Jog/Shuttle control to set the value.
 - Use the **next** key (or the cursor keys) to set the shift amount in the up/down/right/left directions.
 - Minimum shift increments is 0.05 movement.
3. Press the **(exec)** key. The parallel shift is carried, thereby creating the evaluation area.
4. Press the **exit** key to terminate the parallel shift mode.

Function
display

Meaning



: Increase shift amount



: Decrease shift amount

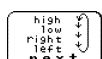

: Cycle the cursor through up/down/right/left

undo

Function key display: 1/3

Serves to undo the immediately preceding command.
Undo is applicable to all commands except save and end.

Press this key and clears the editor screen

end

Function key display: 1/3

Terminates the editor.

Press this key and select storing evaluation area in memory and quit editor or quitting editor without storing evaluation area in memory.

Function display

Meaning

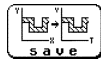

: Store evaluation area in memory and quit editor



: Quit editor without storing evaluation area in memory. The created area is discarded.



: Cancel and continue editor.

If the **end** key is pressed without having done any editing or immediately after using the store command, the editor is terminated without confirmation.

paint

Function key display: 2/3

Fills in an enclosed area.

1. Press this key.
2. Use the cursor keys to move the paintbrush mark  to the area to be filled in. Pressing **speed up** accelerates the movement of the mark.
If the area is not completely enclosed, adjacent areas will also be filled in.
3. Press the **(exec)** key. The area completely enclosed by lines is filled in.
4. Press the **exit** key to terminate the paint mode.

line

Function key display: 2/3

Serves to draw a straight or polygonal line.

1. Press this key.
2. Use the cursor keys to move the pencil mark  to the start point of the line. Pressing **speed up** accelerates the movement of the mark.
If the area is not completely enclosed, adjacent areas will also be filled in.
3. Press the **SET** key.
4. Move the pencil mark. A line is drawn between the set point and the pencil mark.
5. Press the **SET** key again. The color of the line changes, and it is fixed.
Press the **CANCEL** key. Cancel the immediately preceding set point.
6. Repeat steps 4. and 5. when wishing to draw a polygonal line.
7. Press the **exit** key to terminate the line mode.

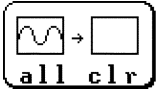
all clr

Function key display: 2/3

Clears the entire editor screen.

Press this key.

reverse

Function key display: 2/3

Reverses the colors of a filled-in area and the surrounding area.

Press this key.

Displays filled in area in reverse.

erase

Function key display: 3/3

Serves to erase unwanted sections.

1. Press this key.
2. Use the cursor keys to move the eraser mark  to the start point of the section to be erased.
Pressing **speed up** accelerates the movement of the mark.
3. Press the **SET** key.
Press the **CANCEL** key. Cancel the immediately preceding set point.
4. Move the eraser mark to erase the unwanted section.
5. Press the **exit** key to terminate the erase mode.

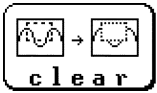
clear

Function key display: 3/3

Clears a specified rectangular area of the editor screen.

1. Press this key.
2. Use the cursor keys to move the pencil mark to the start corner of the area to be erased. Pressing **speed up** accelerates the movement of the mark.
3. Press the **SET** key.
4. Move the pencil mark to the end corner of the area to be erased.
5. Press the **SET** key again. The rectangular area is cleared.
Press the **CANCEL** key. Cancel the immediately preceding set point.
6. Press the **exit** key to terminate the clear area mode.

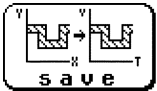
save

Function key display: 3/3

Serves to store the created area in memory.**After an area has been stored, it can be used for waveform evaluation.**

Press this key.

For storing to the media, refer to Section 14.7.

NOTE

If the **end** key is pressed without having done any editing or immediately after using the store command, the editor is terminated without confirmation.

Chapter 17

External Input/ Output Terminals/ Key Lock Function

17

17.1 External Input/Output Terminals

17.1.1 Connecting the Terminals

WARNING

Maximum input voltage ratings for the input/output terminals of the 8841/42 are shown below. To avoid the risk of electric shock and damage to the unit, take care not to exceed these ratings.

Input/output terminal	Maximum input voltage	Maximum rated voltage to earth
EXT TRIG START · STOP PRINT EXT SMPL	-5 to +10 VDC	Not insulated
TRIG OUT GO NG	-20 V to +30 VDC 500 mA max. 200 mW max.	

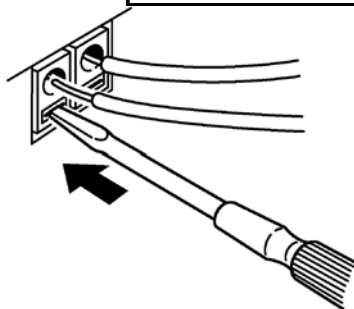

1. Push the tab with a flatblade screwdriver or similar.
2. While keeping the tab depressed, insert a stripped wire into the connector opening.
3. Release the tab to lock the wire.

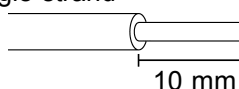
Single strand

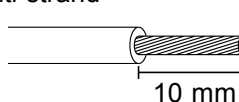
 1.0 mm dia.
 (0.3 to 1.0 mm dia
 can be used .)

Multi-strand

 0.75 mm²
 (0.3 to 0.75 mm²
 can be used)
 Diameter per strand:
 minimum 0.18 mm dia.

Recommended wire

Single strand: 1.0 mm dia. (AWG #18)

Multi-strand: 0.75 mm²

Usable limits

Single strand: 0.3 to 1.0 mm dia. (AWG #26 to #18)

Multi-strand: 0.3 to 0.75 mm² (AWG #22 to #20)

Strand diameter: minimum 0.18 mm

Standard insulation stripping length: 10 mm

17.1.2 External Trigger Input Terminal [EXT TRIG]

- An external signal can be used as trigger source.
- Several 8841/42 units can be synchronized for parallel operation.

Signal input method

- Short the terminal to ground, or input a pulse signal (High level: 2.5 to 5.0 V, Low level: 0 to 1.0 V) or a square wave signal.
- Triggering is activated at the falling edge of 2.5 V of the input waveform or using a terminal short.

Voltage range	High level: 2.5 to 5.0 V, Low level: 0 to 1.0 V
Pulse width	High level: min. 1 ms, Low level: min. 2 μ s
Maximum input voltage	-5 to 10 V

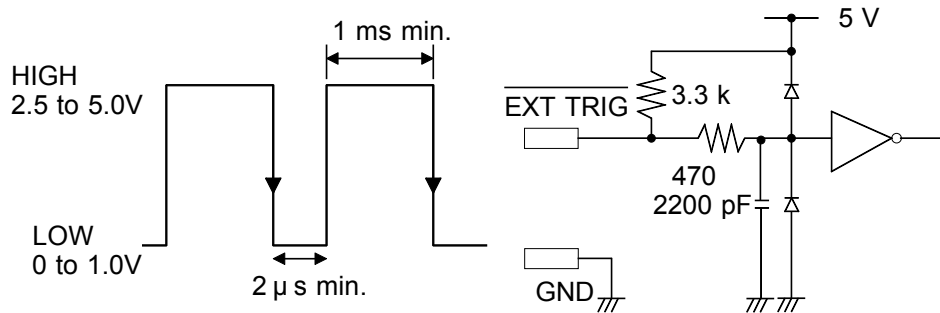

NOTE

The external trigger input (EXT TRIG) cannot be used, unless the external trigger is enabled on the TRIGGER screen.

17.1.3 Trigger Output Terminal [TRIG OUT]

- When triggering occurs, a signal is output from this terminal.
- Several 8841/42 units can be synchronized for parallel operation.

Trigger output signal

Signal type	Open-collector signal, active Low
Output voltage range	High level: 4.0 to 5.0 V Low level: 0 to 0.5 V
Pulse width	Low level: min. 10 ms.
Maximum input voltage	-20 to +30 V, max. 500 mA, max. 200 mW

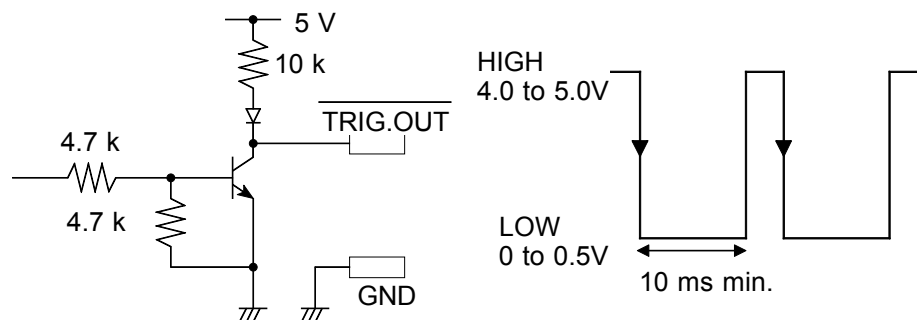

NOTE

When the auto range function is activated by pressing the **AUTO** key, a trigger output signal is generated. This should be taken into consideration when using both the trigger output and the auto range function. (Memory recorder function only)

17.1.4 External Sampling Terminal [EXT SMPL]

An external signal can be used to set the sampling rate.

Signal input method

- Input a pulse signal (High level: 2.5 to 5.0 V, Low level: 0 to 1.0 V) or a square wave signal to the terminal to ground.
- Triggering is activated at the falling edge of the input waveform.

Voltage range	High level: 2.5 to 5.0 V, Low level: 0 to 1.0 V
Pulse width	High/Low level: 0.5 μ s min.
Maximum input voltage	-5 to 10 V

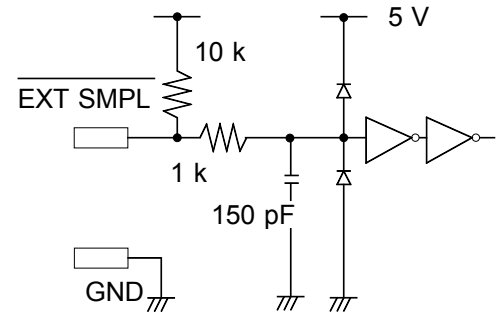
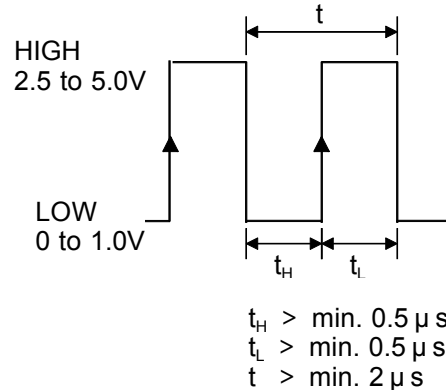

NOTE

The external sampling can be used in Memory recorder function and FFT function. To use external sampling, set the time-axis range (memory recorder) and frequency range (FFT) to "EXT."

17.1.5 External Print Terminal / External Start/Stop Terminal

PRINT terminal Printing starts when a signal is input here.

START terminal Measurement starts when a signal is input here.

STOP terminal Measurement and printing stop when a signal is input here.

Signal input method

- Short the terminal to ground, or input a pulse signal (High level: 2.5 to 5.0 V, Low level: 0 to 1.0 V) or a square wave signal.
- Control is activated at the falling level of the input waveform (active Low).

Voltage range	High level: 2.5 to 5.0 V, Low level: 0 to 1.0 V
Pulse width	High level: 25 ms min. , Low level: 40 ms min.
Maximum input voltage	-5 to 10 V

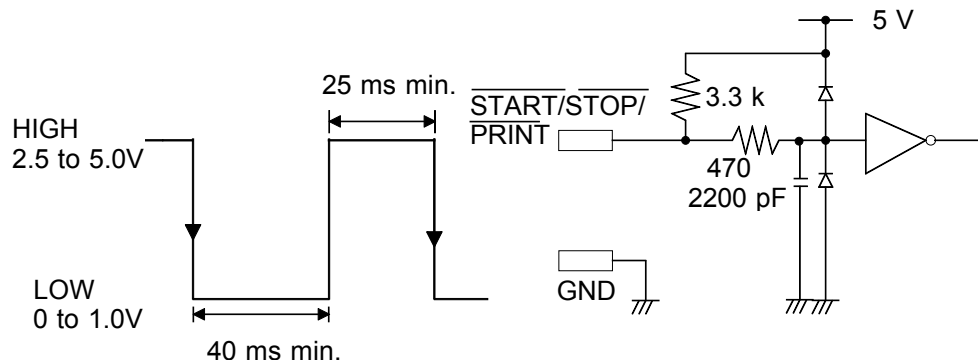

17.1.6 GO/NG Evaluation Output Terminal

When waveform evaluation or waveform parameter evaluation is used, a signal is output from these connectors when the result is GO (pass) or NG (fail).

Output signal

Signal type Open-collector signal, active Low
 Output voltage range High level: 4.0 to 5.0 V, Low level: 0 to 0.5 V
 Maximum input voltage -20 to +30 V, max. 500 mA, max. 200 mW

Evaluation output interval (min. 70 ms)

The evaluation outputs are shown in the following table. Between these states, there is an interval during which the next data are read and waveform data are created. The duration of this interval is inversely proportional to the time axis and proportional to the recording length.

Output Terminal	Evaluation result	
	GO	NG
GO	Low level	High level
NG	High level	Low level

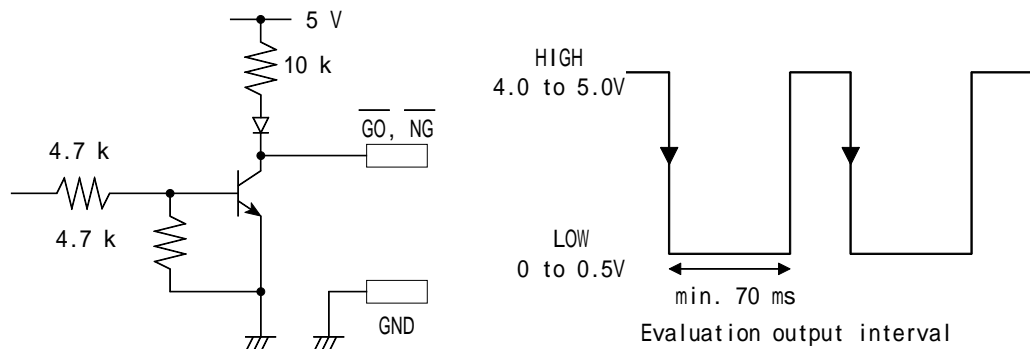

The following diagram shows an example of a circuit that operates an alarm by means of a GO/NG terminal.

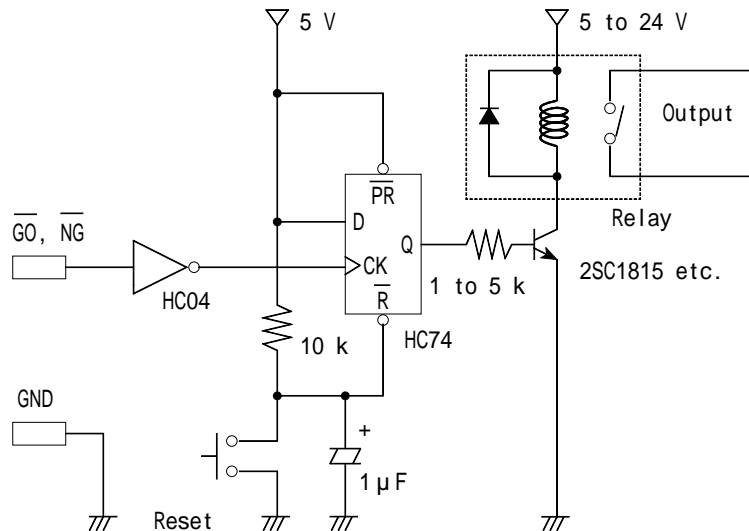

17.2 Using the Key Lock Function

- This function disables all front-panel controls of the 8841/42.
 - The function serves to prevent unintended changes to settings during a measurement.
- (1) Press both cursor keys (↔) simultaneously for 3 seconds to open a window in which you can check key lock on/off status.
Press the **F5** key to set the KEY LOCK switch to ON.
 - (2) To cancel the key lock function, press both cursor keys (↔) simultaneously for 3 seconds to open a window in which you can check key lock on/off status.
Press the **F4** key to set the KEY LOCK switch to OFF.
The key lock function will not be canceled by turning the power off and on.
- When the key lock function is active, the indication KEY LOCK is shown on the display.
 - If the backlight saver function is used and the display backlight turns off, it can be turned on again by touching any key. The function assigned to the key will not be activated.

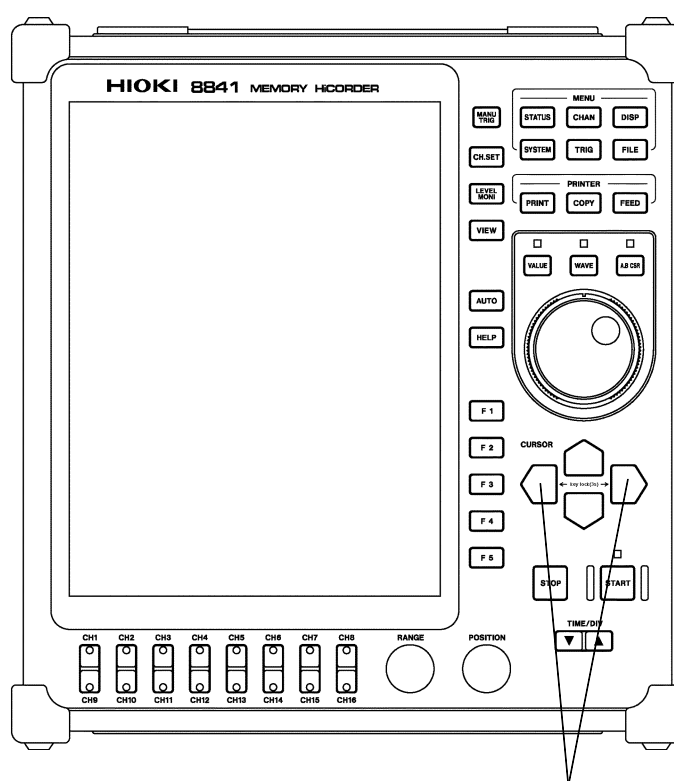

Press both cursor keys simultaneously for 3 seconds

NOTE

The external I/O terminal is active.

Chapter 18

Specifications 18

18.1 General Specifications

Basic specifications

Measurement functions	Memory recorder Recorder RMS recorder Recorder & Memory FFT	High-speed data saving Real time recording For commercial power supplies Real time recording & High-speed data saving Frequency analysis
Number of channels (maximum)	16 analog channels + 16 logic channels (The logic channels are standard equipment for the 8841/42, common ground with main unit)	
Memory capacity	Standard: 8 M words Expansion: 32 M words (8 M words (Standard) added 24 M words (expansion))	
Expansion memory	24 M words (32 M words added 8 M words)	
Maximum sampling period	1 μ s (all channels simultaneously) External sampling period (2 μ s)	
Time axis accuracy	$\pm 0.01\%$ (difference between grid and actual time)	
Input method	Plug-in analog unit	
External control terminals	External trigger input, trigger output, GO/NG output, external start/stop, print input, external sampling	
Time measurement functions	Auto calendar with automatic leap year, 24 hour clock	
Backup battery and lifetime	Used for clock and to preserve waveforms and settings, approx.10 years (reference value at 25°C (77°F))	
Operating Environment	Indoors, altitude up to 2000 m (6562 feet)	
Operational ranges for temperature and humidity	Temperature: 5°C to 40°C (41°F to 104°F) Relative humidity: 35% to 80%RH (with no condensation)	
Temperature and humidity ranges for assured accuracy Guaranteed accuracy period	Temperature: 23 \pm 5°C (73°F \pm 9°F) Relative humidity: 35% to 80%RH (with no condensation) 1 year	
Temperature and humidity ranges for storage	Temperature: -10°C to 50°C (50°F to 122°F) Relative humidity: 20% to 90%RH (with no condensation)	
Insulation resistance	Between the main unit and the power supply, between the input units and the main unit, and between the input units: At least 100 M Ω /500 VDC	

Dielectric strength	One minute at 1.35 kVAC between the main unit and the power supply One minute at 3.7 kVAC between the input units and the main unit, and between the input units (For input units, same as specifications of each input unit.)
Power supply	Rated power voltage 100 to 240 VAC, 10 to 28VDC (using the 9433) (Voltage fluctuations of $\pm 10\%$ from the rated supply voltage are taken into account.) Rated power frequency 50/60 Hz
Maximum rated power	8841: 300 VA max (when printer off and 8936 installed: 85 VA) (when printer off and 8946 installed: 95 VA) 8842: 300 VA max (when printer off and 8936 installed: 105 VA)
Dimensions and mass	8841: Approx.280W \times 300H \times 140D mm (11.02"W \times 11.81"H \times 5.51"D) (excluding projections) Approx. 6 kg (211.64 oz) MO: Approx.280W \times 300H \times 167D mm (11.02"W \times 11.81"H \times 6.58"D) (excluding projections) Approx. 6.6 kg (232.80 oz) 8842: Approx.280W \times 300H \times 220D mm (11.02"W \times 11.81"H \times 8.66"D) (excluding projections) Approx. 7.5 kg (264.55 oz) MO: Approx.280W \times 300H \times 247D mm (11.02"W \times 11.81"H \times 9.73"D) (excluding projections) Approx. 8.1 kg (285.71 oz)
Standards Applying	EMC EN61326, Class A EN 61000-3-2 EN 61000-3-3 Safety EN61010 Pollution Degree 2, measurement category (anticipated transient overvoltage 4000 V)

Recorder

Method of recording	Thermosensitive recording method using a thermal line head
Recording paper	Roll type thermosensitive paper, 216 mm \times 30 m (8.51" \times 98.43")(long)
Width of recording	Total recording width: 212 mm \pm 1 mm (8.35" \pm 0.04") Waveform portion: 200 mm (20 DIV) \pm 1 mm (7.87" (20DIV) \pm 0.04"))
Recording speed	Approx. 25 mm (0.99")/s max.
Paper feed accuracy	$\pm 1\%$ (25°C (77° F), 60%RH)

Display

Display language	Japanese/English (selectable)
Screen	10.4 inch TFT color LCD display (480 \times 640 dots)
Display resolution	In the memory recorder, recorder, RMS recorder, and REC&MEM functions, (1 DIV = 25 (horizontally) \times 32 (vertically) dots) Waveform: 15 DIV \times 20 DIV Text: 30 characters \times 40 lines In the FFT function (1 DIV = 40 (horizontally) \times 20 (vertically) dots) Waveform: 10 DIV \times 20 DIV Text: 30 characters \times 40 lines In the X-Y display (1 DIV = 32 (horizontally) \times 32 (vertically) dots) Waveform: 10 DIV \times 10 DIV Text: 30 characters \times 40 lines
Dots spacing	0.33 H \times 0.33 Vmm (0.013" H \times 0.013" V)
Backlight lifetime	Approx. 50,000 hours (reference value)

NOTE

TFT color LCDs characteristically have a few defective pixels that do not always light, or that remain lit. We do not consider the presence of six or fewer such defects to indicate a damaged or faulty display. Please be aware of this in advance.

18.2 External Data Storage and Interface

Floppy Disk

Device	3.5-inch floppy disk drive
Capacity	1.44 MB (2HD) (IBM PC/AT compatible or NEC PC-9801 series with 3-mode drive) 1.2 MB (2HD) (NEC PC-9801 series) 720 KB (2DD) (IBM PC/AT compatible)
Data format	MS-DOS format (MS-DOS is the registered trademark of Microsoft Corporation.)
Data stored	Settings, waveform evaluation area, screen data (bmp), measurement data (binary or text), (Measurement data can be saved between cursors A and B.) spacing data (text)

MO Disk (Option)

Device	3.5-inch MO disk drive
Capacity	640 MB (128 MB, 230 MB, 540 MB)
Data format	Accordance with ISO standard, overwrite media supported
Data stored	Settings, waveform decision area, screen data (bmp), measurement data (binary or text), (Measurement data can be saved between cursors A and B.) spacing data (text)

PC Card

Expansion slot	PC card standard (1 slot) Accepts TYPE I, II, III PC cards
Card types	SRAM card, flash ATA card, hard disk drive card (HDD) (The performance is guaranteed for our optional PC cards only.)
Card capacity	32 MB max. (SRAM), 528 MB max. (flash, HDD)
Data format	MS-DOS format (MS-DOS is the registered trademark of Microsoft Corporation.)
Data stored	Settings, waveform decision area, screen data (bmp), measurement data (binary or text), (Measurement data can be saved between cursors A and B.) spacing data (text)

Interface

GP-IB	Complies with IEEE 488.2-1987 <ul style="list-style-type: none"> • Remote control including input unit is possible. • The optional 9558 GP-IB CARD is used.
RS-232C	Complies with EIA RS-232C <ul style="list-style-type: none"> • Remote control including input unit is possible. • The optional 9557 RS-232C CARD is used.
Printer	Complies with PC-AT centronics <ul style="list-style-type: none"> • Using the external printer, color print can be printed. • The optional 9559 PRINTER CARD is used.
LAN	Complies with IEEE 802.3i (Ethernet 10BASE-T) <ul style="list-style-type: none"> • Remote control including input unit is possible. • The optional 9578 10BASE-T LAN CARD is used. • Commercially available LAN cards (specified) can be used. • Remote control and data acquisition using the 9333 LAN COMMUNICATOR are possible.

SCSI Interface

SCSI	ANSI X3.131-1986 (SCSI level 2) JIS X6051 (SCSI level 2)
Driver/receiver	Single - ended
Bus-parity	Output data : none Input data : none
Data transfer method	Asynchronous
Terminator	Provided (not removable)
Terminator power	Provided
Initiator operation	Provided
Target	3.5-inch MO disk
Address	0 to 7
Connector	<ul style="list-style-type: none"> • Connect to MO disk drive with SCSI cable • Connector type: High density (pin-type) (D-Sub half-pitch 50 P)
MO disk drive	Connect to MO disk drive with SCSI cable
Data stored	Settings, waveform evaluation area, screen data, measurement data (binary or text), (Measurement data can be saved between cursors A and B.) spacing data (text)

18.3 Trigger Unit

Trigger Method	Digital comparison
Trigger modes	Memory recorder, FFT Recorder, RMS recorder Recorder&Memory Single, repeat, auto Single, repeat Single, repeat, timer
Trigger source	CH1 to CH16, logic CHA to CHD <ul style="list-style-type: none"> External trigger (With an external trigger, the triggering occurs on a falling edge of 2.5 V, or when the terminals are shorted together.) Manual trigger Timer trigger Sources can be set on or off. When all sources are off, the unit is in the free-run state. Trigger conditions can be set for each channel individually.
Trigger conditions	Logical AND or OR of any trigger sources
Trigger types (analog)	(1) Level trigger <ul style="list-style-type: none"> Digital setting of voltage values for full scale Triggering occurs at rising edge (falling edge) of set value. (2) Window-in, window-out trigger <ul style="list-style-type: none"> Upper and lower trigger levels can be set. Triggering occurs when the waveform enters or leaves the defined area. (3) Voltage drop trigger (for commercial power supplies) <ul style="list-style-type: none"> Triggering occurs when the peak of the voltage falls lower than the setting level. (4) RMS level trigger (for commercial power supplies and DC) <ul style="list-style-type: none"> Set the RMS value by digital value. Triggering occurs at rising edge (falling edge) of set value . (5) Period trigger <ul style="list-style-type: none"> This function sets both the period reference voltage and the period range, and measures the rise (fall) period of the set voltage. When the measured period deviates from the specified range, triggering occurs.
Trigger type (logic)	Pattern trigger specified by 1, 0, and \times (\times means that either 1 or 0 is fine.)
Trigger filter	MEM, memory waveform in REC&MEM, FFT: OFF, 0.1, 0.2, 0.5, 1.0, 1.5, 2.0, 2.5, 5.0, 10.0 DIV REC: ON, OFF (10 ms fixed)
Trigger level resolution	0.25%f.s. (f.s. = 20 DIV)
Pre-trigger	MEM, memory waveform in REC&MEM, FFT: 0, 2, 5, 10, 20, 30, 40, 50, 60, 70, 80, 90, 95, 100, -95 % RMS: 0, 5, 10 DIV
Trigger timing	Start, Stop, Start and Stop (REC)
Trigger output	Open collector output (with 5 V output voltage, active low) Pulse width 1 ms min.
Level meter function	When waiting for trigger, the level of the analog input signal is displayed on the Waveform display screen.

18.4 Memory Recorder Function

Time axis	100, 200, 500 μ s/DIV 1, 2, 5, 10, 20, 50, 100, 200, 500 ms/DIV 1, 2, 5, 10, 30 s/DIV 1, 2, 5 min/DIV EXT.
Time axis resolution	100 points/DIV
Sampling period	1/100 of the time axis
Recording length	Standard (8 M words) 25,50,100,200,500,1000,2000,5000,10000 ^{*1} ,20000 ^{*2} ,40000 ^{*3} DIV Expansion (32 M words) 25,50,100,200,500,1000,2000,5000,10000,20000,40000 ^{*1} ,80000 ^{*2} ,160000 ^{*3} DIV Arbitrarily (Set from 1 division to the maximum number of divisions at 1-division intervals.)
Screen/print format	The styles single, dual, quad, oct (LCD) / hex (Print only), X-Y single / X-Y dual (dot/line) are available.
Interpolation	Line (excluding X-Y format), Dot•line (X-Y format)
Recording line display	12-color (LCD), Printout: 4-type
Overlay function	Provided
Waveform magnification/ compression	Time axis $\times 10$, $\times 5$, $\times 2$, $\times 1$, $\times 1/2$, $\times 1/5$, $\times 1/10$, $\times 1/20$, $\times 1/50$, $\times 1/100$, $\times 1/200$, $1/500$, $\times 1/1000$, $\times 1/2000$, $\times 1/5000$, $\times 1/10000$ Measurement range $\times 10$, $\times 5$, $\times 2$, $\times 1$, $\times 1/2$ (single, X-Y single) $\times 5$, $\times 2.5$, $\times 1$, $\times 1/2$, $\times 1/4$ (2, 4, 8, 16, X-Y single/ dual)
Waveform scrolling	Available in the left/right directions
Auto-print	Automatically prints the memorized waveform
Manual print	Available
Partial print	Prints between the A and the B cursors
Print smoothing function	When set, a smoothed waveform is printed, with twice the density in the time axis direction.
A4 print	Available
Logging function	Records measured data as digital values
Variable function	Provided
Zoom function	Provided

(^{*1}) : When 8 channels are in use
 (^{*2}) : When 4 channels are in use
 (^{*3}) : When 2 channels are in use

18.5 Recorder Function

Time axis	20 ^{*1} , 50 ^{*1} , 100 ^{*1} , 200 ^{*1} , 500 ms/DIV 1, 2, 5, 10, 30 s/DIV 1, 2, 5, 10, 30 min/DIV 1 h/DIV
Time axis resolution	100 points/DIV (with the printer)
Sampling period	1, 10, 100 μ s, 1, 10, 100 ms (Can be selected, from 1/100 of the time axis setting)
Recording length	Standard (8 M): 25,50,100,200,500,1000,2000 DIV,CONT ^{*2} Expansion (32 M): 25,50,100,200,500,1000,2000,5000,10000 DIV,CONT ^{*2} Arbitrarily (Set from 1 division to the maximum number of divisions at 1-division intervals.) X-Y format can be set CONT only
Screen/print format	The styles single, dual, quad, oct (LCD) / hex (Print only), X-Y single / X-Y dual (dot/line) are available.
Interpolation	Line (excluding X-Y format), Dot• line (X-Y format)
Recording line display	12-color (LCD), Printout: 4-type
X-Y Spatial resolution	32 dots/DIV (with the display) 80 dots/DIV (horizontally), 80 dots/DIV (vertically) (with the printer)
X-Y Sampling period	Dot display: 300 μ s fixed, Line display: 300 μ s to 25 ms (not fixed)
Waveform magnification/ compression	Time axis $\times 1$, $\times 1/2$, $\times 1/5$, $\times 1/10$, $\times 1/20$, $\times 1/50$, $\times 1/100$, $\times 1/200$, $\times 1/500$ Measurement range $\times 10$, $\times 5$, $\times 2$, $\times 1$, $\times 1/2$ (single) $\times 5$, $\times 2.5$, $\times 1$, $\times 1/2$, $\times 1/4$ (2, 4, 8, 16, X-Y1/2)
Waveform storage	Last 2000 divisions of data saved in memory *3 Can be checked by reverse scrolling and reprinted
Print function	ON/OFF and reprinted
A4 print	Available
Additional recording function	ON/OFF ^{*4}
Logging function	Records measured data as digital values
Variable function	Provided

(^{*1}) : Although real-time recording to the recording paper is not possible in the high-speed range (20 to 200 ms/DIV), the waveforms are stored to the memory and can therefore be monitored on the screen. The last 2000 divisions of each waveform(^{*3}) are retained in memory before the measurement is complete. If the recording length is not set to "continuous," the printer can also be operated, enabling the waveforms to be printed out later.

(^{*2}) : With time axis 20 to 200 ms/DIV, "continuous" is not possible with printer ON.

(^{*3}) : Expanded to 32 M words: 10000 DIV

(^{*4}) : Additional recording function (recording data without paper)

When enabled, the memory is regarded as printer paper. Recording starts at the end of previous data, without erasing them. When the 2000 DIV^{*3} has been reached, old data will be overwritten. When OFF, previous data will be erased. Set to ON if erasing is not desired.

18.6 RMS Recorder Function

Time axis	5, 10, 30 s/DIV, 1, 2, 5, 10, 30 min/DIV, 1 h/DIV
Time axis resolution	100 points/DIV (with the printer)
Number of channel	Analog 16 ch + logic 16 ch
Sampling period	20 rms data/s (200 μ s fixed)* ¹
RMS accuracy	$\pm 3\%$ f.s. (at 50/60 Hz ± 2 Hz, DC) (f.s.=20 DIV)
Measuring object	Commercial power supplies (50/60 Hz), DC
Recording length	Standard (8 M): 25,50,100,200,500,1000,2000 DIV,CONT* ² Expansion (32 M): 25,50,100,200,500,1000,2000,5000,10000 DIV,CONT* ² Arbitrarily (Set from 1 division to the maximum number of divisions at 1-division intervals.)
Screen/print format	The styles single, dual, quad, oct (LCD) / hex (Print only)
Interpolation	Line
Recording line display	12-color (LCD), Printout: 4-type
Waveform magnification/ compression	Time axis $\times 1, \times 1/2, \times 1/5, \times 1/10, \times 1/20, \times 1/50, \times 1/100, \times 1/200, \times 1/500$ Measurement range $\times 10, \times 5, \times 2, \times 1, \times 1/2$ (single) $\times 5, \times 2.5, \times 1, \times 1/2, \times 1/4$ (2, 4, 8, 16)
Waveform storage	Last 2000 divisions of data saved in memory* ² Can be checked by reverse scrolling and reprinted
Print function	ON/OFF and reprinted
A4 print	Available
Additional recording function	ON/OFF* ³
Logging function	Records measured data as digital values
Variable function	Provided

(*¹) : Refer to Appendix 3.5.

(*²) : Expanded to 32 M words: 10000 DIV

(*³) : Additional recording function (recording data without paper)When enabled, the memory is regarded as printer paper. Recording starts at the end of previous data, without erasing them. When the 2000 DIV*² has been reached, old data will be overwritten. When OFF, previous data will be erased. Set to ON if erasing is not desired.

18.7 Recorder & Memory Function

Time axis	Recorder 20, 50, 100, 200 ms/DIV (display only) 500 ms/DIV 1, 2, 5, 10, 30 s/DIV 1, 2, 5, 10, 30 min/DIV 1 h/DIV Memory Recorder 100, 200, 500 μ s/DIV 1, 2, 5, 10, 20, 50, 100, 200, 500 ms/DIV 1, 2, 5, 10, 30 s/DIV 1, 2, 5 min/DIV
Time axis resolution	100 points/DIV
Sampling period	1/100 of the time axis.....Memory waveform
Recording length	Standard (8 M): 25, 50, 100, 200, 500, 1000, CONT (REC) 25, 50, 100, 200, 500, 1000, 2000, CONT (MEM) Expansion (32 M): 25, 50, 100, 500, 1000, 2000, 5000 DIV, CONT (REC) 25, 50, 100, 500, 1000, 2000, 5000, 10000 DIV (MEM)
Screen/print format	The styles single, dual, quad, oct (LCD) / hex (Print only)
Recording line display	12-color (LCD), Printout: 4-type
Display	Switchable between recorder and memory waveforms
Printer output	During measurement operation, recorder waveform only. After data capture, printout of recorder waveform as on display or memory recorder waveform.
Waveform storage (REC)	Last 1000 divisions of data saved in memory ^(*) Can be checked by reverse scrolling and reprinted
Additional recording function	ON/OFF* ²
Trigger source	CH1 to CH16, CHA to CHD and external trigger (MEM)
A4 print	Available
Zoom function	Provided(in memory recorder function)
Variable function	Provided
Real time save function	Time axis range: 50 ms/DIV (less than 8 ch) 100 ms/DIV to 5 min/DIV (more than 9 ch) (1 DIV = 100 points) Save destination: PC card or 9607 MO Drive Unit (option) Save time: depends on available space on the media.

(^{*1}) : Expanded to 32 M words: 5000 DIV

(^{*2}) : Additional recording function (recording data without paper)

When enabled, the memory is regarded as printer paper. Recording starts at the end of previous data, without erasing them. When the 1000 DIV^{*1} has been reached, old data will be overwritten. When OFF, previous data will be erased. Set to ON if erasing is not desired.

18.8 FFT Function

FFT channel mode	1 ch FFT 2 ch FFT
FFT range setting	133 mHz to 400 kHz, EXT.
Dynamic range	72 dB (logical value)
Number of sampling points	1000, 2000, 5000, 10000 points
Frequency resolution	1/400, 1/800, 1/2000, 1/4000
Antialiasing filter	Automatic cutoff frequency selection linked to frequency range
Analysis channel setting	2 channels selectable from all analog channels
FFT analysis mode setting	Storage waveform, Linear spectrum, RMS spectrum, Power spectrum, Cross-power spectrum, Auto-correlation function, Histogram, Transfer function, Cross-correlation function, Unit-impulse response, Coherence function, Octave analysis
Display format setting	Single, dual screen display, Nyquist display
Windows	Rectangular, Hanning, Exponential
Display scale	Linear scale, Log scale, Phase
Print function	As per the memory recorder function, excluding partial print function
Averaging function	Simple average of time and frequency axis, exponential average, peak hold (frequency axis) (2, 4, 8 to 4096 samples)

18.9 Auxiliary Functions

Computation functions (MEM)	<ol style="list-style-type: none"> 1. Waveform processing calculations (MEM) Arithmetic operations, absolute value, exponents, common logarithms, square roots, moving average, 1st and 2nd derivatives, 1st and 2nd integrals, parallel displacement on time axis, trigonometric functions, reverse trigonometric functions 16 arbitrary operational equations: Calculations are possible up to a recording length that corresponds to one fourth of the memory capacity. 2. Waveform parameter calculations (MEM) Average value, RMS value, peak-to-peak value, maximum value, time to maximum value, minimum value, time to minimum value, period, frequency, rise time, fall time, area value, XY area value, standard deviation (parameter calculation result can be saved on floppy disk, MO disk, and so on.) 3. Averaging function Additive average, exponential average (2, 4, 8 to 256 samples) (MEM) Simple average, exponential average, peakhold (2, 4, 8 to 4096 samples) (FFT)
Memory segmentation	<p>Memory can be segmented among channels. Number of segments: Maximum 255 Batch saving of all blocks can be selected.</p>
Sequential saving (MEM, REC&MEM)	<p>Input signal capture is carried out continuously using the trigger, storing waveform data successively in each block. Displaying waveform ON or OFF can be selected.</p>
Multi-block (MEM)	<p>Recording the waveform data in an arbitrary block. Displaying two arbitrary blocks in duplicate.</p>
Waveform evaluation	<ol style="list-style-type: none"> 1. Waveform area evaluation (MEM, FFT): Waveform evaluation based on evaluation area for Y-T waveform, X-Y waveform, or FFT*¹ results Evaluation modes: Out: fail if any part of waveform is outside evaluation area All out: fail if whole of waveform is outside evaluation area Stop modes: GO (pass) stop, NG (fail) stop, GO & NG stop Printer output or waveform save at stop Decision time: Approx. 20 ms max Decision period: Approx. 150 ms (MEM) With input 1 V_{p-p} sin wave, 1 kHz, to 1 channel, used channel ch1 to 4, 100 μs/DIV × 1, 25DIV (depend on time-axis compression, recording length) Approx. 490 ms (FFT) 1000 points, linear spectrum, window function - rectangular (depend on frequency-axis, FFT analysis type, FFT points) Graphics editor (Provided, used for defining an arbitrary evaluation area for waveform evaluations): Line, paint, storage, erase, parallel, reverse, clear, all clr, undo, save, end 2. Waveform parameter evaluation (MEM) Decision based on setting minimum and maximum values for waveform parameter calculation results. 3. Decision output (REC, FFT) GO and NG outputs on right side panel: open collector outputs (with 5 V output, active low, pulse width 70 ms min.)

18.10 Others

Comment printing	Function, channel, Input range, Zero position, Trigger time, DIV and other information can be printed.
Comment input function	Provided
Cursor measurement function	Time difference, voltage difference or number of cycles between cursors A and B, voltage at each cursor, time from trigger
Scaling function	Specifiable for each channel
Display copy function	Provided
List/gauge functions	ON, OFF
Starting status backup function	Provided
Auto setup function	When the power is turned on, settings and a waveform evaluation area stored on a floppy disk can be automatically loaded.
Auto save function	Provided
Remote control	Start, stop and print control terminals (threshold value: 2.5 V approx. , active low, or terminal short)
Auto-range function	Provided, selects optimum time axis and measurement range for input waveform
VIEW function	Relative positions of displayed data within recording length is shown When memory segmentation is used, usage condition of each block is shown.
On-line help	An explanation of the display screen or the item currently selected by the cursor appears.
Key lock function	Locks all keys except the KEY LOCK key
LCD back lighting	ON, OFF (with the auto OFF function) (auto OFF time can be selected 1 to 30 min)
List print function	Settings output after waveform data print. Output by pressing the PRINT key other than on display screen.
Logic display	On/off for each bits, The comments can be input
Vernier function	Input voltage can be minutely adjusted to the desired value.
Direct channel setting	Settable using the TIME/DIV key The range position of direct input unit can be set by using the knob.
Level monitor function	Provided

18.11 System Operation

System operation is explained according to the block diagram.

- All system operations are controlled by a 32-bit RISC CPU.
- The input unit incorporates high-speed 12-bit A/D converters which are connected to the main unit via a photocoupler integrated in each input unit. Each channel has its own power supply, to assure electrical isolation from the main unit.
- Measurement data stored in memory are processed by the CPU, displayed on the LCD screen, and output to the printer. Output to floppy disk, MO disk, PC card or SCSI is also provided.

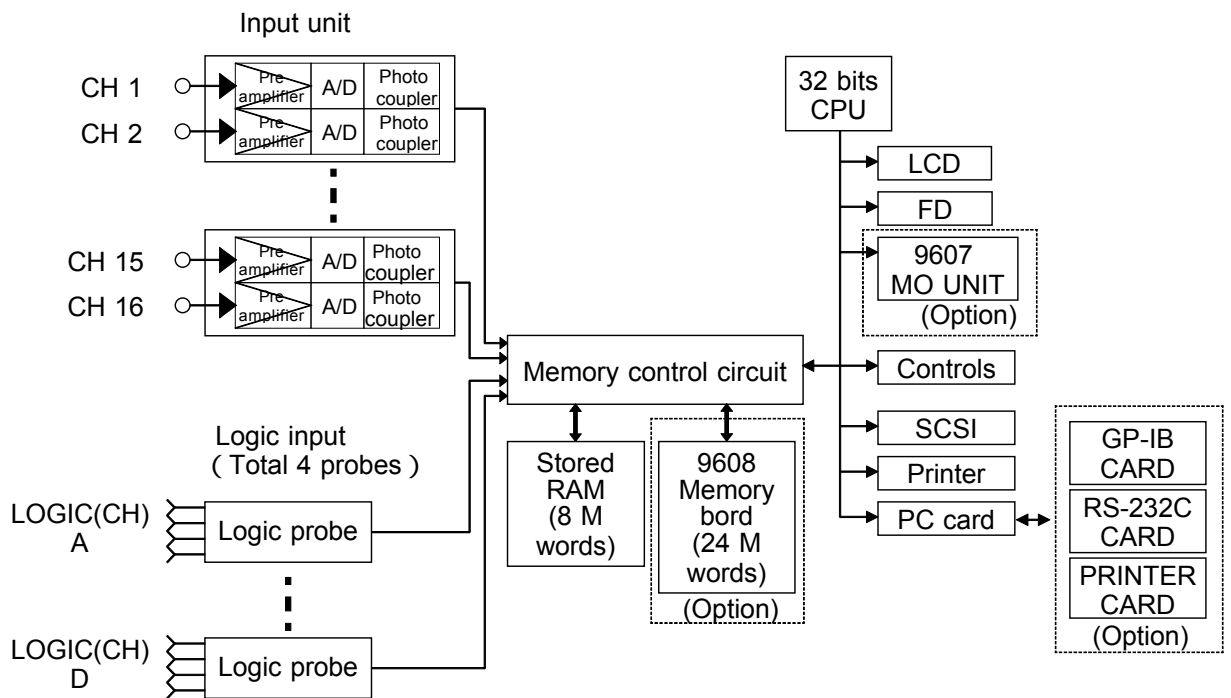

Block Diagram

18.12 Maximum Recording Length for Time Axis Settings

Memory Recorder Function: Standard (8 M)

Time axis range /DIV	Sampling period	Max. recording length			
		16 channels 5000 DIV	8 channels 10000 DIV	4 channels 20000 DIV	2 channels 40000 DIV
100 μ s	1.00 μ s	500ms	1s	2s	4s
200 μ s	2.00 μ s	1s	2s	4s	8s
500 μ s	5.00 μ s	2.5s	5s	10s	20s
1 ms	10.0 μ s	5s	10s	20s	40s
2 ms	20.0 μ s	10s	20s	40s	1min 20s
5 ms	50.0 μ s	25s	50s	1min 40s	3min 20s
10 ms	100 μ s	50s	1min 40s	3min 20s	6min 40s
20 ms	200 μ s	1min 40s	3min 20s	6min 40s	13min 20s
50 ms	500 μ s	4min 10s	8min 20s	16min 40s	33min 20s
100ms	1.00 ms	8min 20s	16min 40s	33min 20s	1h 06min 40s
200ms	2.00 ms	16min 40s	33min 20s	1h 06min 40s	2h 13min 20s
500ms	5.00 ms	41min 40s	1h 23min 20s	2h 46min 40s	5h 33min 20s
1 s	10.0 ms	1h 23min 20s	2h 46min 40s	5h 33min 20s	11h 06min 40s
2 s	20.0 ms	2h 46min 40s	5h 33min 20s	11h 06min 40s	22h 13min 20s
5 s	50.0 ms	6h 56min 40s	13h 53min 20s	1d 03h 46min 40s	1d 07h 33min 20s
10 s	100 ms	13h 53min 20s	1d 03h 46min 40s	2d 07h 33min 20s	4d 15h 06min 40s
30 s	300 ms	1d 17h 40min 00s	3d 11h 20min 00s	6d 22h 40min 00s	13d 21h 20min 00s
1 min	600 ms	3d 11h 20min 00s	6d 22h 40min 00s	13d 21h 20min 00s	27d 18h 40min 00s
2 min	1.20 s	6d 22h 40min 00s	13d 21h 20min 00s	27d 18h 40min 00s	55d 13h 20min 00s
5 min	3.00 s	17d 08h 40min 00s	34d 17h 20min 00s	69d 10h 40min 00s	138d 21h 20min 00s

s: seconds, min: minutes, h: hours, d: days

Memory Recorder Function: Expansion (32 M)

Time axis range /DIV	Sampling period	Max. recording length			
		16 channels 20000 DIV	8 channels 40000 DIV	4 channels 80000 DIV	2 channels 160000 DIV
100 μ s	1.00 μ s	2s	4s	8s	16s
200 μ s	2.00 μ s	4s	8s	16s	32s
500 μ s	5.00 μ s	10s	20s	40s	1min 20s
1ms	10.0 μ s	20s	40s	1min 20s	2min 20s
2ms	20.0 μ s	40s	1min 20s	2min 40s	5min 20s
5ms	50.0 μ s	1min 40s	3min 20s	6min 40s	13min 20s
10ms	100 μ s	3min 20s	6min 40s	13min 20s	26min 40s
20ms	200 μ s	6min 40s	13min 20s	26min 40s	53min 20s
50ms	500 μ s	16min 40s	33min 20s	1h 06min 40s	2h 13min 20s
100ms	1.00ms	33min 20s	1h 06min 40s	2h 13min 20s	4h 26min 40s
200ms	2.00ms	1h 06min 40s	2h 13min 20s	4h 26min 40s	8h 53min 20s
500ms	5.00ms	2h 46min 40s	5h 33min 20s	11h 06min 40s	22h 13min 20s
1s	10.0ms	5h 33min 20s	11h 06min 40s	22h 13min 20s	1d 20h 26min 40s
2s	20.0ms	11h 06min 40s	22h 13min 20s	1d 20h 26min 40s	3d 16h 53min 20s
5s	50.0ms	1d 03h 46min 40s	1d 07h 33min 20s	3d 15h 06min 40s	7d 06h 13min 20s
10s	100ms	2d 07h 33min 20s	4d 15h 06min 40s	9d 06h 13min 20s	18d 12h 26min 40s
30s	300ms	6d 22h 40min 00s	13d 21h 20min 00s	27d 18h 40min 00s	55d 13h 20min 00s
1min	600ms	13d 21h 20min 00s	27d 18h 40min 00s	55d 13h 20min 00s	111d 02h 40min 00s
2min	1.20s	27d 18h 40min 00s	55d 13h 20min 00s	111d 02h 40min 00s	222d 05h 20min 00s
5min	3.00s	69d 10h 40min 00s	138d 21h 20min 00s	277d 18h 40min 00s	555d 13h 20min 00s

s: seconds, min: minutes, h: hours, d: days

Recorder Function

Approximate recording time on one roll (30 m) of recording paper

(Time axis resolution: 100 points /DIV)

Time axis range	Recording paper transport speed	Recording time
20ms/DIV	20mm/s	1 min
50	20	25 min
100	20	5 min
200	20	10 min
500	20	25 min
1s/DIV	10	50 min
2	5	1 h 40 min
5	2	4 h 10 min
10	1	8 h 20 min
30	20mm/min	1 d 1 h
1min/DIV	10	2 d 2 h
2	5	4 d 4 h
5	2	10 d 10 h
10	1	20 d 20 h
30	20mm/h	62 d 12 h
1h/DIV	10	125 d

s: seconds, min: minutes, h: hours, d: days

18.13 Memory Capacity and Recording Length

Memory Recorder Function

Card capacity	Number of divisions per channel (channel)			
	2	4	8	16
8 M words	40000	20000	10000	5000
32 M words	160000	80000	40000	20000

Recorder and RMS Recorder Function

Card capacity	Number of divisions
8 M words	2000
32 M words (Expansion)	10000

Recorder and Memory Function

Card capacity	Number of divisions	
	REC	MEM
8 M words	1000	2000
32 M words (Expansion)	5000	10000



Chapter 19

Logic and Analog Inputs

19

19.1 Logic Inputs

⚠ WARNING

- The unit has separate inputs for four probes, but the ground lines of these inputs are not isolated from each other and from the frame ground of the unit (common ground). If voltage having a different ground level is input, a short circuit will occur, depending on the probe type.
- Do not connect logic probes other than supplied by HIOKI to the logic inputs.

Logic Probe Connection

- The logic input is located on the right side of the unit. Up to four probes can be connected.
- Since one logic probe can record 4 channels, the combined maximum recording capability for logic waveforms is 16 channels.
- Connect the probe by aligning the groove on the plug with the ridge on the connector.

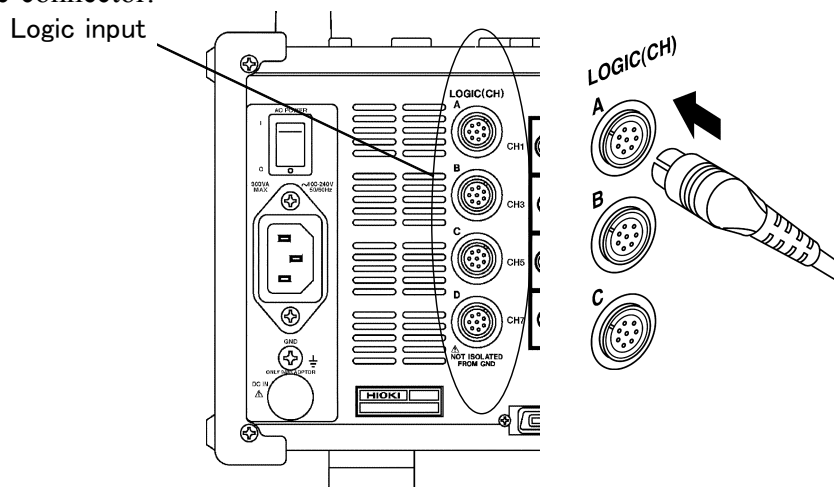

NOTE

- If no logic probe is connected, the corresponding logic waveform is displayed on the screen at high level.
- Carefully read the instruction manual supplied with the probe.

9320 LOGIC PROBE

- When measuring digital signals
Set the input selector to DIGITAL when measuring digital signals. In this case, use IC clip lead. Connect the alligator clip to the circuit ground. Use the threshold value selector to select the threshold value.
- When measuring contact signals
Set the input selector to CONTACT when measuring contact signals. In this case, use alligator clip lead. When these lines are shorted, H level is applied to the contact input.

Range	Digital input (Threshold value)	Contact input (Detecting resistance value)
1.4 V	1.4 V \pm 0.3 V	More than 1.5 k Ω opened (Output L) Less than 500 Ω shorted (Output H)
2.5 V	2.5 V \pm 0.4 V	More than 3.5 k Ω opened (Output L) Less than 1.5 k Ω shorted (Output H)
4.0 V	4.0 V \pm 0.5 V	More than 25 k Ω opened (Output L) Less than 8 k Ω shorted (Output H)

9321 LOGIC PROBE

- Set the input selector in accordance with the measured voltage.
LOW range: Turning 100 VAC and 24 VDC, etc. ON/OFF
HIGH range: Turning 200 VAC, etc. ON/OFF
- Since the inputs are bipolar, polarity should be disregarded.
- Because the inputs are insulated, each channel is connectable to independent potential points.

The number of channels	4 (insulated)	
Input voltage range	LOW	HIGH
Input resistance	30 k Ω min	100 k Ω min
Sensitivity (Output: H)	0 to 10 VAC \pm (0 to 15) VDC	0 to 30 VAC \pm (0 to 43) VDC
Sensitivity (Output: L)	60 to 150 VAC \pm (20 to 150) VDC	170 to 250 VAC \pm (70 to 250) VDC
Response time (↑) (↓)	Less than 1 ms Less than 3 ms with 100 VDC	Less than 1 ms Less than 3 ms with 200 VDC
Maximum input voltage	150 Vrms	250 Vrms
Maximum rated voltage to earth	250 Vrms	
Dielectric strength	2.3 kVAC /1 min (between unit and channels)	
Insulation resistance	More than 100 M Ω / 500 VDC (between unit and channels)	

This unit detects absolute values so that negative DC voltages can be applied. The above values for AC voltages are those obtained with sine wave signals of 50/60 Hz.

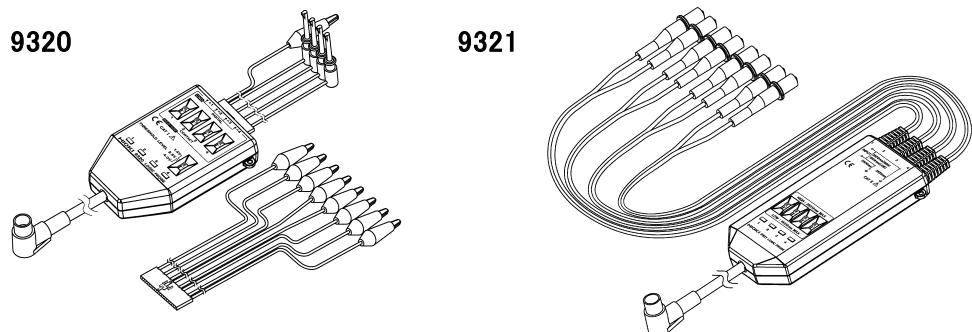

The 9306 and 9307 (no longer manufactured) can be also used.



19.2 Analog Inputs

Measurement Errors Caused by Signal Source Internal Resistance

- If the signal source impedance is higher than the input impedance of the unit, a measurement error will occur.
- The input impedance of the 8936 ANALOG UNIT is 1 M Ω . If the signal source impedance is 1 k Ω , an error of about 0.1% will occur.

$$\text{Measurement error} = E_s \left[1 - \frac{R_{in}}{R_s + R_{in}} \right] \text{ [V]}$$

E_s : Signal voltage
 R_s : Signal source resistance
 R_{in} : Input resistance

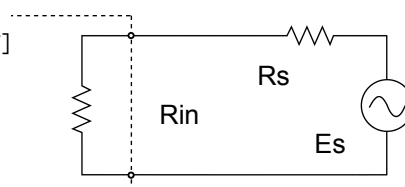

19

19.2.1 8936 ANALOG UNIT

Accuracy at 23°C \pm 5°C, 35% to 80%RH after zero adjustment after 30-minute warming-up time Accuracy guaranteed for 1 year.

Measurement ranges	5, 10, 20, 50, 100, 200, 500 mV/DIV, 1, 2, 5, 10, 20 V/DIV
DC amplitude accuracy	$\pm 0.4\%$ f.s.
Zero position accuracy	$\pm 0.1\%$ f.s.
Zero position setting range	-50 to 150% of the recording width (in full-size representation of the measurement range)
Temperature characteristic	Gain: $\pm 0.025\%$ f.s./ $^{\circ}$ C, Zero position: $\pm 0.02\%$ f.s./ $^{\circ}$ C
Frequency characteristic	DC to 400 kHz ± 3 dB (DC coupling) 7 Hz to 400 kHz ± 3 dB (AC coupling, low cutoff frequency: 7 Hz $\pm 20\%$)
Noise	450 μ Vp-p(typ), 750 μ Vp-p(max.) (sensitivity range, with input shorted)
Common mode rejection ratio	80 dB min (at 50/60 Hz and with signal source resistance 100 Ω max.)
Low-pass filter	OFF, 5, 500, 5 k, 100 k $\pm 50\%$ (Hz) -3 dB
Input type	Unbalanced (input isolated from output)
Input resistance	1 M Ω $\pm 1\%$
Input capacitance	30pF ± 10 pF (at 100kHz)
Input coupling	DC, GND, AC
A/D resolution	12 bits
Voltage axis resolution	80 points/DIV
Maximum sampling speed	1 MS/s (sampling period: 1 μ s)
Input terminals	Insulated BNC terminal
Maximum input voltage	400 VDC max.
Maximum rated voltage to earth	370 VAC/DC (between each input channel and main unit, and between input channels)
Operational ranges for temperature and humidity	Same as the MEMORY HiCORDER in which the 8936 is installed
Location for use	Same as the MEMORY HiCORDER in which the 8936 is installed
Temperature and humidity ranges for storage	Temperature: -10 $^{\circ}$ C to 50 $^{\circ}$ C (50 $^{\circ}$ F to 122 $^{\circ}$ F) Relative humidity: 80%RH max. (with no condensation)

Effect of radiated radio-frequency electromagnetic field	$\pm 2\%$ f.s. at 3V/m
Effect of conducted radio-frequency electromagnetic field	$\pm 28\%$ f.s. at 3V
Dielectric strength	Between 8936 and main unit, between 8936 and input unit: 3.7 kVAC for a minute
Dimensions / Mass	Approx. 170W \times 20H \times 148.5D mm (6.69"W \times 0.79"H \times 5.832"D), Approx. 290 g (10.2 oz)
Standard Applying	EMC EN61326, Class A Safety EN61010 Pollution Degree 2, measurement category (anticipated transient overvoltage 4000 V)

19.2.2 8937 VOLTAGE / TEMP UNIT

Accuracy at 23°C \pm 5°C, 35% to 80%RH after zero adjustment after 60-minute warming-up time

Accuracy guaranteed for 1 year.

Voltage input

Measurement ranges	500 μ V/DIV, 1, 2, 5, 10, 20, 50, 100, 200, 500 mV/DIV, 1, 2 V/DIV
Zero position setting range	-50 to 150%f.s. of the recording width (in full-size representation of the vertical axis)
DC amplitude accuracy	$\pm 0.4\%$ f.s.
Zero position accuracy	$\pm 0.15\%$ f.s.
Temperature characteristic	Gain: $\pm 0.02\%$ f.s./°C Zero position: $\pm 0.03\%$ f.s./°C
Frequency characteristic	DC to 400 kHz $\pm \frac{1}{3}$ dB (in 500 μ to 2 V/DIV range) DC to 3 kHz $\pm \frac{1}{3}$ dB (with digital filter ON in 500 μ to 2 mV/DIV range) (data update rate: 100 μ s \pm 20%)
Noise	75 μ Vp-p typical, 120 μ Vp-p max. (with digital filter OFF in 500 μ V/DIV range) 20 μ Vp-p typical, 30 μ Vp-p max. (with digital filter ON in 500 μ V/DIV range)
Low-pass filter	OFF, 5, 500, 5 k, 100 k \pm 50% (Hz) (-3 dB)
Input terminals	BNC terminal
Input resistance	1 M \pm 1%
Input capacitance	50 pF \pm 20 pF (at 100 kHz)
Input coupling	DC, GND, AC

Temperature input

Measurement ranges	10, 20, 50, 100 /DIV
Measurement input range	K: -200°C to 800°C S: 0 to 1700°C J: -200°C to 1100°C B: 300 to 1800°C T: -200°C to 400°C N: -200°C to 1300°C
Zero position setting range	-100 to 100% f.s. (in full-size representation of the vertical axis)

Temperature measurement accuracy	K, E, J, T, N $\pm 0.1\%$ f.s. $\pm 1.0^\circ\text{C}$ $\pm 0.1\%$ f.s. $\pm 2.0^\circ\text{C}$ (-200 to 0°C) R, S $\pm 0.1\%$ f.s. $\pm 3^\circ\text{C}$ B (effective measurement range: 400°C to 1800°C) $\pm 0.1\%$ f.s. $\pm 4^\circ\text{C}$
Reference junction compensation	Selectable internal or external
Reference junction compensation accuracy	$\pm 0.1\%$ f.s. $\pm 1.5^\circ\text{C}$ (with internal reference contact compensation and input terminal in state of temperature equilibrium)
Temperature characteristic	$\pm 0.05\%$ f.s./ $^\circ\text{C}$ (sensor: K, E, J, T, N, with drift compensation mode OFF) $\pm 0.25\%$ f.s./ $^\circ\text{C}$ (sensor: R, S, B, with drift compensation mode OFF) $\pm 0.04\%$ f.s./ $^\circ\text{C}$ (all sensors, with drift compensation mode ON)
Frequency characteristic	DC to 1 kHz $\pm 1/3$ dB (data update rate: $250\ \mu\text{s} \pm 70\%$, with drift compensation mode OFF) (data update rate: $1\ \text{s} \pm 20\%$, with drift compensation mode ON)
Low-pass filter	OFF, 5, 500 $\pm 50\%$ (Hz) (-3 dB)
Input terminals	2-terminal terminal block
Input resistance	5.1 M $\pm 5\%$

Common specifications

Common mode rejection ratio	80 dB minimum (at 50/60 Hz and with signal source resistance 100 maximum)
Input type	Unbalanced input (isolated from output)
A/D resolution	12 bits
Maximum sampling speed	1 MS/s (However, update rate differs with temperature input.)
Maximum input voltage	30 Vrms or 60 VDC
Maximum rated voltage to earth	30 Vrms or 60 VDC
Operational ranges for temperature and humidity	Same as the MEMORY HiCORDER in which the 8937 is installed
Location for use	Same as the MEMORY HiCORDER in which the 8937 is installed
Temperature and humidity ranges for storage	Temperature: -10°C to 50°C (14°F to 122°F) Relative humidity: 80%RH maximum (with no condensation)
Effect of radiated radio-frequency electromagnetic field	$\pm 2\%$ f.s. at 3 V/m (at 5 mV/DIV)
Dielectric strength	Between 8937 and main unit, between 8937 and input unit: 400 VAC for a minute
Dimensions	Approx. 170W \times 20H \times 148.5D mm (6.69"W \times 0.79"H \times 5.832"D) (excluding projections)
Mass	Approx. 300 g (10.6 oz)
Standard Applying	EMC EN61326, Class A Safety EN61010 Pollution Degree 2, measurement category (anticipated transient overvoltage 330 V)

19.2.3 8938 FFT ANALOG UNIT

Accuracy at 23°C ± 5°C, 35% to 80%RH zero adjustment, after 30-minutes warming-up time. Accuracy guaranteed for 1 year

Number of channels	2 channels
Measurement range	5, 10, 20, 50, 100, 200, 500 mV/DIV, 1, 2, 5, 10, 20 V/DIV
DC amplitude accuracy	± 0.4%f.s.
Zero position accuracy	± 0.1%f.s.
Temperature characteristic	Gain: ± 0.025%f.s./°C, Zero position: ± 0.02%f.s./°C
Frequency characteristic	DC to 400 kHz ± 3 dB (DC coupling) 7 Hz to 400 kHz ± 3 dB (AC coupling, low cutoff frequency 7 Hz ± 20%)
Noise	500 μ Vp-p(typ.), 750 μ Vp-p(max.) maximum sensitivity range, with input shorted
Common mode rejection ratio	80 dB min. (at 50/60 Hz and with signal source resistance 100 max.)
Low-pass filter	OFF, 5, 500, 5 k, 100 k ± 50% (Hz) -3 dB
Anti-aliasing filter	Cutoff frequency (fc) 20, 40, 80, 200, 400, 800, 2 k, 4 k, 8 k, 20 k, 40 k (Hz) (auto setting when anti-aliasing filter on) Attenuation: -66 dB min at 1.5 fc
Input type	Unbalanced (input isolated from output)
Input resistance and capacitance	1 M ± 1% 30 pF ± 10pF (at 100 kHz)
Input coupling	DC, GND, AC
A/D resolution	12 bits
Maximum sampling speed	1 MS/s (sampling period: 1 μ s)
Input terminals	Insulated BNC terminal
Maximum input voltage	400 VDC max.
Maximum rated voltage to earth	370 VAC/DC (between input channels and unit, between input channels)
Operational ranges for temperature and humidity	Same as the MEMORY HiCORDER in which the 8938 is installed
Location for use	Same as the MEMORY HiCORDER in which the 8938 is installed
Temperature and humidity ranges for storage	Temperature: -10 to 50°C (14°F to 122°F) Relative humidity: 80%RH or less (with no condensation)
Effect of radiated radio-frequency electromagnetic field	± 2%f.s. at 3V/m
Effect of conducted radio-frequency electromagnetic field	± 28%f.s. at 3V
Dielectric strength	Between 8938 and main unit, between 8938 and input unit: 3.7 kVAC for a minute
Dimensions / Mass	Approx. 170W × 20H × 148.5D mm (6.69"W × 0.79"H × 5.832"D) Approx. 290 g (10.2 oz)
Standard Applying	EMC EN61326, Class A Safety EN61010 Pollution Degree 2, measurement category (anticipated transient overvoltage 4000 V)

19.2.4 8939 STRAIN UNIT

Accuracy at 23°C ± 5°C, 35% to 80%RH after auto-balancing, after 60-minutes warming-up time. Accuracy guaranteed for 1 year

Number of input channels	2 channels
Appropriate adapter	Strain gauge adapter, Bridge resistance: 120 to 1 k
Bridge voltage	2 ± 0.05 V
Balancing	Electronic auto-balancing
Balance adjustment range	± 10000 μ max.
Measurement ranges	20, 50, 100, 200, 500, 1000 μ /DIV
DC amplitude accuracy	± (0.5%f.s. + 2 μ)
Zero position setting range	-50 to 150% of the recording width (in full-size representation of the measurement range)
Zero position accuracy	± 0.5%f.s.
Temperature characteristic	Gain: ± 0.05%f.s./°C Zero position: ± 2 μ /°C (20,50 μ /DIV) ± 0.1%f.s./°C (other ranges)
Frequency characteristic	DC to 20 kHz $\pm \frac{1}{3}$ dB
Low-pass filter	OFF, 10 Hz, 30 Hz, 300 Hz, 3 kHz ± 30%, -3dB
A/D resolution	12 bits
Maximum sampling speed	1 MS/s (sampling period: 1 μ s)
Maximum input voltage	10 V (DC + AC peak)
Maximum rated voltage to earth	30 Vrms or 60 VDC
Operational ranges for temperature and humidity	Same as the MEMORY HiCORDER in which the 8939 is installed
Location for use	Same as the MEMORY HiCORDER in which the 8939 is installed
Temperature and humidity ranges for storage	Temperature: -10°C to 50°C (14° F to 122° F) Relative humidity: 80%RH max. (with no condensation)
Effect of radiated radio-frequency electromagnetic field	± 5%f.s. at 3V/m
Dielectric strength	Between 8939 and main unit, between 8939 and input unit: 400 VAC for a minute
Dimensions / Mass	Approx. 170W × 20H × 148.5D mm (6.69"W × 0.79"H × 5.832"D) Approx. 250 g (8.8 oz)
Accessories	Conversion cable × 2 (Compatible sensor connector: PRC03-12A10-7M10.5 by TAJIMI)
Standard Applying	EMC EN61326, Class A Safety EN61010 Pollution Degree 2, measurement category (anticipated transient overvoltage 330 V)

19.2.5 8946 4ch ANALOG UNIT

Accuracy at 23°C ± 5°C, 35% to 80%RH after auto-balancing, after 60-minutes warming-up time. Accuracy guaranteed for 1 year

Number of channels	4 channels
Measurement range	10, 20, 50, 100, 200, 500 mV/DIV, 1, 2 V/DIV
DC amplitude accuracy	± 0.5%f.s.
Zero position setting range	-50 to 150% of the recording width (in full-size representation of the measurement range)
Zero position accuracy	± 0.15%f.s. after zero-adjustment
Temperature characteristic	Gain: ± 0.05%f.s./°C Zero position: ± 0.02%f.s./°C after zero-adjustment
Frequency characteristic	DC to 100 kHz ± 3 dB
Noise	1 mVp-p (typ), 2 mVp-p (max.) (sensitivity range, with input shorted)
Common mode rejection ratio	80 dB min. (at 50/60 Hz and with signal source resistance 100 max.)
Low-pass filter	OFF, 5, 500, 5 k, 50 k ± 50%(Hz) -3 dB
Input type	Unbalanced input (isolated from output)
Input resistance and capacitance	1 M ± 1% 15 pF ± 10pF (at 100 kHz)
Input coupling	DC, GND
A/D resolution	12 bits
Maximum sampling speed	1 MS/s (sampling period: 1 μs)
Input terminals	BNC terminal
Maximum input voltage	30 Vrms or 60 VDC
Maximum rated voltage to earth	30 Vrms or 60 VDC (between input channels and unit, between input channels)
Operational ranges for temperature and humidity	Same as the MEMORY HiCORDER in which the 8946 is installed
Location for use	Same as the MEMORY HiCORDER in which the 8946 is installed
Temperature and humidity ranges for storage	Temperature: -10 to 50°C (14° F to 122° F) Relative humidity: 80%RH or less (with no condensation)
Effect of radiated radio-frequency electromagnetic field	± 2%f.s. at 3V/m
Dielectric strength	Between 8946 and main unit, between 8946 and input unit: 330 VAC for a minute
Dimensions / Mass	Approx. 170W × 20H × 148.5D mm (6.69"W × 0.79"H × 5.832"D) Approx. 310 g (10.93 oz)
Standard Applying	EMC EN61326, Class A Safety EN61010 Pollution Degree 2, measurement category (anticipated transient overvoltage 330 V)

19.2.6 8940 F/V UNIT

Accuracy at 23°C ± 5°C, 35% to 80%RH after auto-balancing, after 30-minutes warming-up time. Accuracy guaranteed for 1 year

■ General specifications

A/D resolution	12 bit
Vertical axis resolution	80 LSB/DIV
Measurement function	Frequency measurement, Count, Duty, Voltage measurement, Current measurement
Maximum sampling speed	1 μs
Low-pass filter	OFF, 5, 500, 5 k, 100 k ± 50% (Hz) -3 dB
Input coupling	DC, GND, AC (Fixed DC coupling except voltage and current measurement)
Pull up	ON/OFF (Constant OFF in current measurement) Pull up resistance: 10 k
BNC connector	Input resistance: 1 M ± 1% (at pull-up OFF) Input capacitance: 60 pF ± 20 pF (at 100 kHz) Input type: Unbalanced (for Voltage, Frequency, Count, Duty) Note: With the 3273, the BNC connector and sensor connector are used together. GND is common with the MEMORY HiCORDER in which the unit is installed.
Sensor connector (Current measurement)	Possible to connect 4 channel Note: With the 3273, the BNC connector and sensor connector are used together. GND is common with the MEMORY HiCORDER in which the unit is installed.
Maximum input voltage	30 Vrms or 60 VDC
Maximum rated voltage to earth	30 Vrms or 60 VDC (BNC)
Operational ranges for temperature and humidity	Same as the MEMORY HiCORDER in which the 8940 is installed
Location for use	Same as the MEMORY HiCORDER in which the 8940 is installed
Temperature and humidity ranges for storage	Temperature: -10°C to 50°C (14°F to 122°F) Relative humidity: 80%RH maximum (with no condensation)
Dimensions	Approx. 170W × 20H × 148.5D mm (6.69"W × 0.79"H × 5.85"D) (excluding projections)
Mass	Approx. 300 g (10.6 oz)
Effect of radiated radio-frequency electromagnetic field	± 5% f.s. at 3 V/m
Standard Applying	EMC EN61326, Class A Safety EN61010 Pollution Degree 2, measurement category (anticipated transient overvoltage 330 V)
Accessories	Instruction manual
Option	9318 CONVERSION CABLE (for 9270*,9271*,9272*,9277,9278,9279*) 9319 CONVERSION CABLE (for 3273) *: Not complied with the CE marking.

■ Frequency, Count and Duty Measurement

Frequency ranges	0.05, 0.1, 0.5, 1, 5, 10, 50, 100, 500 Hz/DIV 1, 5 kHz/DIV 5, 10, 50, 100, 500 r/min/DIV Power source frequency ranges: P50 Hz (40 to 60 Hz), P60 Hz (50 to 70 Hz)
Frequency accuracy	± 0.2%f.s. (except 100 kHzf.s. range) ± 0.7%f.s. (100 kHzf.s. range) ± 0.032Hz (Power source frequency ranges)
Frequency hold	ON/OFF (waiting time 10 ms, 1 s variable) When hold is OFF, the current measurement value is halved if the next measurement value is not fixed within the waiting time.
Count ranges	5, 10, 50, 100, 500 counts/DIV 1, 5, 10, 50, 100, 500 k counts/DIV
Duty range	100%f.s.
Duty accuracy	± 1% (10 Hz to 10 kHz)
Threshold value (common)	-10 to +10 V variable (0.2 V steps)
Frequency measurement ranges(common)	DC to 100 kHz (Frequency) DC to 90 kHz (Count) 10 Hz to 100 kHz (Duty)
Response time (common)	10 μs not greater (Frequency (more than 300 Hz), Count) 50 μs not greater (Frequency (less than 300 Hz), Duty) The sampling period of the MEMORY HiCORDER in which the unit is installed must be added to the above.

■ Voltage and Current measurement

Voltage range	500 μV/DIV, 1, 2, 5, 10, 20, 50, 100, 200, 500 mV/DIV, 1, 2 V/DIV
Current range	Using the 9270 ^{*2} , 9272(20A) ^{*2} , 9277 ^{*2} , 3273 5, 10, 20, 50, 100, 200, 500 mA/DIV, 1, 2, 5 A/DIV Using the 9271 ^{*2} , 9272(200A) ^{*2} , 9278 ^{*2} 50, 100, 200, 500 mA/DIV, 1, 2, 5, 10, 20, 50 A/DIV Using the 9279 ^{*2} 200 ^{*1} , 500 mA/DIV, 1 ^{*1} , 2 ^{*1} , 5, 10 ^{*1} , 20 ^{*1} , 50, 100 ^{*1} A/DIV ^{*1} : Vertical resolution 64 LSB/DIV ^{*2} : Not complied with the CE marking.
Frequency characteristic (common)	DC to 400 kHz ± 3 dB (DC coupling) (When using a sensor, depends on the characteristics of the sensor.)
DC amplitude accuracy (common)	± 0.4%f.s. (Using the 9279 ± 0.5%f.s.)
Zero position accuracy (common)	± 0.15%f.s. (Using the 9279 ± 0.2%f.s.)
Temperature characteristic (common)	Gain: ± 0.025%f.s./°C Zero position: ± 0.03%f.s./°C (range: 0.5, 1, 2 mV/DIV) : ± 0.04%f.s./°C (range: except 0.5, 1, 2 mV/DIV)
Common mode rejection ratio	80 dB minimum (at 50/60 Hz and with signal source resistance 100 maximum)
Noise	150 μVp-p max. (f.s.=20 DIV, at 0.5 mV/DIV range)

When measuring current, the accuracy and characteristics of the probe must be added to the above.

19.2.7 8947 CHARGE UNIT

Accuracy at 23°C ± 5°C, 35% to 80%RH after auto-balancing, after 60-minutes warming-up time. Accuracy guaranteed for 1 year

■ General specification

Number of input channels	2 channels (switching) Any of the following can be selected: Charge input, input from preamp, voltage input or individual channels
Input type	Unbalanced input (floating between inputs, floating between input and unit ground, common ground between voltage input and charge input)
Zero position setting range	-50 to 150%f.s. (when vertical axis (× 1) display)
Common mode rejection ratio	80 dB minimum (at 50/60 Hz and with signal source resistance 100 maximum)
Anti-aliasing filter	Cutoff frequency (fc) 20, 40, 80, 200, 400, 800, 2 k, 4 k, 8 k, 20 k, 40 k (Hz) (ON/OFF, auto setting corresponding to the time axis and frequency axis range) Attenuation: -66 dB min at 1.5 fc
Maximum sampling speed	1 MS/s
A/D resolution	12 bits
Operational ranges for temperature and humidity	Temperature: 5°C to 40°C (41° F to 104° F) Relative humidity: 35 to 80%RH maximum (Same as the MEMORY HiCORDER in which the 8947 is installed)
Temperature and humidity ranges for storage	Temperature: -10°C to 50°C (14° F to 122° F) Relative humidity: 80%RH maximum (with no condensation)
Location for use	Same as the MEMORY HiCORDER in which the 8947 is installed
Effect of radiated radio-frequency electromagnetic field	± 10% f.s. at 3 V/m (5 mV/DIV range)
Dimensions / Mass	Approx. 170W × 20H × 148.5D mm (6.69"W × 0.79"H × 5.85"D) (excluding projections) Approx. 310 g (10.9 oz)
Standard Applying	EMC EN61326, Class A Safety EN61010 Pollution Degree 2, measurement category (anticipated transient overvoltage 330 V)

■ Charge Input

Compatible converter:	Charge-output type piezoelectric accelerator pickup sensor
Measurement sensitivity	0.1 to 10 pC/(m/s ²)
Measurement range	2,5,10,20,50,100,200,500,1k,2k,5k,10 km/s ² /DIV (Measurement sensitivity: 0.1 to 0.25 pC/(m/s ²)) 1,2,5,10,20,50,100,200,500,1k,2k,5 km/s ² /DIV (Measurement sensitivity: 0.251 to 0.5 pC/(m/s ²)) 500m,1,2,5,10,20,50,100,200,500,1k,2 km/s ² /DIV (Measurement sensitivity: 0.501 to 1.0 pC/(m/s ²)) 200m,500m,1,2,5,10,20,50,100,200,500,1 km/s ² /DIV (Measurement sensitivity: 1.01 to 2.5 pC/(m/s ²)) 100m,200m,500m,1,2,5,10,20,50,100,200,500 m/s ² /DIV (Measurement sensitivity: 2.51 to 5.0 pC/(m/s ²)) 50m,100m,200m,500m,1,2,5,10,20,50,100,200 m/s ² /DIV (Measurement sensitivity: 5.01 to 10.0 pC/(m/s ²))
Amplitude accuracy	± 2%f.s
Temperature characteristic	± 0.2%f.s./°C
Frequency characteristic	1 to 50 kHz(+1/-3 dB)
Low-pass filter	500, 5 kHz ± 50%(-3 dB)
Maximum input charge	± 500 pC (with six high-sensitivity ranges selected) ± 50,000 pC (with six low-sensitivity ranges selected)
Input terminal	Miniature connector (#10-32UNF)

■ Input for Sensor Preamp

Compatible converter:	Internal preamp type accelerator pickup sensor
Measurement sensitivity	0.1 to 10 mV/(m/s ²)
Measurement range	2,5,10,20,50,100,200,500,1k,2k,5k,10 km/s ² /DIV (Measurement sensitivity: 0.1 to 0.25 mV/(m/s ²)) 1,2,5,10,20,50,100,200,500,1k,2k,5 km/s ² /DIV (Measurement sensitivity: 0.251 to 0.5 mV/(m/s ²)) 500m,1,2,5,10,20,50,100,200,500,1k,2 km/s ² /DIV (Measurement sensitivity: 0.501 to 1.0 mV/(m/s ²)) 200m,500m,1,2,5,10,20,50,100,200,500,1 km/s ² /DIV (Measurement sensitivity: 1.01 to 2.5 mV/(m/s ²)) 100m,200m,500m,1,2,5,10,20,50,100,200,500 m/s ² /DIV (Measurement sensitivity: 2.51 to 5.0 mV/(m/s ²)) 50m,100m,200m,500m,1,2,5,10,20,50,100,200 m/s ² /DIV (Measurement sensitivity: 5.01 to 10 mV/(m/s ²))
Amplitude accuracy	± 2%f.s
Temperature characteristic	± 0.2%f.s./°C
Frequency characteristic	1 to 50 kHz(+1/-3 dB) (low-end cutoff frequency = 1 Hz ± 50%)
Low-pass filter	500, 5 kHz ± 50%(-3 dB)
Drive power	2 mA ± 20%, +15 V ± 5%
Input terminal	BNC connector

■ Voltage input

Measurement range	500 μ , 1m, 2m, 5m, 10m, 20m, 50m, 100m, 200m, 500m, 1, 2 V/DIV
DC amplitude accuracy	$\pm 0.4\%$ f.s.
Zero position setting range	$\pm 0.15\%$ f.s.
Temperature characteristic	Gain: $\pm 0.02\%$ f.s./ $^{\circ}$ C, zero position: $\pm 0.03\%$ f.s./ $^{\circ}$ C
Frequency characteristic	DC to 400 kHz +1/-3 dB (DC coupling) 1 to 400 kHz +1/-3 dB (AC coupling, low-end cutoff frequency 1Hz \pm 50%) (at 500 μ to 2 mV/DIV range)
Noise	75 μ Vp-p typ., 120 μ Vp-p max. (at 500 μ V/DIV range)
Low-pass filter	5 Hz, 500 Hz, 5 kHz, 100 kHz $\pm 50\%$ (-3 dB)
Input resistance	1 M $\pm 1\%$
Input capacity	200 pF max. (at 100 kHz)
Input coupling	DC / AC / GND
Maximum input voltage	30 Vrms or 60 VDC
Maximum rated voltage to earth	30 Vrms or 60 VDC
Input terminal	BNC terminal

Chapter 20

Maintenance and Service

20.1 Maintenance and Inspection

To ensure the safe operation of this unit, perform maintenance regularly.

- If the unit has been subject to moisture, or if oil and dust have accumulated in the unit interior, the danger of electrical shock or fires resulting from the deterioration of insulation increases greatly. If the unit is ever subject to excessive moisture, oil, or dust, cease use immediately, and return the unit to us for maintenance.
- Periodic calibration is necessary to verify and maintain accuracy. If calibration becomes necessary, return the unit to us for maintenance.
- This product uses a lithium battery to back up it's memory. As the battery power is consumed, it's ability to store measurement conditions diminishes. In the event that measurement conditions can no longer be stored, please contact the manufacturer for repair service.
- Spare and replacement parts for this product are guaranteed to be available only until 7 years after manufacture of this model is terminated.
- If the unit is not functioning properly, check the batteries, the probe and leads wiring, fuse blowing, and the "Troubleshooting" list. If a problem is found, contact your dealer.
- Do not transport using the 9397-01 or 9349 CARRYING CASEs.

Cleaning the Unit

- Gently wipe dirt from the surface of the unit with a soft cloth moistened with a small amount of water or mild detergent. Do not try to clean the unit using cleaners containing organic solvents such as benzene, alcohol, acetone, ether, ketones, thinners, or gasoline. They may cause discoloration or damage.
- Wipe the LCD display gently with a dry, soft cloth.

■ Printer Head Cleaning

In normal use, the printer does not require periodic maintenance. However, depending on usage conditions, the thermal head may become contaminated by dust or paper scraps. If the print seems light or if there are dropped sections, clean the head as described below.

Procedure 1

1. Press the **SYSTEM** key to display the SELF CHECK screen.
2. Move the flashing cursor to the PRINTER CHECK item.
3. Press the cleaning function key for about 5 seconds. During this interval, the printer prints 100% black section.
4. If this method does not alleviate the problem, perform the steps of cleaning method 2 as described below.

Procedure 2

1. Moisten printer paper on the rear with alcohol and set the paper in the printer. (If the front side of the paper is moistened, discoloring will occur.)
2. Lower the head up/down lever and move the printer paper back and forth to clean the head.

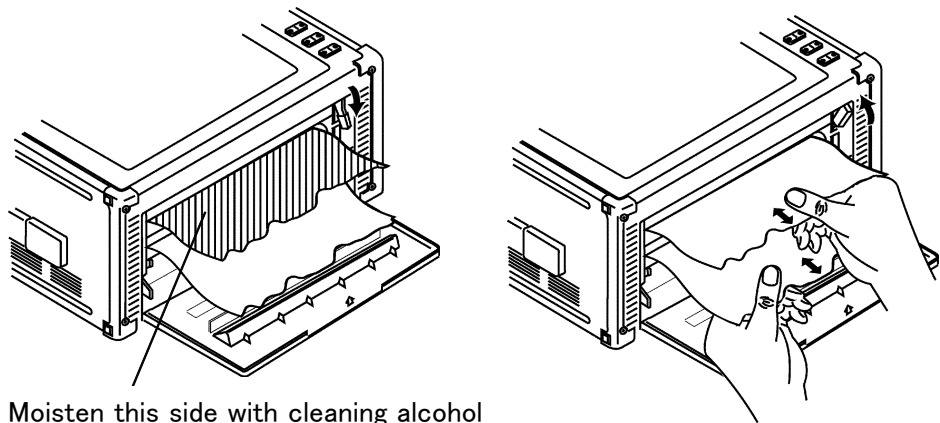

Moisten this side with cleaning alcohol

NOTE

- Do not use organic solvents such as thinners.
- After extended use, paper residue (visible as a white powder-like substance) may accumulate on the roller. While a small amount of residue has no adverse effect, the roller can be cleaned using a air-blow brush (such as sold as a camera accessory).
- Always use the paper cutter integrated in the printer cover to cut printer paper. If the paper is cut near the thermal head, a large amount of paper residue may accumulate on the roller.

20.2 Replacing the Input Units

⚠ WARNING

- To avoid the danger of electric shock, never operate the product with an input module removed. To use the product after removing an input module, install a blank panel over the opening of the removed module.
- The mounting screws must be firmly tightened or the input module may not perform to specifications, or may even fail.
- To avoid the danger of electric shock, never operate the product with an input module removed. To use the product after removing an input module, install a blank panel over the opening of the removed module.

- The following procedure describes how to remove the input unit.
- Install the units by reversing the procedure for removal.

1. Remove the connector cables from all input units.
2. Power off the 8841/42 main unit, and disconnect the power cord.
3. Remove the two fixing screws with a Phillips screwdriver, as shown in the figure below.
4. To remove the input unit, grasp handle or BNC connector.

When replacing the 8936

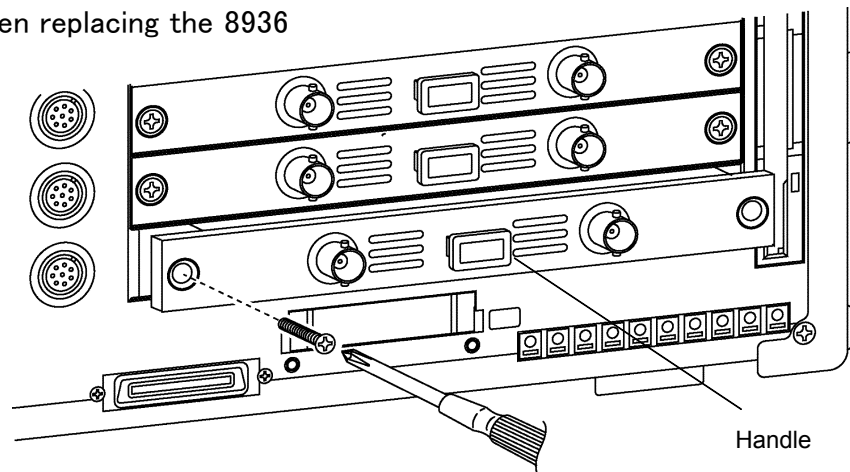

NOTE

Do not measure with a blank panel removed. Otherwise, the unit internal temperature becomes unstable and consequently the specifications are not met.

20.3 Replacing the Fuse of the 9433

⚠ WARNING

- If the fuse has blown, an internal defect in the power supply section of the 9433 may be caused. Check for defects before replacing the fuse.
- To avoid electric shock, turn off the power switch and disconnect the input cables before replacing the fuse.
- Replace the fuse only with one of the specified characteristics and voltage and current ratings. Using a non-specified fuse or shorting the fuse holder may cause a life-threatening hazard.
Type A melting fuse (NM) 30 A/125 V 31.8 mm × 6.4 mm dia.

When the 9433 is used, and the DC power supply fuse has blown, replace the fuse as described below.

1. Set the power switch of the 9433 to OFF.
2. Disconnect the input cord and output cord.
3. Press and turn the fuse holder counterclockwise, remove, and remove the fuse.
4. Replace the fuse. Press and turn the fuse holder clockwise to mount.
5. Reconnect the input and output cords

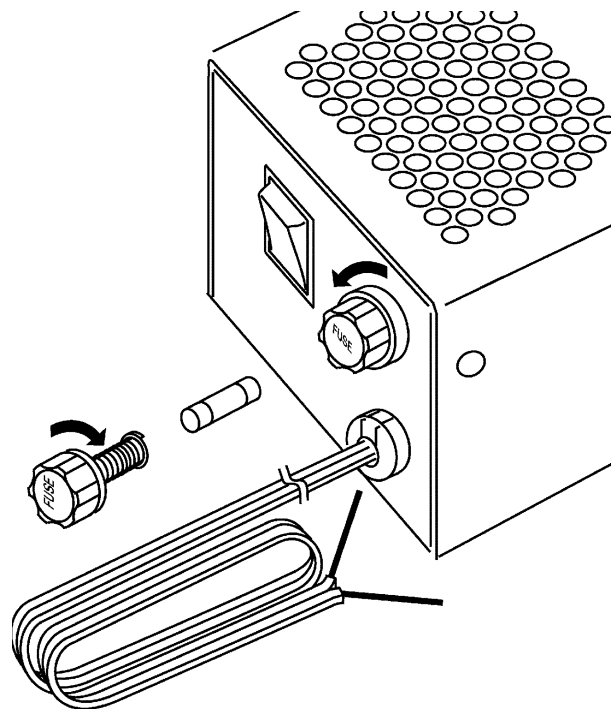

20.4 Removing the Battery Before Discarding the Unit

⚠ WARNING

To avoid electrocution, turn off the power switch and disconnect the thermocouples and measurement cables before removing the lithium battery.

When disposing of this product, remove the lithium battery and dispose of battery and product in accordance with local regulations.

Before final disposal of the 8841/42, remove the battery as described below.

1. Verify that the power is switched OFF.
2. Disconnect all connector cables, the power cord and thermocouples.
3. Remove 4 bolts as illustrated below, and then remove the cover.

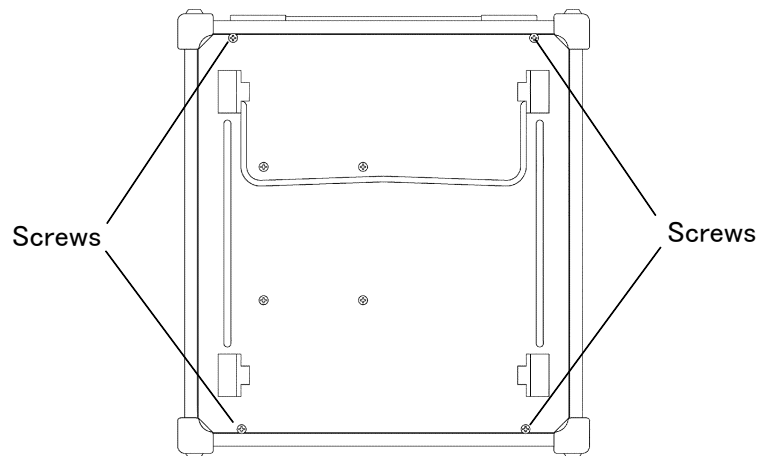

4. Remove the rear panel. The battery is located in the position on the PCB shown in the figure.

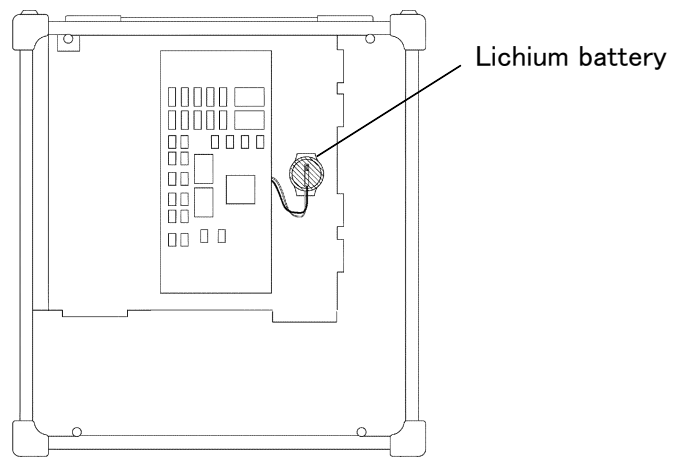

5. Remove the battery cords (red and black) from the board. (Pulling the cords unplugs them from the board.) Otherwise, cut the cords with wire-snippers.
6. Remove the battery (the battery is attached to the board with double-sided adhesive tape).

20.5 Troubleshooting

If the unit does not seem to operate normally, check the following points before requesting service.

Problem	Check
LED does not light when the unit is turned on.	Is power cord connected properly?
There is absolutely no variation in the recorded waveform.	Is the "Pretrigger standby" message displayed? (When pretriggering is activated, triggering does not occur until the current waveform is fully captured.) Has the "Waiting for trigger" message appeared? Check the trigger settings.
There is absolutely no variation in the recorded waveform.	Is the measurement range setting appropriate? Has a low pass filter been set? Is the vernier function is set? Is the offset cancel is set?
The printed recording is non-existent.	Is the recording paper back to front?
Even when the PRINT or the COPY key is pressed, no data is printed.	Make sure the destination of the printout created by pressing the PRINT key or the COPY key is set to "Internal Printer."
The printed recording is very faint.	Are you using the correct (thermal) recording paper?
During memory recorder operation, the apparent frequency of the recording is much lower than the expected frequency.	This is likely to be an aliasing error. Make the time axis range setting faster. For details, see Appendix 3.2.
Recording lines are dense or blurred.	Input signal contains ripple components. Make suitable filter settings at input unit.
Recording lines are duplicated.	When "Dotted line*" is selected as the printed line type in the waveform display color settings, the top and bottom of the line become separated by a 1-dot gap. With waveforms that have little variation, this can cause waveform printing to appear variously as one line or as two lines. To correct this, select "Solid line" as the printed line type.
The keys are dead and do not respond.	Has the unit been put into the key lock condition (message "KEY LOCK" appeared)? Press the KEY LOCK key to clear the key lock condition. Is the unit being remotely controlled ("GP-IB REMOTE" is displayed, if the GP-IB interface is being used)?
Some channels cannot be used.	Is the number of channels to be used restricted?
The size of a waveform does not change, even if the input range is changed.	Has the variable function been enabled? Disable the variable function.
The "Internal MO" media selection is not available.	Is the internal MO interface enabled?

NOTE

If none of the above conditions apply, and the cause of the problem is not understood, try performing a SYSTEM RESET. All the settings will revert to the factory settings. For details, see Section 12.6.3.

Appendix

Appendix 1 Error Messages

The unit produces two levels of message to indicate problems. These are distinguished as follows.

Error messages

- The "ERROR" indication appears at the bottom of the screen, followed by the message. This remains until the cause of the error is removed, or the STOP key is pressed.
- If the "beep sound" item on the system screen is set to ON, then the beeper sounds intermittently while the message is displayed.

Error Message and explanation

ERROR 1: Set printer paper.	Printer paper has run out. Reload.
ERROR 2: Set printer lever.	The head up/down lever has been left in the up position. Lower it.
ERROR 11: Printer is not ready.	External printer is not ready to printout. Set the external printer.
ERROR 12: Set printer power on	Check the external printer connection and power on.
ERROR 13: Paper End	Printer paper has run out. Reload.
ERROR 14: Printer Error.	Check the built-in printer.

Warning Messages

- The "WARNING" indication is displayed on the bottom line of the screen, followed by the message, but disappears after a few seconds.
- Warning messages also disappear if any key is pressed.
- If the "beep sound" item on the system screen is set to ON, then the beeper sounds once only when the message is displayed.

Warning Message and explanation

WARNING 60: Insert MO disk.	No disk is present in the MO disk drive. Insert one.
WARNING 70: Insert Floppy disk.	No disk is present in the floppy disk drive. Insert one.
WARNING 71: Cannot load (not 8841,42 data)	Data cannot be loaded, because it is not a set of data created by the 8841/42.
WARNING 72: Illegal format.	The media is not a correctly formatted MS-DOS, or the floppy disk is a 2DD, 640 KB format disk.
WARNING 73: Write Protected.	The media is write-protected. Release it.
WARNING 74: Disk full.	Data cannot be saved due to insufficient space on the storage medium. Delete files, or use a new storage medium.
WARNING 75: File is read only.	File cannot be written or deleted, because it is read- only.
WARNING 76: General failure.	Access to disk is not possible because of some low-level error, such as in formatting or file saving.
WARNING 80: Insert PC card.	No card is present in the PC card slot. Insert one.
WARNING 90: File already exists.	Another file of the same name exists. Saving cannot be performed.
WARNING 91: Directory full.	Since only a limited number of files (including directory) can be created in the root directory.
WARNING 92: Directory not empty.	The directory is not empty.
WARNING 93: Disk full.	Little capacity is available.
WARNING 94: Path name error.	Up to 127 characters can be used for a path name.
WARNING 95: Empty directory name.	Name the directory.
WARNING 96: Directory already exists.	Another directory of the same name exists. Saving cannot be performed.
WARNING 97: 2DD type FD.	2DD-type FD Select the suitable format.
WARNING 98: 2HD type FD.	2HD-type FD Select the suitable format.
WARNING 99: Conditions for OVERWRITE are not satisfied.	Match the unit condition and file data condition (function and time-axis).
WARNING 201: Set printer paper.	Printer paper has run out. Reload.
WARNING 202: Set printer lever	The head up/down lever has been left in the up position.
WARNING 205: Invalid (START)	The key pressed is not valid, because measurement operation is in progress.
WARNING 207: AUTO RANGE failure.	The auto ranging function has failed. Check the input signal.
WARNING 208: Cannot SAVE. (Write Protected)	Remove the write-protect.
WARNING 209: Cannot SAVE. (Disk Full)	Little capacity is available.
WARNING 213: Invalid (MEASUREMENT)	Pressed key is invalid, because parameter processing is ON.
WARNING 214: Invalid. (Pre Trigger)	Additional recording set on, therefore pre-trigger can not be set.

WARNING 215: Cannot set -95%.	The pre-trigger cannot be set "-95%" at a recording length of 160000 DIV.
WARNING 216: MO drive selected in auto-save.	MO drive selected in auto-save, therefore SCSI cannot be selected.
WARNING 217: SCSI selected in auto-save.	Connected SCSI device selected in auto-save, therefore MO disk cannot be selected.
WARNING 218: The internal MO is accessible from PC only.	The internal MO can only be accessed by the external PC. Operations (file list, automatic storage) on the internal MO cannot be performed from this unit.
WARNING 300: Cannot START. (SYSTEM)	Cannot start measurement from SYSTEM screen.
WARNING 301: Invalid (SYSTEM)	The key pressed is not valid on the system screen.
WARNING 324: Ignore in running. (AVERAGE)	Because averaging is used, waveform processing is not carried out during the start operation.
WARNING 325: Ignore in running. (WAVE CALC)	The vernier change is disabled for processed waveforms.
WARNING 327: Invalid. (COMPARISON)	Pressed key is invalid, when waveform evaluation is being carried out.
WARNING 328: Invalid. (OVER LAY)	Operation is not possible, since the overlay function is enabled.
WARNING 329: Wrong format for Comparison.	Since the format is not SINGLE or XY single, a waveform decision is not possible.
WARNING 330: Cannot set. (SHOT too long)	The recording length is too long for the memory segmentation function or a waveform processing calculation to be carried out.
WARNING 334: Cannot set.(AVERAGE)	Averaging and waveform decision cannot be carried out.
WARNING 335: Cannot set. (SEQUENTIAL)	Waveform processing cannot be carried out, because memory segmentation function is active.
WARNING 336: Cannot set. (MULTI BLOCK)	Waveform processing cannot be carried out, because memory segmentation function is active.
WARNING 337: Cannot set. (ROLL MODE)	Overlay and waveform decision cannot be carried out, because roll mode is active.
WARNING 338: Cannot set. (OVER LAY)	Waveform processing cannot be carried out, because overlay function is active.
WARNING 339: Invalid. (STATUS)	On the status screen, the key pressed is invalid.
WARNING 340: Invalid. (EXT sampling)	External sampling cannot be carried out.
WARNING 345: Cannot set. (AND logic trigger)	AND cannot be set between trigger source RMS level trigger and the logic trigger.
WARNING 346: Cannot set. (AND rms level)	AND cannot be set between trigger source RMS level trigger and the logic trigger.
WARNING 347: Invalid. (Pre Trigger)	If no trigger has been set, pre-trigger (0%) is invalid.
WARNING 348: Invalid. (V-drop Trigger)	When the time axis range is 100 ms to 5 min and external sampling mode is enabled, the voltage drop trigger is disabled.
WARNING 352: Invalid. (CHAN)	On the CHANNEL screen, the key pressed is invalid.
WARNING 353: Cannot set. (time/div:100ms - 5min)	The voltage drop trigger cannot be used when the time axis range is 100ms to 5 min/DIV.
WARNING 354: Cannot set. (frequency:133mHz-400Hz)	The voltage drop trigger is available in the frequency range 800 Hz to 400 kHz.
WARNING 355: Change time axis. (RECORDER)	Since the memory time axis range is slow, the recorder time axis will also be slow.

WARNING 356: Change time axis. (MEMORY)	If the speed of the recorder time axis range is increased beyond two steps below the memory time axis range, the memory time axis range speed is incremented.
WARNING 357: AAF is invalid.	The anti-aliasing filter setting is invalid for the time axis range of 100 to 500 μ s and the frequency range of 400 to 80 kHz.
WARNING 358: Change the time axis range (1 ms -)	The anti-aliasing filter setting is invalid for the time axis range of 100 to 500 μ s. Please change the time axis to between 1 ms and 5 min.
WARNING 359: Change the frequency range (40 kHz -)	The anti-aliasing filter setting is invalid for the frequency range of 400 to 80 kHz. Change the frequency range to between 40 kHz and 133 mHz.
WARNING 380: No data in Ref.Block.	When using the memory segmentation function (multi-block), there is no data in the reference block.
WARNING 381: Ref.block = Using block	When using the memory segmentation function (multi-block), the reference block and the block specified by the "using block" item are the same.
WARNING 382: No waveform data.	Because there is no waveform data present, it cannot be displayed. Start measurement operation to capture data.
WARNING 384: Different Ref.shot.	The recording lengths are different for the reference block and the block specified by the "using block" item. Capture data with the recording lengths set the same.
WARNING 386: Invalid. (RECORDER)	In the recorder function, the key pressed is invalid.
WARNING 387: Invalid. (X-Ycont)	In the X-Y recorder function, the key pressed is invalid.
WARNING 388: No comparison AREA.	No waveform evaluation area. Create waveform evaluation area.
WARNING 389: Cannot use, Printer (200ms).	The printer cannot be used when the time axis range is 20 to 200 ms/DIV.
WARNING 390: Cannot set over up level.	Setting cannot be higher than upper limit.
WARNING 391: Cannot set under low level.	Setting cannot be lower than lower limit.
WARNING 395: Variable is ON.	Since the variable is set to on, changing the voltage axis range will not alter waveform size.
WARNING 394: Cannot cancel offset.	If the input signal deviates more than ± 10 divisions, zero offset is not possible.
WARNING 396: Out of range. (variable)	The settable range for the variable function (captured measurement range value $\times \pm 10000$) was exceeded. When this warning appears, the upper and lower value setting is automatically changed to be within range.
WARNING 397: Out of range. (scaling)	POINT was set for scaling and the settable range was exceeded. See Appendix 3.7.
WARNING 398: A/B cursor positions invalid.	Cursor A and B are not located correctly. Move the cursors to the appropriate position.
WARNING 399: Auto balance failed.	Auto balance did not work properly. Confirm that the sensor is connected properly and that there is no discontinuity.
WARNING 421: Equation contains a syntax error.	Equation contains a syntax error. Correct equation.
WARNING 422: Cannot copy the equation. (Zxx)	Copy function cannot be carried out, because the copy source equation contains a Z number higher than the copy target.
WARNING 423: Upper value has to be bigger than lower value.	Upper value has to be bigger than lower value.
WARNING 425: Length of data in memory is too short.	Recording length is insufficient for the number of FFT points.

WARNING 610: No interface card.	Insert the interface card (PC card).
WARNING 620: Cannot connect. (LAN)	Check the settings or connection environment.
WARNING 622: LAN: Bad IP adress.	The IP address is not set correctly.
WARNING 623: LAN: Bad server IP address.	The IP of the server (that runs the 9333) is not specified correctly.
WARNING 624: LAN: Can not connect to server.	The 8841/42 cannot connect to the PC that runs the 9333. Check the connection environment.
WARNING 625: LAN: Can not connect to 9333.	The 8841/42 cannot connect to the 9333. Check on the PC to see whether the 9333 is in standby status.
WARNING 626: LAN: Connection time out.	Check the connection environment.
WARNING 627: LAN: Transfer was aborted.	Data transmission is interrupted by the STOP key or from the 9333.
WARNING 628: LAN: Network error.	Check the connection environment.
WARNING 629: LAN: Server not found or DNS failed.	Check whether the DNS server is running or set up correctly.
WARNING 630: LAN: DHCP failed.	Check whether the DHCP server is running correctly on the network.
WARNING 797: Mem shot changed.	Since the recording length is long, the recording length will also be short.
WARNING 798: Invalid. (time/div:20ms-200ms)	Since the time axis range is set to 20 to 200 ms/division by the recorder and memory function, the printer cannot be turned on.
WARNING 799: Invalid. (shot:CONT.)	Since the time axis range is set to 20 to 200 ms/division by the recorder, and memory function and recording length are set to "CONT.," the printer cannot be turned on.

Appendix 2 Glossary

A/D	Conversion of an analog quantity into a digital quantity
Aliasing	Phantom signal components; a phenomenon that occurs if sampling frequency is low in relation to the frequency of the sampled signal (see Appendix 3.2).
Analog	Continuous physical quantity such as voltage or current
Attenuator	Device for reducing the level of a signal
Bit	Smallest unit of binary information
Byte	Unit of information. 1 byte is made up of 8 bits.
Channel (CH)	Input signal route
Chassis	Metal frame of the unit
Comment	Notations such as the recording paper and printable measurement conditions that can be entered by the user.
Common mode	Voltage between ground and measurement input line
Cutoff frequency	Point where the filter output amplitude is $1/\sqrt{2}$ of the input.
Digital	Discrete physical quantity
DIV (division)	Unit to indicate the measurement
Dynamic range	Ratio of maximum vs. minimum amplitude that can be displayed
FFT	Fast Fourier Transform For details, see Appendix 3.10
File	A collection of data on a medium such as tape
LED	Abbreviation of "light-emitting diode"
Logic-level	Waveform expressed as High and Low level
Logical formatting	Formatting that writes basic file structure information to the physically-formatted disks, making them compatible for use with the 8841/8842 system.
Low-pass filter	Filter that passes through only signals below a certain frequency
Memory	A device for storing digital data
MS-DOS	Personal computer operating system. MS-DOS is a registered trademark of Microsoft Corporation.
Offset	Amount of shift in relation to 0 V when scaling is used
Physical formatting	Preparatory formatting necessary before use of floppy disks.
Position	When referring to the position of the waveform along the measurement range on the display, this refers more precisely to the origin, that is the position corresponding to 0 V.
Pre-trigger	The condition of the signal before triggering occurred
Probe	Signal line for supplying the signal to the input
PT	Abbreviation of (voltage) "potential transformer"
Recording length	Total amount of sampling data expressed as number of increments
Reference junction compensation	When thermocouples are used, the temperature difference between the object and the measuring equipment terminal is measured. Reference junction compensation takes into account the terminal temperature so that the object temperature can be directly read.

Ripple component	AC component of noise
Sampling	Measuring an analog waveform at regular intervals
Sampling rate	Rate at which sampling carried out; sampling frequency
Scaling	Conversion of voltage value into a specified unit
Storage	Storing measurement data in the internal memory
Thermal head	Print head of thermal printer
Threshold value	When turning an analog signal into a logic signal, the level at which the measured value is divided between High and Low.
Trigger	An event that causes a certain action (such as starting or stopping a measurement) to happen.
Unbalanced input	Using a two-pole input in such a way that one pole carries the signal referenced to the other pole
Word	A unit for expressing digital data. The digital data for one input signal point after conversion.

Appendix 3 Reference

Appendix 3.1 Sampling

- The 8841/42 converts the input signal to a digital value, then carries out all internal processing digitally. This process of converting an analog signal to digital values is termed sampling.
- Sampling measures the magnitude of the signal at fixed time intervals (sampling periods).

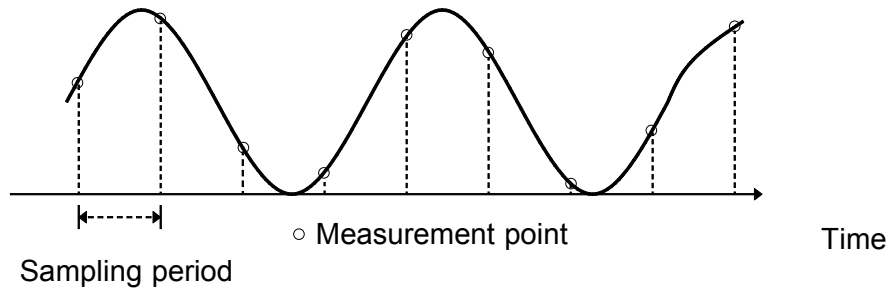

- The rate of taking these measurements is termed the sampling rate.
- The units are S/s, read as samples per second.
- This is the reciprocal of the sampling period ($1/T$).

Appendix 3.2 Aliasing

If the frequency of the signal being measured is significantly higher than the sampling rate, it is possible for sampling to produce an apparent signal which is actually nonexistent. This phenomenon is termed aliasing.

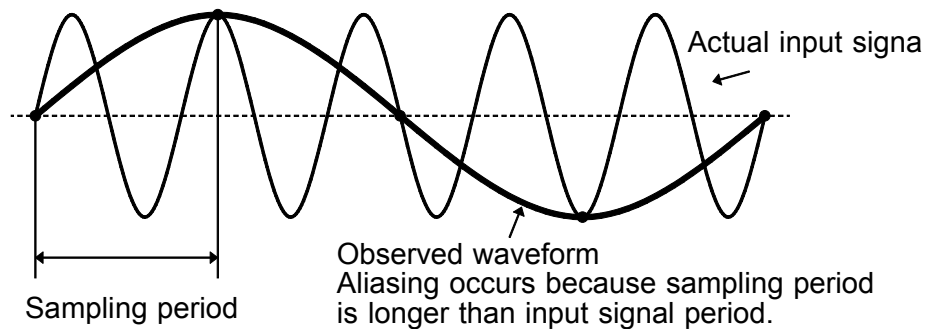

- When using the memory recorder function, because the sampling period for the time axis range may vary widely, care should be taken in setting the range not to produce aliasing.
- The measurement frequency limit is determined by the setting of the time axis range. In any event, it is always best to use the highest practicable sampling rate.
- When measuring a repeating signal, using the auto ranging function is another useful technique.

Appendix 3.3 Measurement Limit Frequency

- As a general rule, to ensure that sampling catches the peaks of a typical sine wave input on the display, more than 25 samples are required for each input cycle.
- The measurement limit frequency changes depending on the time axis range.

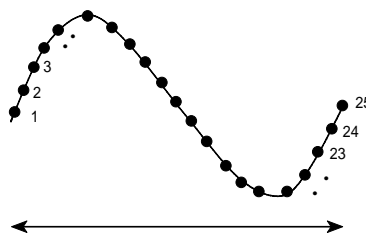

TIME/DIV (s/DIV)	Sampling period (s)	Measurement limit frequency (Hz)
100 μ	1 μ	40 k
200 μ	2 μ	20 k
500 μ	5 μ	8 k
1 m	10 μ	4 k
2 m	20 μ	2 k
5 m	50 μ	800
10 m	100 μ	400
20 m	200 μ	200
50 m	500 μ	80
100 m	1 m	40
200 ms	2 m	20
500 ms	5 m	8
1 s	10 m	4
2 s	20 m	2
5 s	50 m	0.8
10 s	100 m	0.4
30 s	300 m	0.13
1 min	600 m	0.067
2 min	1.2	0.033
5 min	3	0.013

Appendix 3.4 Recorder Function

- One division is equal to 100 samples.
- One piece of sample data collected using the recorder function contains the maximum and minimum voltage obtained in the set sampling period. Therefore, this data is of a certain width.

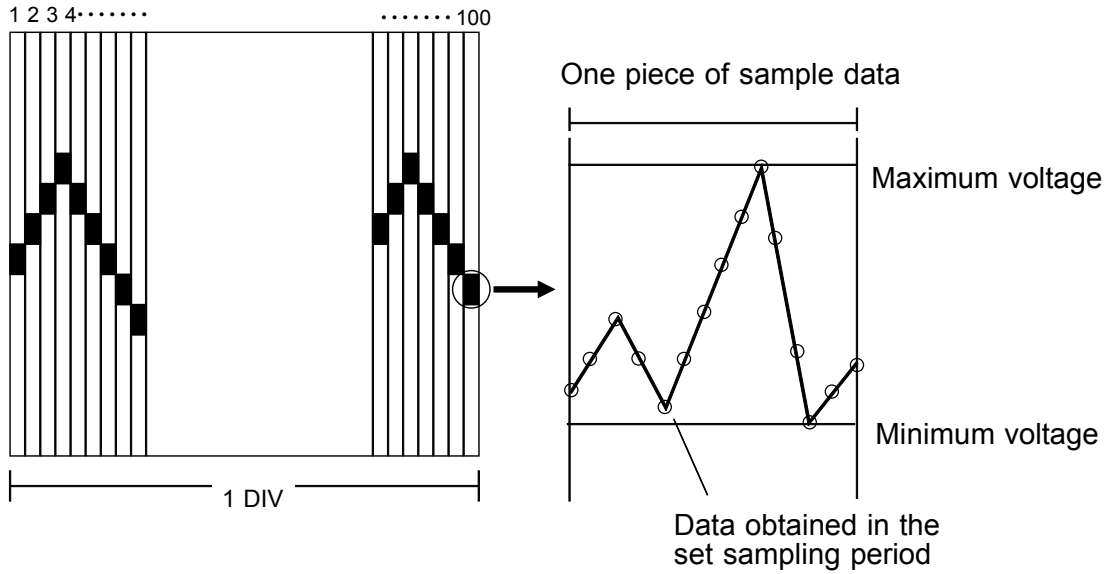

When a short sampling period is set and the input waveform changes slightly, a sudden disturbance such as noise will increase the difference between the maximum and minimum values. To eliminate this phenomenon, set a long sampling period.

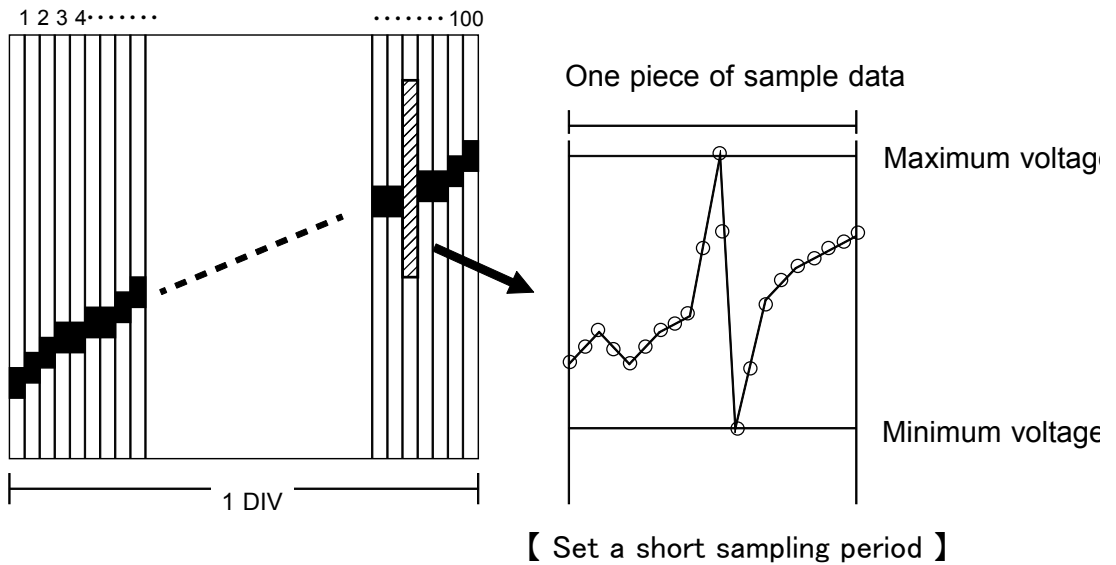

Appendix 3.5 RMS Recorder Function

- For the RMS recorder function, the sampling period is fixed to 20 RMS value data items per second.
- One division is equal to 100 samples.

Calculate one RMS value

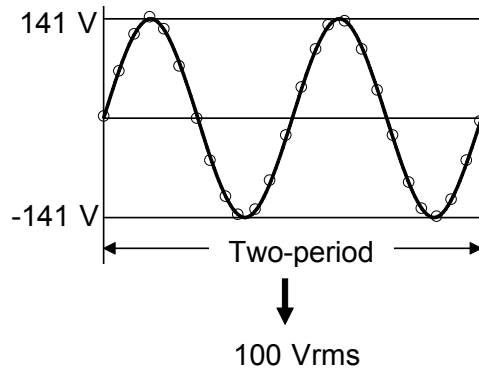

Sample the 50 Hz or 60 Hz waveforms :
200 μ s and calculate one RMS value ite
using two-period data.

[Two-period]
50 Hz: 40 ms 200 sampling data
60 Hz: 33.4 ms 167 sampling data

(1) Time axis: 5 s/division

Since the sampling period is fixed to 20 RMS-value data items per second, 5 s/division provides 100 RMS-value data items per division. This value is in agreement with 100 samples per division and, therefore, the voltage axis does not have a width (upper and lower limits).

(2) Time axis: other than 5 s/division

The maximum and minimum values are specified based on the RMS-value data (by multiplying 20 RMS-value data items per second by the time-axis range [s/division]/100), and the data containing these maximum and minimum values are defined as one item of sample data. When the time-axis range is set to 1 mm/division, the maximum and minimum values are specified in the RMS-value data (20×60 [s/division]/100 = 12), and the data containing these maximum and minimum values are defined as one item of sample data.

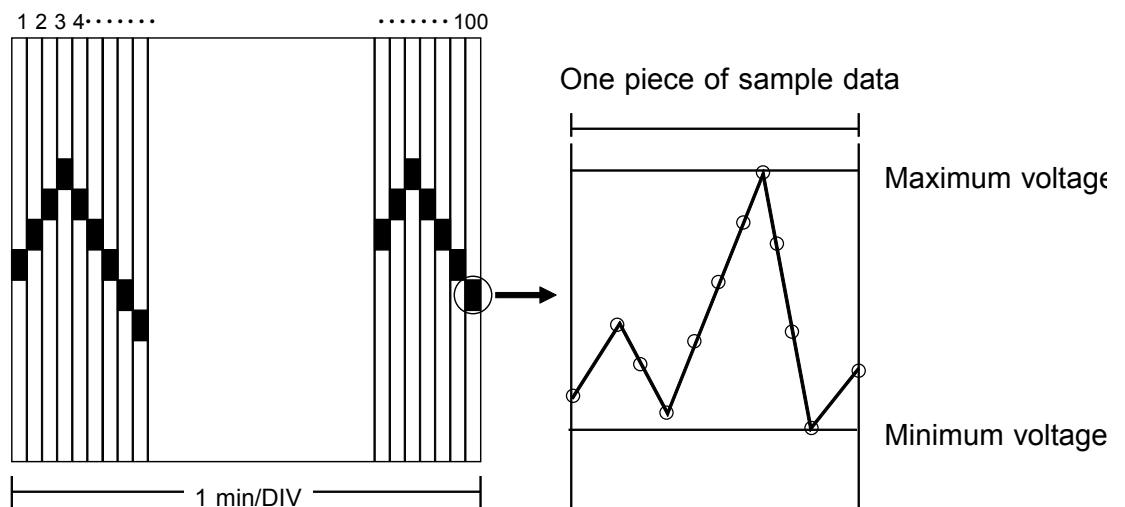

: RMS-value data (20×60 [s/division]/100 = 12)

Appendix 3.6 Averaging Equations

For time axis averaging in memory recorder and FFT functions, summing averaging is synchronized by the trigger.

If trigger synchronization is not performed, the results will be meaningless. In FFT function, unlike time axis averaging, results are valid also if no trigger synchronization is used. But if the characteristics of the input waveform allow triggering, using the trigger for synchronization is recommended.

Summing averaging (simple averaging in FFT)

Captured data are added sequentially and the sum is divided by the number of samples.

$$A_n = \{ (n - 1)A_{n-1} + Z_n \} / n$$

n Averaging count

A_n Result of n times averaging

Z_n n-th measurement data

Exponential averaging

Most recent data are given greatest weighting, and the weighting of older data is reduced with an exponential function.

$$A_n = \{ (N - 1)A_{n-1} + Z_n \} / N$$

N Specified averaging count

n Averaging count

A_n Result of n times averaging

Z_n n-th measurement data

Peak hold (frequency axis: FFT)

The specified number of samples are captured, and the peak value is held (stored) for each frequency.

Appendix 3.7 "2-point method" Scaling Equation

$$Y = \{(SCH - SCL)/(VH - VL)\} X + \{(VH \times SCL - VL \times SCH)/(VH - VL)\}$$

VH: Voltage high point SCH: Scaling high point

VL: Voltage low point SCL: Scaling low point

The ranges for the parts enclosed in dotted lines are as follows.

-9.9999E+9 { } value of enclosed part -1.0000E-9

-9.9999E+9 { } value of enclosed part = 0

+1.0000E-9 { } value of enclosed part +9.9999E+9

- When a setting outside of the above range is attempted, a warning indication is given and the setting becomes "converted value" = "voltage value" (no scaling).
- For channels in which waveform processing result data are recorded, only the unit is valid (scaling is invalid).
- The scaling value is used for the gauge scale, upper and lower display limits, and for A•B cursor readings.

Appendix 3.8 Waveform Parameter Calculation Details

(1) Average value

Calculates the average value (V) of the waveform data.

$$\text{AVE} = \frac{\sum_{i=1}^n d_i}{n}$$

AVE average value
n number of data samples
d_i i-th data of the source channel

(2) RMS value

Calculates the RMS (effective) value (V) of the waveform data. When scaling is used, the value is calculated after scaling.

$$\text{RMS} = \sqrt{\frac{\sum_{i=1}^n d_i^2}{n}}$$

RMS effective value
n number of data samples
d_i i-th data of the source channel

(3) Peak-to-peak value

Calculates the peak-to-peak (maximum-minimum) value of the waveform data.

(4) Maximum value

Calculates the maximum value of the waveform.

(5) Time to maximum value

- Calculates the time interval from the triggering point to the maximum value of the waveform (in seconds).
- If there are two maximum value points, the time to the first point is calculated.

(6) Minimum value

Calculates the minimum value of the waveform.

(7) Time to minimum value

- Calculates the time interval from the triggering point to the minimum value of the waveform (in seconds).
- If there are two minimum value points, the time to the first point is calculated.

(8) Period

(9) Frequency

- Displays the period (s) and frequency (Hz) of the signal waveform.
- The calculation is performed by determining the middle point of the signal amplitude and then measuring the interval from the point when that level is crossed (in rising or falling direction) to the point when it is next crossed.

(10) Rise time

(11) Fall time

- From the captured waveform data, the 0% and 100% level is determined, and the rise time (s) is taken as the time required to go from 10% to 90% (fall time: from 90% to 10%).
- In the captured waveform data, the first rising slope (or falling slope) is used to make the calculation.
- If the A•B cursors (vertical, trace) are used, the first rising slope (or falling slope) within the range defined by the cursors is used.

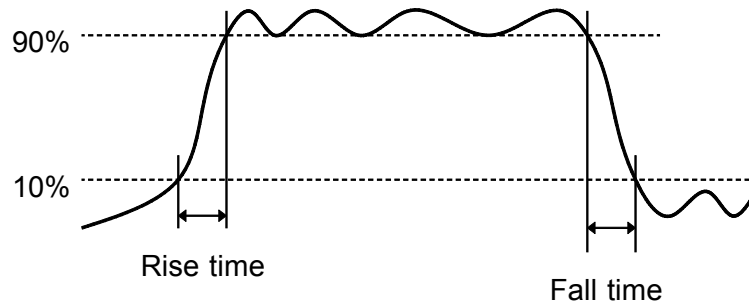

(12) Standard deviation

Calculates the standard deviation (V) of the waveform data.

$$= \sqrt{\sum_{i=1}^n (d_i - AVE)^2 / n}$$

- standard deviation
- AVE effective value
- n number of data samples
- d_i i-th data of the source channel

(13) Area value

- Calculates the area bordered by the signal waveform and the zero position (potential 0 V).
- If the A•B cursors (vertical, trace) are used, the area between the cursors is calculated.

$$S = \sum_{i=1}^n |d_i| \cdot h$$

- S Area value
- n number of data samples
- d_i i-th data of the source channel
- h = t sampling period

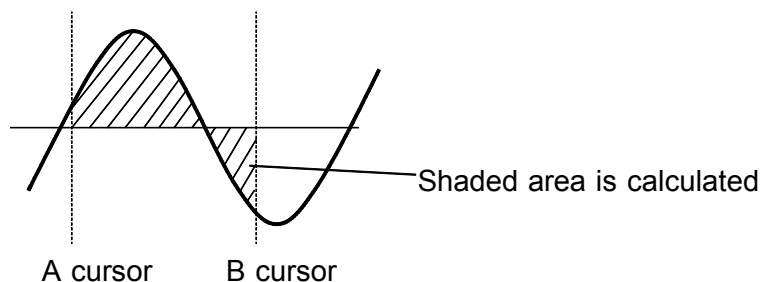

(14) X-Y area value

- Calculates the area (V^2) after X-Y plotting.
- The waveform is plotted on the X-Y screen, and the area enclosed by the plot lines is calculated.
- In single, dual, or quad screen, the A•B cursors (vertical, trace) can be used to specify the range (see Section 11.2.) for X-Y plotting and area calculation.
- On the X-Y screen of the memory recorder function, it is not possible to specify the range with the A•B cursors.

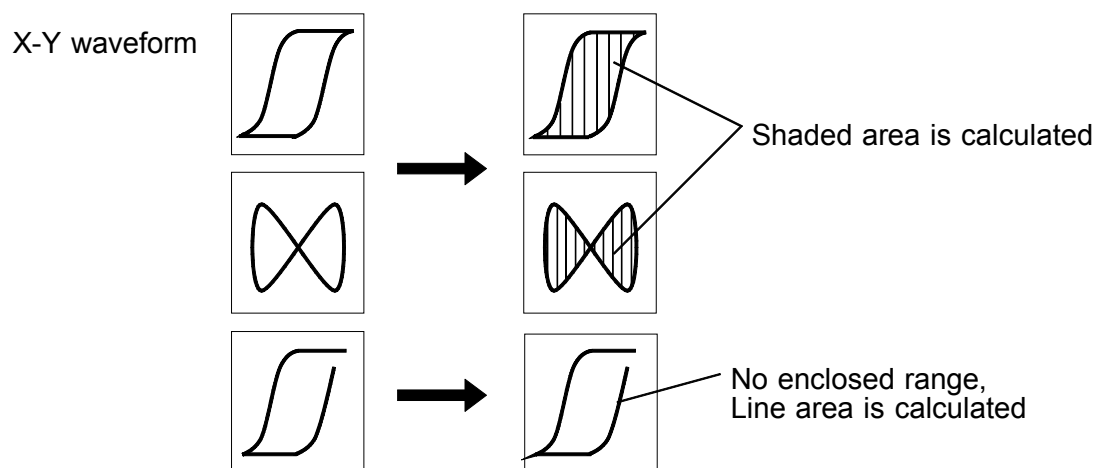
**NOTE**

- Depending on the signal waveform, values for parameters (8), (9), (10), and (11) may not be displayed.
- When the scaling function is used, scaling is first applied to waveform data, and then the parameters are calculated. The parameter unit is determined by the scaling unit (see Section 9.8).

Appendix 3.9 Details on Operators

This section describes the operators used in waveform operation. The parameter "bi" shows the operational result, and "di" shows the source channel, respectively, in which "i" indicates the serial number of data.

(1) The four arithmetical operations (+, -, *, /)

According to the operators set, the four arithmetical operations are performed.

(2) Absolute value (ABS)

$$b_i = |d_i| \quad (i = 1, 2, \dots, n)$$

(3) Exponential (EXP)

$$b_i = \exp(d_i) \quad (i = 1, 2, \dots, n)$$

(4) Common logarithm (LOG)

$$\text{When } d_i > 0, \quad b_i = \log_{10} d_i$$

$$\text{When } d_i = 0, \quad b_i = - \quad (\text{overflow value is output})$$

$$\text{When } d_i < 0, \quad b_i = \log_{10} |d_i| \quad (i = 1, 2, \dots, n)$$

Use the following equation to convert to natural logarithm:

$$\ln X = \log_e X = \log_{10} X / \log_{10} e$$

$$1 / \log_{10} e \quad 2.33E + 0$$

(5) Square root (SQR)

$$\text{When } d_i \geq 0, \quad b_i = \sqrt{d_i}$$

$$\text{When } d_i < 0, \quad b_i = - \sqrt{|d_i|} \quad (i = 1, 2, \dots, n)$$

(6) Moving average (MOV)

$$b_i = \frac{1}{k} \sum_{t=i-k/2}^{i+k/2} d_t \quad (i = 1, 2, \dots, n)$$

dt: t-th data of source channel

k: number of points for averaging (1 to 4000)

1 DIV = 100 points

(7) Parallel displacement on time axis (SLI)

Shifts the value on the time axis by a certain number of points.

$$b_i = d_{i-k} \quad (i = 1, 2, \dots, n)$$

k : number of points for averaging (-4000 to 4000)

After shifting the waveform, the part right or left without source channel data becomes 0 V. 1 DIV = 100 points

(8) Differentiation once (DIF)**(9) Differentiation twice (DIF2)**

- 1st and 2nd differential are calculated using the 5th-order Lagrange interpolation equation, whereby data from a range of five surrounding points are used to determine the value of the current point.
- Data corresponding to sample time $t_1 - t_n$ are taken as $d_1 - d_n$ and used for calculating the differential.

When the input voltage becomes small, processing results will show little variation. In such a case, apply the MOV operator.

1st differential

$$\text{Point } t_1 \ b_1 = (-25d_1 + 48d_2 - 36d_3 + 16d_4 - 3d_5)/12h$$

$$\text{Point } t_2 \ b_2 = (-3d_1 - 10d_2 + 18d_3 - 6d_4 + d_5)/12h$$

$$\text{Point } t_3 \ b_3 = (d_1 - 8d_2 + 8d_4 - d_5)/12h$$

↓

$$\text{Point } t_i \ b_i = (d_{i-2} - 8d_{i-1} + 8d_{i+1} - d_{i+2})/12h$$

↓

$$\text{Point } t_{n-2} \ b_{n-2} = (d_{n-4} - 8d_{n-3} + 8d_{n-1} - d_n)/12h$$

$$\text{Point } t_{n-1} \ b_{n-1} = (-d_{n-4} + 6d_{n-3} - 18d_{n-2} + 10d_{n-1} + 3d_n)/12h$$

$$\text{Point } t_n \ b_n = (3d_{n-4} - 16d_{n-3} + 36d_{n-2} - 48d_{n-1} + 25d_n)/12h$$

b_1 to b_n : data of calculation result

$h = t$: sampling period

2st differential

$$\text{Point } t_1 \ b_1 = (35d_1 - 104d_2 + 114d_3 - 56d_4 + 11d_5)/12h^2$$

$$\text{Point } t_2 \ b_2 = (11d_1 - 20d_2 + 6d_3 + 4d_4 - d_5)/12h^2$$

$$\text{Point } t_3 \ b_3 = (-d_1 + 16d_2 - 30d_3 + 16d_4 - d_5)/12h^2$$

↓

$$\text{Point } t_i \ b_i = (-d_{i-2} + 16d_{i-1} - 30d_i + 16d_{i+1} - d_{i+2})/12h^2$$

↓

$$\text{Point } t_{n-2} \ b_{n-2} = (-d_{n-4} + 16d_{n-3} - 30d_{n-2} + 16d_{n-1} - d_n)/12h^2$$

$$\text{Point } t_{n-1} \ b_{n-1} = (-d_{n-4} + 4d_{n-3} + 6d_{n-2} - 20d_{n-1} + 11d_n)/12h^2$$

$$\text{Point } t_n \ b_n = (11d_{n-4} - 56d_{n-3} + 114d_{n-2} - 104d_{n-1} + 35d_n)/12h^2$$

(10) 1st integral (INT)**(11) 2nd integral (INT2)**

- The 1st and 2nd integral calculation uses the trapezoidal rule.
- Data corresponding to sample time $t_1 - t_n$ are taken as $d_1 - d_n$ and used for calculating the integral.

1st integral

$$\text{Point } t_1 \ I_1 = 0$$

$$\text{Point } t_2 \ I_2 = (d_1 + d_2)h/2$$

$$\text{Point } t_3 \ I_3 = (d_1 + d_2)h/2 + (d_2 + d_3)h/2 = I_2 + (d_2 + d_3)h/2$$

$$\text{Point } t_n \ I_n = I_{n-1} + (d_{n-1} + d_n)h/2$$

I_1 to I_n : processing result data

$h = t$: sampling period

2st integral

$$\text{Point } t_1 \quad \Pi_1 = 0$$

$$\text{Point } t_2 \quad \Pi_2 = (I_1 + I_2)h/2$$

$$\text{Point } t_3 \quad \Pi_3 = (I_1 + I_2)h/2 + (I_2 + I_3)h/2 = \Pi_2 + (I_2 + I_3)h/2$$

$$\text{Point } t_n \quad \Pi_n = \Pi_{n-1} + (I_{n-1} + I_n)h/2$$

Π_1 to Π_n : processing result data

(12) Sine (SIN)

$$b_i = \sin(d_i) \quad (i = 1, 2, \dots, n)$$

(13) Cosine (COS)

$$b_i = \cos(d_i) \quad (i = 1, 2, \dots, n)$$

(14) Tangent (TAN)

$$b_i = \tan(d_i) \quad (i = 1, 2, \dots, n)$$

(15) Arc-sine (ASIN)

$$b_i = \sqrt{1 - d_i^2} \quad d_i > 1$$

$$b_i = \text{asin}(d_i) \quad -1 \leq d_i \leq 1$$

$$b_i = -\sqrt{1 - d_i^2} \quad d_i < -1$$

(16) Arc-cosine (ACOS)

$$b_i = 0 \quad d_i > 1$$

$$b_i = \text{acos}(d_i) \quad -1 \leq d_i \leq 1$$

$$b_i = \pi \quad d_i < -1 \quad (i = 1, 2, \dots, n)$$

(17) Arc-tangent (ATAN)

$$b_i = \text{atan}(d_i) \quad (i = 1, 2, \dots, n)$$

The unit for the Trigonometric and inverse trigonometric functions (12) - (17) is rad (radian).

Appendix 3.10 FFT Function

FFT stands for Fast Fourier Transformation, which is a calculation method used to decompose a time-domain waveform into frequency components. By performing FFT calculation, various calculations can be performed.

■ Concept of time domain and frequency domain

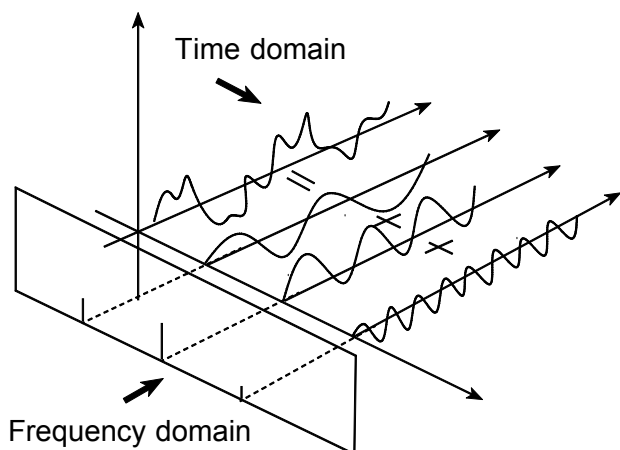

The signals measured by this memory recorder have values which correspond to time, that is the signals are functions of time.

Waveform in the figure on the left is an example of such a signal.

Signals which are expressed as a function of time are called time domain signals.

In reality, a signal consists of a number of sine-waves of different frequencies, called frequency components, which combine to create the final shape of the waveform. Expressing waveform the source signal, as a function of its frequency components yields a frequency domain representation.

Often, the characteristics of a signal which cannot be easily analyzed in the time domain, can be clearly revealed by the frequency domain representation.

■ Fourier transformation and the Inverse Fourier transformation

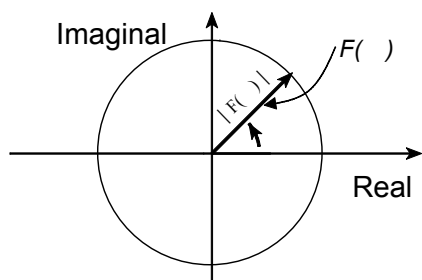

The following equations define the Fourier transformation and the Inverse Fourier transformation.

$$F(\omega) = \mathcal{F}\{f(t)\} = \int_{-\infty}^{+\infty} f(t) \cdot \exp(-j\omega t) dt \quad \mathbf{2}$$

$$f(t) = \mathcal{F}^{-1}\{F(\omega)\} = \frac{1}{2\pi} \int_{-\infty}^{+\infty} F(\omega) \cdot \exp(j\omega t) d\omega \quad \mathbf{3}$$

The function $F(\omega)$ generally results in a complex number, and can be expressed as follows.

$$F(\omega) = |F(\omega)| \cdot \exp(j\phi(\omega)) = |F(\omega)| \cdot \phi(\omega) \quad \mathbf{4}$$

$|F(\omega)|$: Absolute value spectrum of $f(t)$

$\phi(\omega)$: Unit spectrum of the phase of $f(t)$

When conversion is made from the time domain to the frequency domain, the magnitude information and phase information are clearly expressed as indicated in equation (4). The figure below shows $F(\omega)$ in vector form.

■ Application of Fourier transform (transfer function, unit-impulse response)

As an application of Fourier transform, this section describes a steady-state response in a static linear system.

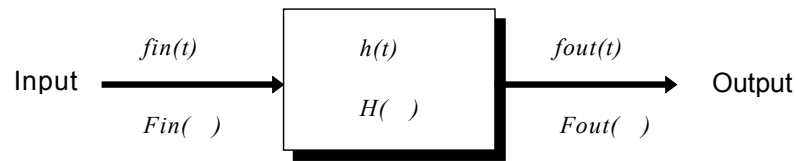

$f_{in}(t)$: time function of input (source signal)

$f_{out}(t)$: time function of output (response function)

$h(t)$: unit impulse response of linear system

t , : time

$$f_{out}(t) = \int_{-\infty}^{+\infty} f_{in}(\tau) \cdot h(t-\tau) d\tau \quad 5$$

The relationship between the input and output is expressed as follows:

This indicates that the response of the linear system can be determined just by knowing the unit impulse response $h(t)$ of the system.

In the frequency domain, $F_{in}(\omega)$, $F_{out}(\omega)$, $H(\omega)$, and ω are defined as follows

$F_{in}(\omega)$: Fourier transformation of $f_{in}(t)$

$F_{out}(\omega)$: Fourier transformation of $f_{out}(t)$

$H(\omega)$: Fourier transformation of $h(t)$

ω : Angular frequency

$$F_{out}(\omega) = F_{in}(\omega) \cdot H(\omega) \quad 6$$

Therefore, when $f_{in}(t)$ and $f_{out}(t)$ are measured, the system transfer function $H(\omega)$ and the unit impulse response $h(t)$ can be obtained by performing an FFT operation and an inverse FFT operation.

■ Aliasing

When the frequency of the signal to be measured approaches the sampling frequency, beyond a certain point the measured signal frequency will be lower than the actual signal frequency. In such a case, frequency components that do not exist will appear in the waveform along the frequency axis. This phenomenon is called aliasing, and it occurs if sampling is carried out at a frequency lower than the so-called Nyquist frequency determined by Nyquist's sampling theorem.

Sampling theorem

$$F_s = 2 \cdot F_{max} \quad 1$$

F_{max} : Highest frequency component to be measured

F_s : Sampling frequency (Nyquist frequency)

- In order to be able to restore the original waveform from the sampling data, the sampling frequency must be at least twice as high as the signal frequency.
- If sampling is carried out at a frequency lower than the Nyquist frequency, frequency components above 1/2 of the sampling frequency will be aliased to lower frequencies, and the measured signal will appear to contain frequency components that actually do not exist.

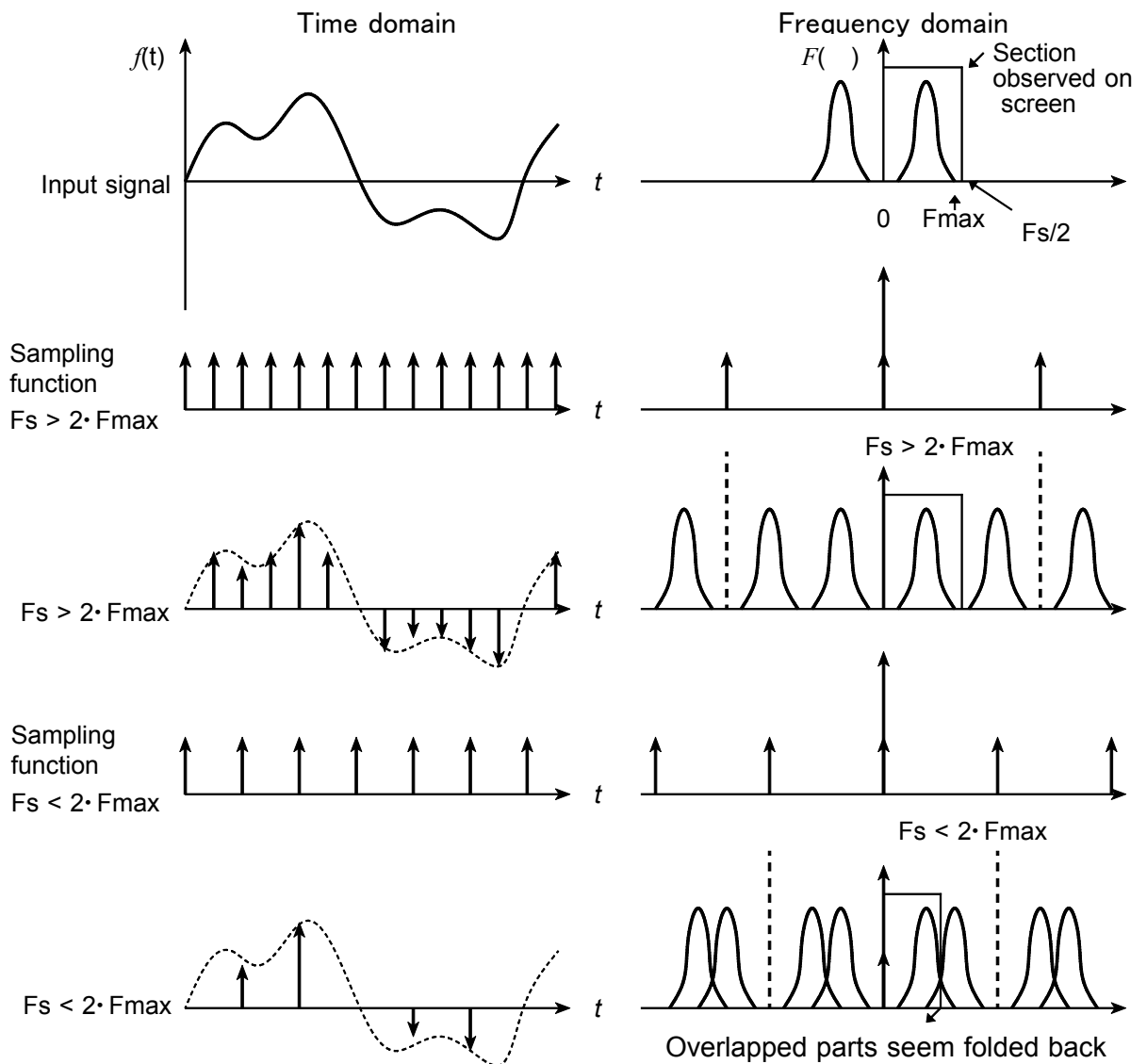

■ Anti-aliasing filter

- In FFT processing, when the frequency bandwidth of the input signal is unlimited, frequency spectrum components that do not exist will appear, due to aliasing. To prevent this, a low-pass filter is required which cuts off the input waveform at 1/2 of the sampling frequency. Such a low-pass filter is called an anti-aliasing filter.
- The input unit incorporates an anti-aliasing filter and therefore allows the 8841/42 to perform FFT analysis without being subject to aliasing.

When an anti-aliasing filter is not used.

G1:LIN y: LOG-MAG x: LOG-Hz w1: CH1
+10dB

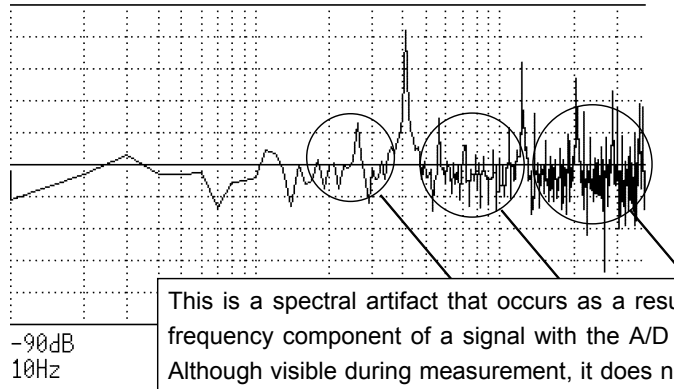

G1:STR y:(Linear) x: (Time) w1: CH1
+2.5000V

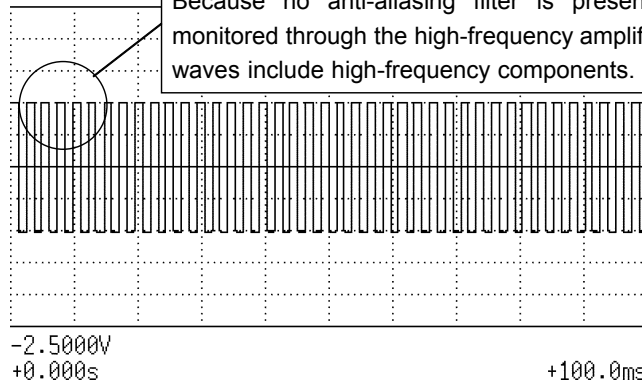

When an anti-aliasing filter is used.

G1:LIN y: LOG-MAG x: LOG-Hz w1: CH1
+10dB

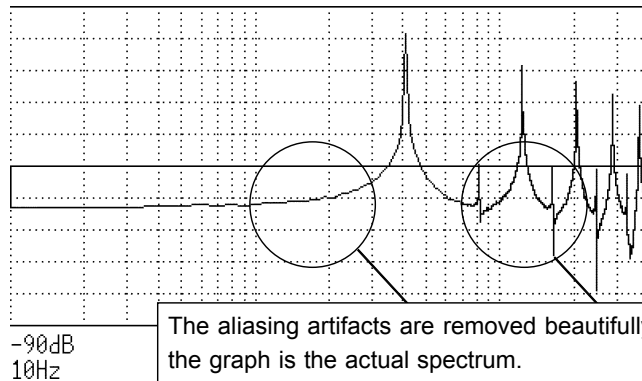

G1:STR y:(Linear) x: (Time) w1: CH1
+2.5000V

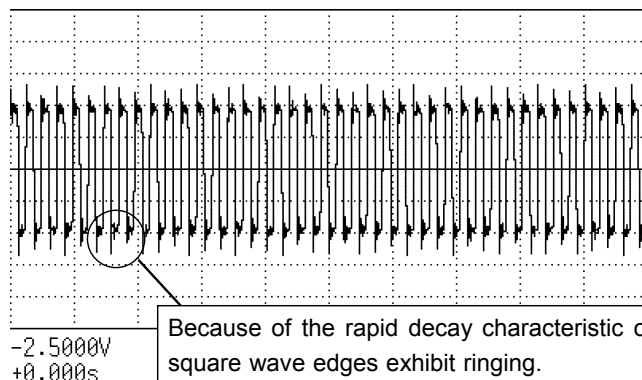

■ Window processing

Fourier transform is defined as the integration from negative infinity to positive infinity, but in actual measurement this calculation is not possible. Therefore only a limited segment of the continuous signal is taken for processing. This is called window processing.

The FFT algorithm assumes that the data of that limited segment are repeated and defines the input signal using a periodic function for determining the frequency spectrum.

Depending on the phase at the start and end of the stored waveform, there may be a difference between the waveform as calculated by FFT processing and the actual input waveform.

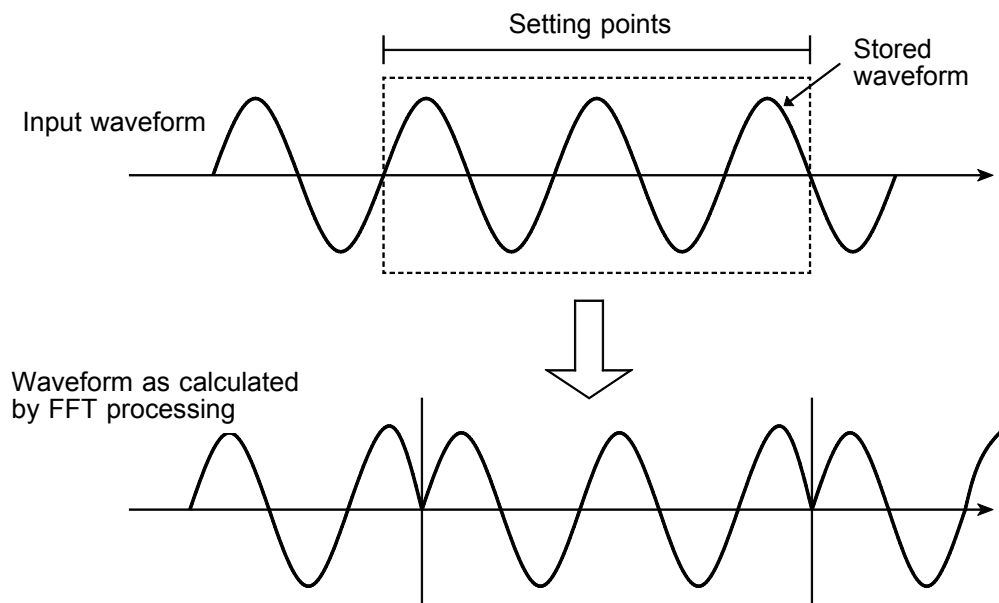

■ Leakage error

When the signal waveform as assumed by the FFT algorithm and the actual waveform are different, the processing result will contain an error. This error is called the leakage error.

■ Window function

- When a limited segment of the input signal is captured, a function can be applied to reduce the leakage error.
- This function is called the window function.
- To minimize the leakage error, a suitable window should be chosen which matches the type of input signal.
- Possible window types include rectangular, Hanning, exponential, flat-top, minimum, force, etc. In the 8841/42, three window functions (rectangular, Hanning, exponential) are available.
- Generally, the rectangular window function is most useful for single waveforms, the Hanning window function for continuous waveforms, and the exponential window function for attenuated waveforms.

Rectangular window

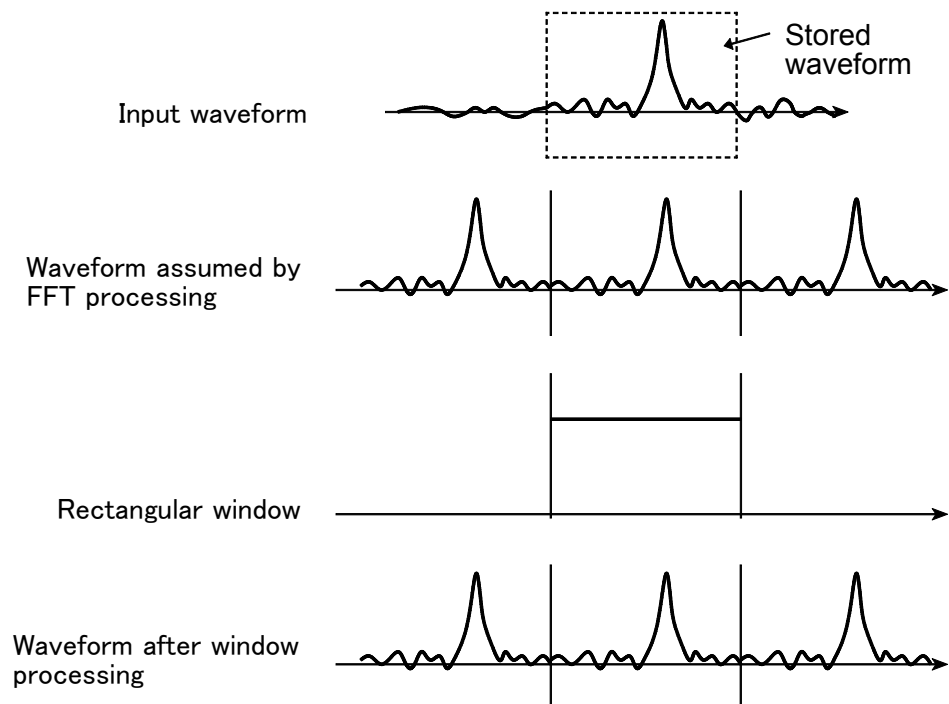

Hanning window

Input waveform

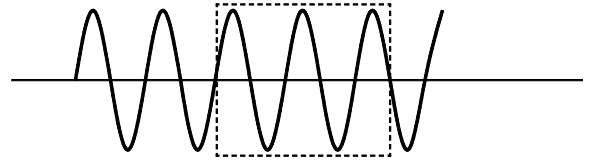
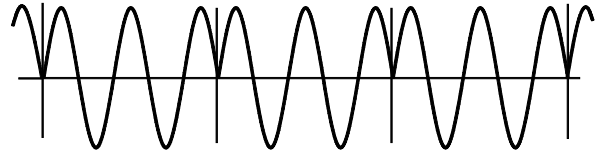
Waveform assumed by
FFT processing

Hanning window

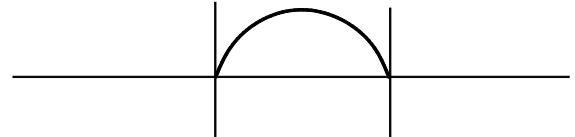
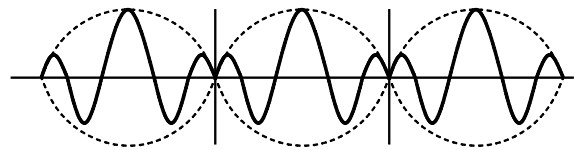
Waveform after window
processing**Exponential window**

Input waveform

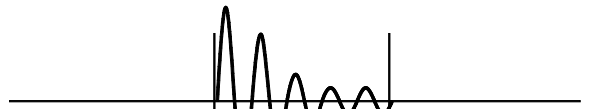
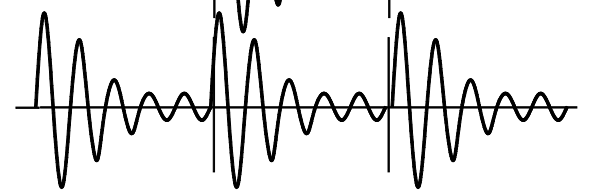
Waveform assumed by
FFT processing

Exponential window

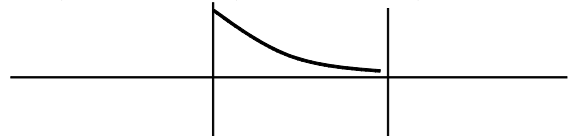
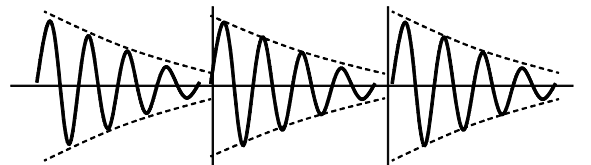
Waveform after window
processing

Appendix 4 Size of a Waveform File (Binary data)

■ In the memory recorder function (Binary data)

Size of a file = header + data

Size of a header = $512 \times \{3 + \text{number of analog channels to be saved} + 3 \times (\text{number of analog channels} + 7) / 8 + \text{number of logic channels to be saved}\}$

Size of a data = $(2 \times \text{number of analog channels to be saved} + (\text{number of logic channels to be saved} + 1) / 2) \times (\text{recording length [DIV]} \times 100 + 1)$

NOTE: Truncates the decimal portion of the quotient of division.

Unit: Byte : 8 M words (standard) : 32 M words (expansio

Number of logic probes: 0

Recording length	Number of analog channels				
	0	2	4	8	16
25		15,636	26,664	48,720	92,832
50		25,636	46,664	88,720	172,832
100		45,636	86,664	168,720	332,832
200		85,636	166,664	328,720	652,832
500		205,636	406,664	808,720	1,612,832
1000		405,636	806,664	1,608,720	3,212,832
2000		805,636	1,606,664	3,208,720	6,412,832
5000		2,005,636	4,006,664	8,008,720	16,012,832
10000		4,005,636	8,006,664	16,008,720	32,012,832
20000		8,005,636	16,006,664	32,008,720	64,012,832
40000		16,005,636	32,006,664	64,008,720	
80000		32,005,636	64,006,664		
160000		64,005,636			

Number of logic probes: 2

Recording length	Number of analog channels				
	0	2	4	8	16
25	8,133	19,161	30,189	52,245	96,357
50	10,633	31,661	52,689	94,745	178,857
100	15,633	56,661	97,689	179,745	343,857
200	25,633	106,661	187,689	349,745	673,857
500	55,633	256,661	457,689	859,745	1,663,857
1000	105,633	506,661	907,689	1,709,745	3,313,857
2000	205,633	1,006,661	1,807,689	3,409,745	6,613,857
5000	505,633	2,506,661	4,507,689	8,509,745	16,513,857
10000	1,005,633	5,006,661	9,007,689	17,009,745	33,013,857
20000	2,005,633	10,006,661	18,007,689	34,009,745	66,013,857
40000	4,005,633	20,006,661	36,007,689	68,009,745	
80000	8,005,633	40,006,661	72,007,689		
160000	16,005,633	80,006,661			

Number of logic probes: 4

Recording length	Number of analog channels				
	0	2	4	8	16
25	11,658	22,686	33,714	55,770	99,882
50	16,658	37,686	58,714	100,770	184,882
100	26,658	67,686	108,714	190,770	354,882
200	46,658	127,686	208,714	370,770	694,882
500	106,658	307,686	508,714	910,770	1,714,882
1000	206,658	607,686	1,008,714	1,810,770	3,414,882
2000	406,658	1,207,686	2,008,714	3,610,770	6,814,882
5000	1,006,658	3,007,686	5,008,714	9,010,770	17,014,882
10000	2,006,658	6,007,686	10,008,714	18,010,770	34,014,882
20000	4,006,658	12,007,686	20,008,714	36,010,770	68,014,882
40000	8,006,658	24,007,686	40,008,714	72,010,770	
80000	16,006,658	48,007,686	80,008,714		

■ In the recorder and RMS recorder functions (Binary data)

Size of a file = header + data

Size of a header = $512 \times \{3 + \text{number of analog channels to be saved} + 3 \times (\text{number of analog channels} + 7) / 8 + \text{number of logic channels to be saved}\}$

Size of a data = $(4 \times \text{number of analog channels to be saved} + \text{number of logic channels to be saved}) \times (\text{recording length}[\text{DIV}] \times 100 + 1)$

NOTE: Truncates the decimal portion of the quotient of division.

Unit: Byte : 8 M words (standard) : 32 M words (expansio

Number of logic probes: 0

Recording length	Number of analog channels				
	0	2	4	8	16
25		25,640	46,672	88,736	172,864
50		45,640	86,672	168,736	332,864
100		85,640	166,672	328,736	652,864
200		165,640	326,672	648,736	1,292,864
500		405,640	806,672	1,608,736	3,212,864
1000		805,640	1,606,672	3,208,736	6,412,864
2000		1,605,640	3,206,672	6,408,736	12,812,864
5000		4,005,640	8,006,672	16,008,736	32,012,864
10000		8,005,640	16,006,672	32,008,736	64,012,864

Number of logic probes: 2

Recording length	Number of analog channels				
	0	2	4	8	16
25	10,634	31,666	52,698	94,762	178,890
50	15,634	56,666	97,698	179,762	343,890
100	25,634	106,666	187,698	349,762	673,890
200	45,634	206,666	367,698	689,762	1,333,890
500	105,634	506,666	907,698	1,709,762	3,313,890
1000	205,634	1,006,666	1,807,698	3,409,762	6,613,890
2000	405,634	2,006,666	3,607,698	6,809,762	13,213,890
5000	1,005,634	5,006,666	9,007,698	17,009,762	33,013,890
10000	2,005,634	10,006,666	18,007,698	34,009,762	66,013,890

Number of logic probes: 4

Recording length	Number of analog channels				
	0	2	4	8	16
25	16,660	37,692	58,724	100,788	184,916
50	26,660	67,692	108,724	190,788	354,916
100	46,660	127,692	208,724	370,788	694,916
200	86,660	247,692	408,724	730,788	1,374,916
500	206,660	607,692	1,008,724	1,810,788	3,414,916
1000	406,660	1,207,692	2,008,724	3,610,788	6,814,916
2000	806,660	2,407,692	4,008,724	7,210,788	13,614,916
5000	2,006,660	6,007,692	10,008,724	18,010,788	34,014,916
10000	4,006,660	12,007,692	20,008,724	36,010,788	68,014,916

NOTE

Values are for Ver. 2.4, and may vary according to version.

Appendix 5 Size of a Waveform File (Reference value of text data)

■ In the memory recorder function (text data) (Reference value)

Size of a file = header + data

Size of a header = 170+27 × number of analog channels+64 × number of logic probes

Size of a data = (14+13 × number of analog channels+9 × number of logic probes) × (recording length[DIV] × 100+1) (Truncates the decimal portion of the quotient of division.)

Unit: Byte : 8 M words (standard) : 32 M words (expansio

Number of logic probes: 0

Recording length	Number of analog channels				
	0	2	4	8	16
25		105,266	170,346	300,506	560,826
50		210,266	340,346	600,506	1,120,826
100		420,266	680,346	1,200,506	2,240,826
200		840,266	1,360,346	2,400,506	4,480,826
500		2,100,266	3,400,346	6,000,506	11,200,826
1000		4,200,266	6,800,346	12,000,506	22,400,826
2000		8,400,266	13,600,346	24,000,506	44,800,826
5000		21,000,266	34,000,346	60,000,506	112,000,826
10000		42,000,266	68,000,346	120,000,506	224,000,826
20000		84,000,266	136,000,346	240,000,506	448,000,826
40000		168,000,266	272,000,346	480,000,506	
80000		336,000,266	544,000,346		
160000		672,000,266			

Number of logic probes: 2

Recording length	Number of analog channels				
	0	2	4	8	16
25	85,332	150,412	215,492	345,652	605,972
50	170,332	300,412	430,492	690,652	1,210,972
100	340,332	600,412	860,492	1,380,652	2,420,972
200	680,332	1,200,412	1,720,492	2,760,652	4,840,972
500	1,700,332	3,000,412	4,300,492	6,900,652	12,100,972
1000	3,400,332	6,000,412	8,600,492	13,800,652	24,200,972
2000	6,800,332	12,000,412	17,200,492	27,600,652	48,400,972
5000	17,000,332	30,000,412	43,000,492	69,000,652	121,000,972
10000	34,000,332	60,000,412	86,000,492	138,000,652	242,000,972
20000	68,000,332	120,000,412	172,000,492	276,000,652	484,000,972
40000	136,000,332	240,000,412	344,000,492	552,000,652	
80000	272,000,332	480,000,412	688,000,492		
160000	544,000,332	960,000,412			

Number of logic probes: 4

Recording length	Number of analog channels				
	0	2	4	8	16
25	130,478	195,558	260,638	390,798	651,118
50	260,478	390,558	520,638	780,798	1,301,118
100	520,478	780,558	1,040,638	1,560,798	2,601,118
200	1,040,478	1,560,558	2,080,638	3,120,798	5,201,118
500	2,600,478	3,900,558	5,200,638	7,800,798	13,001,118
1000	5,200,478	7,800,558	10,400,638	15,600,798	26,001,118
2000	10,400,478	15,600,558	20,800,638	31,200,798	52,001,118
5000	26,000,478	39,000,558	52,000,638	78,000,798	130,001,118
10000	52,000,478	78,000,558	104,000,638	156,000,798	260,001,118
20000	104,000,478	156,000,558	208,000,638	312,000,798	520,001,118
40000	208,000,478	312,000,558	416,000,638	624,000,798	
80000	416,000,478	624,000,558	832,000,638		
160000	832,000,478	1,248,000,558			

■ In the Recorder and RMS recorder functions (text data) (bytes)

Size of a file = header + data

Size of a header = 170 + 64 × number of analog channels + 165 × number of logic probes

Size of a data = (14+26 × number of analog channels+18 × number of logic probes) × (recording length[DIV] × 100+1) (Truncates the decimal portion of the quotient of division.)

Unit: Byte : 8 M words (standard) : 32 M words (expansio

Number of logic probes: 0

Recording length	Number of analog channels				
	0	2	4	8	16
25		170,366	300,546	560,906	1,081,626
50		340,366	600,546	1,120,906	2,161,626
100		680,366	1,200,546	2,240,906	4,321,626
200		1,360,366	2,400,546	4,480,906	8,641,626
500		3,400,366	6,000,546	11,200,906	21,601,626
1000		6,800,366	12,000,546	22,400,906	43,201,626
2000		13,600,366	24,000,546	44,800,906	86,401,626
5000		34,000,366	60,000,546	112,000,906	216,001,626
10000		68,000,366	120,000,546	224,000,906	432,001,626

Number of logic probes: 2

Recording length	Number of analog channels				
	0	2	4	8	16
25	130,552	260,732	390,912	651,272	1,171,992
50	260,552	520,732	780,912	1,301,272	2,341,992
100	520,552	1,040,732	1,560,912	2,601,272	4,681,992
200	1,040,552	2,080,732	3,120,912	5,201,272	9,361,992
500	2,600,552	5,200,732	7,800,912	13,001,272	23,401,992
1000	5,200,552	10,400,732	15,600,912	26,001,272	46,801,992
2000	10,400,552	20,800,732	31,200,912	52,001,272	93,601,992
5000	26,000,552	52,000,732	78,000,912	130,001,272	234,001,992
10000	52,000,552	104,000,732	156,000,912	260,001,272	468,001,992

Number of logic probes: 4

Recording length	Number of analog channels				
	0	2	4	8	16
25	220,918	351,098	481,278	741,638	1,262,358
50	440,918	701,098	961,278	1,481,638	2,522,358
100	880,918	1,401,098	1,921,278	2,961,638	5,042,358
200	1,760,918	2,801,098	3,841,278	5,921,638	10,082,358
500	4,400,918	7,001,098	9,601,278	14,801,638	25,202,358
1000	8,800,918	14,001,098	19,201,278	29,601,638	50,402,358
2000	17,600,918	28,001,098	38,401,278	59,201,638	100,802,358
5000	44,000,918	70,001,098	96,001,278	148,001,638	252,002,358
10000	88,000,918	140,001,098	192,001,278	296,001,638	504,002,358

Appendix 6 FFT File Size

Binary Data Size

Unit: Byte

Number of points	Average: OFF		Average: ON	
	1 ch FFT	2 ch FFT*	1 ch FFT	2 ch FFT*
1000	15,632	26,144	17,636	40,156
2000	25,632	46,144	29,636	74,156
5000	55,632	106,144	65,636	176,156
10000	106,532	206,144	17,636	346,156

Note: With 2-channel FFT, if the signal at channels 1 and 2 is the same, the size is reduced by 512 bytes.

Text data size (text data size is the objective)

Single-screen size. For the 2-screen case, add the graph size of each.

Unit: Byte

Number of points	Analysis mode			
	STR, ACR, CCR, IMP	LIN, RMS, PSP, HIS, TRF, CSP, CHO	OCT(1/1)	OCT(1/3)
1000	27,190	11,017	320	580
2000	54,190	21,817		
5000	135,190	54,217		
10000	270,190	108,217		

Appendix 7 Real-Time Save Files Size (Memory data)

Size of a file = header + data

Size of a header = $512 \times (9 + \text{number of analog channels} + \text{number of logic probes})$

Size of a data = $2 \times \text{number of analog channels} \times (\text{recording length (DIV)} \times 100 + 1)$

- Saved channel number: When saving channels, each analog channel (up to 8) has a corresponding logic channel, and such pairs are regarded as single channels. (Example: Saving analog channels 1 and 2 also saves logic channels A and B, constituting a saved channel number of 2.)

Relationship between saving analog and logic channels:

CH1, CHA	CH2, CHB	CH3, CHC	CH4, CHD
Analog channels 5 through 16 have no corresponding logic channels.			

Recording length	Number of analog channels (Number of logic channels: 0)			
	0	4	8	16
25		27 KB	48 KB	91 KB
50		46 KB	87 KB	169 KB
100		85 KB	165 KB	326 KB
200		163 KB	322 KB	638 KB
1000		788 KB	1572 KB	4 MB
2000		1570 KB	4 MB	7 MB
5000		4 MB	8 MB	16 MB
10,000		8 MB	16 MB	31 MB
20,000		16 MB	31 MB	62 MB
40,000		31 MB	62 MB	123 MB
80,000		62 MB	123 MB	245 MB
160,000		123 MB	245 MB	489 MB

Recording length	Number of analog channels (Number of logic channels: 4)			
	0	4	8	16
25	29 KB	50 KB	72 KB	93 KB
50	48 KB	89 KB	130 KB	171 KB
100	87 KB	167 KB	247 KB	328 KB
200	165 KB	324 KB	482 KB	640 KB
1000	790 KB	1574 KB	3 MB	4 MB
2000	1572 KB	4 MB	5 MB	7 MB
5000	4 MB	8 MB	12 MB	16 MB
10,000	8 MB	16 MB	23 MB	31 MB
20,000	16 MB	31 MB	46 MB	62 MB
40,000	31 MB	62 MB	92 MB	123 MB
80,000	62 MB	123 MB	184 MB	245 MB
160,000	123 MB	245 MB	367 MB	489 MB

Regarding saving of 4 or 8 analog channels in the above table, file sizes are calculated for the case in which the analog channels have no corresponding logic channels.

Example: When saving four analog channels: analog channels 5, 6, 7 and 8, and logic channels A through D are saved.

Appendix 8 Waveform Viewer (Wv)

The waveform viewer provides a simplified view of data transferred to a PC by remote control or data acquisition. The viewer has a CSV conversion function. Converted files may be read by a spreadsheet program.

System requirements

For a PC running Windows 95, 98, Me, Windows NT4.0 SP3 or later, Windows 2000, or Windows XP

Installation

Install by the following procedure:

1. When you insert the Application Disk (CD-R) into the CD-ROM drive, the opening page should appear automatically. If it does not appear, open the "index.htm" file with your Web browser.
2. Select the language to display (click the English icon).
3. Click the [Wave viewer (Wv)] icon to view Wv specifications and revision history.
4. Click the [Install] icon at the top right of the page to open the [File Download] dialog.
5. Click [Open] to display the confirmation dialog to proceed with installation.
6. Click [Next] to open the installation destination selection window. Click the [Browse] button to change the installation folder.
7. Click [Next] to start installation.
The program is now installed.

Appendix 8.1 Starting the Waveform Viewer

In the Windows Start menu, select [Programs] - [HIOKI] - [Wv]. This starts the waveform viewer application.

To close the waveform viewer application, in the [File] menu select [Exit]. You can also click the Close button at the top right corner of the window.

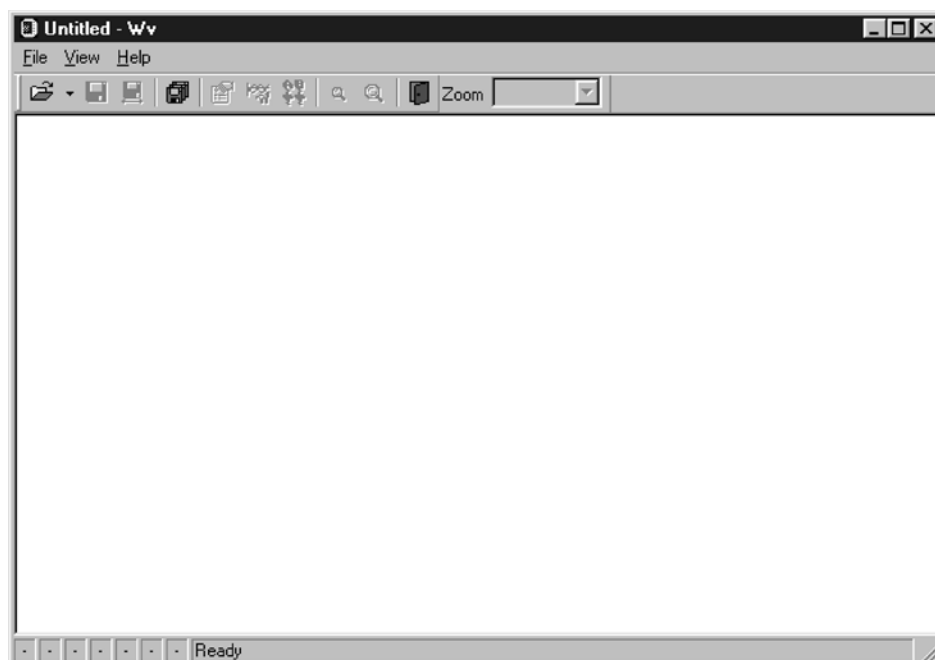

- **Toolbar**

Click the icons in the toolbar for the respective functions.

From the left, these are: [Open], [Save All], [Save Between Cursors], [Batch Conversion], [Properties], [Wave Control Panel], [Trace], [Zoom Out], [Zoom In], and [Exit].

For details of these operations, see the descriptions of the corresponding menu items.

You can also select the magnification factor for the time axis by selecting on the toolbar.

- **Status bar**

The status bar shows, from the left, the model name, function, recording length, time axis, trigger time, pre-trigger and judgment result.

- **Version information**

When making inquiries, the version number will be required.

To check the software version number, in the [Help] menu select [About Wv].

Appendix 8.2 Waveform Viewer Menus

The following is the complete menu tree of the waveform viewer application.

File	Open	
	Save All	
	Save Between Cursors	
	Batch Conversion	
	Exit	
View	Toolbar	
	Status Bar	
	Wave Control Panel	
	Properties	
	Trace	
	Block List	
	Zoom In	
	Zoom Out	
	Set Magnification	
	Jump	Trig A Cursor B Cursor
	Time Notation	DIV Sec Point Trig Date
	Grid Type	None Standard Fine
	Title	
	Remarks	
	Fixed	
Capture		

Right-click with the mouse in the waveform display screen for the following functions.

Right-click with the mouse	Wave Control Panel		
	Properties		
	Trace		
	Block List		
	Zoom In		
	Zoom Out		
	Set Magnification		
	Jump	Trig	
		A Cursor	
		B Cursor	
	Time Notation	DIV	
		Sec	
		Point	
		Trig	
		Date	
	Grid Type	None	
		Standard	
		Detail	
	Title		
	Remarks		
	Fixed		
	Color	Text	
		Background	
Grid			
Font			
Capture			

Appendix 8.3 Using the Waveform Viewer

• Waveform display

To display a waveform it is first necessary to select the file to be displayed. In the [File] menu, select [Open], to display the file selection dialog box. Select a waveform file, and click Open to read in the file, and display the waveform.

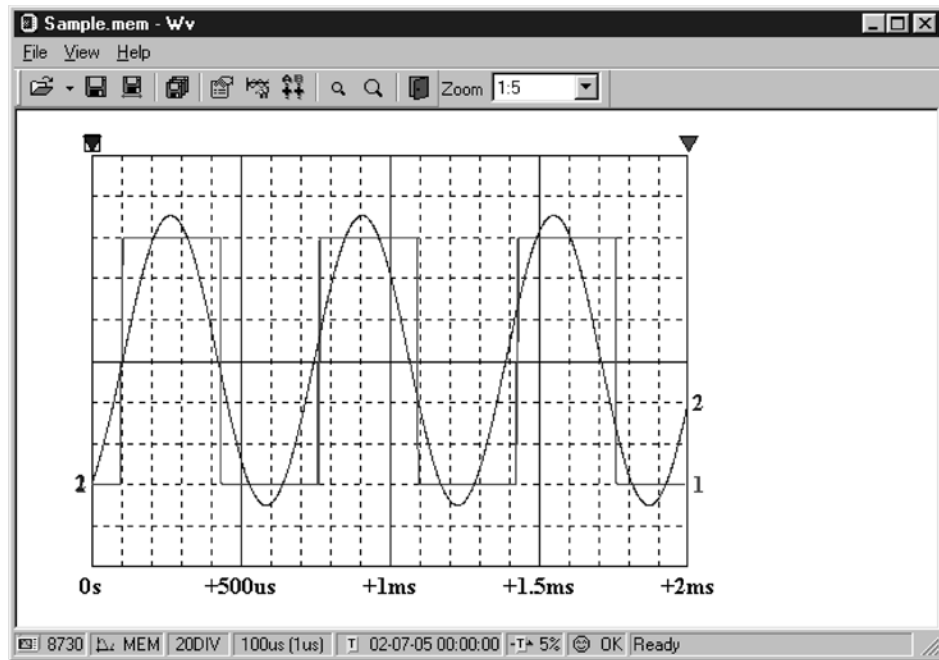

• Changing the time axis scale (zoom function)

You can change the time axis scale in the display using the menus or toolbar.

In the toolbar, click the [Set Magnification] box, to display the possible zoom factors: you can then select any desired value.

- **Changing waveform scale and position (Waveform Control Panel)**

You can adjust the display for each channel separately. In the [View] menu, select [Wave Control Panel] to display a dialog box.

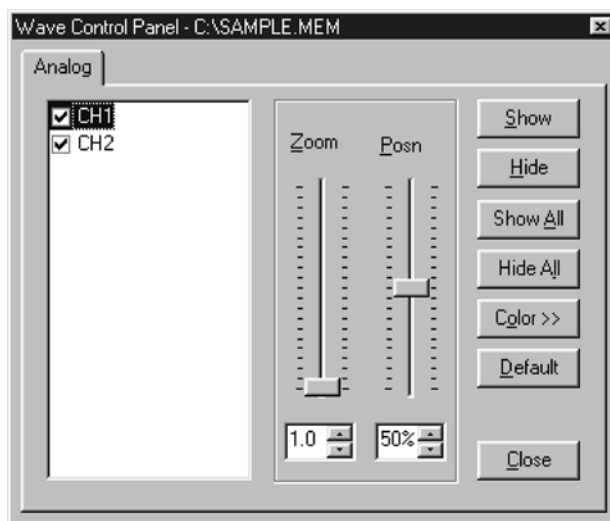

CH	This indicate the list of channel. When a check mark is present the corresponding channel is displayed.
Zoom	Set the magnification on the voltage axis for the specified channel.
Posn	Set the position of the specified channel.
Show	Display the specified channel(s).
Hide	Do not display the specified channel(s).
Show All	Display all channels.
Hide All	Do not display all channels.
Color	Change the color of the specified channel(s).
Default	Set all values of the specified channel(s) to their default values.
Close	Close the Waveform Control Panel.

- **Checking the waveform measurement conditions (Properties)**

Select [View], then [Properties] from the menu to display the measurement settings on the MEMORY HiCORDER.

- **Checking voltage values (Trace)**

Select [View], then [Trace] from the menu to check the time value and difference of the two cursors (A and B) and the voltage values and differences of all channels.

- **File list in index file**

Select [View], then [Block List] to check the file list (block number, file name, time axis range, trigger time) in the index file.

Double-click a file in the list opens a new window in which you can check waveform in that file.

* This is effective only when reading Sequential, Multi-block, REC&MEM index files.

- **Waveform jump function**

Select [View], then [Jump] to jump to the trigger position or the positions of the A or B cursors.

- **Time Notation**

Select [View], then [Time Notation]. You can select the time notation on the waveform display screen.

- **Setting Grid Type**

Select [View], then [Grid Type] on the menu to set the type of grid (None, Standard, or Fine).

- **Display of Title Comment**

Select [View], then [Title] on the menu to display a title comment at the top of the waveform screen.

- **Waveform legend view**

Select [View], then [Remarks] on the menu to view the unit type of each channel, measurement mode, measurement range, filters, comments, scaling, display position, and magnification on the portion below the waveform screen.

- **Fixing waveform view conditions**

Select [View], then [Fixed] on the menu to always view waveforms with the same color, display position and magnification.

When this item is enabled, the file view settings are disabled.

The standard values for display conditions are automatically saved when the application is terminated or when the check mark is removed from [Fixed] menu.

- **Setting the display colors**

Right-click on the waveform display screen, and select [Color], then [Text] [Background] [Grid] to display a dialog box for setting the respective colors.

- **Font settings (character size)**

Right-click on the waveform display screen, and select [Font], to display the font setting dialog box. You can then select the font for text on the waveform display screen.

- **Waveform display snaps (capture)**

Select [View], then [Capture] on the menu to capture waveform display and copy to clipboard as a bit image. You can paste it into other applications.

Appendix 8.4 Conversion to CSV Format

You can convert displayed waveform data to a CSV format file. Once in CSV format, the file can be loaded into spreadsheet or other software for further processing. You can either convert the whole data file or a range selected with the cursors.

If selecting a range, first set the cursors to the required positions. These are indicated at the top of the waveform screen by inverted blue and red "▼": drag these triangles with the mouse to set the range.

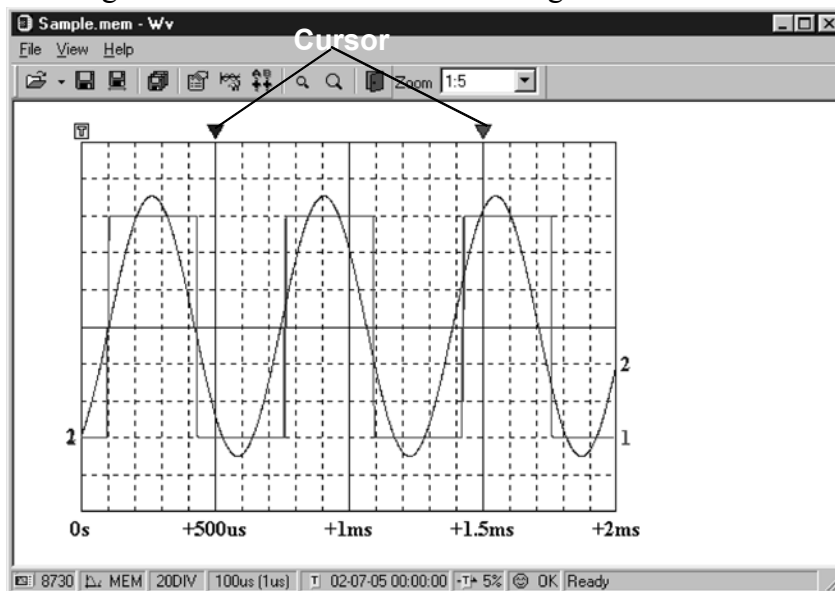

Then to save all of the data, in the [File] menu, select [Save All]; to save the range only, in the [File] menu, select [Save Between Cursors].

A dialog box appears for setting the file to be saved, and the thinning.

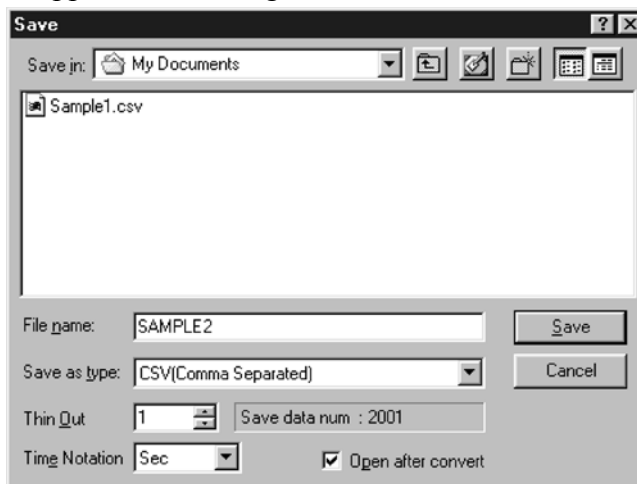

To save in text formats other than CSV (space delimited or tab delimited), select the desired format from the [Save as type] list.

In the [Thin Out] box, enter the number of original samples corresponding to one converted value.

Use this when data over a large range (long time interval) is required, but the whole set of sampled data is not required.

Select [Time Notation] from among [Sec], [Date], [Trig], and [Point].

Enter the name of the file to be saved, and click the [Save] button to convert the data to CSV format and save the file.

Appendix 8.5 Batch Conversion

You can convert multiple waveform files CSV files.

1. Select [File] from the menu bar, then select [Batch Conversion] from the File menu.
2. Select the desired files from the file list. To select two or more files, left-click on the desired files while holding down the Shift or Control key.

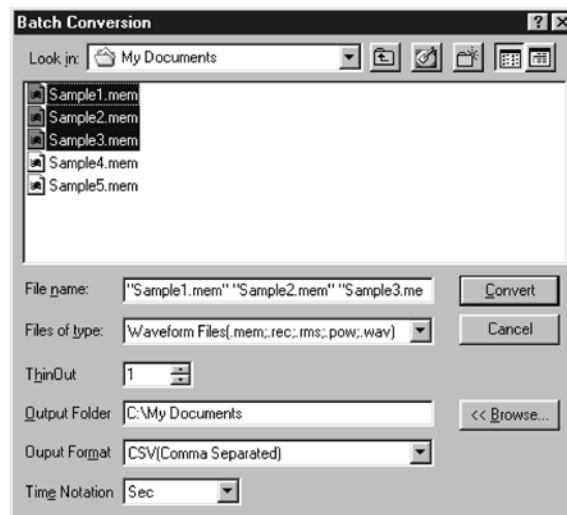

3. If required, specify the sampling intervals in the [ThinOut] box at which data is to be converted. Remember that not all data needs to be converted. This setting is useful when you need data over a broad time span.
4. In the [Output Folder], specify the folder in which to save the CSV files converted from waveform files. You can specify the desired folder without typing simply by clicking on the [<<Browse...] button and selecting the desired folder from the list.
5. To save in text formats other than CSV (space delimited or tab delimited), select the desired format from the [Output Format] list.
6. Select [Time Notation] from among [Sec], [Date], [Trig], and [Point].
7. Click the [Convert] button. All selected waveform files are converted to CSV files and saved in the specified folder.

Index

- A -

A/B cursor 4,247
 ABS 361,364,APPENDIX16
 Accessories i
 ACOS 361
 Aliasing
 124,199,214,216,APPENDIX20
 all clr 378
 All out 375
 Ambient conditions 8
 Analog trigger 219,226
 AND/OR 225,238,243
 Area 322,372,374,376
 ASIN 361,364
 ATAN 361
 Attenuator 26
 AUTO 34,52,58,221,266,328,368
 Auto balancing 200
 Auto correlation (ACR) 129,152
 AUTO key 4,58,244,380
 Auto print 47,140,304
 Auto range function 58,380
 Auto save 48,76,93,109,141
 Auto scroll 246
 Auto setup function 333
 Automatic file name assignment 328
 Average value 356
 Averaging 51,136,APPENDIX12

- B -

Back light saver 261
 Beep sound 262
 Binary 48,76,94,109,111,141,324,326,328,334
 Blank panel 417
 Block diagram 397
 Block display 256,257,350
 BMP 293,323,326
 Bridge voltage 16

- C -

Calculating waveform 361
 CH DIR 339
 CH.SET key 4,191
 CHAN key 3,31,166
 Channel marker 263,290
 CHANNEL screen 31,35,79,168,288
 Clamp on probe 18,21
 Cleaning 280,415,416
 Clear area 378
 Coherence (COH) 129,160
 Comment 187,265,267,290,292
 Common mode rejection ratio
 403,405,406,408,410,411
 Connector cable v,vi,14,15
 Constant value 361,365
 Control code 293,294,308
 Conversion cable 16,17,211
 Conversion ratio method 182,266
 Copy 175,190,363,366
 Copy key 4,31,269,293,307,308
 COS 361,364,APPENDIX18
 Counter print 265,292

Cross Correlation (CCR)	129,158
Cross Power Spectrum (CSP)	129,156
Cursor key	4,32,383
Custom	262
Cut-off frequency	214,216

- D -

DC power adapter	5,10,13
DELETE	336
DIF	361,364,APPENDIX17
DIF2	361,364,APPENDIX17
Digital filter	194
Direct channel setting	193
DISP key	3,31
DISPLAY CHECK	281
Display clear	77,79,80
Display color	169,262,APPENDIX38
Display format	44,54,70,78,89,126,286
Display graph position	169,289
Display scale	133,368
DISPLAY screen	31,57,80,81,95,117,143,191,245
Dot	46,54,77,139

- E -

Editor	375,376
End block	346,348
End time	219,241,243
ERROR	APPENDIX1
Error message	APPENDIX1
Evaluation area	142,322,324,374,376
Evaluation cycle	373
Evaluation result	142,357,359,382
EXP (Exponential)	361,364,APPENDIX16
Exponential averaging	52,136,APPENDIX12
Exponential window	126,151,APPENDIX25
External input/output terminal	379
External print terminal	5,381
External sampling terminal	5,381
External start/stop terminal	5,381
External trigger	219,225,240,380
External trigger terminal	240,380

- F -

Fall time	356,APPENDIX14
FEED key	4,31,307
FFT	119,199,326,372,APPENDIX19
FFT ANALOG UNIT	28,199
File contents	328
File name	76,94,110,141,189,325,328
File name extension	326
Filter width	226,230,238
Floating decimal point	368
Floppy disk	5,48,271,293,312,320,321,331,333
Follow-up waveform display	346
Free-run operation	221
Frequency	88,136,173,201,202,356,APPENDIX13, APPENDIX19
Frequency range	124,163
Full span	180,188
Function ground terminal	5,20
Function mode	42,68,87,101,123
Fuse	9,10,418
Format	315,321,322,387,APPENDIX39

- G -

Gauge	182,185,186,264,291
GO/NG evaluation output terminal	382
GP-IB interface	269,420
Grid	263,290
Ground connection	9,20
Grounding	vii,12,20

- H -

Hanning window	125,151,APPENDIX24
Head up/down lever	23,416
HELP key	4,34
Histogram [HIS]	129,153

- I -

Impulse response [IMP]	129,159
Index file	115,326,APPENDIX37
INFO	335
INITIALIZE screen	278
Input coupling	170,210,214
Input level monitor	255
Input type	403,405,406,408,409,411
Input unit	5,14,26
INT	361,364,APPENDIX17
INT2	364,APPENDIX17
Interface	268,269,271,317,387
Interpolation	46,77,139

- J -

JOG	4,32
-----------	------

- K -

KEY CHECK	281
Key lock	383

- L -

Language	263
LED	4,32,33,281
Level trigger	219,226,236
Line	46,77,139,377
Line cursor	248,249
Linear Spectrum [LIN]	129,146
List	279,341
List & gauge	264,291
List print	307
LOG	361,364
Logic probe	vi,5,20
Logic trigger	219,238
Logic waveform	174
Low pass filter	420

- M -

Magnification/compression ratio along time axis	171,253
Manual print	303
Manual trigger	4,34,219,244
Maximum input voltage	v,26-28,379,402
Maximum rated voltage	v,26,379,402
Maximum recording length	43,51,398
Maximum sampling	385,403,405-409,411
Maximum value	127,356,APPENDIX13
Measurement range	33,34,195,196,213
Memory board	i
Memory segmentation	343
Minimum value	356,APPENDIX13
MK DIR	338
MO disk	313,318,321,APPENDIX31
MOV	361,364
MS-DOS	321,387

- N -

Numerical value	32,46,184
-----------------------	-----------

- O -

Octave Analysis	129,130,134,161
Offset	177,182
On-line help	34
Option	i
Out	372,373,375
Overall value	151
Overlay	50,77
Overwrite	190,313,318,321,332,334

- P -

Paint	377
Parallel	361,364,376,APPENDIX16
Parallel operation	240,380
Partial print	306
Partial saving	323
Partial X-Y plot	55,252
PC card	5,315,316,321
PC CARD CHECK	281
Peak-to-peak value	356,APPENDIX13
Period	69,356,398,APPENDIX8,APPENDIX9
Period trigger	219,233,235
Physical format	321
Position display	246,256
POSITION knob	4,33
Power Spectrum [PSP]	129,150
Power supply	5,9,10,13,202,261,418
Power switch	5,9,13,418
Pre-trigger	222
Print interval	46,73,91,106,140,287
PRINT key	4,31,269,294
Print mode	46,73,91,106,140,287
PRINTER CHECK	280,416
Printer density	264,291
Printer head	280,416
Probe	v,14,17-22,401
PT	ii

- R -

RANGE knob	4,33
Rated supply frequency	9,13
Rated supply voltage	9,10,13
Real time print	75,93,108,305
Recorder function	63
Recording length	43,69,88,103,398,400
Recording paper	vii,23,25
Rectangular window	125,151,APPENDIX24
Ref block	347,349,352
REFRESH	334
REPEAT	50,52,138,344
Report print	307

Reverse	378
Ripple components	420
Rise time	356,APPENDIX14
RM DIR	340
RMS level trigger	219,236
RMS recorder function	83
RMS Spectrum [RMS]	129,148
RMS value	88,219,236,APPENDIX11,APPENDIX13
Roll mode	47
ROM/RAM CHECK	280
Root directory	333,339

- S -

Sampling	APPENDIX8
Sampling period	APPENDIX8
SAVE	322
Scaling function	182
SCSI cable	317,318
SCSI ID	270,319
SCSI interface	270,317
Screen hard copy	307
Scroll	246
SELF CHECK	280,416
Sequential save	326,344
SET	322,324,326
SET UP	260,290
SHUTTLE	4,32
SIN	361,364
SINGLE	50,52,138,224
Size of a waveform file	APPENDIX26,APPENDIX28
SLI	361,364
Smooth print	46,106,287
SORT	337
SQR	361,364
Start & stop	224
Start block	346,348
START key	4,33
Start time	241
STOP key	4,33
Stop mode	358,372
Storage capacity	37,97

STRAIN UNIT 16,28,200
 Subdirectory 338
 Summing averaging 52,137,APPENDIX12
 System reset 279

- T -

TAN 361,364
 Target 270,319
 Text 324,326,329
 Time axis range 42,68,87,102,398
 TIME/DIV key 4,33
 Time interval 241
 TIME SET 278
 Time to maximum value 356
 Time to minimum value 356
 Time value 264
 Timer trigger 219,241
 Trace cursor 247-250
 Transfer function [TRF] 129,154
 Trigger filter 226
 Trigger level 219,225,226
 Trigger mark 75,108,287
 Trigger mode 52,138,218,221
 Trigger pattern 239
 Trigger point 222,226,236
 Trigger slope 219,226
 Trigger source 219,225
 Trigger standby 33,34
 Trigger timing 224

- U -

Unbalanced
 5,403,405,406,408,409,411,APPENDIX7
 Undo 377
 Unit Impulse Response [IMP] 159
 Upper-lower print 264
 Use block 322,327,346,349,351
 Use channel 260

- V -

Variable function 180,185,266

Vernier function 192
 Version 279,APPENDIX33
 VIEW function 256
 Voltage drop trigger 219,231

- W -

WARNING APPENDIX2
 WAVE DATA CLEAR 278
 Waveform GO/NG evaluation 372
 Waveform parameter calculation 355
 Waveform parameter evaluation 357,359,382
 Window-in trigger 219,229
 Window-out trigger 219,229
 Write protect 312,313

- X -

X-Y area 356,APPENDIX15
 X-Y CONT recorder 78,326
 X-Y waveform plot 54

- Z -

Zero adjustment 13,176
 Zero position 4,33,172,265,292
 Zoom function 254,APPENDIX36

- Other-

0 position comment 265,292
 2-point method 182-184,186,266

HIOKI

DECLARATION OF CONFORMITY

Manufacturer's Name: HIOKI E.E. CORPORATION
Manufacturer's Address: 81 Koizumi, Ueda, Nagano 386-1192, Japan
Product Name: MEMORY HiCORDER
Model Number: 8841, 8842
Options: 8936 ANALOG UNIT
8937 VOLTAGE/TEMP UNIT
8938 FFT ANALOG UNIT
8939 STRAIN UNIT
8940 F/V UNIT
8946 4ch ANALOG UNIT
8947 CHARGE UNIT
9607 MO UNIT
9608 MEMORY BOARD (24M-WORD)
9433 DC POWER ADAPTER
9559 PRINTER CARD
9320 LOGIC PROBE
9321 LOGIC PROBE
9197 CONNECTION CORD
9198 CONNECTION CORD
9199 CONVERSION ADAPTOR
9217 CONNECTION CORD

The above mentioned products conform to the following product specifications:

Safety: EN61010-1:2001
EN61010-031:2002
EMC: EN61326:1997+A1:1998+A2:2001+A3:2003
Class A equipment
Minimum immunity test requirement
EN61000-3-2:2000
EN61000-3-3:1995+A1:2001

Supplementary Information:

The products herewith comply with the requirements of the Low Voltage Directive 73/23/EEC and the EMC Directive 89/336/EEC.

HIOKI E.E. CORPORATION

15 September 2006



Tatsuyoshi Yoshiike
President

8841A999-06

HIOKI 8841,8842 MEMORY HiCORDER

Instruction Manual

Publication date: December 2006 Revised edition 11

Edited and published by HIOKI E.E. CORPORATION

Technical Support Section

All inquiries to International Sales and Marketing Department

81 Koizumi, Ueda, Nagano, 386-1192, Japan

TEL: +81-268-28-0562 / FAX: +81-268-28-0568

E-mail: os-com@hioki.co.jp

URL <http://www.hioki.co.jp/>

Printed in Japan 8841A981-11

-
-
- All reasonable care has been taken in the production of this manual, but if you find any points which are unclear or in error, please contact your supplier or the International Sales and Marketing Department at HIOKI headquarters.
 - In the interests of product development, the contents of this manual are subject to revision without prior notice.
 - Unauthorized reproduction or copying of this manual is prohibited.
-
-

HIOKI ---

HIOKI E. E. CORPORATION

HEAD OFFICE

81 Koizumi, Ueda, Nagano 386-1192, Japan
TEL +81-268-28-0562 / FAX +81-268-28-0568
E-mail: os-com@hioki.co.jp / URL <http://www.hioki.co.jp/>

HIOKI USA CORPORATION

6 Corporate Drive, Cranbury, NJ 08512, USA
TEL +1-609-409-9109 / FAX +1-609-409-9108

8841A981-11 06-12H



Printed on recycled paper
