

Declaration of Conformity

We

GOOD WILL INSTRUMENT CO., LTD.
 No. 7-1, Jhongsing Rd., Tucheng City, Taipei County 236, Taiwan

GOOD WILL INSTRUMENT (SUZHOU) CO., LTD.
 No.69 Lushan Road, Suzhou New District Jiangsu, China.

declares that the below mentioned product

GRS-6052A, GRS-6032A

are herewith confirmed to comply with the requirements set out in the Council Directive on the Approximation of the Law of Member States relating to Electromagnetic Compatibility (89/336/EEC, 92/31/EEC, 93/68/EEC) and Low Voltage Equipment Directive (73/23/EEC, 93/68/EEC).

For the evaluation regarding the Electromagnetic Compatibility and Low Voltage Equipment Directive, the following standards were applied:

© EMC

EN 61326-1: Electrical equipment for measurement, control and laboratory use — EMC requirements (1997+A1: 1998)	
Conducted and Radiated Emission EN 55011: 1998 Group I class A	Electrostatic Discharge IEC 61000-4-2: 1995
Current Harmonic IEC 61000-3-2: 1995	Radiated Immunity IEC 61000-4-3: 1995
Voltage Fluctuation IEC 61000-3-3: 1994	Electrical Fast Transients IEC 61000-4-4: 1995
-----	Surge Immunity IEC 61000-4-5: 1995
-----	Conducted Susceptibility IEC 61000-4-6: 1996
-----	Power Frequency Magnetic Field IEC 61000-4-8: 1993
-----	Voltage Dips/ Interrupts IEC 61000-4-11: 1994

© Safety

Low Voltage Equipment Directive 73/23/EEC & amended by 93/68/EEC
Safety Requirements IEC/EN 61010-1:2001

CONTENTS	PAGE
1. PRODUCT INTRODUCTION.....	1
1-1.Description.....	1
1-2.Feature.....	2
2. TECHNICAL SPECIFICATIONS.....	5
3. PRECAUTIONS BEFORE OPERATION.....	9
3-1.Unpacking the Oscilloscope.....	9
3-2.Checking the Line Voltage.....	9
3-3.Environment.....	10
3-4.Equipment Installation and Operation.....	10
3-5.CRT Intensity.....	10
3-6.Withstanding Voltage of Input Terminals.....	10
4. PANEL INTRODUCTION.....	11
4-1.Front Panel.....	13
4-2.Rear Panel.....	32
5. OPERATION METHOD.....	34
5-1.Readout Display.....	34
5-2.Connecting Input Signals.....	37
5-3.Adjustment and Checks.....	38
5-4.Function Check.....	40
5-5.Basic Operation.....	42
5-6.Digital Storage Functions.....	51
5-7.Measurement Application.....	60
5-8.RS-232 Interface Remote Control.....	62
6. MAINTENANCE.....	94
6-1.Fuse Replacement.....	94
6-2.Line Voltage Conversion.....	94
6-3.Cleaning.....	95
7. BLOCK DIAGRAM.....	96

SAFETY TERMS AND SYMBOLS

These terms may appear in this manual or on the product:



WARNING. Warning statements identify condition or practices that could result in injury or loss of life.



CAUTION. Caution statements identify conditions or practices that could result in damage to this product or other property.

Measurement category I is for measurements performed on circuits not directly connected to MAINS.

Measurement category II is for measurements performed on circuits directly connected to the low voltage installation.

Measurement category III is for measurements performed in the building installation.

Measurement category IV is for measurements performed at the source of the low-voltage installation.

The following symbols may appear in this manual or on the product:



DANGER
High Voltage



ATTENTION
refer to Manual



Protective
Conductor
Terminal



Earth(ground)
Terminal

FOR UNITED KINGDOM ONLY

NOTE: This lead/appliance must only be wired by competent persons

WARNING: THIS APPLIANCE MUST BE EARTHED

IMPORTANT: The wires in this lead are coloured in accordance with the following code:

Green/ Yellow:	Earth
Blue:	Neutral
Brown:	Live (Phase)

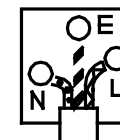

As the colours of the wires in main leads may not correspond with the colours marking identified in your plug/appliance, proceed as follows:

The wire which is coloured Green & Yellow must be connected to the Earth terminal marked with the letter E or by the earth symbol  or coloured Green or Green & Yellow.

The wire which is coloured Blue must be connected to the terminal which is marked with the letter N or coloured Blue or Black.

The wire which is coloured Brown must be connected to the terminal marked with the letter L or P or coloured Brown or Red.

If in doubt, consult the instructions provided with the equipment or contact the supplier.

This cable/appliance should be protected by a suitably rated and approved HBC mains fuse: refer to the rating information on the equipment and/or user instructions for details. As a guide, cable of 0.75mm² should be protected by a 3A or 5A fuse. Larger conductors would normally require 13A types, depending on the connection method used.

Any moulded mains connector that requires removal /replacement must be destroyed by removal of any fuse & fuse carrier and disposed of immediately, as a plug with bared wires is hazardous if engaged in live socket. Any re-wiring must be carried out in accordance with the information detailed on this label.

1.PRODUCT INTRODUCTION

1-1. Description

The GRS-6052A and GRS-6032A set a standard in performance and economy, each equips with two professional scopes in one. They can be operated as a real time 50 or 30MHz analog oscilloscope and become a full function digital storage oscilloscope by pressing a button. Now, you have the power for digital capture and analysis of elusive single shots with a full 100MS/s sample rate. The instruments provide with a high speed A/D converter for each channel to enable the measurement, memory, and analysis of high-speed phenomena. A microprocessor-based operating system controls most of the functions of the instrument, including cursor readout and digitized panel setting. On-screen alphanumeric readout and cursor function for voltage, time and frequency measurement provide extraordinary operational convenience. Ten different user defined instrument settings can be saved and recalled without restriction.

The vertical deflection system has two input channels. Each channel has 14 basic deflection factors from 1mV to 20V per division. The horizontal deflection system provides sweep time from 100s to 0.2 μ s per division. The trigger system provides stable triggering over the full bandwidth of the vertical deflection system.

1-2.Features

Additionally, the oscilloscope offers several other features:

1) High intensity and internal graticule CRT

The oscilloscope employs a high intensity 6-inch rectangular type cathode-ray tube with red internal graticule. It displays clear readable traces even at high sweep speeds. Internal graticule lines eliminate parallax-viewing error between the trace and the graticule line.

2) Multiple Digital Storage Functions

- Digitizing repetitive waveform up to full bandwidth 50/30MHz through the use of equivalent sampling (500MS/s).
- 2k-word acquisition memory per channel up to 10 sets SAVE/RECALL reference memories (with back-up) are provided.
- Pre-trigger function for observing waveforms before triggering. The trigger point can be selected from 0~10 DIV (in 0.02DIV steps).
- Roll mode is ideal for observing flickering low-speed signals. The TIME/DIV range up to 100s.
- The peak detect mode can detect glitch with pulse duration of 25ns or more.
- The persistence mode makes for easy measurements of jitter, voltage variation, and etc.
- The averaging function can be selected freely from 2 to 256. This effectively reduces noise from repetitive signals.
- The smoothing (dot-join) function provides linear connections between the captured point, ensuring that digitized signals are displayed without gaps.
- In the magnification mode, the DOT or LINEAR interpolation can be selected according to the waveform.

- The built-in RS-232C interface enables remote control operation and signal processing via a PC.
 - The X-Y mode is same as the real time mode. The X (horizontal) signal is connected to the input of CH1, the Y (vertical) signal is applied to the input of CH2, and the storage waveform bandwidth up to 50MHz/30MHz.
- ### 3) ALT-MAG Function (both Real Time Mode and Storage Mode)
- The primary sweep waveform along with the magnified sweep waveform can be displayed simultaneously using the ALT-MAG function. The magnification ratio can be selected from among three stages of $\times 5$, $\times 10$, $\times 20$ for magnifying the displayed waveform in the center of the CRT.
- ### 4) Convenient VERT-MODE Triggering
- The sync signal source is decided automatically when vertical axis mode is switched. This means that you need not change the trigger source every time you switch the VERT-MODE.
- ### 5) TV triggering
- Exclusive TV sync separator circuit technology provides stable TV signal measurements on fields, frames and lines.
- ### 6) Hold Off (Real Time Mode only)
- The function allows the obtaining of stable synchronization for even complex waveforms that are difficult to synchronized by adjusting the trigger level alone.
- ### 7) CH1 Signal Output
- The CH1 signal output is obtained by branching the input signal in the middle of the signal line. As the connector outputs the input signal at a rate of 50mV/DIV, connecting a frequency counter makes it possible to measure the frequency of a very low signal while observing its waveform.

8) Z-axis intensity modulation (Real Time Mode only)

For applying a blanking signal from an external source. The trace displayed on the screen may be intensity-modulated where pulse signal or time-scale marks are required.

9) LED indicator and buzzer alarm

The LED's located in the front panel assist operation and indicated additional information. Incorrect operation and the electrical end position of control knobs are indicated by a warning beep.

10) SMD manufacturing technology

The instrument is built by using the most advanced SMD technology so as to reduce the number of internal wiring and shorten the foil route on the pc board. This will also greatly increase the high frequency performance and the reliability of the product.

11) Compact size (275W×130H×370D) mm and front panel layout groups for easy-to-use.

2. TECHNICAL SPECIFICATIONS

CRT	Type	6-inch rectangular type with internal graticule; 0%, 10%, 90% and 100% markers. 8 x 10 DIV (1 DIV = 1 cm)		
	Accelerating Potential	Approx. 10kV (GRS-6052A), 2kV (GRS-6032A)		
	INTEN and FOCUS	Front panel control.		
	Illumination	Provided		
	Trace Rotation	Provided.		
	Z-axis Input (REAL TIME mode only)	Sensitivity: at least 5V Polarity : positive going input decrease intensity Usable frequency range: DC to 2MHz. Max. input voltage: 30V (DC +AC peak) at 1kHz or less. Input Impedance: approx. 33kΩ (GRS-6052A) 47kΩ (GRS-6032A)		
VERTICAL SYSTEM	Sensitivity Accuracy	1mV~2mV/DIV ± 5%, 5mV~20V/DIV ± 3%, 14 calibrated steps in 1-2-5 sequence.		
	Vernier Vertical Sensitivity	Continuously variable to 1/2.5 approx. of panel indicate value.		
	Bandwidth(-3dB) and Rise Time	GRS-6052A	Bandwidth(-3dB)	Rise Time
		5mV~20V/DIV	DC~50MHz	Approx. 7ns
		1mV~2mV/DIV	DC~7MHz	Approx. 50ns
		GRS-6032A	Bandwidth(-3dB)	Rise Time
	5mV~20V/DIV	DC~30MHz	Approx. 11.7ns	
	1mV~2mV/DIV	DC~7MHz	Approx. 50ns	
Maximum Input Voltage	400V (DC + AC peak) at 1kHz or less.			
Input Coupling	AC, DC, GND			
Input Impedance	Approx. 1MΩ ±2% // approx. 25pF			
Vertical Modes	CH1, CH2, DUAL(CHOP/ALT), ADD, CH2 INV.			
CHOP Frequency	Approx. 250kHz.			
Dynamic Range (REAL TIME mode only)	GRS-6052A: 8DIV at 40MHz, 6DIV at 50MHz GRS-6032A: 8DIV at 20MHz, 6DIV at 30MHz			

HORIZONTAL SYSTEM (REAL TIME mode)	Sweep Time	0.2 μ s/DIV~0.5s/DIV, 20 steps selectable in 1-2-5 sequence, continuous variable control between steps at least 1:2.5.			
	Accuracy	$\pm 3\%$, $\pm 5\%$ at $\times 5$ and $\times 10$ MAG, $\pm 8\%$ at $\times 20$ MAG			
	Sweep Magnification	$\times 5$, $\times 10$, $\times 20$ MAG			
	Maximum Sweep Time (at MAG)	GRS-6052A:20ns/DIV (10ns/DIV uncalibrated) GRS-6032A:50ns/DIV(10ns/DIV~40ns/DIV uncalibrated).			
TRIGGER SYSTEM	ALT-MAG Function	Available.			
	Trigger Modes	AUTO, NORM, TV			
	Trigger Source	VERT-MODE, CH1, CH2, LINE, EXT.			
	Trigger Coupling	AC, HFR, LFR, TV-V(-), TV-H(-).			
	Trigger Slope	“+” or “-” polarity.			
	Trigger Sensitivity	GRS-6052A	CH1, CH2	VERT-MODE	EXT
		20Hz~5MHz	0.5 DIV	2.0 DIV	200mV
		5MHz~40MHz	1.5 DIV	3.0 DIV	800mV
		40MHz~50MHz	2.0 DIV	3.5 DIV	1V
		GRS-6032A	CH1, CH2	VERT-MODE	EXT
		20Hz~2MHz	0.5 DIV	2.0 DIV	200mV
2MHz~20MHz		1.5 DIV	3.0 DIV	800mV	
20MHz~30MHz		2.0 DIV	3.5 DIV	1V	
External Trigger Input	TV sync pulse more than 1 DIV (CH1, CH2, VERT-MODE) or 200mV (EXT). Input impedance: Approx. 1M Ω //25pF(AC coupling) Max. input voltage: 400V (DC + AC peak) at 1kHz.				
Hold-off Time	Variable (Real Time Mode only).				
X-Y OPERATION (REAL TIME mode)	Input	X-axis : CH1, Y-axis : CH2			
	Sensitivity	1mV/DIV~20V/DIV.			
	Bandwidth	X-axis: DC~500kHz (-3dB)			
	Phase Difference	3° or less from DC to 50kHz			

DIGITAL STORAGE FUNCTIONS	Acquisition Digitizer	8 bit ADC $\times 2$
	Max. Sampling Rate	500MS/s for equivalent time sampling. 100MS/s for normal sampling.
	Acquisition Mode	Sample, Peak detect (>25ns), envelope, persistence, average (2~256).
	Storage Bandwidth(-3dB)	Single shot: DC to 25MHz. Repetitive : DC to 50MHz (GRS-6052A) DC to 30MHz (GRS-6032A)
	Dynamic Range	± 5 DIV.
	Memory Length	2k words/CH $\times 2$, 1k words/CH (equivalent)
	Acquisition Memory	1k words/CH $\times 10$ with back-up memory(REF 0~9)
	Save REF Memory	1k words/CH $\times 4$ waveform (max.)
	Display Memory	1k words/CH $\times 4$ waveform (max.)
	Sweep Time	Equivalent: 0.2 μ s/DIV ~ 0.5 μ s/DIV Normal: 1 μ s/DIV ~ 0.1s/DIV Roll Mode: 0.2s/DIV ~ 100s/DIV
	Sweep Magnification	$\times 5$, $\times 10$, $\times 20$
	Max. Sweep Time	10ns/DIV
	MAG Interpolation	Dots, Linear
	ALT-MAG Function	Available
	Operation Mode	Auto, Norm, Single, Single-roll, Roll, X-Y Average (2 ~ 256), Run/Stop
	Smoothing Function	Dot Joint ON/OFF selectable
	Pre-trigger	0 ~ 10DIV in 0.02DIV steps (at 5 μ s/DIV ~ 0.1s/DIV)
	X-Y Operation	X-axis: CH1, Y-axis: CH2 Storage Bandwidth : DC~50MHz (GRS-6052A) DC~20MHz (GRS-6032A)
	Display Resolution	H : 100 points/DIV V : 25 points/DIV X-Y: 25 \times 25 points/DIV
	Waveform SAVE/RECALL	10 sets (REF0 ~ REF9) with back-up memory.
OUTPUT SIGNAL	CH1 Signal Output	Voltage : approx. 20mV/DIV (with 50 Ω terminal.) Bandwidth: 50Hz to at least 5MHz.
	Calibrator Output	Voltage : 0.5V $\pm 3\%$, Frequency: approx. 1kHz, square wave.

CURSOR READOUT & CONTROL INTERFACE	Panel Setting Display	CH1/CH2 sensitivity, sweep time, trigger condition, digital storage function.
	Panel Setting Save & Recall	10 sets
	Cursor Measurement	Cursor Measurement Function: ΔV , ΔT , $1/\Delta T$. Cursor Resolution: 1/25 DIV. Effective Cursor Range: Vertical: ± 3 DIV, Horizontal: ± 4 DIV
	Text Readout Intensity	Adjustable
	RS232 Interface	Remote control via a PC.
LINE POWER REQUIREMENT	Voltage	AC100V, 120V, 230V $\pm 10\%$ selectable.
	Frequency	50Hz or 60Hz.
	Power Consumption	Approx. 70VA, 60W(max).
MECHANICAL SPEC.	Dimensions	275(W) \times 130(H) \times 370(D) mm.
	Weights	8.5 kg
OPERATING ENVIRONMENT	Indoor use Altitude up to 2000 m Ambient temperature : To satisfy specifications : 10°C to 35°C (50° F to 95°F) Maximum operating ranges: 0°C to 40°C (32°F to 104°F) Relative humidity: 85% RH(max.) non condensing Installation Category : II Pollution degree 2	
STORAGE TEMPERATURE & HUMIDITY	-10° to 70°C, 70%RH(maximum)	
ACCESSORIES	Power cord..... 1 Instruction manual..... 1 Probe ($\times 1/\times 10$)..... 2	

Measurement category I is for measurements performed on circuits not directly connected to MAINS.

Measurement category II is for measurements performed on circuits directly connected to the low voltage installation.

Measurement category III is for measurements performed in the building installation.

Measurement category IV is for measurements performed at the source of the low-voltage installation.

3. PRECAUTIONS BEFORE OPERATION

3-1. Unpacking the Oscilloscope

The product has been fully inspected and tested before shipping from the factory. Upon receiving the instrument, please unpack and inspect it to check if there is any damages caused during transportation. If any sign of damage is found, notify the bearer and/or the dealer immediately.

3-2. Checking the Line Voltage

The oscilloscope can be applied any kind of line voltage shown in the table below. Before connecting the power plug to an AC line outlet, make sure the voltage selector of the rear panel is set to the correct position corresponding to the line voltage. It might be damaged the instrument if connected to the wrong AC line voltage.



WARNING. To avoid electrical shock the power cord protective grounding conductor must be connected to ground.

When line voltages are changed, replace the required fuses shown as below:

Line voltage	Range	Fuse
100V	90-110V	T 1A 250V
120V	108-132V	
230V	207-250V	T 0.4A 250V



WARNING. To avoid personal injury, disconnect the power cord before removing the fuse holder.

3-3.Environment

The normal ambient temperature range of this instrument is from 0° to 40°C (32° to 104°F). To operate the instrument over this specific temperature range may cause damage to the circuits.

Do not use the instrument in a place where strong magnetic or electric field exists as it may disturb the measurement.

3-4.Equipment Installation, and Operation

Ensure there is proper ventilation for the vents in the oscilloscope case. If the equipment is used not according to the specification, the protection provided by the equipment may be impaired.

3-5.CRT Intensity

To prevent permanent damage to the CRT phosphor, do not make the CRT trace brighten excessively or leave the spot stay for an unreasonably long time.

3-6.Withstanding Voltages of Input Terminals

The withstanding voltages of the instrument input terminals and probe Input terminals are shown in the following table. Do not apply voltages higher than these limits.

Input terminal	Maximum input voltage
CH1, CH2, inputs	400V (DC + AC peak)
EXT TRIG input	400V (DC + AC peak)
Probe inputs	600V (DC + AC peak)
Z AXIS input	30V (DC + AC peak)



CAUTION. To avoid damaging the instrument, do not apply input voltages of the frequency over 1 kHz to the instrument.

4. PANEL INTRODUCTION

After the instrument is switched on, all the important settings are displayed in the readout. The LED's located on the front panel assist operation and indicate additional information. Incorrect operation and the electrical end positions of control knobs are indicated by a warning beep.

All of the pushbuttons, VOLTS/DIV control knobs, TIME/DIV control knobs are electronically selected, and their functions and settings can therefore be stored and remotely controlled as well. Some controls are only operated in the digital storage mode or have a different function. Explanation pertaining to them are indicated with the hint of "storage mode only".

The front panel is subdivided into five sections:

- Display controls
- Vertical controls
- Horizontal controls
- Trigger controls
- Digital storage functions

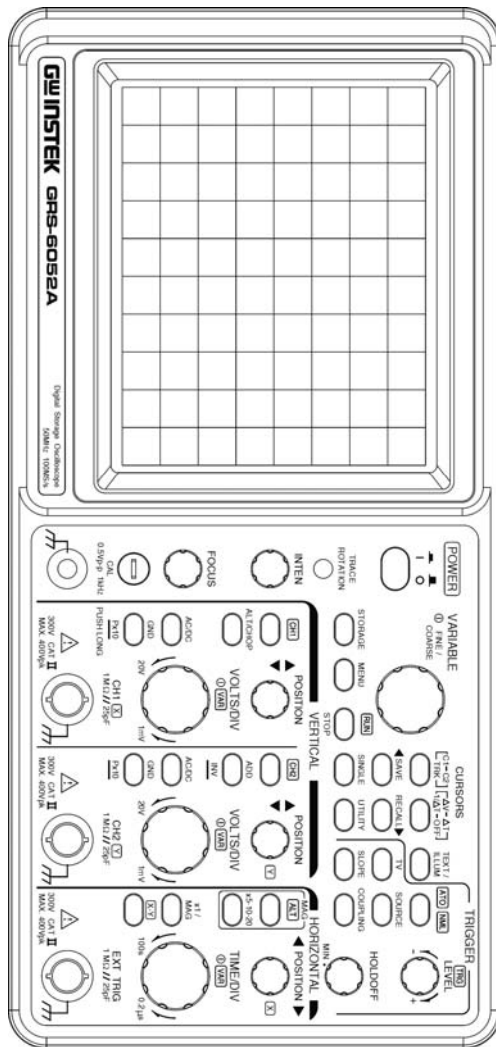

Front panel of GRS-6052A

4-1. Front Panel

Display controls

The display controls adjust the on-screen appearance of the waveform and provide a probe compensation signal source.

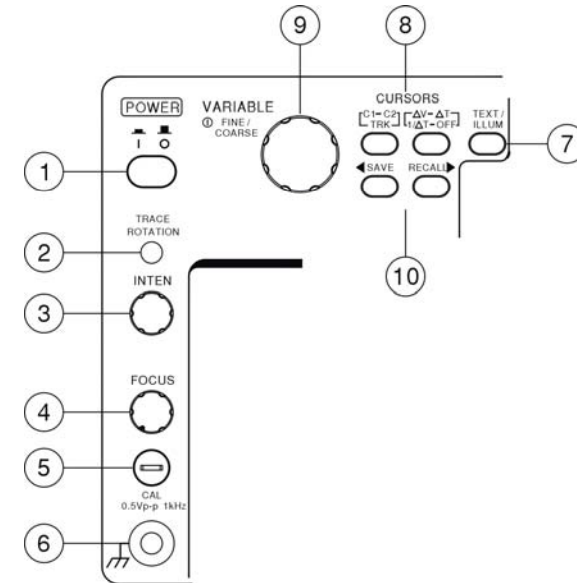

(1) POWER – Pushbutton

When switch on the oscilloscope to have all LEDs lighted and wait a few seconds, the normal operation mode is present. Then the last settings become activated and the LED indicates “ON” condition.

(2) TRACE ROTATION

The TRACE ROTATION is for aligning the horizontal trace in parallel with graticule lines. This potentiometer can be adjusted with a small screwdriver.

(3) INTEN—Control knob (REAL TIME Mode only)

The control knob is used for adjusting the traces intensity in the real time mode. Turning the knob clockwise to increase the intensity while turning it counterclockwise to decrease the intensity.

(4) FOCUS

The control knob effects both the trace and the readout sharply.

(5) CAL

The terminal provides a reference signal of 0.5Vp-p at 1kHz for probe adjustment.

(6) Ground Socket—Banana Socket galvanically connected to safety earth

This socket can be used a reference potential connection for DC and low frequency signal measurement purpose.

(7) TEXT/ILLUM—Control knob with a double function.

The pushbutton is for selecting the text readout intensity function or scale illumination function, and indicates the letter “TEXT” or “ILLUM” in the readout. Press the pushbutton for the following sequences:

“TEXT” — “ILLUM” — “TEXT”

The TEXT/ILLUM function is associated the VARIABLE (9) control knob. Turning the knob clockwise to increase the text intensity or scale illumination, while turning the knob counterclockwise to decrease it. Pressing the knob to switch the TEXT/ILLUM on or off.

In the STORAGE mode, the brightness of the waveform on the screen can be controlled by the “TEXT”.

(8) CURSORS MEASUREMENT FUNCTION

There are two pushbutton and associated the VARIABLE (9) control knob. When the pushbutton is pressed, the three measurement functions will be selected in the sequence as follows:

ΔV — ΔT —1/ ΔT —OFF

ΔV : Two horizontal cursors appear. The voltage between the two cursors is calculated according to the setting of VOLTS/DIV, and displayed with ΔV on the upper side of the CRT.

Single channel mode (CH1 or CH2):

The ΔV measuring result is automatically related to the deflection coefficient of the active channel. The readout displays “ $\Delta V1...$ ” or “ $\Delta V2...$ ”.

Dual channel mode:

The cursor lines must be set on the CH1 or CH2 signal. As the deflection coefficients may be different, it will be required to select between the deflection coefficient of CH1 and CH2.

ADD mode:

In ADD (addition) mode, normally two input signals are displayed as one signal (sum or difference). As the result can only be determined if both (calibrated) deflection coefficients are equal, the readout indicates “ $\Delta V...$ ” without any additional channel information. Different deflection coefficient settings or uncalibrated deflection coefficients are indicated in the readout as “ $\Delta V=...DIV$ ”.

X-Y mode:

In the X-Y mode, the instrument is automatically set to ΔV measurement. The deflection coefficient selected for each channel may be different, thus as in DUAL mode the ΔV cursor measurement requires a channel selection. Under channel 1 (X signal) measuring condition the cursor lines are displayed as vertical lines and the readout displays “ $\Delta VX...$ ”. Pressing the pushbutton, select channel 2 (Y signal) measuring, then the cursor lines are displayed as horizontal lines and the readout indicates “ $\Delta VY...$ ”.

ΔT : Two vertical cursors appear. The time between the two cursors is calculated according to the setting of TIME/DIV, and displayed with

ΔT on the upper side of the CRT.

1/ ΔT : Two vertical cursors appear. The reciprocal of the time (frequency) between the two cursors is calculated with $1/\Delta T$ on the upper side of the CRT.

C1—C2—TRK Pushbutton

The cursor 1, cursor 2 and tracking can be selected by this button. Pressing the pushbutton to select the cursors in sequence as follows:

C1: Moves the cursor 1 on the CRT.

C2: Moves the cursor 2 on the CRT.

TRK: Simultaneously moves the cursor 1 and cursor 2 with the interval between the two cursors unchanged.

(9) **VARIABLE**—

Set the cursor position, TEXT/ILLUM, etc. by turning or pressing the VARIABLE knob.

In the cursor mode, pressing the VARIABLE control knob to select the cursor position between FINE and COARSE adjustment. When select FINE adjustment by turning the VARIABLE, the cursor lines will move slowly. If select COARSE adjustment, the cursor will move fast.

In TEXT/ILLUM mode, this control knob can be used to set the text intensity or illumination. Please refer to TEXT/ILLUM(7) for details.

(10). **SAVE—RECALL**

The instrument contains 10 non-volatile memories, which can be used by the operator to save instrument setting and to recall them. It relates to all controls which are electronically selected.

Press \blacktriangleleft or \blacktriangleright pushbutton to select the memory location. The readout then indicates the letter “M” followed by a cipher between 0 and 9. Each time the \blacktriangleright pushbutton is briefly pressed the memory location cipher increases until the number 9 is reached. The \blacktriangleleft pushbutton is similar but decreases the memory location cipher until the number 0 is reached.

Pressing and holding SAVE for approx. 3 seconds to write the instrument settings in the memory and indicate the associated readout information of “ \blacktriangleleft ”.

To recall a front panel setup, select a memory location as described above. Recall the settings by pressing and holding the RECALL pushbutton for approx. 3 seconds, the readout then indicates the associated readout information of “ \blacktriangleright ”.

Vertical controls

The vertical controls select the displayed signals and control the amplitude characteristics.

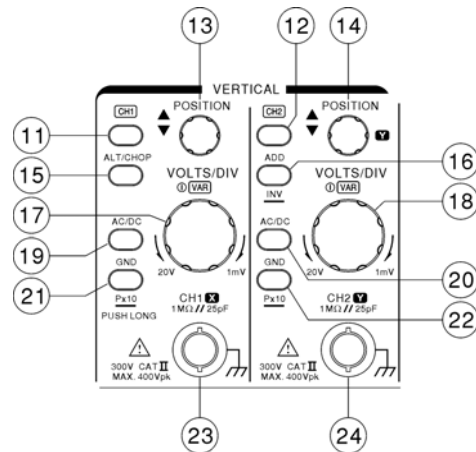

(11) **CH1**—Pushbutton

(12) **CH2**—Pushbutton

Pressing briefly the CH1 (CH2) button to set the channel 1 (channel 2) of the instrument on, the deflection coefficient will be displayed in the readout indicating the current conditions.

(13) **CH1 POSITION**—Control knob

The vertical trace position of channel 1 can be set with the control knob. When X-Y operation in the Storage mode, CH1 POSITION control knob is used for the X deflection.

(14) **CH2 POSITION**—Control knob

The vertical trace position of channel 2 can be set with the control knob. In X-Y operation, CH2 POSITION control knob is used for the Y deflection.

(15) **ALT/CHOP**

In the REAL TIME mode, the pushbutton has two functions, which are required and available only when both channels are active.

ALT—Displays in the readout, indicates alternate channel switching. After each time base sweeps the instrument internally, switches over from channel 1 and channel 2 and vice versa.

CHOP—Indicates chopper

The channel switching occurs constantly between channel 1 and channel 2 during each sweep.

In the STORAGE mode, ALT or CHOP mode is automatically selected by TIME/DIV range. The ALT mode is established for the sweep range of 0.5ms/DIV or faster. The CHOP mode is established for the sweep range of 1ms/DIV or slower.

(16) **ADD-INV**—Pushbutton with double functions.

ADD— Displays the “+” symbol in the readout, indicates additional mode.

Whether the algebraic sum (addition) or the difference (subtraction) of both input signals is displayed, depends on the phase relationship and the INV setting. As a result, both signals are displayed as one signal. For correct measurements, the deflection coefficients for both channels must be equal.

INV—Pressing and holding the pushbutton to set the channel 2 invert function on or off. The invert on condition is indicated by the “ ∇ ” symbol in the readout. The invert function causes the signal display of channel 2 to be inverted by 180°.

(17) **CH1 VOLTS/DIV**

(18) **CH2 VOLTS/DIV**— Control knob for channel 1/channel 2 has double functions.

Turning the knob clockwise to increase the sensitivity in 1-2-5 sequence and turning it in the opposite direction (CCW) to decrease. The available range is from 1mV/DIV up to 20V/DIV. The knob is automatically switched inactive if the related channel is switched off.

The deflection coefficients and additional information regarding the active channels are displayed in the readout.

VAR

Pressing the VOLTS/DIV control knob to select the VOLTS/DIV function between attenuator and vernier (variable). The current setting is displayed by the “>” symbol in the readout.

After switching on the VAR, turn the VOLTS/DIV control knob counterclockwise to reduce the signal height, and the deflection coefficient becomes uncalibrated.

(19) CH1 AC/DC

(20) CH2 AC/DC

Pressing the pushbutton briefly to switch over from AC (~ symbol) to DC (= symbol) input coupling. The setting is displayed in the readout with the deflection coefficient.

(21) CH1 GND – P×10

(22) CH2 GND – P×10 – Pushbutton of two functions.

GND

Each time when the pushbutton is pressed briefly, the input of the vertical amplifier is grounded. It is displayed in the readout as an earth (ground) symbol “ \perp ”.

P×10

Pressing and holding the pushbutton to select the indicated deflection coefficient of the channel displayed in the readout between 1:1 and 10:1. The probe factor of 10:1 is displayed in the readout with the probe symbol “P×10” in front of channel indication. When proceed cursor voltage measurement, the probe factor will be automatically included. The symbol must not be activated unless a 10:1 attenuator probes are used.

(23) CH1-X—Input BNC socket

This BNC socket is the signal input for channel 1. In X-Y mode, signals at this input are used for the X deflection. The outer (ground) connection is galvanically connected to the instrument ground and consequently to the safety earth contact of the line/mains plug.

(24) CH2-Y—Input BNC socket

This BNC socket is the signal input for channel 2. In X-Y mode, signals at this input are used for the Y deflection. The outer (ground) connection is galvanically connected to the instrument ground and consequently to the safety earth contact of the line/mains plug.

Horizontal controls:

The horizontal controls select the time base operation mode and adjust the horizontal scale, position and magnification of the signal.

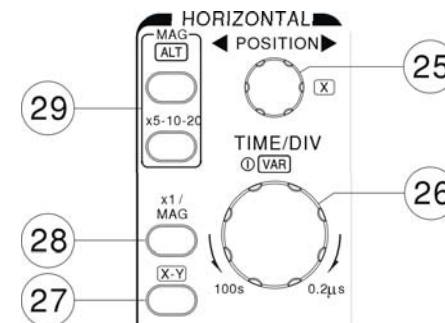

(25) H POSITION (Real Time mode only)

The control knob enables a horizontal position shift of the signals. In combination with MAG the function makes it possible to shift any part of the signal on the screen.

In X-Y mode, the control knob are used for the X deflection.

(26) TIME/DIV-VAR– Control knobs

Turning the knob clockwise to reduce the deflection coefficient in a 1-2-5 sequence and turning it in the opposite direction (CCW) to increase. The time coefficient(s) will be displayed in the readout.

In the REAL TIME mode, the time deflection coefficients between 0.5s/DIV and 0.2 μ s/DIV can be chosen in 1-2-5 sequence, if the MAG function is not activated.

In the STORAGE mode, the sampling method is changed automatically by the TIME/DIV range.

Equivalent sampling (EQU): 0.2 μ s/DIV to 0.5 μ s/DIV.

Only a repetitive signal can be stored.

Normal sampling (SMPL): 1 μ s/DIV to 0.1s/DIV.

Single shot and repetitive signal can be stored.

Roll mode: 0.2s/DIV to 100s/DIV.

For observing flickering low-speed signals.

VAR (Real Time mode only)

Pressing the pushbutton to select the TIME/DIV control knob function between time base switch and vernier (variable). In the Real Time mode, after switching on the VAR, the time deflection coefficient is still calibrated until further adjustments are made. Turn the TIME/DIV control knob counter clockwise to increase the time deflection coefficient (reduce the deflection speed) and the deflection coefficient becomes uncalibrated. The current setting is displayed by the ">" symbol in the readout.

(27) X-Y

Pressing the pushbutton when using the instrument as an X-Y oscilloscope. The time deflection coefficient is replaced by the "X-Y" symbol in the readout.

In this mode, the X (horizontal) signal is connected to the input of CH1; the Y (vertical) signal is applied to the input of CH2 and has a deflection range from less than 1mV to 20V/DIV at a reduced band-width of 500kHz (Real Time mode).

In the Storage mode, the X-Y operation is same as the REAL TIME mode. The storage waveform bandwidth of both X and Y signal are up to 50MHz/30MHz.

(28) $\times 1$ /MAG

Pressing the pushbutton the select the sweep time between $\times 1$ (normal) and MAG (magnify). If the MAG function, the signal display will be expanded and consequently only a part of the signal curve is visible. The interesting part of the signal can be made visible with the aid of the H POSITION control in the REAL TIME mode.

(29) MAG FUNCTION **$\times 5$ - $\times 10$ - $\times 20$ MAG**

When MAG has been done, the displayed waveform will be expanded to the right and left with the center of the CRT. The magnification ratio can be selected from among three stage of $\times 5$ - $\times 10$ - $\times 20$ MAG by pressing this pushbutton.

ALT MAG

Pressing the pushbutton, the primary sweep waveform along with the magnified sweep waveform. The magnified can be displayed simultaneously using the ALT-MAG function. The magnified sweep waveform appears 3 divisions below the primary sweep waveform.

Trigger controls

The trigger controls determine the sweep start timing for both signals.

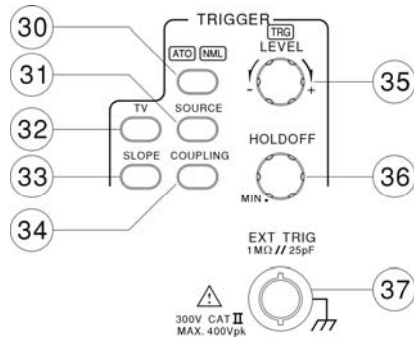

(30) ATO/NML – Pushbutton and indicator LEDs.

Pressing the pushbutton to select auto or normal trigger mode. The actual setting is indicated by a LED.

Each time when the pushbutton is pressed the trigger mode changes in the sequence:

ATO—NML—ATO

ATO (Auto)

Select the automatic mode, the sweep free-runs will display a baseline trace when there is no trigger signal. The setting of triggering level changed only when the TRIGGER LEVEL control is adjusted to a new level setting.

NML (Normal)

Select the normal mode, the input signal will trigger the sweep when the TRIGGER LEVEL control is set within the peak-to-peak limits of an adequate trigger signal. When the sweep is not triggered, no baseline trace will be displayed.

Use this mode when effecting synchronization to a very low frequency signal (25Hz or less).

(31) SOURCE—Pushbutton

Pressing the pushbutton to select the trigger signal source. The actual setting is indicated by the readout (“SOURCE”, slope, coupling).

Each time when the pushbutton is pressed, the trigger source change in the sequence:

VERT—CH1—CH2—LINE—EXT—VERT

VERT (Vertical Mode)

For observing two waveforms, the sync signal changes alternately corresponding to the signals on CH1 and CH2 to trigger the signal.

CH1

The signal applied to the channel 1 input connector is the source of the trigger signal.

CH2

The signal applied to the channel 2 input connector is the source of the trigger signal.

LINE

The triggering signal is obtained from a sample of the AC power source waveform. The trigger source is useful when the displayed waveform frequency is time related to the AC power source frequency.

EXT

The external signal applied through the EXT input connector is used for the external triggering source signal.

(32) TV—Pushbutton for video sync signal selection

Separate the video sync signal from the composite waveform and direct it to the triggering circuit. The horizontal or vertical sync signals are selected by TV pushbutton. The current setting is displayed in the readout under item (source, video polarity, “TVV or TVH”). Each time when the pushbutton is pressed, the video sync signal is displayed in the sequences as follows:

TV-V—TV-H—OFF—TV-V

TV-V

Start the main trace at the beginning of a video signal field. The polarity must match the composite sync polarity (i.e., “” for negative sync) to obtain TV field triggering on the vertical sync pulse.

TV-H

Start the main trace at the beginning of a video signal line. The polarity must match the composite sync polarity to obtain TV line triggering on the horizontal sync pulse.

(33) SLOPE—Pushbutton for the triggering slope.

Briefly pressing the pushbutton to select the slope of the signal which is used for triggering the time base generator. Each time when the pushbutton is briefly pressed, the slope direction will switch from falling edge to rising edge, and vice versa.

The current setting is displayed in the readout under item “source, SLOPE, coupling”.

If in the TV trigger mode, it is synchronized only when the sync signal is negative. A “” symbol is displayed in the readout.

(34) COUPLING—

Pressing the pushbutton to select the trigger coupling. The actual setting is indicated by the readout (source, slope “COUPLING”).

Each time when the COUPLING pushbutton is pressed the trigger coupling changes in the sequence:

AC—HFR—LFR—AC

AC

Attenuates trigger signal frequency components below 20Hz and blocks the DC component of the signal.

AC coupling is useful for triggering on AC waveforms that have a large DC offset.

HFR (High Frequency Reject)

Attenuates high-frequency triggering signal components above 50kHz. HFR coupling is useful for providing a stable display of low-frequency components of complex waveforms and eliminates high-frequency interference from the trigger signal.

LFR (Low Frequency Reject)

Attenuates low-frequency triggering signal components below 30kHz and blocks the DC component of the trigger signal.

LFR coupling is useful for producing stable triggering on the high-frequency components of complex waveforms and rejecting low-frequency interference or power supply hum from the trigger signal.

(35) TRIGGER LEVEL—Control knob with TRG LED

Turning the control knob causes a different trigger input setting (voltage), and set to a suitable position for the starting of triggered sweep of the waveform. When rotate clockwise the control knob, the trigger point moves toward the positive peak of the trigger signal and rotate it counterclockwise to move the trigger point toward the negative peak of the trigger signal.

When the setting (voltage) value is out of the changing portion of the observation waveform, the synchronization sweep stops.

TRG LED

The TRG LED is lit if the triggering conditions are met. Whether the LED flashes or is lit constantly depends on the frequency of the trigger signal.

(36) **HOLD-OFF**—Control knob (REAL TIME mode only)

Used when the signal waveform is complex and stable triggering cannot be attained with the TRIGGER LEVEL(35) knob alone, rotate this control knob to adjust hold-off time(trigger inhibit period beyond sweep duration). When control is rotated fully clockwise, the hold-off period is at MINimum (normal). The hold-off period increases progressively with counterclockwise rotation.

(37) **TRIG EXT**—This BNC socket is the external trigger signal input.

Pressing the TRIG. SOURCE (31) pushbutton until the information of “EXT, slope, coupling” is shown up in the readout switches the input on.

The outer (ground) connection is galvanically connected to the instrument ground and consequently to the safety earth contact of the line/mains plug.

The maximum input voltages of the input terminal are shown in the section of 3-6. “Withstanding voltage of Input terminals”. Do not apply voltage higher than the limit.

Storage Control

The Storage Control select the digital storage function.

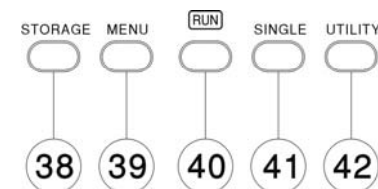

(38) **STORAGE/REAL TIME mode**

Switch the REAL TIME mode to (digital) STORAGE mode by pressing the button. In this case, all the switches from (39) to (42) are valid.

When the switch is pressed again in the STORAGE mode, the REAL TIME mode is established again. In the STORAGE mode, the RUN LED blinks in synchronism with sampling.

(39) **MENU**

Press the pushbutton to change the acquisition mode, the smoothing ON or OFF, the interpolation method and the selection of SAVE/RECALL waveform memory. Each pressing changes the setting mode and the present setting mode is displayed at the top right on the CRT. The settings in each mode are changed by the VARIABLE (9) control knob. Please refer to section 5-7 for details.

(40) **RUN/STOP—Pushbutton and indicator LED**

Pressing this pushbutton to stop sampling, resulting in the hold state, and the RUN LED is off. The current setting is indicated by the readout (“STOP”).

Further pressing the pushbutton to release hold state and start sampling states.

(41) SINGLE

Pressing the pushbutton to set the SINGLE mode and the “SINGLE” message will be indicated in the readout.

In this operation mode, a single signal acquisition process or sweep can be started with a trigger. Providing the trigger circuit has been previously activated with reset function, SINGLE is automatically switched to normal triggering (NML LED lights up). Otherwise the trigger automatic would start the signal acquisition processes without an input (trigger) signal.

Pressing the RUN/STOP pushbutton (reset function) again to resume a new single event capture which then overwrites the previously recorded display.

(42) UTILITY

The instrument software contains several utility setting. Each time when the UTILITY pushbutton is pressed, the readout displays the following message in the sequence at the top right of the CRT:

RS232 baud rate

BEEP ON/OFF

FACTORY DEFAULT loading

RS232 Baud Rate

The setting of baud rate and data format on the instrument must be the same as the one on the computer. The baud rate of the RS-232 interface can be selected by turning the VARIABLE control knob according to the list as follows:

300—900—1200—2400—4800—9600

Press the VARIABLE control knob to set RS-232 baud rate, the screen will display “RM” in the upper left corner to show GRS-6052AA/6032 in the Remote Control mode.

Note: When the baud rate is set, the front panel control will be locked. Press UTILITY can unlock the front panel control and disable remote control.

BEEP ON/OFF

When the “BEEP” is displayed, turning the VARIABLE control knob to set the beep on or off. In the “OFF” condition, the acoustic signals actuated by the control limits are switched off.

FACTORY DEFAULT loading

When the “FACTORY DEFAULT” is displayed, pressing the VARIABLE control knob to overwrite all panel setting memories (MEM0~MEM9), please refer to the setting as follows:

REAL TIME mode	: ON
VERTICAL	: CH1: ON, CH2: ON
	VOLTS/DIV: 0.5V
	COUPLING: AC
HORIZONTAL	: TIME/DIV: 100 μ s
TRIGGER	: MODE: ATO
	SOURCE: CH1
	COUPLING: AC
	SLOPE: \square

4-2. Rear Panel

The rear panel provides input power and additional signal connections.

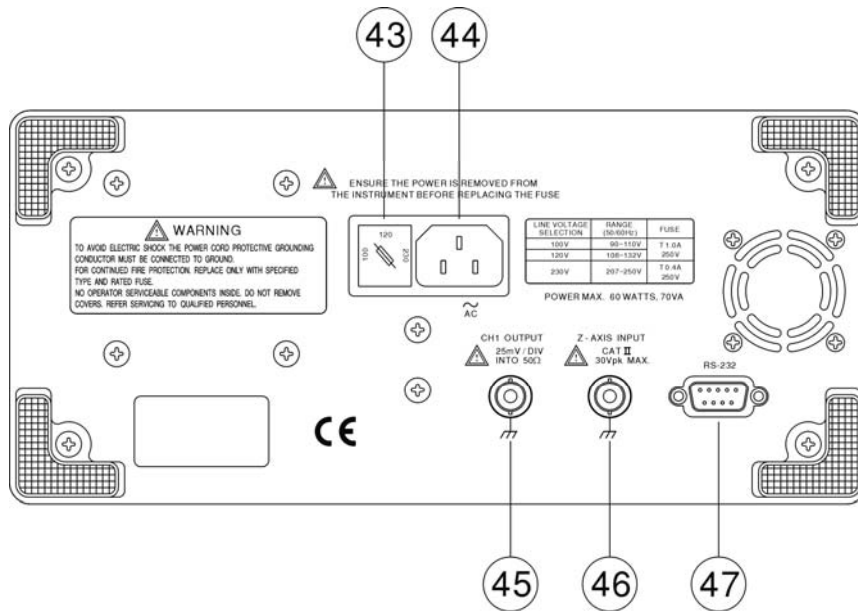

(43) **Line voltage selector and input fuse holder**—Select power source and contain the primary power fuse

The fuse rating is shown in the section of 3-2 Checking the line voltage.

(44) **AC power input connector**

Connect the AC power cord to the power supply of instrument, the power cord protective-ground connection is connected to the exposed metal part of the instrument. The power cord must be connected to a proper grounded source for electrical-shock protection.

(45) **CH1 Output**—BNC socket

This output may be used to connect to a frequency counter or other instrument.

(46) **Z-Axis Input**—BNC socket

Connect external signals to the Z-axis amplifier for intensity modulating the CRT display. This terminal is DC-coupled. The intensity is lowered by a positive signal, while it is increased by a negative signal.

(47) **RS-232**—Connector

Connect to other equipment with the RS-232 interface.

5. OPERATION METHOD

This section contains basic operation information and techniques that should be considered before proceeding any measurement. As for the location and function of instrument controls, connectors, and indicators, refer to the “Instruction of Front Panel and Rear Panel” of this manual.

5-1. Readout Display

The CRT readout display indicates how to set up the instrument controls. No physical marking shown on the rotating switches indicates the control setting. A key to the location and type of readout information display are illustrated in figure 5-1(a) and 5-1(b):

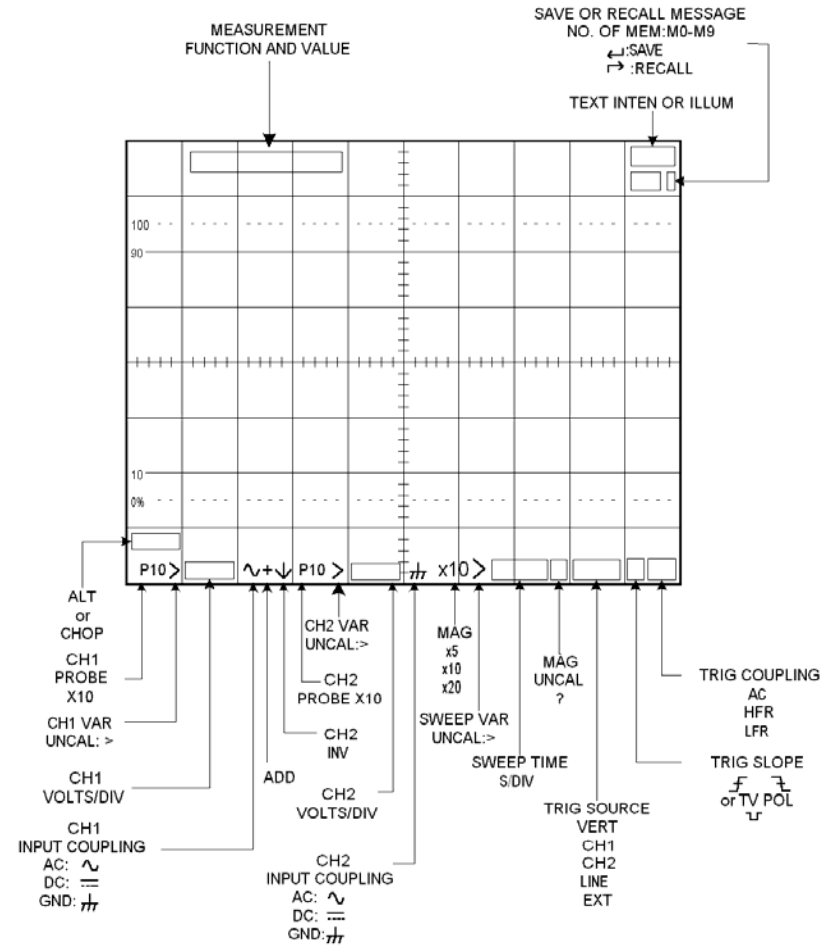

Figure 5-1(a) REAL TIME mode Readout Layout

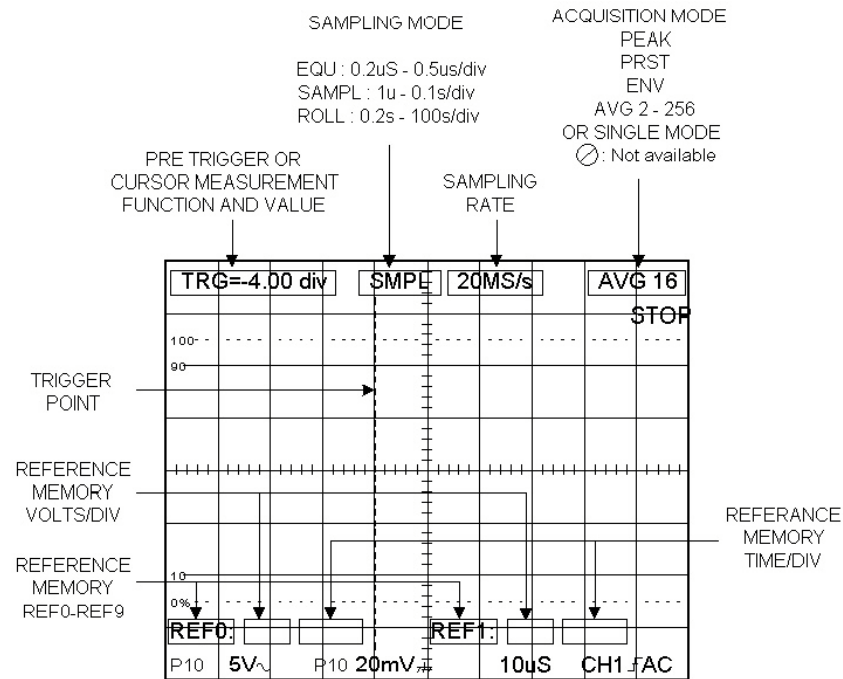

Figure 5-1(b) Storage Mode Readout Layout

5-2.Connecting Input Signals

Grounding

The most reliable signal measurements are made when the oscilloscope and the unit under test are connected by a common reference (ground lead) in addition to the signal lead or probe. The ground lead of the probe provides the best grounding method for signal interconnection and ensures the maximum amount of signal-lead shielding in the probe cable. A separate ground lead (with a banana plug) can also be connected from the unit under test to the oscilloscope ground jack on the front panel.

Probes

A probe provides the most convenient way to connect an input signal to the oscilloscope. The standard $\times 1 \times 10$ probes supplied to the oscilloscope are shielded against electromagnetic interference and have a high input impedance for low circuit loading.



CAUTION. To get the best waveform precisely, keep probe ground and signal leads as short as possible.

Misadjust probe compensation can cause measurement error. Check and adjust probe compensation whenever a probe is moved to a different channel or oscilloscope. As for the probe compensation adjustment procedure, refer to the “Probe Compensation”.

Coaxial Cables

Signal input cable can greatly affect the accuracy of a displayed waveform. To maintain original frequency characteristics of the input signal, use only high-quality, low-loss coaxial cables. Coaxial cables must be terminated at both ends in their characteristic impedance to prevent signal reflections within the cable. Use suitable impedance-matching devices.

5-3.Adjustments and checks

Trace Rotation Adjustment

Normally, when the trace is in parallel with the center horizontal graticule line, there will be no need to adjust the TRACE ROTATION. If necessary, adjust the TRACE ROTATION to make the baseline trace parallel to the center horizontal graticule line by using a small straight-blade screwdriver or alignment tool.

Probe Compensation

To minimize the distortion of measured waveforms, check the compensation of your probes before using them. The probe compensation should be checked periodically whenever the probes are moved to different input channels.

1. Install the probes onto the oscilloscope (Press the BNC connector onto the channel input and rotate the connector to lock it into place).
2. Set the probe slide switches to the $\times 10$ position.
3. Briefly pressing the CH1/CH2 button to set the oscilloscope to channel 1 and channel 2.
4. Pressing and holding the P $\times 10$ button to set the indicated deflection coefficient of the channel displayed in the readout as a symbol "P10".
5. Attach the probe tips to the CAL connection in the front of the oscilloscope.
6. Set the oscilloscope controls to display both channels:

VERTICAL:	VOLTS/DIV	0.2V
	COUPLING	DC
	ALT/CHOP	CHOP
HORIZONTAL:	TIME/DIV	0.5ms
TRIGGER:	MODE	ATO
	SOURCE	VERT
	COUPLING	AC
	SLOPE	\square

7. Observe the displayed waveform and compare them with the waveforms shown in figure 5-2. If either probe needs to be adjusted, proceed the step 8. If

either probe does not need to be adjusted, proceed the "Function Check".

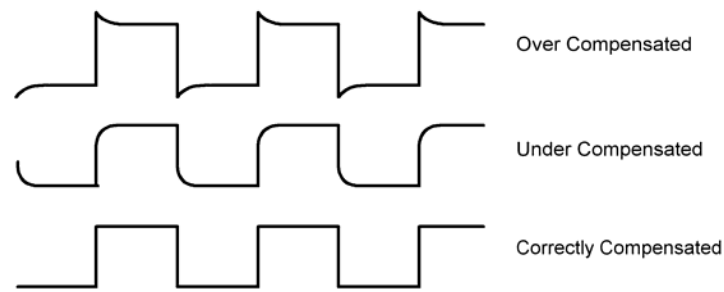

Figure 5-2 Typical Compensation Waveform

8. Adjust the probe by using a small insulated screwdriver. Slowly rotate the adjustment control until the probe is properly compensated.

5-4.Function Check

When you start to check the operation of your oscilloscope, proceed the following instruction:

1. Install the $\times 10$ probes onto CH1 and CH2 inputs.
2. Connect the probe tips to the CAL test point of the oscilloscope.
3. Set the oscilloscope controls to display both channels:

VERTICAL:	VOLTS/DIV	0.2V
	COUPLING	DC
	ALT/CHOP	CHOP

HORIZONTAL:	TIME/DIV	0.5ms
-------------	----------	-------

TRIGGER:	MODE	ATO
	SOURCE	VERT
	COUPLING	AC
	SLOPE	\uparrow

The figure 5-3 below illustrates a satisfactory display. The waveform should be approximately 0.5Vp-p at a frequency of 1kHz that confirms the vertical and horizontal deflection function of the oscilloscope.

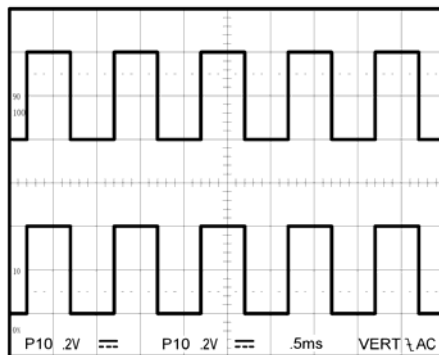

Figure 5-3 Function Check

4. Set both CH1 and CH2 COUPLING to GND.
5. Use the CH1 and CH2 POSITION controls to align both traces on the center graticule.
6. Open the CH2 INV by pressing and holding the pushbutton.
7. Set to the ADD mode by pressing the ADD pushbutton briefly.
8. Set both CH1 and CH2 COUPLING to DC.
9. The figure 5-4 below shows a satisfactory display. The display will show a flat trace located on the center graticule that confirms the channel balance and ADD offset function.

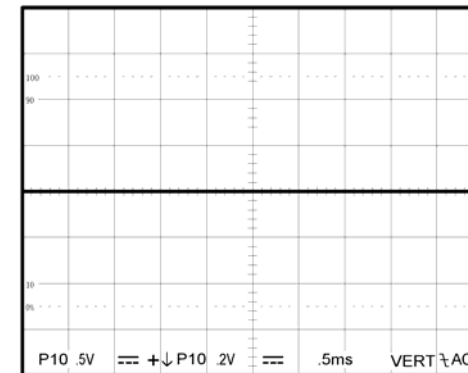

Figure 5-4 ADD mode

10. Turn off the ADD mode by pressing the ADD pushbutton briefly.
11. Turn off the CH2 INV by pressing and holding the pushbutton.

5-5. Basic Operation

Displaying CH1 or CH2

To display the signal from a signal channel, pressing briefly the CH1 or CH2 pushbutton to set the oscilloscope to channel 1 or channel 2.

Displaying CH1 and CH2

To display both signals at the same time, proceed the following steps:

1. Set the CH1 and CH2 on. The figure 5-5 below shows two synchronous waveforms in the both modes.
2. Adjust the CH1 or CH2 POSITION control to position the two waveforms.
3. Set the ALT/CHOP button to CHOP mode if the waveforms are flickering.

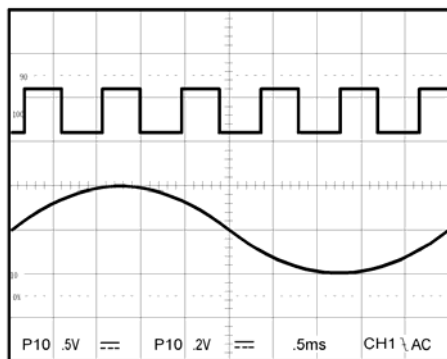

Figure 5-5 Both typical waveforms

Displaying the sum or difference of CH1 and CH2

To display the algebraic sum or difference of CH1 and CH2, proceed the following steps:

1. Set the ADD button to ADD mode. The figure 5-6 below shows the sum of the waveforms from figure 5-5.
2. Set the CH2 INV on by pressing and holding the button, if necessary, to display the different waveform.
3. Pressing and holding one of the VOLTS/DIV control knob to set it to vernier (variable). Then adjust one channel to the other in the event of gain difference.

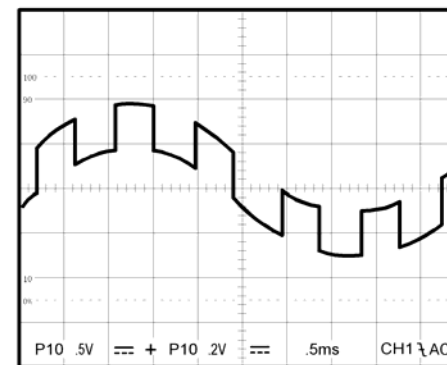

Figure 5-6 Typical ADD waveform

Comparing Frequency and phase (X-Y Operation)

To compare the frequency and phase between two signals by using the X-Y mode. The X-Y waveform displays different amplitude, frequency, and phase. The figure 5-7 shows a typical waveform made up of two signals that are of the same frequency and amplitude, but approximate 45° out of phase.

To use the oscilloscope in the X-Y mode, proceed the following steps:

1. Connect the horizontal or X-axis signal to the CH1 input.
2. Connect the vertical or Y-axis signal to the CH2 input.
3. Set the X-Y button to X-Y operation (shown as Fig. 5-7 below).

Use the HORIZONTAL POSITION control to adjust the X-axis.

Note: When high frequency signals are displayed in the X-Y operation, note the frequency bandwidths and phase difference between X and Y axis. Refer to “2. SPECIFICATION” section for details.

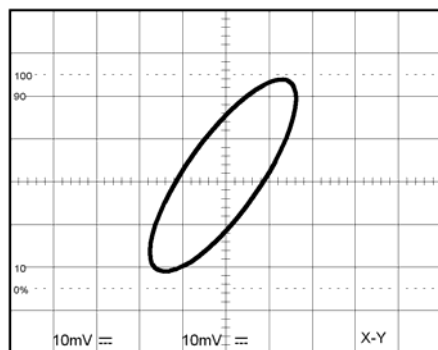

Figure 5-7 Typical single X-Y display.

Magnifying Waveform Events

Use the MAG pushbutton to view small portions of a waveform as which is too far back from the starting point to view by using the TIME/DIV control. To use the MAG button, proceed the following steps:

1. Adjust the TIME/DIV to the fastest sweep that displays the event.
2. Rotate the HORIZONTAL POSITION control to move the event to display on the center of screen.
3. Press the MAG button.
4. Select MAG $\times 5$, MAG $\times 10$, or MAG $\times 20$ for MAG function.

When above procedures have been done, the displayed waveform will be expanded 10 times to the right and left from the center of screen as center of expansion.

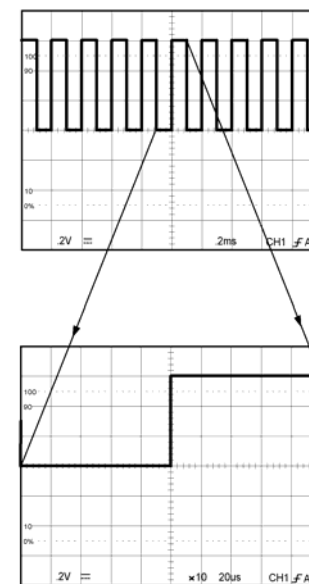

Figure 5-8 Magnified Waveform

MAG-ALT Function

The input Signal is displayed by pressing MAG(magnify) and MAG-ALT(LED light) buttons:

- 1.Set the wished portion of the waveform to the center of the screen for magnification.
- 2.The magnified waveform spreads about 3 Divisions below the normal ($\times 1$) waveform.
- 3.It is a normal function when the MAG-ALT button is pressed, the characters will be vanished from the screen.

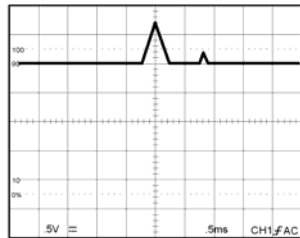

Figure 5-9(a) Mag.x1 Waveform

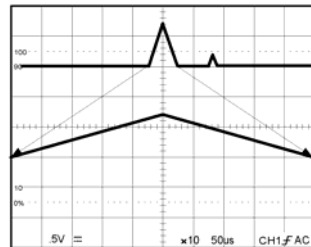

Figure 5-9(b) Mag.x10 Waveform

Operating Hold off time Control (REAL TIME mode only)

When the measured signal is a complex waveform with two or more repetition frequencies (period), triggering with the LEVEL control alone may not be sufficient to attain a stable waveform display. In such a case, the sweep can be stable synchronized to the measured signal waveform by adjusting the Hold off time of the sweep waveform.

Figure 5-10(a) shows several different waveforms which overlapped on the screen, marking the signal observation unsuccessful when the hold off is set to minimum.

Figure 5-10(b) shows the undesirable portion of the signal is held off. The same waveforms are displayed on the screen without overlapping.

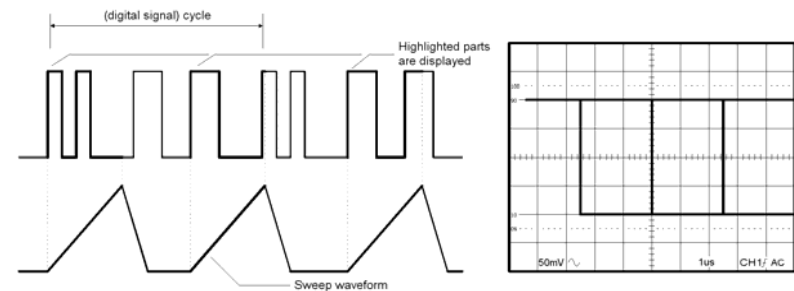

Figure 5-10(a) Hold-off Time Control

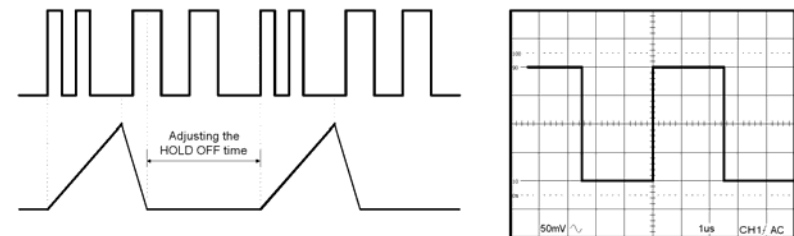

Figure 5-10(b) Hold-off Time Control

Observing the Synchronization of two Waveforms

When two signals of the CH1 and CH2 have the same frequencies with an integral number, or a specific time difference, the SOURCE selects either CH1 or CH2 as a reference signal. Select CH1 signal from CH1 position and select CH2 signal from CH2 position as a reference.

Set the SOURCE to VERT-MODE for observing the signal of different frequencies. Switch the sync signal alternately to each channel, the waveform of each channel will be triggered stably.

When set the SOURCE to VERT-MODE and set the ALT/CHOP to ALT, the input signals applied to CH1 and CH2 will become trigger source alternately during sweep. Consequently, even the waveforms of different frequency of each channel can be triggered stably.

Apply a sine wave to CH1 and a square wave to CH2, “A”s shown in Figure 5-11 are at the level possible for synchronization.

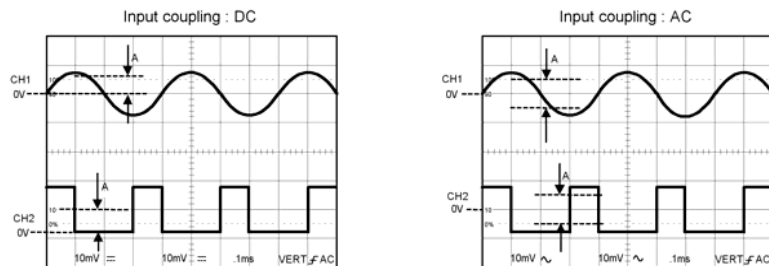

Figure 5-11 Trig. Source on VERT

Apply AC coupling to CH2 in order to expand the synchronization range.

If the input signal of CH1 or CH2 becomes small, adjust VOLT/DIV control knob to obtain sufficient amplitude.

The VERT-MODE triggering required 2.0 DIV which is larger than the amplitude of CH1 or CH2.

The VERT-MODE triggering is not possible when the signal is applied only to one channel as shown in Figure 5-12 below:

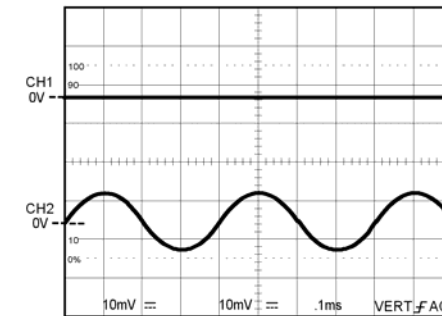

Figure 5-12 Trig. Source on VERT. one channel

ALTERNATE TRIGGER

The Jittering wave as shown in Figure 5-13 may appear on the screen when a gently-sloping signal is displayed 10 cycles or less approximately by setting VERT-MODE to SOURCE, and setting ALT/CHOP pushbutton to ALT. For detailed and clear observation of each signal, set VERTICAL mode to CH1 or CH2.

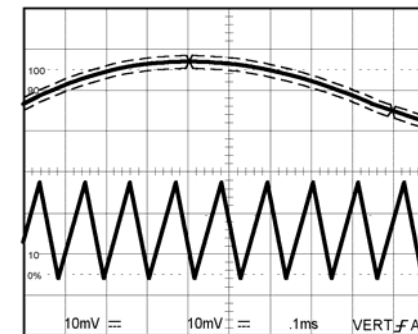
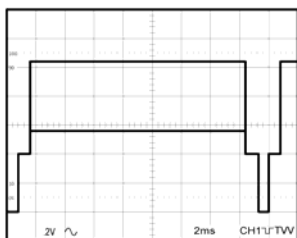
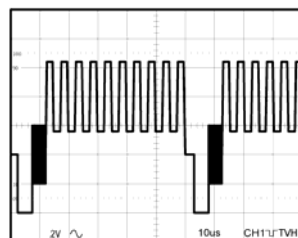

Figure 5-13 Alternate Trig.

Triggering of Video signal

In the work concerned with TV, complex signals and containing video signal, blanking pedestal signal, and synchronizing signal are often measured.

Press the TV pushbutton to set the TV position. The built-in active TV-Sync-separator provides the separation of frame or line sync pulses from the video signal. To trigger the oscilloscope at the vertical (frame) rate, press the TV pushbutton to set TV-V and TV-H triggering. The figure 5-14(a) shows vertical signal of TV-V and Figure 5-14(b) shows horizontal signal of TV-H.

**Figure 5-14(a) TV-V****Figure 5-14(b) TV-H**

The figure 5-15 shows the examples of TV polarity synchronization signals.

Note: This oscilloscope synchronizes with only (┐┘) synchronizing signal.

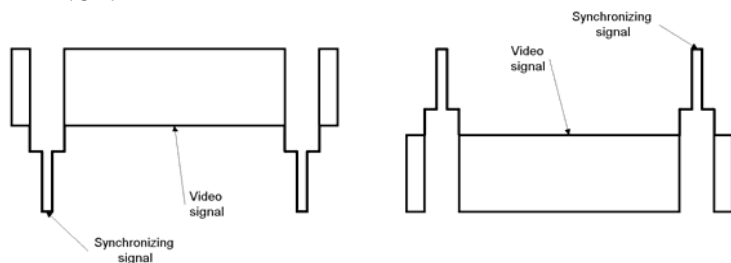
REFERENCE:**Figure 5-15 TV Signal****5-6. Digital Storage Functions**

The operation procedure of the digital storage functions is described below.

Normal Sampling mode (SMPL)

- 1) Display the waveform to be stored in the REAL TIME mode.
- 2) Press the STORAGE pushbutton switch and the RUN LED is on.
- 3) In this mode, a waveform is swept every trigger according to the setting state of controls on the front panel, the waveform to be stored is displayed on the CRT as it is. The slower the sweep rate, the longer the time is required for the acquisition and display of the waveform. It takes approximately 3 seconds until a waveform is acquired at the sweep range of 0.1s/DIV. The trigger signal is generated thereafter. Therefore, when the sweep rate is slow, the waveform is not displayed on the CRT immediately after the controls on the front panel have been adjusted.
- 4) When the TIME/DIV control is from 1 μ s/DIV to 0.1s/DIV, both the single and the repetitive waveforms can be stored.

Equivalent Sampling Mode (EQU)

When the TIME/DIV control knob is set to 0.2 μ s/DIV to 0.5 μ s/DIV (2 steps), only the repetitive waveform can be stored in the equivalent sampling mode.

The first (left end) rising and falling edges of the traces may not be displayed in the repeat mode range. In this case, measure the rising or falling edge on the second or later cycles of the waveform.

It takes 5 seconds or more to store the input signal of 1kHz or lower. When the low frequency signal is stored, noise can be mixed. It is recommended to use a sine wave of 1MHz or higher or a square wave with the rise time which is faster than 0.3 μ s.

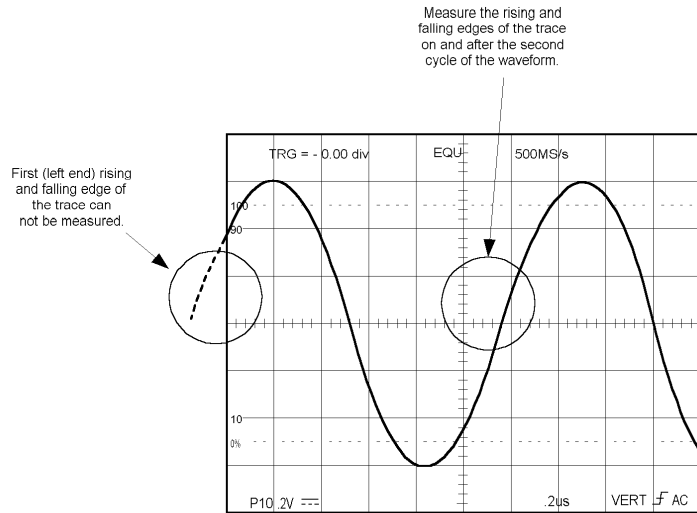

Figure 5-16

ROLL mode

The displayed waveform is rolled from right to left (0.2s/DIV to 100s/DIV). The right end of each trace is the updating point of a new data. The Roll mode facilitates the measurement of a signal of approximately 100Hz or lower. Press the STOP switch to stop the ROLL mode and hold the final waveform on the CRT.

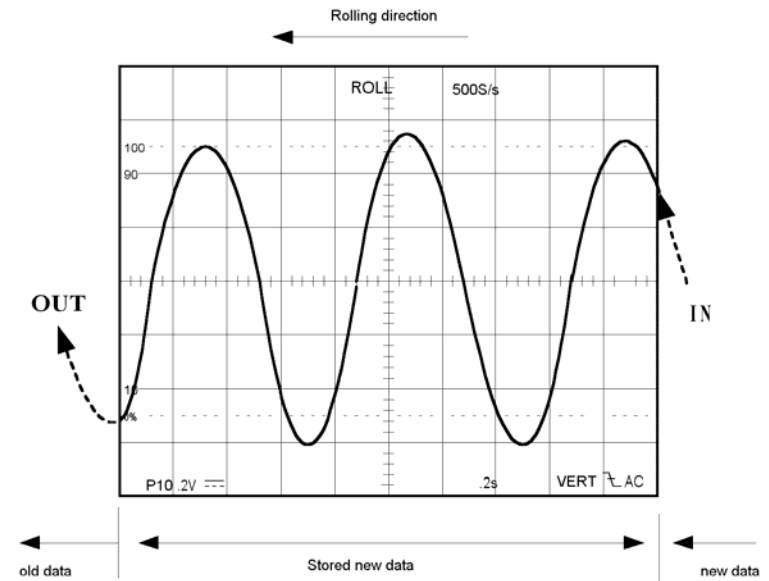

Figure 5-17

NOTE:**Aliasing:**

While measuring the signal in such STORAGE mode as SMPL, AVG, etc., the aliasing can be occurred by inputting a signal of more than half of the frequency with respect to the sample clock frequency at the sweeping range is added.

When the aliasing is occurred, the waveform of the input signal frequency minus the sample clock frequency will be displayed. It is possible that this display is judged a current waveform. If the aliasing is suspected, select the REAL TIME mode and check if the display is the same as that in the actual operation mode.

PRE-TRIGGER

Measure the waveform before the trigger point.

Although a conventional oscilloscope displays the trigger point only at the left end of the screen since the sweep starts at the trigger point of the signal, the instrument can display the trigger point anywhere on the screen in 0.1DIV steps, using the PRE-TRIGGER function in the STORAGE mode, so that it is possible to measure the waveform before the trigger point precisely.

- 1) When the MENU and CURSOR functions are off, the position of the trigger point is displayed.
- 2) The position of the trigger point is set by the VARIABLE control knob.
- 3) For example, in the case of 4.0DIV setting, the signal before the rising edge of the waveform (the triggered point) can be observed as shown in Figure 5-18 below.

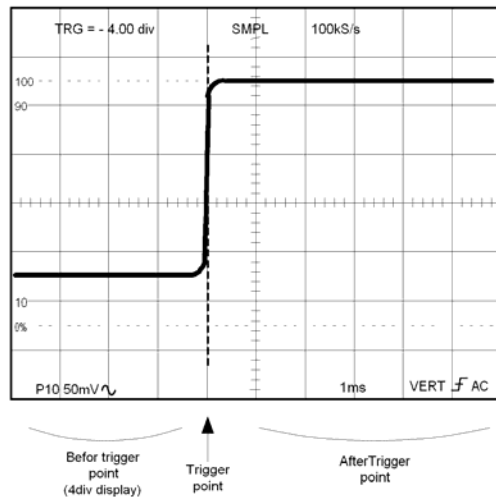

Figure 5-18

MENU

The acquisition mode, the on-off settings of the waveform smoothing, the interpolation method in the horizontal magnification mode, the save and recall memory can be selected by the MENU pushbutton.

Each time when the MENU pushbutton is pressed, the readout displays at the top right of the CRT in the sequence as follows:

MENU 1: "acquisition mode"

MENU 2: SMOOTH

MENU 3: INTRPL

MENU 4: SAVE

MENU 5: RECALL

OFF

1) Select acquisition mode

When the "MENU 1: acquisition" mode is displayed at the top right of the CRT, the selection of acquisition mode can be set.

M E N U 1 : P A K

Acquisition mode

Setting marker by VARIABLE

SMPL: Normal Sampling

PEAK: Peak Detect

PERSIST: Persistence Display

ENVELOPE: Envelope Display

AVERAGE: 2~256 times

The Acquisition mode is selected by the VARIABLE control knob. Acquisition is the process of sampling for the analog input signal, converting it into digital format afterward and assembling it into a waveform record finally.

SMPL(0.1s~1 μ s/div)

In normal sampling mode, the instrument generates a record point by saving the first sample during each acquisition interval.

PEAK(100s~5 μ s/div at one channel, 0.5ms~5 μ s/div at two channels)

The peak detect mode stores the minimum and maximum values (pairs) for each time bucket. This mode is capable of detecting glitches of 25ns or more regardless of the sweep rate.

PERSIST(0.1s ~0.2 μ s/div)

The persistence mode displays the minimum and maximum values mutually in the normal sampling and initialization by changing the TIME/DIV control knob. This mode can acquire and display a waveform record that shows the total variation over entire acquisition.

ENVELOP (0.1s ~5 μ s/div at one channel, 0.5ms~5 μ s/div at two channels)

The Envelope mode activates both peak detect and persistence mode. This mode monitors signal variations over time. You can measure interference signals, jitter, amplitude modulated signals and more.

AVERAGE (0.1s ~0.2 μ s/div)

In the Average mode, pressing the VARIABLE control knob to set the number of average, turning the knob clockwise to change the number from 2 to 4-8-16-32-64-128-256 and turning the knob counter-clockwise to change the number in the reverse order, the average waveform is displayed after the data of the set sweep number has been acquired. When the number of average is 16, the data is acquired 16 times (the RUN LED blinks 16 times). Thus, the non-repetitive signal affected by asynchronous noise can be picked up. The average operation is performed by setting the number of average. In the ROLL mode, the average operation is not performed.

2) Smoothing selection mode

When the “MENU 1: SMOOTH” is displayed at the top right of the CRT, the smoothing is made on and off.

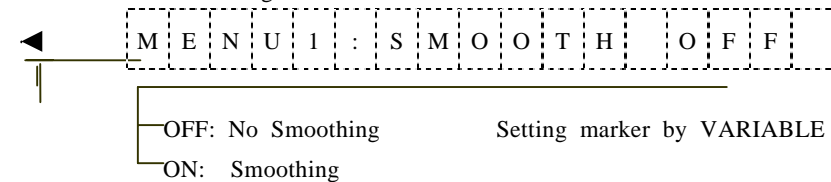

In case of OFF, the storage waveform is displayed by dots, while changing to ON, the dots are connected smoothly as result of a smooth waveform display.

When the sampling frequency is low with respect to the input signal frequency (when the signal of more than 5 cycles per division is connected), the amplitude to be display may be small. In this case, set the smoothing mode to OFF to display the waveform of the similar amplitude with the input signal. The setting can be done by the VARIABLE control knob.

3) Interpolation Method Selection mode

When the “MENU 3: INTRPL” is displayed at the top right of the CRT, THE interpolation Method can be selected.

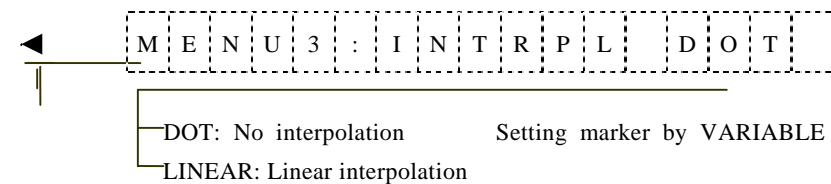

The mode selection is made by the VARIABLE control knob. The interpolation method is how to interpolate the magnified data while magnifying the display waveform in the horizontal direction (except for the SAVE/RECALL reference waveform). In the case of DOT, the

waveform is magnified as is in the horizontal direction.

In the case of LINEAR, the data is interpolated linearly, and the waveform is displayed smoother than at DOT. This is effective for a square wave or sine wave.

4) Save reference memory setting mode

When the “MENU 4: SAVE” is displayed at the top right of the CRT, the save reference memory can be selected.

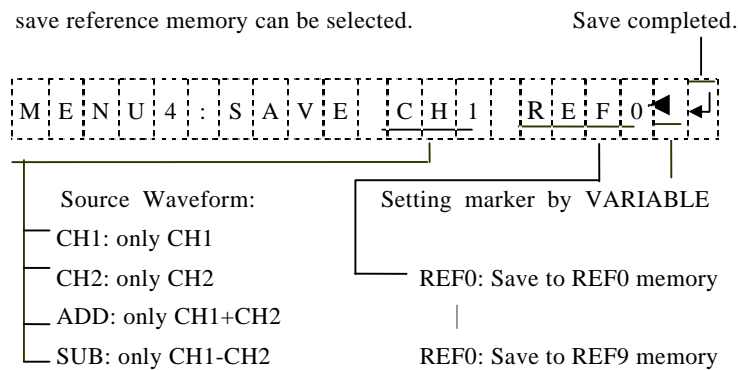

The source waveform is automatically switched by vertical mode. When both CH1 and CH2 are active, pressing the VARIABLE control knob to select the source waveform between CH1 and CH2.

Turning The VARIABLE control knob clockwise to change the number of reference memory from REF0 to REF9 and turning the knob counterclockwise to change the number in the reverse order.

When the source waveform and the number of reference memory are established, pressing the SAVE pushbutton to write the source waveform in the memory and indicate the associated readout information of “↵”.

5) RECALL reference

When the “MENU5:RECALL” is displayed at the top right of the CRT, the recall reference memory can be selected.

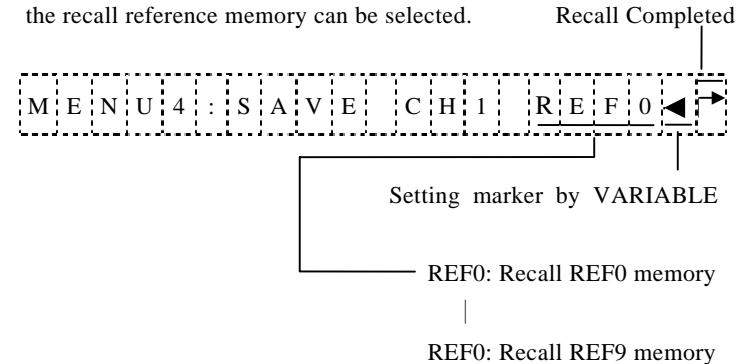

Turning the VARIABLE control knob clockwise to change the number of reference memory from REF0 to REF9 while turning the knob counterclockwise to change the number in the reverse order.

+Recall the waveform on the CRT by pressing the RECALL pushbutton, the readout then indicates the associated readout information of “↵”. When this pushbutton is pressed again, the displayed waveform will be removed.

5-7.Measurement Application

The oscilloscope has a cursor measurement system for making accurate, direct-readout voltage, time and frequency measurements. The measurements described in this section are examples of typical applications using this measurement system. After becoming familiar with the controls, indicators, and capabilities of the instrument, you can develop convenient methods to make the special measurement for your own applications.

Proceed a measurement by using the cursor according to the following steps:

1. Press the [ΔV — ΔT , 1/ ΔT —OFF] pushbuttons to turn on the cursor and measurement readout.

2. Press the pushbutton to select the seven measurement function in the sequence as below:

ΔV — ΔT — 1/ ΔT — OFF

3. Press the [C1—C2 TRK] pushbutton to select C1 cursor, C2 cursor and tracking cursor.

4. Rotate the VARIABLE control knob to position selected cursor. Press one of the VARIABLE control knob to select FINE or COARSE cursor move speed.

5. Read the measurement value on the screen. Typical measurement readouts and applications are shown in Figure 5-16. The measurement values are automatically controlled by the VOLTS/DIV and TIME/DIV control settings.

Figure 5-19: Cursor Measurement

(a).Typical ΔV (Voltage difference) for AC voltage.

When both CH1 and CH2 are turned on, the measurement value of CH1($\Delta V1$).

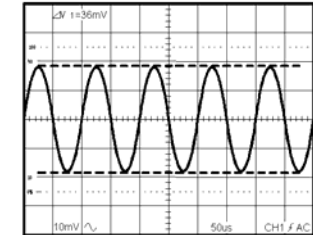

(b).Typical ΔT (Time difference) cursor measurement for rise time.

Proceed rise-time or fall-time measurement requiring some additional signal scaling by using the graticule rise-time measurement aids. Number 0%, 10, 90 and 100 are etched near the left vertical graticule line. Use the following steps as a guideline to in making rise-time measurement:

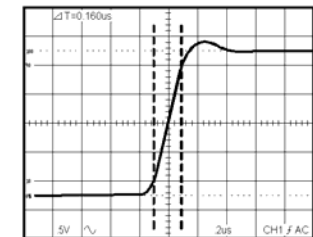

(c).Typical 1/ ΔT cursor function for frequency measurement.

When the two cursors are superimposed at two edge points of the one period waveform by the [C1—C2 TRK] and VARIABLE controls, the measurement value is displayed in frequency units on the upper side of the screen.

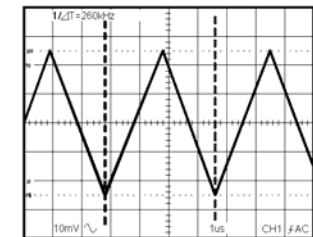

NOTE. When the VOLTS/DIV or the TIME/DIV controls are in uncalibrated setting, the ΔV and ΔT measurement values will be displayed with divisions.

When the vertical mode is set to the ADD mode, and the CH1 and CH2 VOLTS/DIV controls are set to different scales, the ΔV measurement values will be displayed with divisions.

5-8 RS-232 Interface –Remote Control

5-8-1. RS-232 Configuration

The GRS-6052A/6032A contains a DB 9-pin, male RS-232 connector for serial communication with a computer or terminal. The GRS-6052A/6032A RS-232 interface is configured as an RS-232 “*Data Terminal Equipment*” so that data is sent from pin 3 and received on pin 2. For remote controls, the RS-232 interface has to be connected with a computer or terminal.

Pin Assignments

The pin assignments for RS-232 interface of GRS-6052A/6032A are listed below.

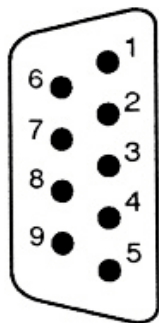

1. No connection
2. Receive Data (RxD) (input)
3. Transmit Data (TxD) (output)
4. No connection
5. Signal Ground (GND)
6. No connection
7. No connection
8. No connection
9. No connection

Figure 5-20. Pin assignments of the RS232 connector on the rear panel for DB-9-D

DB9 to DB9 Wiring

The wiring configuration is used for computer with DB9 connectors that configured as Data Terminal Equipment.

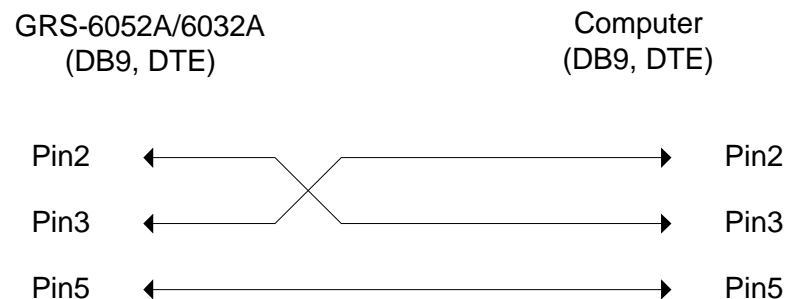

Figure 5-21. DB9 to DB9 wiring

When the GRS-6052A/6032A is set up with a RS232 interface, please check the following points:

- Do not connect the output line of one DTE device to the output line of the other.
- Many devices require a constant high signal on one or more input pins.
- Ensure that the signal ground of the equipment is connected to the signal ground of the external device.
- Ensure that the chassis ground of the equipment is connected to the chassis ground of the external device.
- Do not use more than 15m of cable to connect devices to a PC.
- Ensure the same configurations are used on the device as the one used on PC terminal.
- Ensure the connector for the both side of cable and the internal connected line are met the demand of the instrument.

Communication Mode

The same baud rate and data format must be set to the instrument and the computer.

The baud rate of the RS-232 interface can be set as listed in the following table.

300	Baud	900	Baud	1200	Baud
2400	Baud	4800	Baud	9600	Baud

The data transmission format is N-8-1 (no parity bit, 8 data bits, 1 stop bits).

Computer's Connection

A personal computer with a COM port is the essential facility in order to operate the instruction via RS232 interface.

The connections between GRS-6052A/6032A and computer are as follows:

- 1) Connect one end of a RS232 cable to the computer.
- 2) Connect the other end of the cable to the RS232 port on the GRS-6052A/6032A.
- 3) Turn on the GRS-6052A/6032A.
- 4) Turn on the computer.

The RS232 connection testing

If you want to test whether the RS232 connection is working or not, you can send a command from computer. For instance, using a terminal program send the query command (uppercase)

* IDN?

should return the Manufacturer, model number, serial number and firmware version in the following format:

GW,GRS60X2A,V.1.10

If you do not receive a proper response from the GRS-60X2A, please check if the power is on, the RS232 configurations are the same on both sides, and all cable connections are active.

5-8.2. RS-232 Remote Control

Command Syntax

All commands syntax is **ASCII** format. If you want to transfer any of the instructions to an instrument, there are five basic elements must be included.

- *Command header:*

Distinguish commands

- *Command type:*

Equal mark (=): Sets instrument state

Question mark (?): Queries instrument state

- *Parameter (if required)*

Instrument states value

- *Target (if required)*

Some commands need to be assigned specific channel

- *Message terminator or separator*

Command Header	Command Type	Parameter	Target	Message terminator or separator
2 bytes	1 byte	3 bytes	1 byte	1 byte

Here are some valid examples remote control commands (**not including message terminator**):

V 1 = 0 1 0 A

H 4 = 0 0 1

M2?

* I D N ?

The following example includes the header, type, value for the parameter, and target
(This command will set channel 1 vertical gain at 20mV/DIV):

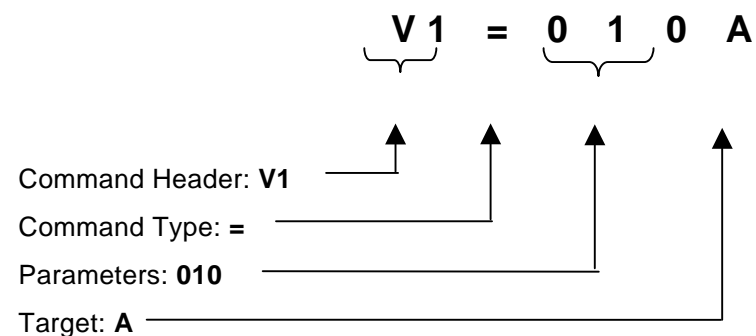

Note: The GRS-60X2A is sensitive to the case of command characters. All of the commands are uppercase.

Message Terminator and Message Separator

As there is no signal of end message on RS232 bus, therefore use **LF** (Line Feed, 0x0A) as message terminator. When a series of commands are sent to the instrument, it must add a LF to be a judgment for message terminator. As for query command, the return message of the instrument is also added a LF for PC to judge message terminator.

A semicolon separates one command from another when the commands appear on the same line.

Return Data Format

If instrument received question mark (?) at the third byte (command type) of the command, it will answers 3 bytes value in **ASCII** format and 1 byte message terminator of LF (0x0A).

The following example ask the Time base scale, and instrument will return 010 (.1s/DIV):

Example: **H 1 ?** (ASCII)

Return: **0 1 0** (3 bytes, ASCII format)

If instrument receives **WA?-WD?**. It will return **1000 bytes** channel 1, channel 2 or 2 recalled waveforms data in **Binary** format and **1 byte** message terminator.

Example: **W A ?** (ASCII)

Return:

1000 bytes waveform data				Message terminator
0x01	0x05	0x09	0x0A

If instrument receives **W0?-W9?**. It will return **3 bytes** waveform information, **1000 bytes** waveforms data in **Binary** format and **1 byte** message terminator.

Example: **W 5 ?** (ASCII)

Return:

VAR	Vertical scale	Horizontal scale	1000 byte waveform data	Message terminator
0x01	0x05	0x10	0x01, 0x05,.....,0x09	0x0A

VAR=0: Vertical VAR function disable.

VAR=1: Vertical VAR function enable.

Vertical scale: 1-14(20V/DIV – 1mV/DIV).

Horizontal scale: 10-27(.1s/DIV - .2us/DIV).

Combining Commands

You can use a semicolon (;) to combine commands and queries. The GRS-60X2A executes coherent commands in the order it receives them. When you coherent queries, the GRS-60X2A combine the responses into a single response message. For example, if the channel 1 display is ON (001) and horizontal time base scale equals to 1ms/DIV (016), the query commands (must add 1 byte message terminator)

V 3 ? A ; H 1 ?

Instrument will return the message

0 0 1 0 1 6

Buffer Size

The command receive buffer of instrument is 128 bytes. The return message buffer of instrument is 1024 bytes.

If your combining commands size is larger than 128 bytes, commands will be lost.

If you query the waveform data (WA? or WB?), the instrument will return 1000 bytes waveform data. Do not use any query commands during the data transmission.

Command List

Note: Every command must add 1 byte message terminator of LF (0x0A).

<i>Function</i>	Transmission Format
<i>*IDN?</i>	*IDN?
<i>*CLR</i>	*CLR
<i>*ULK</i>	*ULK
<i>*RST</i>	*RST
<i>Vertical Scale</i>	V1=<Parameters (3bytes)><Target (1byte)> V1? <Target (1byte)>
<i>Input Coupling</i>	V2=<Parameters (3bytes)><Target (1byte)> V2? <Target (1byte)>
<i>Display</i>	V3=<Parameters (3bytes)><Target (1byte)> V3? <Target (1byte)>
<i>Probe</i>	V4=<Parameters (3bytes)><Target (1byte)> V4? <Target (1byte)>
<i>V-VAR</i>	V5=<Parameters (3bytes)><Target (1byte)> V5? <Target (1byte)>
<i>Invert</i>	V6=<Parameters (3bytes)> V6?
<i>ADD</i>	V7=<Parameters (3bytes)> V7?

<i>ALT/CHOP</i>	V8=<Parameters (3bytes)> V8?
<i>Horizontal Scale</i>	H1=<Parameters (3bytes)> H1?
<i>Pre-trigger Position</i>	H2=<Parameters (3bytes)><Target (1byte)> H2?
<i>H-VAR</i>	H3=<Parameters (3bytes)> H3?
<i>XY Mode</i>	H4=<Parameters (3bytes)> H4?
<i>Sweep Magnification</i>	H5=<Parameters (3bytes)> H5?
<i>MAG-ALT</i>	H6=<Parameters (3bytes)> H6?
<i>Trigger Mode</i>	T1=<Parameters (3bytes)> T1?
<i>Trigger Source</i>	T2=<Parameters (3bytes)> T2?
<i>Trigger Couple</i>	T3=<Parameters (3bytes)> T3?
<i>TV Trigger</i>	T4=<Parameters (3bytes)> T4?

<i>Trigger Slope</i>	T5=<Parameters (3bytes)> T5?
<i>Dump Waveform</i>	WA? WB? WC? WD? W [0-9] ?
<i>Smooth</i>	M1=<Parameters (3bytes)> M1?
<i>Average</i>	M2=<Parameters (3bytes)> M2?
<i>MAG Interpolation</i>	M3=<Parameters (3bytes)> M3?
<i>Acquisition Mode</i>	M4=<Parameters (3bytes)> M4?
<i>Real-time/ Storage</i>	O1=<Parameters (3bytes)> O1?
<i>RUN/STOP</i>	O2=<Parameters (3bytes)> O2?
<i>Text Intensity</i>	O3=<Parameters (3bytes)> O3?
<i>Illumine Intensity</i>	O3=<Parameters (3bytes)> O3?

Details of Command Reference

Each command in this chapter will give a brief description. The examples of each command will be provided and what query form might return.

Note: Every command must add 1 byte message terminator of LF (0x0A).

Common Commands***IDN?**

*	I	D	N	?
---	---	---	---	---

Queries the unique identification code of instrument

Return: GW,GRS60X2A,V.1.10

***CLR**

*	C	L	R
---	---	---	---

Clear the output buffer data of instrument

***ULK**

*	U	L	K
---	---	---	---

Unlock front panel control

***RST**

*	R	S	T
---	---	---	---

Load factory default setting into instrument

Vertical Controls Commands**Vertical Scale**

V	1	=	Parameters (3Bytes)	Target
---	---	---	---------------------	--------

V	1	?	Target
---	---	---	--------

Sets or queries the vertical gain of the specific channel.

Syntax

V1=010A

V1?B

Arguments

Parameters:

001→20V/DIV	002→10V/DIV	003→5V/DIV	004→2V/DIV
005→1V/DIV	006→.5V/DIV	007→.2V/DIV	008→.1V/DIV
009→50mV/DIV	010→20mV/DIV	011→10mV/DIV	012→5mV/DIV
013→2V/DIV	014→1mV/DIV		

Target:

A→Channel 1

B→Channel 2

Input Coupling

V	2	=	Parameters (3Bytes)	Target
---	---	---	---------------------	--------

V	2	?	Target
---	---	---	--------

Sets or queries the input coupling states.

Syntax

V2=001B

V2?A

Arguments

Parameters:

000→Place scope in DC coupling state

001→Place scope in AC coupling state

002→Place scope in grounding state

Target:

A→Channel 1

B→Channel 2

Display

V	3	=	Parameters (3Bytes)	Target
---	---	---	---------------------	--------

V	3	?	Target
---	---	---	--------

Sets or queries the channel's display.

Syntax

V3=001A

V3?B

Arguments

Parameters:

000→Disable channel display

001→Enable channel display

Target:

A→Channel 1

B→Channel 2

Probe

V	4	=	Parameters (3Bytes)	Target
---	---	---	---------------------	--------

V	4	?	Target
---	---	---	--------

Sets or queries the probe attenuation factor.

Syntax

V4=001B

V4?A

Arguments

Parameters:

000→1X

001→10X

Target:

A→Channel 1 B→Channel 2

V-VAR

V	5	=	Parameters (3Bytes)	Target
---	---	---	---------------------	--------

V	5	?	Target
---	---	---	--------

Sets or queries the vertical VAR function of the specified channel.

Syntax

V5=071A

V5=?B

Arguments

Parameters:

001 (uncalibrated, Max) to 71 (uncalibrated, Min) →Enable vertical VAR function and sets VAR value.

000 (calibrated) →Disable vertical VAR function.

Target:

A→Channel 1 B→Channel 2

Invert

V	6	=	Parameters (3Bytes)
---	---	---	---------------------

V	6	?
---	---	---

Sets or queries the invert function.

Syntax

V6=001

V6?

Arguments

Parameters

000→Disable invert function

001→Enable invert function

ADD

V	7	=	Parameters (3Bytes)
---	---	---	---------------------

V	7	?
---	---	---

Sets or queries the addition function.

Syntax

V7=001

V7?

Arguments

Parameters:

000→Disable the addition function

001→Enable the addition function

ALT/CHOP

V	8	=	Parameters (3Bytes)
---	---	---	---------------------

V	8	?
---	---	---

Sets or queries the ALT/CHOP mode.

Syntax

V8=001

V8?

Arguments

Parameters:

000→ALT mode

001→CHOP mode

Horizontal Controls Commands**Horizontal Scale**

H	1	=	Parameters (3Bytes)
---	---	---	---------------------

H	1	?
---	---	---

Sets or queries the horizontal time base scale.

Syntax

H1=010

H1?**Arguments**

Parameters:

001→100s/DIV

002→50s/DIV

003→20s/DIV

004→10s/DIV

005→5s/DIV

006→2s/DIV

007→1s/DIV

008→.5s/DIV

009→.2s/DIV

010→.1s/DIV

011→50ms/DIV

012→20ms/DIV

013→10ms/DIV

014→5ms/DIV

015→2ms/DIV

016→1ms/DIV

017→.5ms/DIV

018→.2ms/DIV

019→.1ms/DIV

020→50us/DIV

021→20us/DIV

022→10us/DIV

023→5us/DIV

024→2us/DIV

025→1us/DIV

026→.5us/DIV

027→.2us/DIV

Pre-trigger Position

H	2	=	Parameters (3Bytes)	Target
---	---	---	---------------------	--------

H	2	?	Target
---	---	---	--------

Sets or queries the horizontal pre-trigger position.

Syntax

H2=300A

H2=100B

H2?

Arguments

Parameters:

If Target=A, Parameter range→0 (0 DIV) to 500 (-10DIV)

If Target=B, Parameter range→0 (0DIV) to 200 (4 DIV)

Target:

A→Pre

B→Post

H-VAR

H	3	=	Parameters (3Bytes)
---	---	---	---------------------

H	3	?
---	---	---

Sets or queries the horizontal VAR function.

Syntax

H3=128

H3?

Arguments

Parameters:

080 (uncalibrated, Max) to 255 (uncalibrated, Min) →Enable horizontal VAR function and sets VAR value

000 (calibrated) →Disable horizontal VAR function

XY Mode

H	4	=	Parameters (3Bytes)
---	---	---	---------------------

H	4	?
---	---	---

Sets or queries the XY mode

Syntax

H4=001

H4?

Arguments

Parameters:

000→Disable XY mode

001→Enable XY mode

Sweep Magnification

H	5	=	Parameters (3Bytes)
---	---	---	---------------------

H	5	?
---	---	---

Sets or queries the MAG function.

Syntax

H5=002

H5?

Arguments

Parameters:

000→MAG Disable 001→X5
 002→X10 003→X20

MAG-ALT

H	6	=	Parameters (3Bytes)
---	---	---	---------------------

H	6	?
---	---	---

Sets or queries the MAG-ALT mode

Syntax

H6=001

H6?

Arguments

Parameters:

000→Disable MAG-ALT mode

001→Enable MAG-ALT mode

Trigger Commands**Trigger Mode**

T	1	=	Parameters (3Bytes)
---	---	---	---------------------

T	1	?
---	---	---

Sets or queries trigger mode

Syntax

T1=001

T1?

Arguments

Parameters:

000→Auto trigger mode

001→Normal trigger mode

002→Single trigger mode

Trigger Source

T	2	=	Parameters (3Bytes)
---	---	---	---------------------

T	2	?
---	---	---

Sets or queries the trigger source

Syntax

T2=001

Waveform Data Commands**Dump Waveform**

W	A	?
---	---	---

Dump channel 1 waveform data

W	B	?
---	---	---

Dump channel 2 waveform data

W	C-D	?
---	-----	---

Dump 2 recalled waveform data

W	0-9	?
---	-----	---

Dump REF 0-9 waveform data

Syntax

WA?

W5?

Note: GRS 60x2A can't return waveform data in real-time mode or in roll mode(100s/DIV to .2s/DIV) of storage mode.

Menu Commands**Smooth**

M	1	=	Parameters (3Bytes)
---	---	---	---------------------

M	1	?
---	---	---

Sets or queries the waveform smooth function

Syntax

M1=001

M1?

Arguments

Parameters:

000→Disable Smooth function

001→Enable Smooth function

Average

M	2	=	Parameters (3Bytes)
---	---	---	---------------------

M	2	?
---	---	---

Sets or queries the waveform average function.

Syntax

M2=006

M2?

Arguments

Parameters:

000→Disable average function

001→Average number is 2 002→Average number is 4

003→Average number is 8 004→Average number is 16

005→Average number is 32 006→Average number is 64

007→Average number is 128 008→Average number is 256

MAG Interpolation:

M	3	=	Parameters (3Bytes)
---	---	---	---------------------

M	3	?
---	---	---

Sets or queries the MAG interpolation function

Syntax

M3=001

M3?

Arguments

Parameters:

000→Dot mode 001→Linear mode

Acquisition Mode:

M	4	=	Parameters (3Bytes)
---	---	---	---------------------

M	4	?
---	---	---

Sets or queries the Acquisition Mode

Syntax

M4=001

M4?

Arguments

Parameters:

001→Normal sampling mode 002→Peak detect mode

003→Persistence mode 004→Envelope mode

005→Average mode

Other Commands

Real-Time/Storage mode:

O	1	=	Parameters (3Bytes)
---	---	---	---------------------

O	1	?
---	---	---

Sets or queries the instrument operation mode.

Syntax

O1=001

O1?

Arguments

Parameters:

001→Real-Time mode 000→Storage mode

Run/Stop:

O	2	=	Parameters (3Bytes)
---	---	---	---------------------

O	2	?
---	---	---

Sets or queries the waveform Run/Stop function

Syntax

O2=001

O2?

Arguments

Parameters:

000→Stop 001→Run

Text intensity

O	3	=	Parameters (3Bytes)
---	---	---	---------------------

O	3	?
---	---	---

Sets or queries the text intensity

Syntax

O3=030

O3?

Arguments

Parameters:

000→Disable text display 001 (Min) to 060 (Max)→Text intensity

Illumine intensity

O	4	=	Parameters (3Bytes)
---	---	---	---------------------

O	4	?
---	---	---

Sets or queries the illumine intensity

Syntax

O4=125

O4=00?

Arguments

Parameters:

000→Disable illumine display 001 (Min) to 240 (Max)→Illumine intensity

6. MAINTENENCE

The instructions below are executed by qualified personnel only. To avoid electrical shock, do not perform any servicing other than the operating instructions unless you are qualified to do so.

6-1. Fuse Replacement

If the fuse blows, the power lamp indicators will not light and the oscilloscope will not start. The fuse should not normally open unless a problem has developed in the unit. Try to determine and correct the cause of the blown fuse and replace only with a fuse of the correct rating and type on the rear panel.



WARNING. For continued fire protection. Replace fuse only with 250V fuse of the specified type and rating, and disconnect power cord before replacing fuse.

6-2. Line Voltage Conversion

The primary winding of the power transformer is tapped to permit operation from 100, 120, or 230VAC 50/60Hz line voltage. Conversion from one line voltage to another is done by changing the line voltage selector switch as shown in page 9. The rear panel identifies the line voltage to which the unit was factory set. To convert to a different line voltage, perform the following procedure:

- (1). Make sure the power cord is unplugged.
- (2). Adjust the line voltage selector switch to the desired line voltage position.
- (3). A change in line voltage may also require a corresponding change of fuse value. Install the correct fuse value as listed on rear panel.

6-3. Cleaning

To clean the oscilloscope, use a soft cloth dampened in a solution of mild detergent and water. Do not spray cleaner directly onto the oscilloscope because it may leak into the cabinet and cause damage.

Do not use chemicals containing benzine, benzene, toluene, xylene, acetone, or similar solvents. Do not use abrasive cleaners on any portion of the oscilloscope.

7. Block Diagram

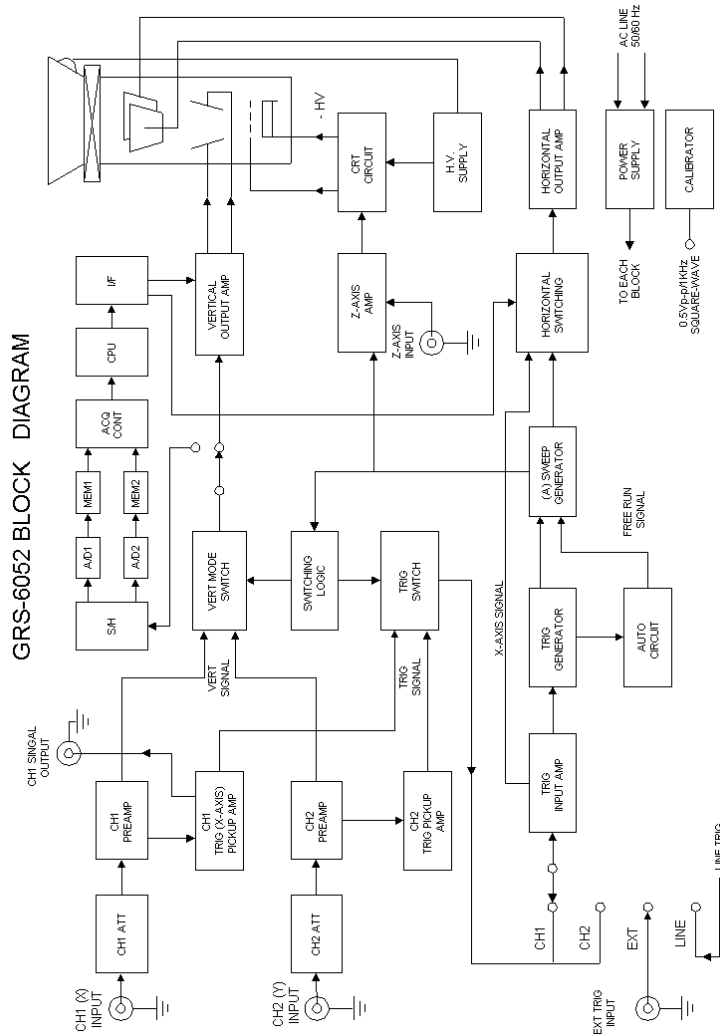



205 Westwood Ave
Long Branch, NJ 07740
1-877-742-TEST (8378)
Fax: (732) 222-7088
salesteam@Tequipment.NET