

3.0GHz Spectrum Analyzer

GSP-830

USER MANUAL

GW INSTEK PART NO. 82SP-83000MA1



ISO-9001 CERTIFIED MANUFACTURER

GW INSTEK

This manual contains proprietary information, which is protected by copyrights. All rights are reserved. No part of this manual may be photocopied, reproduced or translated to another language without prior written consent of Good Will company.

The information in this manual was correct at the time of printing. However, Good Will continues to improve products and reserves the rights to change specification, equipment, and maintenance procedures at any time without notice.

Windows is a registered trademark of Microsoft Corporation in the United States and other countries.

Good Will Instrument Co., Ltd.

No. 7-1, Jhongsing Rd., Tucheng City, Taipei County 236, Taiwan.

Table of Contents

SAFETY INSTRUCTIONS	6
Safety Symbols	6
Safety Guidelines	6
GETTING STARTED	9
GSP-830 Characteristics	10
Package Contents	11
Front Panel Overview	13
Rear Panel Overview	16
Display Overview	18
Tilt Stand & Power Up	20
Error Check	22
Functionality Check	23
QUICK REFERENCE	25
Operation Shortcuts	26
Menu Tree	31
Preset Contents	40
FREQUENCY/SPAN	41
View Signal (Center and Span)	42
View Signal (Start and Stop)	44
Full/Zero Span	46
Recall the Last Span Setting	47
AMPLITUDE	48
Set Vertical Scale	49
Amplitude Correction	52
Use Pre-Amplifier (Optional)	56
Set Input Impedance	57
AUTOSET	58
How Autoset Works	59
Run Autoset	60
Limit vertical search range	61
Limit horizontal view range	61
MARKER	62
Activate/de-activate marker	63
Move marker	65
Show Markers in Table	67

PEAK SEARCH	68
Search Signal Peak	69
Show Peak Table	71
TRACE	73
View traced waveform	74
Move Marker to Trace	76
Run Trace Math	78
Select Signal Detection Mode	80
POWER MEASUREMENT	82
ACPR Measurement	83
OCBW Measurement	86
N dB Measurement	88
Phase Jitter Measurement	89
LIMIT LINE	90
Edit Limit Line	91
Run Pass/Fail test	94
BANDWIDTH	95
Select RBW (Resolution BandWidth)	96
Select VBW (Video BandWidth)	98
RBW/VBW Auto Mode Contents	99
Set Sweep time	101
Average Waveform	101
TRIGGER	103
Select Trigger Type	104
Select Trigger Mode	105
Set Trigger Delay	106
DISPLAY	107
Change Display Brightness	108
Activate Display Line	108
Enter Display Title	109
Use Split Display	110
Use VGA Output	111
Save Display Image to USB Flash Drive	111
FILE	113
File Location and File Type	114
Copy File	115
Delete File	118
Rename File	120

Save Display Image to USB Flash Drive.....	121
PRESET.....	123
SYSTEM.....	124
Save/Recall Panel Setting	125
Configure Communication Interface	126
View System Information	128
Set Date/Time.....	132
Synchronize GSP-830 with Other Devices.....	133
Select Language	135
Use Auxiliary Signal	135
Enter Service Operation	135
SEQUENCE	136
Edit Sequence	137
Run Sequence	140
TRACKING GENERATOR	142
DEMODULATOR	144
EMI FILTER.....	146
BATTERY / DC OPERATION	148
Battery Operation.....	148
DC Operation	149
PC SOFTWARE	150
Install Software	151
Connect Software	152
Use Software	154
REMOTE CONTROL	157
Configure Interface	158
Command Syntax	160
Command Set	161
FAQ.....	171
Appendix	172
GSP-830 Specifications	172
Optional Items Specifications.....	174
Declaration of Conformity.....	176
INDEX.....	177

S SAFETY INSTRUCTIONS

This chapter contains important safety instructions that you must follow when operating the GSP-830 and when keeping it in storage. Read the following before operating this instrument to ensure your safety and to keep the GSP-830 in best condition.

Safety Symbols

These safety symbols may appear in this manual or on the GSP-830.



WARNING

Warning: Identifies conditions or practices that could result in injury or loss of life.



CAUTION

Caution: Identifies conditions or practices that could result in damage to the GSP-830 or to other properties.



DANGER High Voltage



Attention Refer to the Manual



Protective Conductor Terminal



Earth (ground) Terminal

Safety Guidelines

General Guideline



CAUTION

- Make sure that the RF input level and the Tracking Generator output reversed power level do not exceed +30dBm.
- Do not supply an input signal to the Tracking Generator output.
- Do not place any heavy object on the GSP-830.
- Avoid severe impacts or rough handling that leads to damaging the GSP-830.
- Do not discharge static electricity onto the GSP-830.

- Use only mating connectors, not bare wires, for the terminals.
- Do not block or obstruct the cooling fan vent opening.
- Do not perform measurement at a power generating source or building installation site (Note below).
- Do not disassemble the GSP-830 unless you are technically qualified.

(Note) EN 61010-1:2001 specifies the measurement categories and their requirements as follows. The GSP-830 falls under category II.

- Measurement category IV is for measurement performed at the source of low-voltage installation.
- Measurement category III is for measurement performed in the building installation.
- Measurement category II is for measurement performed on the circuits directly connected to the low voltage installation.

Power Supply



WARNING

- AC Input voltage: 100 to 240 V AC, 50/60Hz, 90W maximum
- DC Input voltage: 12V DC, 40W maximum
- The power supply voltage should not fluctuate more than 10%.
- Connect the protective grounding conductor of the AC power cord to an earth ground, to avoid electrical shock.

Battery



CAUTION

- Rating: 11.1V lithium-ion battery pack x 2
- Turn off the main power switch before installing or taking out the battery packs.

Fuse



WARNING

- Fuse type: T1.6A/ 250V, time-delay, 5x20mm glass
- To ensure fire protection, replace the fuse only with the specified type and rating.
- Disconnect the power cord before fuse replacement.
- Make sure the cause of fuse blowout is fixed before fuse replacement.

Cleaning the GSP-830

- Disconnect the power cord before cleaning.
- Use a soft cloth dampened in a solution of mild detergent and water. Do not spray any liquid into the GSP-830.
- Do not use chemicals or cleaners containing harsh products such as benzene, toluene, xylene, and acetone.

Operation Environment

- Location: indoor, no direct sunlight, dust free, almost non-conductive pollution (Note below)
- Relative Humidity: < 90%
- Altitude: < 2000m
- Temperature: 18°C to 28°C

Storage Environment

- Location: indoor
- Relative humidity: < 85%
- Temperature: 0°C to 40°C

(Note) EN 61010-1:2001 specifies the pollution degrees and their requirements as follows. The GSP-830 falls under degree 2.

Pollution refers to “addition of foreign matter, solid, liquid, or gaseous (ionized gases), that may produce a reduction of dielectric strength or surface resistivity”.

- Pollution degree 1: No pollution or only dry, non-conductive pollution occurs. The pollution has no influence.
- Pollution degree 2: Normally only non-conductive pollution occurs. Occasionally, however, a temporary conductivity caused by condensation must be expected.
- Pollution degree 3: Conductive pollution occurs, or dry, non-conductive pollution occurs which becomes conductive due to condensation which is expected. In such conditions, equipment is normally protected against exposure to direct sunlight, precipitation, and full wind pressure, but neither temperature nor humidity is controlled.

Power cord for the United Kingdom

When using the GSP-830 in the United Kingdom, make sure the power cord meets the following safety instructions.

NOTE: This lead / appliance must only be wired by competent persons



WARNING: THIS APPLIANCE MUST BE EARTHED

IMPORTANT: The wires in this lead are coloured in accordance with the following code:

Green/ Yellow: Earth
 Blue: Neutral
 Brown: Live (Phase)



As the colours of the wires in mains leads may not correspond with the colour markings identified in your plug/appliance, proceed as follows:

The wire which is coloured Green & Yellow must be connected to the Earth terminal marked with the letter E or by the earth symbol \oplus or coloured Green or Green & Yellow.

The wire which is coloured Blue must be connected to the terminal which is marked with the letter N or coloured Blue or Black.

The wire which is coloured Brown must be connected to the terminal marked with the letter L or P or coloured Brown or Red.

If in doubt, consult the instructions provided with the equipment or contact the supplier.

This cable/appliance should be protected by a suitably rated and approved HBC mains fuse: refer to the rating information on the equipment and/or user instructions for details. As a guide, cable of 0.75mm² should be protected by a 3A or 5A fuse. Larger conductors would normally require 13A types, depending on the connection method used.

Any moulded mains connector that requires removal /replacement must be destroyed by removal of any fuse & fuse carrier and disposed of immediately, as a plug with bared wires is hazardous if engaged in live socket. Any re-wiring must be carried out in accordance with the information detailed on this label.

G ETTING STARTED

This chapter describes the GSP-830 in a nutshell, including its main features, package contents, and front / rear / display panel introduction. After going through the overview, follow the Power-up sequence and Functionality check section to properly setup the GSP-830.



GSP-830 package	GSP-830 Characteristics	10
	Package Contents	11
Panel introduction	Front Panel Overview	13
	Rear Panel Overview	16
	Display Overview.....	18
	Status Icon overview	19
Setup	Tilt stand.....	20
	Power Up.....	20
	Error Check	22
	Functionality Check	23

GSP-830 Characteristics

The GSP-830 is a mid-to-high range digital storage spectrum analyzer suitable for a wide variety of applications, such as production testing, research, and field verification.

Performance	<ul style="list-style-type: none">• Low noise floor: typical -117dBm @1GHz, 3k RBW• Fast sweep: 50ms to 25.6s• Compact size: 330(W) x 170(H) x 340(D) mm• Light weight: approx. 6kg
Features	<ul style="list-style-type: none">• Autoset• 5 markers with delta marker and peak functions• 3 traces• Power measurements: ACPR, OCBW, N-dB, Phase Jitter• Pass/fail test with limit line editing• Split windows with separate settings• Sequence programming (user-defined macro)• 6.4" TFT color LCD, 640 x 480 resolution• Phone output (available in the optional Demodulator)• AC/DC/battery multi-mode power operation
Interface	<ul style="list-style-type: none">• USB host for storage device connection• USB slave/RS232/GPIB(optional) for PC software connection and remote control• Direct VGA display image output• Reference signal input/output for synchronization• External trigger signal input
Optional Items (complete list on the next page)	<ul style="list-style-type: none">• Tracking Generator• Pre-amplifier GAP-801 (10dB typical, 9kHz to 6GHz)• Pre-amplifier GAP-802 (20dB typical, 9kHz to 3GHz)• ± 1ppm stability module• EMI filter with 9kHz/120kHz RBW and 6-dB bandwidth• Battery pack• Demodulator• 300Hz/10kHz/100kHz RBW• GPIB interface

Package Contents

Contact your dealer in case of missing items. The detailed specifications are listed from page 172.

GSP-830

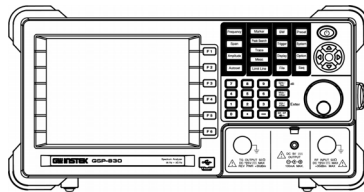

Standard accessories	<ul style="list-style-type: none"> • Power cord • USB cable (Type A to Type B) for PC connection • User Manual (this document)
Optional items	<p>Option01 Tracking Generator (factory installed)</p> <p>Option02 Battery Pack</p> <p>Option03 ± 1ppm Stability Module (factory installed)</p> <p>Option04 300Hz RBW (factory installed)</p> <p>Option05 9kHz & 120kHz RBW (also called EMI Filter, factory installed)</p> <p>Option06 10kHz & 100kHz RBW (factory installed)</p> <p>Option07 Demodulator (factory installed)</p> <p>Option08 GPIB Interface (factory installed)</p> <p>Note: Among Option 05, 06, and 07, only one can be installed at a time.</p>
Optional accessories	<p>ADP-001 BNC(J/F) to N(P/M) Adaptor</p> <p>ADP-002 SMA(J/F) to N(P/M) Adaptor</p> <p>ADP-101 BNC(J/F)75 Ω to BNC(P/M)50 Ω Adaptor</p> <p>ATA-001 BNC Antenna</p> <p>ATN-100 10dB Attenuator N(J/F)-N(P/M)</p> <p>GAK-001 Terminator 50 Ω N(P/M)</p> <p>GAK-002 Cap with Chain N(P/M)</p> <p>GAP-801 Pre-Amplifier, 9kHz to 6GHz, 10dB typical</p> <p>GAP-802 Pre-Amplifier, 9kHz to 3GHz, 20dB typical</p>

GKT-001 General Kit Set

ADP-002: SMA (J/F) to N (P/M) Adaptor x 2

ATN-100: 10dB Attenuator x 1

GTL-303: RF Cable Assembly (RD316, SMA(P),60cm) x2

GSC-002: Kit box

GKT-002 CATV Kit Set

ADP-001: BNC (J/F) to N (P/M) Adaptor x 2

ADP-101: BNC(P/M) 50 Ω to BNC(J/F) 75 Ω adaptor x2

GTL-304: RF Cable Assembly (RG223,N(P)-N(J),30cm) x2

GSC-003: Kit box

GKT-003 RLB Kit SetGAK-001: Termination, N(P), 50 Ω x 1

GAK-002: Cap with Chain, N(P) x 1

GTL-302: RF Cable Assembly (RG223, N(P), 30cm) x2

GSC-004: Kit box

GKT-006 EMI Probe Set

ADP-01: Adaptor, BNC(J/F) - N(P/M) x 1

ADP-02: Adaptor, SMA(J/F) – N(P/M) x 1

ANT-01: 6cm Loop, H-Field Probe x 1

ANT-02: 3cm Loop, H-Field Probe x 1

ANT-03: 6mm Loop, H-Field Probe x 1

PR-03: Touch Passive Probe, < 3GHz x 1

Test Lead: RF Cable Assembly BNC(P/M)-BNC(P/M)x1

Test Lead: RF Cable Assembly SMA(P/M)-SMA(P/M)x1

GRA-404 19 Inch Rack Adaptor Panel, 4U

GSC-001 Soft Carrying Case

GTL-301 RF Cable Assembly, RG223, N(P/M), 1000mm

GTL-302 RF Cable Assembly, RG223, N(P/M), 300mm

GTL-303 RF Cable Assembly, RD316, SMA(P/J), 600mm

GTL-304 RF Cable Assembly, RG223, N(P/M) to N(J/F),
300mm

GTL-401 DC Power Line with Lighter Plug, 5A

RLB-001 Return Loss Bridge

Front Panel Overview

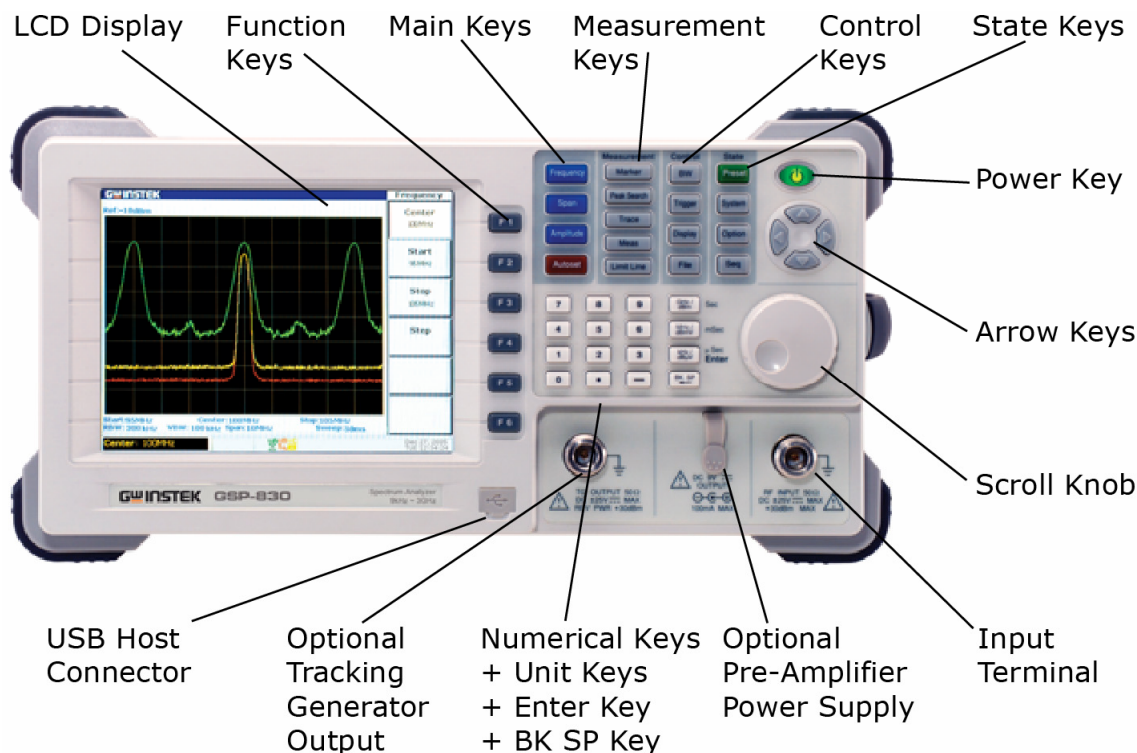

LCD Display TFT Color display, 640x480 resolution. For display setting details, see page107.

F1 to F6 Function Keys **F 1** to **F 6** Soft keys linked to the menu that appears on the right side of the display.

Main Keys

Frequency	<p>Frequency key (page41), together with Span key, configures the horizontal (frequency) scale.</p> <p>Amplitude key (page48) configures the vertical (amplitude) scale and input impedance.</p> <p>Autoset key (page58) automatically searches the peak signal with maximum amplitude and displays it with appropriate horizontal and vertical scales.</p>
Span	
Amplitude	
Autoset	

Measurement keys



Marker key (page62) activates markers and places them on specified locations.
Peak Search key (page68) searches peak signals and configures peak ranges/orders.
Trace key (page73) activates trace signals, configures them, and runs trace math operations.
Measurement key (page82) configures and runs 4 types of Power Measurements: ACPR, OCBW, N-dB, and Phase Jitter.
Limit Line key (page90) configures high/low limit lines and runs the pass/fail test.

Control keys



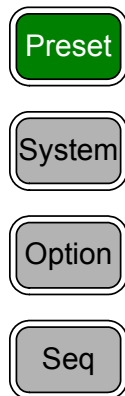

BW key (page95) configures the RBW/VBW width, sweep time length, and waveform averaging number.
Trigger key (page103) selects the trigger type, sets the trigger running mode / delay / frequency, and activates the external trigger input.
Display key (page107) configures the LCD dimmer, edits and shows the display line and title, and activates split windows.
File key (page113) saves/recalls/deletes the trace waveform, limit line, amplitude correction, sequence, and panel settings. Display images may be saved to a storage device via the front panel USB port.

State Keys



Preset key (page40or123) resets the GSP-830 to a predefined state.
System key configures the date/time (page132), GPIB/RS232C interface (page126), and language (page135). It also shows the system information (page128) and self test result (page131), and saves/recalls panel settings (page125).
Option key configures the Tracking Generator (page142), Demodulator (page144), battery (page148), and external reference frequency (page133).
Seq key (page136) edits and runs sequences (user-defined macro).

Power Key  Power key selects the power state between the standby mode (Red LED on) and power on mode (Green LED on). To turn on/off the main power, use the power switch on the rear panel. See page20 for the power up sequence.

Arrow Keys  Arrow keys select parameters in various occasions; Up/Right for increasing, Down/Left for decreasing.

Scroll Knob  Scroll knob sets or selects parameters in various occasions. In many cases, it works in tandem with the Arrow keys.

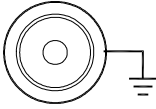
Input Terminal  Input terminal accepts RF input signals.





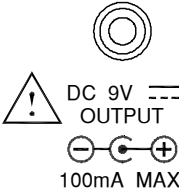









- Maximum +30dBm
- Input impedance 50Ω

RF INPUT 50 Ω
DC ±25V --- MAX
+30dBm MAX 

Pre-Amplifier Power Supply Terminal  Pre-amplifier power supply terminal provides power for the optional GAP-801 or GAP-802 pre-amplifier. For details, see page56.

DC 9V ---
OUTPUT

100mA MAX.

Numerical Keys **Unit Keys** **Enter Key** **BK SP key** Numerical keys set various parameters. In many cases, they work in tandem with the Arrow keys and Scroll knob.

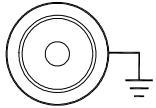
Example	Key sequence
9kHz	  Enter
-3.8dB	     dB
1.0mS	   
9 + Enter	  Enter
Correction	

Optional TG Output Terminal  Outputs the optional Tracking Generator signal. Reversed power should not exceed +30dBm. For details, see page142.

TG OUTPUT 50 Ω
DC ±25V --- MAX 

USB Host Connector  Via the USB port (typeA male), display images may be saved to or recalled from USB flash drives For details, see page113.

Rear Panel Overview

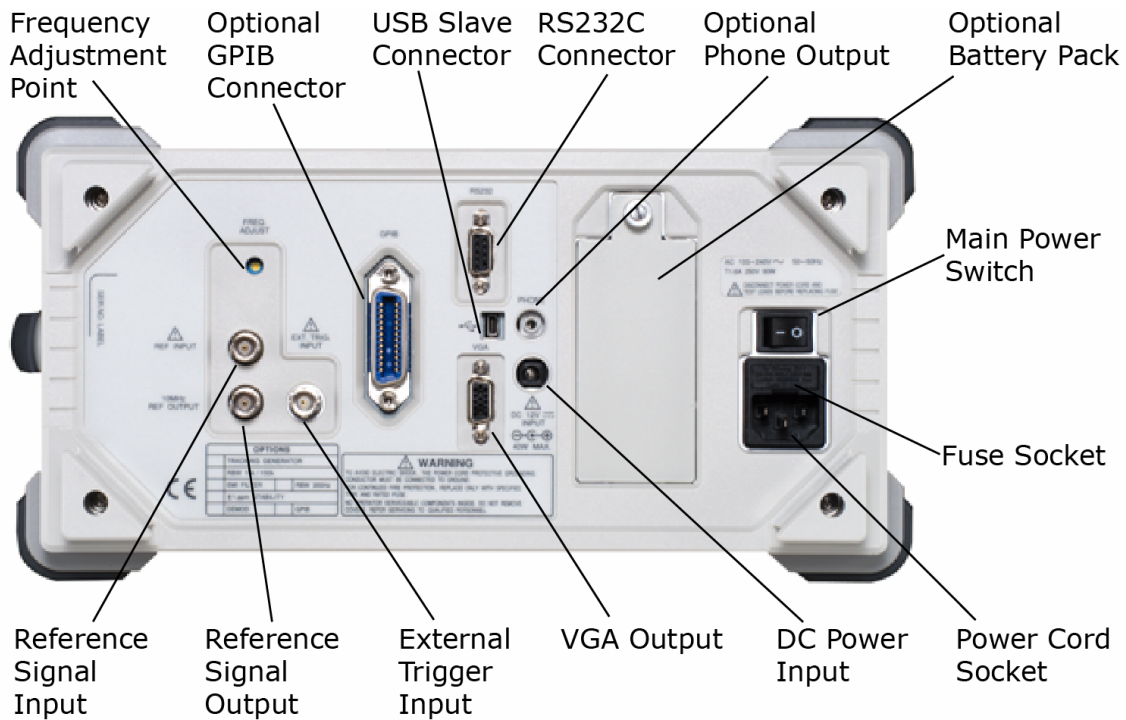

Frequency Adjustment Point



Adjusts the internal reference signal frequency; for service operation only.

GPIB Connector (Optional)

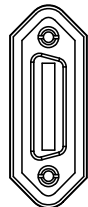

Optional 24 pin female GPIB connector for remote control (page157). For interface setting details, see page127.

USB Connector

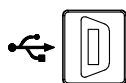

Type B mini connector for PC software connection (page150) and remote control (page157). For interface setting details, see page126.

RS232C Connector

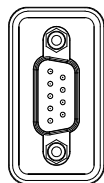

9 pin female connector for PC software connection (page150) and remote control (page157). For interface setting details, see page126.

Phone Output (Optional)



3.5mm phone jack for audio output. Available when the optional Demodulator is installed. For details, see page144.

Battery Pack
(Optional)

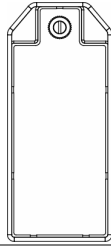

Stores the optional battery packs for portable usage. For details, see page148.

Main Power Switch,
Fuse Socket,
Power Cord Socket

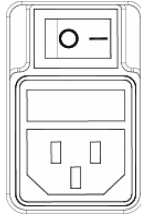

The main power switch turns on/off the GSP-830 main power. For the power up sequence, see page20.
The fuse socket stores the main fuse, T1.6A 250V, time-delay, 5x20mm glass.
The power cord socket accepts the AC power cord, 100 to 240V, 50/60Hz.
For power and fuse related safety instructions, see page6.

DC Power Input

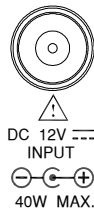

DC power input, 12V, 40W max rating. Accepts a standard 2.1mm DC plug or the optional GTL-401 DC power cord. For details, see page149.

VGA Output

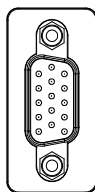

15pin, female VGA connector which outputs 640 x 480 resolution display image to an external monitor. For details, see page111.

External Trigger Input

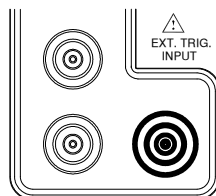

Accepts a trigger signal from an external device. For details, see page103.

Reference Output

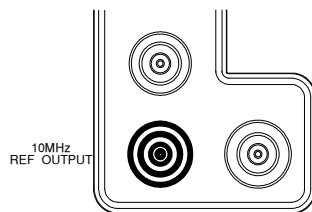

Outputs +5V TTL, 10MHz reference signal used for synchronizing the GSP-830 with an external device. For details, see page133.

Reference Input

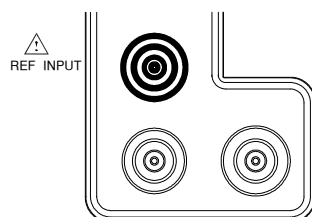

Accepts a TTL signal from an external device, used for synchronization with the GSP-830. For details, see page134.



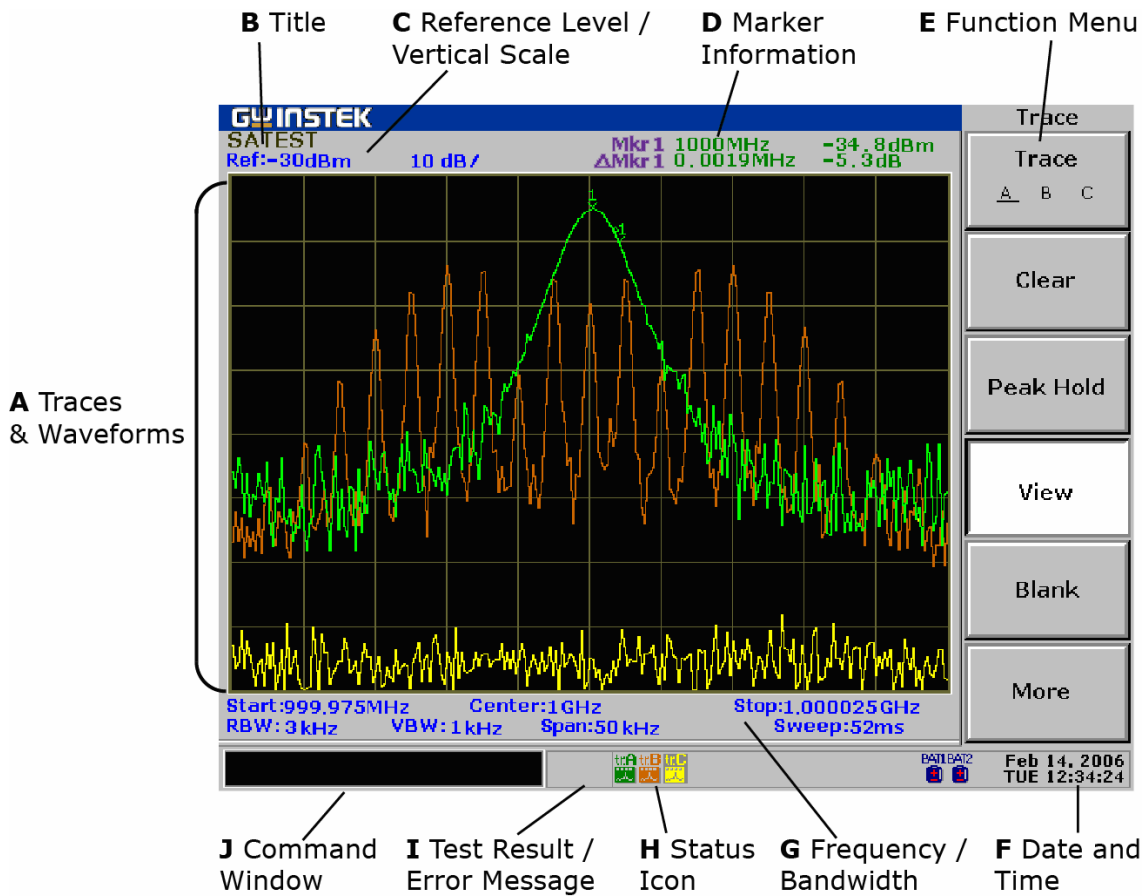



















Display Overview



A	Traces & Waveforms	Input signals and traces that appear within the main display area. Input signal & TraceA: Green, TraceB: Red, TraceC: Yellow. For trace details, see page73.
B	Title	The title of the current display. For details, see page109.
C	Reference Level/Scale	The reference amplitude level and vertical scale. For amplitude details, see page48.
D	Marker Information	The frequency and amplitude for the active marker / delta marker. For marker details, see page62.
E	Function Menu	The menu associated with F1 to F6 function keys on the right side of the display.
F	Date and Time	Current date and time. For setup details, see page132.
G	Frequency/Bandwidth	Upper line: shows the start/stop frequency (page44) and center frequency (page42). Lower line: shows the VBW (video bandwidth - page98), RBW (resolution bandwidth - page96), frequency span (page42), and sweep time (page101).

H	Status Icon	The icons showing various system conditions. See the below Status Icon overview for details.
I	Test Result/ Error Message	The result of the pass/fail test using limit lines (page94) or the system error messages (page128).
J	Command Window	Shows the current status of the selected menu or the entered parameters such as frequency and amplitude.

Status Icon overview

Amplitude (page48)		External gain on, amplitude correction on, Input impedance 75Ω, Input impedance calibration on
Peak Search (page68)		Peak track on
Trace (page73)	TraceA:green  , B:red  , C:yellow 	
		Clear mode
		Average on
		Peak hold mode
		View mode, trace math
BW (page95)		RBW, VBW manual mode
		Sweep time manual mode
Trigger (page103)		Video trigger mode
		External trigger signal on
Battery level (page148)		Fully charged
		50% to 25%
		75% to 50%
		Less than 25%
Options		TG normalization activated (page142)
		External reference signal used (page133)
		±1ppm stability module installed (page133)
Sequence(page136)		Sequence currently running
USB		USB flash drive is detected (page114), or USB remote control connection is detected (page158)

Tilt Stand & Power Up

Tilt stand

Low angle

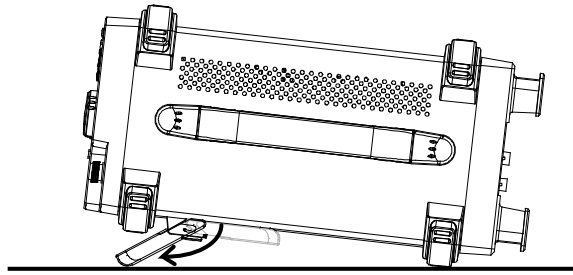
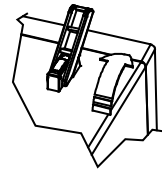
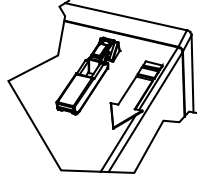

High angle

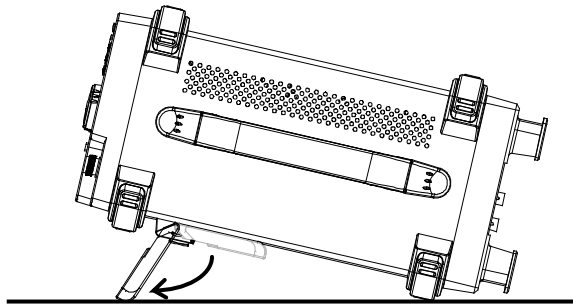
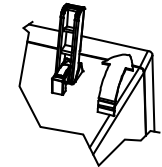
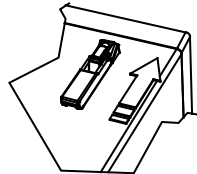

Power Up

1. Connect the power cord to the rear panel socket.

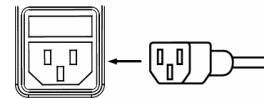

2. Turn on the main power switch.

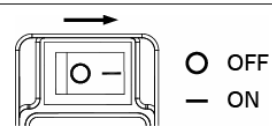

3. The ON/STBY key on the front panel turns red.



4. Press the ON/STBY key. Its color turns green and the display becomes active.



Last Stored Settings

At the initial state, only the F3 menu “Last stored state” becomes available. For details of storing the panel settings, see page125.



To recall the last stored panel settings:

Press F3. One of the panel settings from S1 – S10, which was stored the last time, will be recalled.

To use the GSP-830 without recalling the last stored panel settings:

Press any other function keys (see below).

List of function keys

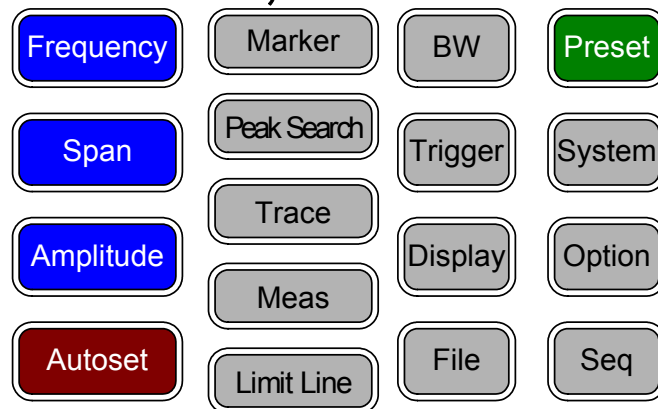

Note

Ignore the error message that might appear at the bottom of the display when powering up the GSP-830. The message indicates that internal configurations are ongoing. For error message details, see page22.

Error Check

This section assumes that the GSP-830 is already powered up (page20).

1. Check system error Check for error messages at the bottom of the display, next to the command window.

Center : 1.5GHz **EXT Unlock** (EXT Unlock)

Contact the service center if any of the following messages remains in the display.

Amp Uncal • Inappropriate RBW or VBW is selected.
• Frequency is less than 15MHz and amplitude is less than -30dBm.

EXT Unlock External reference input is not working properly.

LO1 Unlock Local oscillator 1 is not working properly.

LO3 Unlock Local oscillator 3 is not working properly.

Med Unlock ±1ppm stability signal is not working properly. Appears only when the optional ±1ppm stability module is installed.

Ref Unlock Internal reference signal is not working properly.

2. Check self test result View the GSP-830's self-diagnosis test result. Press the System key → F6 (More) → F2 (Self Test).



The test automatically runs at each power-up. The underline shows the result, pass or fail. Contact the service center if any of the items fails.

GPIB
Pass Fail **F 1** GPIB module connectivity (available only when installed)

Flash
Pass Fail **F 2** Internal Flash memory for storing the system code/data

SDRAM <u>Pass</u> Fail	F 3	Internal SDRAM for running the system code
RTC <u>Pass</u> Fail	F 4	Internal real time clock for configuring the date and time

Functionality Check

- This section assumes that the GSP-830 is already powered up (page20).
- Before operating the GSP-830 in a new environment, run these steps to make sure it is functionally stable.

1. Feed a signal Input a signal to check if the GSP-830 correctly shows the waveform on the display. There are two ways to feed an input signal.

Feeding the DUT signal

If the DUT is already available, connect the output signal to the RF input terminal. The signal amplitude must be less than +30dBm.

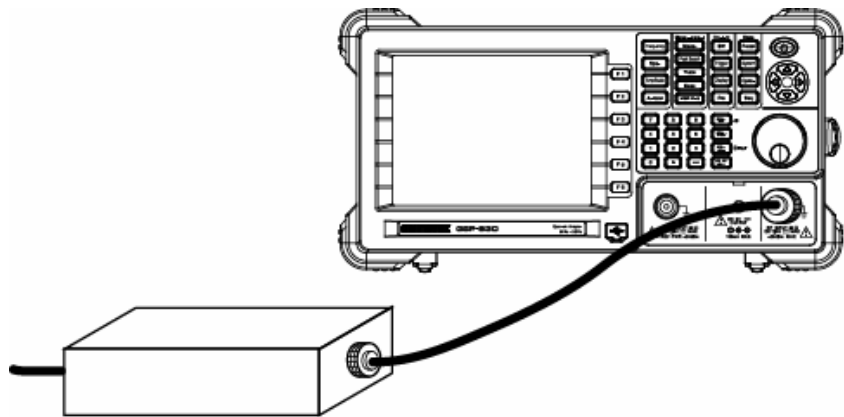

Feeding the internal auxiliary signal

You can also use the internal auxiliary signal, 100MHz/-30dBm. No cable connection is required in this case. Activate the signal by pressing the System key → F4 (Aux Sig On).

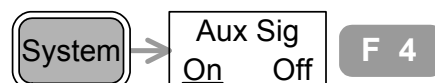



2. View the signal

Press the Autoset key → F1 (Autoset).



The GSP-830 automatically configures the horizontal and vertical scales and shows the signal on the display.

Check the peak frequency and amplitude that appear on the top right corner of the display. To move the marker, use the Scroll knob  or Left/Right keys .

Internal auxiliary signal, -30dBm @ 100MHz

Peak frequency/amplitude

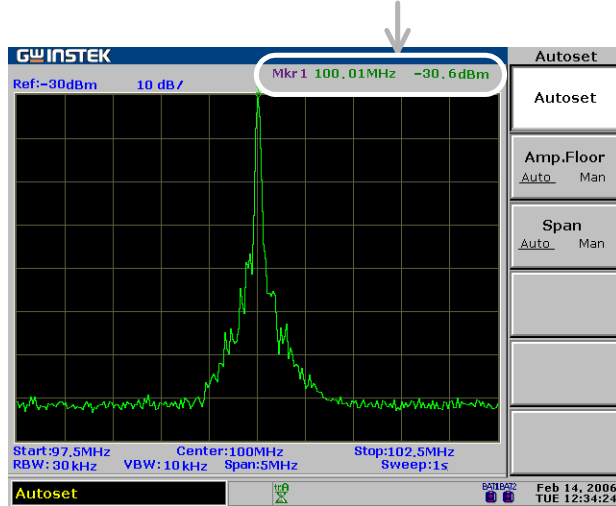

If the displayed value does not match the actual signal, contact the service center.

QUICK REFERENCE

Shortcuts	Power-on screen.....26
	Frequency and Span26
	Amplitude.....26
	Autoset.....26
	Marker.....26
	Peak Search27
	Trace.....27
	Power Measurement.....27
	Limit Line28
	Bandwidth28
	Trigger28
	Display29
	File29
	System.....29
	Option.....30
	Sequence.....30
Menu Tree	Power-on screen.....31
	Frequency, Span, Autoset, Amplitude(1 of 2)31
	Amplitude (2 of 2), Marker.....32
	Peak Search, Trace.....33
	Measurement, Limit Line34
	BW, Trigger, Display.....35
	File (1 of 2)36
	System.....38
	Option, Sequence.....39
Preset	Preset Contents40

Operation Shortcuts

Here is the list of available operations and their shortcuts.

Power-on screen

Recall the last stored settings	F3
---------------------------------	----

Frequency and Span

Set Center Frequency and Span	Frequency→F1→Span→F1
Set Start and Stop Frequency	Frequency→F2(Start), F3(Stop)
Set Frequency Step	Frequency→F4
Activate Full Span (3.0GHz)	Span→F2
Activate Zero Span (Time Domain)	Span→F3
Recall Last Span	Span→F4

Amplitude

Set Reference Level	Amplitude→F1
Select Vertical Scale	Amplitude→F2
Select Unit (dBm/dBmV/dBuV)	Amplitude→F3→F1 to F3
Set External Gain	Amplitude→F4
Activate Amplitude Correction	Amplitude→F5→F2
Select Amplitude Correction Set	Amplitude→F5→F1→F1
Delete Amplitude Correction Item	Amplitude→F5→F1→F2
Delete Amplitude Correction Set	Amplitude→F5→F1→F3→F2
Undo Correction Item/Set Deletion	Amplitude→F5→F1→F4
Save Amplitude Correction Set	Amplitude→F5→F1→F5
Select Input Impedance (50Ω/75Ω)	Amplitude→F6→F1
Set Input Impedance Offset	Amplitude→F6→F2

Autoset

Run Autoset	Autoset→F1
Set Amplitude Floor	Autoset→F2
Set Frequency View Span	Autoset→F3

Marker

Activate Normal Marker	Marker→F1→F2
------------------------	--------------

Activate Delta Marker	Marker→F1→F2→F3
Activate All Normal Markers	Marker→F6→F3
Move Marker to Peak	Marker→F4 or Peak Search
Move Marker and Peak to Center	Marker→F4→F5 or Peak Search→F5
Track Marker on Peak	Peak Search→F6→F4
Move Marker to Various Locations	Marker→F6→F4→F1 to F5
Show Marker Table	Marker→F6→F2
Put Marker on Trace	Marker→F6→F1

Peak Search

Search Peak Signal	Peak Search or Marker→F4
Search Next Peak	Peak Search→F2
Search Next Peak to Right	Peak Search→F3
Search Next Peak to Left	Peak Search→F4
Search Peak and Move to Center	Peak Search→F5 or Marker→F4→F5
Track Marker on Peak	Peak Search→F6→F4
Search Minimum Amplitude	Peak Search→F6→F5
Show Peak Table	Peak Search→F6→F1
Sort Peaks in Peak Table	Peak Search→F6→F2
Set Peak Threshold	Peak Search→F6→F3

Trace

Activate Trace	Trace→F1
Clear Trace (Update in Real-Time)	Trace→F2
View Peak Hold Trace	Trace→F3
Freeze Trace	Trace→F4
Hide Trace	Trace→F5
View Averaged Trace	Trace→F6→F1 or BW→F4
Run Trace Math	Trace→F6→F2→F1 to F5
Select Signal Detection Mode	Trace→F6→F3→F1 to F5

Power Measurement

Activate ACPR	Meas→F2
Set ACPR Channel Bandwidth	Meas→F1→F1
Set ACPR Channel Space	Meas→F1→F2
Set ACPR Adjacent Channel Offset	Meas→F1→F4→F2 and F4

Set ACPR Adjacent Channel BW	Meas→F1→F4→F1 and F3
Move ACPR Channel Up	Meas→F4
Move ACPR Channel Down	Meas→F5
Activate OCBW	Meas→F3
Set OCBW Channel Bandwidth	Meas→F1→F1
Set OCBW Channel Space	Meas→F1→F2
Set OCBW %	Meas→F1→F3
Move OCBW Channel Up	Meas→F4
Move OCBW Channel Down	Meas→F5
Activate N dB	Meas→F6→F1
Set N dB Value	Meas→F6→F2
Activate Phase Jitter	Meas→F6→F3
Set Phase Jitter Offset	Meas→F6→F4→F1(Start), F2(Stop)

Limit Line

Activate Limit Line	Limit Line→F1 (High), F2 (Low)
Select Limit Line for Edit	Limit Line→F3→F1
Activate Limit Line Edit Table	Limit Line→F3→F2
Delete Limit Line Table Item	Limit Line→F3→F3
Delete All Table Item	Limit Line→F3→F4→F2
Undo Last Deletion	Limit Line→F3→F5
Run Pass/Fail Test	Limit Line→F4
Select Pass/Fail Condition	Limit Line→F5

Bandwidth

Select RBW	BW→F1
Select VBW	BW→F2
Set Sweep Time	BW→F3
Set Trace Average Number	BW→F4 or Trace→F6→F1
Reset RBW/VBW/Sweep to Auto	BW→F5

Trigger

Select Free Run (Default)	Trigger→F1
Select Video/External Trigger	Trigger→F2
Select Trigger Mode	Trigger→F3
Set Trigger Delay	Trigger→F4

Set Trigger Frequency	Trigger→F5
-----------------------	------------

Run Trigger (in Single/Continuous)	Trigger→F6
------------------------------------	------------

Display

Change Dimmer Level	Display→F1
---------------------	------------

Show Display Line	Display→F2
-------------------	------------

Clear Title	Display→F3→F1
-------------	---------------

Enter Title	Display→F3→F2 to F4
-------------	---------------------

Show Title	Display→F3→F5
------------	---------------

Activate Split Window	Display→F4→F1 (Upper), F2 (Lower)
-----------------------	-----------------------------------

Alternate Upper/Lower Sweep	Display→F4→F3
-----------------------------	---------------

Switch Split Display to Full Screen	Display→F4→F4
-------------------------------------	---------------

File

Select Copy Source File	File→F1→F1→F1 to F5
-------------------------	---------------------

Select Copy Destination File	F2→F1 to F5 (After Selecting Source)
------------------------------	--------------------------------------

Edit Copied File Name	F3 (After Selecting Destination)
-----------------------	----------------------------------

Copy Selected File	F4 (After Selecting Source/Destination)
--------------------	---

Select File for Deletion	File→F2→F1→F1 to F5
--------------------------	---------------------

Delete Selected File	F2 (After Selecting File)
----------------------	---------------------------

Rename File	File→F3→F1
-------------	------------

Confirm New File Name	F2 (After Renaming File)
-----------------------	--------------------------

Save Display Image to USB Drive	File→F4→F1→F2
---------------------------------	---------------

Rename File in USB Drive	File→F4→F1→F1
--------------------------	---------------

Select System Code for Update	File→F5→F1→F1
-------------------------------	---------------

Select Language for Update	File→F5→F1→F2
----------------------------	---------------

Update System File from USB Drive	F2 (After Selecting File)
-----------------------------------	---------------------------

Preset

Recall Factory Installed Settings	Preset
-----------------------------------	--------

System

Save Setup	System→F1→F1 or F2→F3
------------	-----------------------

Recall Setup	System→F1→F1 or F2→F4
--------------	-----------------------

Select GPIB Address	System→F2
---------------------	-----------

Show RS-232C Configuration	System→F3→F1 to F4
----------------------------	--------------------

Activate Auxiliary Signal	System→F4
---------------------------	-----------

Set Date	System→F6→F1→F1→F1 to F4
Set Time	System→F6→F1→F2→F1 to F3
Activate Clock Display	System→F6→F1→F3
View Self Test Result	System→F6→F2
View System Configuration	System→F6→F4
Select Language	System→F6→F5→F1

Option

Activate Tracking Generator	Option→F1→F1
Set Tracking Generator Amplitude	Option→F1→F2
Normalize Tracking Generator	Option→F1→F3→F2
Activate Normalized TG	Option→F1→F4
Set Ref Level for TG Normalization	Option→F1→F5
Activate FM Demodulator	Option→F2→F1
Activate AM Demodulator	Option→F2→F2
Activate Phone Output	Option→F2→F3
Set Phone Output Volume	Option→F2→F4
Set Squelch Level	Option→F2→F5
View Battery Level	Option→F3
Set Ext. Reference Signal Frequency	Option→F4

Sequence

Select Sequence Set	Sequence→F1, F2
Start Sequence Edit	Sequence→F3→F1
Insert 100ms Delay	Sequence→F3→F2
Insert Pause in Sequence	Sequence→F3→F3
Insert Another Sequence Set	Sequence→F3→F4→F1 to F2
Stop Sequence Edit	Sequence→F3→F5
Insert Item to Sequence Set	Sequence→F3→F6→F1
Save Sequence Set	Sequence→F3→F6→F2
Delete Sequence Item	Sequence→F3→F6→F3
Delete Sequence Set	Sequence→F3→F6→F4→F2
Undo Sequence Item/Set Delete	Sequence→F3→F6→F5
Select Sequence Run Mode	Sequence→F4→F1
Run Sequence	Sequence→F4→F2
Delete All Sequence Set	Sequence→F5→F2

Menu Tree

Power-on screen

Last stored state	F 3
-------------------	-----

Frequency, Span, Autoreset, Amplitude(1 of 2)

Frequency

Center 1.5 GHz	F 1
Start 0 kHz	F 2
Stop 3 GHz	F 3
Step 1 MHz	F 4

Span

Span 3 GHz	F 1
Full Span	F 2
Zero Span	F 3
Last Span	F 4

Autoreset

Autoreset	F 1
Amp.Floor Auto Man	F 2
Span Auto Man	F 3

Amplitude

Ref.Level 0 dBm	F 1	}	dBm	F 1
Scale dB/Div 10 5 2 1	F 2		dBmV	F 2
Units...	F 3		dBuV	F 3
Ext.Gain 0dB	F 4			
Corrections..	F 5			
More	F 6		Return	F 6

Amplitude (2 of 2), Marker

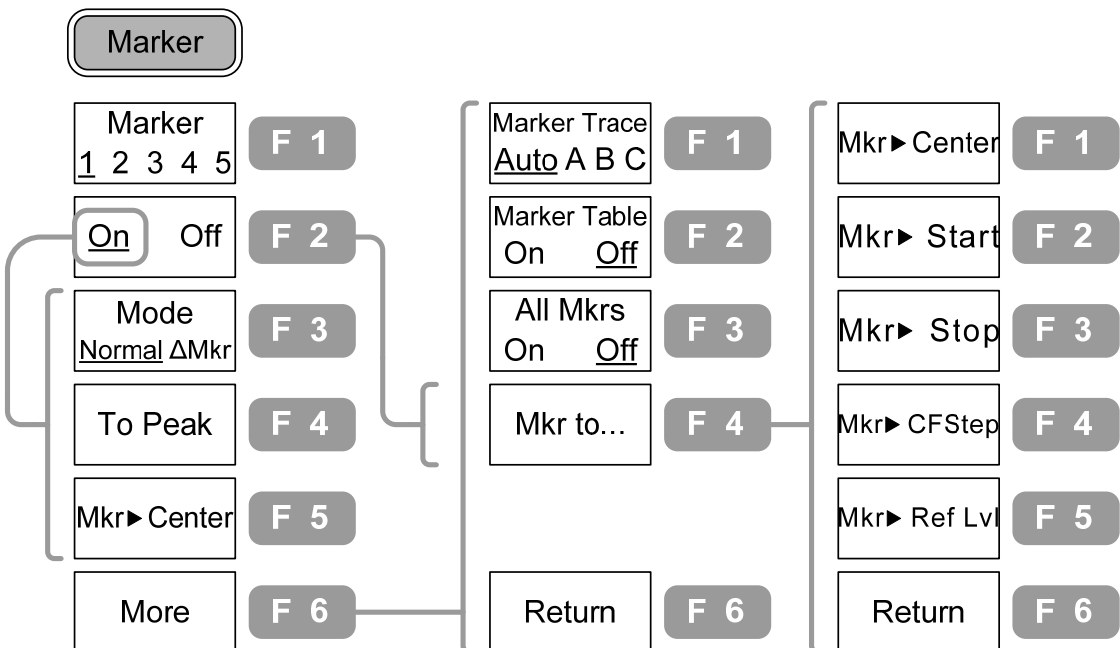
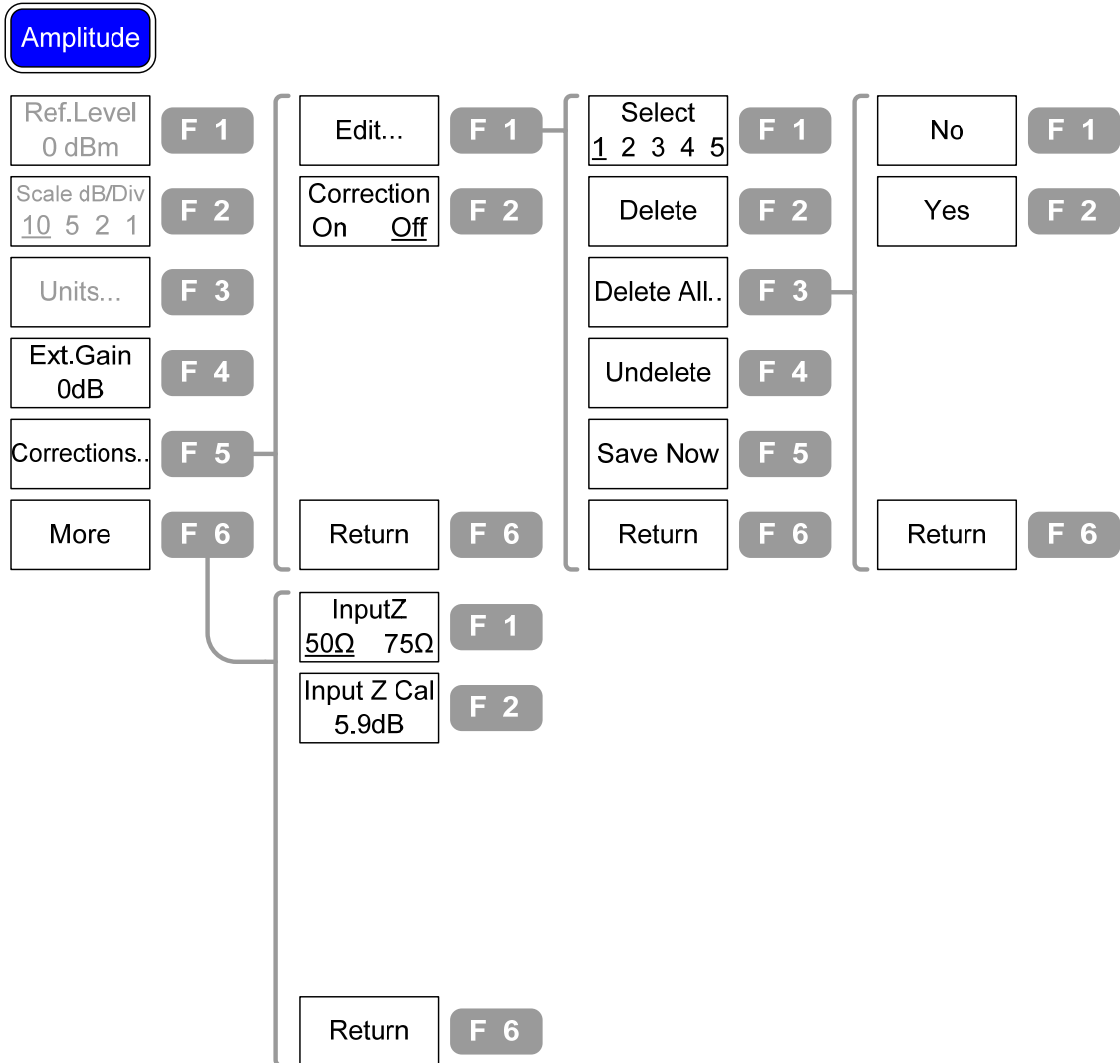

Peak Search, Trace

Peak Search

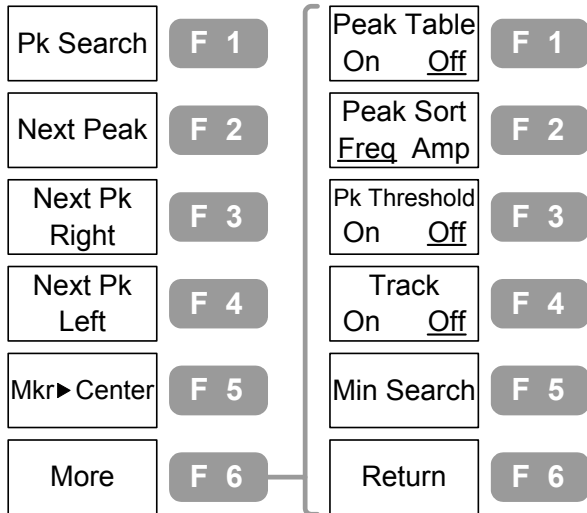

Trace

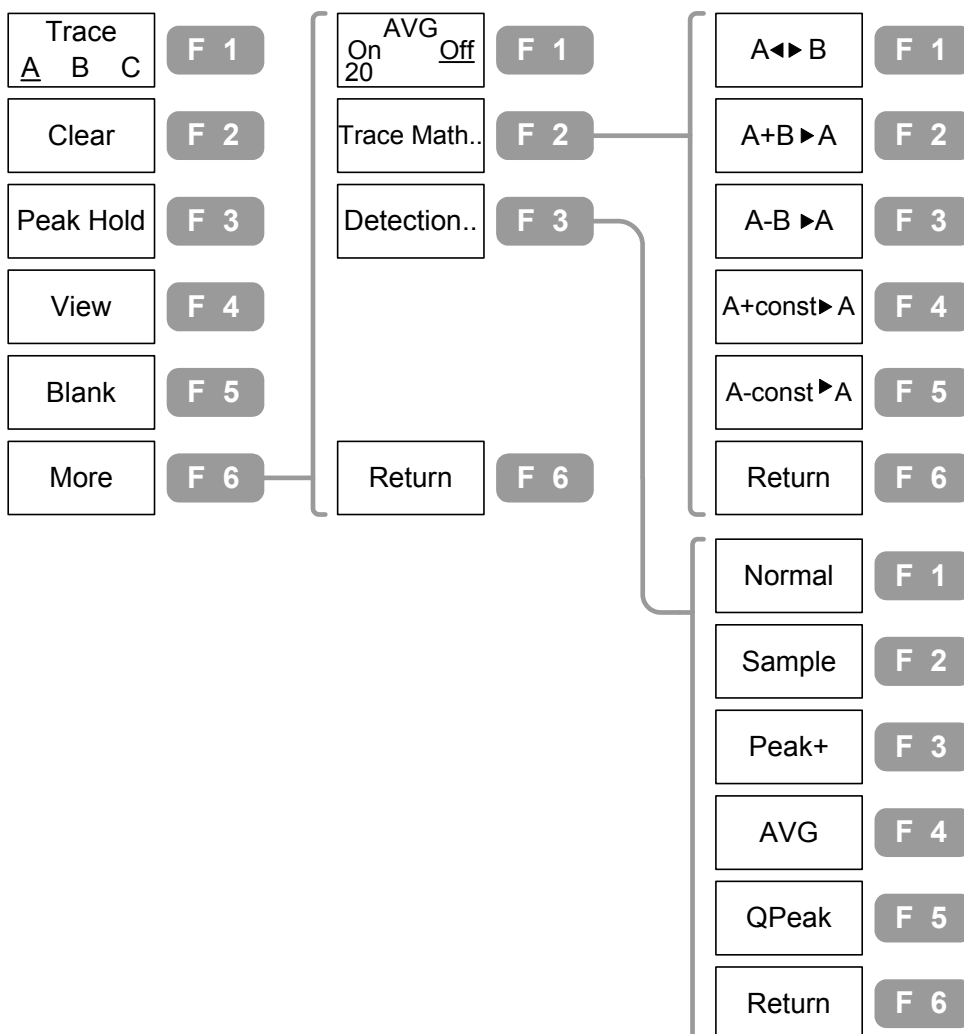

Measurement, Limit Line

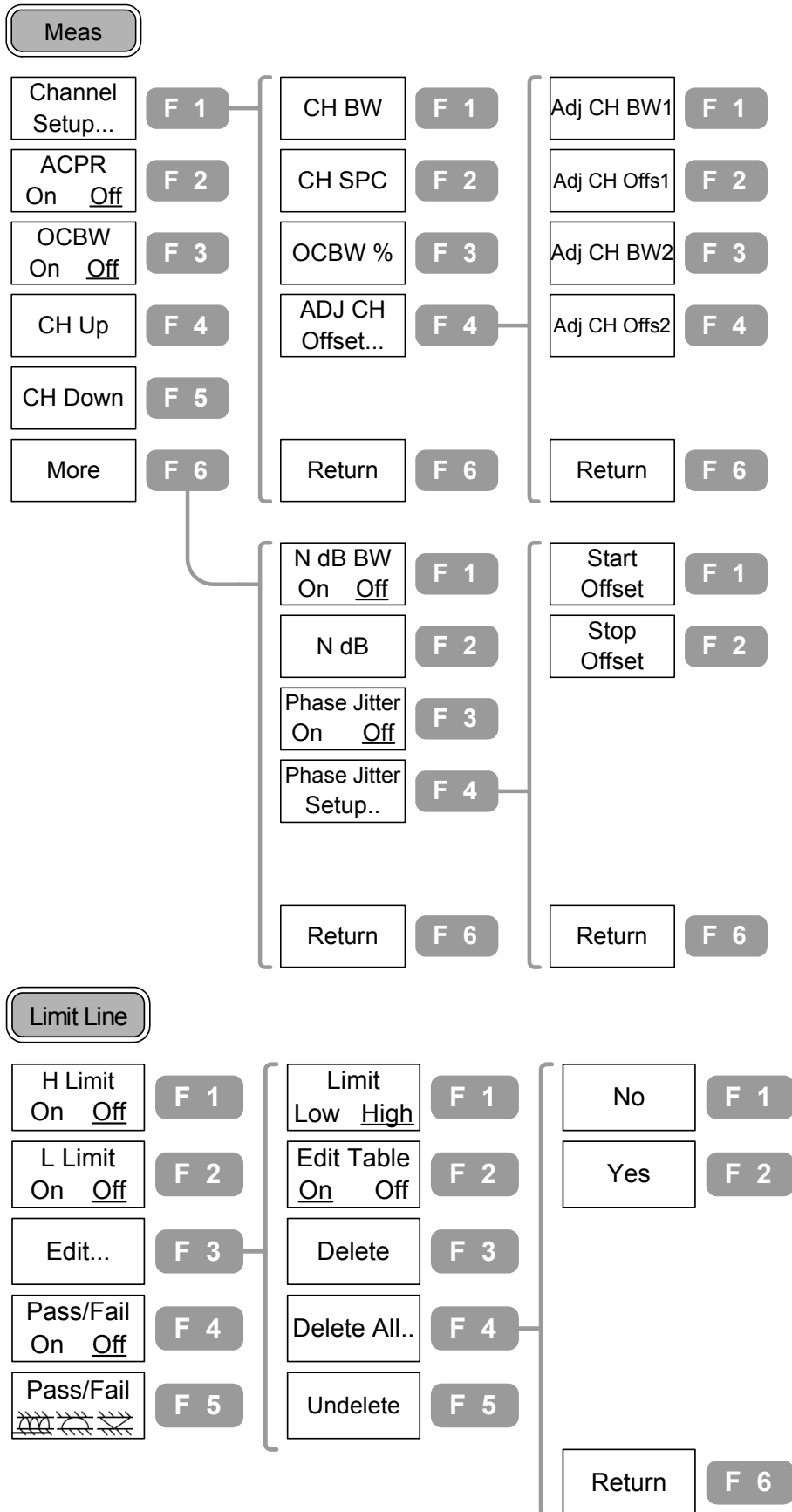

BW, Trigger, Display

BW

RBW
Auto Man F 1

VBW
Auto Man F 2

Swp Tm
Auto Man F 3

AVG
On 20 Off F 4

All Auto F 5

Trigger

Free Run F 1

Trigger
Condition Video Ext. F 2

Trigger Mode
Nor. Sgl. Cont. F 3

Trigger Delay
50ms F 4

Trigger Freq
1.5GHz F 5

Run Now F 6

Display

LCD Dimmer F 1

Display Line
On Off F 2

Title... F 3

Split
Window... F 4

Clear Title F 1

(Capital
Letter) F 2

(Small
Letter) F 3

(Symbol) F 4

Show Title F 5

Return F 6

Upper F 1

Lower F 2

Alternate
Sweep F 3

Full Screen F 4

Return F 6

File (1 of 2)

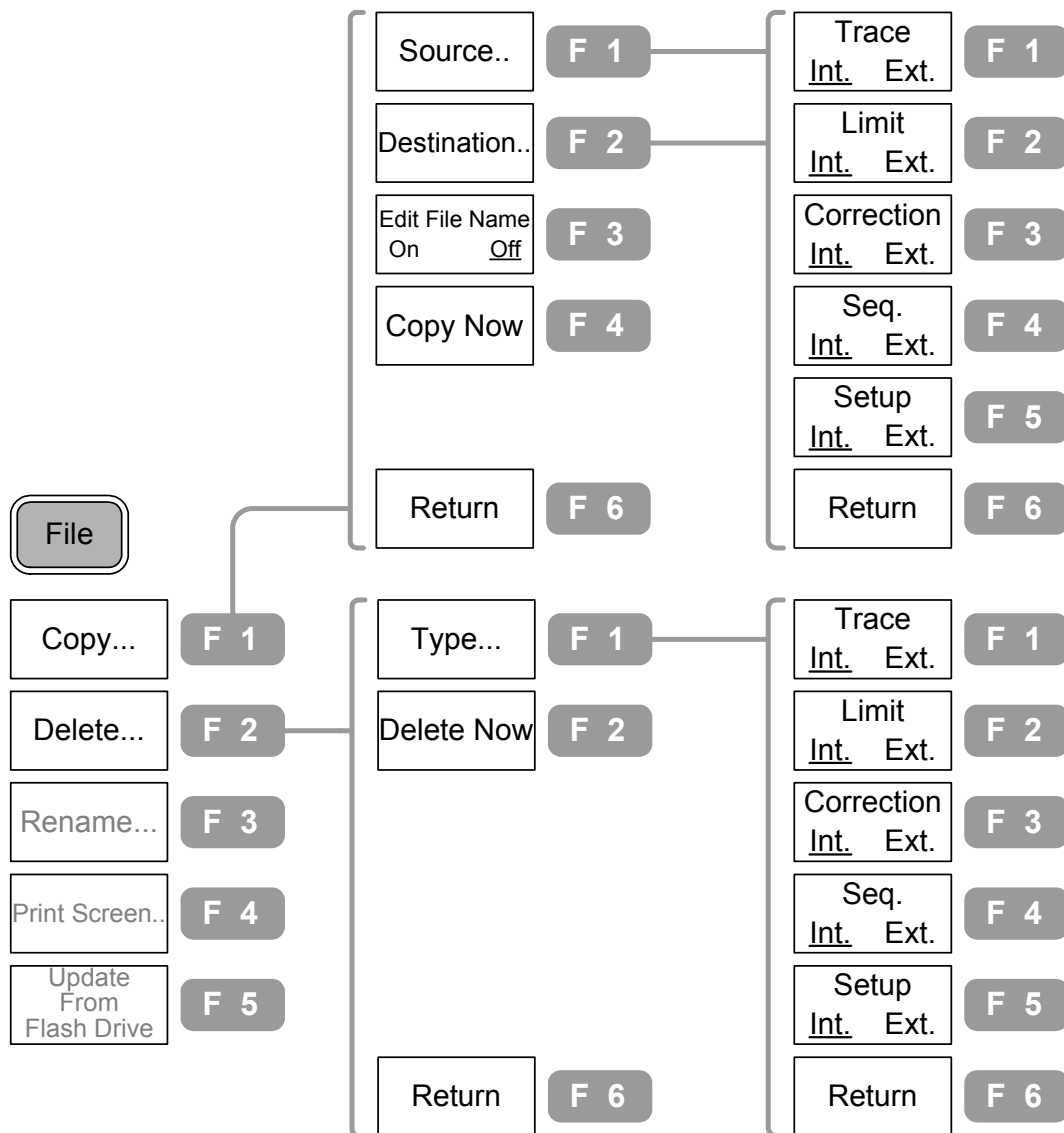

File (2 of 2)

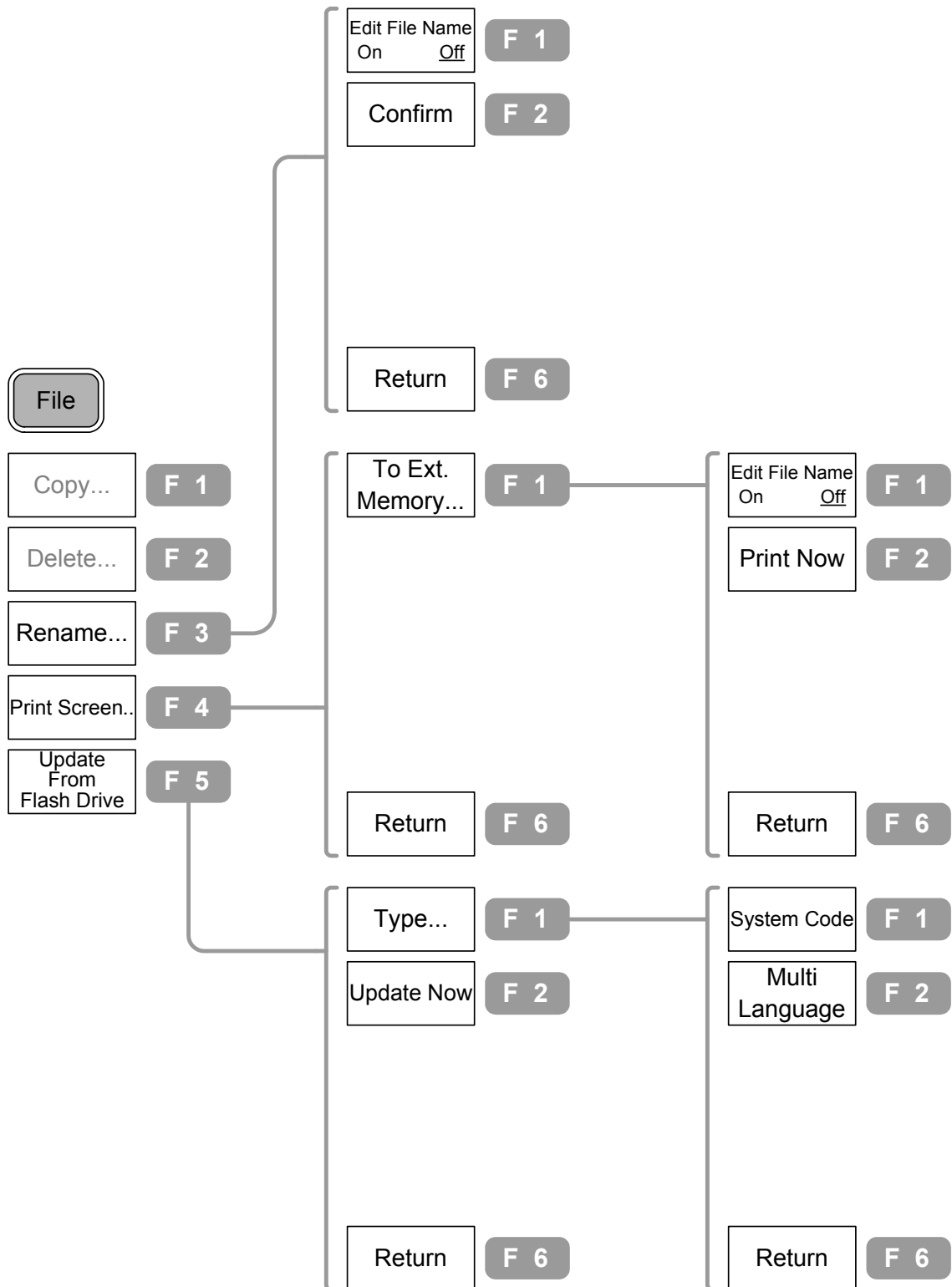

Preset



(No menu item)

System

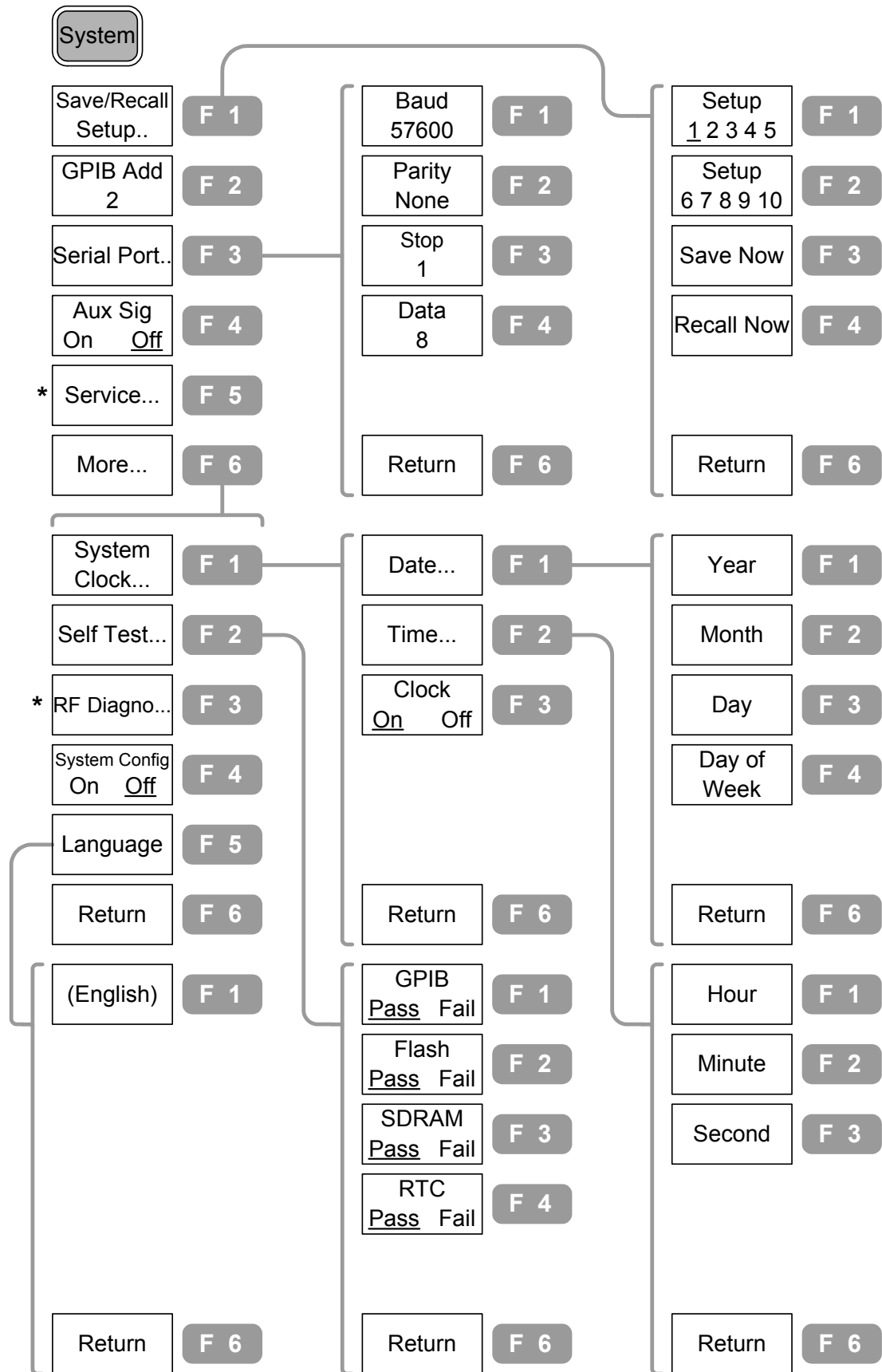

* Submenu only for service personnel

Option, Sequence

Option

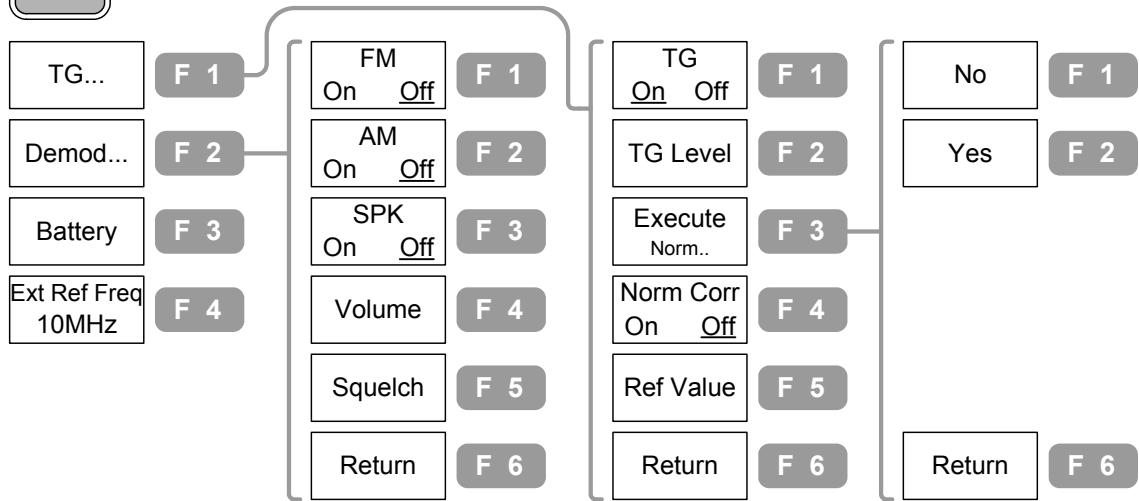

Seq

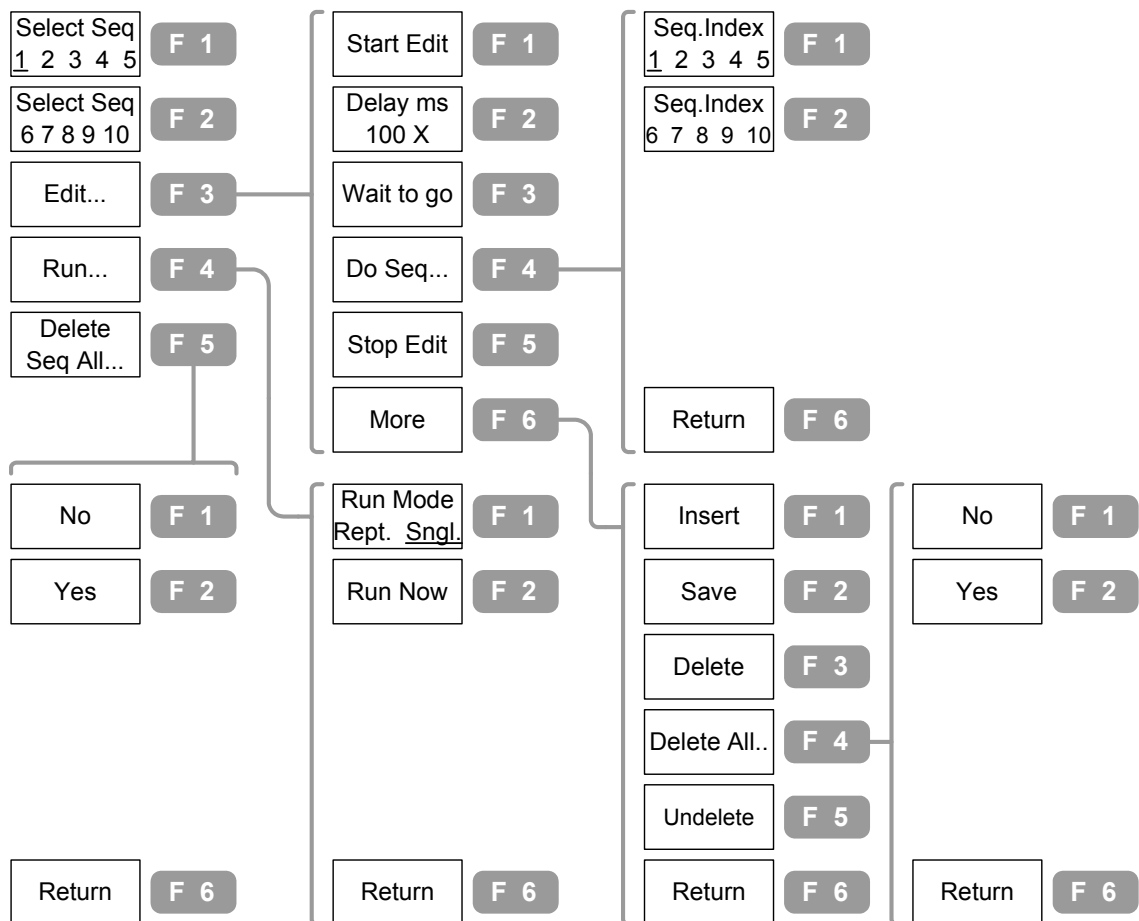

Preset Contents

These are the settings that appear when pressing the Preset key .

Frequency	Center: 1.5GHz Start: 0Hz	Stop: 3GHz Step: 1MHz
Span	3GHz	
Amplitude	Ref.level: 0dBm Unit: dBm Scale: 10dB/	External Gain: 0dB Input Z: 50Ω
Autoset	Amplitude Floor: Auto	Span: Auto
Marker	Marker: Off Marker Table: Off	Marker Trace: Auto All Marker: Off
Peak Search	Peak Table: Off Peak Threshold: Off	Peak Sort: Freq Peak Track: Off
Trace	Trace: A Average: Off, 20	Mode: Clear Detection: Normal
Meas	ACPR: Off CH SPC: 0 CH BW: 600MHz OCBW %: 0 N dB: Off	OCBW: Off Adj CH Offs: 0MHz Adj CH BWs: 0MHz Phase Jitter: Off
Limit Line	H & L Limit: Off	Pass/ Fail: Off
BW	RBW: Auto SwpTime: Auto	VBW: Auto Average: Off, 20
Trigger	Trigger Delay: 50ms Trigger Mode: Normal	Trigger Freq: 1.5GHz
Display	LCD Dimmer: 5 Split Window: Off	Display Line: Off Display Title: Off
File	Copy Type: Int. Trace Rename Type: Ext. Trace	Delete Type: Int. Trace
System	GPIB Add: 2 Aux Sig: Off	System Config: Off Clock: On
Option	External Ref Freq: 10MHz TG Norm Corr: Off Demod AM: Off	TG Output: Off TG Ref Value: 0dBm Demod FM: Off
Sequence	Sequence: 1	Run Mode: Single

FREQUENCY/SPAN

The **F**requency key, together with **S**pan key, sets the frequency scale. Two methods are available. Center-and-Span method defines the center point and surrounding frequency range. Start-and-Stop method defines the beginning and end of the frequency range. Special span settings are available at full and zero spans. The last span setting may also be recalled.

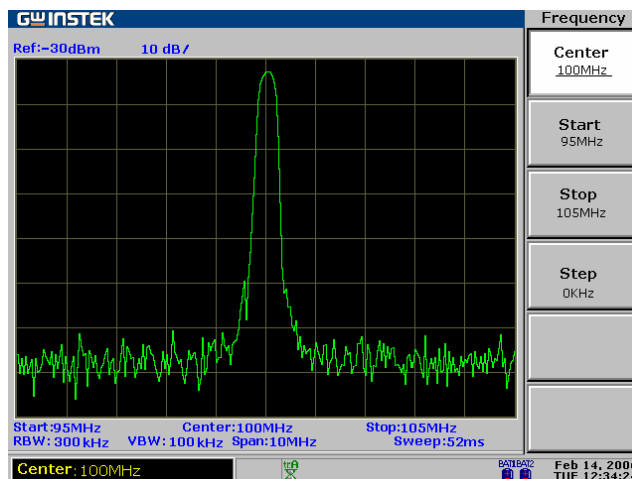
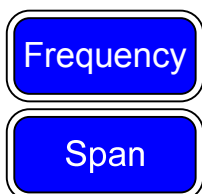



Center and Span	Set frequency adjustment step	42
	Set center frequency	42
	Set frequency span	43
Start and Stop	Set frequency adjustment Step	44
	Set start frequency	44
	Set stop frequency	45
Span	Display full frequency span (3GHz)	46
	Display zero span (time domain)	46
	Recall the Last Span Setting	47

View Signal (Center and Span)

Center-and-Span method defines the center frequency and the left/right bandwidth (span) to locate the signal.

Set frequency adjustment step

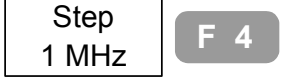
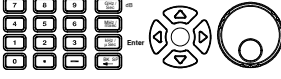
Background	Frequency adjustment step defines the Arrow keys resolution for center, start, and stop frequency.	
Panel operation	1. Press the Frequency key.	
	2. Press F4 (Step).	
	3. Enter the value using the Numerical and Unit keys, Arrow keys, and Scroll knob.	
Range	0kHz to 3GHz * Arrow keys and Scroll knob resolution: 1/10 of Span	

Set center frequency

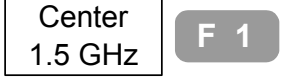
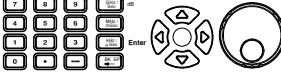
Panel operation	1. Press the Frequency key.	
	2. Press F1 (Center).	
	3. Enter the value using the Numerical and Unit keys, Arrow keys, or Scroll knob.	
Range	0kHz to 3GHz Arrow keys and Scroll knob resolution: step value	
Note	Center frequency and span settings automatically change according to start and stop frequency settings, and vice versa.	

Display

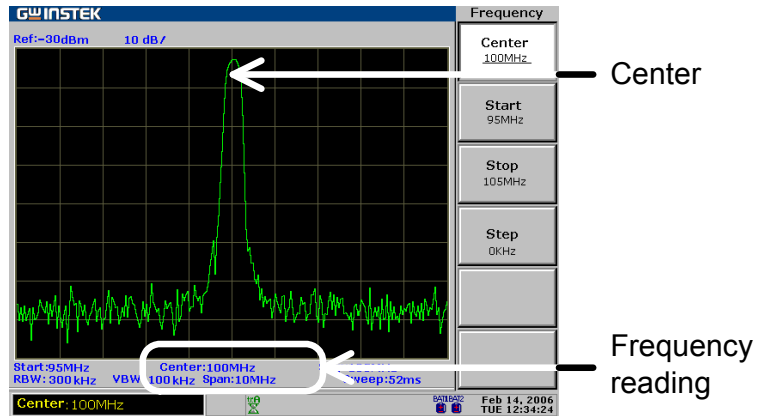

Set frequency span

Panel operation

1. Press the Span key.

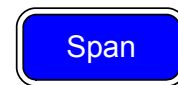

2. Press F1 (Span).

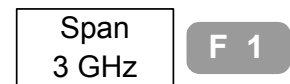

3. Enter the value using the Numerical and Unit keys, Arrow keys, and Scroll knob.

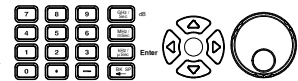

Range

2kHz to 3GHz

* Arrow keys & Scroll knob resolution: 1-2-5 sequence (0 [zero span], 2kHz, 5kHz, 10kHz, 20kHz, 50kHz,1GHz, 2GHz, 3GHz)

Display

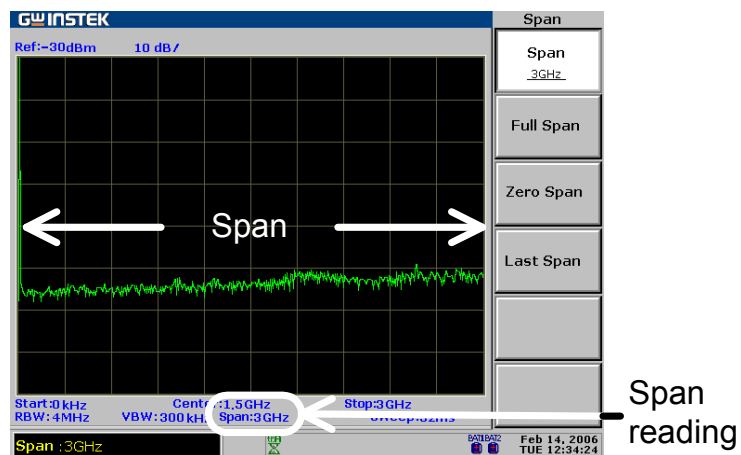



Note

- Center frequency and span settings automatically change according to start and stop frequency settings, and vice versa.
- If the span becomes smaller than the CHBW (channel bandwidth) in the ACPR or OCBW measurement (page82), the warning “Span is less than CHBW!” appears in the command window.

View Signal (Start and Stop)

Start-and-Stop method defines the beginning (start) and the end (stop) of the frequency range.

Set frequency adjustment Step

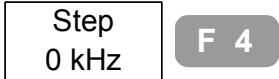
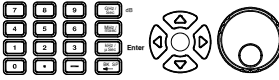
Background	Frequency adjustment step defines the Arrow keys resolution for Center, Start, and Stop frequency.	
Panel operation	1. Press the Frequency key.	
	2. Press F4 (Step).	
	3. Enter the value using the Numerical and Unit keys, Arrow keys, and Scroll knob.	
Range	0.0kHz to 3.0GHz * Arrow keys and Scroll knob resolution: 1/10 of span	

Set start frequency

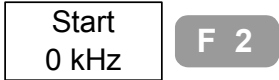
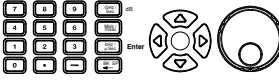
Panel operation	1. Press the Frequency key.	
	2. Press F2 (Start).	
	3. Enter the value using the Numerical and Unit keys, Arrow keys, and Scroll knob.	
Range	0kHz to 3GHz (start frequency ≤ stop frequency) Arrow keys and Scroll knob resolution: step value	
Note	Center frequency and span settings automatically change according to start and stop frequency settings, and vice versa.	

Display

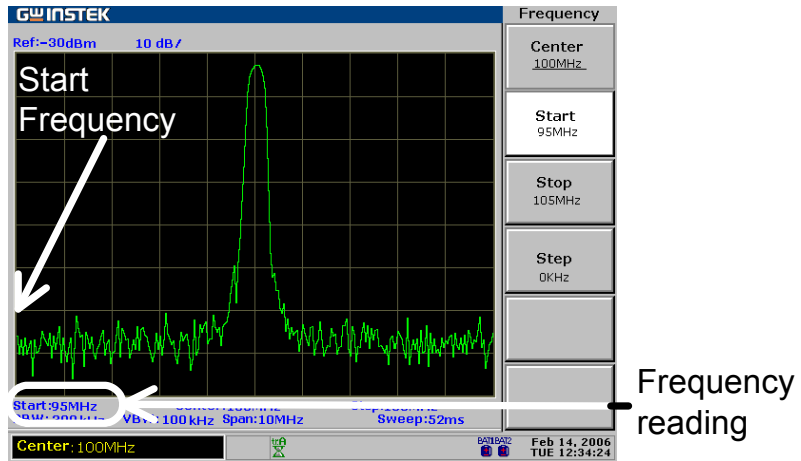

Set stop frequency

Panel operation

1. Press the Frequency key.



2. Press F3 (Stop).

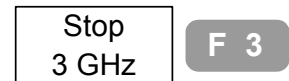

3. Enter the value using the Numerical and Unit Keys, Arrow keys, and Scroll knob.

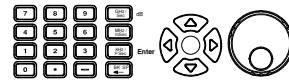

Range

0.0kHz to 3.0GHz (start frequency \leq stop frequency)
 * Arrow keys and Scroll knob resolution: step value

Display

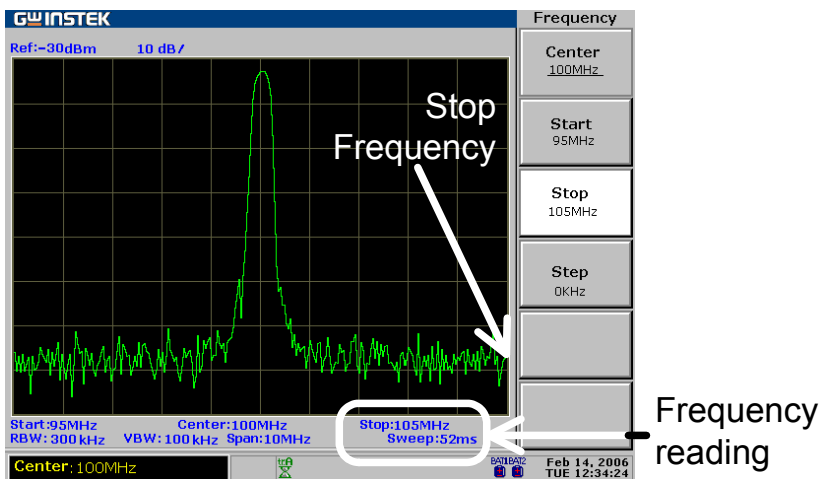



Note

Center frequency and span settings automatically change according to start and stop frequency settings, and vice versa.

Full/Zero Span

Full or zero span setting sets the span to extreme values: 3GHz (full) or 0kHz (zero). They provide faster ways to view signals in certain situations, such as in time domain (zero span) for viewing modulation or in full span for viewing signals with unknown frequencies.

Display full frequency span (3GHz)

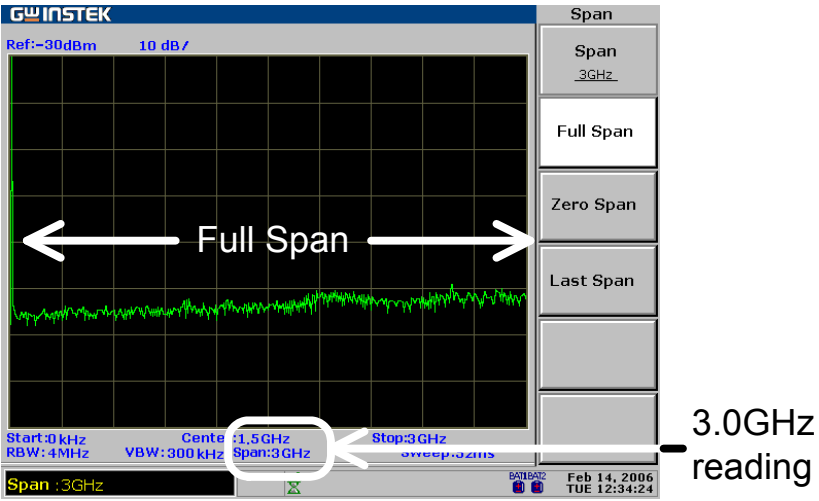

Panel operation	1. Press the Span key.	
	2. Press F2 (Full Span).	
Range	3GHz (fixed)	
	Full span also sets these parameters to fixed values.	
	<ul style="list-style-type: none"> • Center frequency: 1.5GHz • Start frequency: 0.0kHz • Stop frequency: 3.0GHz 	

Display



The screenshot shows the GWINSTEK GSP-830 interface. The main display is a spectrum analyzer with a green signal trace. A white double-headed arrow labeled "Full Span" spans the width of the plot. The status bar at the bottom shows "Span: 3GHz" in yellow. A white circle highlights the "Span: 3GHz" text. A white arrow points from the "3.0GHz reading" text to the "Span: 3GHz" text. The status bar also shows "Start: 0 kHz", "Center: 1.5 GHz", "Stop: 3 GHz", "RBW: 4 MHz", "VBW: 300 kHz", and "Span: 3 GHz". The date and time are "Feb 14, 2006 TUE 12:34:24".

Display zero span (time domain)

Panel operation	1. Press the Span key.	
	2. Press F3 (Zero Span).	
Range	Center frequency (fixed)	

Zero span also sets these parameters to fixed values.

- Start frequency: same as the center frequency
- Stop frequency: same as the center frequency

Display

The diagram shows an example of observing the amplitude modulation of the input signal.

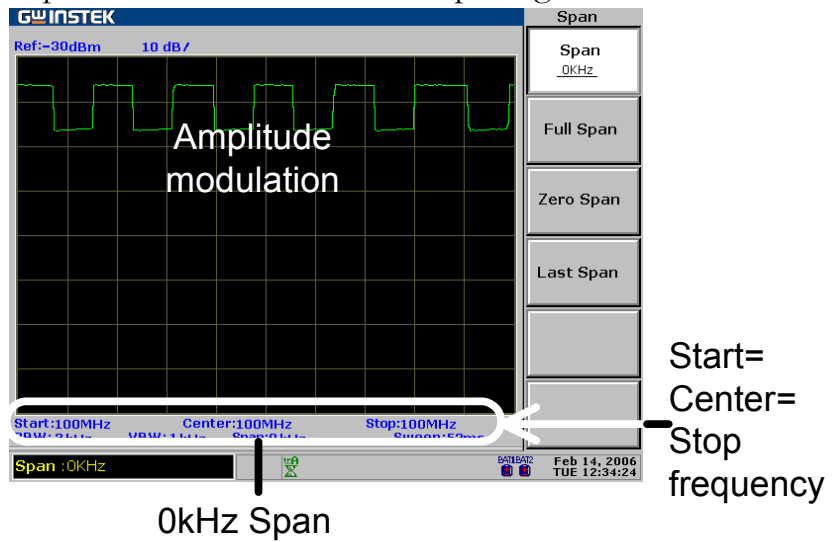

Note

When using zero span for viewing amplitude modulation, make sure that the RBW setting is large enough. For RBW setting details, see page96.

Recall the Last Span Setting

Panel operation

1. Press the Span key.

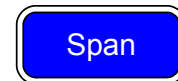

2. Press F4 (Last Span).



3. The span setting goes back to the previous one.

Nesting level

1 level

AMPLITUDE

The **Amplitude key** sets the vertical attribute of the display, including the upper limit (reference level), vertical range (amplitude scale), vertical unit, and compensation for external gain or loss (external offset). Amplitude correction adjusts the frequency response distortion caused by external networks. The optional pre-amplifier GAP-801 and GAP-802 boosts the level of a weak input signal before it enters the GSP-830. The input impedance can also be adjusted according to the application needs.

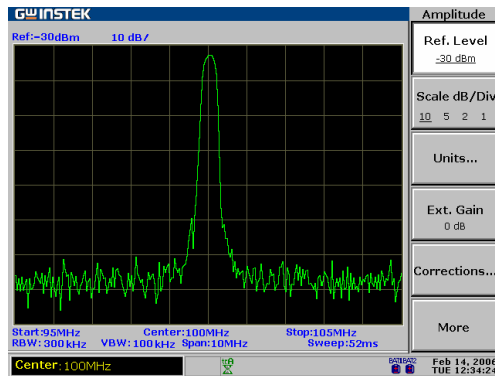
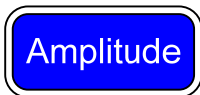



Vertical Scale Setting	Set reference amplitude.....	49
	Select amplitude scale	50
	Select amplitude unit	50
	Set external offset level	51
Amplitude Correction	Correct amplitude step by step.....	52
	Delete entire correction set data	55
	Recall existing correction set.....	55
	Save/copy/delete/rename correction file.....	56
Pre-Amplifier	Use Pre-Amplifier (Optional).....	56
Input Impedance	Select input impedance (50Ω/75Ω)	57
	Set impedance offset (75Ω only)	57

Set Vertical Scale

Vertical display scale is defined by the reference amplitude, amplitude range, measurement unit, and external gain/loss.

Set reference amplitude

The reference level defines the amplitude at the top of the displayed range (see below screen snapshot).

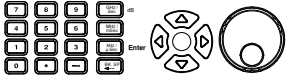
- | | | |
|-----------------|--|---|
| Panel operation | 1. Press the Amplitude key. |  |
| | 2. Press F1 (Ref.Level). |  |
| | 3. Enter the value using the Numerical and Unit keys, Arrow keys, and Scroll knob. |  |
- *Arrow keys and Scroll knob resolution: vertical scale

Range	dBm	-110 to +20 dBm, 0.1dB resolution
	dBmV	-63.01 to +66.99 dBmV, 0.01dB resolution
	dBuV	-3.01 to +126.99 dBuV, 0.01dB resolution



See page50 for selecting amplitude units.

Display

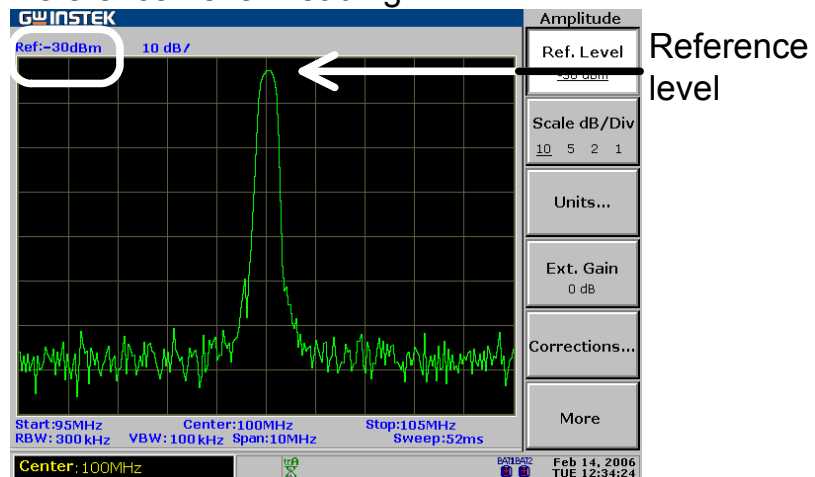
Reference Level Reading









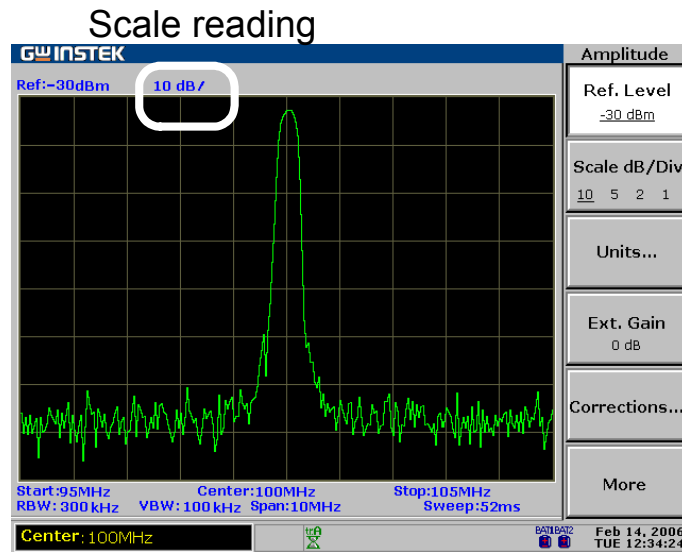

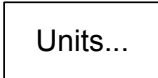

Select amplitude scale

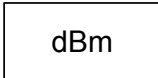
Panel operation	1. Press the Amplitude key.	
	2. Press F2 (Scale dB/Div) repeatedly to select the scale.	 
Range	10, 5, 2, 1 dB/Div	

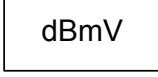
Display

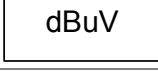

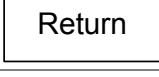

Select amplitude unit

Panel operation	1. Press the Amplitude key.	
	2. Press F3 (Units).	 
	3. Select and press the unit from F1 (dBm), F2 (dBmV), and F3 (dBuV).	 
		 
 		
4. Press F6 (Return) to go back to the previous menu.	 	

Range	dBm	-110 to +20 dBm
	dBmV	-63.01 to +26.99 dBmV
	dBuV	-3.01 to +126.99 dBuV

Set external offset level

Background External offset compensates the amplitude gain or loss caused by an external network or device.

- Panel operation**
1. Press the Amplitude key. 
 2. Press F4 (Ext.Gain). 
 3. Enter the value using the Numerical keys and dB or Enter key. 

Range -20.0dB to +20.0dB, 0.1dB resolution

Icon  The amplitude icon appears at the bottom of the display when the external offset changes.

Example
Before (offset: 0dB)

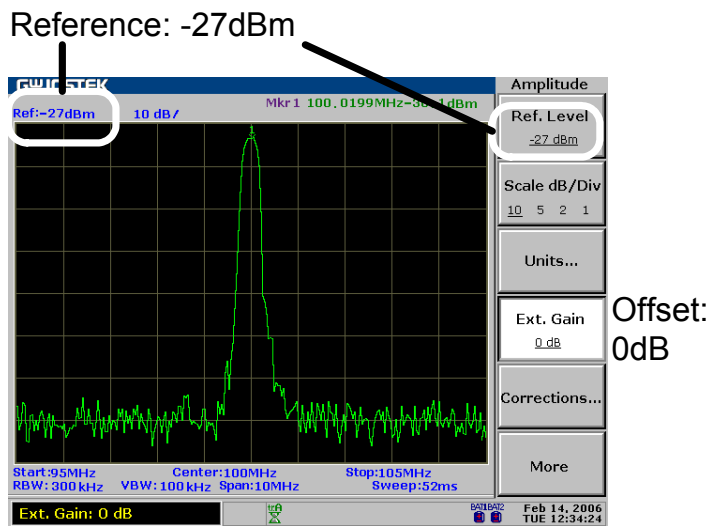

After (offset: -3dB)

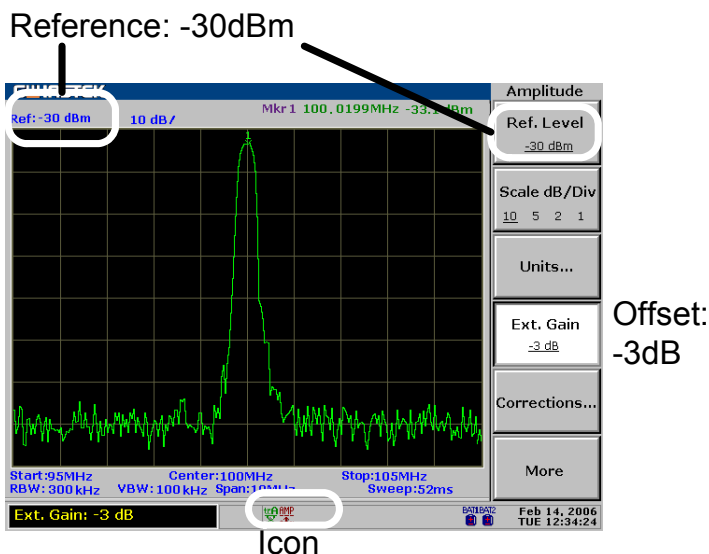

Amplitude Correction

Overview

Background	Amplitude correction adjusts the GSP-830's frequency response by changing amplitudes for specific frequencies.	
Range	Correction set	5 sets, 30 correction points each
	Amplitude	-40 to +40dB per correction point, 0.1dB resolution
	Frequency	9kHz to 3GHz, 1kHz resolution
Icon		The amplitude icon appears at the bottom of the display when amplitude correction is on.

Correct amplitude step by step

Example description	In this example, the network between the GSP-830 and DUT distorts the waveform and pushes the amplitude down at around 2.4GHz. Amplitude correction can bring the amplitude back to its original level.
Correction level	In this example the amplitude around 2.4GHz is boosted by +1 to +3dB as shown below.
	2.2GHz +2.5dB
	2.3GHz +1.3dB
	2.4GHz +2.8dB
	2.5GHz +2.5dB
	2.6GHz +1.2dB

Waveform (before correction) The frequency response is distorted (non-flat) and the level is attenuated by 2 to 3dB.

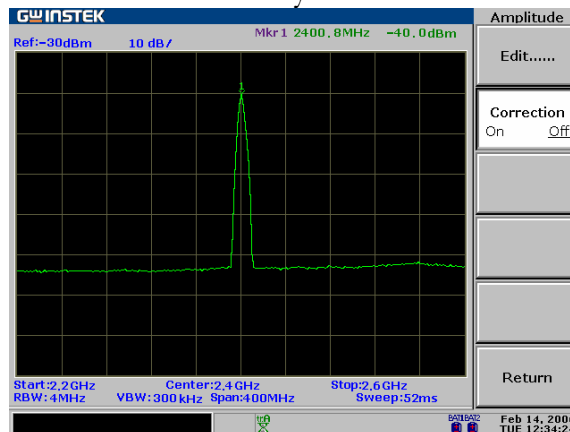

1. Enter correction edit mode



2. Press F5 (Corrections).

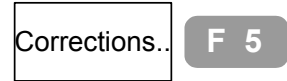

3. Press F1 (Edit). The display shows the correction sets.

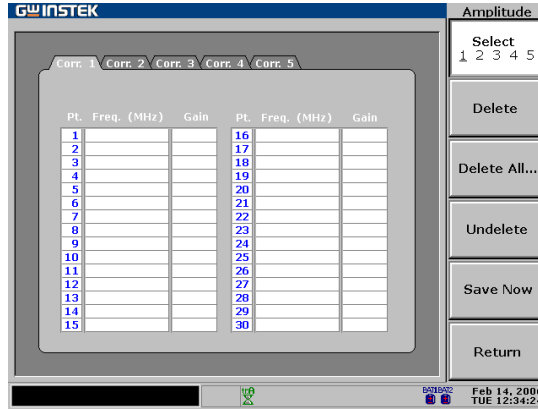
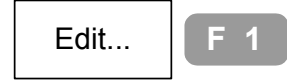

2. Select correction set
- Press F1 (Select) repeatedly to select the correction set. 5 sets, 30 points each, are selectable.

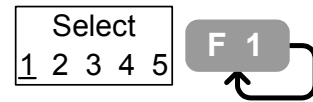

Example: correction set 3 selected

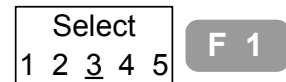

- 3a. Add correction point

1. Make sure that the cursor is pointing to the first empty frequency point.

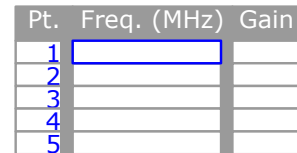

2. If necessary, move the cursor using the Up/Down keys.



3. Enter the frequency using the Numerical and Unit keys: 9kHz to 3GHz.



4. The cursor automatically moves to the Gain side. Enter the gain using the Numerical keys and dB key. Range: -40dB to +40dB.

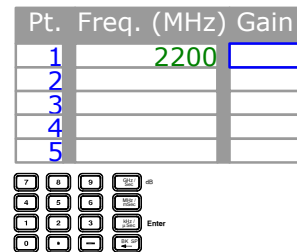

5. Repeat the above procedure for all correction data. The points are automatically sorted by frequency (low → high).

3b. Modify correction point

1. Move the cursor using the Arrow keys.



2. Enter the new frequency or gain using the Numerical keys and Unit keys or dB key.

Pt.	Freq. (MHz)	Gain
1	2200	2.5
2	2300	1.3
3	2400	2.8
4	2500	1.8
5	2600	1.2



3c. Delete correction point

1. Move the cursor to the target using the Arrow keys.



2. Press F2 (Delete). The frequency and gain are deleted together.



3. To undo the last deletion, press F4 (Undelete).



Example: point 3 deleted

Pt.	Freq. (MHz)	Gain		Pt.	Freq. (MHz)	Gain
1	2200	2.5	→	1	2200	2.5
2	2300	1.3		2	2300	1.3
3	2400	2.8		3	2500	1.8
4	2500	1.8		4	2600	1.2
5	2600	1.2		5		

4. Save correction set

1. Press F5 (Save Now). The edited data is saved internally.

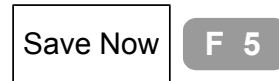

2. Press F6 (Return) to go back to the previous menu.

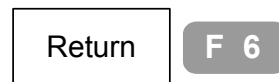

5. Activate correction

1. Press F2 (Correction On) to turn on the correction.

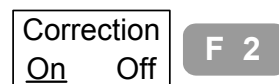

2. The amplitude icon appears at the bottom of the display.







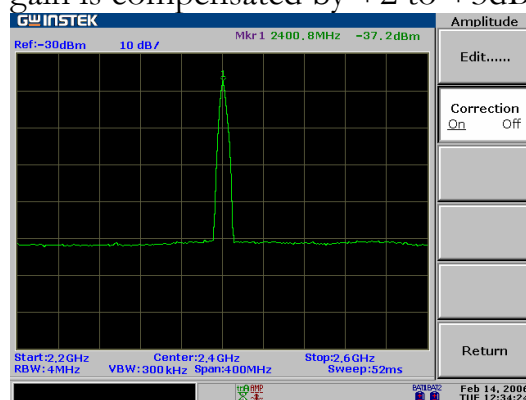



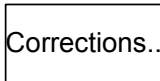



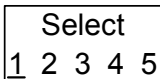

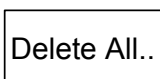
After correction

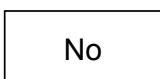

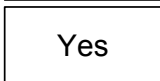

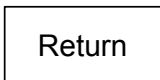



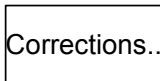

Frequency response becomes linear (original), and the gain is compensated by +2 to +3dB.



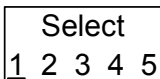

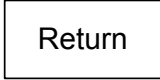

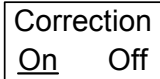

Delete entire correction set data

Panel operation	1. Press the Amplitude key.	
	2. Press F5 (Corrections).	 
	3. Press F1 (Edit). The display shows the correction sets.	 
	4. Press F1 (Select) repeatedly to select the correction set.	  
	5. Press F3 (Delete All).	 
	6. Press F2 (Yes). The whole data in the specified correction set is deleted. To cancel deletion, press F1 (No).	   
	7. Press F6 (Return) repeatedly to go back to previous menus.	  

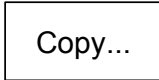
Recall existing correction set

Panel operation	1. Press the Amplitude key.	
	2. Press F5 (Corrections).	 
	3. Press F1 (Edit). The display shows the correction sets.	 
	4. Press F1 (Select) repeatedly to select the correction set.	  
	5. Press F6 (Return) to go back to the previous menu.	 
	6. Press F2 (Correction On) to activate the correction data.	 

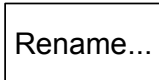
Save/copy/delete/rename correction file

Background	Correction files can be saved, copied, deleted, or renamed using the file utilities. Press the File key to access each function.	
Save/Copy	Press F1 (Copy). For detailed steps, see page115.	 
Delete	Press F2 (Delete). For detailed steps, see page118.	 
Rename	Press F3 (Rename). For detailed steps, see page120.	 

Use Pre-Amplifier (Optional)

Background	The optional pre-amplifier GAP-801 or GAP-802 boosts weak input signals such as in EMI testing to levels that are easy to handle, over the entire frequency range.				
Range	<table border="0"> <tr> <td>GAP-801</td> <td>9kHz to 6GHz, 10dB typical</td> </tr> <tr> <td>GAP-802</td> <td>9kHz to 3GHz, 20dB typical</td> </tr> </table>	GAP-801	9kHz to 6GHz, 10dB typical	GAP-802	9kHz to 3GHz, 20dB typical
GAP-801	9kHz to 6GHz, 10dB typical				
GAP-802	9kHz to 3GHz, 20dB typical				
Connection	<ol style="list-style-type: none"> Connect the pre-amplifier between the input terminal and DUT signal output. Connect the pre-amplifier power input to the GSP-830 DC 9V output. 				

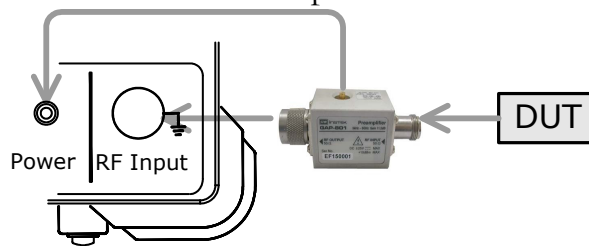



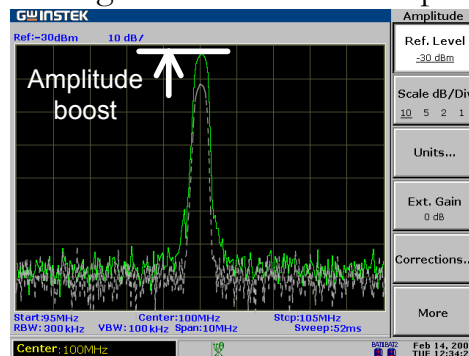

- The signal level becomes amplified.





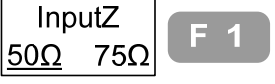

Set Input Impedance

Select input impedance (50Ω/75Ω)

Background	In most cases, the default 50Ω is appropriate. Use 75Ω when specifically required, such as in cable TV signals.	
Panel operation	1. Press the Amplitude key.	
	2. Press F6 (More).	
	3. Press F1 (Input Z 50Ω/75Ω) to select the impedance.	
	4. When 75Ω is selected, the amplitude icon appears at the bottom of the display.	

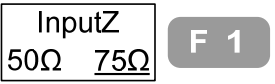
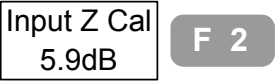
Set impedance offset (75Ω only)

Background	Impedance transformation to 75 Ω is also available through external devices such as impedance converter module (optional accessory ADP-101). In these cases an external loss will be induced. Impedance offset can compensate this effect.	
Panel operation	1. Press the Amplitude key.	
	2. Press F6 (More).	
	3. Make sure 75Ω is selected in F1 (Input Z).	
	4. Press F2 (Input Z Cal).	
	5. Enter the offset using the Numerical keys and dB or Enter key.	
Range	-10dB to +10dB, 0.1dB resolution	

AUTOSET

The **Autoset** function checks input signal characteristics and automatically searches the maximum peak signal, then sets up the suitable horizontal and vertical scale. The amplitude floor (which limits the search range) and frequency observation span (which limits the viewing range) are configurable according to the application needs.

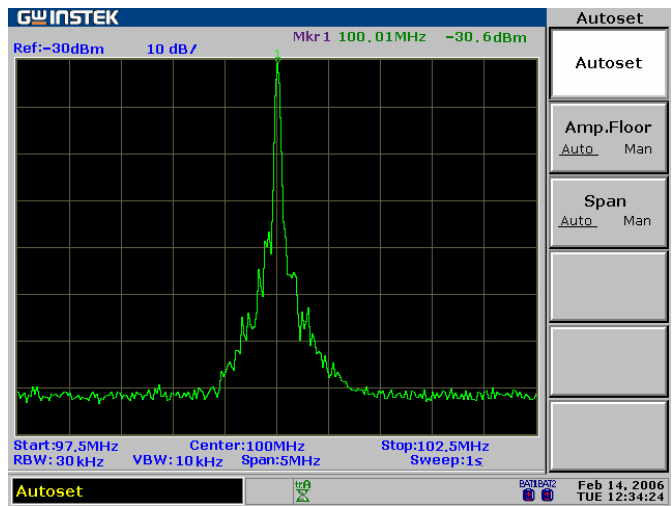

Overview	How Autoset Works	59
Run	Run Autoset.....	60
Limit Range	Limit vertical search range.....	61
	Limit horizontal view range	61

How Autoset Works

Description The Autoset function searches the peak signals in two stages (full span & 0Hz - 100MHz limited span), picks up the signal peak with the maximum amplitude, and then shows it in the display. The following flowchart graphically shows the simplified procedures.

Flowchart

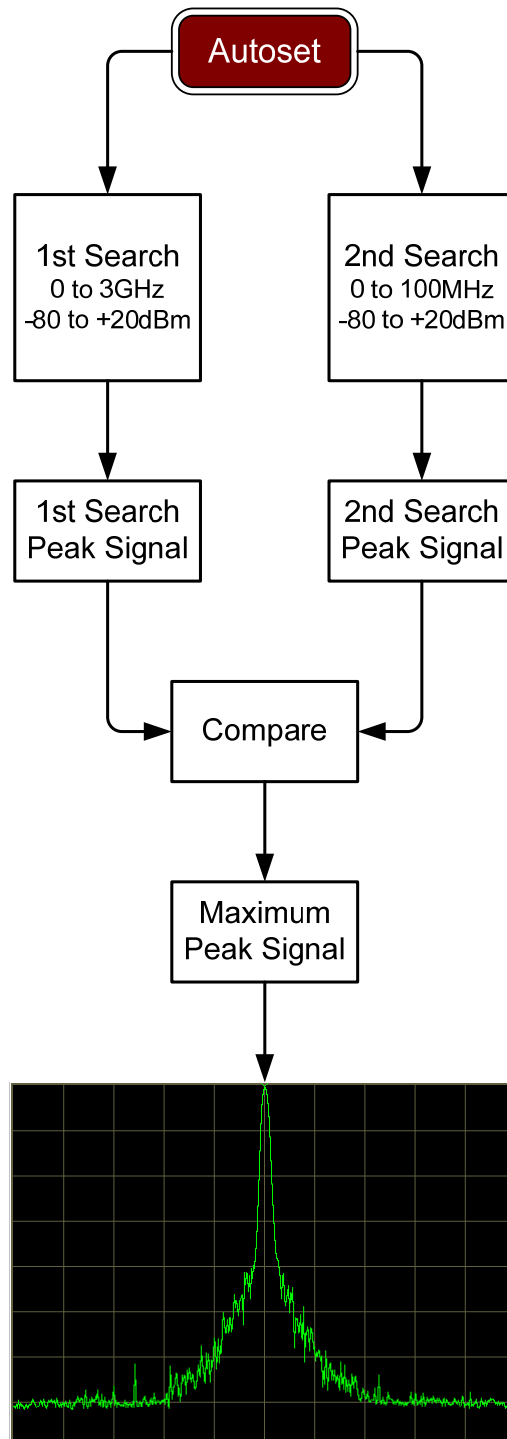

Run Autoset

Panel operation

1. Press the Autoset key.



2. Press F1 (Autoset).



Search range

Amplitude	dBm	-80 to +20dBm
	dBmV	-33.01to+66.99dBmV
	dBuV	+26.99to+126.99dBuV

Frequency 0kHz to 3.0GHz

* These ranges are applicable when both Amplitude floor (F2) and Span limit (F3) are set to Auto.

Example: before Autoset

Start frequency: 0kHz	Stop frequency: 3GHz
Span: 3GHz	Signal peak: 100MHz
Center frequency: 1.5GHz	Reference level: -30dBm

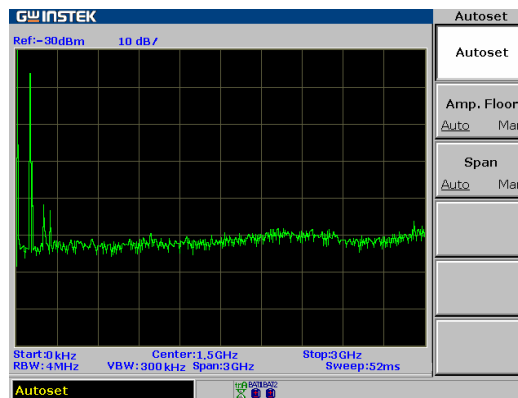

Example: after Autoset

Start frequency: 97.5MHz	Stop frequency: 102.5MHz
Span: 5MHz	Signal peak: 100MHz
Center frequency: 100MHz	Reference level: -30dBm

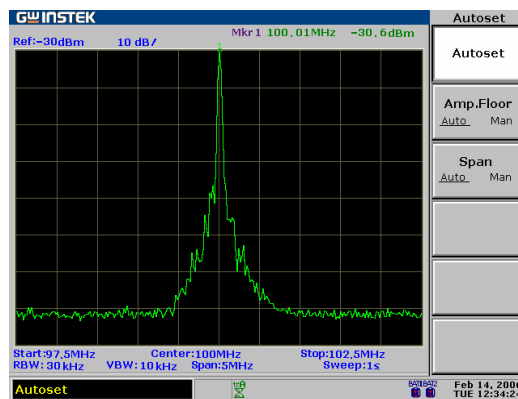



RBW/VBW/Sweep after Autoset All the three BW related parameters, RBW, VBW, and Sweep, will be reset to Auto mode when using Autoset, regardless of their previous settings.



Limit vertical search range



Background You can set the amplitude floor so that the signals lower than the setting will be ignored by the Autoset search.

- Panel operation**
1. Press the Autoset key. 
 2. Press F2 (Amp. Floor) to switch the range from Auto (whole range) to manual (limited range). 
 3. Enter the amplitude in dB using the Numerical keys and dB or Enter key. The Command window shows the setting. 

Range	dBm	-80 to +20dBm, 0.1dB resolution
	dBmV	-33.01 to +66.99dBmV, 0.01dB resolution
	dBuV	+26.99 to +126.99dBuV, 0.01dB resolution
See page50 for selecting amplitude units.		

Limit horizontal view range

Background You can change the frequency span limit in the display to get a better view of the Autoset result. By default, the frequency span after Autoset is set at 3MHz (Auto).

- Panel operation**
1. Press the Autoset key. 
 2. Press F3 (Span) to switch the range between Auto (3MHz fixed limit) to Manual. 
 3. Enter the frequency using the Numerical and Unit keys. 

Range	Zero span, 2kHz to 3GHz (Manual) 3MHz fixed (Auto)
--------------	--

M ARKER

A **Marker** shows the frequency and amplitude of a waveform point. The GSP-830 can activate up to 5 markers or marker pairs simultaneously. The marker table helps editing and viewing multiple markers in a single display. You can also enable/disable all markers at once. A delta marker shows the frequency and amplitude differences between the reference marker. The GSP-830 can automatically move a marker to various locations including peak signal, center frequency, and start/stop frequency. More marker operations regarding signal peaks are also available in the **Peak Search** function.

Marker

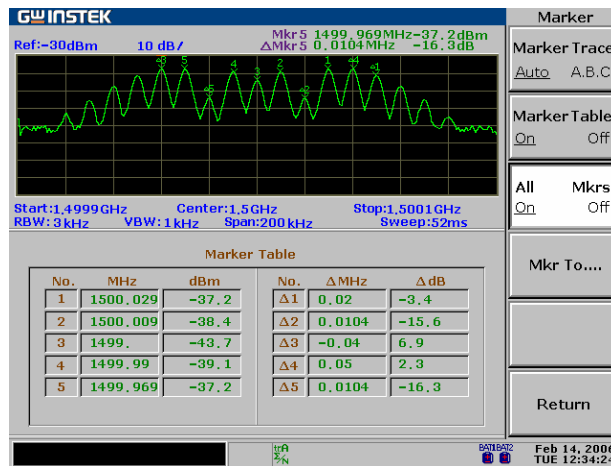

Activate Marker(s)	Activate normal marker	63
	Activate all 5 normal markers at once	64
	Activate delta marker	64
Move Marker(s)	Move marker manually	65
	Move marker to highest peak	65
	Move marker and highest peak to center.....	66
	Move marker to various locations	66
	Move marker to trace	67
Marker Table	Show Markers in Table.....	67

Activate/de-activate marker

Range	Normal marker	5
	Delta marker	5 pairs
Amplitude	-120 to +20dBm, 0.1dB resolution -73.01 to +66.99dBmV, 0.01dB resolution -13.01 to +126.99dBuV, 0.01dB resolution	
Frequency	0kHz to 3GHz	



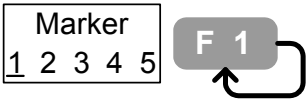
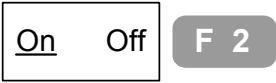
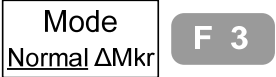

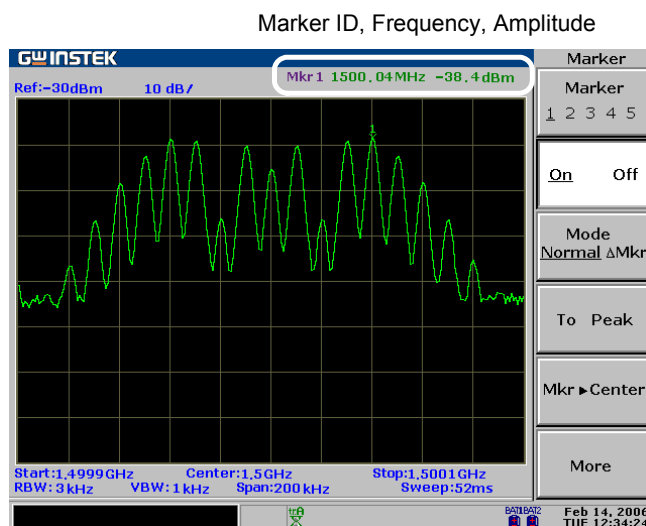

Activate normal marker

Panel operation	1. Press the Marker key.	
	2. Press F1 (Marker) repeatedly to select the marker ID from 1 to 5.	
	3. Press F2 (On) and turn On the selected marker.	
	4. Make sure Normal is selected in F3. If necessary, press F3 and select it.	
	5. Repeat the above steps for the number of markers required.	

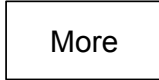
Display The upper right corner of the display shows the active marker.

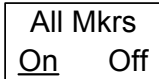

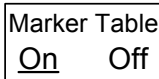



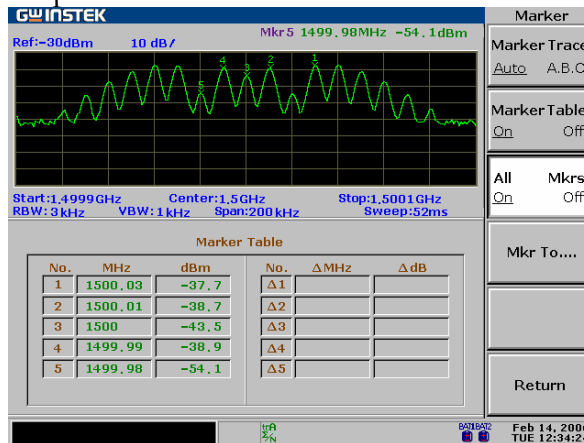

Activate all 5 normal markers at once

- Panel operation
1. Press the Marker key. 
 2. Press F6 (More).  
 3. Press F3 (All Mkrs On) to turn On all 5 normal markers.  
 4. To view all marker status, press F2 (Marker Table On). The frequency and the amplitude of the markers appear in table list.  

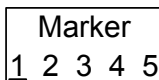
Display The marker table shows all 5 marker frequencies and amplitudes.

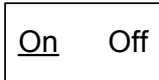

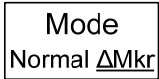
Activate delta marker

- Panel operation
1. Press the Marker key. 
 2. Press F1 (Marker) repeatedly to select the marker ID from 1 to 5.  
 3. Press F2 (On) and turn on the selected marker.  
 4. Make sure Δ Mkr is selected in F3. If necessary, press F3 and select Δ Mkr.  
 5. Repeat the above steps for the number of markers required.

Display The upper right corner of the display shows the active delta marker pair.

Move marker

This section assumes at least one marker is already activated (page63). Marker frequency positions can be set manually, or can be automatically positioned at specific locations using the menu shortcuts.

Move marker manually

Panel operation

1. Check the active marker at the top right corner of the display.
2. Move the marker using the Left/Right keys and Scroll knob, or directly enter the frequency using the Numerical and Unit keys.

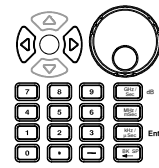
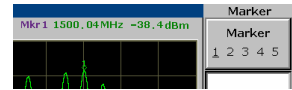

Move marker to highest peak

Method 1

1. Check the active marker at the top right corner of the display.
2. Press the Marker key.
3. Press F4 (To Peak).

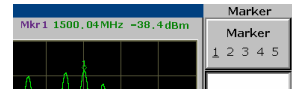

Method 2

1. Alternatively, press the Peak Search key.
2. Press F1 (Pk Search).

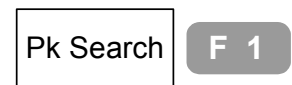





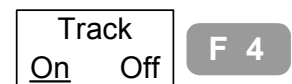



Method 3 (marker tracked to the peak)

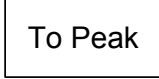









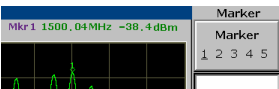

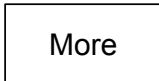

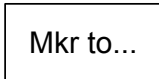

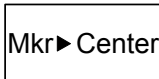

1. Another method moves marker to the peak and also tracks it. Press the Peak Search key.
2. Press F6 (More).
3. Press F4 and select Track On. The marker is tracked to the peak.
4. The peak tracking icon appears at the bottom of the display.

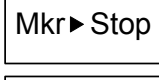

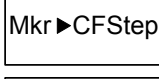

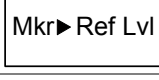

Move marker and highest peak to center

Method 1	1. Check the active marker at the top right corner of the display.	
	2. Press the Marker key.	
	3. Press F4 (To Peak). The marker moves to the signal peak.	 
	4. Press F5 (Mkr→Center). The signal peak moves to the center.	 
Method 2	1. Alternatively, press the Peak Search key.	
	2. Press F5 (Mkr→Center). The signal peak moves to the peak, then to the display center.	 





Move marker to various locations

Panel operation	1. Check the active marker at the top right corner of the display.	
	2. Press the Marker key.	
	3. Press F6 (More).	 
	4. Press F4 (Mkr to...)	 
	5. Select the destination and press F1 (Center) to F5 (Ref Lvl).	 
	Center: center frequency Start: start frequency Stop: stop frequency CF Step: set the marker frequency as the frequency step value Ref Lvl: reference amplitude level	       
6. Press F6 (Return) to go back to the previous menu.	 	

Move marker to trace

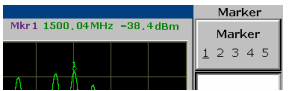
Panel operation	1. Check the active marker at the top right corner of the display.	
	2. Press the Marker key.	
	3. Press F6 (More).	
	4. Press F1 (Marker Trace).	
Range	Auto	The marker moves to the active signal/trace.
	TraceA	The marker moves to TraceA.
	TraceB	The marker moves to TraceB.
	TraceC	The marker moves to TraceC.

Show Markers in Table

Panel operation	1. Check the active marker at the top right corner of the display.	
	2. Press the Marker key.	
	3. Press F6 (More).	
	4. Press F2 (Marker Table On).	
	5. The marker ID, frequency, and amplitude list appears in the lower half of the display, updated in real time.	

Display

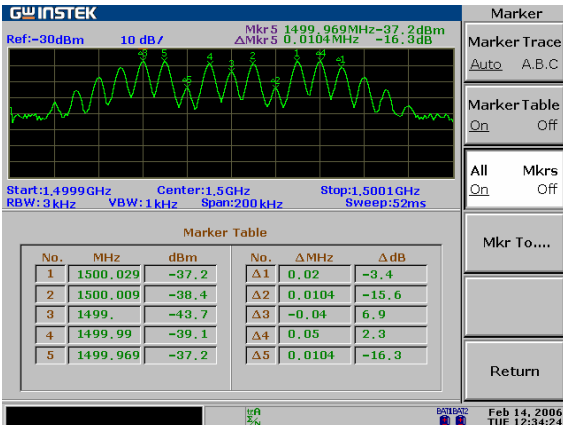

No.	MHz	dBm	No.	ΔMHz	ΔdB
1	1500.029	-37.2	Δ1	0.02	-3.4
2	1500.009	-38.4	Δ2	0.0104	-15.6
3	1499.	-43.7	Δ3	-0.04	6.9
4	1499.99	-39.1	Δ4	0.05	2.3
5	1499.969	-37.2	Δ5	0.0104	-16.3

PEAK SEARCH

The **Peak search** function automatically locates signal peaks in various conditions, such as in next highest peak and minimum peak. The Peak Search overlaps its feature with the **Marker** function, and it is best to use the two together. All peaks can be viewed at once using the peak table, with configurable amplitude threshold and sorting order.

Peak Search

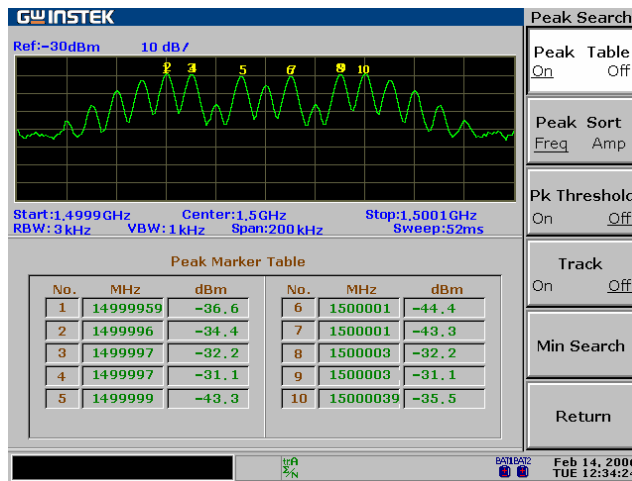

Search Signal Peaks	Search signal peak	69
	Search next highest peak	70
	Search highest peak and move to center	70
	Search minimum amplitude	71
Show Peak Table	Activate peak table.....	71
	Set peak threshold	72
	Sort peak	72

Search Signal Peak

Peak Search puts a marker on the target signal peak. If no marker has been activated, the GSP-830 automatically activates marker 1. The peak signal frequency and amplitude appear at the top right corner of the display.

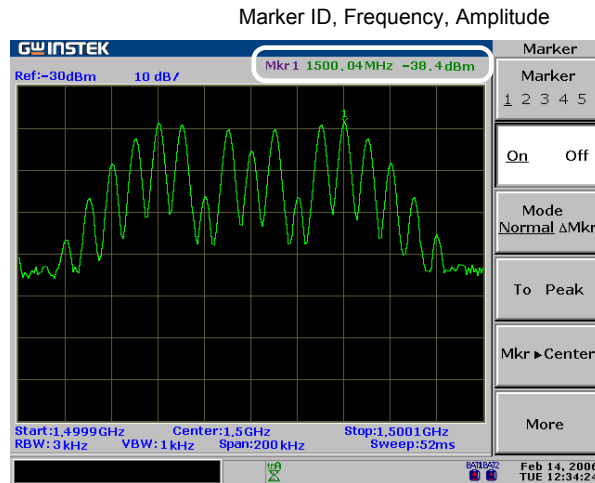

Search signal peak

Method 1	1. Press the Peak Search key.	
	2. Press F1 (Pk Search).	
Method 2	1. Make sure that the marker is already activated. If not, press the Marker key.	
	2. Press F4 (To Peak).	
Method 3 (marker tracked to the peak)	1. Another method continuously tracks the peak signal. Press the Peak Search key.	
	2. Press F6 (More).	
	3. Press F4 (Track On). The marker is tracked to the peak signal.	
	4. The peak tracking icon appears at the bottom of the display.	

Search next highest peak

The marker keeps moving to the next highest peak, in descending order.

Panel operation

1. Press the Peak Search key.



2. Press F2 to F4 repeatedly. **Next Peak** moves the marker to the next highest peak. **Next Pk Right** moves the marker to the next highest peak on the right side (higher frequency). **Next Pk Left** moves the marker to the next highest peak on the left side (lower frequency).

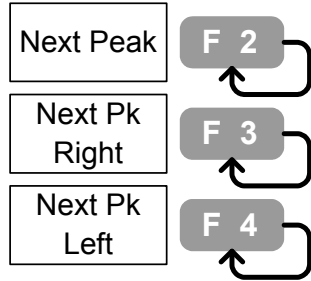

Display

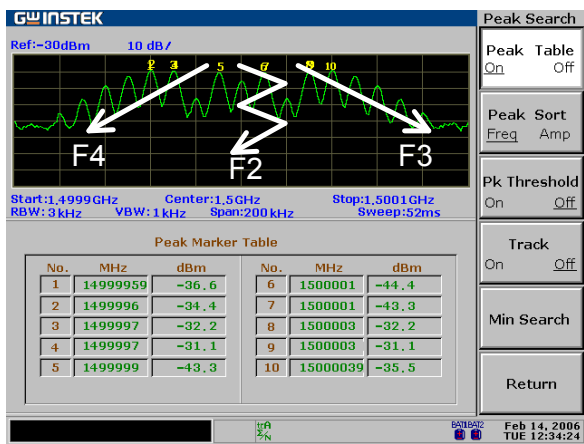

Search highest peak and move to center

Method 1

1. Press the Peak Search key.



2. Press F1 (Pk Search).







Method 2

1. Make sure that the marker is already activated. If not, press the Marker key.
2. Press F4 (To Peak).
3. Press F5 (Mkr to Center).





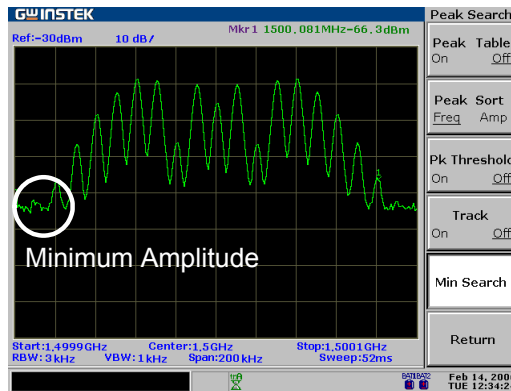

Search minimum amplitude

- Panel operation
1. Press the Peak Search key. 
 2. Press F6 (More).  
 3. Press F5 (Min Search). The active marker moves to the deepest valley in the trace.  

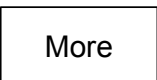

Show Peak Table

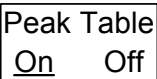
Activate peak table



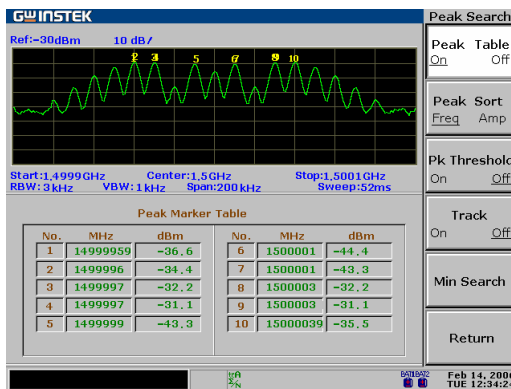

- Panel operation
1. Press the Peak Search key. 
 2. Press F6 (More).  
 3. Press F1 (Peak Table On). The peak table appears in the lower half of the display.  



Range 10 peaks maximum

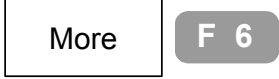

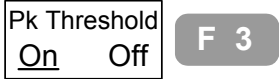
Set peak threshold

Only the peaks below the threshold amplitude will be listed in the table.

Panel operation	1. Press the Peak Search key.	
	2. Press F6 (More).	
	3. Press F1 (Peak Table On).	
	4. Press F3 (Pk Threshold On).	
	5. A horizontal line appears on the display. The GSP-830 searches and lists the peaks below this threshold amplitude.	
	6. Use the Arrow keys or the Scroll knob to move the threshold line.	

Sort peak

The peaks are sorted in ascending frequency or descending amplitude order.

Panel operation	1. Press the Peak Search key.	
	2. Press F6 (More).	
	3. Press F2 (Peak Sort) to switch between frequency and amplitude sorting.	

Example: amplitude sort

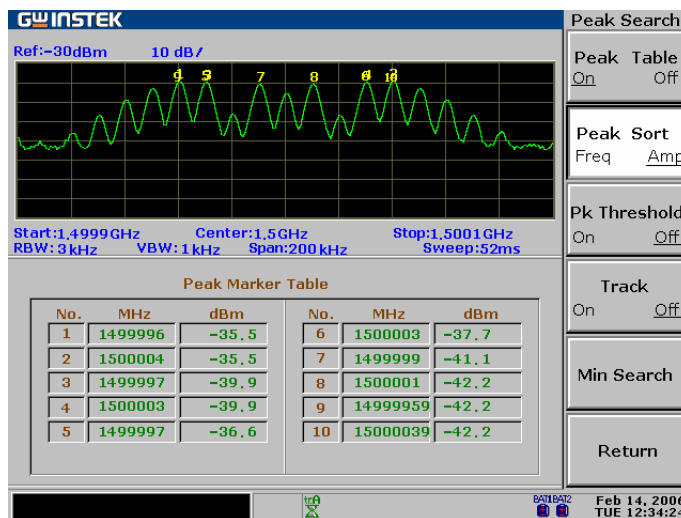

T RACE

A **Trace** keeps track of waveform variants. Three traces, A, B, and C, are available for accumulating the peak level, freezing the current waveform shape, and averaging the waveform. Trace math operations are available using trace A and B.

Detection modes configure the way the GSP-830 samples the input analog signal for digitizing.

Trace

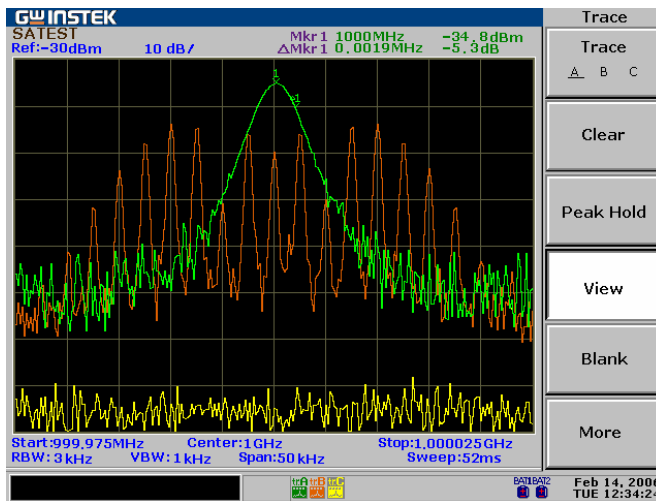



View Trace	Select (activate) trace	74
	View real-time updated trace (default).....	74
	View peak-hold trace.....	74
	Freeze trace.....	75
	Hide trace	75
Move Trace	View averaged trace	75
	Move Marker to Trace	76
	Save/copy/delete/rename trace file	77
Trace Math	Run Trace Math.....	78
Detection Mode	Select Signal Detection Mode	80

View traced waveform

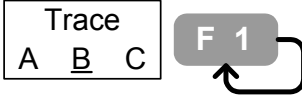
Select (activate) trace

Panel operation	1. Press the Trace key.	
	2. Press F1 (Trace) repeatedly to select the trace.	
Range	A (green)	The default trace which is always activated. Together with trace B, runs trace math operation (page78).
	B (amber)	Together with trace A, runs trace math operation (page78).
	C (yellow)	

View real-time updated trace (default)

Background	The trace is updated at every sweep. The old trace is cleared up and a new trace is drawn on the display according to the latest measurement.	
Panel operation	1. Press the Trace key.	
	2. Press F2 (Clear).	
	3. The clear mode icon appears at the bottom of the display.	

View peak-hold trace

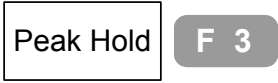
Background	In the peak hold mode, the amplitude of the new trace is compared with the last one at each sweep. Only the higher amplitude replaces old trace points, thus holding the highest (peak) value.	
Panel operation	1. Press the Trace key.	
	2. Press F3 (Peak Hold).	

- The peak hold trace icon appears at the bottom of the display.



Display

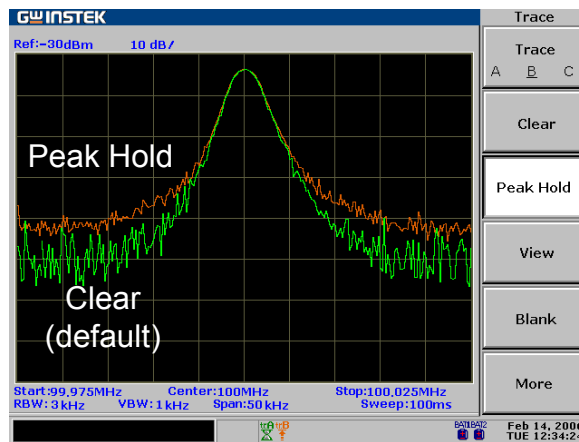

Freeze trace

Panel operation

- Press the Trace key.
- Press F4 (View). The trace shape and location becomes fixed.
- The view mode (freeze) icon appears at the bottom of the display.

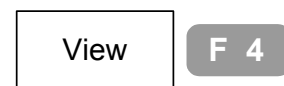
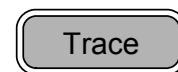

Hide trace

Panel operation

- Press the Trace key.
- Press F5 (Blank). The trace disappears from the display.
- To bring back the trace again, press F2 (Clear).

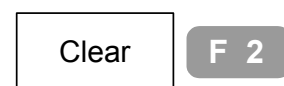
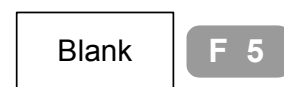
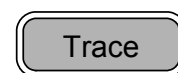





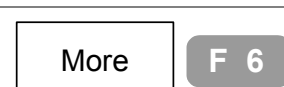
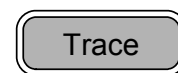

View averaged trace

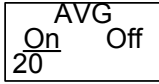
Panel operation (Method1)

- Press the Trace key.
- Press F6 (More).

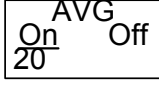





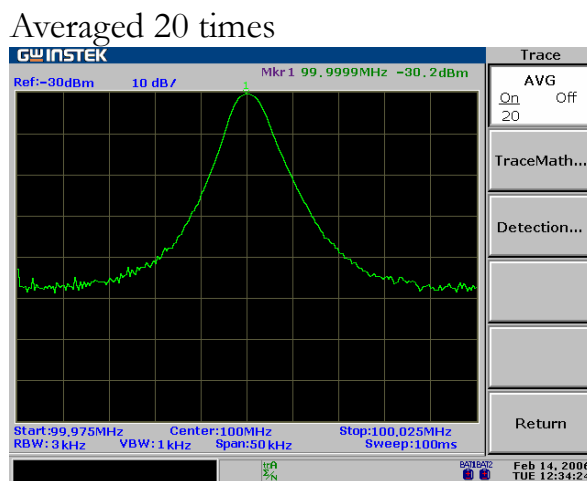

	3. Press F1 (AVG On) to turn on the average mode.		
	4. The average mode icon appears at the bottom of the display.		
	5. Enter the average number using the Numerical keys and Enter key.		
Panel operation (Method2)	1. Press the BW key.		
	2. Press F4 (AVG On) to turn on averaging.		
	3. Enter the average time using the numerical keys and Enter key.		
Range	1 to 200		

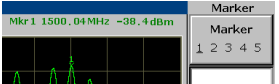
Example: after average

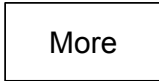

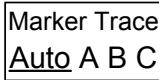
Move Marker to Trace

Panel operation	1. Check the active marker at the top right corner of the display.		
	2. Press the Marker key.		
	3. Press F6 (More).		
	4. Press F1 (Marker Trace).		
Range	Auto	The marker moves to the active signal or trace.	





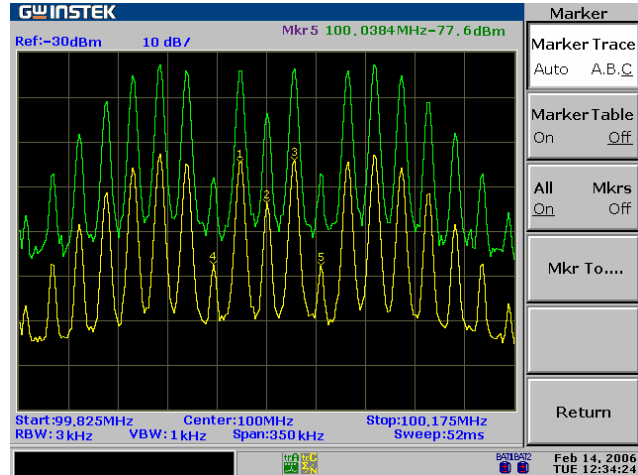

TraceA	The marker moves to TraceA.
TraceB	The marker moves to TraceB.
TraceC	The marker moves to TraceC.

Display

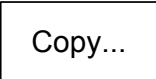
Marker on TraceC

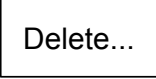

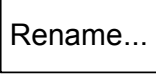
Save/copy/delete/rename trace file











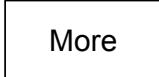

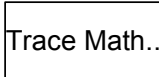

Background	Trace files can be saved, copied, deleted, or renamed using the file utility. Press the File key to access each function.	
Save/Copy	Press F1 (Copy). For detailed steps, see page115.	 
Delete	Press F2 (Delete). For detailed steps, see page118.	 
Rename	Press F3 (Rename). For detailed steps, see page120.	 

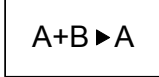
Run Trace Math

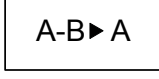
Background

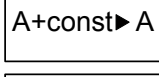
Various mathematical operations are available using trace A and trace B. Both traces have to be activated in advance (page74). After the math operation, the trace mode changes into the View mode (page75).

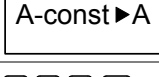
Panel operation

- Press the Trace key. 
- Press F6 (More).  
- Press F2 (Trace Math).  
- Select and press the type of math operation from F1 to F5.
 - A↔B**: Swaps trace A and B.  
 - A+B→A**: Adds trace A and B.  
 - A-B→A**: Subtracts trace B from trace A.  
 - A+const→A**: Adds a constant value to trace A.  
 - A-const→A**: Subtracts a constant value from trace A.  
- When **A+const / A-const** are selected, enter the constant value using the Numerical keys and dB or Enter key. 

Range: -40 to +40dB
- The trace math icon appears at the bottom of the display. 

Example: A↔B

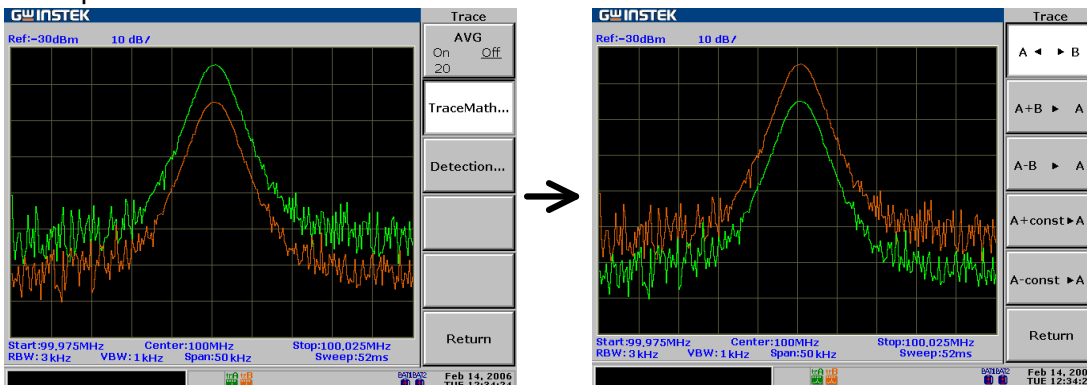

Example: $A+B \rightarrow A$

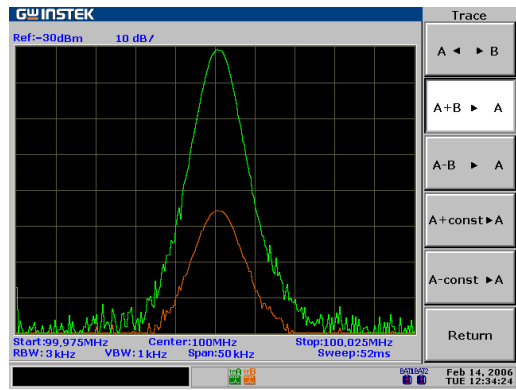
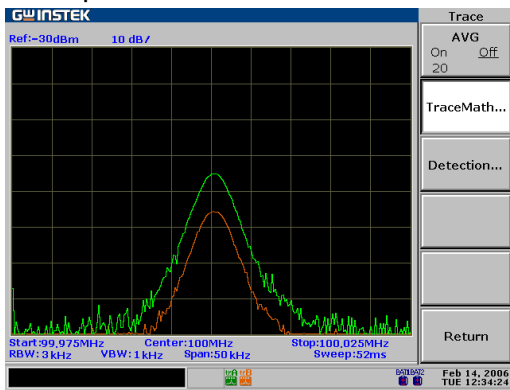

Example: $A-B \rightarrow A$

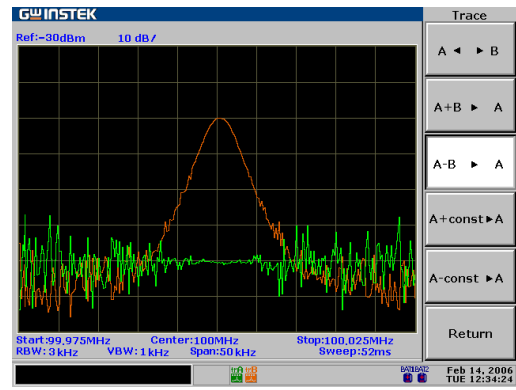
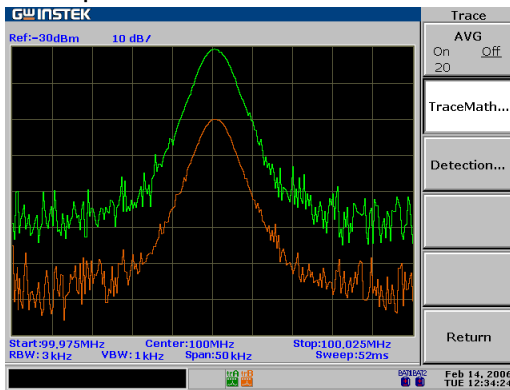

Example: $A+\text{constant} \rightarrow A$ (5 dB)

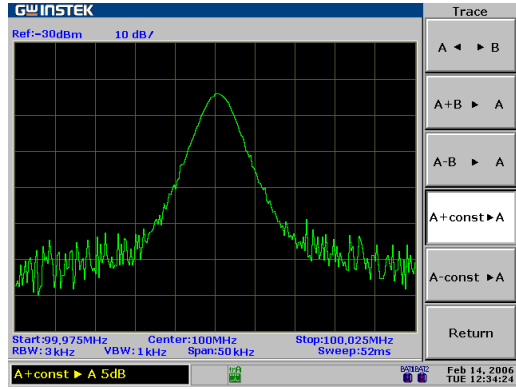
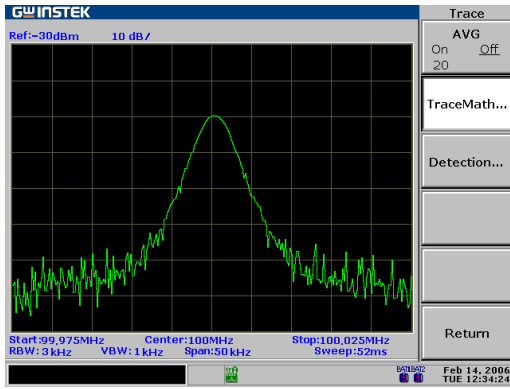



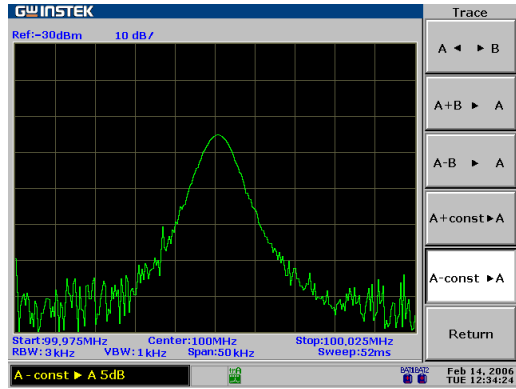
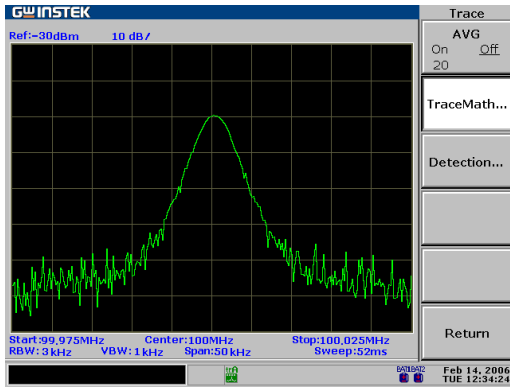



Example: $A-\text{constant} \rightarrow A$ (5 dB)

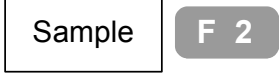
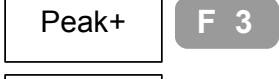
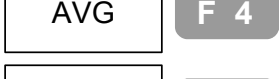

Select Signal Detection Mode

Background In order to show the incoming signal on the display, the GSP-830 first converts the input signal to a video signal, digitizes it, then uses a detector to pick up the samples for display. By configuring the detection mode, certain signals can be viewed more clearly and/or sharply.

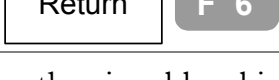
Panel operation	1. Press the Trace key.	
	2. Press F6 (More).	
	3. Press F3 (Detection).	
	4. Select the signal detection type from F1 to F5 and press it. See below for the description of each type.	
		
		
		
		
5. Press F6 (Return) to go back to the previous menu.		

Parameter	Normal	The default mode. When the signal level is constantly increasing or decreasing, the positive peaks are detected. Otherwise, detecting mode switches between positive peak and negative peaks. Useful for picking up burst phenomenon while avoiding excessive noise.
	Sample	Detects signals randomly. Useful when detecting noise-like signals, but tends to miss burst phenomenon.
	Peak+ (positive peak)	Detects positive peak signals. Useful for detecting sinusoid signals, but tends to pick up more noise than other modes.

AVG
(average) Available when the optional EMI filter is installed. Detects the average power level of the samples using low pass filter. Useful for reducing the noise level. For EMI filter details, see page146.

QPeak
(quasi-peak) Available when the optional EMI filter is is installed. Detects the quasi-peak power level of the samples. Useful for viewing in zero span without missing signal variations. For EMI filter details, see page146.

Example

Normal detection mode

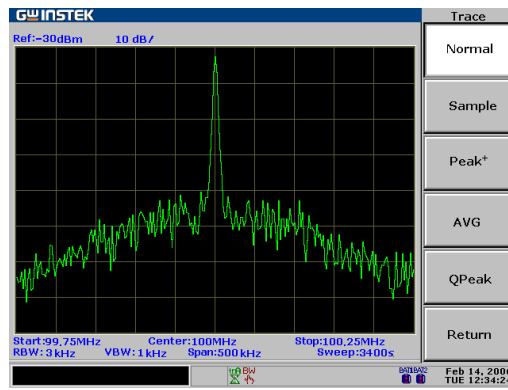

Sample detection mode

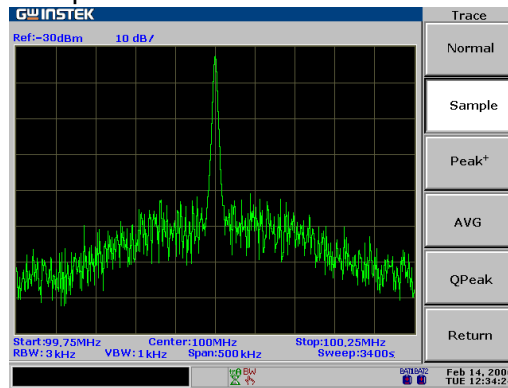

Peak+ detection mode

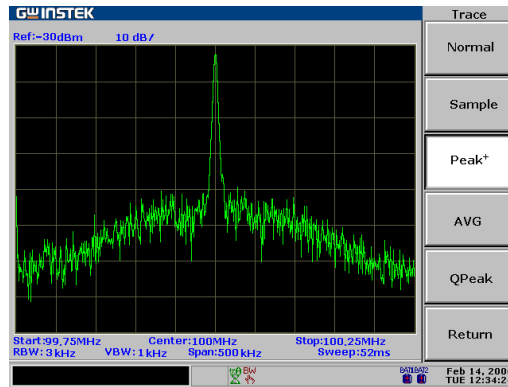

POWER MEASUREMENT

The **Power Measurement** function includes four types of frequently used complex measurement procedures: ACPR, OCBW, N dB, and Phase Jitter. Each item is configurable and updated in real-time.

Meas

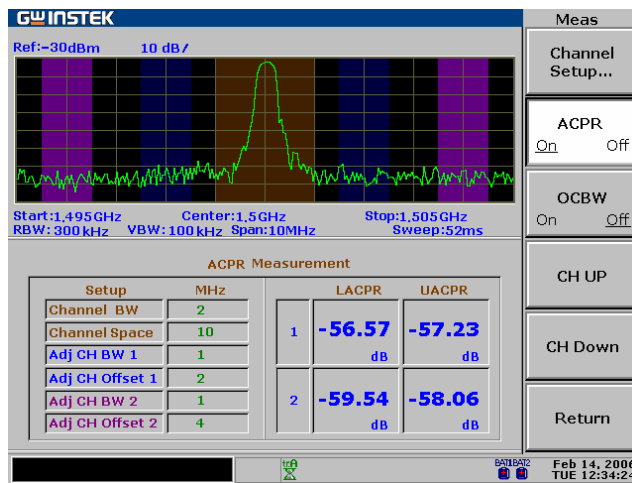



ACPR	Overview.....	83
	ACPR measurement step	83
OCBW	Overview.....	86
	OCBW measurement step.....	86
N dB	N dB Measurement.....	88
Phase Jitter	Phase Jitter Measurement.....	89

ACPR Measurement





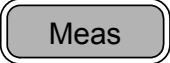

Overview

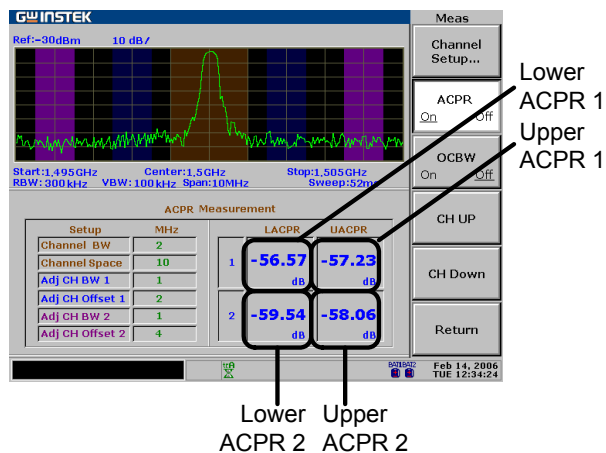
Background	ACPR (Adjacent Channel Power Ratio), or ACLR (Adjacent Channel Leakage Ratio), refers to the amount of leakage power coming from the main radio channel which affects adjacent channels as signal distortion.	
Parameter	Channel bandwidth	The frequency bandwidth the target channel occupies. Range: 0kHz to Current span
	Channel space	The frequency distance between each main channel. Range: 0kHz to 3GHz
	Adjacent channel bandwidth 1 & 2	The frequency bandwidth the adjacent channels occupy. Range: 1kHz to 3GHz
	Adjacent channel offset 1 & 2	The frequency distance between the adjacent channels and main channel. Range: 1kHz to 3GHz

ACPR measurement step

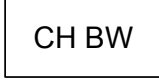



1. Activate ACPR
 1. Press the Measurement key. 
 2. Press F2 (ACPR On). 
 3. The display switches to ACPR mode, updating the ACPR results in the lower half of the display.





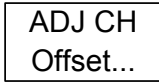

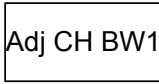

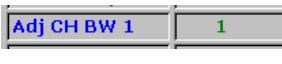
2. Set channel BW
1. Press F1 (Channel Setup).  
 2. Press F1 (CH BW).  
 3. Enter the channel BW using the Numerical and Unit keys.  Range: 0kHz to Current span
 4. The value is updated in the Channel BW column in MHz. 

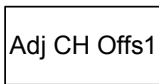





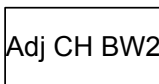

Note:

- If the span (page43) becomes less than the CHBW setting, the warning “Span is less than CHBW!” appears in the command window.
- If the CHBW is 0kHz, the warning “CHBW is zero!” appears in the command window.

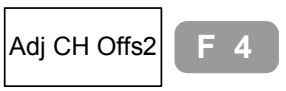
3. Set adjacent channel1 bandwidth
1. Press F4 (ADJ CH Offset).  
 2. Press F1 (Adj CH BW1).  
 3. Enter the adjacent channel 1 bandwidth using the Numerical and Unit keys.  Range: 1kHz to 3GHz
 4. The value is updated in the Adj CH BW1 column in MHz. 

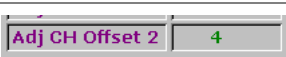
4. Set adjacent channel1 offset
1. Press F2 (Adj CH Offs1).  
 2. Enter the adjacent channel1 offset using the Numerical and Unit keys.  Range: 1kHz to 3GHz
 3. The value is updated in the Adj CH Offset1 column in MHz. 

5. Set adjacent channel2 bandwidth
1. Press F3 (Adj CH BW2).  

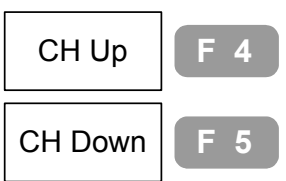

	2. Enter the adjacent channel2 bandwidth using the Numerical and Unit keys. Range: 1kHz to 3GHz	
	3. The value is updated in the Adj CH BW2 column in MHz.	
6. Set adjacent channel2 offset	1. Press F4 (Adj CH Offs2).	
	2. Enter the adjacent channel 2 offset using the Numerical and Unit keys. Range: 1kHz to 3GHz	
	3. The value is updated in the Adj CH Offset2 column in MHz.	
7. Set channel space	1. Press F2 (Channel SPC).	
	2. Enter the channel space using the Numerical and Unit keys. Range: 0kHz to 3GHz	
	3. The value is updated in the Channel Space column in MHz.	
8. Move channel up/down	1. Press F6 (Return) twice.	 x2
	2. Press F4 (CH Up) or F5 (CH Down) to switch the measurement to the next channel.	

OCBW Measurement

Overview

Background	OCBW (OCcupied BandWidth) refers to the bandwidth of the channel that consumes (occupies) the specified amount of power.	
Parameter	Channel bandwidth	The frequency bandwidth that the target channel occupies. 0kHz to Current span
	Channel space	The frequency distance between each main channel. 0kHz to 3GHz
	OCBW %	The ratio of occupied bandwidth as the amount of power consumed. 0% to 100%, 0.1% resolution

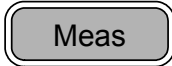
OCBW measurement step

1. Activate OCBW
 1. Press the Measurement key. 
 2. Press F3 (OCBW On). 
 3. The display switches to OCBW mode, updating the OCBW result in the lower half of the display.

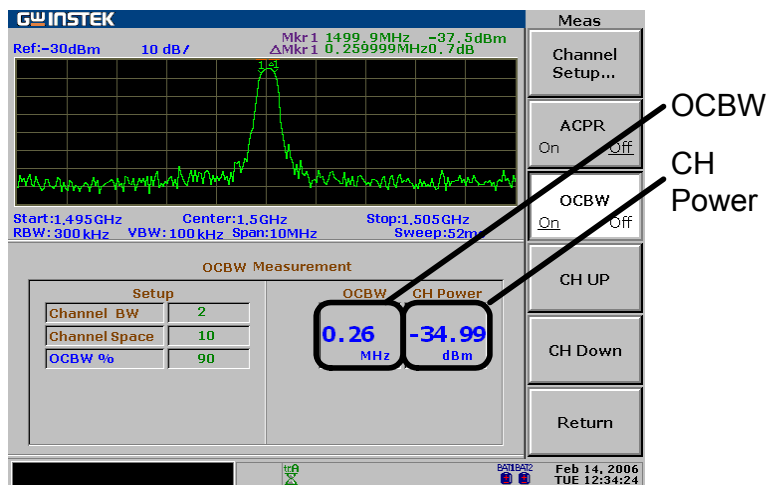



2. Set channel BW
 1. Press F1 (Channel Setup). 

- | | | |
|----|--|--|
| 2. | Press F1 (CH BW). | <div style="border: 1px solid black; padding: 2px; display: inline-block;">CH BW</div> <div style="border: 1px solid black; padding: 2px; margin-left: 10px; background-color: #ccc;">F 1</div> |
| 3. | Enter the channel BW using the Numerical and Unit keys.
Range: 0kHz to Current span |  |
| 4. | The value is updated in the Channel BW column in MHz. | <div style="border: 1px solid black; padding: 2px; display: inline-block; background-color: #eee;">Setup</div>
<div style="border: 1px solid black; padding: 2px; display: inline-block; background-color: #eee;">Channel BW</div> <div style="border: 1px solid black; padding: 2px; margin-left: 10px; background-color: #eee;">2</div> |

Note:

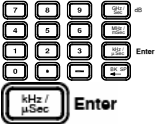
- If the span (page43) becomes less than the CHBW setting, the warning “Span is less than CHBW!” appears in the command window.
- If the CHBW is 0kHz, the warning “CHBW is zero!” appears in the command window.

- | | | | |
|---------------|----|---|---|
| 4. Set OCBW % | 1. | Press F3 (OCBW %). | <div style="border: 1px solid black; padding: 2px; display: inline-block;">OCBW %</div> <div style="border: 1px solid black; padding: 2px; margin-left: 10px; background-color: #ccc;">F 3</div> |
| | 2. | Enter the OCBW % using the Numerical keys and Enter key.
Range: 0% to 100% |  |
| | 3. | The value is updated in the OCBW % column. | <div style="border: 1px solid black; padding: 2px; display: inline-block; background-color: #eee;">OCBW %</div> <div style="border: 1px solid black; padding: 2px; margin-left: 10px; background-color: #eee;">90</div> |





- | | | | |
|----------------------|----|---|--|
| 3. Set channel space | 1. | Press F2 (Channel SPC). | <div style="border: 1px solid black; padding: 2px; display: inline-block;">CH SPC</div> <div style="border: 1px solid black; padding: 2px; margin-left: 10px; background-color: #ccc;">F 2</div> |
| | 2. | Enter the channel space using the Numerical and Unit keys.
Range: 0kHz to 3GHz |  |
| | 3. | Space column updates the value in MHz. | <div style="border: 1px solid black; padding: 2px; display: inline-block; background-color: #eee;">Channel Space</div> <div style="border: 1px solid black; padding: 2px; margin-left: 10px; background-color: #eee;">10</div> |

- | | | | |
|-------------------------|----|---|---|
| 5. Move channel up/down | 1. | Press F6 (Return) twice. | <div style="border: 1px solid black; padding: 2px; display: inline-block;">Return</div> <div style="border: 1px solid black; padding: 2px; margin-left: 10px; background-color: #ccc;">F 6</div> |
| | 2. | Press F4 (CH Up) or F5 (CH Down) to switch the measurement to the next channel. | <div style="border: 1px solid black; padding: 2px; display: inline-block; margin-bottom: 5px;">CH Up</div> <div style="border: 1px solid black; padding: 2px; margin-left: 10px; background-color: #ccc; margin-bottom: 5px;">F 4</div> <div style="border: 1px solid black; padding: 2px; display: inline-block; margin-bottom: 5px;">CH Down</div> <div style="border: 1px solid black; padding: 2px; margin-left: 10px; background-color: #ccc; margin-bottom: 5px;">F 5</div> |

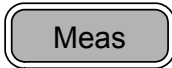
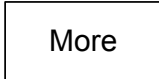

N dB Measurement

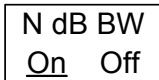
Background N dB refers to the frequency bandwidth of a channel that covers the specified amplitude.

Parameter N dB 0.1dB to 80dB, 0.1dB resolution

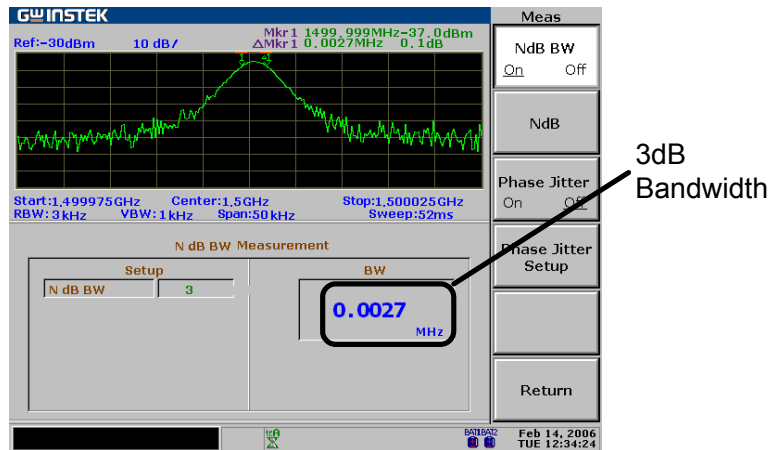
1. Activate N dB
 1. Press the Measurement key. 
 2. Press F6 (More).  
 3. Press F1 (N dB BW On).  
 4. The display switches to N dB mode, updating N dB result in the lower half of the display.

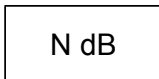





2. Set amplitude
 1. Press F2 (NdB) to set the amplitude which the BW covers.  
 2. Enter the amplitude using the Numerical keys and dB or Enter key.  Enter
Range: 0.1dB to 70dB

Phase Jitter Measurement

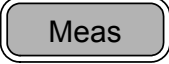
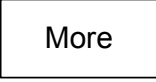

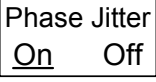

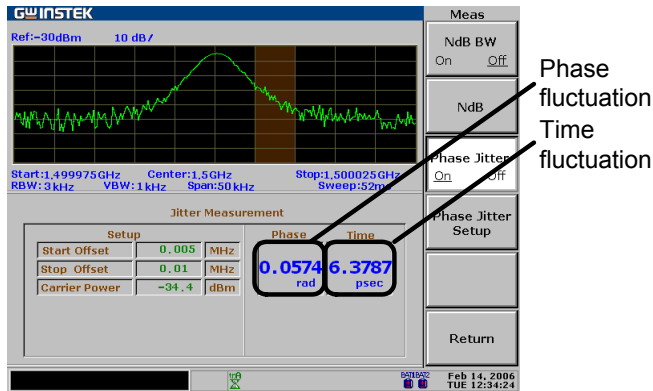

Background	Phase Jitter refers to the amount of phase fluctuation that leads to shortening or lengthening the center frequency.	
Parameter	Start offset	Beginning frequency offset in reference to the center frequency. 0kHz to 1/2 of span, 0.1MHz resolution
	Stop offset	End frequency offset in reference to the center frequency. 0kHz to 1/2 of span, 0.1MHz resolution

1. Activate Phase Jitter

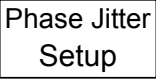
 - Press the Measurement key. 
 - Press F6 (More).  
 - Press F3 (Phase Jitter On).  
 - The display switches to Phase jitter mode, updating Phase jitter result in the lower half of the display.

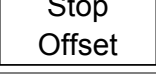

2. Set start/stop offset

 - Press F4 (Phase Jitter Setup).  
 - Press F1 (Start Offset) and F2 (Stop Offset) to set the amount of the beginning and end offset.    
 - Enter the offset using the Numerical/Unit keys. Range: 0kHz to 1/2 of span 

LIMIT LINE

A **Limit Line** sets the upper and lower amplitude limit over the entire frequency range. Limit lines can be used to detect whether the input signal level is above, below, or within the specified amplitude. The result, pass or fail, is shown at the bottom of the display in real-time.

Limit Line

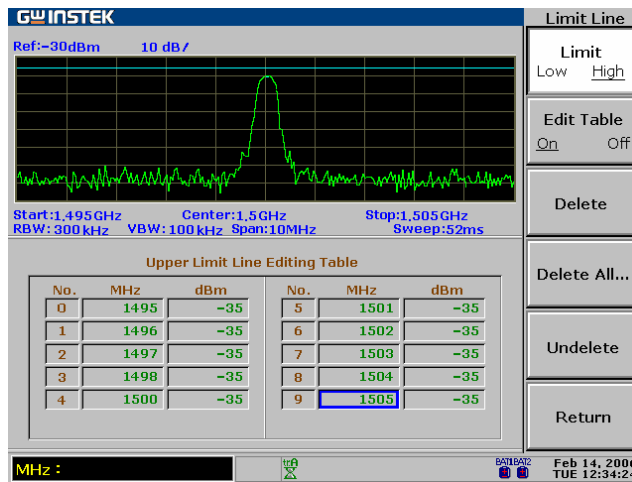

Edit	Edit Limit Line	91
Pass/Fail Test	Run Pass/Fail test.....	94
Limit Line File	Save/copy/delete/rename limit line file.....	94

Edit Limit Line

Parameters	Editing point	Maximum 10 points for each limit line, high or low.
	Frequency	9kHz to 3GHz per editing point.
	Amplitude	Per editing point: -130 to +20dBm -83.01dBmV to +66.99dBmV -23.01dBuV to +126.99dBuV

1. Activate Limit Line
 1. Press the Limit Line key.
 
 2. Press F1 (H Limit On) and/or F2 (L Limit On) to activate the high and/or low limit line.

H Limit	On	Off	F 1
L Limit	On	Off	F 2
 3. The limit line appears on the display.
 Blue: — H limit line
 Yellow: — L limit line

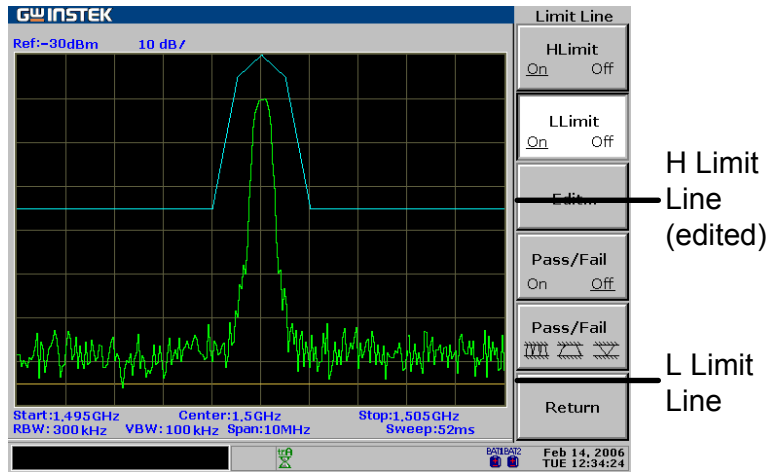

- 2a Activate limit line editing table
 1. Press F3 (Edit).
 
 2. Press F1 (Limit) to select the limit line to be edited.

Limit	Low	High	F 1
-------	-----	------	-----
 3. Press F2 (Edit Table On). The editing table appears in the lower half of the display.

Edit Table	On	Off	F 2
------------	----	-----	-----

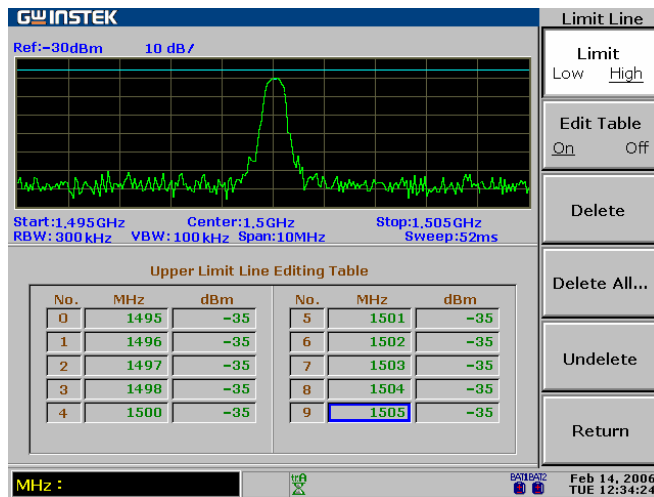

2b Deactivating limit line table

Press F2 (Edit Table Off). The editing table disappears and the edited contents will be saved.

Edit Table
On Off **F 2**

3a. Add a limit line point

1. Make sure that the cursor is pointing to the first empty frequency point. Use the Up/Down keys to move the cursor, if necessary. 10 points are available for each high and low limit line.

No.	MHz	dBm
1		
2		
3		
4		
5		



2. If necessary, move the cursor to different frequency points using the Arrow keys.



3. Enter the frequency using the Numerical and Unit keys. Range: 9kHz to 3GHz. The value is displayed in MHz.



4. The cursor automatically moves to the dBm side. Enter the gain in using the Numerical keys and dB or Enter key. Range: -130dBm to +20dBm

No.	MHz	dBm
1	98	
2		
3		
4		
5		

5. Continue the above steps for the number of points required.

3b. Delete a limit line point

1. Move the cursor using the Arrow keys.



2. Press F3 (Delete) to delete the point (frequency and amplitude together).

Delete **F 3**

No.	MHz	dBm		No.	MHz	dBm
1	98	-40	→	1	98	-40
2	100	-30		2	102	-40
3	102	-40		3		
4				4		
5				5		

- | | | |
|--------------------------------------|---|---|
| 3. | To undo deletion, press F5 (Undelete). | Undelete F 5 |
| <hr/> | | |
| 3c. Delete the whole limit line data | 1. Press F4 (Delete All). | Delete All.. F 4 |
| | 2. Press F1 (No) or F2 (Yes) to confirm deletion. All 10 limit line points will be deleted at once. | No F 1
Yes F 2 |
| | 3. Press F6 (Return) to go back to the previous menu. | Return F 6 |
| | 4. To undo deletion, press F5 (Undelete). | Undelete F 5 |
| <hr/> | | |
| 4. Switch upper/lower limit line | If necessary, press F1 (Limit) to start editing the other limit line. Repeat the above steps. | Limit
Low <u>High</u> F 1 |

Example

High Limit Line

Point No.	Frequency (MHz)	Amplitude (dBm)
1	98MHz	-40dBm
2	100MHz	-30dBm
3	102MHz	-40dBm

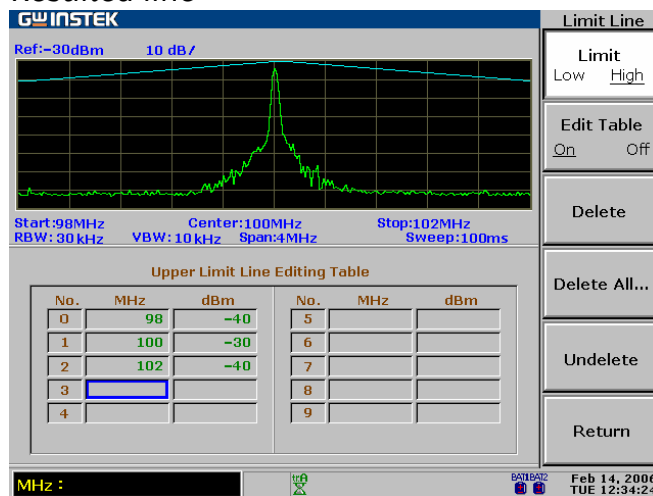

Resulted line



Run Pass/Fail test

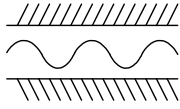
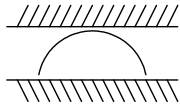
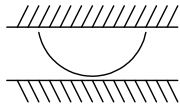

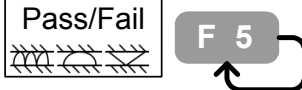
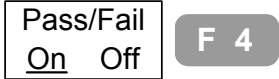

This section assumes that the limit line is already defined.

Pass/Fail condition		Checks whether the entire waveform amplitude stays between the high limit and low limit lines.
		Checks whether the peak waveform amplitude stays between the high and low limit lines.
		Checks whether the waveform valleys stay between the high and low limit lines.

1. Select condition	1. Press the Limit Line key.	
	2. Press F5 (Pass/Fail) repeatedly to select the condition.	
2. Run Pass/Fail test	1. Press F4 (Pass/Fail On) to activate the test.	
	2. The test result appears at the bottom of the display.	

Note If the limit lines are not defined, the Pass/Fail test uses the highest or lowest display level as the limit line.

Save/copy/delete/rename limit line file

Background	Limit line files can be saved, copied, deleted, or renamed using the file utility. Press the File key to access each function.	
Save/Copy	Press F1 (Copy). For detailed steps, see page115.	
Delete	Press F2 (Delete). For detailed steps, see page118.	
Rename	Press F3 (Rename). For detailed steps, see page120.	

BANDWIDTH



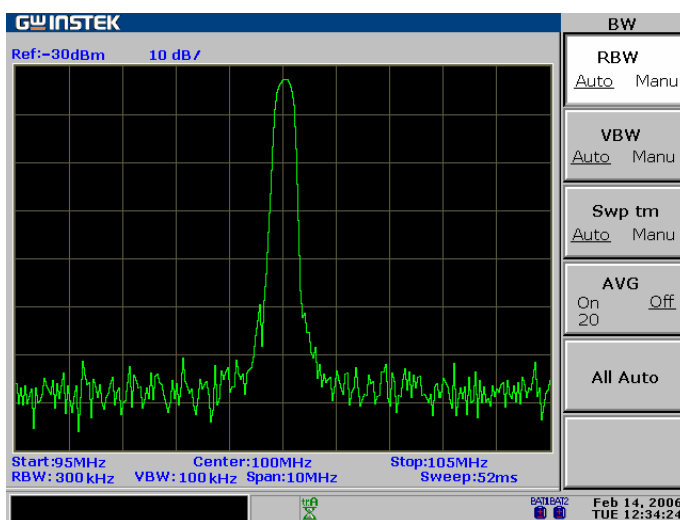

The **BW (BandWidth)** feature configures how narrow the GSP-830 can sort out different signal peaks (resolution), and how fast the display can be updated (sweep time). Averaging the waveform is also available for smoothing noise level. The resolution, sweep time, and averaging are in a trade-off relationship, so configuration should be done with care.



RBW/VBW	Select RBW (Resolution BandWidth).....	96
	Select VBW (Video BandWidth)	98
	RBW/VBW Auto Mode Contents	99
Sweep Time	Set Sweep time.....	101
Average	Average Waveform.....	101
Reset	Reset RBW/VBW/sweep time to auto	102

Select RBW (Resolution BandWidth)

Background RBW (Resolution Bandwidth) defines the width of the IF (intermediate frequency) filter that is used to separate signal peaks from one another. The narrower the RBW, the greater the capability to separate signals at close frequencies. But it also makes the sweep time longer under specific frequency span (the display is updated less frequently). See page99 for suitable RBW selection.

- Panel operation**
1. Press the BW key. 
 2. Press F1 (RBW) to select Auto or Manual. 
 3. When Man (manual) is selected, use the Arrow keys or Scroll knob to select the RBW. The selected RBW appears in the command window. 





Mode	Auto	RBW is automatically selected. See page99 for the setting.
	Manual 	RBW is manually selected. The BW icon appears at the bottom of the display.

Range See page99 for RBW reference setting according to the frequency span.

RBW	Recommended span	Standard/ Optional
300Hz	Span<30kHz	Optional (300Hz RBW)
3kHz	Span<300kHz	Standard
9kHz	300kHz≤Span<600kHz	Optional (EMI Filter - page146)
10kHz	300kHz≤Span<1MHz	Optional (10k/100kHz RBW)
30kHz	300kHz≤Span<6MHz	Standard

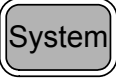
100kHz	6MHz≤Span<20MHz	Optional (10k/100kHz RBW)
120kHz	6MHz≤Span<19MHz	Optional (EMI Filter – page146)
300kHz	6MHz≤Span<60MHz	Standard
4MHz	60MHz≤Span	Standard

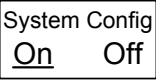
Check RBW installation status

1. Press the System key. 
2. Press F6 (More).  
3. Press F4 (System Config On) to show the system configuration in the display.  

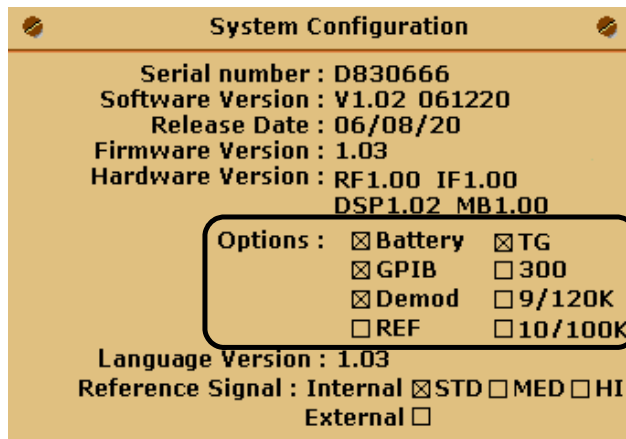

4. Check the optional items corner and see the RBW installation status (checkmark – installed, blank – not installed)





Installed	<input checked="" type="checkbox"/> 300
	<input checked="" type="checkbox"/> 9/120K
	<input checked="" type="checkbox"/> 10/100K
Not installed	<input type="checkbox"/> 300
	<input type="checkbox"/> 9/120K
	<input type="checkbox"/> 10/100K

5. Press F4 (System Config Off) to close the system configuration.  

Note

9k/120kHz RBW (EMI Filter) and 10k/100kHz RBW are exclusive; cannot be installed together. For installing a new optional RBW, contact the service center.

Select VBW (Video BandWidth)





Background	<p>VBW (Video Bandwidth) defines the smoothness of the trace on the display. Combined with RBW, VBW defines the ability to sort out target signal from surrounding noise or adjacent peaks.</p> <p>See page99 for suitable VBW selection.</p>	
Panel operation	<ol style="list-style-type: none"> 1. Press the BW key. 2. Press F2 (VBW) to select Auto or Manual. 3. When Man (manual) is selected, use the Arrow keys or Scroll knob to select the VBW. The selected VBW appears in the command window. 	   
Mode	<p>Auto</p>	<p>VBW is automatically selected. See page99 for setting.</p>
	<p>Manual</p> 	<p>VBW is manually selected. The VBW icon appears at the bottom of the display.</p>
Range	<p>10Hz to 1MHz in 1-3 steps</p> <p>In Auto mode, VBW is automatically selected in combination with RBW. See page99 for the settings. Use the Auto mode settings for reference when manually selecting the VBW.</p>	
Note	<p>The GSP-830 automatically changes the VBW according to RBW selection.</p>	

RBW/VBW Auto Mode Contents

Background

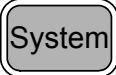
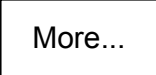
- The following applies when selecting Auto mode for RBW and VBW setting. Use them as a reference when manually selecting RBW and VBW.
- The RBW/VBW range differs according to system configuration, especially the optional items.

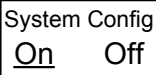
Check the RBW installation status

1. Press the System key. 
2. Press F6 (More).  
3. Press F4 (System Config On) to turn on the system configuration window.  

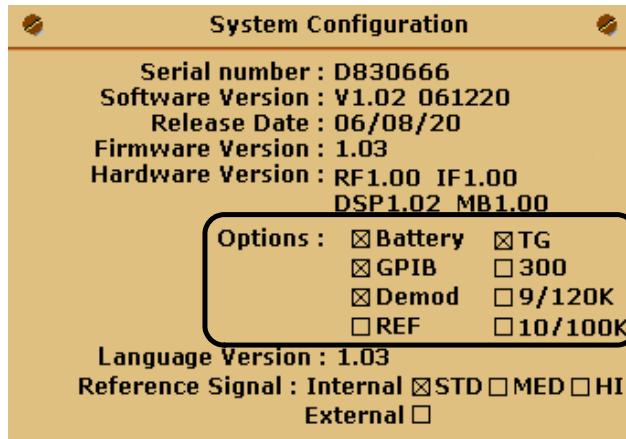

4. Press F4 (System Config Off) to close the system configuration.  

Standard configuration

Optional item	Install	Icon
EMI Filter(9k/120k RBW)	No	<input type="checkbox"/> 9/120K
300Hz RBW	No	<input type="checkbox"/> 300
10k/100kHz RBW	No	<input type="checkbox"/> 10/100K

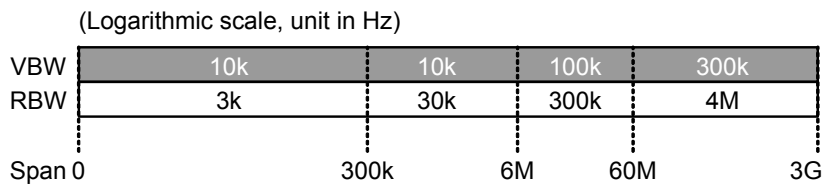

Standard +
9k/120kHz RBW
configuration

Optional item	Install	Icon
EMI Filter (9k/120k RBW)	Yes	<input checked="" type="checkbox"/> 9/120K
300Hz RBW	No	<input type="checkbox"/> 300
10kHz/100kHz RBW	No	<input type="checkbox"/> 10/100K

(Logarithmic scale, unit in Hz)

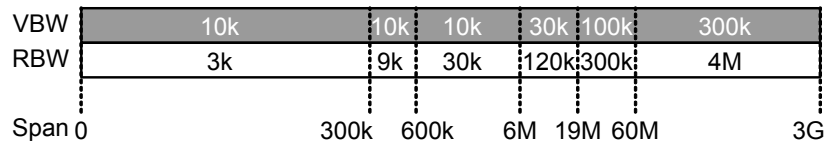

Standard +
300/9k/120kHz
RBW configuration

Optional item	Install	Icon
EMI Filter (9k/120k RBW)	Yes	<input checked="" type="checkbox"/> 9/120K
300Hz RBW	Yes	<input checked="" type="checkbox"/> 300
10kHz/100kHz RBW	No	<input type="checkbox"/> 10/100K

(Logarithmic scale, unit in Hz)

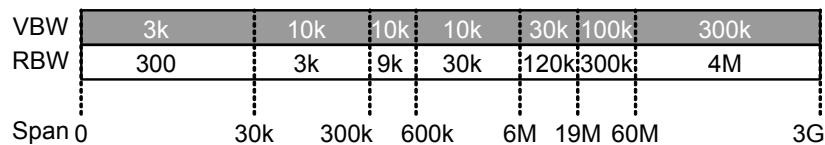

Standard +
10k/100kHz RBW
configuration

Optional item	Install	Icon
EMI Filter (9k/120k RBW)	No	<input type="checkbox"/> 9/120K
300Hz RBW	No	<input type="checkbox"/> 300
10kHz/100kHz RBW	Yes	<input checked="" type="checkbox"/> 10/100K

(Logarithmic scale, unit in Hz)

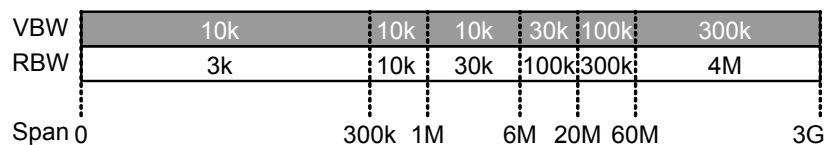



Standard +
300/10k/100kHz
RBW configuration

Optional item	Install	Icon
EMI Filter (9k/120k RBW)	No	<input type="checkbox"/> 9/120K
300Hz RBW	Yes	<input checked="" type="checkbox"/> 300
10kHz/100kHz RBW	Yes	<input checked="" type="checkbox"/> 10/100K

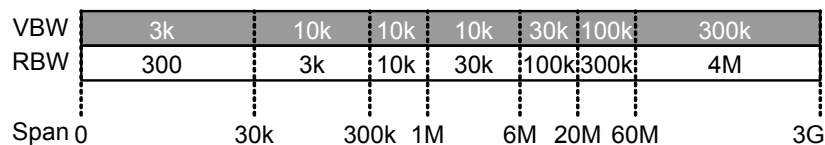
(Logarithmic scale, unit in Hz)

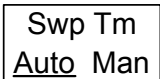

Set Sweep time

Background	Sweep time defines the display update rate. Note that sweep time and RBW/VBW are in trade-off. Faster sweep time updates display more frequently but makes RBW and VBW wider, reducing the capability to separate signals at close frequencies.	
Panel operation	1. Press the BW key.	
	2. Press F3 (Swp tm) To switch between Auto and Manual setting.	 
	 In the Manual mode, the manual sweep time icon appears.	
Mode	Auto	Sweep time is automatically set.
	Manual	Sweep time is manually set.
Range	50ms to 25.6s, 1us resolution	
Note	When in the Auto mode, GSP830 is optimized for fast sweep time. For narrower RBW settings, like 300 Hz or 3 KHz, this optimization will cause slightly higher phase noise. To reduce the phase noise level, slow down the sweep time using manual setting.	

Average Waveform

Background	The GSP-830 averages the waveform for a user-defined or system-defined number before it is displayed. This feature smoothes the noise level to a great extent, but slows down the display update rate.	
Panel operation (Method1)	1. Press the BW key.	

2. Press F4 (AVG On) to turn on averaging. The current average number setting appears in the command window.

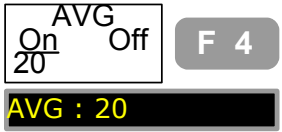

3. The trace average icon appears at the bottom of the display.



4. Enter the average time using the Numerical keys and Enter key.



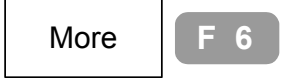

Panel operation (Method2)

1. Press the Trace key.

2. Press F6 (More).

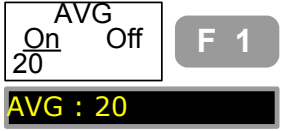
3. Press F1 (AVG On) to turn on the average mode. The current average number setting appears in the command window.

4. The average mode icon appears at the bottom of the display.

5. Enter the average number using the numerical keys followed by the Enter key.





Parameter 2 to 200 (Available only when Average is on)

AVG number after power on/preset After powering up the GSP-830 (page20) or presetting it (page40), the average number is reset to 20 (AVG itself is turned off)

Reset RBW/VBW/sweep time to auto

- Panel operation**
1. Press the BW key.



 2. Press F5 (All Auto). The RBW, VBW, and sweep time setting all change to Auto.



RBW/VBW/Sweep Setting after Autoset When using the Autoset, all three BW related parameters, RBW, VBW, and sweep, will be reset to Auto mode, regardless of their previous settings.

T RIGGER

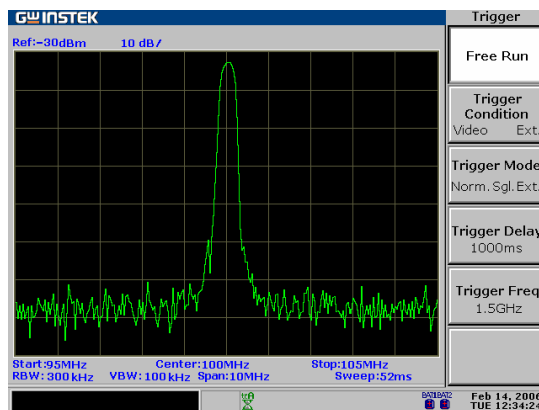
The **Trigger** function sets the signal conditions upon which the GSP-830 triggers capturing waveforms, including frequency, amplitude, and delay. An external trigger signal, instead of the default internal signal, may be used as required for special conditions.





Free Run	Select free run (default)	104
Video Trigger	Activate video trigger	104
External Trigger	Activate external trigger	105
Trigger Mode	Select Trigger Mode	105
Trigger Delay	Set Trigger Delay	106







Select Trigger Type

Select free run (default)

In the free run mode, the GSP-830 captures all incoming signals (no triggering condition).

Panel operation	1. Press the Trigger key.	
	2. Press F1 (Free Run).	

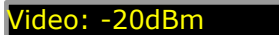
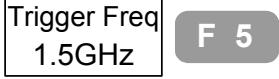
Activate video trigger



Panel operation	1. Press the Trigger key.	
	2. Press F2 (Trigger Condition Video).	
	3. The video trigger icon appears at the bottom of the display.	
	4. Enter the trigger level (amplitude) using the Numerical keys and dB or Enter key. The value appears in the command window.	 
	5. Press F5 (Trigger Freq) to set the frequency at which the GSP-830 checks the trigger condition. Default value: center frequency	
	6. Enter the trigger frequency using the Numerical/Unit keys.	

Deactivate video trigger	To de-activate video triggering, press F1 (Free Run).	
--------------------------	---	---



Level range	(Ref.Level – 80dBm) to Ref.Level (Example: when the reference level is –30dBm, the trigger range will be –110dBm to –30dBm)
-------------	--

Frequency range	0 to 3GHz
-----------------	-----------

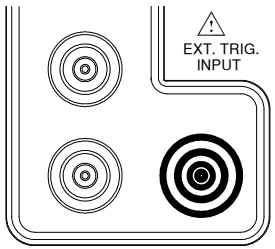

Activate external trigger

Panel operation	1. Press the Trigger key.	
	2. Press F2 (Trigger Condition Ext.).	
	3. The Ext. trigger icon appears at the bottom of the display.	
	4. Connect the external trigger signal to the rear panel terminal.	
Input level range	0V to 5V, positive edge trigger	

Select Trigger Mode

Panel operation	1. Press the Trigger key.	
	2. Press F3 (Trigger Mode) repeatedly to select the trigger mode.	
	3. Press F6 (Run Now) to manually start triggering.	
Modes	Normal	The GSP-830 captures signals every time the triggering condition occurs.
	Single	The GSP-830 captures signals when the first triggering condition occurs, then stops capturing altogether.
	Continuous	The GSP-830 captures signals when the first triggering condition occurs, then switches to Free Run mode. After then, input signals are captured continuously regardless of their conditions.

Set Trigger Delay

Background	Trigger delay sets the amount of time between the moment of trigger condition and when the GSP-830 starts capturing signal.	
Panel operation	1. Press the Trigger key.	
	2. Press F4 (Trigger Delay).	
	3. Enter the delay time using the Numerical/Unit keys.	
Delay range	10us to 100s, 1us resolution	

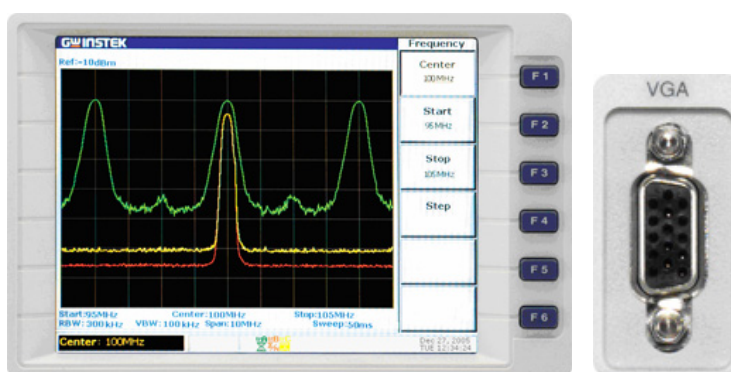

DISPLAY

The **Display** setting configures the LCD screen dimmer level, display line, display title, and split window. Display line provides a convenient reference line for measuring amplitude. Split window allows two simultaneous waveforms to be shown on the display. The VGA connector on the rear panel outputs the LCD screen contents in 640x480 resolution.





LCD Dimmer	Change Display Brightness	108
Display Line	Activate Display Line.....	108
Title	Enter Display Title.....	109
Split Window	Use Split Display.....	110
VGA Output	Use VGA Output	111
Save	Save Display Image to USB Flash Drive	111

Change Display Brightness

Panel operation	1. Press the Display key.	
	2. Press F1 (LCD Dimmer).	
	3. Change the brightness using the Left/Right keys or Scroll knob.	
Range	0 (darkest) to 5 (brightest)	

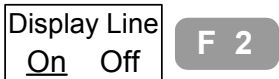
Activate Display Line



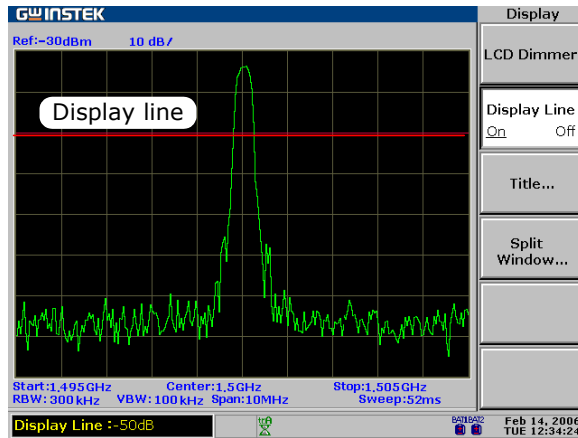







Panel operation	1. Press the Display key.	
	2. Press F2 (Display Line On).	
	3. The display line appears on the display and its level appears in the command window.	

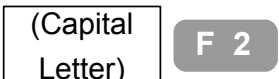
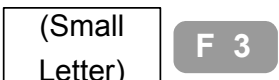
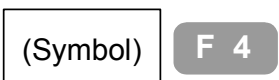
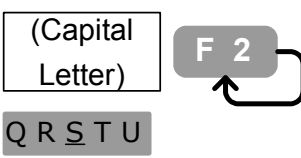

4. Move the line using the Left/Right keys or Scroll knob.	
--	---

Note	<p>Display line is NOT available in the following situations.</p> <ul style="list-style-type: none"> • Split window (page110) • Limit Line editing (page91) • Power measurements (page82)
------	--

Enter Display Title

Panel operation	1. Press the Display key.	
	2. Press F3 (Title).	
	3. Select the character from F2 to F4 and press it. (When entering numbers 0 to 9, press one from F2 to F4 anyway)	
		
		
	4. Here is how to type in the capital letter “S”. Press F2 (Capital Letter) repeatedly until the cursor reaches S.	
	5. Press the Enter key. S appears in the command window.	
	To enter the number “2”, press the number 2 key.	
	To delete (undo) previously entered character, press the BK SP key.	
6. Continue the above until all the characters are entered.		
7. Press F5 (Show Title).		
8. The entered title appears at the top left corner of the display.		
9. To erase the title, press F1 (Clear Title).		
Parameter	Capital letter	Upper case alphabet, A to Z.
	Small letter	Lower case alphabet, a to z.
	Number	0 to 9.

Symbol Commonly used 14 symbols as shown below.

\	#	/	_	-
.	*	:	&	(
)	<	>	%	

Use Split Display

Panel operation

1. Press the Display key.



2. Press F4 (Split Window).



3. The display splits into upper and lower screen. The lower display retains the original vertical and horizontal scale. The upper display shows full scale.

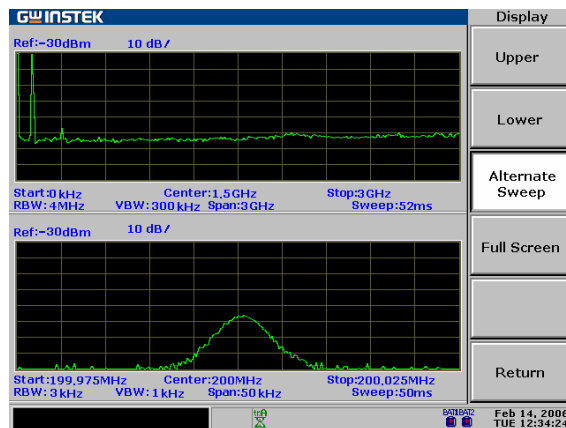

4. Select the active display (in which the waveform is updated) by pressing F1 (Upper) or F2 (Lower). Pressing F3 (Alternate Sweep) updates both displays alternately.

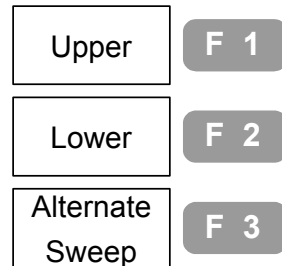

5. To go back to the original single display, press F4 (Full Screen). The currently active window is expanded.

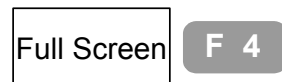

Note

Switching to the Full Screen from the Alternate Sweep mode is not recommended, since it is not predictable which display, upper or lower, will be selected.

Use VGA Output

Panel operation Connect an external monitor to rear panel VGA output terminal. The display output is always on.



Parameter	Connector type	VGA 15pin, female
	Resolution	640 x 480

Save Display Image to USB Flash Drive

Panel operation 1. Connect the USB flash drive to the front panel USB terminal. The USB icon appears at the bottom of the display.



Compatibility USB 1.1/2.0

Connector TypeA host, female

Note  If it takes more than 2 seconds for the USB icon to appear, disconnect the USB flash drive and connect again.

2. Press the File key.



3. Press F4 (Print Screen).

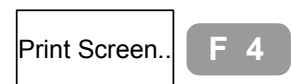

4. Press F1 (To Ext. Memory).

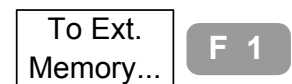

5. The USB flash drive contents appear in the display.

Item Name	Date	Memory	External	Remark
MyFolderA	2007/03/06 09:48			
MyFolderB	2007/01/12 14:45			
MvResultA	2007/06/06 10:29			

6. To enter into an existing folder, move the cursor to the folder and press the Enter key.



Enter

7. To save the display image, move the cursor to the blank area using the Up/Down keys and press F2 (Print Now). A new bitmap file (MyBMapx.bmp) is created in the USB flash drive.



File Function: Print to File		Memory External
Item Name	Date	Remark
MyFolderA	2007/03/06 09:48	
MyFolderB	2007/01/12 14:45	
MyResultA	2007/06/06 10:29	
MyBMap0		



Note

If the cursor is pointing to an existing file, the file will be overwritten.

8. A confirmation message appears in the command window. To accept saving, press the Enter key. To cancel saving, press the BK SP key.

ENTER for Yes: BKSP for No:



Enter



9. The file is saved when the date information appears. Now it is safe to remove the USB drive from the GSP-830.

File Function: Print to File		Memory External
Item Name	Date	Remark
MyFolderA	2007/03/06 09:48	
MyFolderB	2007/01/12 14:45	
MyResultA	2007/06/06 10:29	
MyBMap0	2007/07/10 15:30	



FILE

The **File** function manages file operations; copy, delete, and name change. The file format and contents include trace waveform, limit line, amplitude correction, sequence set (user defined macro), and panel settings. The file source and destination are selectable between internal (inside the GSP-830) and external (inside the USB flash drive). The File function can also save display images to USB flash drives.



File Operation	File Location and File Type.....	114
	Copy	115
	Delete File.....	118
	Rename File	120
	Save Display Image to USB Flash Drive	121

File Location and File Type

File location	Internal	The GSP-830 internal memory. The number of files is fixed (see below).
	External	The USB flash drive connected to the front panel connector. There is no practical limit on the number of files.
		
		 The USB icon turns on when the flash drive is detected. <p>Compatibility: USB 1.1/2.0</p> <p>Connector: TypeA host</p>
	 Note	If it takes more than 2 seconds for the USB icon to appear, disconnect the USB flash drive and connect again.
File type	Trace	Trace waveform data. For details, see page73. File format: *.tra 13 files are available internally: TraceA/B/C (current trace), Trace 1to10 (stored trace).
	Limit	Limit Line data. For details, see page90. File format: *.lmt 12 files are available internally: LimitHL (current high limit line), LimitHL1 to 5 (stored high limit line), LimitLL (current low limit line), LimitLL1 to 5 (stored low limit line).
	Correction	Amplitude correction data. For details, see page52. File format: *.cor 5 files are available: Correction 1 to 5.
	Seq.	Sequence data. For details, see page136. File format: *.seq 10 files are available: Sequence 1 to 10.

Setup Panel setup data. For details, see page125.
 File format: *.set
 10 files are available: Setup 1 to 10.

Copy File

1. Connect USB flash drive (for external file)

When using the USB flash drive (external file) for source or destination, connect the drive to the front panel connector.



The USB icon turns on when the flash drive is detected.

2. Select source file

1. Press the File key.



2. Press F1 (Copy). The file copy window appears.

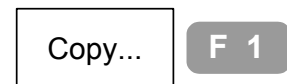

Source			
File Function:	Copy	Type:	Memory
Item	Name	Date	Remark

3. Press F1 (Source).

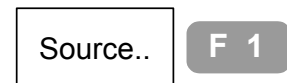

4. Select the file type from F1 to F5, press it, and then select Int (internal) or Ext (external). The display gets updated accordingly. The below example shows the internal trace files.

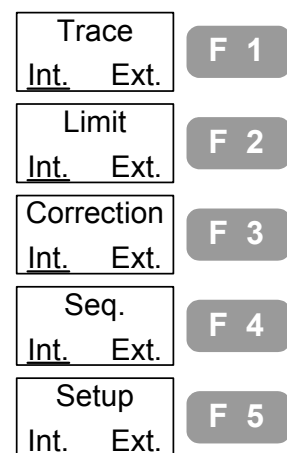

Source			
File Function:	Copy	Type:	Trace Memory Internal
Item	Name	Date	Remark
	TraceA		
	TraceB		
	TraceC		

5. Use the Up/Down keys to move the cursor to the source file location. (Example: Internal TraceC selected)



Source			
File Function:	Copy	Type: Trace	Memory Internal
Item	Name	Date	Remark
	TraceA		
	TraceB		
	TraceC		

6. Press F6 (Return). The copy source file information is retained.

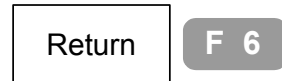

3. Select destination file

1. Press F2 (Destination). The destination file copy window becomes active in the lower half of the display.

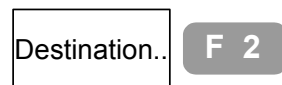

2. Select the file type from F1 to F5, press it, and select Internal or external. The file type must be the same as the source type. The display updates accordingly.

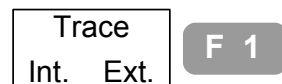

Source			
File Function:	Copy	Type: Trace	Memory Internal
Item	Name	Date	Remark
	TraceC		
	Trace1		Empty
	Trace2		Empty
	Trace3		Empty
	Trace4		Empty

Destination			
File Function:	Copy	Type: Trace	Memory Internal
Item	Name	Date	Remark
	TraceA		
	TraceB		
	TraceC		
	Trace1		Empty
	Trace2		Empty
	Trace3		Empty
	Trace4		Empty

3. Use the Up/Down keys to move the cursor to the copy destination file location. (Example: internal Trace1 selected)



Destination			
Item	Name	Date	Remark
File Function: Copy Type: Trace Memory Internal			
	TraceA		
	TraceB		
	TraceC		
	Trace1		Empty

When selecting an external location, select a blank space or an existing folder (a new file will be created inside).

Destination			
Item	Name	Date	Remark
File Function: Copy Type: Trace Memory External			
	MyFolderA	2007/03/06 09:48	
	MyFolderB	2007/01/12 14:45	
	MyBMap0	2007/06/06 10:29	

4. Press F6 (Return). The copy destination file information is retained.
- Return

F 6

4. Edit file name (when creating new file)
1. (Skip this step when overwriting an existing file or copying to a folder) To edit the newly created file name, press F3 (Edit File Name On).
- Edit File Name
On Off

F 1

2. Move the cursor inside the character table using the Left/Right keys or Scroll knob. Press the Enter key to confirm each character and the BK SP key to delete one character.
- 
- kHz / μSec

Enter
- BK SP

←

Char Table																															
A	B	C	D	E	F	G	H	I	J	K	L	M	N	O	P	Q	R	S	T	U	V	W	X	Y	Z	a	b	c	d	e	f
g	h	i	j	k	l	m	n	o	p	q	r	s	t	u	v	w	x	y	z	0	1	2	3	4	5	6	7	8	9		

3. When completed, press F3 (Edit File Name Off) to turn it off.
- Edit File Name
On Off

F 1

5. Copy file
1. Press F4 (Copy Now).
- Copy Now

F 4

2. A confirmation message appears in the command window. To accept the file, press the Enter key. To cancel the file, press the BK SP key.
- ENTER for Yes: BKSP for No:
- kHz / μSec

Enter
- BK SP

←

- When the file copy is done, the destination file attribute changes from Empty to Full and/or the date becomes updated.

Destination				
File Function:	Copy	Type:	Trace	Memory Internal
Item	Name	Date		Remark
	TraceA			
	TraceB			
	TraceC			
	Trace1	2007/07/09 10:41		Full

Note

If the source file does not contain data, a warning message appears. In this case, re-select a source file with actual data.

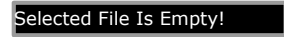

Delete File

- Connect USB flash drive (for external file)

When using the USB flash drive (external file) for source or destination, connect the drive to the front panel connector.



The USB icon turns on when the flash drive is detected.

- Select source file

- Press the File key.



- Press F2 (Delete).

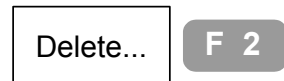

- Press F1 (Type). The file deletion window appears.

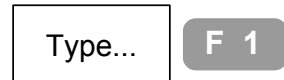

File Function:	Delete	Type:	Memory	Remark
Item	Name	Date		

4. Select the file type by pressing F1 to F5, then select Int (internal) or Ext (external). The display gets updated accordingly. The example below shows the internal Trace files.
- | | |
|-------------------------|-----|
| Trace
Int. Ext. | F 1 |
| Limit
Int. Ext. | F 2 |
| Correction
Int. Ext. | F 3 |
| Seq.
Int. Ext. | F 4 |
| Setup
Int. Ext. | F 5 |

5. Use the Up/Down keys to move the cursor to the file location. (Example: internal Trace1 selected)



File Function: Delete		Type: Memory Internal
Item	Name	Date
Trace1		2007/07/09 10:41
Trace2		
		Full
		Empty

6. Press F6 (Return). The file location is retained.
- | | |
|--------|-----|
| Return | F 6 |
|--------|-----|

3. Delete file

1. Press F2 (Delete Now).
- | | |
|------------|-----|
| Delete Now | F 2 |
|------------|-----|

2. A confirmation message appears in the command window. To accept deletion, press the Enter key. To cancel deletion, press the BK SP key.
- | | |
|-----------------------------|-------|
| ENTER for Yes; BKSP for No: | |
| kHz /
μSec | Enter |
| BK SP
← | |

3. Internal file: The file attribute (Remark) changes from Full to Empty.
External file: The file itself is deleted.

File Function: Delete		Type: Memory Internal
Item	Name	Date
Trace1		
Trace2		
		Empty
		Empty

Rename File

File rename is allowed only for external (USB flash drive) files.

1. Connect USB flash drive

Connect the USB flash drive to the front panel connector.



The USB icon turns on when the flash drive is detected.

2. Select file

1. Press the File key.



2. Press F3 (Rename). The USB flash drive contents and the character table appear in the display.

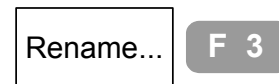

3. Point the cursor to the file using the Up/Down keys.



3. Edit file name

1. Press F1 (Edit File Name) and turn it on.

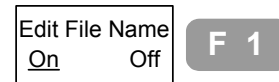

2. Move the cursor inside the character table using the Left/Right keys or Scroll knob. Press the Enter key to confirm each character.

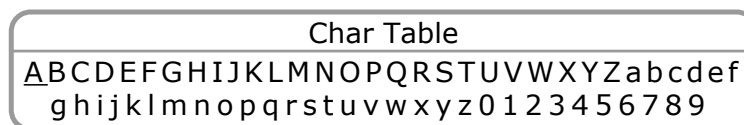
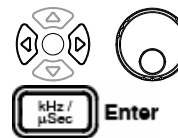

3. When completed, press F1 (Edit File Name Off) to turn it off.

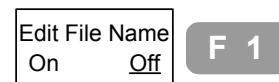

4. Press F2 (Confirm). A confirmation message appears in the command window.



ENTER for Yes; BKSP for No:

5. To accept renaming and save the new file name, press the Enter key. To cancel renaming, press the BK SP key.

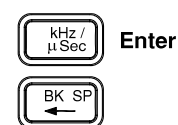

Save Display Image to USB Flash Drive

1. Connect USB flash drive

Connect the USB flash drive to the front panel USB connector. The USB icon appears at the bottom of the display.



Compatibility USB 1.1/2.0

Connector TypeA host



Note

If it takes more than 2 seconds for the USB icon to appear, disconnect the USB flash drive and connect again.

2. Enter menu

1. Press the File key.



2. Press F4 (Print Screen).

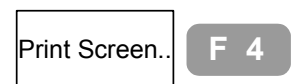

3. Press F1 (To Ext. Memory).

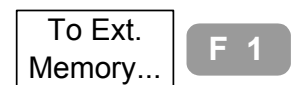

4. The USB flash drive contents appear in the display.

Item Name	Date	Remark
MyFolderA	2007/03/06 09:48	
MyFolderB	2007/01/12 14:45	
MyResultA	2007/06/06 10:29	

3. Selecting file

Move the cursor to the blank area using the Up/Down keys.



Item Name	Date	Remark
MyFolderA	2007/03/06 09:48	
MyFolderB	2007/01/12 14:45	
MyResultA	2007/06/06 10:29	
MyBMap0		

To enter into an existing folder, move the cursor to the folder and press the Enter key.

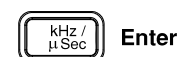

Note If the cursor is pointing to an existing file, the file will be overwritten.

4. Edit file name (when creating new file)

1. (Skip this step when overwriting an existing file) To edit the newly created file name, press F1 (Edit File Name On).

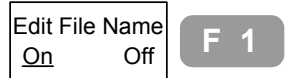

2. Move the cursor inside the character table using the Left/Right keys or Scroll knob. Press the Enter key to confirm each character and the BK SP key to delete one character.

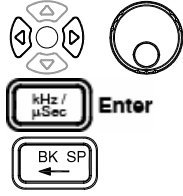

Char Table																															
A	B	C	D	E	F	G	H	I	J	K	L	M	N	O	P	Q	R	S	T	U	V	W	X	Y	Z	a	b	c	d	e	f
g	h	i	j	k	l	m	n	o	p	q	r	s	t	u	v	w	x	y	z	0	1	2	3	4	5	6	7	8	9		

3. When completed, press F1 (Edit File Name Off) to turn it off.



5. Save file

1. Press F2 (Print Now) and press F2 (Print Now).



2. A confirmation message appears in the command window. To accept the file, press the Enter key. To cancel the file, press the BK SP key.



3. The file is saved when the date information appears. Now it is safe to remove the USB drive from the GSP-830.

File Function: Print to File		Memory External	
Item	Name	Date	Remark
	MyFolderA	2007/03/06 09:48	
	MyFolderB	2007/01/12 14:45	
	MyResultA	2007/06/06 10:29	
	MyBMap0	2007/07/10 15:30	

PRESET



Pressing the Preset key returns the GSP-830 to the factory default parameters as defined below.

Frequency	Center: 1.5GHz Start: 0Hz	Stop: 3GHz Step: 1MHz
Span	3GHz	
Amplitude	Ref.level: 0dBm Unit: dBm Scale: 10dB/	External Gain: 0dB Input Z: 50Ω
Autoset	Amplitude Floor: Auto	Span: Auto
Marker	Marker: Off Marker Table: Off	Marker Trace: Auto All Marker: Off
Peak Search	Peak Table: Off Peak Threshold: Off	Peak Sort: Freq Peak Track: Off
Trace	Trace: A Average: Off, 20	Mode: Clear Detection: Normal
Meas	ACPR, OCBW: Off CH SPC: 0 CH BW: 600MHz OCBW %: 0	N dB, Phase Jitter: Off Adj CH Offs: 0MHz Adj CH BW: 0MHz
Limit Line	H & L Limit: Off	Pass/ Fail: Off
BW	RBW, VBW, Swptime: Auto	Average: Off, 20
Trigger	Trigger Delay: 50ms Trigger Mode: Normal	Trigger Freq: 1.5GHz
Display	LCD Dimmer: 5 Split Window: Off	Display Line: Off Display Title: Off
File	Copy Type: Int. Trace	Delete Type: Int. Trace
System	GPIO Add: 2 Aux Sig: Off	System Config: Off Clock: On
Option	External Ref Freq: 10MHz TG Norm Corr: Off Demod AM: Off	TG Output: Off TG Ref Value: 0dBm Demod FM: Off
Sequence	Sequence: 1	Run Mode: Single





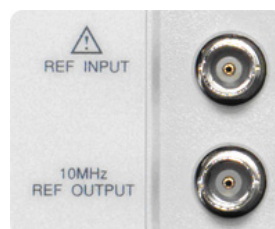
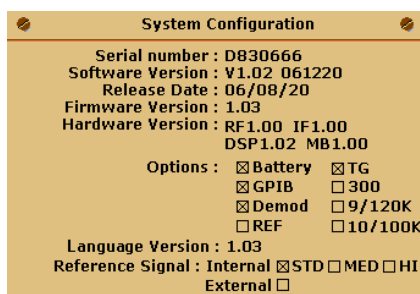
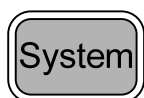



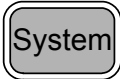
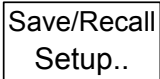

SYSTEM

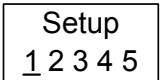
The **System key** configures and displays the system settings, including self-test result, date/time setting, and synchronization with other devices. The panel settings can be saved to GSP-830 internal memories or external USB flash drive, the latter permitting transferring panel settings among multiple GSP-830.

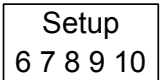

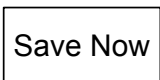

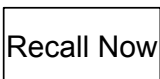



Panel Setting	Save/Recall Panel Setting	125
	Copy/delete/rename setup	125
Interface Configuration	USB slave port configuration.....	126
	RS-232C configuration.....	126
	GPIB configuration (optional)	127
System Information	View system error	128
	View system configuration.....	129
	View self-test result	131
Date/Time	Set Date/Time	132
Synchronization	GSP-830 as master (internal reference signal)	133
	GSP-830 as slave (external reference signal)	134
Language	Select Language.....	135
Auxiliary Signal	Use Auxiliary Signal	135
Service Menu	Enter Service Operation.....	135

Save/Recall Panel Setting

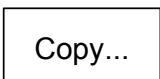

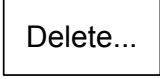

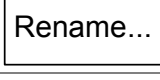
Panel operation	1. Press the System key.	
	2. Press F1 (Save/Recall Setup).	 
	3. Press F1 or F2 repeatedly to select the setting file.	   
	4. Press F3 (Save Now) or F4 (Recall Now) to save or recall the setting file.	   

File contents	Setting file contains the following information. <ul style="list-style-type: none"> • Reference amplitude level • Amplitude unit, scale • Start/stop frequencies • Center and span frequencies • VBW, RBW, and sweep time • Tracking Generator level • Tracking Generator normalization data
---------------	---

Copy/delete/rename setup file

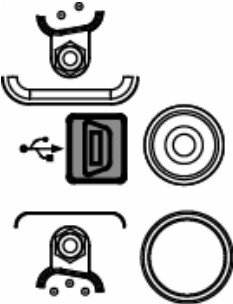
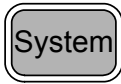
Background	Setting files can be copied, deleted, or renamed using the file utility. Press the File key to access each function.	
Copy	Press F1 (Copy). For detailed step, see page115.	 
Delete	Press F2 (Delete). For detailed step, see page118.	 
Rename	Press F3 (Rename). For detailed step, see page120.	 

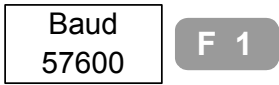
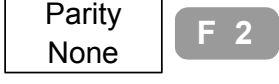
Configure Communication Interface

Background	The GSP-830 supports three types of communication interface: standard USB/RS-232C and optional GPIB.	
Communication Method	PC software (page150)	USB slave, RS-232C
	Remote control (page157)	USB slave, RS-232C, GPIB
Interface type	USB slave	USB 1.1 or 2.0, TypeB mini
	RS-232C	D-sub 9 pin.
	GPIB (optional)	IEEE-488 24pin.
USB slave port configuration	No need for panel configuration: Just connect a type B mini USB cable between the rear panel and PC.	
RS-232C configuration	1. The RS-232C configuration can be viewed from the system menu. Press the System key.	
	2. Press F3 (Serial Port).	
	3. The RS-232C port configuration appears. Configure the PC according to this setting. Baud: 57600 Parity: None Stop bit: 1 Data bit: 8	   

4. Connect a 9-pin male RS-232C cable to the rear panel connector.

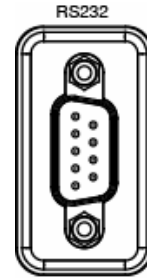

GPIB configuration (optional)

The GPIB interface is a factory installed optional item. Contact service personnel for a new installation.

1. Press the System key.

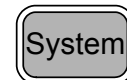

2. Press F2 (GPIB Add).

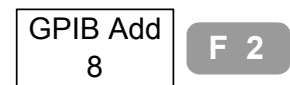

3. Select GPIB address using the Left/Right keys, Scroll knob, or Numerical keys. Configure the PC according to this setting.

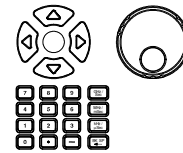

4. Connect GPIB cable to the rear panel terminal.

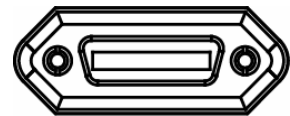

Check GPIB installation status

1. To check the GPIB installation status, press the System key.

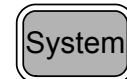

2. Press F6 (More).



3. Press F4 (System Config On).

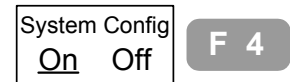

4. The system configuration appears. When the GPIB module is installed correctly, the check box is marked.



Check GPIB self-test result

1. To check the internal GPIB functionality result, press the System key.

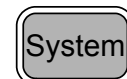

2. Press F6 (More).



- | | | |
|---|--------------------------|-----|
| 3. Press F2 (Self Test). | Self Test... | F 2 |
| 4. The GPIB result appears at F1.
If the result is Fail (underlined), contact service personnel. | GPIB
<u>Pass</u> Fail | F 1 |

GPIB constraints

- Keep these rules when using the GPIB interface.
- Altogether less than 15 devices & 20m cable length, 2m between each device on the bus
 - Unique address assigned to each device
 - At least 2/3 of the GPIB devices turned on
 - No loop or parallel structure allowed

View System Information

View system error

Panel operation View the bottom of the screen, the error message area. If there is a system error, the message appears in red.

Center : 1.5GHz

EXT
Unlock

(EXT Unlock)

Amp
Uncal

- Inappropriate RBW or VBW is selected.
- Frequency is less than 15MHz and amplitude is less than -30dBm.

EXT
Unlock

External reference input is not working properly.

LO1
Unlock

Local oscillator 1 is not working properly.

LO3
Unlock

Local oscillator 3 is not working properly.



Med
Unlock

± 1 ppm stability signal is not working properly. Appears only when the optional ± 1 ppm Stability Module is installed.

Ref
Unlock

Internal reference signal is not working properly.

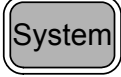
View system configuration

- Panel operation
- To check system configuration, press the System key. 
 - Press F6 (More). 
 - Press F4 (System Config On). 
 - The system configuration appears. Four types of information are listed.
 - Serial number
 - Software/hardware/firmware/language version
 - Installed optional items
 - Reference signal selection status

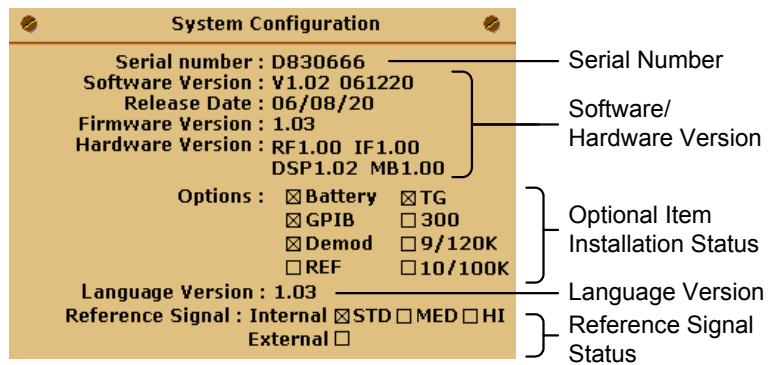

- To close the configuration, press F4 again (System Config Off). 

Serial number The serial number for device identification. This number is necessary for various service level operations. The same number is pasted on the rear panel.

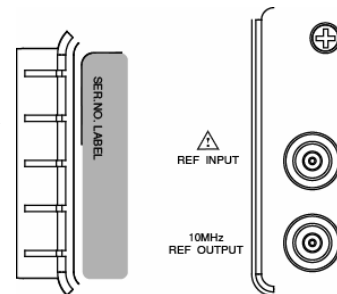









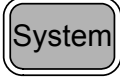
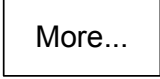



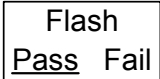

Software/hardware language version Shows versions and release date of hardware, software, firmware, and language database. Used for service level operations.

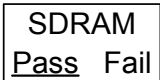
Optional item installation status	Shows which optional item is currently installed. <input checked="" type="checkbox"/> : installed, <input type="checkbox"/> : uninstalled.	
	Sign	Description
	Battery	Battery pack / DC input module (page148)
	GPIB	GPIB interface (page127)
	Demod	Demodulator (page144)
	REF	Internal reference signal with middle range stability (±1ppm stability module - page174).
	300	300Hz RBW (page96)
	9/120K	9k/120kHz RBW(page96) included in the EMI Filter(page146)
	10/100K	10k/100kHz RBW (page96)
Reference signal status	Checked radio button shows the reference signal used. For reference signal usage, see page133. <input checked="" type="checkbox"/> : enabled, <input type="checkbox"/> : disabled.	
	Sign	Description
	Internal STD	Internal reference signal, standard stability
	Internal MED	Internal reference signal, medium stability. Available when the ±1ppm stability module (page174) is installed.
	Internal HI	Internal reference signal, high stability (reserved for future use).
	External	External reference signal.

View self-test result

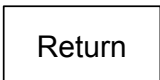
Background The GSP-830 runs a series of internal tests upon power-up. If any of the test result shows Fail, contact the service center.

Panel operation	1. Press the System key.	
	2. Press F6 (More).	 
	3. Press F2 (Self Test).	 
	4. The result appears in F1 to F4. (The GPIB result appears only when the module is installed)	 
		 
 		
 		
5. Press F6 (Return) to go back to the previous menu.	 	

Item	GPIB	The optional GPIB interface connection. Available only when the GPIB module is installed (page129).
	Flash	Internal Flash memory area for storing the system code and data.
	SDRAM	Internal SDRAM area on which the code runs.
	RTC	The real-time clock that controls the date and time settings (page132).

Set Date/Time

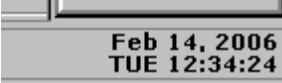
1. Activate clock display (if necessary)	<p>The clock display is activated by default.</p> <hr/> <p>1. Press the System key.</p> <div style="display: flex; align-items: center; margin-left: 100px;"> <div style="border: 1px solid gray; border-radius: 10px; padding: 5px 15px; margin-right: 10px;">System</div> </div> <hr/> <p>2. Press F6 (More).</p> <div style="display: flex; align-items: center; margin-left: 100px;"> <div style="border: 1px solid gray; padding: 5px 10px; margin-right: 10px;">More...</div> <div style="background-color: #ccc; border-radius: 5px; padding: 5px 10px; margin-right: 10px;">F 6</div> </div> <hr/> <p>3. Press F1 (System Clock).</p> <div style="display: flex; align-items: center; margin-left: 100px;"> <div style="border: 1px solid gray; padding: 5px 10px; margin-right: 10px;">System Clock...</div> <div style="background-color: #ccc; border-radius: 5px; padding: 5px 10px; margin-right: 10px;">F 1</div> </div> <hr/> <p>4. Press F3 (Clock On). The clock appears at the bottom right side of the display.</p> <div style="display: flex; align-items: center; margin-left: 100px;"> <div style="border: 1px solid gray; padding: 5px 10px; margin-right: 10px;">Clock On Off</div> <div style="background-color: #ccc; border-radius: 5px; padding: 5px 10px; margin-right: 10px;">F 3</div> </div> <div style="margin-left: 100px; margin-top: 10px;">  </div>																							
2. Set date	<p>1. Press F1 (Date).</p> <div style="display: flex; align-items: center; margin-left: 100px;"> <div style="border: 1px solid gray; padding: 5px 10px; margin-right: 10px;">Date...</div> <div style="background-color: #ccc; border-radius: 5px; padding: 5px 10px; margin-right: 10px;">F 1</div> </div> <hr/> <p>2. Press F1 (Year) to F4 (Day of Week). Enter the value using the Numerical keys and Enter key.</p> <div style="display: flex; align-items: center; margin-left: 100px; margin-bottom: 10px;"> <table border="1" style="border-collapse: collapse; text-align: center; font-size: 8px;"> <tr><td>0</td><td>1</td><td>2</td><td>3</td><td>4</td></tr> <tr><td>5</td><td>6</td><td>7</td><td>8</td><td>9</td></tr> <tr><td>Enter</td><td>Enter</td><td>Enter</td><td>Enter</td><td>Enter</td></tr> </table> <div style="margin: 0 10px;">Enter</div> <div style="border: 1px solid gray; border-radius: 10px; padding: 2px 5px; font-size: 8px;">kHz / μSec</div> <div style="margin: 0 10px;">Enter</div> </div> <p>The clock display changes accordingly.</p> <div style="display: flex; flex-direction: column; margin-left: 100px;"> <div style="display: flex; align-items: center; margin-bottom: 5px;"> <div style="border: 1px solid gray; padding: 5px 10px; margin-right: 10px;">Year</div> <div style="background-color: #ccc; border-radius: 5px; padding: 5px 10px;">F 1</div> </div> <div style="display: flex; align-items: center; margin-bottom: 5px;"> <div style="border: 1px solid gray; padding: 5px 10px; margin-right: 10px;">Month</div> <div style="background-color: #ccc; border-radius: 5px; padding: 5px 10px;">F 2</div> </div> <div style="display: flex; align-items: center; margin-bottom: 5px;"> <div style="border: 1px solid gray; padding: 5px 10px; margin-right: 10px;">Day</div> <div style="background-color: #ccc; border-radius: 5px; padding: 5px 10px;">F 3</div> </div> <div style="display: flex; align-items: center;"> <div style="border: 1px solid gray; padding: 5px 10px; margin-right: 10px;">Day of Week</div> <div style="background-color: #ccc; border-radius: 5px; padding: 5px 10px;">F 4</div> </div> </div> <hr/> <table border="0" style="width: 100%; border-collapse: collapse;"> <tr> <td style="width: 20%; padding-right: 20px;">Year</td> <td>2000 to 2099</td> </tr> <tr> <td style="padding-right: 20px;">Month</td> <td>1 to 12 (translated to Jan to Dec)</td> </tr> <tr> <td style="padding-right: 20px;">Day</td> <td>1 to 31 (depends on the month)</td> </tr> <tr> <td style="padding-right: 20px;">Day of Week</td> <td>1(Mon) to 7(Sun)</td> </tr> </table>	0	1	2	3	4	5	6	7	8	9	Enter	Enter	Enter	Enter	Enter	Year	2000 to 2099	Month	1 to 12 (translated to Jan to Dec)	Day	1 to 31 (depends on the month)	Day of Week	1(Mon) to 7(Sun)
0	1	2	3	4																				
5	6	7	8	9																				
Enter	Enter	Enter	Enter	Enter																				
Year	2000 to 2099																							
Month	1 to 12 (translated to Jan to Dec)																							
Day	1 to 31 (depends on the month)																							
Day of Week	1(Mon) to 7(Sun)																							
3. Set time	<p>1. Press F2 (Time).</p> <div style="display: flex; align-items: center; margin-left: 100px;"> <div style="border: 1px solid gray; padding: 5px 10px; margin-right: 10px;">Time...</div> <div style="background-color: #ccc; border-radius: 5px; padding: 5px 10px; margin-right: 10px;">F 2</div> </div>																							

- Press F1 (Year) to F3 (Second). Enter the value using the Numerical keys and Enter key.



The clock display changes accordingly.

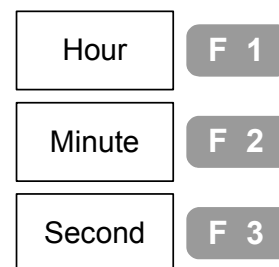

Hour	0 to 23
Minute	0 to 59
Second	0 to 59

Synchronize GSP-830 with Other Devices

Using the REF INPUT/OUTPUT on the rear panel, the GSP-830 can synchronize its internal frequency with other devices. The GSP-830 can become the master (reference signal for another device) or the slave (reference signal input from another device).

GSP-830 as master (internal reference signal)

Panel operation Connect the reference signal output terminal on the rear panel to the other device's reference input.

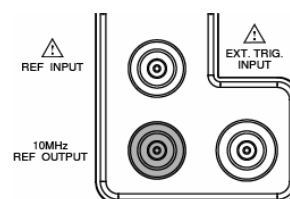

Signal type **Output level** 10MHz, 5V TTL signal (assumes the load impedance is infinite)

Output impedance 50Ω

- Press the System key.

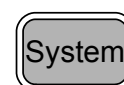

- Press F6 (More).

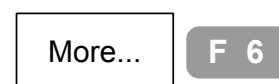

- Press F4 (System Config On).

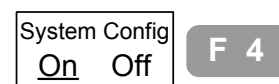

The system configuration window appears. The Internal Reference Signal sign **Internal** shows the status.

: enabled, : disabled.

STD Internal reference signal, standard stability

- 

Internal reference signal, median stability. Available when the ± 1 ppm stability module (page 174) is installed. The MED icon appears at the bottom of the display.
- 

Internal reference signal, high stability (reserved for future use).

GSP-830 as slave (external reference signal)

- Panel operation
1. Press the Option key.

 2. Press F4 (Ext Ref Freq) to enable external reference signal.

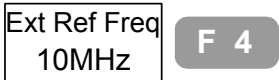
 3. Use the Left/Right keys or Scroll knob to select the external reference frequency.

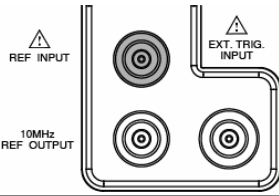

 4. Connect the external reference signal to the input terminal on the rear panel.



 5. The external reference signal icon appears at the bottom of the display.



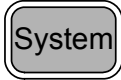

Signal type	TTL signal				
Frequency	10 preset frequencies are available (units in MHz).				
	1.0	1.544	2.048	5.0	10.0
	10.24	13.0	15.36	15.4	19.2

- Status check
1. Press the System key.







 2. Press F6 (More).

 3. Press F4 (System Config On).

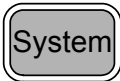
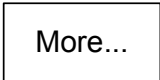

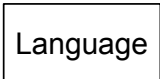

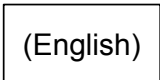
The system configuration window appears. The External Reference Signal sign **External** shows the status:  - enabled,  - disabled.

Select Language

Panel operation	1. Press the System key.	
	2. Press F6 (More).	 
	3. Press F5 (Language).	 
	4. Press F1 repeatedly to select the menu language.	 
Language type	English → Simplified Chinese → Other selections (The language selection depends on the regions)	



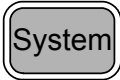



Use Auxiliary Signal

The auxiliary signal is a general purpose signal useful for functionality check.

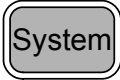
Panel operation	1. Press the System key.	
	2. Press F4 (Aux Sig On). The auxiliary signal appears in the display.	 
Specification	100MHz, -30dBm	

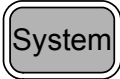
Enter Service Operation

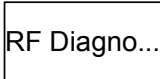
The following functions are intended only for service personnel.

Optional items maintenance	1. Press the System key.	
	2. Press F5 (Service). To continue, a password is needed.	 
RF diagnosis	1. Press the System key.	
	2. Press F6 (More).	 
	3. Press F3 (RF Diagno). To continue, a password is needed.	 





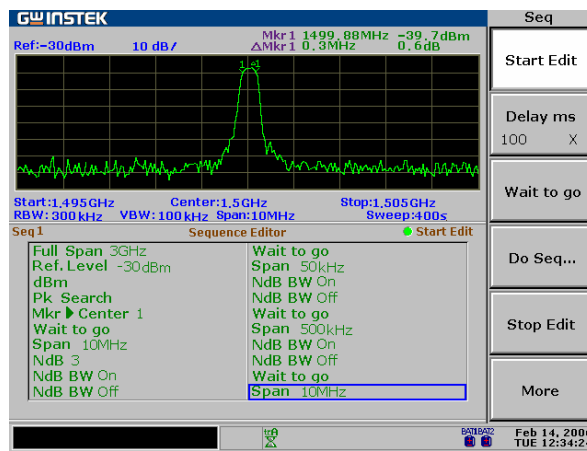



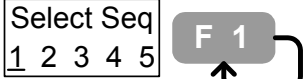
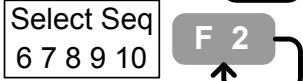

SEQUENCE

The **Sequence** function records and plays back user-defined macros (measurement steps). 10 sequences are available in repeat or single running mode, each with maximum 20 steps including all panel operations. Delay and pause features permit observing measurement results during the sequence.

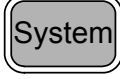
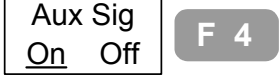

Edit	1. Select sequence	137
	2. Start editing.....	137
	3. Stop editing	140
	4. Save the edited sequence	140
	Delete all sequence.....	140
Run	1. Select sequence	140
	2. Select running mode.....	141
	3. Run sequence	141
Sequence File	Save/copy/delete/rename sequence file	141

Edit Sequence

1. Select sequence	1. Press the Sequence key. The display enters into the sequence edit mode.	
	2. Press F1 (sequence 1 to 5) or F2 (sequence 6 to 10) repeatedly to select the sequence ID.	 
2. Start editing	1. Press F3 (Edit).	
	2. Press F1 (Start Edit).	
	3. The Start Edit sign in the mid-right of the display turns green.	
2a. Add step	<p>20 steps are available for each sequence. Every key operation can be recorded as a step. Press the Enter key each time to confirm step entering. (In some cases this is not necessary: check if the item appears in the window).</p>	
	<p>Example: Activate system auxiliary signal</p>	
	1. Press the System key.	
	2. Press F4 (Aux Sig On).	
	3. Press the Enter key.	
	<p>Example: Run Autoset</p>	
	1. Press the Autoset key.	
	2. Press F1 (Autoset).	
	3. Press the Enter key.	
	The result looks like this.	

2b. Add delay

The delay function inserts a waiting period between steps. The basic unit of delay time is 100ms.

- 1. Press F2 (Delay ms).

Delay ms
100 X

F 2

- 2. Enter the delay time using the Numerical keys and Enter key.

For example, pressing 5 + Enter inserts 500ms (5 * 100ms) and pressing 100 + Enter inserts 10s (100 * 100ms = 10,000ms = 10s).

Range 100ms to 10s, 100ms resolution

2c. Pause sequence

Stops executing the sequence until the F1 (Continue) is pressed. Useful for observing the result of particular action (for example ACPR measurement).

- 1. Press F3 (Wait to go).

Wait to go

F 3

- 2. When the sequence is running, F1 (Continue) menu appears on the menu. Press it to break the pause and continue the sequence.

Continue

F 1

2d. Insert another sequence

Inserts a whole sequence set.

- 1. Press F4 (Do Seq).

Do Seq...

F 4
- 2. Press F1 (sequence 1 to 5) or F2 (sequence 6 to 10) repeatedly to select the inserted sequence.

Select Seq
1 2 3 4 5

F 1

Select Seq
6 7 8 9 10

F 2

Note: The currently edited sequence cannot be inserted.

2e Insert blank space

- 1. Press F6 (More).

More

F 6

- 2. Use the Up/Down keys to move the cursor to the insertion point.

- 3. Press F1 (Insert). A blank space will be created.

Insert

F 1

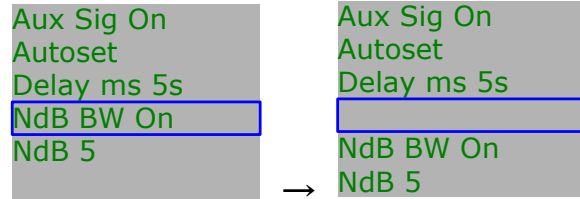

4. Press F6 (Return) to go back to the previous menu.
- | | |
|--------|-----|
| Return | F 6 |
|--------|-----|

2f. Delete step

1. Press F6 (More).
- | | |
|------|-----|
| More | F 6 |
|------|-----|

2. Use the Up/Down keys to move the cursor to the deletion point.
-

3. Press F3 (Delete). The step will be deleted.
- | | |
|--------|-----|
| Delete | F 3 |
|--------|-----|

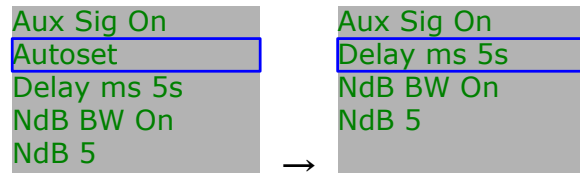

4. To undo deletion, press F5 (Undelete).
- | | |
|----------|-----|
| Undelete | F 5 |
|----------|-----|

5. To go back to the previous menu, press F6 (Return).
- | | |
|--------|-----|
| Return | F 6 |
|--------|-----|

2g. Delete all steps in a sequence

1. Press F6 (More).
- | | |
|------|-----|
| More | F 6 |
|------|-----|

2. Press F4 (Delete All).
- | | |
|--------------|-----|
| Delete All.. | F 4 |
|--------------|-----|

3. Press F2 (Yes) to confirm, or F1 (No) to cancel. All steps will be deleted.
- | | |
|-----|-----|
| No | F 1 |
| Yes | F 2 |

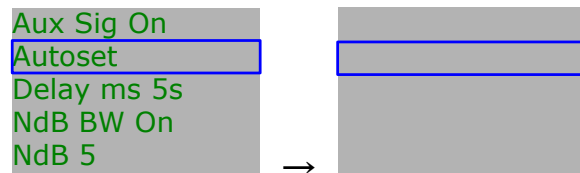

4. To undo deletion, press F5 (Undelete).
- | | |
|----------|-----|
| Undelete | F 5 |
|----------|-----|

	5. Press F6 (Return) to go back to the previous menu.	Return	F 6
3. Stop editing	1. Press F5 (Stop Edit).	Stop Edit	F 5
	2. The Start Edit sign in the display mid-right turns off.		
4. Save the edited sequence	1. Press F6 (More).	More	F 6
	2. Press F2 (Save). The sequence is saved.	Save	F 2
	3. Press F6 (Return) to go back to the previous menu.	Return	F 6

Delete all sequences









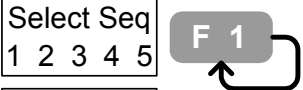
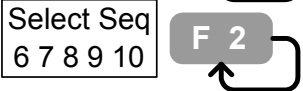

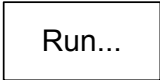
Panel operation	1. Press the Sequence key.		
	2. Press F5 (Delete Seq All).	Delete Seq All...	F 5
	3. Press F2 (Yes) to confirm, or F1 (No) to cancel. All 10 sequences will be deleted.	No	F 1
		Yes	F 2
4. To go back to the previous menu, press F6 (Return).	Return	F 6	

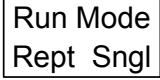
Note Delete Seq All cannot be recovered – the Undelete function is not applicable.

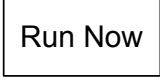
Run Sequence

This section assumes that editing the sequence is completed.

1. Select sequence	1. Press the Sequence key		
	2. Press F1 (sequence 1 to 5) or F2 (sequence 6 to 10) repeatedly to select the sequence.	 	

2. Select running mode	1. Press F4 (Run).		
	2. Press F1 (Run Mode) to select the running mode, repeat (Rept) or single (Sngl).		
	Repeat	Repeats running a sequence until F6 (Stop) is pressed. Note: F6 (Stop) menu appears only when the sequence is running.	
	Single	Runs the sequence once.	
3. Run sequence	1. Press F2 (Run Now).		
	2. If the sequence editing has not yet finished, a warning message appears. In such case, stop (finish) the editing process first (page140).		
	3. The sequence icon appears at the bottom of the display.		
	4. To stop running, press F6 (Stop). In the single mode, the sequence automatically stops when all steps are completed.		

Save/copy/delete/rename sequence file

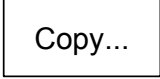
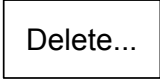
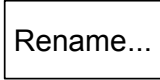
Background	Sequence files can be saved, copied, deleted, or renamed using the file utility. Press the File key to access each function.	
Save/Copy	Press F1 (Copy). For detailed steps, see page115.	
Delete	Press F2 (Delete). For detailed steps, see page118.	
Rename	Press F3 (Rename). For detailed steps, see page120.	

T RACKING GENERATOR

The optional **Tracking Generator** (Opt.01) is a factory installed item which generates a sweep signal with its sweep time and frequency range matching the GSP-830 system. The amplitude is maintained to a constant value over the entire frequency range, which is very useful for testing the frequency response of the DUT.







Activate tracking generator

1. Activate TG output	1. Press the Option key.	
	2. Press F1 (TG).	
	3. Press F1 (TG On).	
	4. The tracking generator output becomes activated.	
2. Set TG output level	1. Press F2 (TG Level).	
	2. Change the TG output level using the Numerical keys and Enter key.	
Range		0 to -50dBm

Normalize tracking generator

1. Set reference level	1. Press the Option key.	
------------------------	--------------------------	--

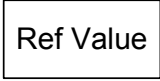

- 2. Press F1 (TG).  





- 3. Press F5 (Ref Value).  

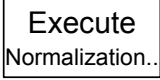

- 4. Set the reference value using the Numerical keys and Enter key. 

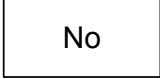

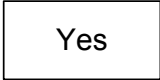
Normalization amplitude is set at Reference level regardless of the TG output level.

Range -130dBm to +20dBm

- 2. Run normalization
 - 1. Press F3 (Execute Normalization).  

 - 2. Press F2 (Yes) to confirm running Normalization. Press F1 (No) to cancel running.  
 

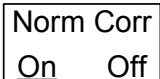

 - 3. Press F6 (Return) to go back to the previous menu.  



- 3. Activate normalization
 - 1. To activate normalization, press F4 (Norm Corr On).  

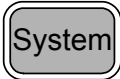

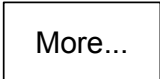
 - 2. Normalization is activated and the TG icon appears. 

Check TG installation status

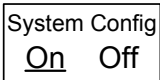
- Panel operation
 - 1. Press the System key. 

 - 2. Press F6 (More).  

 - 3. Press F4 (System Config On). The configuration appears.  

 - 4. The TG sign shows the installation status, installed (checked) or not installed (unchecked).  

DEMODULATOR

The optional FM/AM **Demodulator** (Opt.07) is a factory installed item which recovers AM or FM modulated baseband signal. The demodulated signal can be output from the rear panel 3.5mm mini-phone jack.



Activate demodulation

Panel operation	1. Press the Option key.	
	2. Press F2 (Demod).	
	3. Select Frequency Modulation or Amplitude Modulation by pressing F1 (FM On) or F2 (AM On).	





Activate phone output

Panel operation	1. Press F2 (Demod).	
	2. Press F3 (SPK On). The rear panel phone output becomes active.	

Specification	<ul style="list-style-type: none"> • 3.5mm stereo headphone jack wired for mono • Maximum 0.5W output into 8 Ω load • Frequency range: 30Hz to 50kHz
---------------	---

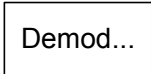

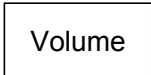

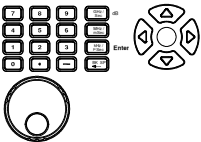
Note	Either FM or AM must be turned on before activating the phone output.
------	---

Set phone output volume



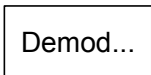

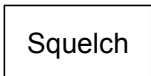
Panel operation	1. Press F2 (Demod).	 
	2. Press F4 (Volume).	 
	3. The volume level appears in the command window.	
	4. Change the output volume using the Numerical keys, Arrow keys, or Scroll knob followed by the Enter key.	

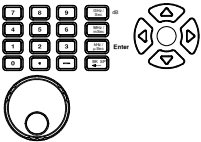
Volume level 0 to 63

Cut off phone output noise (squelch)

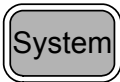
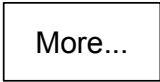
Panel operation	1. Press F2 (Demod).	 
	2. Press F5 (Squelch). Squelch level: 0 to 4	 
	3. The squelch level appears in the command window. Output level lower than the setting is muted.	
	4. Change the squelch level using the Numerical keys, Arrow keys, or Scroll knob followed by the Enter key.	

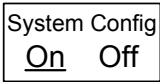



Check Demodulator installation status

Panel operation	1. Press the System key.	
	2. Press F6 (More).	 
	3. Press F4 (System Config On). The configuration appears.	 
	4. The Demodulator sign shows the installation status, installed (checked) or not installed (unchecked).	<p>Installed <input checked="" type="checkbox"/> Demod</p> <p>Not installed <input type="checkbox"/> Demod</p>

EMI FILTER



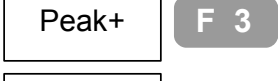
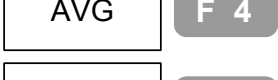
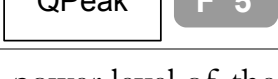

The optional **EMI filter** (Opt. 05, also called 9kHz/120kHz RBW) is a factory installed optional item used for specific measurement situations such as EMI average detection, where a higher level of sensitivity is required than the standard configuration. When this module is installed, the GSP-830 acquires two additional features: Average/Quasi-peak detection mode, and 9k/120k RBW.

Select average/ quasi peak signal detection mode

Panel operation	1. Press the Trace key.	
	2. Press F6 (More).	
	3. Press F3 (Detection).	
	4. The signal detection mode appears. When the EMI filter is installed, F4 (AVG) and F5 (QPeak) becomes available. For signal detection mode details, see page80.	    



Parameter	AVG (average)	Detects the average power level of the samples using a low pass filter. Useful for smoothing the noise level.
	QPeak (quasi-peak)	Detects the quasi-peak power level of the samples. Useful for viewing in zero span without missing signal variations.

Select 9kHz/120kHz RBW

Panel operation	1. Press the BW key.	
	2. Press F1 (RBW Man).	
	3. Select 9kHz/120kHz RBW using the Arrow keys or Scroll knob. The RBW value appears in the command window.	 

Note In the automatic mode, RBW is selected according to the internal reference setting.
For reference RBW/VBW setting, see page99.

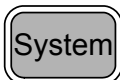
Check EMI filter installation status

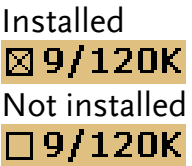
Panel operation	1. Press the System key.	
	2. Press F6 (More).	
	3. Press F4 (System Config On). The system configuration window appears.	
	4. The 9/120k RBW sign shows the installation status, installed (checked) or not installed (unchecked).	

Note EMI filter (9k/120k RBW) and 10k/100k RBW are exclusive. These two optional items cannot be installed together.

BATTERY / DC

OPERATION

The **Battery Pack** (Opt.02) is an optional item permitting portable field operation of the GSP-830 using internal battery. The **DC Input** permits using an automobile 12V power, also useful for field operation.



Battery Operation

Package removal / insertion 

Turn Off the main power switch and remove the power cord before inserting or removing the battery pack.

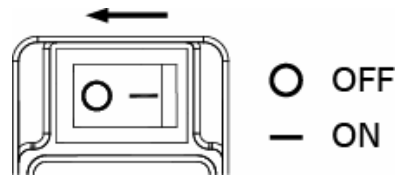

Turn the knob to open the battery compartment.

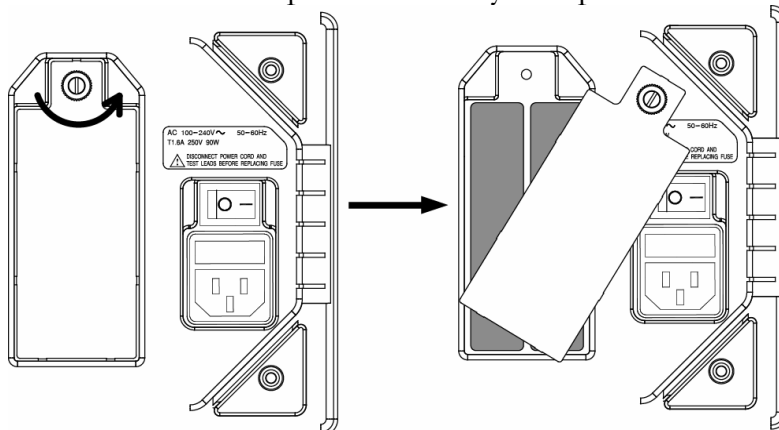

Check Battery level 1. Press the Option key.



2. Press F3 (Battery). The level icon appears at the bottom of the display.



	Fully charged		50% to 25%
	75% to 50%		Less than 25%

Note Regardless of battery check, the GSP-830 shows the icon for 5 seconds every 30 minutes.

Battery maintenance	To prolong the battery life, take out the batteries when they are not in use for more than one month.
Parameter	Usage time 3 hours (typical)
	Charge time 3 hours (typical)

Check battery installation status

- Panel operation
- Press the System key.
 - Press F6 (More).
 - Press F4 (System Config On). The configuration appears.
 - The Battery sign shows the installation status, installed (checked) or not installed (unchecked).

Installed	<input checked="" type="checkbox"/> Battery
Not installed	<input type="checkbox"/> Battery

DC Operation

Panel operation	Connect the DC power cable to the rear panel input connector.	
Specification	12V, 40W max, 2.1mm plug	
Battery charging	When the DC power is in use, the batteries are also charged.	
Note	DC power cable (with a lighter plug for automobile usage) is available as an optional item, GTL-401 (page174).	

PC SOFTWARE

The proprietary **PC software** (Eagleshot) for remote operation is downloadable from Good Will Instruments website (www.gwinstek.com.tw). The Eagleshot software permits waveform viewing and major panel operations using the familiar PC interface: large monitor, keyboard, and mouse.

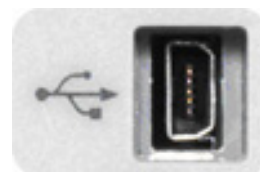
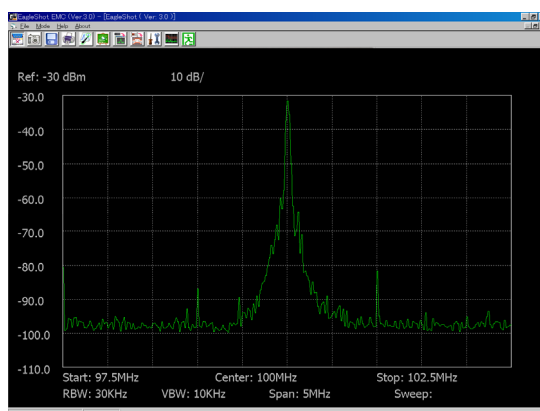

Installation	PC requirement.....	151
	Software download	151
	Installation step.....	151
Invocation	Configure interface	152
	Invoke software.....	152
Usage	Establish connection.....	154
	Capture waveform	154
	Clear waveform	154
	Save waveform	155
	Printout screen image.....	155
	Use marker	155
	Exit program	156

Install Software

PC requirement

Software	OS	Windows 2000/XP
Hardware	USB	1 USB host connector, 1.1 or 2.0 compatible



Software download

1. Website access Access <http://www.gwinstek.com.tw/>.
2. Download Go to the GSP-830 corner and download the software.

Installation step

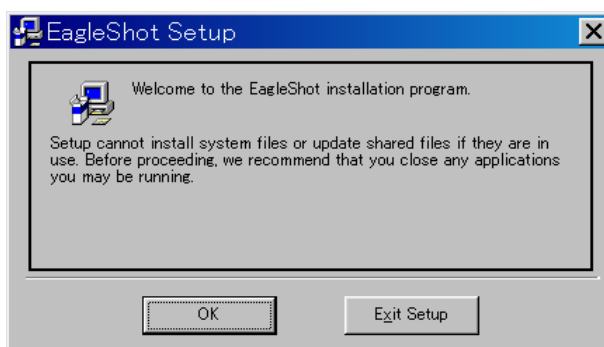
1. Activate setup software
 1. Unpack the zip file.
 2. Double click Setup.exe.
 3. The setup screen opens. Close all other applications and click OK. To cancel, click Exit Setup.



2. Start installation
 1. To install the software into a specific directory, click the Change Directory button.
 
 2. Click the icon to start installation.
 
 3. When the installation is successful, a message appears. Click OK to complete the installation.

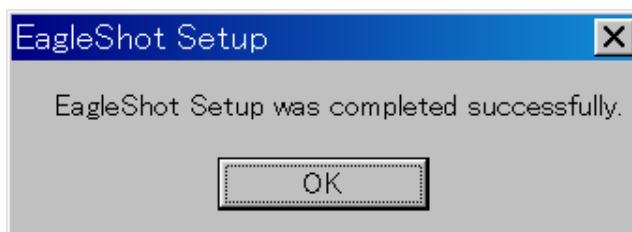





Connect Software

This section assumes that the software is already installed.

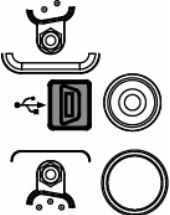
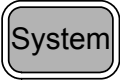
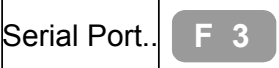
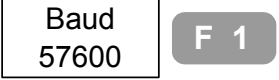
Configure interface

USB slave or RS-232C is acceptable.

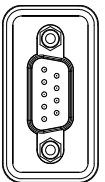
<p>Configure USB</p>	<p>No need to configure anything on the GSP-830 side. Just connect the type B mini USB cable to the rear panel.</p>	
<p>Configure RS-232C</p>	<ol style="list-style-type: none"> The RS-232C configuration can be checked from the system menu. Press the System key. Press F3 (Serial Port). The RS-232C port configuration appears. Configure the PC according to this setting. Baud: 57600 Parity: None Stop bit: 1 Data bit: 8 Connect a 9 pin, male RS-232C cable to the rear panel connector. 	      

Invoke software

PC operation

- Invoke the software from the startup menu in the PC.

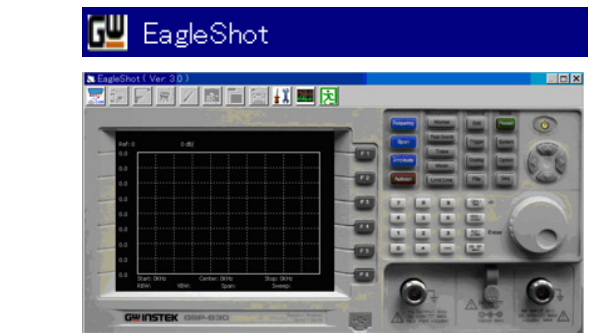

- Click the setting icon. The parameter setting window appears.

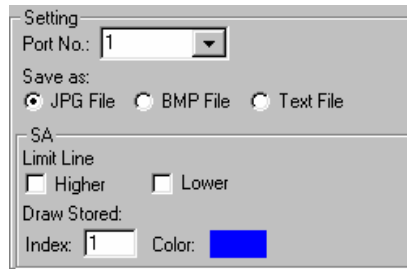

- Select the connection port (COM port).

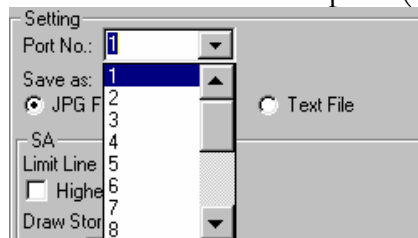

To check the configuration in the PC, go to Control panel → System properties → Device Manager.

- Click the Setting icon again to close the setting window



- Click the Open COM Port icon. The connection is established when the other icons become active.



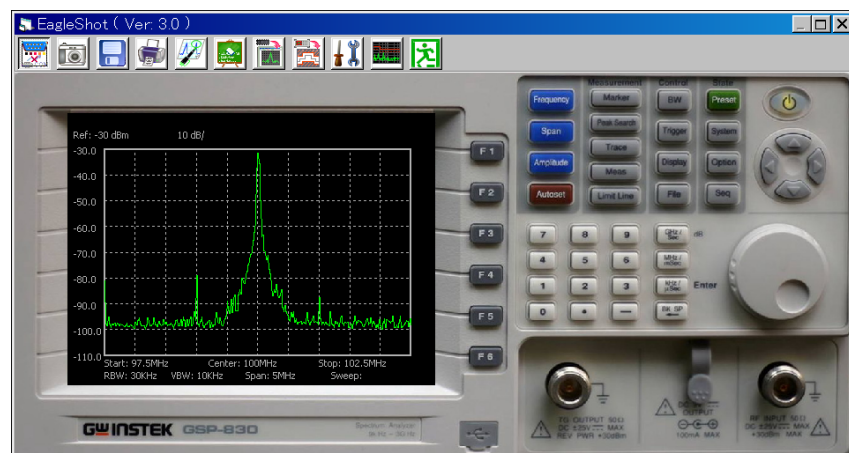

- Functionality check Click the Capture icon. Make sure the waveform shown in the GSP-830 display is captured correctly.

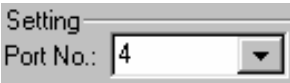

Use Software

Establish connection

Operation step	1. Press the setting icon and open the parameter setting window.	
	2. Select the serial port terminal.	
	3. Press the COM port icon. The connection is established when the other icons become active.	
Port setting	Select the port specified in the PC configuration. To check the configuration in the PC, go to Control panel → System properties → Hardware tab → Device Manager.	

Capture waveform

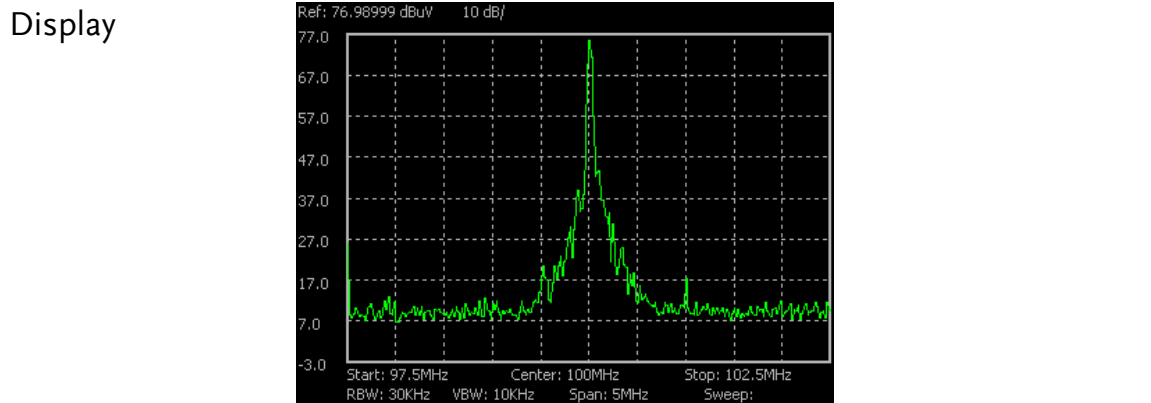

Operation step	Click the capture icon. The current waveform is captured and appears on the screen.	
----------------	---	---



Clear waveform

Operation step	Click the clear trace icon. The waveform is cleared from the screen.	
----------------	--	---



Save waveform

Operation step	<p>1. Press the setting icon. Select the file format from *.jpg/*.bmp (screen snapshot), *.txt (measurement data).</p>	
		
	<p>2. Press the save icon. The standard save dialogue window opens. Select the directory and save the file.</p>	
File format	<p>The *.txt file contains the following information.</p> <ul style="list-style-type: none"> • Frequency (MHz) and Amplitude for all waveforms • Amplitude reference level, unit, and scale • Start, Stop, Center frequency, and frequency span • RBW, VBW, and sweep time • Date and time (if already configured) 	

Printout screen image

Operation step	<p>Click the print icon. The standard printout dialogue opens. Select the printer and printout the screen image.</p>	
Note	<p>The screen image contrast will be reversed (background color becomes white).</p>	

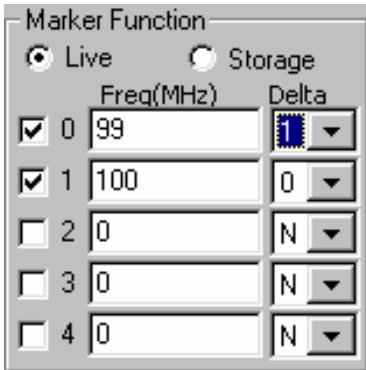
Use marker

Operation step	<p>1. Click the marker icon. The marker function window appears.</p>	
		
	<p>2. Select Live or Storage.</p>	

3. Check the marker ID box. 5 markers, 0 to 4, are available.



4. Enter the frequency to each marker in MHz.

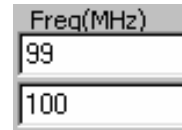

5. Select normal (N) or delta marker. Example:
Marker 0 & Delta 1: the delta marker shows the difference between marker0 and marker1.



6. The display is updated with markers in red color. The marker values are listed at the bottom of the display.

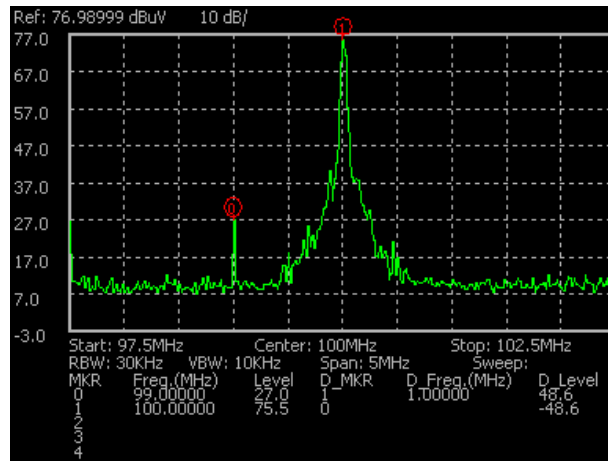

Exit program

Operation step Click the exit icon or press Alt key + F4.



REMOTE CONTROL





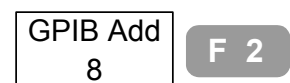
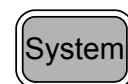
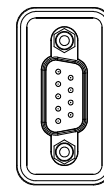
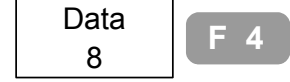
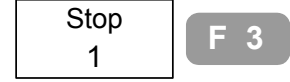
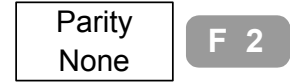
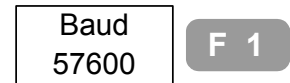
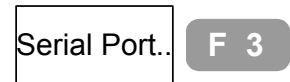
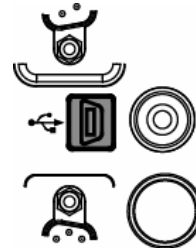

The GSP-830 supports remote control which is partially based on IEEE 488.2 and SCPI (Standard Commands for Programmable Instrumentation) standards. The command set covers most of the panel operations. Three interfaces are available: USB slave, RS-232, and GPIB.

Interface	Configure Interface	158
Command Syntax	Command Syntax	160
Command Set	IEEE488.2 standard commands	161
	Frequency	161
	Span	161
	Amplitude	162
	Autoset	162
	Marker & Peak Search	163
	Trace	164
	Power measurement	165
	Limit line	166
	BW	167
	Trigger	167
	Display	168
	File	168
	Preset	169
	System	169
	Option	170
	Sequence	170

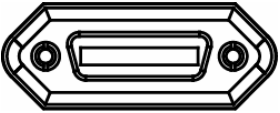
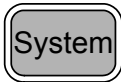
Configure Interface

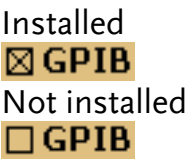
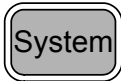
Interface type	USB slave	USB 1.1 or 2.0, type B mini
	RS-232C	D-sub 9 pin
	GPIB (optional)	24 pin
USB slave port configuration	<p>No need for panel configuration: Just connect a type B mini USB cable to the rear panel.</p> <p> The USB icon turns on when the connection is detected.</p>	
RS-232C configuration	<p>1. The RS-232C configuration can be checked from the system menu. Press the System key.</p>	
	<p>2. Press F3 (Serial Port).</p>	
	<p>3. The RS-232C port configuration appears. Configure the PC according to this setting:</p> <p>Baud: 57600 Parity: None Stop bit: 1 Data bit: 8</p>	
	<p>4. Connect a 9-pin male RS-232C cable to the rear panel terminal.</p>	
GPIB (optional) configuration	<p>GPIB interface is a factory installed optional item. Contact the service center for a new installation.</p>	
	<p>1. Press the System key.</p>	
	<p>2. Press F2 (GPIB Add).</p>	



	3. Select the GPIB address using the Left/Right keys or Scroll knob. Configure the PC accordingly.	
	4. Connect the GPIB cable to the rear panel terminal.	
Check GPIB installation status	1. To check the GPIB installation status, press the System key.	
	2. Press F6 (More).	
	3. Press F4 (System Config On). The configuration appears.	
	4. The system configuration window appears. GPIB sign shows installed (checked) or not installed (unchecked)	
Check GPIB self-test result	1. To check the internal GPIB functionality test result, press the System key.	
	2. Press F6 (More).	
	3. Press F2 (Self Test).	
	4. The GPIB result appears at F1. If the result is Fail (underlined), contact the service center.	
GPIB constraints	<p>Keep these rules when using the GPIB interface.</p> <ul style="list-style-type: none"> • Altogether less than 15 devices & 20m cable length, 2m between each device on the bus • Unique address assigned for each device • At least 2/3 of the GPIB devices turned On • No loop or parallel structure allowed 	
Functionality Check	<p>Run this query command from the terminal.</p> <p>*idn?</p> <p>This should return the Manufacturer, Model number, Serial number, and Firmware version.</p> <p>GW, GSP-830, P920130, V3.01</p>	

Command Syntax

The commands are partially compatible with IEEE488.2 (1992) and SCPI (Standard Commands for Programmable Instrumentation) (1994) standards. Commands are NON-case sensitive.

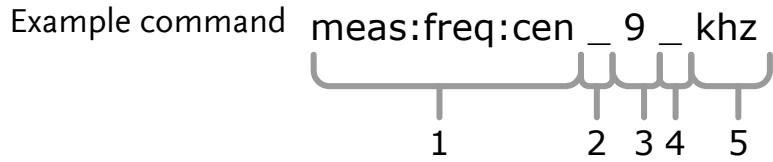

- | | |
|-------------------|-----------------|
| 1: Command Header | 2: Single space |
| 3: Parameter1 | 4: Single space |
| 5: Parameter2 | |

Command Header Several command header elements (nodes) can be concatenated to form a complex command. The above example can be separated into:
 meas: (root node) + freq: + cen:

Parameter example	0/1	0 or 1.
	1to4	Integer between 1, 2, 3, or 4.
	0.01to5	Decimal number between 0.01 and 5.
	khz	Unit (non-case sensitive)

Message Terminator Marks the end of a command line. Any of the following is acceptable.

CR^END	Line feed code (hexadecimal 0D) with END message
CR	Line feed code
<dab>^END	Last data byte with END message

Message Separator ; (semicolon) Command separator.

Command Set

- Commands are **non**-case sensitive.
- Underline means a single space (100_mhz→100 mhz).

IEEE488.2 standard commands

*cls	Clear Status Command
*ese?	Standard Event Status Enable Command
*ese	Standard Event Status Enable Query
*esr?	Standard Event Status Register Query
*idn?	Identification Query. Parameter: Manufacturer, Model, Serial number, Firmware version. Example: GW, GSP-830, P920130,V3.01
*opc?	Operation Complete Command
*opc	Operation Complete Query
*rst	Reset Command
*sre?	Service Request Enable Command
*sre	Service Request Enable Query
*stb?	Read Status Byte Query
*tst?	Self-Test Query
*wai	Wait-to-Continue Command

Frequency

meas:freq:cen?	Returns the center frequency in kHz. Example: 1000000 khz
meas:freq:cen	Sets the center frequency. Example: meas:freq:cen_100_mhz
meas:freq:st?	Returns the start frequency in kHz. Example: 1000000 khz
meas:freq:st	Sets the start frequency. Example: meas:freq:st_100_mhz
meas:freq:stp?	Returns the stop frequency in kHz. Example: 1000000 khz
meas:freq:stp	Sets the stop frequency. Example: meas:freq:stp_100_mhz
meas:freq:ss?	Returns the frequency step size in kHz. Example: 1000000 khz
meas:freq:ss	Sets the frequency step. Example: meas:freq:ss_100_mhz
meas:freq:cen:fw	Moves the center frequency one step size forward.
meas:freq:cen:bw	Moves the center frequency one step size backward.

Span

meas:span?	Returns the frequency span in kHz. Example: 10000 khz
meas:span	Sets the frequency span. Example: meas:span:10_mhz
meas:span:full	Sets the frequency span to full.
meas:span:zero	Sets the frequency span to zero.
meas:span:last	Recalls the last frequency span setting.

Amplitude

meas:refl:unit?	Returns the reference level unit. Parameter: 1 (dBm), 2 (dBmV), 3 (dBuV)
meas:refl:unit	Sets the reference level unit. Parameter: 1 (dBm), 2 (dBmV), 3 (dBuV) Example: meas:refl:unit:_1 (dBm)
meas:refl?	Returns the reference level in the current unit. Example: -30 (-30dBm when the unit is dBm)
meas:refl	Sets the reference level in the current unit. Example: meas:refl:_-30 (-30dBm when in dBm)
meas:refl:scale?	Returns the amplitude scale. Parameter: 1(10dB/Div), 2(5dB/Div), 3(2dB/Div), 4(1dB/Div)
meas:refl:scale	Sets the amplitude scale. Parameter: 1(10dB/Div), 2(5dB/Div), 3(2dB/Div), 4(1dB/Div) Example: meas:refl:scale_1 (10dB/Div)
meas:refl:exg?	Returns the external gain/loss in dB. Example: -6 (-6dB)
meas:refl:exg	Sets the external gain/loss. Example: meas:refl:exg_-6 (-6dB)
meas:refl:corr:edit	Sets the amplitude correction data (frequency, amplitude). Need to specify the table index and the number of correction. Example: meas:refl:corr:edit_1_CR_2,100,-40,150,-30 (table index1, 2 data, 100MHz/-40dB, 150MHz/-30dB)
meas:refl:corr:edit:delall	Deletes all point in an amplitude correction set. Need to specify set index. Example: meas:refl:corr:edit:delall_5 (delete set No.5)
meas:refl:corr:on?	Returns the activated amplitude correction set. Parameter: none, 1 to 5 (correction set)
meas:refl:corr:on?	Returns the amplitude correction set is active or inactive. Need to specify the set index. Parameter: on, off Example: meas:refl:corr:on_1? (set No.1 is activated?)
meas:refl:corr:on	Activates the amplitude correction set. Specify the set index. Example: meas:refl:corr:on_1 (activate set No.1)
meas:refl:corr:off	Deactivates the amplitude correction set. Specify set index. Example: meas:refl:corr:off_1 (deactivate set No.1)
meas:inputz?	Returns the input impedance. Parameter: 0 (50 Ω), 1 (75 Ω)
meas:inputz	Sets the input impedance. Parameter: 0 (50 Ω), 1 (75 Ω) Example: meas:inputz_0 (50 Ω)
meas:inputz:cal?	Returns the input impedance calibration value in dB.
meas:inputz:cal	Sets the input impedance calibration value in dB. Example: meas:inputz:cal_5.9 (5.9dB)

Autoset

meas:autoset:run	Runs autoset.
meas:autoset:amp:auto	Sets the autoset amplitude floor setting to auto mode.
meas:autoset:amp:man	Sets the autoset amplitude floor setting to manual mode. Need to specify the amplitude in dB. Example: meas:autoset:amp:man_20 (20dB)

meas:autoset:amp:mode?	Returns the autoset amplitude floor setting mode. Parameter: auto, manual
meas:autoset:span:auto	Sets the autoset frequency span setting to auto mode.
meas:autoset:span:man	Sets the autoset frequency span setting to manual mode. Need to specify unit. Example: meas:autoset:span:man_100_khz (100kHz)
meas:autoset:span:mode?	Returns the autoset frequency span setting mode. Parameter: auto, manual

Marker & Peak Search

meas:mark:on?	Returns marker On/Off. Need to specify the marker ID. Parameter: on, off Example: meas:mark:on_1? (marker1 On?)
meas:mark:on	Turn On marker. Parameter: 1to5 (marker ID), all (all markers) Example: meas:mark:on_1 (marker 1 On)
meas:mark:off	Turn Off marker. Parameter: 1 to 5 (marker ID), all (all markers) Example: meas:mark:off_1 (marker 1 Off)
meas:mark:norm	Sets a marker to normal mode. Parameter: 1 to 5 (marker ID) Example: meas:mark:norm_1 (marker 1 normal mode)
meas:mark:norm:freq?	Returns the frequency of a normal marker. Need to specify ID. Example: meas:mark:norm:freq_1? (normal mkr1 frequency?)
meas:mark:norm:level?	Returns the amplitude of a normal marker. Need to specify ID. Example: meas:mark:norm:level_1? (normal mkr1 level?)
meas:mark:delta	Sets a marker to delta mode. Also sets the relative frequency. Parameter: 1 to 5 (marker ID) Example: meas:mark:delta_1 (marker 1 in delta mode) Example: meas:mark:delta_1_10_mhz (marker 1 in delta mode, relative frequency 10MHz)
meas:mark:delta:freq?	Returns the relative frequency of a delta mkr. Need to specify ID. Example: meas:mark:delta:freq_1?(delta mkr1 freq?)
meas:mark:delta:level?	Returns the relative amplitude of a delta mkr. Need to specify ID. Example: meas:mark:delta:level_1?(delta mkr1 amp?)
meas:mark:tomin	Moves a marker to minimum peak. Parameter: 1 to 5 (marker ID) Example: meas:mark:tomin_1 (marker 1 to min peak)
meas:mark:topeak	Moves a marker to the peak. Parameter: 1 to 5 (marker ID) Example: meas:mark:topeak_1 (marker 1 to peak)
meas:mark:tonp	Moves a normal/delta marker to the next peak. Parameter: 1 to 5 (marker ID) Example: meas:mark:tonp_1 (marker 1 to the next peak)
meas:mark:tonpr	Moves a normal/delta marker to the next right peak. Parameter: 1 to 5 (marker ID) Example: meas:mark:tonpr_1 (marker 1 to the next right pk)
meas:mark:tonpl	Moves a normal/delta marker to the next left peak. Parameter: 1 to 5 (marker ID) Example: meas:mark:tonpl_1 (marker 1 to the next left peak)

meas:mark:tocen	Moves a normal/delta marker to the center frequency. Parameter: 1 to 5 (marker ID) Example: meas:mark:tocen_1 (marker 1 to the center freq)
meas:mark:tost	Moves a normal/delta marker to the start frequency. Parameter: 1 to 5 (marker ID) Example: meas:mark:tost_1 (marker 1 to the start frequency)
meas:mark:tostp	Moves a normal/delta marker to the stop frequency. Parameter: 1 to 5 (marker ID) Example: meas:mark:tostp_1 (marker 1 to stop frequency)
meas:mark:toss	Moves a normal/delta marker to the center frequency + step. Parameter: 1 to 5 (marker ID) Example: meas:mark:toss_1 (marker 1 to center freq + step)
meas:mark:torefl	Moves a normal/delta marker to the reference level. Parameter: 1 to 5 (marker ID) Example: meas:mark:torefl_1 (marker 1 to the reference level)
meas:mark:trace	Moves a normal/delta marker to a trace. Parameter: 1 to 5 (marker ID), followed by 0 (auto), 1 (traceA), 2 (traceB), 3 (traceC) Example: meas:mark:trace_1_2 (marker 1 to traceB)
meas:mark:marktable:on	Activates marker table.
meas:mark:marktable:off	Deactivates marker table.
meas:mark:peaktable:on	Activates peak table.
meas:mark:peaktable:off	Deactivates peak table.
meas:mark:peaktable:sortf	Sorts peak table by frequency.
meas:mark:peaktable:sorta	Sorts peak table by amplitude.
meas:mark:peaktrack:on	Turns On peak track. Parameter: 1 to 5 (marker ID) Example: meas:mark:peaktrack:on_1 (marker1 track on)
meas:mark:peaktrack:off	Turns Off peak track. Parameter: 1 to 5 (marker ID) Example: meas:mark:peaktrack:off_1 (marker1 track off)
meas:mark:peakthres:on	Turns On peak threshold and sets amplitude. Parameter: peak threshold in dB. Example: meas:mark:peakthres:on_-30 (-30dB threshold)
meas:mark:peakthres:off	Turns Off peak threshold.

Trace

meas:tra	Sets the mode for a trace. Parameter: 1 (traceA), 2 (traceB), 3 (traceC), followed by 1 (clear), 2 (peak hold), 3 (view), 4 (blank) Example: meas:tra_1_2 (traceA set to peak hold mode)
meas:tra:avg:on	Turns On average mode and sets average number for a trace. Parameter: 1 (traceA), 2 (traceB), 3 (traceC), followed by No. Example: meas:tra:avg:on_1_20 (Average trace A 20 times)
meas:tra:avg:off	Turns Off the average mode. Parameter: 1 (traceA), 2 (traceB), 3 (traceC) Example: meas:tra:avg:off_1 (traceA average mode Off)

meas:tra:read?	Returns trace data. Parameter:1 (traceA), 2(traceB), 3(traceC), all(all three traces) Example: meas:read_1? (traceA data)
meas:tra:a<>b	Swaps trace A and B.
meas:tra:a+b>a	Adds trace B to A.
meas:tra:a-b>a	Subtracts trace B from A.
meas:tra:const?	Returns the constant value to be added or subtracted.
meas:tra:const	Sets the constant value to be added or subtracted.
meas:tra:a+const>a	Adds a constant value to traceA.
meas:tra:a-const>a	Subtracts a constant value from traceA.
meas:tra:det?	Returns the detection mode. Parameter: 1 (normal), 2(sample), 3(peak+), 4(avg), 5(qpeak)
meas:tra:det	Sets the detection mode. Parameter: 1 (normal), 2(sample), 3(peak+), 4(avg), 5(qpeak) Example: meas:tra:det_4 (set the detection mode to average)

Power measurement

meas:ch:bw?	Returns the main channel bandwidth. Example: 1000 khz
meas:ch:bw	Sets the main channel bandwidth. Need to specify the unit. Example: meas:ch:bw_1_mhz (1MHz)
meas:adjch:bw?	Returns the adjacent channel bandwidth in kHz. Need to specify the channel. Example: meas:adjch:bw_2? (adjacent channel2 bandwidth)
meas:adjch:bw	Sets the adjacent channel bandwidth. Need to specify CH and unit. Example: meas:adjch:bw_2_1_mhz(adj CH2 BW 1MHz)
meas:adjch:offs?	Returns the adjacent channel offset in kHz. Specify channel. Example: meas:adjch:offs_2? (adjacent channel2 offset)
meas:adjch:offs	Sets the adjacent channel offset. Specify channel and unit. Example: meas:adjch:offs_2_1_mhz (adjacent ch2 offs 1MHz)
meas:acpr?	Returns ACPR activation status. Parameter: on, off
meas:acpr	Turns On/Off ACPR measurement. Parameter: on, off Example: meas:acpr_on (ACPR On)
meas:acpr:lower?	Returns the lower ACPR result. Need to specify 1 or 2. Example: meas:acpr:lower_2? (lower ACPR 2 result?)
meas:acpr:upper?	Returns the upper ACPR result. Need to specify 1 or 2. Example: meas:acpr:upper_2? (upper ACPR 2 result?)
meas:acpr:chup	Moves the ACPR channel up.
meas:acpr:chdown	Moves the ACPR channel down.
meas:chspc?	Returns the channel space in kHz.
meas:chspc	Sets the channel space. Need to specify the unit. Example: meas:chspc_10_mhz (10MHz)

meas:ocbw?	Returns the OCBW activation/deactivation status. Parameter: on, off
meas:ocbw	Turns On/Off OCBW. Parameter: on, off Example: meas:ocbw_on
meas:ocbw:bw?	Returns the power measurement channel space in kHz.
meas:ocbw:per?	Returns OCBW percentage.
meas:ocbw:per	Sets OCBW percentage. Example: meas:ocbw:per_90 (90%)
meas:ndb?	Returns N dB activation status. Parameter: on, off
meas:ndb	Turns on/off N dB. Parameter: on, off Example: meas:ndb_on
meas:nbw:ndb?	Returns N dB bandwidth. Example: 1000 khz
meas:nbw:ndb	Sets N dB. Example: meas:ndb:ndb_3 (3 dB)
meas:jitter?	Returns Phase Jitter on/off status. Parameter: on, off
meas:jitter	Turns On/Off Phase Jitter. Parameter: on, off Example: meas:jitter_on
meas:jitter:stoffs?	Returns Phase Jitter start offset. Example: 0 khz
meas:jitter:stoffs	Sets Phase Jitter start offset. Need to specify the unit. Example: meas:jitter:stoffs_0_khz
meas:jitter:stpoffs?	Returns Phase Jitter stop offset. Example: 50 khz
meas:jitter:stpoffs	Sets Phase Jitter stop offset. Need to specify the unit. Example: meas:jitter:stpoffs_50_khz
meas:jitter:phase?	Returns Phase Jitter phase in radian. Example: 1.234 rad
meas:jitter:time?	Returns Phase Jitter time in pico second. Example: 1.234psec

Limit line

meas:lmntline:on	Turns On limit line. Parameter: 0 (low limit line), 1 (high limit line) Example: meas:lmntline:on_0 (low limit line On)
meas:lmntline:off	Turns Off limit line. Parameter: 0 (low limit line), 1 (high limit line) Example: meas:lmntline:off_0 (low limit line Off)
meas:lmntline:passfail?	Returns Pass/Fail test result. Parameter: on, off
meas:lmntline:passfail	Turns On/Off Pass/Fail test. Parameter: on, off Example: meas:lmntline:passfail_on (Pass/Fail test On)
meas:lmntline:passfail:critereion?	Returns Pass/Fail test criteria. Parameter: 1 (pass if all signals are in the zone), 2 (pass if the peaks are in the zone), 3 (pass if valleys are in the zone)
meas:lmntline:passfail:critereion	Sets Pass/Fail test criteria. Parameter: 1 (pass if all signals are in the zone), 2 (pass if the peaks are in the zone), 3 (pass if valleys are in the zone) Example: meas:lmntline:passfail:critereion_3
meas:lmntline:table?	Returns limit line table On/Off. Parameter: on, off
meas:lmntline:table	Turns On/Off limit line table. Parameter: on, off Example: meas:lmntline:table_on (limit line table On)

meas:limitline?	Returns the limit line table data. Need to specify 0 (low limit line), 1 (high limit line) / limit line points. Example: meas:limitline:edit_0? Returns: 3,100,0,110,3,120,2 (low limit line, 3 points, 100MHz/0dB, 110MHz/3dB, 120MHz/2dB)
meas:limitline:edit	Sets the limit line table data. Need to specify 0 (low limit line), 1 (high limit line) / limit line points. Example: meas:limitline:edit_0_CR_3,100,-2,110,-3,120,-2 (low limit line, 3 points, 100MHz/-2dB, 110MHz/-3dB, 120MHz/-2dB)
meas:limitline:edit:delall	Delete all points in limit line table. Parameter: 0 (low limit line), 1 (high limit line) Example: meas:limitline:edit:delall_0 (delete low limit line table)

BW

con:rbw:auto	Sets RBW to auto.
con:rbw?	Returns the RBW (resolution bandwidth). Parameter: 0 (200Hz), 1 (300Hz), 2 (3kHz), 3 (9kHz), 4 (30kHz), 5 (120kHz), 6 (300kHz), 7 (4MHz)
con:rbw:man	Selects the RBW. Parameter: 0 (200Hz), 1 (300Hz), 2 (3kHz), 3 (9kHz), 4 (30kHz), 5 (120kHz), 6 (300kHz), 7 (4MHz) Example: con:rbw:man_1 (sets RBW to 300Hz)
con:rbw:mode?	Returns RBW mode. Parameter: auto, manual
con:vbw:auto	Sets VBW to auto.
con:vbw?	Returns the VBW. Parameter: 0 (10Hz), 1 (30Hz), 2 (100kHz), 3 (300kHz), 4 (1kHz), 5 (3kHz), 6 (10kHz), 7 (30kHz), 8 (100kHz), 9 (300kHz), 10 (1MHz)
con:vbw:man	Selects the VBW. Parameter: 0 (10Hz), 1 (30Hz), 2 (100Hz), 3 (300Hz), 4 (1kHz), 5 (3kHz), 6 (10kHz), 7 (30kHz), 8 (100kHz), 9 (300kHz), 10 (1MHz) Example: con:vbw:man_4 (sets VBW to 1kHz)
con:vbw:mode?	Returns VBW mode. Parameter: auto, manual
con:swt:auto	Sets the sweep time to auto.
con:swt:man	Sets the sweep time in msec. Example: con:swp:man_5 (sets the sweep time to 5ms)
con:swt?	Returns the sweep time in msec.
con:swt:mode?	Returns the sweep time mode. Parameter: auto, manual
con:allcouple	Sets the RBW, VBW, and sweep time to auto.

Trigger

con:trig:freerun	Sets the trigger to free run mode.
con:trig:video	Sets the trigger to video and sets the trigger level in current unit. Example: con:trig:video_-20 (video mode, -20dBm)

con:trig:single	Sets the trigger condition to single.
con:trig:cont	Sets the trigger condition to continuous.
con:trig:ext	Sets the trigger to external mode.
con:trig:delay	Sets the trigger delay in msec. Example: con:trig:delay_1000 (1000ms delay)
con:trig:freq	Sets the trigger frequency in MHz. Example: con:trig:freq_1 (1MHz)

Display

con:disp:dim	Selects the display dimmer level. Parameter: 0 to 5 Example: con:disp:dim_2 (dimmer level 2)
con:disp:dl	Turns On/Off display line. Parameter: on, off Example: con:disp:dl_on (display line On)
con:disp:dl:level	Sets the display line level in current unit. Example: con:disp:dl:level_-50 (display line at -50dBm)
con:disp:title:show	Sets and shows the display title. The title is case sensitive. Example: con:disp:title:show_SAtest (title is SAtest)
con:disp:title:clr	Clears the display title.
con:disp:split:upper	Turns On and sweeps upper window in split window mode.
con:disp:split:lower	Turns On and sweeps lower window in split window mode.
con:disp:split:alt	Sweeps the upper/lower window alternatively in split mode.
con:disp:split:full	Goes back to full screen mode.

File

con:file:copy	Copies file. Need to specify the source and destination file. Parameter: ta/tb/tc (traceA/B/C), t1to10 (trace1to10), lh/l (high/low limit line), lh1to5 (high limit line 1to5), ll1to5 (low limit line 1to5), c1to5 (correction set 1to5), q1to10 (sequence 1to10), s1to10 (setup 1to10), file name in USB flash drive Example: con:file:copy_t10_ta (copy from trace10 to traceA) Example: con:file:copy_ta_mytrace (copy from traceA to a file in external USB flash named mytrace)
con:file:del	Deletes file. Need to specify the source and destination file. Parameter: ta/tb/tc (traceA/B/C), t1to10 (trace1to10), lh/l (high/low limit line), lh1to5 (high limit line 1to5), ll1to5 (low limit line 1to5), c1to5 (correction set 1to5), q1to10 (sequence 1to10), s1to10 (setup file 1to10), file name in external USB flash drive. Example: con:file:del_t10 (delete trace10) Example: con:file:del_myspace (delete a file names myspace in external USB flash drive)
con:file:prtsc:tofile	Saves the display image to external USB flash drive. Need to specify the file name. Example: con:file:prtsc:tofile_myscreen (saves the display image to a file named myscreen)

Preset

con:preset Presets the GSP-830.

System

con:sys:setup:save Save the current system setting. Parameter: 1to10
Example: con:sys:setup:save_1 (save current setup to setup1)

con:sys:setup:recall Recalls a system setting from setup file. Parameter: 1to10
Example: con:sys:setup:recall_1 (recall setting in setup1 file)

con:sys:gpibaddr? Returns the current GPIB address.

con:sys:gpibaddr Sets the GPIB address. Example: con:sys:gpib:addr_2

con:sys:auxsig Turns On/Off the auxiliary signal. Parameter: on, off
Example: con:sys:auxsig_on (auxiliary signal On)

con:sys:clock:date? Returns the current date setting.
Parameter: year/month/ day/ day of week 1 (Mon) to 7(Sun)
Example: 2006 6 24 6 (June 24th, Saturday, 2006)

con:sys:clock:date Sets the date.
Parameter: year/month/day/ day of week 1 (Mon) to 7(Sun)
Example: con:sys:clock:date_2006_6_24_6 (Jun24, Sat, 2006)

con:sys:clock:time? Returns the current time setting.
Parameter: hour / minute / second
Example: 13 30 26 (1p.m., 30 minutes, 26 second)

con:sys:clock:time Sets the time. Parameter: hour / minute / second
Example: con:sys:clock:time_13_30_26 (1p.m., 30min, 26sec)

con:sys:clock:show Turns On/Off clock display. Parameter: on, off
Example: con:sys:clock:show_on (clock display On)

con:sys:selftest? Returns the self test result. Parameter: 0 (fail), 1 (pass) in the following order: GPIB/Flash/SDRAM/RTC
Example: 1 1 0 1 (GPIBpass,Flashpass,SDRAMfail,RTCpass)

con:sys:lang Selects language. Parameter: 1 (English), 2 (Simplified Chinese) Example: con:sys:lang_2 (simplified Chinese)

con:sys:ser? Returns the serial number. Example: EE8300000

con:sys:swver? Returns the software version.
Example: v1.0 06/07/28 (version 1.0, 2006 July 28th)

con:sys:fwver? Returns the firmware version. Example: v1.0 (version 1.0)

con:sys:hwver? Returns hardware version in following order. RF, IF, DSP, MB
Example: v1.0 v1.0 v1.01 v1.0 (RF: version 1.0, IF: version 1.0, DSP: version 1.01, MB: version 1.0)

con:sys:optstatus? Returns optional items installation status in the following order. 300HzRBW, EMIFilter, 10k/100kHzRBW, TG, Demodulator, Medref (± 1 ppm stability) Parameter: 0 (not installed), 1 (installed)
Example: 0 0 1 1 1 (TG, Demodulator, Medref are installed)

Option

con:opt:tg	Turns On/Off Tracking Generator (TG). Parameter: on, off Example: con:opt:tg_on (TG On)
con:opt:tg:level?	Returns the TG level.
con:opt:tg:level	Sets the TG level.
con:opt:tg:norm	Turns On/Off TG normalization. Parameter: on, off Example: con:opt:tg:norm_on (normalization On)
con:opt:tg:offset	Sets the TG offset level.
con:opt:tg:refval?	Returns the TG reference value.
con:opt:tg:refval	Sets the TG reference value.
con:opt:dm:fm	Turns On/Off FM in the demodulator. Parameter: on, off Example: con:opt:dm:fm_on (FM On)
con:opt:dm:am	Turns On/Off AM in the demodulator. Parameter: on, off Example: con:opt:dm:am_on (AM On)
con:opt:dm:spk	Turns On/Off phone output in the demodulator. Parameter: on, off Example: con:opt:dm:spk_on (phone On)
con:opt:dm:vol	Sets the demodulator phone output volume.
con:opt:dm:sql?	Returns the demodulator squelch level.
con:opt:dm:sql	Sets the demodulator squelch level.
con:opt:bat?	Returns the battery level.
con:opt:extreffreq?	Returns the external reference frequency.
con:opt:extreffreq	Sets the external reference frequency.

Sequence

con:seq:runmode	Selects the sequence run mode. Parameter: 1 (repeat mode), 2 (single mode) Example: con:seq:runmode_2 (sequence runs in sing mode)
con:seq:runseq	Runs the sequence. Parameter: sequence index, 1 to 10 Example: con:seq:runseq_2 (run sequence 2)
con:seq:stopseq	Stops the running sequence.
con:seq:delallseq	Deletes all programmed sequence.
con:seq:delseq	Deletes a sequence. Parameter: sequence index, 1 to 10 Example: con:seq:delseq_2 (delete sequence 2)

F FAQ

I pressed the power (ON/STBY) key on the front panel but nothing happens.

Make sure you turned on the rear panel power switch. For details, see page20. Note that after proper sequence, it takes around 10 seconds for the display to become active.

I cannot even see the default green line on the display.

Check if the TraceBlank (hide trace from the display) is on for TraceA, the default waveform. Press the Trace key → F1 (select TraceA) → F2 (Clear) to recover the trace. For details, see page74.

I connected the signal but it does not appear on screen.

Run the Autoset and let the GSP-830 find the best display scale for your target signal. Press the Autoset key, then press F1 (Autoset). For details, see page58.

I want to see which optional items are installed.

Check the optional item status in the system information window. Press the System key → F6 (More) → F4 (System Config On). For details, see page129.

The Pre-amplifier (GAP-801 or GAP-802, page56) is a completely external item, therefore does not appear in the system information menu.

The GSP-830 performance does not match the specification.

Make sure the device is powered on for at least 30 minutes, within +18°C to +28°C. This is necessary to stabilize the unit to match the specification.

If there is still a problem, please contact your local dealer or GWInstek at marketing@goodwill.com.tw.

Appendix

GSP-830 Specifications

The following specifications apply when the GSP-830 is powered on for at least 30 minutes within +18°C to +28°C.

Frequency	Frequency Range	9kHz to 3.0GHz	
	Aging Rate	± 10ppm, 0-50°C, 5ppm/yr	
	Span Range	2kHz to 3.0GHz in 1/2/5 sequence, full span, zero span	
	Phase Noise	-80dBc/Hz @ 1GHz 20kHz Offset typical	
Resolution Bandwidth	Sweep Time Range	50ms to 25.6s	
	RBW Range	3kHz, 30kHz, 300kHz, 4MHz	
	RBW Accuracy	15%	
Amplitude	VBW Range	10Hz to 1MHz in 1-3 steps	
	Measurement Range (Span: 50kHz, RBW: 3kHz)	-103dBm to +20dBm: 1 MHz to 15MHz, Ref Lvl @ -30dBm -117dBm to +20dBm: 15MHz to 1GHz, Ref Lvl ≥ -110dBm -114dBm to +20dBm: 1GHz to 3GHz, Ref Lvl ≥ -110dBm	
	Overload Protection	Max. +30dBm, 25VDC	
	Reference Level Range	-110dBm to +20dBm	
	Accuracy	±1dB @100MHz	
	Frequency Flatness	±1dB	
	Display Range	±1dB over 70dB	
	Linearity		
	Dynamic Range	Average Noise Floor	< -135±1dBm/Hz: 1MHz to 15MHz, Ref Lvl @ -30dBm < -149dBm/Hz, typical -152dBm/Hz: 15MHz to 1GHz, Ref Lvl ≥ -110dBm < -146dBm/Hz, typical -149dBm/Hz: 1GHz to 3GHz, Ref Lvl ≥ -110dBm
		Third Intermodulation	<-70dBc, RF Input @-40dBm, Ref Level @ -30dBm
Harmonic Distortion		<-60dBc, RF Input < -40dBm, Ref Level @ -30dBm	
Non-Harmonic Spurious (Span: 50kHz, RBW: 3kHz)		< -93dBm: 1MHz to 15MHz, RefLvl ≥ -30dBm < -107dBm: 15MHz to 1GHz, RefLvl ≥ -110dBm < -104dBm: 1GHz to 3GHz, RefLvl ≥ -110dBm	

General	Display	640 x 480 high-res color TFT LCD
	Split Windows	Active Window: Upper, Lower, or Alternate (two simultaneously sweeping windows)
	Markers	10 markers for peaks: 5 normal-delta marker pairs. Function: Delta, To Peak, To Minimum, Peak Track, Peak Table, Peak Sort
	Trace Detection	3 traces with Peak, Maximum hold, Freeze, Average, and Trace Math
	Power Measurement	ACPR, OCBW, Channel power, N dB, and Phase Jitter
	Autoset Function	Auto tuning the measurement result for observation
	Trigger	Conditions: Video, External (Positive-going +5V-TTL ext. signal) Modes: Normal, Single, Continuous
	Sequence	Automated test by user defined macros without any remote controller. 10 sequential macro sets and 10 macros per each set. Variable Delays and Wait-to-Go facilitate automated measurement. Do-Sequence links and nests different sequence sets.
Connectors	RF Input	Type: N Female, 50Ω nominal RF input VSWR: <2:1, @0dBm Ref Lvl
	External Reference Clock Input (MHz)	Type: BNC Female, 1M, 1.544M, 2.048M, 5M, 10M, 10.24M, 13M, 15.36M, 15.4M, 19.2M
	Ref. Clock Output	Type: BNC Female, 10MHz
	DC Input (DC Power Operation)	Jack: 5.5mm, 12V
	DC Output (for pre-amplifier)	Type: SMA Male, output +9V/100mA max.
Interface	RS-232C	Sub-D 9pins Female
	USB Connector	USB Host/Device fully supported Front Panel: Type A receptacle for USB flash drives. Rear Panel: Type mini-B receptacle for PC remote control.
	VGA Output	Sub-D 15pins Female
	GPIB (option)	Fully programmable with IEEE488.2 compliance
Accessories	User Manual x1, Power Cord x1, USB Cable (Type A plug to Type mini-B plug) x 1	
Power Source	AC 100V to 240V, 50/60Hz	
Dimensions & Weight	330 (W) × 170(H) × 340(D) mm, Approx. 6kg	
Operation Environment	Temperature: 18°C to 28°C Relative Humidity: < 90%	
Storage Environment	Temperature: 0°C to 40°C Relative Humidity: < 85%	

Optional Items Specifications

Opt.01 Tracking Generator	Frequency Range	9kHz to 3.0GHz
	Amplitude Range	-50dBm to 0 dBm
	Amplitude Accuracy	± 1 dB @100MHz, 0dBm
	Amplitude Flatness	± 1 dB @0dBm
	Harmonics	<-30dBc typical
	Reverse Power	+30dBm
	Impedance	Type: N female, 50 Ω nominal
	RF Output VSWR	< 2:1
Opt.02 Battery Pack	Battery Type	11.1V Li-Ion battery pack x 2
Opt. 03 ± 1 ppm Stability	Output Range	± 1 ppm, 0to50 $^{\circ}$ C
	Aging Rate	± 1 ppm / year
Opt. 04 300Hz RBW	RBW Selection	300Hz
	RBW Accuracy	20%
Opt. 05 9kHz&120kHz RBW(= EMI Filter)	RBW Selections	9kHz and 120kHz, 6dB bandwidth
	RBW Accuracy	15%
Opt. 06 10kHz & 100kHz RBW	RBW Selections	10kHz and 100kHz, 3dB bandwidth
	RBW Accuracy	15%
Opt. 07 Demodulator	Demodulation	AM, FM
	Output	3.5mm stereo jack wired for mono operation
	RBW Selections	10kHz and 100kHz, 3dB bandwidth
	RBW Accuracy	15%
Opt. 08 GPIB Interface	Compliant standard	IEEE 488 bus
ADP-001	BNC(J/F)to N(P/M) adaptor	
ADP-002	SMA(J/F)to N(P/M) adaptor	
ADP-101	BNC(J/F)75 Ω to BNC(P/M)50 Ω adaptor	
ATA-001	BNC antenna	
ATN-100	10dB attenuator N(J/F) to N(P/M)	
GAK-001	Termination 50 Ω N(P/M)	
GAK-002	Cap with chain N(P/M)	
GAP-801	10dB Preamplifier: 9kHz to 6GHz, 10dB typical	
GAP-802	20dB Preamplifier: 9kHz to 3GHz, 20dB typical	
GKT-001 General Kit Set	ADP-002	SMA (J/F) to N (P/M) adaptor x 2
	ATN-001	10dB Attenuator, N (J) to N(P) x 1

	GTL-303	RF Cable (RD316, SMA(P), 60cm) x 2
	GSC-002	Kit box x 1
GKT-002 CATV Kit set	ADP-001	BNC (J/F) to N (P/M) adaptor x 2
	ADP-101	BNC (P/M) 50Ω to BNC (J/F) 75Ω adaptor x2
	GTL-304	RF Cable (RG223, N(P)-N(J), 30cm) x 2
	GSC-003	Kit box x 1
GKT-003 RLB Kit set	GAK-001	Termination, 50Ω, N(P) x 1
	GAK-002	Cap with chain, N(P) x 1
	GTL-302	RF Cable assembly (RG223+N(P), 30cm) x 2
	GSC-004	Kit box x 1
GKT-006 EMI Probe set	ADP-01	BNC (J/F) to N (P/M) adaptor x 1
	ADP-02	SMA (J/F) to N (P/M) adaptor x 1
	ANT-01	6cm loop, H-Field probe x 1
	ANT-02	3cm loop, H-Field probe x 1
	ANT-03	6mm loop, H-Field probe x 1
	PR-03	Touch passive probe, < 3GHz x 1
	Test Lead	RF Cable BNC (P/M) to BNC (P/M) x 1
	Test Lead	RF Cable SMA (P/M) to SMA (P/M) x 1
GRA-404	19 inch Rack adaptor panel, 4U	
GTL-301	RF Cable assembly RG223, N(P/M) 100cm	
GTL-302	RF Cable assembly RG223, N(P/M) 30cm	
GTL-303	RF Cable assembly RD316, SMA(P/J) 60cm	
GTL-304	RF Cable assembly RG223, N(P/M) to N(J/F) 30cm	
GTL-401	DC power cord with DC Jack and lighter plug, 5A	
GSC-001	Soft Carrying Case: available to accommodate the field operations	
RLB-001 Return Loss Bridge	Frequency range	10MHz to 1GHz
	Directivity	10MHz to 100MHz: > 48dB 100MHz to 1000MHz: > 38dB
	Insertion loss	Source to Load: < 10dB Load to Coupler: < 7dB
	Return loss	Source return loss: > 7dB Load return loss: > 11dB Coupler return loss: > 17dB
	Impedance	50Ω (Characteristic Impedance)
	Connector	N type, Source/load: female, Coupler: male
	Dimension & weight	88 x 54 x 32 (mm), 230g

Note: Among Opt. 05 to 07, only one item can be installed to the GSP-830.

The following are factory installed items. Opt. 01, 03, 04, 05, 06, 07

Declaration of Conformity

We

GOOD WILL INSTRUMENT CO., LTD.

(1) No.7-1, Jhongsing Rd., Tucheng City, Taipei County, Taiwan

(2) No. 69, Lu San Road, Suzhou City (Xin Qu), Jiangsu Sheng, China

declare, that the below mentioned product

Type of Product: Digital Spectrum Analyzer

Model Number: GSP-830

are herewith confirmed to comply with the requirements set out in the Council Directive on the Approximation of the Law of Member States relating to Electromagnetic Compatibility (89/336/EEC, 92/31/EEC, 93/68/EEC) and Low Voltage Directive (73/23/EEC, 93/68/EEC).

For the evaluation regarding the Electromagnetic Compatibility and Low Voltage Directive, the following standards were applied:

◎ **EMC**

EN 61326-1: Electrical equipment for measurement, control and laboratory use — EMC requirements (1997 + A1:1998 + A2:2001 + A3:2003)	
Conducted Emission Radiated Emission EN 55011: Class A 1998 + A1:1999 + A2:2002	Electrostatic Discharge EN 61000-4-2: 1995 + A1:1998 + A2:2001
Current Harmonics EN 61000-3-2: 2000 + A2:2005	Radiated Immunity EN 61000-4-3: 2002 + A1:2002
Voltage Fluctuations EN 61000-3-3: 1995 + A1:2001	Electrical Fast Transients EN 61000-4-4: 2004
-----	Surge Immunity EN 61000-4-5: 1995 + A1:2001
-----	Conducted Susceptibility EN 61000-4-6: 1996 + A1:2001
-----	Power Frequency Magnetic Field EN 61000-4-8: 1993 + A1:2001
-----	Voltage Dip/ Interruption EN 61000-4-11: 2004

◎ **Safety**

Low Voltage Equipment Directive 73/23/EEC
Safety Requirements IEC/EN 61010-1: 2001

INDEX

1	
1ppm stability	
error message.....	22
specifications.....	175
5	
50ohm/75ohm	57
A	
accessories list.....	11
ACPR	83
adjacent channel.....	83
activate	
ACPR.....	83
all marker at once.....	64
amplitude correction	54
autoset.....	60
delta marker	64
demodulator.....	144
limit line.....	91
N dB.....	88
OCBW.....	86
phase jitter.....	89
phone output.....	144
TG.....	142
trace.....	74
AM demodulator	144
amplitude	48
command set.....	162
copy correction file.....	115
delete correction file	119
menu tree	31, 32
operation shortcut	26
peak sort.....	72
preset contents.....	123
specifications.....	173
amplitude correction.....	52
file type.....	114
amplitude floor.....	61
autoset	58
amplitude floor.....	61
command set.....	162
how autoset works.....	59
in functionality check	24
menu tree	31
operation shortcut	26
preset contents.....	123
auxiliary signal.....	23, 135
average	
signal detection	81
trace	75
waveform	101
B	
bandwidth	95
command set.....	167
menu tree.....	35
operation shortcut.....	28
preset contents	123
specifications	173
battery.....	148
life	149
safety instruction	7
specifications	175
C	
cable TV	57
kit set.....	176
calibration	
error message	22, 128
input impedance.....	57
caution symbol.....	6
center and span	42
center frequency	42
move marker to	66
move peak to.....	70
channel bandwidth	
ACPR	83
OCBW	86
channel space	
ACPR	83
OCBW	86
cleaning the GSP-830.....	7
clear trace	74
COM port selection.....	153
command syntax.....	160
continuous trigger mode	105
cooling fan caution	7
copy file	115
D	
date setting	132
dB unit selection.....	50

DC input 148
 specifications 174
 DC operation 149
 DC output 56
 specifications 174
 delay in sequence set 138
 delete
 amplitude correction 55
 limit line 93
 sequence 139
 delete file 118
 delta marker 64
 demodulator 144
 specifications 175
 destination files, copy 116
 detection mode 80
 display 107
 clock activation 132
 command set 168
 FAQ 172
 menu tree 35
 operation shortcut 29
 preset contents 123
 save image 111
 split 110
 title 109
 VGA output 111
 display line 108

E

edit file name
 when copy file 117
 when rename 120
 when save image 122
 EMI filter 146
 bandwidth configuration 100
 specifications 175
 EMI probe set 176
 EN 55011 declaration of conformity ... 177
 EN 61010
 declaration of conformity 177
 measurement category 7
 pollution degree 8
 environment
 safety instruction 7
 specifications 174
 error
 message list 22
 message on power up 21
 self test result 22
 external offset 51
 external reference signal 134
 external trigger 105

F

feature list 10
 file 113

command set 168
 copy 115
 delete 118
 display image 121
 menu tree 36, 37
 operation shortcut 29
 preset contents 123
 rename 120
 type 114
 USB icon 114
 Flash memory self test 22
 FM demodulator 144
 free run 104
 freeze trace 75
 frequency 41
 command set 161
 menu tree 31
 operation shortcut 26
 peak sort 72
 preset contents 123
 specifications 173
 frequency adjustment point 16
 frequency step 42
 full span 46
 functionality check 23
 PC software 153
 fuse instruction 7

G

GAP-801/802 56
 specifications 175
 general kit set 175
 GPIB
 configuration 127
 constraints 128
 functionality check 159
 self test 22, 127
 specifications 174
 ground symbol 6

H

hardware version 129
 hide trace 75
 high limit line 91
 high voltage symbol 6

I

icon
 75ohm impedance 57
 amplitude correction 52
 battery level 149
 external offset 51
 external reference 134
 internal reference median 134
 peak track 65, 69
 RBW manual 96

sequence running	141	marker table	67
sweep time	101	minimum peak.....	71
TG normalized	143	month setting.....	132
trace average.....	76, 102		
trace clear mode.....	74	N	
trace math.....	78	N dB	88
trace peak hold	75	normal detection mode.....	80
trace view	75	normal marker.....	63
trigger external.....	105	normal trigger mode.....	105
trigger video.....	104	numerical keys example	15
USB	114		
VBW manual.....	98	O	
icon overview	19	OCBW	86
IEEE488.2	157	offset	
standard commands	161	amplitude.....	51
impedance offset	57	phase jitter	89
impedance selection.....	57	operation environment.....	7
initial display	21	option	
menu tree	25, 31	command set.....	170
shortcut	25, 26	menu tree.....	39
interface configuration	126	operation shortcut.....	30
		preset contents	123
L		optional item	
language		10/100kHz RBW	96
selection.....	135	300Hz RBW	96
version	129	9k/120kHz RBW	96
last span setting.....	47	battery	148
last stored settings.....	21	demodulator	144
LCD dimmer.....	108	EMI filter.....	96, 146
limit line	90	FAQ.....	172
command set.....	166	installed items.....	129
copy file	115	list of options	11
delete file.....	119	pre-amplifier.....	56
file type.....	114	specifications	175
menu tree	34	TG	142
operation shortcut	28	overview	
preset contents.....	123	display.....	18
local oscillator error message.....	22	display icon.....	19
low limit line	91	features	10
		front panel	13
M		menu tree.....	31
marker	62	operation shortcuts	26
activate all at once.....	64	preset	40
command set.....	163	rear panel	16
marker table	67		
marker to center	66	P	
marker to peak.....	65	package contents	11
menu tree	32	panel settings	
operation shortcut	26	copy file	115
PC software.....	155	delete file	119
peak track	69	file type	115
preset contents.....	123	save/recall.....	125
specifications.....	174	pass/fail test.....	94
to center frequency	66	pause sequence	138
to reference level.....	66	PC requirement for software	151
to start/stop frequency	66	PC software.....	150
to trace.....	67, 76		

- installation 151
- peak hold trace 74
- peak search 68
 - command set 163
 - menu tree 33
 - minimum peak 71
 - next peak 70
 - operation shortcut 27
 - peak table 71
 - preset contents 123
- peak signal
 - in autoset 59
 - search 69
- peak table 71
- peak threshold 72
- percentage, OCPW 86
- phase jitter 89
- phone output 144
- positive peak detection 80
- power measurement 82
 - ACPR 83
 - command set 165
 - menu tree 34
 - N dB 88
 - OCBW 86
 - operation shortcut 27
 - phase jitter 89
 - preset contents 123
- power supply safety instruction 7
- power up sequence 20
 - FAQ 172
- pre-amplifier 56
 - specifications 175
- preset 123
 - command set 169
 - contents 40
- printout display image 155
- protective conductor symbol 6

Q

- quasi-peak detection 81

R

- RBW 96
 - 9k/120kHz RBW 146
 - error message 22
- RBW configuration 100
- real-time clock self test 23
- recall
 - amplitude correction 55
 - panel settings 125
- reference level 49
 - move marker to 66
- reference signal
 - error message 22
 - master 133
 - settings 129

- slave 134
 - specifications 174
- remote control 157
 - PC software 150
- return loss bridge 176
 - accessory kit set 176
- RS-232C
 - configurations 126
 - specifications 174
- RTC test result 131

S

- sample detection mode 80
- save
 - panel settings 125
 - waveform from PC software 155
- SCPI 157
- SDRAM self test 23
- self test result 22
- sequence 136
 - command set 170
 - copy file 115
 - delete file 119
 - edit 137
 - file type 114
 - menu tree 39
 - operation shortcut 30
 - preset contents 123
 - run 140
 - specifications 174
- serial number 129
- service operation
 - contact 172
 - menu 135
- signal detection 80
 - in EMI filter 146
- single trigger mode 105
- soft carrying case 176
- source files, copy 115
- span 41, 43
 - command set 161
 - menu tree 31
 - operation shortcut 26
 - preset contents 123
 - specifications 173
- specifications
 - FAQ 172
 - GSP-830 173
 - optional item 175
- split display 110
- squelch, demodulator setting 145
- start and stop 44
 - move marker to 66
- start frequency 44
- stop frequency 45
- storage environment 7
- sweep time 101

synchronization		menu tree.....	35
master	133	normal trigger	105
slave.....	134	operation shortcut.....	28
system	124	preset contents	123
command set	169	single trigger	105
error message.....	128	specifications	174
menu tree	38	video.....	104
operation shortcut	29		
preset contents.....	123	U	
system configuration	129	UK power cord requirement	8
		USB	
T		file copy	115
table of contents	3	file delete	118
TG	142	file rename.....	120
level	142	icon.....	114
normalization.....	143	save display image	111, 121
reversed power level caution	6	slave configuration.....	126, 152, 158
specifications.....	175	specifications	174
tilt stand	20		
time domain view.....	46	V	
time setting	132	VBW	98
title, display.....	109	error message	22
trace	73	VBW configuration	100
average	75	version information	129
clear	74	vertical unit	50
command set	164	VGA output	111
copy file	115	specifications	174
delete file.....	119	video trigger.....	104
FAQ.....	172		
file type.....	114	W	
freeze	75	warning symbol	6
menu tree	33	website, Good Will Instruments.....	151
move marker to.....	67, 76		
operation shortcut	27	Y	
preset contents.....	123	year setting	132
specifications.....	174		
trace math	78	Z	
trigger	103	zero span	46
command set	167		
continuous trigger	105		
delay	106		
external	105		