



Programmable Power Supply

PSH series

USER MANUAL

GW INSTEK PART NO. XXXX-XXXXXX

This manual contains proprietary information, which is protected by copyrights. All rights are reserved. No part of this manual may be photocopied, reproduced or translated to another language without prior written consent of Good Will company.

The information in this manual was correct at the time of printing. However, Good Will continues to improve products and reserves the rights to change specification, equipment, and maintenance procedures at any time without notice.

Good Will Instrument Co., Ltd.

No. 7-1, Jhongsing Rd., Tucheng City, Taipei County 236, Taiwan.



ISO-9001 CERTIFIED MANUFACTURER

GW INSTEK

Table of Contents

Safety Instructions	5
Safety Symbols	6
Safety Guidelines.....	6
Power cord for the United Kingdom	9
PSH Overview	11
Main Features	12
PSH Series Lineup.....	13
Package Contents	14
Front Panel	16
Rear Panel	18
Display.....	19
Setup	21
AC Power Cable Assembly	22
Remote Sensing and Local Sensing	24
Load / Remote Sensing Wire Selection.....	25
Load Configuration.....	26
Load Wire Assembly	30
Remote Sensing Wire Assembly	32
Functionality Check.....	34
Rack Mounting (Optional)	40
Panel Operation	43
Menu Key Overview	44
Constant Voltage/ Constant Current Crossover Characteristic	45
Output Voltage Setting	46
Output Current Setting	47
OVP (Output Voltage Protection) Setting	48
OCP (Output Current Protection) Setting	49
Display Contrast Setting	50

Buzzer sound Setting	51
Remote Operation	52
Interface Selection.....	53
Command Syntax	57
Command Set	58
Calibration	61
Calibration Preparation	62
Entering calibration mode	63
Output Voltage calibration	64
Output Current calibration	66
OVP Calibration	68
FAQ.....	69
Appendix.....	71
Specifications.....	71
Declaration of Conformity	75
Index	76







Safety Instructions

This chapter contains important safety instructions that must be followed when operating PSH and when keeping it in storage. Read the following before any operation to insure safety and to keep the best condition for PSH.

Safety Symbols	Safety Symbols	6
Safety Guidelines	Safety Guidelines.....	6
	Power Supply	7
	Fuse	7
	Cleaning PSH	7
	Operation Environment.....	8
	Storage Environment	8
Power cord	Power cord for the United Kingdom	9

Safety Symbols

These safety symbols may appear in this manual or on PSH.

	WARNING	Warning: Identifies conditions or practices that could result in injury or loss of life.
	CAUTION	Caution: Identifies conditions or practices that could result in damage to PSH or to other properties.
		DANGER High Voltage
		Attention Refer to Manual
		Protective Conductor Terminal
		Earth (ground) Terminal

Safety Guidelines

- General Guideline**
- Do not place any heavy object on PSH.
 - Avoid severe impacts or rough handling that leads to damaging PSH.
-  **CAUTION**
- Do not discharge static electricity to PSH.
 - Do not block or obstruct cooling fan vent opening.
 - Do not perform measurements at power source and building installation site (Note below).
 - Do not disassemble PSH unless you are qualified as service personnel.

(Note) EN 61010-1:2001 specifies the measurement categories and their requirements as follows. PSH falls under category II. Measurement category IV is for measurement performed

at the source of low-voltage installation.
 Measurement category III is for measurement performed in the building installation.
 Measurement category II is for measurement performed on the circuits directly connected to the low voltage installation.

Power Supply

- Input voltage: 90 ~ 250 V AC, 50/60 Hz



WARNING

- The power supply voltage should not fluctuate more than 10%.
- Connect the protective grounding conductor of the power cord to earth ground, to avoid electrical shock.

Fuse



WARNING

PSH-1036A	6.3A/250V x2
PSH-2018A	
PSH-3610A	
PSH-6006A	
PSH-1070A	6.3A/250V x2
PSH-2035A	0.5A/250V x1
PSH-3620A	15A/250V x1
PSH-6012A	
PSH-10100A	6.3A/250V x3
PSH-2050A	0.5A/250V x1
PSH-3630A	20A/250V x1
PSH-6018A	

- Make sure the correct type of fuse is installed before powering up.
- Replace the fuse with the specified type and rating only, for continued fire protection.
- Disconnect the power cord before fuse replacement.
- Make sure the cause of the fuse blowout is fixed before fuse replacement.

Cleaning PSH

- Disconnect the power cord before cleaning.
- Use a soft cloth dampened in a solution of mild detergent and water. Do not spray any liquid into PSH.
- Do not use chemicals or cleaners containing harsh materials such as benzene, toluene,

xylene, and acetone.

Operation Environment

Location: Indoor, no direct sunlight, dust free, almost non-conductive pollution (Note below)

Relative Humidity: < 85%



WARNING

Altitude: < 2000m

Temperature: 0°C to 40°C

Input Breaker Capacity: Over 20A (PSH-10100A, 2050A, 3630A, 6018A)

This is a Class A product which may cause radio interference in a domestic environment. In such case, take adequate measures.

(Note) EN 61010-1:2001 specifies the pollution degrees and their requirements as follows. PSH falls under degree 2.

Pollution refers to “addition of foreign matter, solid, liquid, or gaseous (ionized gases), that may produce a reduction of dielectric strength or surface resistivity”.

Pollution degree 1: No pollution or only dry, non-conductive pollution occurs. The pollution has no influence.

Pollution degree 2: Normally only non-conductive pollution occurs. Occasionally, however, a temporary conductivity caused by condensation must be expected.

Pollution degree 3: Conductive pollution occurs, or dry, non-conductive pollution occurs which becomes conductive due to condensation which is expected. In such conditions, equipment is normally protected against exposure to direct sunlight, precipitation, and full wind pressure, but neither temperature nor humidity is controlled.

Storage Environment

Location: Indoor

Relative Humidity: < 70%

Temperature: -10°C to 70°C

Power cord for the United Kingdom

When using PSH in the United Kingdom, make sure the power cord meets the following safety instructions.

NOTE: This lead / appliance must only be wired by competent persons



WARNING: THIS APPLIANCE MUST BE EARTHED

IMPORTANT: The wires in this lead are coloured in accordance with the following code:

Green/ Yellow: Earth
Blue: Neutral
Brown: Live (Phase)



As the colours of the wires in main leads may not correspond with the colours marking identified in your plug/appliance, proceed as follows:

The wire which is coloured Green & Yellow must be connected to the Earth terminal marked with the letter E or by the earth symbol  or coloured Green or Green & Yellow.

The wire which is coloured Blue must be connected to the terminal which is marked with the letter N or coloured Blue or Black.

The wire which is coloured Brown must be connected to the terminal marked with the letter L or P or coloured Brown or Red.

If in doubt, consult the instructions provided with the equipment or contact the supplier.

This cable/appliance should be protected by a suitably rated and approved HBC mains fuse: refer to the rating information on the equipment and/or user instructions for details. As a guide, cable of 0.75mm² should be protected by a 3A or 5A fuse. Larger conductors would normally require 13A types, depending on the connection method used.

Any moulded mains connector that requires removal /replacement must be destroyed by removal of any fuse & fuse carrier and disposed of immediately, as a plug with bared wires is hazardous if engaged in live socket. Any re-wiring must be carried out in accordance with the information detailed on this label.

PSH Overview

PSH Series are modular-type programmable switching power supplies designed for broad range of applications. The series consists of 12 models, output ranging from 360W to 1000W. Switching technology and built-in PFC control give PSH higher power efficiency, power density, and power factor compared with other linear power supplies. Protection mechanisms keep the output voltage, current, and temperature within limit. Remote control interface equipped with SCPI command set and Lab-View Driver facilitates ATE software development.

This chapter describes PSH series features and appearances in a nutshell.

Main features	Main Features	12
Series lineup	360W	13
	720W	13
	1000/ 1080W	13
Package contents	Main unit	14
	AC input cable kit	14
	Output connection kit	15
	Manual	15
Panel descriptions	Front Panel	16
	Rear Panel	18
Display descriptions	Default display	19
	Menu mode display	20

Main Features

Performance	<ul style="list-style-type: none"> • 12 models with wide output range: 6~100A, 10~60V, and 360~1000W. • High power factor with PFC control • High efficiency power conversion • Compact size, light weight
Operation	<ul style="list-style-type: none"> • Constant voltage operation • Constant current operation • Output On/Off control • Built-in buzzer • Self test and calibration • LCD display
Protection	<ul style="list-style-type: none"> • Over voltage protection (OVP) • Over current protection (OCP) • Over temperature protection (OTP)
Interface	<ul style="list-style-type: none"> • RS-232 (standard) / GPIB (optional) interface • IEEE 488.2/SCPI compatible command set • LabView driver
Optional items	<ul style="list-style-type: none"> • GPIB remote control interface • 19 inch standard rack mounting

PSH Series Lineup

PSH series consist of the following 12 models with various output voltage and current ratings. For the detailed specifications, see page71.

**360W
(Mainframe only)**

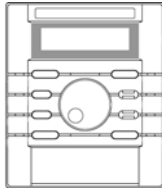

PSH-1036A
10V, 36A

PSH-2018A
20V, 18A

PSH-3610A
36V, 10A

PSH-6006A
60V, 6A

**720W
(Mainframe + one slave module)**

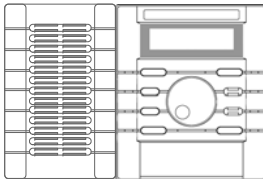

PSH-1070A
10V, 70A

PSH-2035A
20V, 35A

PSH-3620A
36V, 20A

PSH-6012A
60V, 12A

**1000/ 1080W
(Mainframe + two slave modules)**

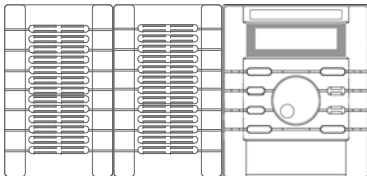

PSH-10100A
10V, 100A

PSH-2050A
20V, 50A

PSH-3630A
36V, 30A

PSH-6018A
60V, 18A

Package Contents

Check the contents before using PSH series. Contact your local dealer in case there is a missing item.

Main unit

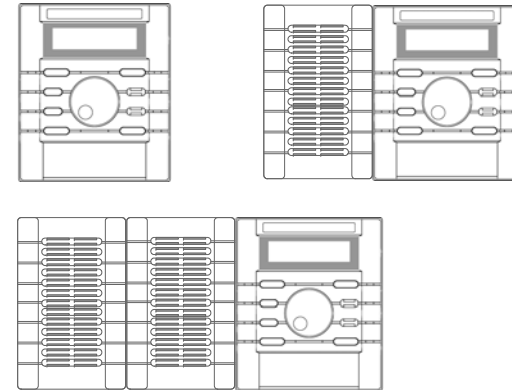

AC input cable kit

- Cable gland



- Terminal cover

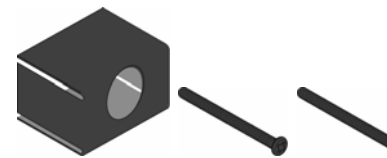

- AC power input cord



(US/Taiwan/Japan only)

Package Contents (cont.)

Output connection kit

- Terminal cover

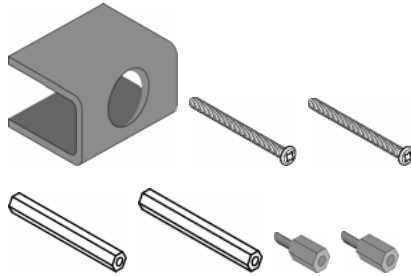

- Output cable screw



Manual

- User manual (this document)
- Programming manual

Front Panel

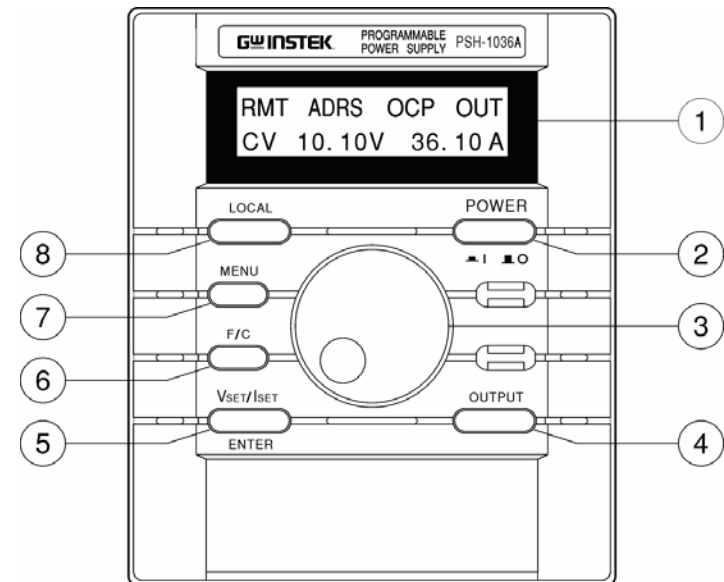

- 1 LCD Display** Shows the output and the configuration status. See page19 for details.
- 2 Power Switch** On Off
- 3 Wheel knob** Sets parameters. Turn right: increase, turn left: decrease.
- 4 Output Switch** Turns the output On or Off. When On, the “OUT” sign appears on the display.

Out On

Out Off

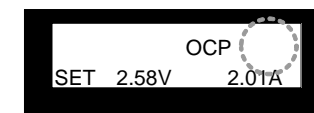
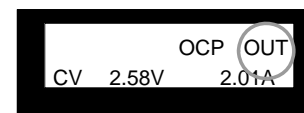

- 5 **Vset/ Iset/ Enter key** Switches between voltage setting mode and current setting mode, or confirm the entered value in the menu mode (see page44).

Vset (edit Voltage)

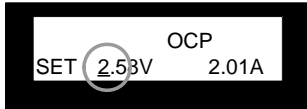

Iset (edit Current)

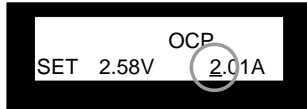

- 6 **F/C (Fine/ Coarse) key** Switches the editing location and resolution: before (coarse) or after (fine) the decimal point.

Fine (after decimal)

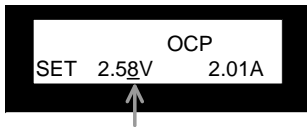

Coarse (before decimal)

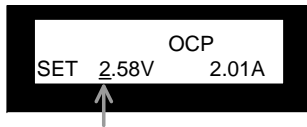

- 7 **Menu key** Enters into the menu mode. For details, see page44.

Default mode

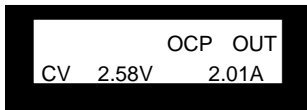

Menu mode (OVP setting)

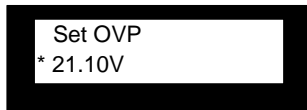

- 8 **Local key** Switches from remote control mode to local operation mode (page56), OR releases OVP/OCP error messages and go back to normal operation (page37), OR enters the calibration mode when pressed for more than 5 seconds (page61).

Error message example

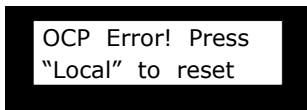

Calibration mode

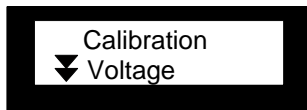

Rear Panel

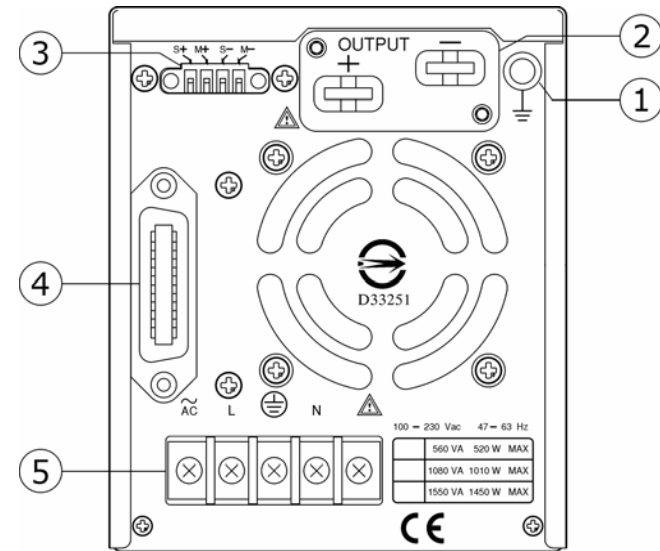

- | | |
|-------------------------------|---|
| 1 Ground Terminal | Connect the output line shield (page25) and the remote sensing line shield (page32). |
| 2 Output Terminal | Connect DUT (Device Under Test). For details, see page24. |
| 3 Sense Terminal | Connect the feedback line to compensate for cable loss. For details, see page24 (theory), page32 (cable connection). |
| 4 RS232/ GPIB Terminal | Connect the remote control line. For remote control details, see page52. GPIB requires an optional module. For installation details, see the service manual.
Note: Only one interface module (RS232 or GPIB) can be installed at a time. |
| 5 AC input Terminal | Connect the AC power input cable. For details, see page22. |

Display

Default display

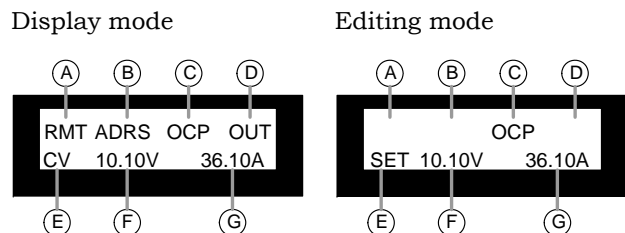

- A RMT: remote control mode
(Nothing): panel operation mode
Not available in editing mode
- B ADRS: RS-232 or GPIB address (available in remote control)
Not available in editing mode
- C OCP: Output Current Protection On
(Nothing): Output Current Protection Off
- D OUT: Output On
(Nothing): Output Off
Not available in editing mode
- E CV/CC: Current and Voltage display mode (Constant Voltage/ Constant Current)
SET: Current and Voltage editing mode
- F Output Voltage readback value (display mode)
Output Voltage setting value (editing mode)
- G Output Current readback value (display mode)
Output Current setting value (editing mode)

Display (cont.)

Menu mode display

The following displays appear when pressing the Menu key . To move to the next configuration, press the Menu key repeatedly. When inactive for more than 5 seconds, the display goes back to the default mode.

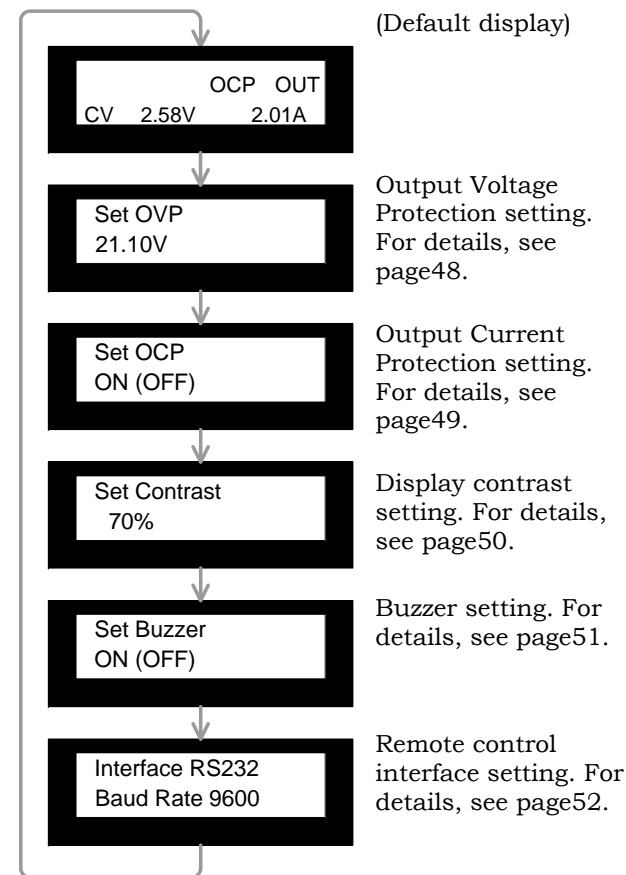

Setup

This chapter describes load configurations and setup procedures. Follow these instructions to properly install PSH series.

AC power cable assembly	AC Power Cable Assembly	22
	AC power cable requirement	23
Load configuration	Remote Sensing and Local Sensing	24
	Load / Remote Sensing Wire Selection	25
	Single Load + Local Sensing	26
	Single Load + Remote Sensing	26
	Multiple Loads + Local Sensing	27
	Multiple Loads + Remote Sensing	27
	Series Operation + Local Sensing	28
Wire assembly	Load Wire Assembly	30
	Remote Sensing Wire Assembly	32
Functionality Check	Preparation	34
	Output Voltage & OVP Check	35
	Output Current Check	37
	OCP Check	38
Rack mounting (optional)	Rack mounting kit contents	40
	Rack mounting assembly	41

AC Power Cable Assembly

1 Cable gland + Terminal Cover Put the power cable through the cable gland and the terminal cover, screw them together.

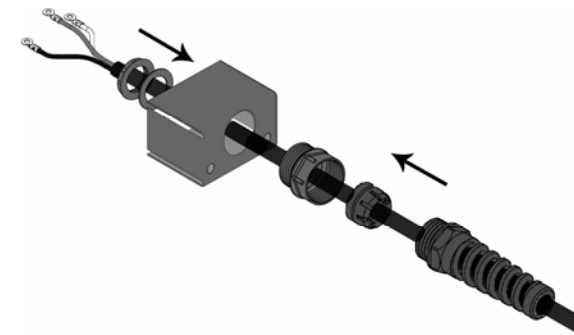

2 Cable wire + Terminal Screw the wire onto the AC input terminal. Note the wire color: Neutral (white), GND (green), and Line (black).

CAUTION

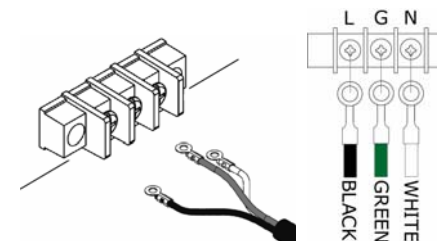

3 Terminal cover + Terminal Screw the terminal cover onto the terminal.

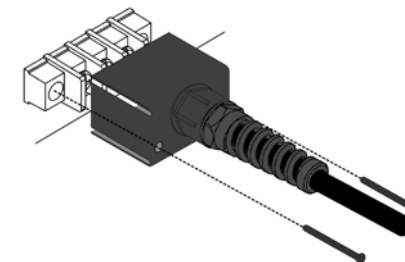

AC power cable requirement

Here is the AC power cable specification, in case of using cables other than the attached one.

Cable length	≤ 3m
Cable gland	KSS or PG-2013
Cable type (recommended)	Model: SJT Type: 3 x 14 AWG stranded copper Rating: 60°C min, 300V Diameter: 9.143~10.03 mm Model: H05 VV-F Type: 3G 1.5mm ² stranded copper Rating: 300V/500V Diameter: 8.5 ± 0.2 mm

Remote Sensing and Local Sensing

Remote sensing compensates the cable loss between PSH and load, up to 0.5V. Use remote sensing whenever the load voltage has to be accurate.

Local Sensing (default)

$V_{SET} = V_{OUT}$
 $V_{OUT} > V_{LOAD}$

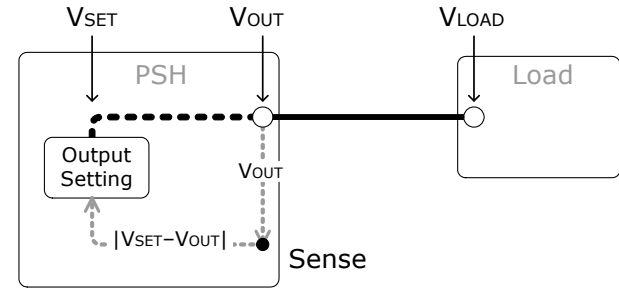

The sense terminal is internally connected to the PSH output terminal. The delta between the voltage setting level (V_{SET}) and the actual output level (V_{OUT}) is compensated. The load terminal voltage (V_{LOAD}) might become lower than the output due to cable loss.

Remote Sensing

$V_{SET} = V_{LOAD}$
 $V_{OUT} > V_{SET}$

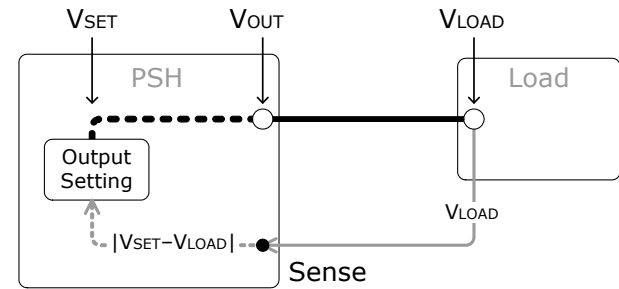

The sense terminal is connected to the load input terminal. The delta between the voltage setting level (V_{SET}) and the actual load voltage (V_{LOAD}) is compensated. The output voltage (V_{OUT}) might become higher than the setting due to the compensation.

Load / Remote Sensing Wire Selection

The following instructions apply to both load wire and remote sensing wire, unless noted.

Wire size (FOR LOAD ONLY) Load wires must have enough current capacity to minimize cable loss and load line impedance. Voltage drop across a wire should not exceed 0.5V. The following list is the wire current rating at 450A/cm².

Wire size (AWG)	Max. current (A)	Wire size (AWG)	Max. current (A)
20	2.5	6	61
18	4	4	97
16	6	2	155
14	10	1	192
12	16	1/0	247
10	21	2/0	303
8	36		

Wire length To avoid excessive cable loss, shorten the distance between PSH and load as much as possible. Remote sensing compensates cable loss up to 0.5V.

Wire shielding To minimize noise effect and load line impedance, use shielded pair wiring. Twisted wires are more effective, especially for remote sensing.



Wire shield should be connected to the rear panel ground connector.

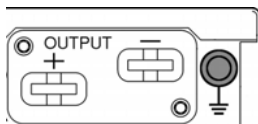

Load Configuration

Select the appropriate configuration for the target application. For local sensing and remote sensing explanation, see the previous page.

For connection guideline, see page25 (wire selection), page30 (load connection), page32 (remote sensing connection).

Single PSH + single load

Single Load + Local Sensing

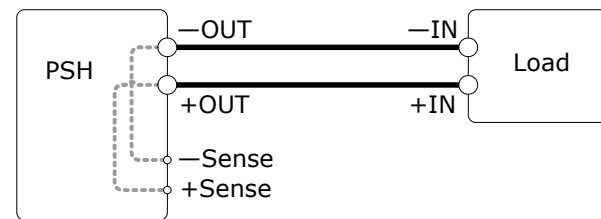

Connect the output wire to the load and the sense terminal to the PSH local output monitor.

Single Load + Remote Sensing

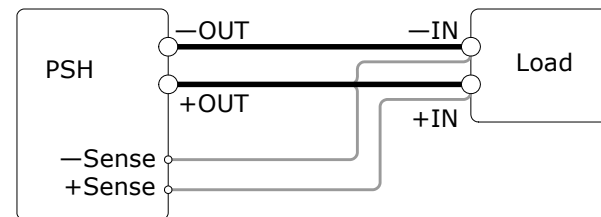

Connect both the output wire and the remote sensing wire to the load.

Single PSH + multiple Load

- Condition**
- Output current for each load follows the load requirement.
 - When the sum of the load current surpasses the rating, PSH automatically switches to CC (Constant Current) mode.

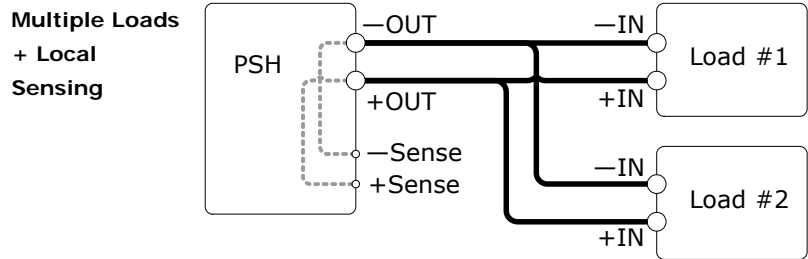

All loads share one PSH output.

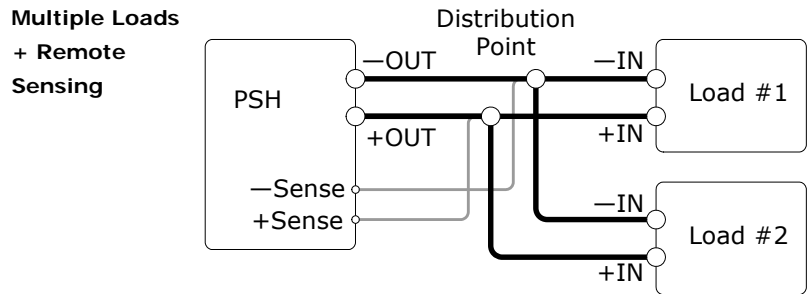

Create a distribution point between PSH and the loads. PSH compensates the cable loss up to the distribution point.

To maximize compensation, make sure the distribution point is closer to the load side.

Multiple PSH + single load (series operation)

- Condition**
- Up to four PSH series (with identical output ratings) can be cascaded.
 - Output voltage is the sum of the cascaded PSH.
 - Output current is the same as a single PSH.

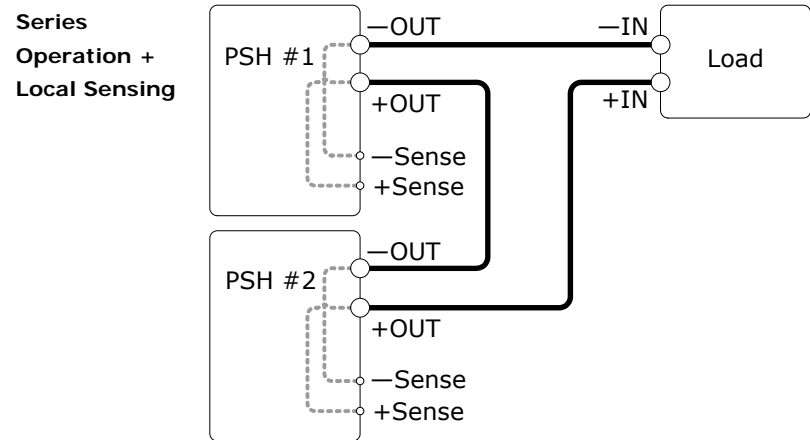

First PSH:

Negative output → Negative load input

Positive output → The next PSH negative output

Intermediate PSH:

Negative output → The previous PSH positive output

Positive output → The next PSH negative output

Last PSH:

Negative output → The previous PSH positive output

Positive output → Positive load input

Series Operation (cont.)

Series
Operation +
Remote
Sensing

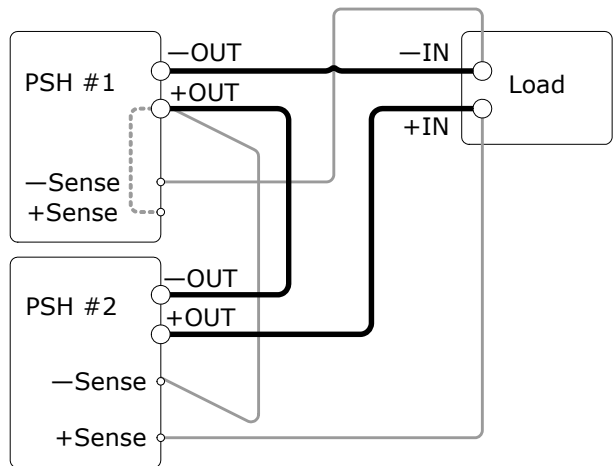

First PSH:

- Negative output → Negative load input
- Positive output → The next PSH negative output
- Negative sense → Negative load input
- Positive sense → Positive output monitor

Intermediate PSH:

- Negative output → The previous PSH positive output
- Positive output → The next PSH negative output
- Negative sense → The previous PSH positive output
- Positive sense → Positive output monitor

Last PSH:

- Negative output → The previous PSH positive output
- Positive output → Positive load input
- Negative sense → The previous PSH positive output
- Positive sense → Positive load input

Load Wire Assembly

1. Wire
selection

Select the appropriate wire according to the guideline on page 25.

2. Terminal
screw
replacement

Replace the two screws on the output terminal with the hex screw in the output connection kit.

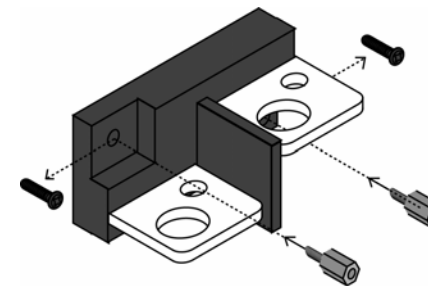

3. Terminal
connection

Screw load wires to the terminal.

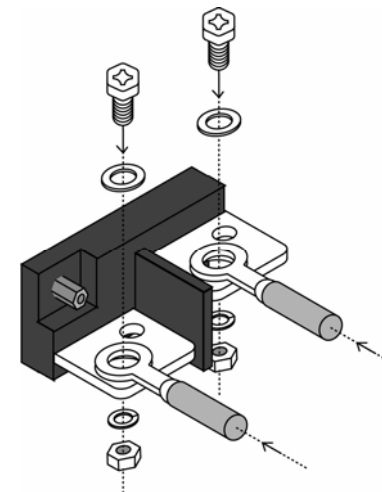

Load Wire Assembly (cont.)

- 4. Terminal cover assembly** Screw the output terminal cover to the rear panel.

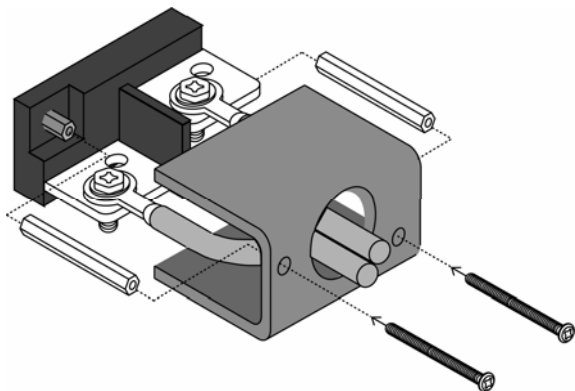

- 5. Wire shield connection (recommended)** Connect the load wire shield to the rear panel ground connector.

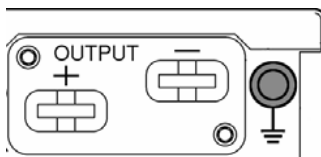
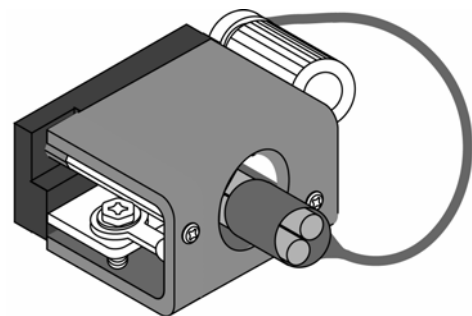

Remote Sensing Wire Assembly

Select the appropriate wire according to the guideline on page 25.

- Local sensing** The sense terminal is connected to the output monitor terminal with bare wires.

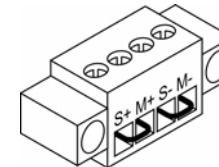

- Remote Sensing** 1. Take off the wire jumpers.

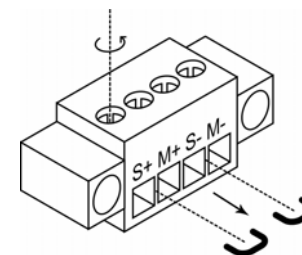

2. Screw wires to the sense (S) side.

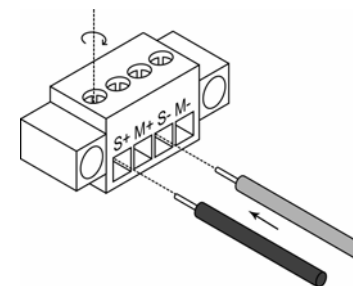

- Do not screw remote sensing wires to the monitor (M) side.
- M+, M- are for output monitoring only. NEVER screw load wires to the remote sensing terminal.

Remote Sensing Wire Assembly (cont.)

5. Wire shield connection

To minimize noise effect, we recommend covering the remote sensing wire with ground shield and connect it to the ground terminal.

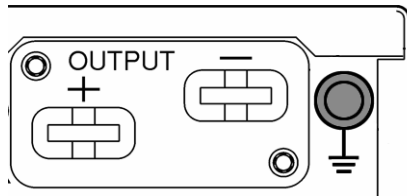

CAUTION

An open remote sense circuit leads to output level overshoot. Make sure the line is securely connected.

Functionality Check

Check the PSH basic functionalities before operation.

Preparation

Check items	• Output Voltage
	• OVP functionality
	• Output Current
	• OCP functionality
Equipment	Digital Multimeter <ul style="list-style-type: none"> • DC Voltage Accuracy: $<\pm 0.1\%$ • Recommended model: GDM-8245, GDM-8246
	Current Shunt <ul style="list-style-type: none"> • Current range: $>100A$ • Accuracy: $<\pm 0.1\%$
	PSH – Current Shunt cable <ul style="list-style-type: none"> • Voltage rating: $>70V$ • Current rating: $>100A$
	Multimeter – Current Shunt cable <ul style="list-style-type: none"> • N/A
When there is a problem...	Run calibrations (page61). If this does not solve the issue, refer to the service center.

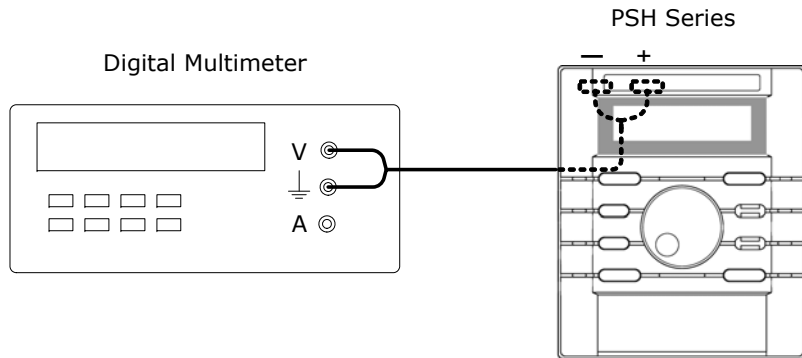

Output Voltage & OVP Check

Connection



Checking step

1. Power On PSH and connect the Multimeter Voltage measurement terminal.
2. Set Output Voltage and Output Current to the rating value.

- Vset/Iset/Enter key  switches the cursor between Voltage and Current.
- F/C key  switches the cursor between before and after the decimal point.
- Wheel knob  changes the value.

PSH-2018A (20V, 18A)



3. Press the Menu key once and set the OVP value to rating voltage + 100mV.

Press the Vset/Iset/Enter key  to confirm the OVP setting.

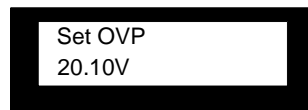

4. Make sure the Multimeter shows no value (No output).
5. Press the Output key  and turn On the output.

The display changes into CV (Constant Voltage) mode and shows the OUT sign on the top right corner.



6. Make sure the Multimeter reading and the PSH display show approximately the same Voltage.
7. Increase the PSH output voltage beyond the OVP value.
8. Make sure the display shows an error message.

Press the Local key  to get back to the normal display.

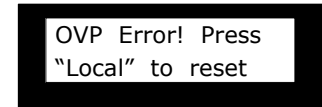

9. Make sure the output is now turned Off in the display and the Multimeter shows no value (No output).

Output Current Check

Connection

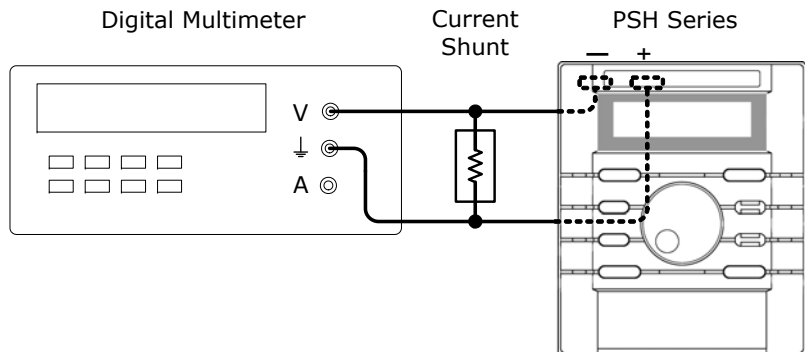

Checking step

1. Power On PSH and connect the Multimeter/ Current Shunt terminal.
2. Set the Output Voltage and Current value to the rating.
 - Vset/Iset/Enter key switches the cursor between Voltage and Current.
 - F/C key switches the cursor before and after the decimal point.
 - Wheel knob changes the value.
3. Make sure the Multimeter/Current Shunt shows no output.
4. Press the Output key and turn On the output.
5. Make sure the Multimeter/Current Shunt reading and the PSH display show approximately the same Current.

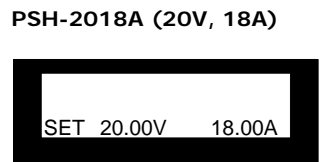

OCP Check

Connection

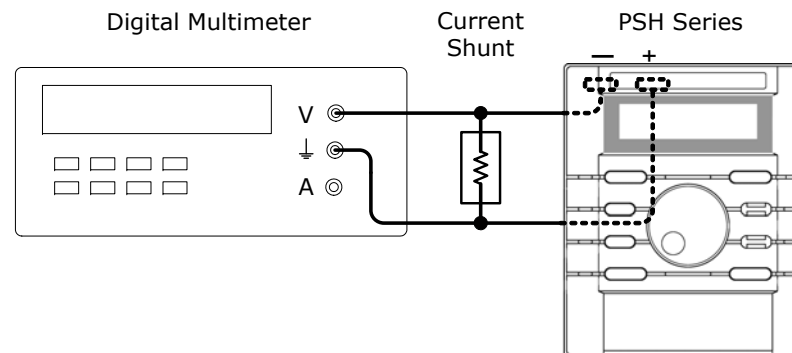

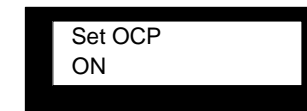
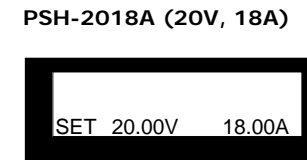

Checking step

1. Power On PSH and connect the Multimeter / Current Shunt terminal.
 2. Set the Output Voltage and Current value to the rating.
 - Vset/Iset/Enter key switches the cursor between Voltage and Current.
 - F/C key switches the cursor before and after the decimal point.
 - Wheel knob changes the value.
 3. Press the Menu key twice to view the OCP setting.
 - Turn the wheel knob to change OCP setting to ON.
- Press the Vset/Iset/Enter key to confirm the setting.

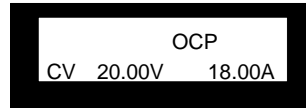

The OCP sign appears on the upper side of the display.



4. Press the Output key  and turn On the output.
5. Make sure the display shows the error message.

Press the Local key  to get back to the normal display.

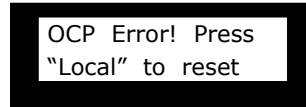

6. Make sure the output is now turned Off in the display and the Multimeter / Current Shunt shows no value (No output).

Rack Mounting (Optional)

PSH can be mounted on standard 19 inch rack using GRA-403 rack mounting kit.

Rack mounting kit contents

Main bracket x 1

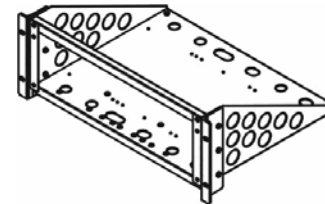

Front panel x 1

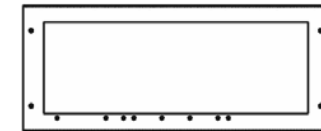

Large decoration board x 1



Medium decoration board x 2



Small decoration board x 2



Binding plate x 6

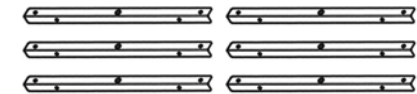

Handle x 2



Screw M4 * 0.7 L=10mm x 4



Screw M3 * 0.5 L = 8mm x 18



Rack mounting assembly

1. Rack mounting layout

Confirm the rack mount layout. Make sure there is a space between each PSH. Below is the example of rack mounting layout.

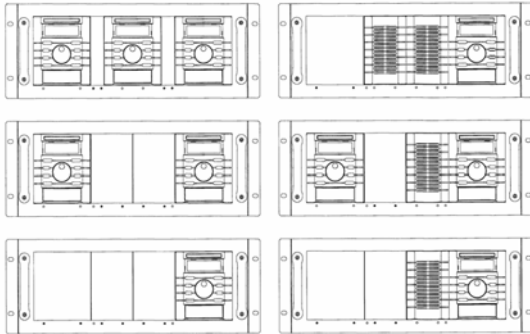

2. Decoration board assembly

Once the layout is fixed, screw the decoration boards to the front panel using M3 screws.

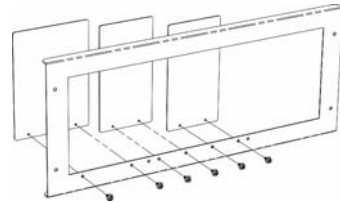

3. Binding plate assembly

Take off two M3 screws from PSH side panels, front and rear. Hold the binding plate between PSH and drive the same screws in.

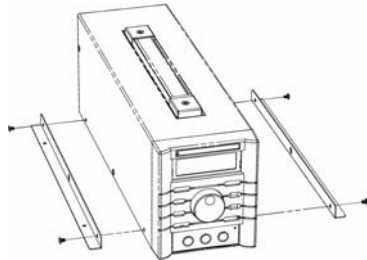

4. Main bracket assembly

Fix the PSH to the main bracket using M3 screws.

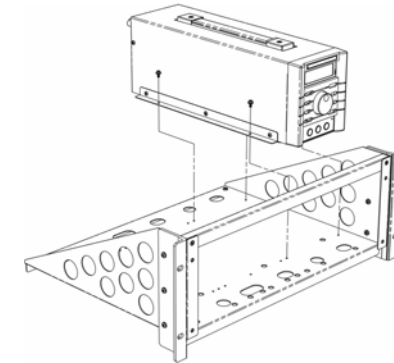

Fix the front panel and the handle to the main bracket using M4 screws.

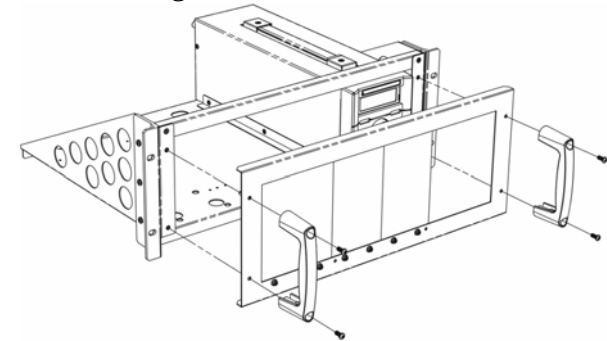

Panel Operation

This chapter describes the manual operations done at the front panel, together with the constant voltage/ constant current crossover characteristics.

Menu key overview	Menu Key Overview	44
CV/ CC characteristic	Constant Voltage/ Constant Current Crossover Characteristic	45
Output Voltage setting	Output Voltage Setting	46
Output Current setting	Output Current Setting	47
	Note	47
OVP setting	Set the OVP value.....	48
	Clear OVP error	48
OCP setting	Turn the OCP On/Off	49
	Clear OCP error	49
Display contrast setting	Display Contrast Setting	50
Buzzer sound setting	Buzzer sound Setting	51
	Buzzer condition	51

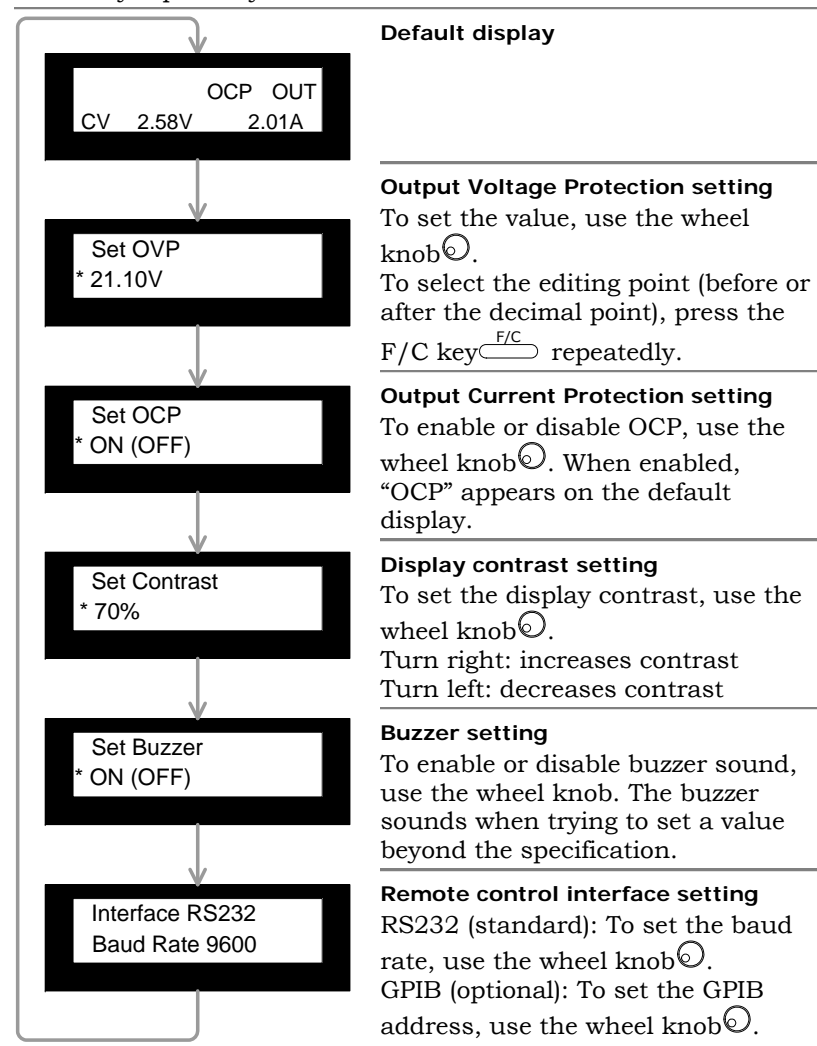

Menu Key Overview

Press the Menu key . To move to the next item, press the Menu key repeatedly.



Default display

Output Voltage Protection setting

To set the value, use the wheel knob . To select the editing point (before or after the decimal point), press the F/C key  repeatedly.

Output Current Protection setting

To enable or disable OCP, use the wheel knob . When enabled, "OCP" appears on the default display.



Display contrast setting

To set the display contrast, use the wheel knob . Turn right: increases contrast
Turn left: decreases contrast

Buzzer setting

To enable or disable buzzer sound, use the wheel knob. The buzzer sounds when trying to set a value beyond the specification.

Remote control interface setting

RS232 (standard): To set the baud rate, use the wheel knob . GPIB (optional): To set the GPIB address, use the wheel knob .

Constant Voltage/ Constant Current

Crossover Characteristic

PSH series automatically switch between constant voltage mode and constant current mode, according to the load change.

When **the load current is smaller** than the limit (ISET), PSH operates in **Constant Voltage mode**, changing the current level according to the load but keeping the Voltage level at the limit (VSET).

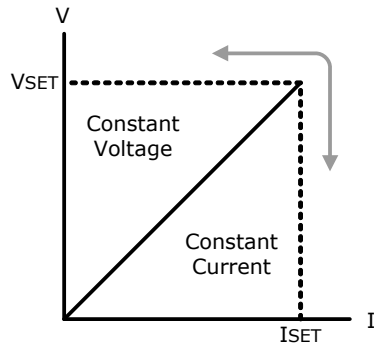

When **the load current is the same** as the limit (ISET), PSH operates in **Constant Current mode**, changing the Voltage level according to the load but keeping the Current level at the limit (ISET).

VSET = Output Voltage setting
ISET = Output Current setting

Let's take recharging a 12V battery as an example. PSH output setting is 13.8V, 1A. An empty battery puts a heavy current load on the power supply. PSH starts running at Constant Current mode, supplying full 1A current but keeping the voltage lower than 13.8V. As the battery becomes charged, the load also becomes smaller. PSH then switches to Constant Voltage mode, supplying less than 1A current but supplying full 13.8V.

Display The display indicates CV (Constant Voltage) or CC (Constant Current) on the left side.

Constant Voltage

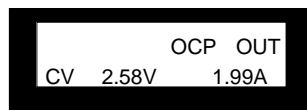

Constant Current

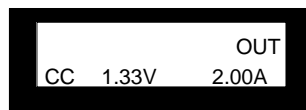

Output Voltage Setting

Operation

1. Press the Vset/ Iset key  repeatedly to move the underline to the Voltage side.

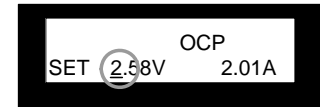

2. Press the F/C key  to move the underline before or after the decimal point.

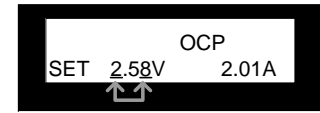

3. Use the wheel knob  to change the output voltage.

Range 0.00V ~ rating voltage

Step 10mV (rating voltage < 36V)
20mV (rating voltage ≥ 36V)

Output Current Setting

Operation

1. Press the Vset/ Iset key  repeatedly to move the underline to the Current side.

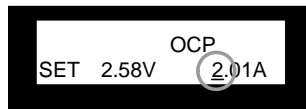

2. Press the F/C key  to move the underline before or after the decimal point.

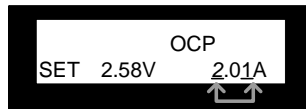

3. Use the wheel knob  to change the output current.

Range 0.00A ~ rating current

Step 10mA

Note When the output current exceeds the setting value, PSH automatically switches from CV (Constant Voltage) to CC (Constant Current) mode.

OVP (Output Voltage Protection) Setting

Set the OVP value

1. Press the Menu key  repeatedly until the OVP menu appears.

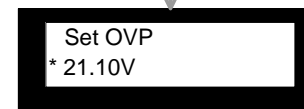
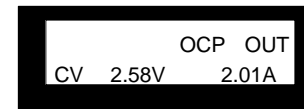

2. Press the F/C key  to move the underline before or after the decimal point.

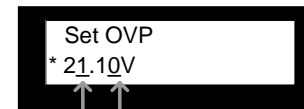

3. Use the wheel knob  to change the value.

4. Press the Iset/Vset/Enter key  to confirm the value.

Clear OVP error

1. When the output voltage exceeds OVP value, the output is shut off and an OVP error message appears on the display.
2. Press the Local key  to clear the error message (the output is still Off).

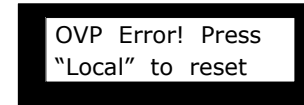

Range 0.00V ~ rating voltage

Step 10mV (rating voltage < 36V)
20mV (rating voltage ≥ 36V)

OCP (Output Current Protection) Setting

Turn the OCP On/Off

1. Press the Menu key  repeatedly until the OCP menu appears.

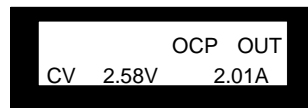

Set OCP
OFF

2. Use the wheel knob  to change the status to ON (or OFF).

Set OCP
ON

3. Press the Iset/Vset/Enter key  to confirm the setting.

Clear OCP error

1. When the output current exceeds the current setting, the output is shut off and an OCP error message appears on the display.

OCP Error! Press
"Local" to reset

2. Press the Local key  to clear the error message (the output is still Off).

Range	According to the output current
--------------	---------------------------------

Display Contrast Setting

Operation

1. Press the Menu key  repeatedly until the Contrast menu appears.

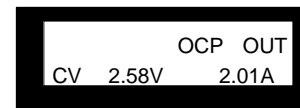

Set Contrast
71%

2. Use the wheel knob  to change the contrast. Clockwise: increase, Counterclockwise: decrease.

Range	5% ~ 95%
--------------	----------

Step	6%
-------------	----

Buzzer sound Setting

Operation

1. Press the Menu key  repeatedly until the Buzzer menu appears.

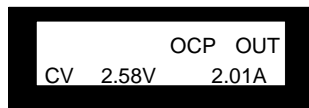

2. Use the wheel knob  to change the buzzer setting to ON (or OFF).
3. Press the Iset/Vset/Enter key to confirm the value.

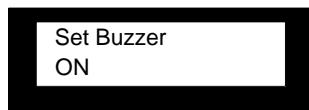

Buzzer condition When “Set Buzzer ON”, the buzzer sounds under the following conditions.
 * When pressing the panel keys
 * When the value setting exceeds the limit

Remote Operation

This chapter describes the IEEE 488.2 based remote control configuration, command syntax, and command set overview. For further descriptions and examples, refer to the programming manual.

Interface configuration	RS232 (Standard).....	53
	GPIB (Optional).....	55
	Interface functionality check	56
Command set	Command Syntax	57
	General commands	58
	Status commands	59
	Miscellaneous commands.....	60



Interface Selection

RS232 (Standard)

Baud rate setting

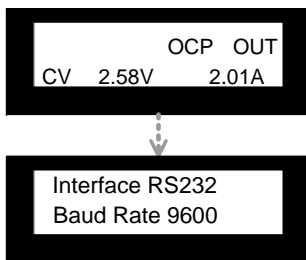
1. Press the Menu key  repeatedly until the Interface menu appears.



2. Use the wheel knob  to select the baud rate.
3. Press the Iset/Vset/Enter key  to confirm the setting.
4. Connect the RS232 cable between your PC and PSH rear panel. PSH switches to remote control mode as soon as the connection is established.

RS-232 interface protocol

Baud rate: 9600, 4800, 2400, 1200 (selectable)
 Parity: None (fixed)
 Stop bit: 1 (fixed)
 Data bit: 8 (fixed)

PSH RS-232 pin assignment

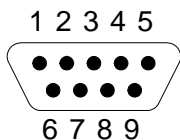

Pin 2: RxD
Pin 3: TxD
 Pin 5: GND
 Pin 1, 4, 6 ~ 9: No Connection

PC RS-232 pin assignment

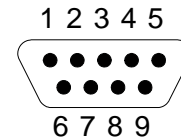

Pin 2: TxD
Pin 3: RxD
 Pin 5: GND
 Pin 1, 4, 6 ~ 9: No Connection

PSH – PC connection

Null-modem connection, in which transmit (TxD) and receive (RxD) lines are crosslinked, is required.

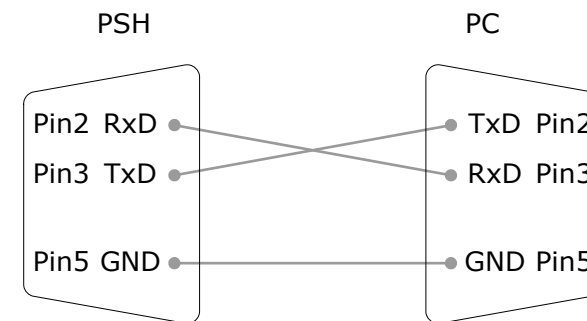



GPIB (Optional)

Refer to the service manual for GPIB module installation.
 Note: The RS232 module has to be replaced with the GPIB module: they cannot be used together.

Address setting

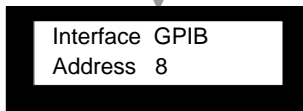
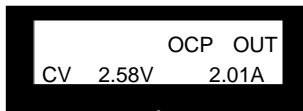
1. Press the Menu key  repeatedly until the Interface menu appears.



2. Use the wheel knob  to select the address.
GPIB address: 1 ~ 30
3. Press the Iset/Vset/Enter key  to confirm the setting.
4. Connect the GPIB cable between your PC and PSH rear panel. PSH switches to remote control mode as soon as the connection is established.

GPIB constraints

- Address range: 1 ~ 30
- Altogether less than 15 devices, less than 20m total cable length, maximum 2m between each device
- Unique address assigned for each device
- At least 2/3 of the GPIB devices turned On
- No loop or parallel structure

Interface functionality check

Remote mode display

In the remote control mode, the display shows "RMT" on the top left corner. The panel operation is disabled.

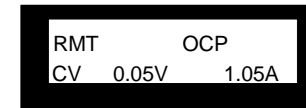

To enable panel operation, press the Local key . This also disconnects the remote control.

Functionality check

Run this query command via the terminal.

*idn?

This should return the Manufacturer, Model number, Serial number, and Firmware version in the following format.

GW.Inc,PSH-2018A,12345678,FW1.00

Command Syntax

The commands are fully compatible with IEEE488.2 (1992) standard and partially compatible with SCPI (1994) standard.

Example command	:chan1:prot:curr <0/1> LF	
	1	2 3 4
	1: Command Header	
	2: Single space	
	3: Parameter	
	4: Message Terminator OR Message Separator	
Command Header	Several command header elements (nodes) can be concatenated to form a complex command. The above example can be separated into: :chan1: (root node) + prot: + curr:	
Parameter example	<0/1>	0 or 1.
	<1~4>	Integer between 1, 2, 3, or 4.
	<0.01~5>	Decimal number between 0.01 and 5.
Message Terminator	Marks the end of a command line. Any of the following is acceptable, in accordance with IEEE488.2 standard.	
	LF^END	Line feed code (hexadecimal 0A) with END message
	LF	Line feed code
	<dab>^END	Last data byte with END message
Message Separator	; (semicolon) Command separator.	

Command Set

Commands are **non**-case sensitive.

For more detailed information, refer to the Programming Manual which is downloadable from www.gwinstek.com.tw.

General commands

:chan1:curr?	Returns the output current (unit: A). Range: 0.01~rating current
:chan1:curr <0.01~rating>	Sets the output current (unit: A). Range: 0.01~rating current
:chan1:volt?	Returns the output voltage (unit: V). Range: 0.01~rating voltage
:chan1:volt <0.01~rating>	Returns the output voltage (unit: V). Range: 0.01~rating current
:chan1:meas:curr?	Returns the actual output load current (unit: A).
:chan1:meas:volt?	Returns the actual output load voltage (unit: V).
:chan1:prot:curr?	Returns the Over Current Protection status. Range: 0 (Off), 1 (On)
:chan1:prot:curr <0/1>	Sets the Over Current Protection. Range: 0 (Off), 1 (On)
:chan1:prot:volt?	Returns the Over Voltage Protection value. Range: 0.01~rating (unit: V)
:chan1:prot:volt <0.01~rating>	Sets the Over Voltage Protection value. Range: 0.01~rating (unit: V)
:chan1:prot:clear	Clears the OCP & OVP protection message from the display.
:outp:stat?	Returns the output status. Range: 0 (Output Off), 1 (Output On)
:outp:stat <0/1>	Sets the output status. Range: 0 (Output Off), 1 (Output On)

Status commands

*cls	Clears all event status registers (Output Queue, Operation Event Status, Questionable Event Status, Standard Event Status)
*ese?	Returns the ESER (Event Status Enable Register) contents. Example: 130→means ESER=10000010
*ese <0~255>	Sets the ESER contents. Example: *ese 65→sets ESER to 01000001
*esr?	Returns and clears the SESR (Standard Event Status Register) contents. Example: 198→means SESR=11000110
*sre?	Returns the SRER (Service Request Enable Register) contents. Example: 3→means SRER=00000011
*sre <0~255>	Sets the SRER contents. Example: *SRE 7→SRER=00000111
*stb?	Returns the SBR (Status Byte Register) contents. Example: 81→means SBR=01010001
:stat:oper:cond?	Returns the Operation register contents.
:stat:oper:enab?	Returns the mask conditions of the event register. Range: 0~32767 Example: 32767 means all 15bits are set to 1.
:stat:oper:enab <0~32767>	Returns the mask conditions of the event register. Range: 0~32767 Example: 32767 sets all 15bits to 1.
:stat:oper:even?	Returns the operation register contents. Example: 32767 means all 15bits are set to 1.
:stat:pres	Sets the operation register and questionable enable register to zero.
:stat:ques:enab ?	Returns the mask conditions of the event register. Range: 0~32767 Example: 32767 means all 15bits are set to 1.
:stat:ques:enab <0~32767>	Returns the mask conditions of the event register. Range: 0~32767 Example: 32767 sets all 15bits to 1.
:stat:oper:even?	Returns the questionable register contents. Example: 32767 means all 15bits are set to 1.

Miscellaneous commands

*idn?	Returns the power supply ID as Manufacturer, Model No, Serial No, Firmware version. Example: GW.Inc,PSH-2018A,12345678,FW1.00
*opc?	"1" is placed in the output queue when all the pending operations are completed.
*opc	Sets the operation complete bit (bit0) in SERS (Standard Event Status Register) when all the pending operations are completed.
*rcl <1~99>	Recalls the panel setup from internal memory. Example: *RCL 1→recalls setup from memory1
*rst	Recalls the default panel setup (reset the device).
*sav <1~99>	Saves the panel setup to internal memory. Example: *SAV 1→saves setup to memory1
*tst?	Run the self-test for RAM and ROM and returns 0 (successful) or -300 (unsuccessful).
*wai	Prevents execution of further commands until all the pending operations are completed.
:syst:err?	Returns the error number followed by the error message from the queue. Example: 0, "No error"
:syst:vers?	Returns the SCPI version. Example: 1994.0

Calibration

Run calibration when the output exceeds the specification, or when the functionality check (page34) fails. To get the optimal result, make sure PSH is powered for at least 30 minutes before the calibration.

Setup	Calibration Preparation	62
	Entering calibration mode	63
Calibration	Output Voltage calibration.....	64
	Output Current calibration.....	66
	OVP Calibration	68

Calibration Preparation

- Calibration condition**
- At least 30 minutes of warm-up time
 - Temperature: 23 ± 5 °C



- Relative Humidity: $\leq 80\%$

- Calibration items**
- Minimum/ Maximum Output Voltage
 - Minimum/ Maximum Output Current
 - OVP functionality

- Calibration Equipment**
- | | |
|--------------------|--|
| Digital Multimeter | <ul style="list-style-type: none"> • DC Voltage Accuracy: $<\pm 0.1\%$ • Recommended model: GDM-8245, GDM-8246 |
|--------------------|--|

- | | |
|---------------|--|
| Current Shunt | <ul style="list-style-type: none"> • Current range: $>100A$ • Accuracy: $<\pm 0.1\%$ |
|---------------|--|

- | | |
|---------------------------|---|
| PSH – Current Shunt cable | <ul style="list-style-type: none"> • Voltage rating: $>70V$ • Current rating: $>100A$ |
|---------------------------|---|

- | | |
|----------------------------------|---|
| Multimeter – Current Shunt cable | <ul style="list-style-type: none"> • N/A |
|----------------------------------|---|

Entering calibration mode

1. Press the Local key for 5 seconds. The password entry menu appears.

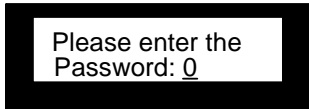

2. Enter the model number as the password. Wheel knob changes the digit. F/C key moves the cursor to the next digit.

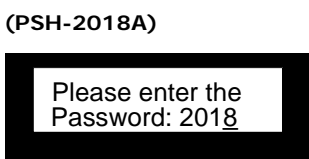

3. Press the Vset/Iset/Enter key as confirmation.

4. The calibration menu appears. Wheel knob selects the item.

Vset/Iset/Enter key confirms the selection.

- Minimum/Maximum output voltage calibration

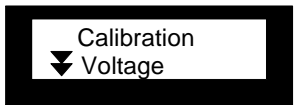

- Minimum/Maximum output current calibration

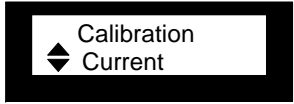

- Over Voltage Protection calibration



- Save the calibration result and exit the calibration menu

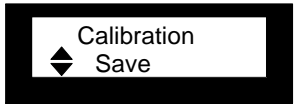

- Exit calibration menu without saving the calibration result

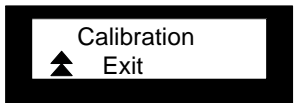

Output Voltage calibration

Connection

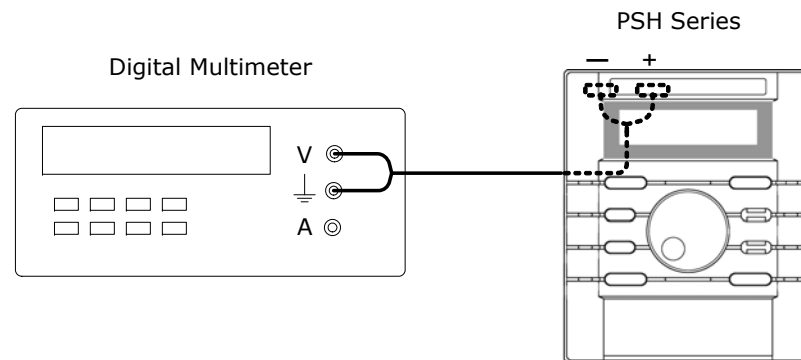

Calibration step

1. Enter the Voltage calibration menu. See page63 for details.

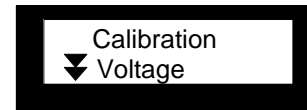

2. Press the Vset/Iset/Enter key and enter Minimum Voltage calibration mode.

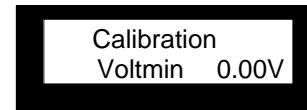

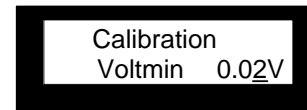

3. Adjust the display value to the Multimeter reading. Wheel knob changes the value. F/C key moves the cursor before and after the decimal point.

Multimeter reading: 0.02V



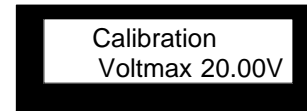

4. Press the Vset/Iset/Enter key to confirm the setting. The display enters Maximum Voltage calibration mode.

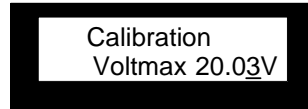

- Adjust the display value to the Multimeter reading.
Wheel knob  changes the value.
F/C key  moves the cursor before and after the decimal point.

Multimeter reading:
20.03V



- Press the Vset/Iset/Enter key  to confirm the setting. The display goes back to the default calibration menu.

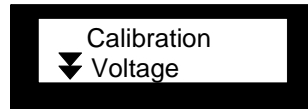

- Save the result and exit the calibration mode (Save), OR Exit the calibration mode without saving the result (Exit).

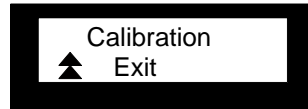
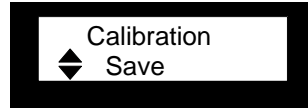

Output Current calibration

Connection

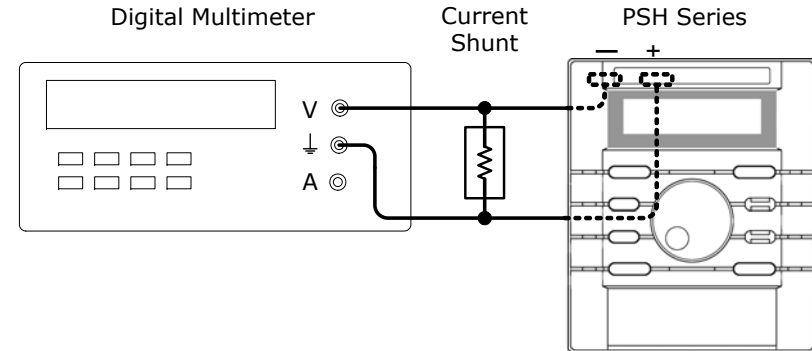

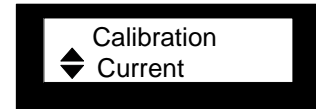

Calibration step

- Enter the Current calibration menu. See page63 for details.



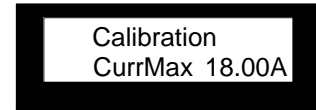

- Press the Vset/Iset/Enter key  and enter Maximum Current calibration mode.





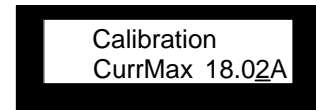

- Adjust the display value to the Multimeter / Current Shunt reading.
Wheel knob  changes the value.
F/C key  moves the cursor before and after the decimal point.

Multimeter reading:18.02A

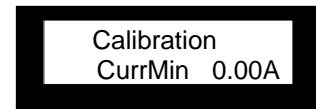

- Press the Vset/Iset/Enter key  to confirm the setting. The display enters Minimum Current calibration mode.



5. Adjust the display value to the Multimeter / Current Shunt reading.
Wheel knob  changes the value.
F/C key  moves the cursor before and after the decimal point.
6. Press the Vset/Iset/Enter key  to confirm the setting. The display goes back to the default calibration menu.
7. Save the result and exit the calibration mode (Save), OR Exit the calibration mode without saving the result (Exit).

Multimeter reading: 0.02A

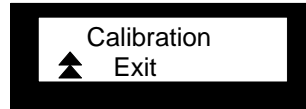
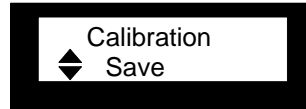
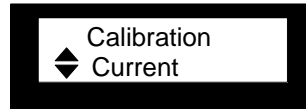
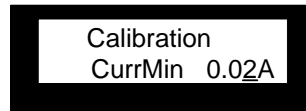

OVP Calibration

Connection

No connection required

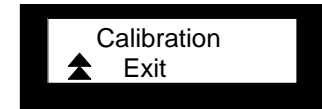
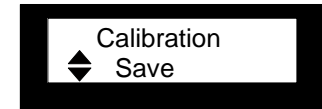
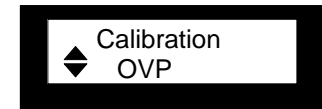
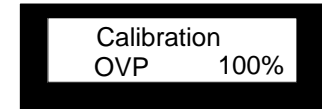
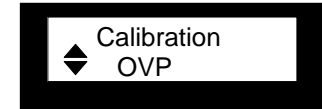

Calibration step

1. Enter the Voltage calibration menu. See page63 for details.
2. Press the Vset/Iset/Enter key  . PSH calibrates OVP automatically.
3. The display goes back to the default calibration menu.
4. Save the result and exit the calibration mode (Save), OR Exit the calibration mode without saving the result (Exit).



FAQ

The OVP value/ OCP status has not been changed.

After editing OVP value and OCP status, press
the Vset/Iset/Enter key   to confirm.
Otherwise the setting does not change.

The front panel does not respond.

When in remote control mode, PSH does not respond to panel operations. Terminate the remote operation or press the Local key  on the front panel. The “RMT” message disappears from the display and panel operation is resumed.

The actual output is lower than the setting.

The cable loss might be causing the load voltage lower than the setting. Upgrade the output cable to a better capacity and/or use the remote sense to compensate for the voltage drop. See page25 (theory) and page25 (cable assembly).

The actual output is much higher than the setting.

The remote sensing (page24) compensates for the cable loss for up to 0.5V. If the output level goes much higher, the remote sensing terminal might be disconnected. Make sure the connection is secure. See page32 for details.

The load wire does not fit into the terminal.

Make sure you are NOT connecting the load wire to the remote sensing terminal. Refer to page30 for connection details.

If there is still a problem, please contact your local dealer or GWInstek at www.gwinstek.com.tw / marketing@goodwill.com.tw.

Appendix

Specifications

The specifications apply under the following conditions: PSH is powered on for at least 30 minutes, within +20°C~+30°C.

Common specification

Recovery Time	CV mode	≤ 2ms (50% step load change from 25%~75%)
Response Time	Voltage Up	≤ 150ms (10%~90% ≤ 95% rating load)
	Voltage Down	≤ 150ms (90%~10% ≥ 10% rating load)
Ripple & Noise	Voltage (mVrms)	≤ 10mVrms, 100mVpp, 20Hz~20MHz
	Current (mArms)	≤ 0.2% + 40mA
Temperature Coefficient	Voltage (25±5°C)	≤ 100ppm/ °C
Protection	Over Voltage Protection, Over Current Protection, Over Heat Protection, Inrush Current Protection	
Output On/Off	Available	
AC Power Input	100~230V, 50/ 60 Hz	
Operation Condition	Location	Indoor
	Altitude	≤ 2000m
	Ambient temperature	Specification: 10°C~35°C (50°F~95°F) Operation: 0°C~40°C (32°F~104°F)
	Relative Humidity	85% RH (maximum), non condensing
	Installation	Category II (for details, see page6)
	Pollution	Degree 2 (for details, see page8)
Storage Condition	-10°C~70°C, 70% RH (maximum)	
Accessories	User manual, Programming manual, Cable gland, AC power cord, AC input cover, O/P terminal cover	

PSH-1036A/ 2018A/ 3610A/ 6006A

Output	PSH-1036A	10V, 36A
	PSH-2018A	20V, 18A
	PSH-3610A	36V, 10A
	PSH-6006A	60V, 6A
Regulation (C.V.)	Load	≤ 0.1% + 5mV
	Line	≤ 0.05% + 5mV
Regulation (C.C.)	Load	≤ 0.2% + 5mA
	Line	≤ 0.2% + 5mA
Ripple & Noise	Voltage (mVrms)	≤ 10mVrms, 100mVpp, 20Hz~20MHz
	Current (mArms)	≤ 0.2%
Program Accuracy	Voltage	≤ 0.05% + 25mV (rating ≤ 36V) ≤ 0.05% + 50mV (rating > 36V)
	OVP	≤ 0.1% + 50mV (rating ≤ 36V) ≤ 0.1% + 100mV (rating > 36V)
	Current	≤ 0.2% + 30mA
Program Resolution	Voltage & OVP	10mV (rating ≤ 36V) 20mV (rating > 36V)
	Current	10mA
Readback (Meter) Accuracy	Voltage	≤ 0.05% + 25mV (rating ≤ 36V) ≤ 0.05% + 50mV (rating > 36V)
	Current	≤ 0.2% + 30mA
Readback (Meter) Resolution	Voltage	10mV (rating ≤ 36V) 20mV (rating > 36V)
	Current	10mA
Fuse	6.3A/ 250V AC x 2	
Dimensions	108 x 141 x 388 mm	
Weight	Approx. 3.3kg	

PSH-1070A/ 2035A/ 3620A/ 6012A

Output	PSH-1070A	10V, 70A
	PSH-2035A	20V, 35A
	PSH-3620A	36V, 20A
	PSH-6012A	60V, 12A
Regulation (C.V.)	Load	$\leq 0.1\% + 5\text{mV}$
	Line	$\leq 0.05\% + 5\text{mV}$
Regulation (C.C.)	Load	$\leq 0.2\% + 10\text{mA}$
	Line	$\leq 0.2\% + 10\text{mA}$
Ripple & Noise	Voltage (mVrms)	$\leq 10\text{mVrms}, 100\text{mVpp}, 20\text{Hz}\sim 20\text{MHz}$
	Current (mArms)	$\leq 0.2\% + 20\text{mA}$
Program Accuracy	Voltage	$\leq 0.05\% + 25\text{mV}$ (rating $\leq 36\text{V}$)
		$\leq 0.05\% + 50\text{mV}$ (rating $> 36\text{V}$)
	OVP	$\leq 0.1\% + 50\text{mV}$ (rating $\leq 36\text{V}$)
		$\leq 0.1\% + 100\text{mV}$ (rating $> 36\text{V}$)
Current	$\leq 0.2\% + 60\text{mA}$ (rating $\leq 10\text{V}$)	
	$\leq 0.2\% + 30\text{mA}$ (rating $\leq 60\text{V}$)	
Program Resolution	Voltage & OVP	10mV (rating $\leq 36\text{V}$)
		20mV (rating $> 36\text{V}$)
	Current	20mA (rating $\leq 10\text{V}$) 10mA (rating $\leq 60\text{V}$)
Readback (Meter) Accuracy	Voltage	$\leq 0.05\% + 25\text{mV}$ (rating $\leq 36\text{V}$)
		$\leq 0.05\% + 50\text{mV}$ (rating $> 36\text{V}$)
Readback (Meter) Accuracy	Current	$\leq 0.2\% + 60\text{mA}$ (rating $\leq 10\text{V}$)
		$\leq 0.2\% + 30\text{mA}$ (rating $\leq 60\text{V}$)
Readback (Meter) Resolution	Voltage	10mV (rating $\leq 36\text{V}$)
		20mV (rating $> 36\text{V}$)
Readback (Meter) Resolution	Current	20mA (rating $\leq 10\text{V}$)
		10mA (rating $\leq 60\text{V}$)
Fuse	6.3A/ 250VAC x 2, 0.5A/ 250VAC x 1, 15A/ 250VAC x 1	
Dimensions	188 x 141 x 388 mm	
Weight	Approx. 6.2kg	

PSH-10100A/ 2050A/ 3630A/ 6018A

Output	PSH-10100A	10V, 100A
	PSH-2050A	20V, 50A
	PSH-3630A	36V, 30A
	PSH-6018A	60V, 18A
Regulation (C.V.)	Load	$\leq 0.1\% + 5\text{mV}$
	Line	$\leq 0.05\% + 5\text{mV}$
Regulation (C.C.)	Load	$\leq 0.2\% + 15\text{mA}$
	Line	$\leq 0.2\% + 15\text{mA}$
Ripple & Noise	Voltage (mVrms)	$\leq 10\text{mVrms}, 100\text{mVpp}, 20\text{Hz}\sim 20\text{MHz}$
	Current (mArms)	$\leq 0.2\% + 40\text{mA}$
Program Accuracy	Voltage	$\leq 0.05\% + 25\text{mV}$ (rating $\leq 36\text{V}$)
		$\leq 0.05\% + 50\text{mV}$ (rating $> 36\text{V}$)
	OVP	$\leq 0.1\% + 50\text{mV}$ (rating $\leq 36\text{V}$)
		$\leq 0.1\% + 100\text{mV}$ (rating $> 36\text{V}$)
Current	$\leq 0.2\% + 90\text{mA}$ (rating $\leq 10\text{V}$)	
	$\leq 0.2\% + 60\text{mA}$ (rating $\leq 20\text{V}$)	
$\leq 0.2\% + 30\text{mA}$ (rating $\leq 60\text{V}$)		
Program Resolution	Voltage & OVP	10mV (rating $\leq 36\text{V}$)
		20mV (rating $> 36\text{V}$)
	Current	30mA (rating $\leq 10\text{V}$) 20mA (rating $\leq 20\text{V}$) 10mA (rating $\leq 60\text{V}$)
Readback (Meter) Accuracy	Voltage	$\leq 0.05\% + 25\text{mV}$ (rating $\leq 36\text{V}$)
		$\leq 0.05\% + 50\text{mV}$ (rating $> 36\text{V}$)
Readback (Meter) Accuracy	Current	$\leq 0.2\% + 90\text{mA}$ (rating $\leq 10\text{V}$)
		$\leq 0.2\% + 60\text{mA}$ (rating $\leq 20\text{V}$)
$\leq 0.2\% + 30\text{mA}$ (rating $\leq 60\text{V}$)		
Readback (Meter) Resolution	Voltage	10mV (rating $\leq 36\text{V}$)
		20mV (rating $> 36\text{V}$)
Readback (Meter) Resolution	Current	30mA (rating $\leq 10\text{V}$)
		20mA (rating $\leq 20\text{V}$)
$\leq 0.2\% + 30\text{mA}$ (rating $\leq 60\text{V}$)		
Fuse	6.3A/ 250VAC x 3, 0.5A/ 250VAC x 1, 20A/ 250VAC x 1	
Dimensions	268 x 141 x 388 mm	
Weight	Approx. 9.3kg	

Declaration of Conformity

We
GOOD WILL INSTRUMENT CO., LTD.
 (1) No.7-1, Jhongsing Rd., Tucheng City, Taipei County, Taiwan
 (2) No. 69, Lu San Road, Suzhou City (Xin Qu), Jiangsu Sheng, China
 declare, that the below mentioned product
Type of Product: Power Supply
Model Number:
PSH-1036A/ 2018A/ 3610A/ 6006A
PSH-1070A/ 2035A/ 3620A/ 6012A
PSH-10100A/ 2050A/ 3630A/ 6018A
 are herewith confirmed to comply with the requirements set out in the Council Directive on the Approximation of the Law of Member States relating to Electromagnetic Compatibility (89/336/EEC, 92/31/EEC, 93/68/EEC) and Low Voltage Directive (73/23/EEC, 93/68/EEC).
 For the evaluation regarding the Electromagnetic Compatibility and Low Voltage Directive, the following standards were applied:

© **EMC**

EN 61326-1: Electrical equipment for measurement, control and laboratory use — EMC requirements (1997 + A1:1998 + A2:2001 + A3:2003)	
Conducted Emission	Electrostatic Discharge
Radiated Emission	EN 61000-4-2: 1995 + A1:1998 + A2:2001
EN 55011: Class A 1998 + A1:1999 + A2:2002	
Current Harmonics	Radiated Immunity
EN 61000-3-2: 2000 + A2:2005	EN 61000-4-3: 2002 + A1:2002
Voltage Fluctuations	Electrical Fast Transients
EN 61000-3-3: 1995 + A1:2001	EN 61000-4-4: 2004
-----	Surge Immunity
-----	EN 61000-4-5: 1995 + A1:2001
-----	Conducted Susceptibility
-----	EN 61000-4-6: 1996 + A1:2001
-----	Power Frequency Magnetic Field
-----	EN 61000-4-8: 1993 + A1:2001
-----	Voltage Dip/ Interruption
-----	EN 61000-4-11: 2004

© **Safety**

Low Voltage Equipment Directive 73/23/EEC
Safety Requirements
IEC/EN 61010-1: 2001

Index

A

AC input

cable assembly..... 22
 cord requirement..... 23
 terminal..... 18

C

calibration

certificate..... 15

CC

characteristic..... 45

cleaning PSH 5, 7

current

OCP setting 49
 output setting..... 47

CV

characteristic..... 45

D

display

contrast setting 50
 default mode..... 19
 fine/coarse..... 17
 menu mode20, 44
 output On/Off 16
 remote control mode..... 17

E

EN 55011 75
 EN 61000 75
 EN 610106, 8, 75

F

faq 69
 feature list 12

front panel..... 16
 faq 69

functionality check

OCP 38
 output current 37
 output voltage..... 35
 OVP 35
 setup 34

fuse

rating 7, 72, 73, 74
 safety instruction..... 7

G

GPIB

interface setting..... 55

I

IEEE remote control

general commands..... 58
 miscellaneous commands 60
 status commands 59
 syntax 57

O

OCP

check 38

operation environment

safety instruction..... 5, 8

output

cable assembly..... 30
 cable selection..... 25
 current check 37
 current setting..... 47
 faq 69
 load configuration..... 26
 terminal 18

