

CONTENTS	PAGE
<u>1. PRODUCT INTRODUCTION</u>	1
<u>1-1. DESCRIPTION</u>	1
<u>1-2. FEATURE</u>	2
<u>2. TECHNICAL SPECIFICATIONS</u>	3
<u>3. PRECAUTIONS BEFORE OPERATION</u>	6
<u>3-1. UNPACKING THE INSTRUMENT</u>	6
<u>3-2. CHECKING THE LINE VOLTAGE</u>	6
<u>3-3. ENVIRONMENT</u>	7
<u>4. PANEL INTRODUCTION</u>	8
<u>4-1. FRONT PANEL</u>	8
<u>4-2. REAR PANEL BRIEF</u>	10
<u>4-3. DISPLAY BRIEF</u>	11
<u>5. OPERATION INSTRUCTION</u>	15
<u>5-1. BASIC OPERATION</u>	15
<u>5-2. FUNCTION KEY DESCRIPTION</u>	16
<u>5-3. OPERATION METHOD</u>	33
<u>5-4. THE MAXIMUM VALUE OF THE OUTPUT SETTING</u>	43
<u>5-5. TEST LEAD</u>	44

<u>6. MAINTENANCE</u>	45
<u>6-1. FUSE REPLACEMENT</u>	45
<u>6-2. LINE VOLTAGE CONVERSION</u>	45
<u>6-3. MEASUREMENT TECHNIQUES</u>	46
<u>6-4. ADJUSTMENT AND CALIBRATION</u>	49
<u>6-5. CLEANING</u>	54
<u>7. THE SYSTEM DIAGRAM AND DESCRIPTION</u>	55
<u>7-1. BLOCK DIAGRAM</u>	55
<u>7-2. THE CONFIGURATION OF BLOCK SYSTEM</u>	56

SAFETY TERMS AND SYMBOLS

These terms may appear in this manual or on the product:



WARNING. Warning statements identify condition or practices that could result in injury or loss of life.



CAUTION. Caution statements identify conditions or practices that could result in damage to this product or other property.

The following symbols may appear in this manual or on the product:



DANGER
High Voltage



ATTENTION
refer to Manual



Protective
Conductor
Terminal



Earth (ground)
Terminal



Frame or Chassis
Terminal

FOR UNITED KINGDOM ONLY

NOTE: This lead/appliance must only be wired by competent persons

WARNING: THIS APPLIANCE MUST BE EARTHED

IMPORTANT: The wires in this lead are coloured in accordance with the following code:

Green/ Yellow:	Earth
Blue:	Neutral
Brown:	Live (Phase)

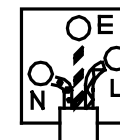

As the colours of the wires in main leads may not correspond with the colours marking identified in your plug/appliance, proceed as follows:

The wire which is coloured Green & Yellow must be connected to the

Earth terminal marked with the letter E or by the earth symbol  or coloured Green or Green & Yellow.

The wire which is coloured Blue must be connected to the terminal which is marked with the letter N or coloured Blue or Black.

The wire which is coloured Brown must be connected to the terminal marked with the letter L or P or coloured Brown or Red.

If in doubt, consult the instructions provided with the equipment or contact the supplier.

This cable/appliance should be protected by a suitably rated and approved HBC mains fuse: refer to the rating information on the equipment and/or user instructions for details. As a guide, cable of 0.75mm² should be protected by a 3A or 5A fuse. Larger conductors would normally require 13A types, depending on the connection method used.

Any moulded mains connector that requires removal /replacement must be destroyed by removal of any fuse & fuse carrier and disposed of immediately, as a plug with bared wires is hazardous if engaged in live socket. Any re-wiring must be carried out in accordance with the information detailed on this label.

Declaration of Conformity

We

GOOD WILL INSTRUMENT CO., LTD.

No. 7-1, Jhongsing Rd., Tucheng City, Taipei County 236, Taiwan

GOOD WILL INSTRUMENT (SUZHOU) CO., LTD.

No. 69 Lushan Road, Suzhou New District Jiangsu, China.

declare that the below mentioned product

PSM-3004/6003/2010

are herewith confirmed to comply with the requirements set out in the Council Directive on the Approximation of the Law of Member States relating to Electromagnetic Compatibility (89/336/EEC, 92/31/EEC, 93/68/EEC) and Low Voltage Equipment Directive (73/23/EEC, 93/68/EEC).

For the evaluation regarding the Electromagnetic Compatibility and Low Voltage Equipment Directive, the following standards were applied:

© EMC

EN 61326-1: Electrical equipment for measurement, control and laboratory use — EMC requirements (1997+A1: 1998+A2:2001)

Conducted and Radiated Emissions EN 55011: 1998	Electrostatic Discharge EN 61000-4-2: 1995+A1:1998+A2:2001
Current Harmonic EN 61000-3-2: 2000	Radiated Immunity EN 61000-4-3: 1996+A1:1998+A2 :2001
Voltage Fluctuation EN 61000-3-3: 1995+A1:2001	Electrical Fast Transients EN 61000-4-4: 1995+A2:2001
-----	Surge Immunity EN 61000-4-5: 1995+A1:2001
-----	Conducted Susceptibility EN 61000-4-6: 1996+A1:2001
-----	Power Frequency Magnetic Field EN61000-4-8 :1993+A1:2001
-----	Voltage Dips/ Interrupts EN 61000-4-11: 1994+A1:2001

© Safety

Low Voltage Equipment Directive 73/23/EEC & amended by 93/68/EEC

IEC/EN 61010-1: 2001

1. PRODUCT INTRODUCTION

1-1. Description

PSM-series Programmable Power Supply is controlled by Micro Processor Unit (MPU) with extreme high accuracy of 200W maximum, and the single output with double range (switching between the main panel and communication interface) that can easily connect communication interface RS-232 or GPIB to computer in order to satisfy users' demand for auto-testing and auto-control. The software commands are fully complied with the SCPI format, it's convenient for user to proceed auto-tested and auto-controlled application program.

The voltage and current are completely controlled by 16 bits D/A Converter with higher resolution and accuracy. Also, the digitalization of system makes a speedy, precise and convenient input of information controlled by keyboard.

The adjustment of voltage/current is made by software calibration without manual error that will increase the preciseness of the instrument.

The function of Over Voltage Protection (OVP) and Over Current Protection (OCP) is set with software and detected with hardware to achieve protected function precisely and speedily in order to secure users from danger by using the instrument.

If need further technique support or update information, please enter our web-side: <http://www.goodwill.com.tw>

1-2. Feature

- 1) An overall digitalization of programmable interface with high resolution and accuracy.
- 2) High stability and low draft.
- 3) Excellent contrast and brightest VFD display.
- 4) Single output and double range.
- 5) Constant voltage/current operation.
- 6) Low ripple and noise.
- 7) The convenient and high efficiency operation of setting interface.
- 8) Wheel knob for Fine and Coarse adjustment and item selection.
- 9) Both front and rear panels are equipped with Remote voltage sensing.
- 10) The protection function of output ON/OFF and Over Voltage/Current/Temperature protection.
- 11) Intelligent control fan (Vary with different output power).
- 12) Warning signal by the built-in Buzzer.
- 13) A programmed calibration procedure.
- 14) The brand new panel design and the 1/2 rack size reduction volume design.
- 15) Save and Recall function of 100 groups setting and proceed together with auto operation can achieve the purpose of auto test.
- 16) IEEE-488.2 and SCPI compatible command setting.
- 17) Correspond to many safety regulations.

2. TECHNICAL SPECIFICATIONS

Specification		PSM-2010	PSM-3004	PSM-6003
DC Output	Low Range	0~ +8V / 0~20A	0~ +15V / 0~ 7A	0~ +30V / 0~6A
	High Range	0~ +20V/0~ 10A	0~ +30V/0~4A	0~ +60V/0~3.3A
Constant Voltage Operation	Regulation (% output + offset)	Load regulation $\leq 0.01\% + 2\text{mV}$ Line regulation $\leq 0.01\% + 2\text{mV}$		
	Ripple & Noise	<350uVrms/ 3mVpp	<350uVrms/ 2mVpp	<500uVrms/ 3mVpp, <1mVrms/ 3mVpp (Rating voltage >50V)
Constant Current Operation	Regulation (% output + offset)	Load regulation $\leq 0.01\% + 250\text{uA}$ Line regulation $\leq 0.01\% + 250\text{uA}$		
	Ripple & Noise	2mArms		
Resolution				
Programming	Voltage	1mV	1mV	2mV
	Current	1mA	0.5mA	0.5mA
Readback	Voltage	0.5mV	0.5mV	1mV
	Current	1mA	0.1mA	0.5mA
Front Panel	Voltage	1mV		
	Current	1mA(<10A),10mA($\geq 10\text{A}$)		
OVP		10mV		
OCP		10mA		

Specification		PSM-2010	PSM-3004	PSM-6003			
Accuracy							
Programming (@23°C±5°C), ±(% output + offset)	Voltage	0.05% + 10mV					
	Current	0.2% + 10mA					
Readback (@23 °C ±5 °C), ±(% output + offset)	Voltage	0.05% + 5mV					
	Current	0.15% + 5mA					
OVP/OCP Accuracy, ±(% output + offset)	Voltage	0.1% + 10mV					
	Current	0.4% + 10mA					
Interface Command proceeding time (The average proceeding time during receiving GPIB or RS-232 command until voltage output)		100ms					
Voltage Setting Response Time (Resistor Load)	Load	Full Load	No Load	Full Load	No Load	Full Load	No Load
	Rise	95ms	45ms	50ms	20ms	80ms	100ms
	Fall	30ms	450ms	45ms	400ms	30ms	450ms
Stability ±(% of output + offset): Following 1 hour warm-up, the output level drift after 8 hours test under a fixed load, test lead and ambient temperature.							

Specification	PSM-2010	PSM-3004	PSM-6003
Voltage	0.02% + 1mV		
Current	0.1% + 1mA		
Memory	Store/Recall points 0~99		
Temperature Coefficient per °C ±(% of output + offset) : Maximum change in output / readback per °C after 30-minute warm-up.			
Voltage	0.01% + 3mV		
Current	0.02% + 3mA		
AC Input	100VAC, 120VAC, 220VAC ±10%, 230VAC, -6%+10%, 50/60Hz		
Input Rating	700VA, 380W	300VA, 220W	600VA, 310W
Interface	RS-232, GPIB		
Accessories (1)	Power cord ×1, Instruction manual×1, Programmer Manual×1		
Accessories (2)	Type	Common terminal	CE Safety terminal
	Item		
	Test Lead	1	1 set
	Sense Lead	0	1 set
	Grounding Lead	0	1
	Short bar A on Front panel	3	0
Short bar B on Rear panel	3	3	
Operation Environmental	Indoor use Altitude up to 2000 m Ambient temperature: To satisfy specifications : 10°C ~ 35°C (50° F ~ 95°F) Maximum operating ranges: 0°C ~ 40°C (32°F ~ 104°F) Relative humidity: 85% RH (max.) non condensing Pollution degree: 2		
Storage Temperature & Humidity	-10°C to 70°C, 70%RH (maximum)		
Dimensions & Weight	230(W)×140(H)×380(L) mm. Approx. 10kg.		

3. PRECAUTIONS BEFORE OPERATION

3-1. Unpacking the Instrument

The product has been fully inspected and tested before shipping from the factory. Upon receiving the instrument, please unpack and inspect it to check if there is any damage caused during transportation. If any sign of damage is found, notify the bearer and/or the dealer immediately.

3-2. Checking the Line Voltage

The product can be applied by any kind of line voltages shown in the table below. Before connecting the power plug to an AC line outlet, make sure the voltage selector of the rear panel is set to the correct position corresponding to the line voltage. It might be damaged the instrument by connecting to the wrong AC line voltage.



WARNING. To avoid electrical shock the power cord protective grounding conductor must be connected to ground.

When line voltages are changed, replace the required fuses shown as below:

Model	Line voltage	Range	Fuse	Line voltage	Range	Fuse
PSM-2010			T 7A 250V			T3.15A 250V
PSM-3004	100V 120V	90-110V 108-132V	T3.15A 250V	220V 230V	198-242V 216-250V	T 1.6A 250V
PSM-6003			T 5A 250V			T2.5A 250V



WARNING. To avoid personal injury, disconnect the power cord before removing the fuse holder.

3-3. Environment

The normal ambient temperature range of this instrument is from 0° to 40°C (32° to 104°F). To operate the instrument exceeding this specific temperature range may cause damage to the circuits of instrument.

Do not use the instrument in a place where strong magnetic or electric field exists as it may disturb the measurement.



CAUTION. To avoid damaging the instrument, do not use it in a place where ambient temperature exceeds 40°C .

4. PANEL INTRODUCTION

4-1. Front Panel

1.	Power Switch	Connect the AC power, then press ON/OFF power switch.
2.	Display	Indicate the setting of voltage/current value, output voltage/current value and the status of setting and output.
3.	+Output Terminal	Positive output terminal.
	S+ Output Terminal	Positive sampling terminal.
4.	-Output Terminal	Negative output terminal.
	S- Output Terminal	Negative sampling terminal.
5.	GND Terminal	Connect the ground terminal to chassis.
6.	Rotary Encoder	Wheel knob.
7.	< >	Cursor (for value input).
8.	LOCK	A software to lock up panel setting (keep pressing for a few second).
9.	V SET	Output voltage setting.
10.	I SET	Output current setting.
11.	OVP SET	Over Voltage protection value setting. (Level, ON/OFF, Clear)
12.	OCP SET	Over Current Protection value setting. (Level, ON/OFF, Clear, DELAY)
13.	20V, 10A/8V,20A	Select output voltage /current range (The secondary function key).
1	RECALL ↑	Recall last group of data setting.
		Warning. When query the memory setting data, in order to avoid personal injury and damaging the machine, it is suggested to disconnect the output.
	RECALL ↓	Recall next group of data setting.

15.	DELAY	Set the voltage and current output time in the automatic operation mode.
16.	AUTO RANGE (AUTO INFO)	Proceed setting step by step. During setting proceeding, press this key can display the memory address of the setting and its residual time and period (The secondary function key).
17.	AUTO	Turn ON/OFF the auto operation.
18.	RECALL	Recall one of the memory datas (The secondary function key). When query the memory setting data, in order to avoid personal injury and damaging the machine, it is suggested to disconnect the output.
19.	STORE	Store the data to one of the memory groups (The secondary function key).
20.	SHIFT	Select the secondary function key.
21.	“0”, “1” ... “9”, “.”	The key for number input.
22.	ENTER	The key for Input confirmation.
23.	LOCAL	Clear the remote control mode by using the panel control setting instead.
24.	GPIB/RS-232	Select GPIB or RS-232 by pressing [SHIFT] [GPIB/RS-232].
25.	V STEP	Voltage Step setting (The secondary function key).
	I STEP	Current Step setting (The secondary function key).
26.	I△	Under the status of [SHIFT], press I△ to ascend one step of output current value.
	I▽	Under the status of [SHIFT], press I▽ to descend one step of output current value.
	V△	Under the status of [SHIFT], press V△ to ascend one step of output voltage value.
	V▽	Under the status of [SHIFT], press V▽ to descend one step of output voltage value.

27.	FL DIMMER	Adjust the intensity of VFD. After pressing [SHIFT], can press [FL DIMMER] continually until the required brightness is reached. Then press again the [SHIFT] to end the setting.
28.	•))	Set beeper by pressing [SHIFT][•))] to turn ON/OFF the buzzer.
29.	OUTPUT	Turn on or off output by pressing the knob.
30.	DISPLAY LIMIT	Switch over the voltage and current mode by pressing [DISPLAY LIMIT]. The setting value will be displayed, press again [DISPLAY LIMIT] or wait a few seconds to return to the previous status.

4-2. Rear Panel brief

1.	AC Power Socket	AC power input terminal.
2.	AC Select Switch	Switch Voltage to 100V, 120V, 220V or 230V, 50/60Hz.
3.	Cooling Fan	A cooling fan.
4.	Interface	GPIB or RS-232 communication interface.
5.	Output Terminal	The output terminals of rear panel connected with case, including output sampling terminal and ground terminal.

4-3. Display brief

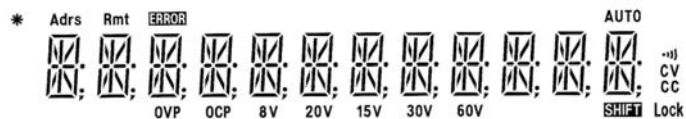

1.	Adrs	Set the power supply to the address of Listen or Talk by using the interface card.
2.	Rmt	Set the power supply to Remote Control mode.
3.	ERROR	The Error message appears when the command from the Remote Controlled Interface is in error.
4.	SHIFT	Select the second level function.
5.	AUTO	Set the power supply to Auto mode.
6.	8V, 15V, 20V, 30V, 60V	The output ranges of power supply.
7.	OVP	When the indicator lights up without blinking, means the OVP function is on. When the Over Voltage Protection function is triggered, the indicator will be changed to blinking status, and the message “OVP TRIPPED” will be displayed. Now clear the OVP function. When the light of indicator is off, means the OVP function is off.
8.	OCP	When the indicator lights up without blinking, means the OCP function is on. When the Over Current Protection function is triggered, the indicator will be changed to blinking status, and the message “OCP TRIPPED” will be displayed. Now clear the OCP function. When the light of indicator is off, means the OCP function is off.

9.	*	When the power supply is set to operation mode, the symbol of “*” will be lighted up. ● When the Output is on, the symbol of “*” lights up to indicate the power supply is in the operation mode, when the meter displays the measurement value, the symbol of “*” becomes blinking.
10.	CC	The CC light is on to indicate the instrument is in the CC mode.
11.	CV	The CV light is on to indicate the instrument is in the CV mode.
12.	•)))	The light of “•)))” is on to indicate the buzzer is on.
13.	Lock	The Lock light is on to indicate the panel control knobs is locked up.

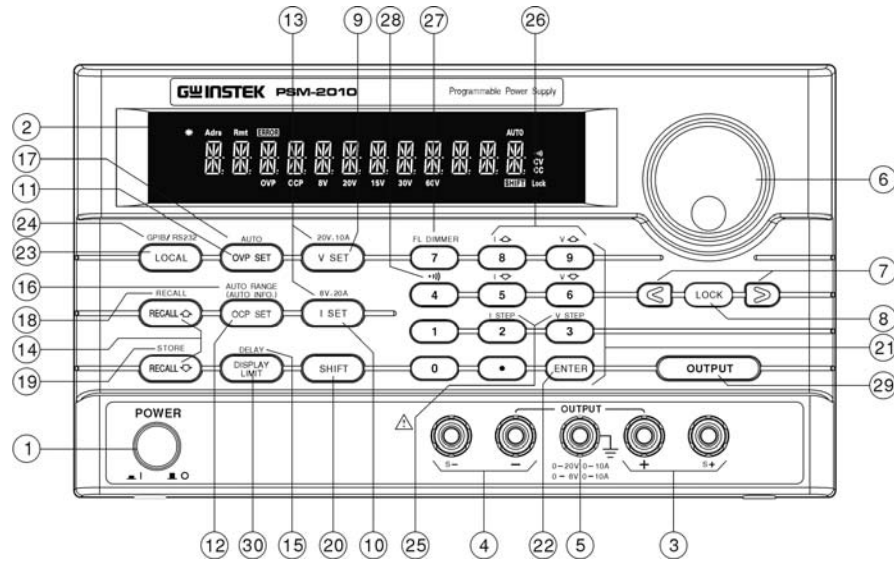

Figure 4-1 Front Panel

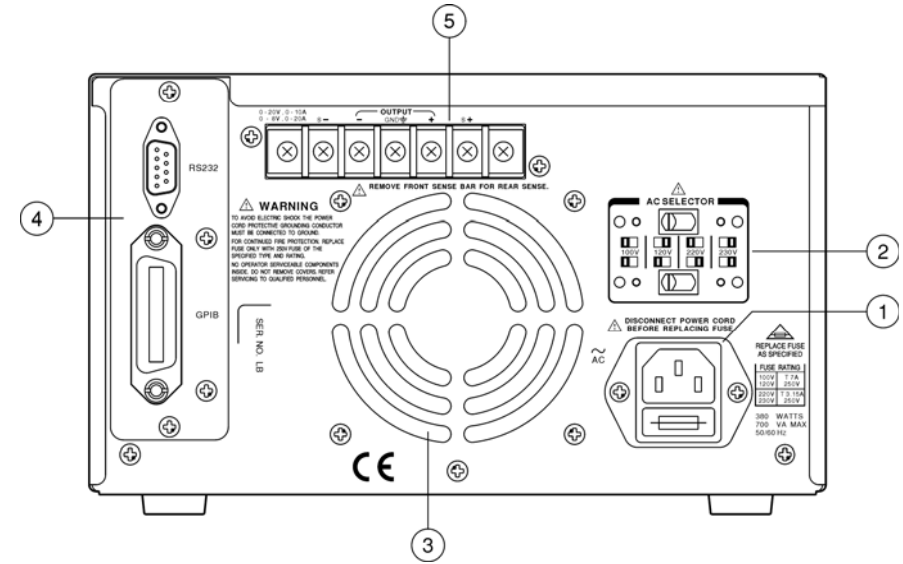

Figure 4-2 Rear Panel

5. OPERATION INSTRUCTION

5-1. Basic Operation

- The applied Voltage/Current Unit for this series instruments is Volt and Amp.
- The Instrument requires 30 minutes warm-up with no load before operation or calibration to achieve rated accuracy.
- The Factory setting is in panel operation mode that enable user to operate the instruments directly from panel control knob. Besides, when the remote controller is on line, the operation can only be proceed through it, unless the LOCAL key is pressed, at this time, the OUTPUT is still working. Whenever the power is reset, the output will be at OFF status and the operation is through front panel operation mode.
- The series of power supplies have double output ranges, after power on, the output is always at OFF status, and the setting is stayed at the previous setting status before power off.
- Whatever the output is at ON or OFF, the output range can be switched dynamically. During the switch process, if the original setting value is more than the maximum output range after switch, the setting value will be modified automatically to the maximum output value after switch.
- A short plate is attached to the sampling terminal of the front panel, when use the remote sense, the short plate must be removed.

- When the output is set to OFF, the OUTPUT OFF message will be displayed on the front panel, the setting still can be modified. At the same time of modification, the corresponding setting item or status will be displayed. When the output is set to ON, the setting can also be modified. At the same time of the modification, the panel display mode is changed from measurement value to the setting item or status. Under the normal setting of voltage or current, the panel will display measurement value, if want to change the displayed mode to setting value, press [SHIFT][DISPLAY LIMIT] to input setting value, after a few seconds, if no value is input, the display mode will be switched to measurement value automatically.
- When set output on, the symbol of “*” will be appeared on the upper left of meter to indicate the instrument is at output mode. when the meter displays output measurement value(at measuring status), the symbol of “*” becomes blinking.

5-2. Function Key Description

Press one of the function keys to proceed function setting, after setting, press again the function key to leave the function or press another key for another setting.

- **V SET : Output voltage setting**



The minimum resolution of output voltage is at 1mV. When set output to ON, press [V SET] to proceed voltage setting, now the meter will display measurement value (the symbol of “*” is blinking). Besides, when the operation is set to “DISPLAY LIMIT” mode, the meter will display setting value (the symbol of “*” lights up without blinking). When the output is set to OFF, the output voltage setting (V SET) can be done by pressing [V SET] directly or by changing the “DISPLAY LIMIT” mode (please refer to the operation of DISPLAY LIMIT).

Setting method 1: Press [V SET][Number key (voltage value)] [ENTER] to set output voltage.

Setting method 2: Press [V SET][number knob (voltage value)] to change the output voltage setting immediately, then press again [V SET] to complete voltage setting. When use this method with the output on, the input voltage will be changed following the input value by rotating the knob which can be adjusted by moving the [<] or [>] cursor.

For example: Set output voltage to 8.000V.

Press [V SET][8][.][0][0][0][ENTER] or [V SET][8][ENTER].

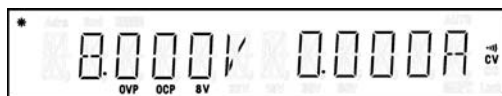

● I SET : Output current setting



The minimum resolution of output current is at 1mA (output $\geq 10A$ at 10mA). When set output to ON, press [I SET] to proceed current setting, the meter will display measurement value (the symbol of “*” is on with blinking). Besides, when the operation is set to “DISPLAY LIMIT” mode, the meter will display setting value (now the symbol of “*” is on without blinking). When the output is set to OFF, the output current setting can be done by pressing [I SET] directly or by changing the “DISPLAY LIMIT” mode (please refer to the operation of DISPLAY LIMIT).

Setting method 1: Press [I SET][Number key (current value)] [ENTER] to set output current.

Setting method 2: Press [I SET][number knob (voltage value)] to change the output current setting immediately, then press again [I SET] to complete current setting. ° When use this method with the output on, the input current will be changed following the input value by rotating the knob which can be adjusted by moving the [<] or [>] cursor.

For example: Set output voltage to 20.00A

Press [I SET][2][0][.][0][0][ENTER] or [I SET][2][0][ENTER]



When the current load runs through output terminal, if the current exceeds the setting value, the operation of the instrument will be set to Constant Current Mode (C. C. Mode), if the current does not exceed the setting value, the operation will be set to Constant Voltage mode (C. V. Mode).

- **OVP SET: Over Voltage protection setting (LEVEL, ON/OFF /CLEAR)**

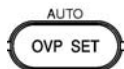

Setting method: After pressing [OVP SET], get into Over Voltage Protection Level setting, now use the number key (or knob) to input setting value, then press [ENTER] to complete the setting change.

When get into Over Voltage protection state setting by selecting Over Voltage protection state and pressing [ENTER], use the knob to select ON/OFF/CLEAR, then press [ENTER] to complete the setting change.

Remark: When the Over Voltage protection of the instrument is triggered, use the function of Over Voltage Protection Clear (OVP CLEAR) to clear its protection state.

For example: Set Over Voltage protection value to 21.00V at ON state. After pressing [OVP SET] to get into OVP LEVEL setting, then input [2][1][.][0][0][ENTER] to get into OVP STATE setting, now set the knob select state to ON and press [ENTER] to complete setting.

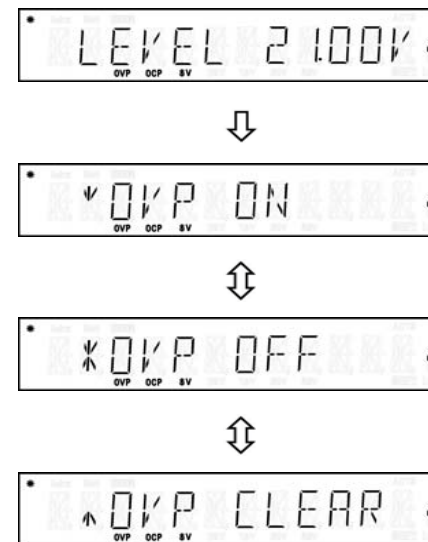

- **OCP SET: Over current protection setting (LEVEL, ON/OFF/ CLEAR, DELAY)**



Setting method: After pressing [OCP SET] to get into Over Current Protection Level (OCP LEVEL) setting, use the number key (or knob) to input setting value and press [ENTER] to complete the setting change.

When get into over current protection state, use the knob to select ON/OFF/CLEAR, then press [ENTER] to change the setting.

When the Over Current Protection is set to ON, then get into Over Current Protection Delay setting (The minimum Delay time is at 0 second, the maximum is at 10second, and the scale base is 0.1 second).

● **OCP DELAY TIME CHART**

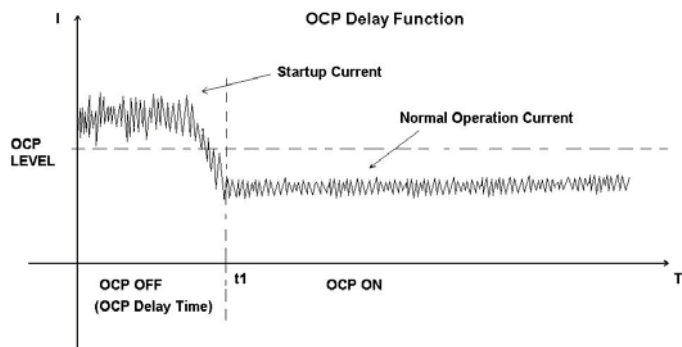

Remark: When the over current protection of the instrument is triggered, use the function ++of Over Current Protection Clear (OCP CLEAR) to clear its protection state.

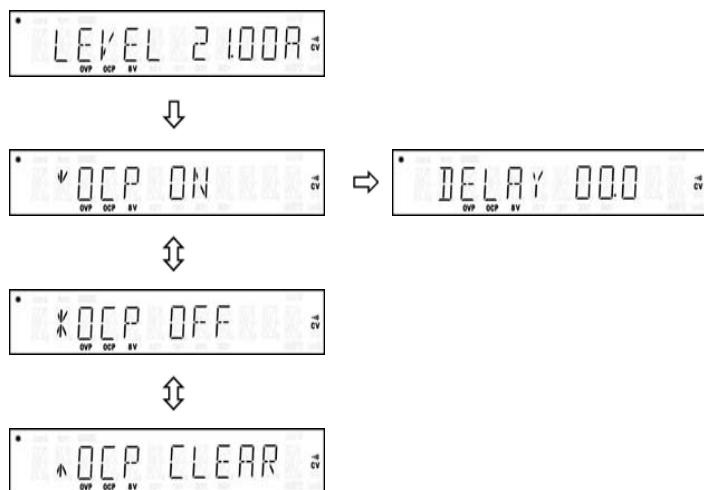

For example: Set over current protection value to 21.00A at ON state. After pressing [OCP SET], get into OCP LEVEL setting, input [2][1][.][0][0][ENTER], now set the knob select state to ON and press [ENTER] to complete setting.

● **Output voltage/current selection**



When re-power on, the output range is stayed at the previous setting before power off. Besides, whatever the output is at ON or OFF status, the output range can be switched over dynamically. When the setting value is more than the value of the switched voltage/current range, it will be modified to maximum value of the switched range automatically. If the setting value is less than the value of the switched voltage/current range, it will be stayed as it is.

- PSM-2010 : 20V,10A/8V,20A
- PSM-3004 : 30V,4A/15V,7A
- PSM-6003 : 60V,3.3A/30V,6A

For example: Set output range of PSM-2010 to 20V, 10A
 Press [SHIFT][20V,10A], the output range will be changed to 20V,10A.

● **DELAY** : The Auto mode setting for the voltage/current Delay time



Setting method: Press [SHIFT] [DELAY] to appear the “MIN.” setting item selection, then input setting value and press [ENTER] to “SEC.” setting item selection, input setting value and press [ENTER] to change Delay setting.

Remark:

- 1) **The minimum unit of the “SEC.” Setting picture is at 0.1 sec.**
- 2) **The Delay setting is effective only under the Auto running operation, therefore, during the storage proceeding, the Delay setting will be saved to the memory address simultaneously.**

For example: Set the Delay time to 9 minutes and 9.9 seconds.

Press [SHIFT] [DELAY] to appear “MIN” setting item, input [9] and [ENTER], then select “SEC” setting item and input [9][.][9][ENTER] to complete DELAY setting.

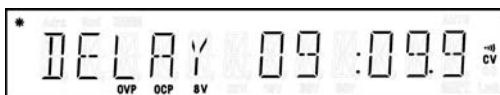

● **RECALL** : Recall the setting data from the memory bank



Remark:

- 1) **After RECALL setting, it needs to press again [SHIFT] [RECALL] to leave the function.**
- 2) **When query the stored setting data, in order to avoid personal injury and damaging the machine, it is suggested to turn off the output.**

Recall Setting method: Press [SHIFT][RECALL](Recall Data setting from the memory bank), use knob or number key to input the memory address.

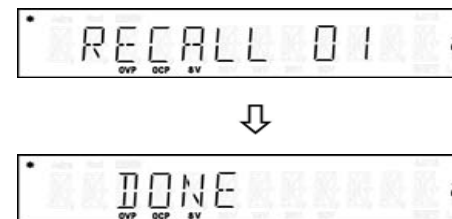

For example: Recall the setting data from the memory address of 01. Press [SHIFT][RECALL], get into RECALL setting, then press [0][1][ENTER] to complete Recall.

● AUTO RANGE

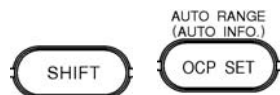

AUTO RANGE Setting method: Press [SHIFT][AUTO RANGE] , use knob to select the item for setting change.

For example: Set the AUTO RANGE to: START : 00 ; CEASE : 99 ; CYCLE : 99999 ◦

Press [SHIFT][AOTU RANGE] to enter AUTO RANGE setting item selection, first select START and press [ENTER], then input [0][0][ENTER] to complete the change. Then input [9][9][ENTER] to CEASE setting item to complete CEASE setting. Furthermore, input [9][9][9][9][9][ENTER] to CYCLE setting item to complete CYCLE setting. After proceeding above setting, select SAVE to store the setting or select EXIT to exit the setting without storing.

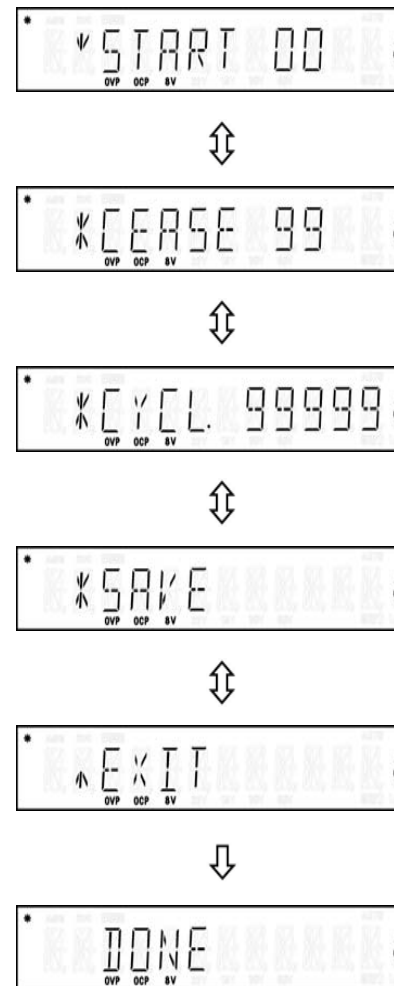

● **STORE : Save the setting data to one of the memory groups**



STORE setting method: Press the function of [STORE], use knob or number key to input the memory address to save the data.

For example: Store the setting date to the memory address of 01.

Press [SHIFT][STORE] to get into STORE setting, then input [0][1][ENTER] to complete the Store.

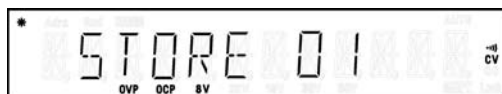

● **Rotary Encoder : The wheel knob for number input or function selection.**

The function knob can be used for number input or function selection. When the knob is used as number input, it should be matched with the cursor moving keys [<] and [>].

- **[<] and [>]:** [<] and [>] are cursor moving keys for number input or function selection.
- **LOCAL(GPIB/RS-232) :** Clear the Remote Control mode and use the panel control mode instead. Press [SHIFT][GPIB/RS-232] to GPIB or RS-232 setting selection.



Press [LOCAL] function can clear Remote Control mode and use panel control instead. After press [SHIFT][GPIB/RS-232], use knob to select GPIB or RS-232 and press [ENTER] to confirm the setting. If want to set to GPIB, use knob to select input address, then press [ENTER] to complete GPIB setting. If want to set to RS-232, use knob to select input BAUD rate, then press [ENTER] to complete RS-232 setting.

Remark: When enter GPIB/RS-232 setting, can press again [SHIFT] [GPIB/RS-232] to leave the function.

For example: Select GPIB communication interface and set the ADDRESS to 08.

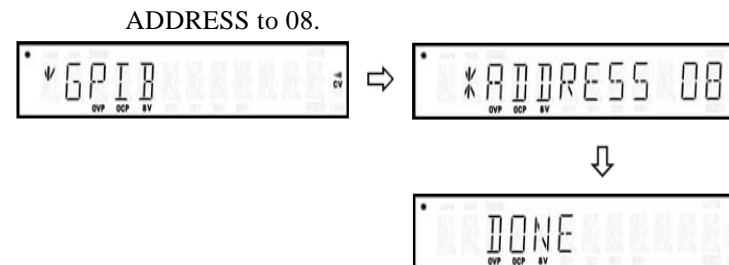

Press [SHIFT] [GPIB/RS-232], use wheel knob to select GPIB and press [ENTER] to confirm the setting. Then use wheel knob to select [08] and press [ENTER] to complete GPIB setting.

For example: Select RS-232 communication interface and set the BAUD rate to 9600.

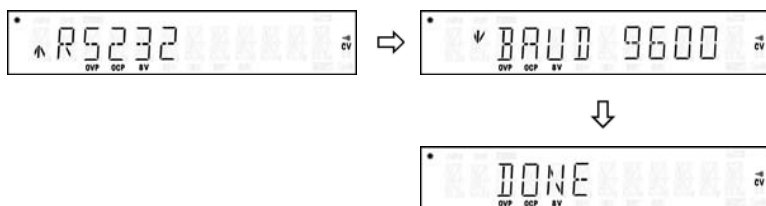

Press [SHIFT] [GPIB/RS-232], use wheel knob to select RS-232 and press [ENTER] to confirm the setting. Then use wheel knob to select [9600] and press [ENTER] to complete RS-232 setting.

- **ENTER : The key for input confirmation.**



- **SHIFT : The push-button to select the second level function.**



- **OUTPUT : Turn on/off the output**



When the output is set to OFF, the OUTPUT OFF message will be displayed on the front panel, and the CC and CV indicators are off, but the rest of indicators keep at the original setting. When Output is on, the symbol of “*” at the upper left corner of the panel will be on to indicate the power supply is in the output mode, when the meter displays the measurement value, the symbol of “*” becomes blinking (the symbol of “*” is on without blinking when the display other than the measurement value). When the instrument is operated in the CV mode, the CV indicator is on, while in the CC mode, the CC indicator is on.



- **LOCK : The key to lock up panel setting.**



Press the LOCK key to lock up the panel setting, now, the Output key is still working. Press the key again for several seconds to unlock the panel setting.

- **V STEP : The step setting of voltage.**



Set the maximum value of Step to be the rating value of the setting range. Switch to “V STEP” by pressing [SHIFT][V STEP], use number key (or knob) to input setting value, then press [ENTER] to complete and store the voltage step setting.

For example: Set the “V STEP” to 1.000V.

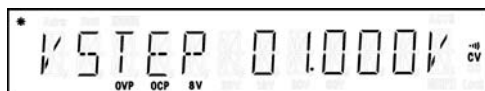

Press [SHIFT] [V STEP], then input [1][.][0][0][0][ENTER] to complete and store the voltage step setting.

- **I STEP : The step setting of current.**



Set the maximum value of Step to be the rating value of the setting range. Switch to “I STEP” by pressing [SHIFT][I STEP], use number key (or knob) to input setting value, then press [ENTER] to complete and store the current step setting.

For example: Set the “I STEP” to 1.000A.



Press [SHIFT] [I STEP], then input [1][.][0][0][0][ENTER] to complete and store the current step setting.

- **DISPLAY LIMIT : Switch panel display to the voltage/current setting mode.**



Display the present voltage and current value, this function can be operated both on Output on and off.

Switch to the voltage/current setting mode by pressing [DISPLAY LIMIT], then press again [DISPLAY LIMIT] for several seconds to leave the setting mode and back to the measurement mode or “OUTPUT OFF”. The operation of the voltage/current setting can be matched with the [V SET] or [I SET] to change the output value. When set the output to ON, the change of value will be reacted to the output immediately.



5-3. Operation Method

The applied Voltage/Current Unit for this series instruments is Volt and Amp.

- **Constant Voltage Operation**

- 1) Connect load to output terminal:

For the safety, when connect the load to output terminals of (+) and (-), it must turn off the power.

- 2) Select output range:

Turn on the power after the load is well connected, select the adequate operation range by pressing [SHIFT][8V/20A] or [SHIFT][20V/10A].

- 3) Set the current limit value:

Press [I SET], the panel operation is set to current value input mode, set the desired change value by using the number key or the wheel knobs (the wheel knob can be used together with [<] or [>] to adjust the resolution).

- 4) Set the desired output voltage value:

Press [V SET], the panel operation is set to voltage value input mode, change to the desired value by using the number key or the wheel knobs (the wheel knob can be used together with [<] or [>] to adjust the resolution).

- 5) Start the output:

Press [OUTPUT] to enable output, now, the meter displays the actual output measurement value.

- 6) Constant voltage mode confirmation

Check whether the C.V. indicator is on or not to make sure the output operation is under the constant voltage mode. If the C.C. indicator is on, it needs to enlarge its current limit value to assure that the output operation is under constant voltage mode.

- **Constant Current Operation**

- 1) Connect load to output terminal:

For the safety, when connect the load to output terminals of (+) and (-), it must turn off the power.

- 2) Select output range:

Turn on the power after the load is well connected, select the adequate operation range by pressing [SHIFT][8V/20A] or [SHIFT][20V/10A].

- 3) Set the voltage limit value:

Press [V SET], the panel operation is set to voltage value input mode, set the desired change value by using the number key or the wheel knobs (the wheel knob can be used together with [<] or [>] to adjust the resolution).

4) Set the desired output current value:

Press [I SET], the panel operation is set to current value input mode, change to the desired value by using the number key or the wheel knobs (the wheel knob can be used together with [<] or [>] to adjust the resolution.

5) Start the output:

Press [OUTPUT] to enable output, now, the meter displays the actual output measurement value.

6) Constant current mode confirmation

Check whether the C.C. indicator is on or not to make sure the output operation is under the constant current mode. If the C.V. indicator is on, it needs to enlarge its voltage limit value to assure that the output operation is under constant current mode.

- **Programming Over Voltage Protection, OVP**

Set OVP level and the protection circuit of the OVP status.

1) Input the value of the Over Voltage protection limit value and set the OVP status.

2) Confirm the function of OVP (Over Voltage Protection):

Adjust the output voltage up near to OVP level to confirm the OVP function, when the OVP circuit is triggered, the OVP loop will drop the output voltage near to zero, now, the OVP indicator will be blinking.

3) Clear the OVP function:

Firstly, remove the external test unit, such as battery, from the instrument, adjust the voltage down or raise up the OVP level, then clear the OVP.

- **Programming Over Current Protection, OCP**

Set OCP level and the protection circuit of the OCP status.

1) Input the value of the Over Voltage protection limit value and set the OCP status.

2) Confirm the function of OCP (Over Current Protection):

Adjust the output current up near to OCP level to confirm the OCP function, when the OCP circuit is triggered, the OCP loop will drop the output current near to zero, now, the OCP indicator will be blinking.

3) Clear the OCP function:

Firstly, remove the external test unit, such as battery, from the instrument, adjust the output current down or raise up the OCP level, then clear the OCP.

- **Storing and Recalling Operating:**

1) The storing setting function including the store of the Output range, Output voltage value, Output current value, Over Voltage protection level, Over Current protection level, Over Voltage protection status, Over Current protection status and the Delay time.

2) Store the present setting status to the memory bank:

Press [SHIFT][STORE], set the panel operation to Storing setting selection, input the memory address by using number key (When want to correct the input value due to error key-in, can use wheel knob to clear the error value and re-input the value), then press [ENTER] to complete the change of store, and the panel will display “DONE” message.

3) Recall the setting status from the memory bank:

Press [SHIFT][RECALL], set the panel operation to Recall setting, use the number key to recall the desired memory address (When want to correct the input value due to error key-in, can use wheel knob to clear the error value and re-input the value), then press [ENTER] to complete the change, and the panel will display “DONE” message.

- **Auto Running Operation**

The function must be used together with the DELAY setting which is defined as the operation delay time of next running operation. The Delay function is workable only under Auto Running operation.

1) Delay time setting:

Press [DELAY] to set the panel operation to Delay time setting selection.

2) The setting and store of very group of data:

A group setting includes the Output range, Output voltage value, Output current value, Over Voltage protection level, Over Current protection level, Over Voltage status (ON/OFF), and Delay time. User can proceed the setting and store it to the memory bank group by group up to 100 groups maximum.

3) Recall range setting (Auto running operation range):

Regarding the setting description, please refer to AUTO RANGE operation.

4) Enter AUTO mode by pressing [AUTO], now, the operation is in the auto running function by pressing [OUTPUT].

5) Under this mode, press [SHIFT][AUTO INFO] can monitor the current operation setting address and operation time.

● **The flow chart of the Auto Running Operation**

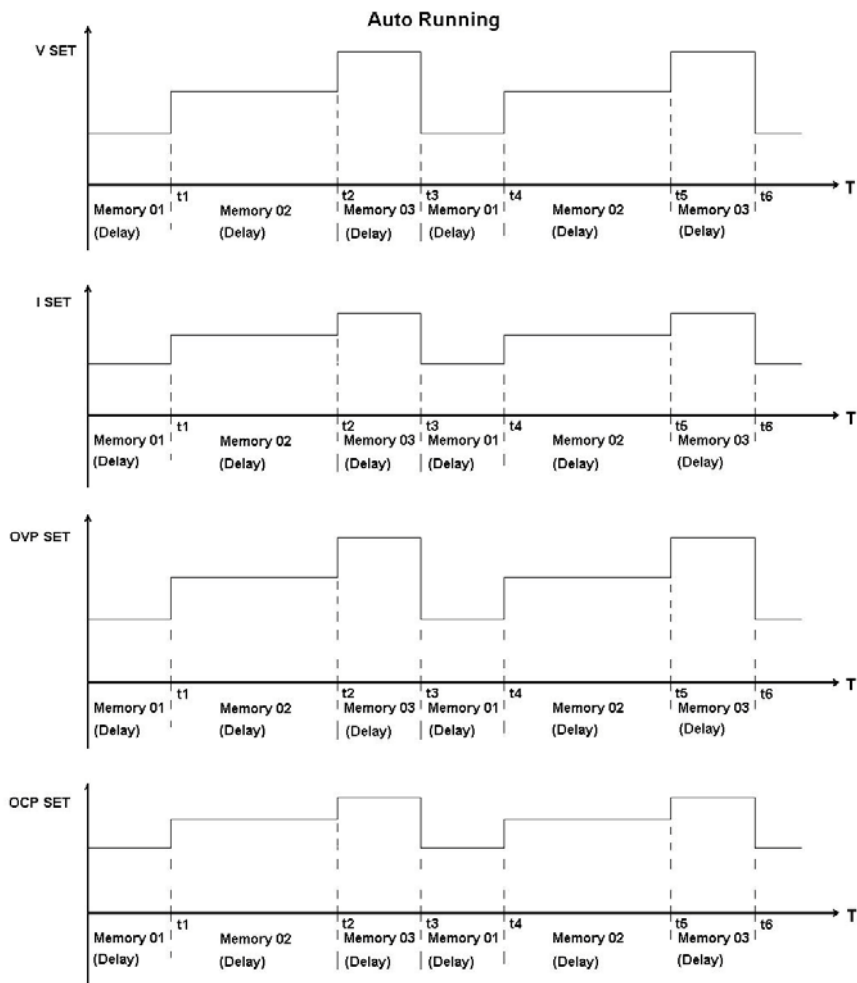

● **The Remote voltage sensing of the front/rear panel terminals:**

The remote voltage sensing circuit is to compensate the voltage drop occurred on the power supply and load terminal during load adding. When proceed the remote voltage sensing, the probe connected between the output of power supply and the sensing terminal must be removed. The output terminals of the front panel and rear panel is parallel and connected with the sensing terminal, when use the output of front panel, the sensing probe of the rear panel terminal must be removed, and visa versa.

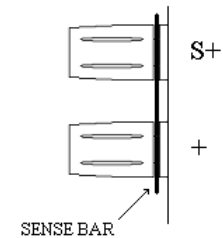

Figure 5-1 : General output terminal sampling and output wiring

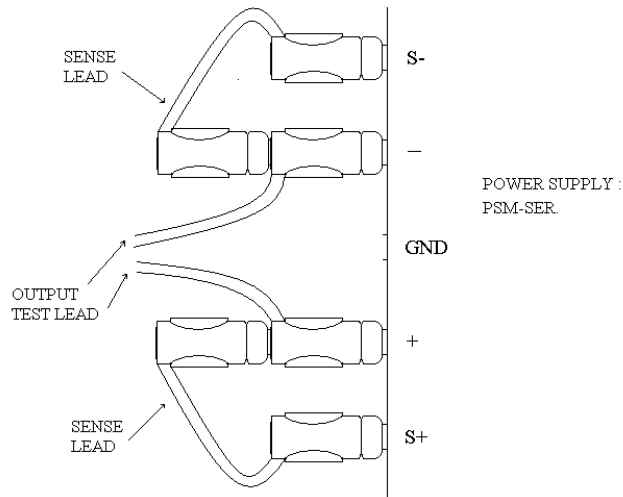

Figure 5-2 : Sampling and wiring application for the output terminal of European Regulation

1) CV Regulation

When the voltage drop between the (+) output terminal and positive sensing point increases 1V, its voltage Load regulation must be add another 5mV.

2) Output Noise

A voltage load regulation effects could be occurred by any noise which interferes the output terminal of the power supply. Therefore, it will be helpful to reduce the output noise by paralleling two sensing circuit of (S+) and (S-) and separating each other adequately, then connect a single end to the ground terminal of power supply. The relative configuration is as follows:

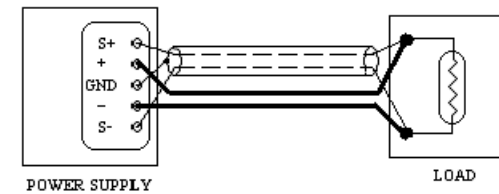

Figure 5-3

● **Panel Lock Key:**

Press [LOCK] key can lock up the panel control knob to prevent any setting change, now the [OUTPUT] key still works. Press again [LOCK] key for a few seconds can release the lock setting.

● **GPIB and RS232 interface setting:**

Please refer to the PSM-SERIES Programmer manual for detailed description.

RS232 cable configuration:

Instrument	Cable	PC
(1) DCD		(1) DCD
(2) RX		(2) RX
(3) TX		(3) TX
(4) DTR		(4) DTR
(5) GND		(5) GND
(6) DSR		(6) DSR
(7) RTS		(7) RTS
(8) CTS		(8) CTS
(9) RI		(9) RI
DB-9 male		DB-9 male

Figure 5-4 RS-232 Cable Configuration

Please enter to our web site for updated information:

<http://www.goodwill.com.tw>

5-4. The maximum value of the output setting

Model	PSM-2010		PSM-3004		PSM-6003	
Output Range						
Item	8V,20A	20V,10A	15V,7A	30V,4A	30V,6A	60V,3.3A
Output Voltage	8.240V	20.60V	15.450V	30.900V	30.900V	61.800V
Output Current	20.60A	10.30A	7.210A	4.120A	6.180A	3.400A
OVP (Over Voltage Protection)	22V		32V		64V	
OCP (Over Current Protection)	22A		7.500A		6.500A	
Step Voltage	8.000V	20.000V	15.000V	30.000V	30.000V	60.000V
Step Current	20.00A	10.00A	7.000A	4.000A	6.000A	3.300A
Delay Time	59'59.9"					
Memory Group	100					

5-5. Test Lead**Table 1:**

Model	PSM-2010	PSM-3004	PSM-6003
Test Lead	GTL-104 or GTL-204 (The maximum current: 10A)		

Note: The attached test lead to the PSM-SERIES is only used for the front panel output terminal with the maximum current of 10A.

Table (2)

AWG	10	12	14	16	18	20	22	24	26	28
Maximum Current(amps)	40	25	20	13	10	7	5	3.5	2.5	1.7
mΩ/m	3.3	5.2	8.3	13.2	21.0	33.5	52.8	84.3	133.9	212.9

6. MAINTENANCE

WARNING

The following instructions are executed by qualified personnel only. To avoid electrical shock, do not perform any servicing other than the operating instructions unless you are qualified to do so.

6-1. Fuse Replacement

If the fuse blows, the display will not light and the power supply will not operate. The fuse should not normally open unless a problem has developed in the unit. Try to determine and correct the cause of the blown fuse, then replace only with a fuse of the correct rating and type.



WARNING. For continued fire protection. Replace fuse only with 250V fuse of the specific type and rating, and disconnect power cord before replacing fuse.

6-2. Line Voltage Conversion

The primary winding of the power transformer is tapped to permit operation from 100, 120, 220, or 230VAC, 50/60 Hz line voltage. Conversion from one line voltage to another is done by change AC selects switch.

The rear panel identifies the line voltage to which the unit was factory set. To convert to a different line voltage, perform the following procedure:

- (1) Make sure the power cord is unplugged.
- (2) Change the AC selects switch to the desired line voltage position.
A change in line voltage may also require a corresponding change of fuse value. Install the correct fuse value as listed on rear panel.

6-3. Measurement Techniques

For an accurate and convenient measurement, please set up the instrument according to the following:

1) Setup:

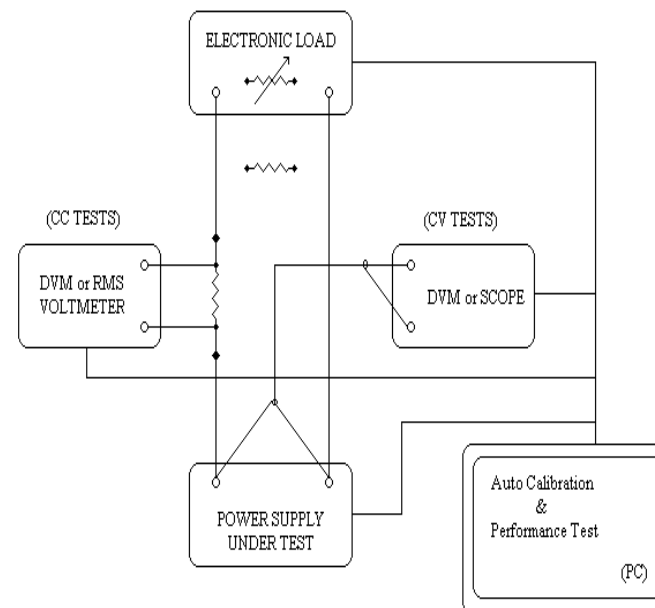

Figure 6-1

2) The calibrated devices:

For general calibration, user can select the suitable calibration devices by their own. Please refer to the below recommendation:

A. Electronic Load

In order to meet the demand of the auto calibration, the Electronic Load with GPIB is well recommended. The main function of the Electronic Load is to control the short test (CC current calibration), the connection test (voltage load regulation, transient response time) and open test (CV voltage calibration).

Measurement Techniques

Assure a precise Load regulation, Voltage peak to peak, and transient response time, the test joint point must be configured to sampling terminals of S+ and S-.

B. Current Monitoring Resistor

The resistor must have sufficient Watt value that can meet the calibration need to control the change amount less than 15mA when a 20.00A current run over it for a long period.

C. DVM or RMS Voltmeter

The meter used for the output voltage measurement should have 0.1mV resolution (accuracy: 0.01%). For the output current measurement, the meter should have 0.001mV resolution(accuracy: 0.01%) to measure the voltage of the shunt, then transfer it to the corresponding current value.

D. Oscilloscope

To test the voltage noise and output oscillator when the power supply is in the CV and CC mode.

E. Person Computer (PC)

This is a supplementary tool for the auto calibration including interface card and auto calibration software of its own.

6-4. Adjustment and Calibration

--Preparation

1. 30 minutes warm up before calibration.
2. Ambient temperature: $23 \pm 5^\circ\text{C}$, Humidity: Under RH80%.

--Output Calibration Steps:

[Step 1]



Press [SHIFT][.] to appear Password input window, input Password (vary with different models: PSM-2010= 2010, PSM-3004 = 3004, PSM-6003 = 6003) by using the number key, press [ENTER] key

[Step 2]

When get into Calibrated item selection window, set the cursor to the calibrated item by using the knob and press [ENTER]. After the calibrated item is selected, proceeding voltage, current and over-voltage calibration step by step.

[Step 3] Voltage Calibration Steps

Set to [VOLTAGE] by using the knob and press [ENTER] getting into voltage calibration procedure.



[Step 3.1]

Firstly, proceed the calibration procedure of LO calibrated point, input DMM measurement value, then press [ENTER].



Note: The DMM selected for the measurement must have the resolution of 4 digits after the decimal point at least, and take three digits after the decimal point to be the effective value and run off the rest.

[Step 3.2]

Next, proceed the calibration procedure of MI calibrated point, input DMM measurement value, then press [ENTER].



Note: The DMM selected for the measurement must have the resolution of 4 digits after the decimal point at least, and take three digits after the decimal point to be the effective value and run off the rest.

[Step 3.3]

Finally, proceed the calibration procedure of HI calibrated point, input DMM measurement value, then press [ENTER].

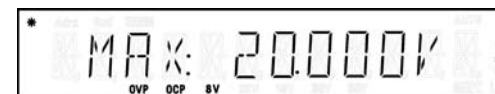

Note: The DMM selected for the measurement must have the resolution of 4 digits after the decimal point at least, and take three digits after the decimal point to be the effective value and run off the rest.

Now, switch to SAVE by using the knob and press [ENTER] to leave the mode with storing. Also can press [SHIFT][.] to leave the mode without storing.

【Step 4】

Set to [O.V.P.] by using the knob and press [ENTER] getting into Over Voltage Protection auto-calibration procedure. Now, the output is in CV mode (output terminal open).

Switch to SAVE by using the knob and press [ENTER] to leave the mode with storing. Also can press [SHIFT][.] to leave the mode without storing.

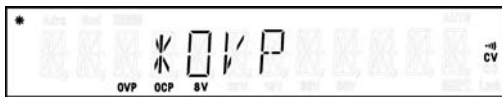

【Step 5】 Current Calibration Steps

Set to [CURRENT] by using the knob and press [ENTER] getting into Current calibration procedure.



【Step 5.1】

Firstly, proceed the calibration procedure of LO calibrated point, input DMM measurement value, then press [ENTER].



Note: The current measurement method, please refer to 6-3. Measurement technique. Now, the DMM selected for the measurement must have the resolution of 3 digits after the decimal point at least.

【Step 5.2】

Next, proceed the calibration procedure of MI calibrated point, input DMM measurement value, then press [ENTER].



【Step 5.3】

Finally, proceed the calibration procedure of HI calibrated point, input DMM measurement value, then press [ENTER].



Now, switch to SAVE by using the knob and press [ENTER] to leave the mode with storing. Also can press [SHIFT][.] to leave the mode without storing.

Caution. When proceed the current adjustment, please use a Shunt with sufficient Watt to overcome the problem of temperature rising. A Shunt with general material of Manganin can be used as long as its temperature is less than 85°C.



[Step 6]

Set to [O.C.P.] by using the knob and press [ENTER] getting into Over Current Protection auto-calibration procedure. Now, the output is in CC mode (output terminal short).

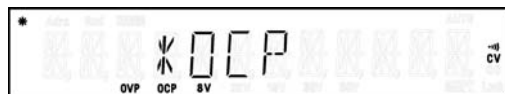

Switch to SAVE by using the knob and press [ENTER] to leave the mode with storing. Also can press [SHIFT][.] to leave the mode without storing.

[Step 7]

Set to [SAVE] and press [ENTER] to complete the calibration procedure with storing. If want to cancel the calibration, using the knob to set the cursor to [EXIT] and press [ENTER] to terminate the procedure without storing.



6-5. Cleaning

To clean the power supply, use a soft cloth dampened in a solution of mild detergent and water. Do not spray cleaner directly onto the instrument, since it may leak into the cabinet and cause damage. Do not use chemicals containing benzene, benzene, toluene, xylene, acetone, or similar solvents. Do not use abrasive cleaners on any portion of the instrument.

7. THE SYSTEM DIAGRAM AND DESCRIPTION

7-1. Block Diagram

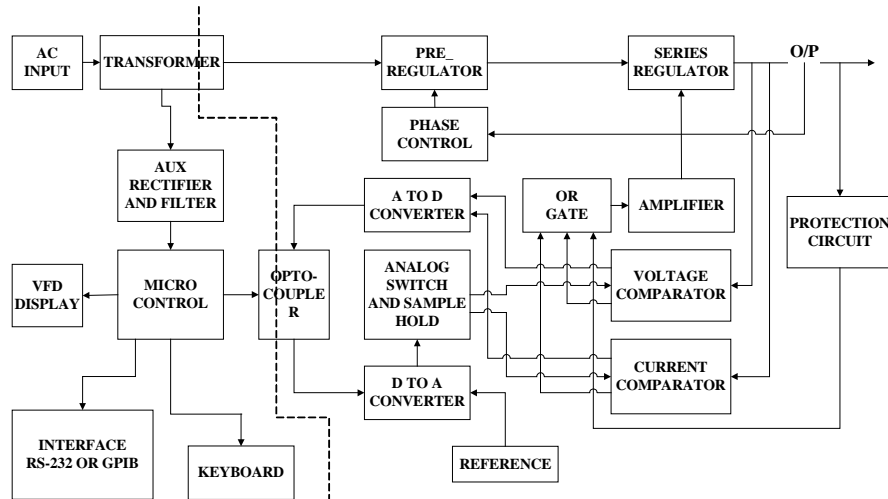

The graph above is the system diagram of PSM-SERIES, which consists of Micro Processor Unit (MPU), Digital to Analog Converter (DAC), Analog Switch Circuit, Reference Voltage Circuit, Driver Circuit, Control Circuit, Comparator, Phase Control and etc.

7-2. The Configuration of Block System

The whole Block system consists of two Circuit Blocks, Digital Control circuit (connected to the ground) and power output circuit (isolated from the ground):

Digital Control circuit: MPU (Micro Processor Unit), VFD DISPLAY, Interface Control Card, GPIB (IEEE-488) and RS-232.

Power output circuit: DAC (Digital to Analog Converter), ADC (Analog to Digital Converter), Analog Switch Circuit, Reference Voltage Circuit, Driver Circuit, Control Circuit, Comparator and Phase Control.

The MPU is the heart of PSM-SERIES control the DAC(digital to analog converter) control to provide the required reference voltage source of voltage, current, Over Voltage protection, Over Current protection in order to make the accurate setting and protection. Then, use the reference voltage to control the Analog Switch Circuit to achieve high quality and high accuracy output. Beside, the protection precaution detected by the hardware can reach speedy and accurate purpose.