

CONTENTS	PAGE
1. PRODUCT INTRODUCTION.....	1
1-1. Description.....	1
1-2. Feature.....	1
2. TECHNICAL SPECIFICATIONS.....	3
3. PRECAUTIONS BEFORE OPERATION.....	5
3-1. Unpacking the Instrument.....	5
3-2. Checking the Line Voltage.....	5
3-3. Environment.....	6
4. PANEL INTRODUCTION.....	7
5. OPERATION METHOD.....	10
5-1. Output Voltage/Current Setting.....	10
5-2. Over Voltage/Current Protection Setting.....	11
5-3. The Display Contrast Setting.....	12
5-4. The Buzzer Setting.....	12
5-5. GPIB/RS-232 Interface Setting.....	12
5-6. The Maximum Setting Value.....	13
5-7. Test Lead.....	13
5-8. The Setting for the GPIB and RS232 Interface.....	13
6. MAINTENANCE.....	14
6-1. Fuse Replacement.....	14
6-2. Line Voltage Conversion.....	14
6-3. Adjustment and Calibration.....	15
6-4. Cleaning.....	18
7. THE SYSTEM DIAGRAM AND DESCRIPTION.....	19
7-1. Block Diagram.....	19
7-2. The Operation of the whole circuit.....	20

SAFETY TERMS AND SYMBOLS

These terms may appear in this manual or on the product:



WARNING. Warning statements identify condition or practices that could result in injury or loss of life.



CAUTION. Caution statements identify conditions or practices that could result in damage to this product or other property.

The following symbols may appear in this manual or on the product:



DANGER
High Voltage



ATTENTION
refer to Manual



Protective
Conductor
Terminal



Earth (ground)
Terminal



Frame or Chassis
Terminal

FOR UNITED KINGDOM ONLY

NOTE: This lead/appliance must only be wired by competent persons

WARNING: THIS APPLIANCE MUST BE EARTHED

IMPORTANT: The wires in this lead are coloured in accordance with the following code:

Green/ Yellow:	Earth
Blue:	Neutral
Brown:	Live (Phase)

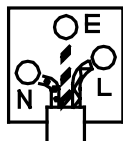

As the colours of the wires in main leads may not correspond with the colours marking identified in your plug/appliance, proceed as follows:

The wire which is coloured Green & Yellow must be connected to the

Earth terminal marked with the letter E or by the earth symbol  or coloured Green or Green & Yellow.

The wire which is coloured Blue must be connected to the terminal which is marked with the letter N or coloured Blue or Black.

The wire which is coloured Brown must be connected to the terminal marked with the letter L or P or coloured Brown or Red.

If in doubt, consult the instructions provided with the equipment or contact the supplier.

This cable/appliance should be protected by a suitably rated and approved HBC mains fuse: refer to the rating information on the equipment and/or user instructions for details. As a guide, cable of 0.75mm² should be protected by a 3A or 5A fuse. Larger conductors would normally require 13A types, depending on the connection method used.

Any moulded mains connector that requires removal /replacement must be destroyed by removal of any fuse & fuse carrier and disposed of immediately, as a plug with bared wires is hazardous if engaged in live socket. Any re-wiring must be carried out in accordance with the information detailed on this label.

Declaration of Conformity

We

GOOD WILL INSTRUMENT CO., LTD.

No. 7-1, Jhongsing Rd., Tucheng City, Taipei County 236, Taiwan

GOOD WILL INSTRUMENT (SUZHOU) CO., LTD.

No.69 Lushan Road, Suzhou New District Jiangsu, China.

declare that the below mentioned product

PSS-2005, PSS-3203

are herewith confirmed to comply with the requirements set out in the Council Directive on the Approximation of the Law of Member States relating to Electromagnetic Compatibility (89/336/EEC, 93/68/EEC) and Low Voltage Equipment Directive (73/23/EEC, 93/68/EEC). For the evaluation regarding the Electromagnetic Compatibility and Low Voltage Equipment Directive, the following standards were applied:

◎ EMC

EN 61326-1: Electrical equipment for measurement, control and laboratory use — EMC requirements (1997+A1: 1998)	
Conducted and Radiated Emissions EN 55011: 1991+A1: 1997+A2: 1996	Electrostatic Discharge EN 61000-4-2: 1995
Current Harmonic EN 61000-3-2: 1995+A1: 1998+A2: 1998 +A14: 2000	Radiated Immunity EN 61000-4-3: 1996
Voltage Fluctuation EN 61000-3-3: 1995	Electrical Fast Transients EN 61000-4-4: 1995
-----	Surge Immunity EN 61000-4-5: 1995
-----	Conducted Susceptibility EN 61000-4-6: 1996
-----	Voltage Dips/ Interrupts EN 61000-4-11: 1994

◎ Safety

Low Voltage Directive 73/23/EEC & amended by 93/68/EEC

IEC/EN 61010-1: 2001

1. PRODUCT INTRODUCTION

1-1. Description

PSS-series Programmable Power Supply is controlled by Micro Processor Unit (MPU) that can easily connect communication interface RS-232 or GPIB to computer in order to satisfy users' demand for auto-testing and auto-control.

The voltage and current are completely controlled by a 12 bits D/A Converter with higher resolution and accuracy. Also, the digitalization of system makes a speedy, precise and convenient input of information controlled by keyboard and wheel knob.

The adjustment of voltage/current is made by software calibration without man-made error that will increase the preciseness of the instrument.

The function of Over Voltage Protection (OVP) and Over Current Protection (OCP) is set with software and detected with hardware to achieve protected function precisely and speedily in order to secure users from danger by using the instrument.

1-2. Feature

- 1) An overall digitalization of programmable interface with high resolution.
- 2) The 16×2 LCD Display.
- 3) High stability and low draft.

- 4) The function of over voltage/current/temperature protection.
- 5) Intelligent control fan (Vary with different output power.)
- 6) Warning signal by the built-in Buzzer.
- 7) Step by step calibration procedure.
- 8) Brand new panel design and the 1/4 rack size reduction volume design.
- 9) Wheel knob of Fine and Coarse.
- 10) IEEE-488.2 and SCPI compatible command setting.
- 11) Correspond to CE safety regulation.

2. TECHNICAL SPECIFICATIONS

SPECIFICATIONS		PSS-3203	PSS-2005
Output	Voltage	0~32V×1	0~20V×1
	Current	0~3A×1	0~5A×1
	OVP	0~33V×1	0~21V×1
Load Effect	Voltage	≤ 3mV(≤ 5mV rating current>3.0A)	
	Current	≤ 3mA(≤ 5mA rating current>3.0A)	
Source Effect	Voltage	≤ 3mV	
	Current	≤ 3mA	
Resolution	Voltage	10mV	
	Current	1mA(2mA rating current>3.0A)	
	OVP	10mV	
Program Accuracy (25±5°C)	Voltage	≤ 0.05%+20mV	
	Current	≤ 0.1%+5mA(+10mA rating current >3.0A)	
	OVP	≤ 0.05%+20mV	
Ripple & Noise (20Hz~20MHz)	Voltage	Ripple ≤ 1mVrms/3mVp-p Noise ≤ 2mVrms/30mVp-p	
	Current	≤ 3mArms (≤ 5mArms rating current>3.0A)	
Temperature Coefficient (0~40°C)	Voltage	≤ 100ppm+3mV	
	Current	≤ 100ppm+3mA	
Readback Resolution	Voltage	10mV	
	Current	1mA(2mA rating current >3.0A)	
Readback Accuracy (25±5°C)	Voltage	≤ 0.05%+10mV	
	Current	≤ 0.1%+5mA(10mA rating current >3.0A)	
Response Time	Voltage Up	10%~90% ≤ 100ms	
	Voltage Down	90%~10% ≤ 100ms (≥ 10% rating load)	
Readback Temperature Coefficient	Voltage	≤ 100ppm+10mV	
	Current	≤ 100ppm+5mA	
Drift	Voltage	≤ 100ppm+10mV	
	Current	≤ 150ppm+10mA	

Interface	RS232 (GPIB interface option)	
Power Source	AC100V, 120V, 220V±10%, 230V +10%/-6% 50/60Hz	
Power Consumption	PSS-2005: 215W PSS-3203: 190W	
Mechanical Spec.	Dimensions	110(W)×140(H)×320(D) mm.
	Weights	4.8 kg
Operation Environmental	Indoor use Altitude up to 2000 m Ambient temperature : To satisfy specifications : 10°C to 35°C (50° F to 95°F) Maximum operating ranges: 0°C to 40°C (32°F to 104°F) Relative humidity: 85% RH(max.) non condensing Installation Category: II Pollution degree: 2	
Storage Temperature & Humidity	-10° to 70°C, 70%RH (maximum)	
Accessories	Power cord..... × 1 Instruction manual.....× 1 Programmer manual..... × 1 Test Lead.....× 1	

3.PRECAUTIONS BEFORE OPERATION

3-1.Unpacking the Instrument

The product has been fully inspected and tested before shipping from the factory. Upon receiving the instrument, please unpack and inspect it to check if there is any damage caused during transportation. If any sign of damage is found, notify the bearer and/or the dealer immediately.

3-2.Checking the Line Voltage

The product can be applied by any kind of line voltages shown in the table below. Before connecting the power plug to an AC line outlet, make sure the voltage selector of the rear panel is set to the correct position corresponding to the line voltage. It might be damaged the instrument by connecting to the wrong AC line voltage.



WARNING. To avoid electrical shock the power cord protective grounding conductor must be connected to ground.

AVERISS: Pour éviter les chocs électriques, le fil de terre du cordon secteur doit impérativement être relié à la terre.

When line voltages are changed, replace the required fuses shown as below:

Model	Line voltage	Range	Fuse	Line voltage	Range	Fuse
PSS-3203	100V	90-110V	T3A	220V	198-242V	T1.6A
PSS-2005	120V	108-132V	250V	230V	216-250V	250V

3-3.Environment

The normal ambient temperature range of this instrument is from 0° to 40°C (32° to 104°F). To operate the instrument exceeding this specific temperature range may cause damage to the circuits of instrument.

Do not use the instrument in a place where strong magnetic or electric field exists as it may disturb the measurement.

4. PANEL INTRODUCTION

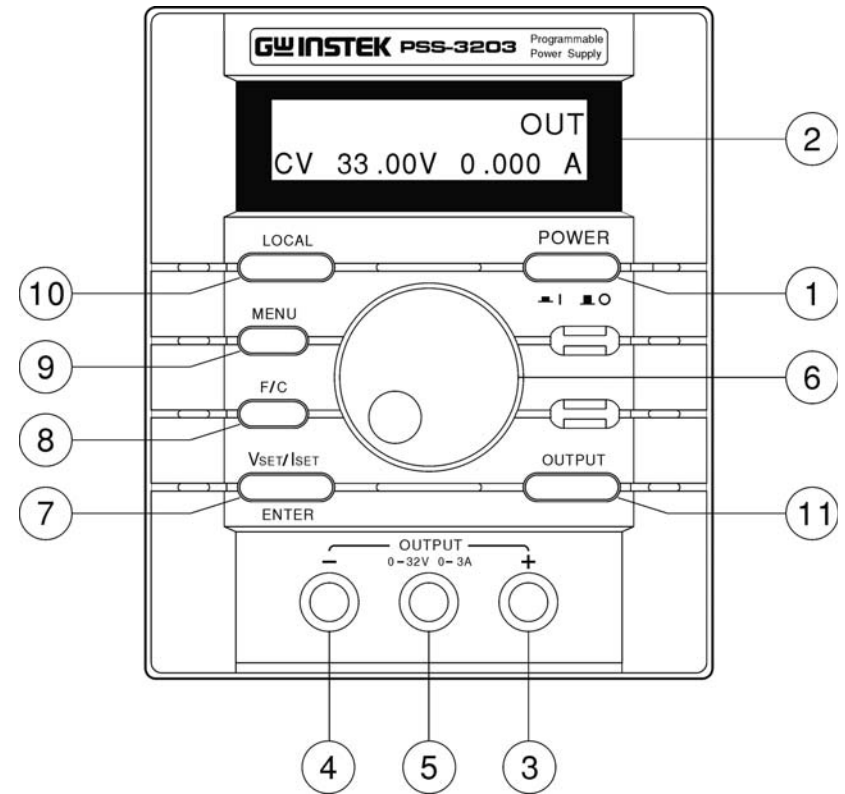

Figure 4-1 Front Panel

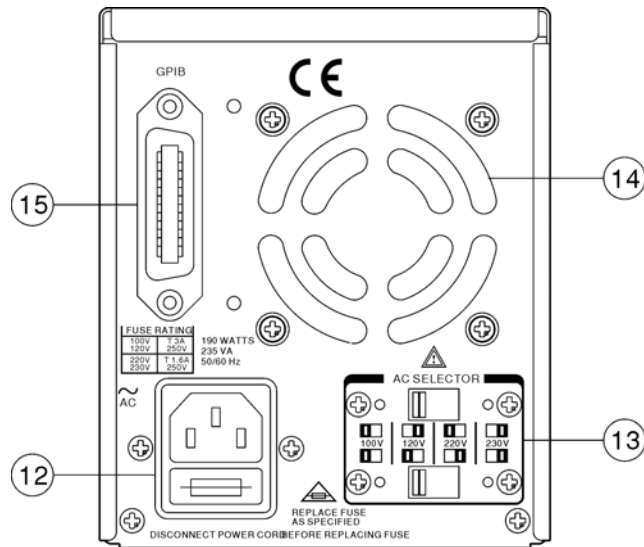



Figure 4-2 Rear Panel

- | | | |
|-----|---------------------|--|
| 1. | Power Switch | Connect the AC power, then press power switch. |
| 2. | Display | Indicate the setting of voltage/current value, output voltage/current value and the status of setting and output. |
| 3. | +Output Terminal | Positive output terminal. |
| 4. | -Output Terminal | Negative output terminal. |
| 5. | GND Terminal | Connect the ground terminal to chassis. |
| 6. | Rotary Encoder | Wheel knob. |
| 7. | V Set/I Set (ENTER) | The key for switch over output voltage and output current setting.
ENTER: The knob for value input or setting confirmation. |
| 8. | F/C | The knob for switching over coarse and fine adjustment. |
| 9. | MENU | The category of function setting (Output, OVP, OCP, Contrast, Buzzer, Interface.)
PS. After switching to the picture of function setting category, if there is no further setting action within 4 to 5 seconds, the system will return to previous setting picture or output display picture. |
| 10. | LOCAL | Clear REMOTE control mode, and replace with panel control.
PS. Get into calibration mode by pressing the knob more than 5 seconds uninterruptedly, |
| 11. | Output | Turn on or off output by pressing the knob. |
| 12. | AC Power Socket | AC power input terminal. |
| 13. | AC Select Switch | Switch Voltage to 100V, 120V, 220V or 230V, 50/60Hz. |
| 14. | Cooling Fan | A cooling fan. |
| 15. | Interface | GPIB or RS-232C communication interface. |

5. OPERATION METHOD

5-1. Output Voltage/Current Setting

At first, ensure that the window now is at the Output Voltage/Current setting or the output value display.

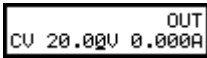
 or
 

--Output Voltage Setting:

Press [Vset/Iset] to set the cursor to the position for voltage input, and modify the setting value with wheel knob. Right now, can use [F/C] to switch over the input of 1V step or 10mV step.

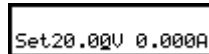

Example:

If want to set the voltage as 12.34V, first using the [F/C] knob to switch the cursor to 10mV step and adjust the value to 34, then switch the cursor to 1V step and adjust the value to 12 to complete the modification.



 >>
 

 >>
 

PS. If the output is on now, the output voltage value will be varied with the setting of the knob.

--Output Current Setting:

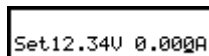
After pressing [Vset/Iset] to set the cursor to the position for current input, modify the setting value with wheel knob. Right now, use [F/C] to switch over the input of 100mA step or 1mA step.



Example:

If want to set the current as 1.234A, first using the [F/C] knob to switch the cursor to 1mA step and adjust the value to 34, then switch the cursor to 100mA step and adjust the value to 12 to complete the modification.

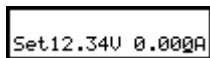
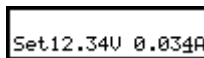
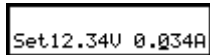
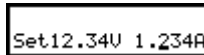
 >>
 

 >>
 

Note: 1. When the load current through output terminal exceeds the setting value, the instrument is operated in the C.C. mode, if not exceeds the setting value, the instrument is operated in the C.V. mode.

2. When the maximum output voltage is larger than 36V, its adjustable step is 20mV the minimum while the maximum output current is larger 3A, its adjustable step is 2mA the minimum.

5-2. Over Voltage /Current Protection Setting

--Over Voltage Protection Setting:

Set to OVP SET window by pressing [MENU], modify the setting value with the wheel knob and press [ENTER]. The modification can be done by using the [F/C] knob to switch over the input of 1V step or 10mV step.

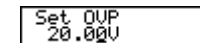

--OVP Status Clear Up:

When the output voltage exceeds the setting voltage, the output of the instrument will be off and get into OVP mode by displaying "OVP Error. Press "LOCAL" to reset" on the panel. Just press [LOCAL] to clear OVP status and back to previous status.

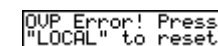

--Over Current Protection Setting:

Set to OCP SET window by pressing [MENU], Turn on/off the OCP with the wheel knob and press [ENTER]. If OCP is on, when the output current equals or exceeds the current value setting, the output of the instrument will be off and get into over current protection mode by displaying "OCP Error. Press "LOCAL" to reset" on the display. Just press [LOCAL] to clear OCP status and back to previous status.

```
OCP Error! Press
"LOCAL" to reset
```

5-3. The Display Contrast Setting

Set to Contrast Set window by pressing [MENU], modify its setting value with the wheel knob and press [ENTER].

```
Set Contrast
50%
```

5-4. The Buzzer Setting

Set to Buzzer Set window by pressing [MENU], turn on or off the buzzer with the wheel knob, then press [ENTER].

```
Buzzer Set ON
```

5-5.GPIB/RS232 Interface Setting

Set to Interface window by pressing [MENU]. If the GPIB is displayed, the Address value window will be appeared, if the RS-232 is displayed, the Baud Rate window will be appeared, then using the wheel knob to modify the value and press [ENTER] to complete the setting.

Note: The system will detect the interface used at present automatically, and switch the detected interface over the setting interface of GPIB or RS-232.

Example:

1) If want to set the GPIB address value to 15:

Set to interface window by pressing [MENU], and adjust the address value to 15 with the wheel knob and press [ENTER] to

complete the setting.

```
Interface GPIB
Address 15
```

2) If want to set the RS-232 Baud Rate to 9600:

Set to interface window by pressing [MENU], and adjust the Baud Rate value to 9600 with the wheel knob and press [ENTER] to complete the setting.

```
Interface RS-232
Baud Rate 9600
```

5-6. The Maximum Setting Value

MODEL ITEM	PSS-3203	PSS-2005
Output Voltage	33.00V	21.00V
Output Current	3.100A	5.200A
Over-voltage	34.00V	22.00V

5-7.Test Lead

MODEL ITEM	PSS-3203	PSS-2005
	Current 3A Test Lead	Current 4A-10A Test Lead

5-8. The setting for the GPIB and RS232 Interface

If you have PSS-series programmable power supply, use the GPIB or RS-232 interface, please refer to the PSS-series Programmer Manual for more details.

6. MAINTENANCE

WARNING

The following instructions are executed by qualified personnel only. To avoid electrical shock, do not perform any servicing other than the operating instructions unless you are qualified to do so.

6-1. Fuse Replacement

If the fuse blows, the display will not light and the power supply will not operate. The fuse should not normally open unless a problem has developed in the unit. Try to determine and correct the cause of the blown fuse, then replace only with a fuse of the correct rating and type (refer to 3-2 of page 5). The fuse is located on the rear panel (see Fig.4-2).



WARNING. *For continued fire protection. Replace fuse only with 250V fuse of the specific type and rating, and disconnect power cord before replacing fuse.*

6-2. Line Voltage Conversion

The primary winding of the power transformer is tapped to permit operation from 100, 120, 220, or 230VAC, 50/60 Hz line voltage. Conversion from one line voltage to another is done by change AC selects switch.

The rear panel identifies the line voltage to which the unit was factory set. To convert to a different line voltage, perform the following procedure:

- (1) Make sure the power cord is unplugged.
- (2) Change the AC selects switch to the desired line voltage position.
- (3) A change in line voltage may also require a corresponding change of fuse value. Install the correct fuse value as listed on rear panel.

6-3. ADJUSTMENT AND CALIBRATION

--Preparation

- (1) 30 minutes warm up before calibration.
- (2) Ambient temperature: $23 \pm 5^\circ\text{C}$, Humidity: Under PH80%.

--Output Calibration Steps:

[Step 1]

Press [LOCAL] for 4 to 5 seconds interruptedly to appear Password input window (vary with different models: PSS-3203: 3203, PSS-2005: 2005), input the password number with the wheel knob, and use the F/C button to shift the input position at the same time, then press [ENTER]. When the password number has been input by mistake, the system will jump out of the present mode.

Please enter the
password: ■■■■

[Step 2] Voltage Calibration Step

After getting into Calibration selection window, select Voltage calibration with the knob and press [ENTER].

[Step 2.1]

Now input the voltage value (Min) measured by DMM with the knob and press [ENTER]. During the voltage value input, use the [F/C] button to switch over the input of 1V step or 10mV step.

Note: The DMM selected for the measurement have the resolution of three digits of the decimal point at least (1mV). Also the input value is to take two digits of decimal point of effective value (10mV) and run off the rest.

[Step 2.3]

Adjust VR311 and adjust the voltage value measured by DMM according to the voltage displayed in the window, then press [ENTER].

Note: The DMM selected for the measurement must have the resolution of three digits of the decimal point at least (1mV). During the adjustment, the maximum error of the measured value is $\pm 0.005V$.



Calibration
VoltMax 30.000

[Step 3] Current Calibration Steps

Switch the Calibration selection window to current calibration item with the knob and press [ENTER] getting into current calibration steps.

[Step 3.1]

Now input the current value (Max.) measured by the DMM with the knob and press [ENTER]. During the current value input, use the

[F/C] button to switch over the input of 100mA range (100mA/step) or 1mA range (1mA/step).

Note: The DMM selected for the measurement must have the resolution of four digits of the decimal point at least (0.1mA). Also the input value is to take three digits of decimal point of effective value (1mA) and run off the rest.

[Step 3.2]

Now input the current value (Min.) measured by the DMM with the knob and press [ENTER]. During the current value input, use the [F/C] button to switch over the input of 100mA range (100mA/step) or 1mA range (1mA/step).



Calibration
CurrMin 0.1000

Note: The DMM selected for the measurement must have the resolution of four digits of the decimal point at least (0.1mA). Also the input value is to take three digits of decimal point of effective value (1mA) and run off the rest.

[Step 4]

Switch the Calibration selection window to O.V.P. calibration item with the knob and press [ENTER] getting into O.V.P calibration steps.

[Step 4.1]

At present, the window will indicate the progress of OVP calibration. When the calibration is completed, it will jump out of the window.

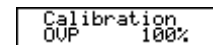

Calibration
OVP 100%

[Step 5]

When above calibration steps has been confirmed correctly, switch the calibration selection window to SAVE window with the knob and press [ENTER] to complete the whole calibration procedures.

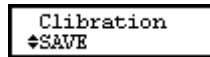

[Step 6]

If the calibration procedure is not necessary to be stored, just switch the calibration selection window to Exit window and press [ENTER] to leave the calibration procedure.

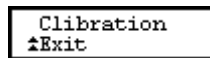

6-4. Cleaning

To clean the power supply, use a soft cloth dampened in a solution of mild detergent and water. Do not spray cleaner directly onto the instrument, since it may leak into the cabinet and cause damage. Do not use chemicals containing benzine, benzene, toluene, xylene, acetone, or similar solvents. Do not use abrasive cleaners on any portion of the instrument.

7. THE SYSTEM DIAGRAM AND DESCRIPTION

7-1. Block Diagram

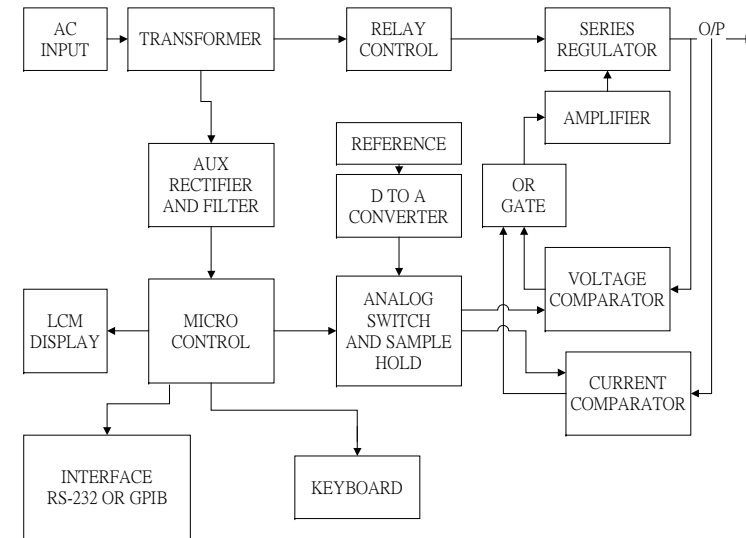

The graph above is the system diagram of PSS-SERIES, Which consists of Micro Processor Unit (MPU), Digital to Analog Converter (DAC), Analog Switch Circuit, Reference Voltage Circuit, Driver Circuit, Control Circuit, Comparator, and etc.

7-2.The Operation of the whole circuit

Each output channel of PSS-series has a reference voltage circuit at around 2.5V output voltage which can be amplified to $2.5(1+R314/(R315+Vr))=2.5(1+12.4k/(7.68k+Vr))$ by a non-inverter amplifier. When $Vr=0\sim 500$, take its middle value to convert above formula into 6.41V, and treat this as the reference voltage of DAC AD7541. The AD7541 is a 12-bit DAC with $6.41V/4095=1.56mV/bit$ of the resolution.

When the instrument is in C.V. Mode, the MPU will send 3300 counts, 33.00V of output voltage, to DAC, output through analog switch and Sample Hold circuit, the voltage now is at around $-5.148V(-1.56mV \times 3300=-5.148V)$. Then, compare this voltage with the real output voltage which is retrieved by the voltage sense circuit. As the entire circuit is a close loop, therefore, the retrieved voltage value will be followed with the reference voltage of Sample Hold. Besides, the Comparator output terminal will output a related voltage value to control the whole output circuit through a driver circuit, and generate the required output voltage. The attenuation of the voltage sense circuit is $A=R342/(R342+R335)=4.99K/(4.99k+27.0k)=0.156$, and the output voltage is $Vout=5.148/A=5.148/0.156=33.00V$. If the output is affected by the offset of materials, can use the Vr to make adequate adjustment.

The operation in C.C. Mode is similar to that in C.V. Mode. The MPU will send 2100 counts, 2.1A output current, to DAC, output through analog switch and Sample Hold circuit, the voltage now is at around $-3.276V(-1.56mV \times 2100=-3.276V)$. Then, compare this voltage with the real output voltage which is retrieved by the current sense circuit. As the entire circuit is a close loop, therefore, the retrieved voltage value will be followed with the reference voltage of Sample Hold. Besides, the Comparator output terminal will output a relative voltage value to control the whole output circuit through a driver circuit, and generate the required output voltage. The current sense circuit for detecting the voltage value from current sense resistor is mainly composed by differential amplifier TL071. The multiple of the differential amplifier is $A=-R355/R356=-22.0k/1.91k=-11.518$, the voltage on the both sides of current sense resistor is $-3.276/-11.518=0.285V$, so the output current is basis on $Iout=(0.285/R374)*2=(0.285/0.3)*2=1.9A$, and 2.1A making multiple operand to get a real output current by using the software.

The Displayed Value of Voltage and Current

The voltage/current sense circuit retrieves a voltage value which will be sent to Comparator through Analog Switch, and joined with the output voltage of DAC in dichotomy approaching method to get the same voltage as the real output value of the instrument.