

Leica DISTO™ D8

The original laser distance meter



Leica DISTO™

3 Years
Warranty

if registered within 8 weeks after
purchase at www.disto.com

T  **USA**
Equipment
.NET

205 Westwood Ave
Long Branch, NJ 07740
1-877-742-TEST (8378)
Fax: (732) 222-7088
salesteam@Equipment.NET

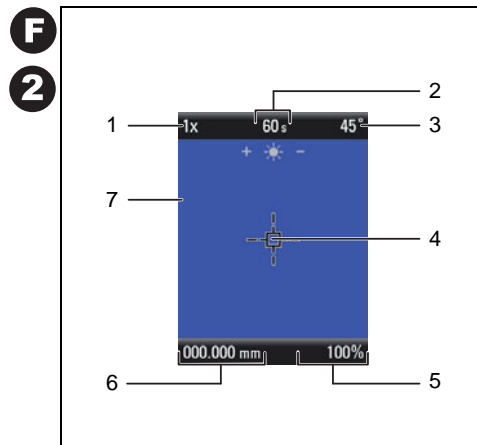
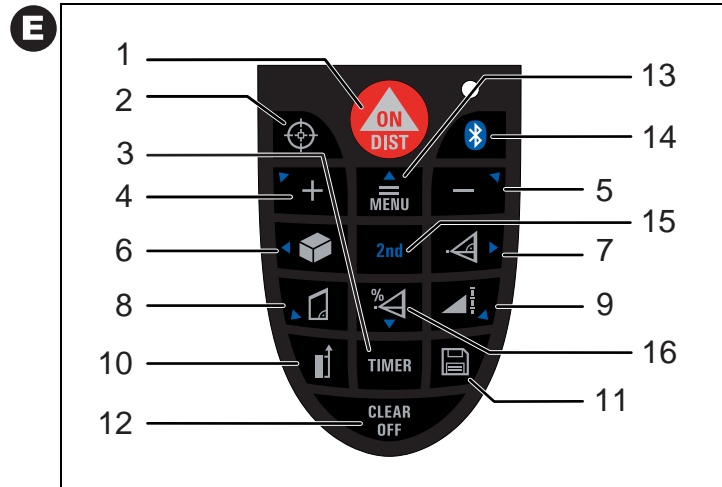
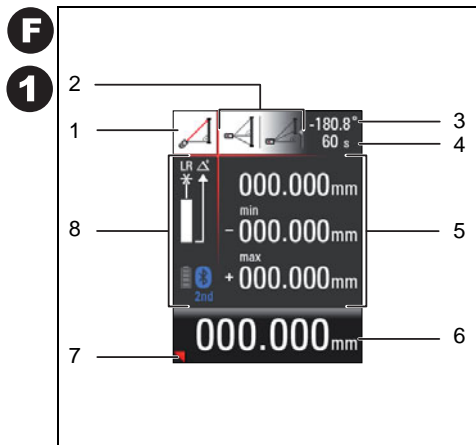
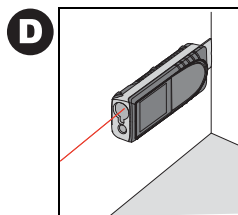
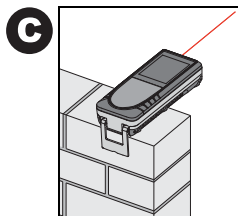
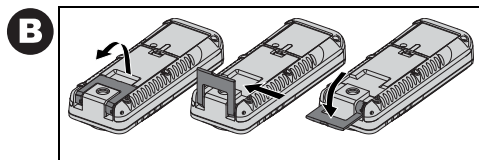
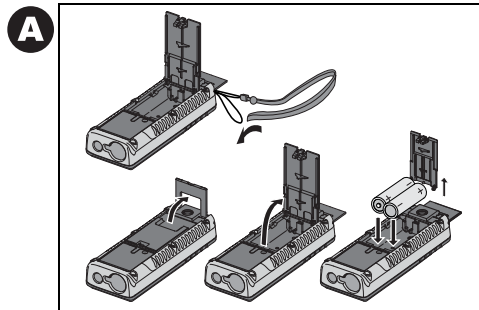



Leica DISTO™ D8

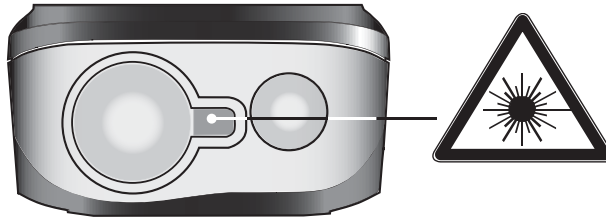

Congratulations on the purchase of your Leica DISTO™ D8.



Carefully read the Safety Instructions and the User Manual before using this product.

The person responsible for the instrument must ensure that all users understand these directions and adhere to them.

Contents

Safety Instructions.....	1
Start-up	5
Menu functions	6
Operation	9
Measuring.....	9
Functions.....	10
Working with BLUETOOTH®.....	15
Appendix.....	16

Safety Instructions

Symbols used

The symbols used in the Safety Instructions have the following meanings:



WARNING:

Indicates a potentially hazardous situation or an unintended use which, if not avoided, will result in death or serious injury.



CAUTION:

Indicates a potentially hazardous situation or an unintended use which, if not avoided, may result in minor injury and/or in appreciable material, financial and environmental damage.



Important paragraphs which must be adhered to in practice as they enable the product to be used in a technically correct and efficient manner.

Use of the instrument

Permitted use

- Measuring distances
- Computing functions, e. g. areas and volumes
- Storing measurements (BLUETOOTH®)
- Measuring tilts

Prohibited use

- Using the instrument without instruction
- Using outside the stated limits
- Deactivation of safety systems and removal of explanatory and hazard labels
- Opening of the equipment by using tools (screwdrivers, etc.), as far as not specifically permitted for certain cases
- Carrying out modification or conversion of the product

- Use of accessories from other manufacturers without the express approval of Leica Geosystems.
- Deliberate or irresponsible behaviour on scaffolding, when using ladders, when measuring near machines which are running, or near parts of machines or installations which are unprotected
- Aiming directly into the sun
- Deliberate dazzling of third parties; also in the dark
- Inadequate safeguards at the surveying site (e.g. when measuring on roads, construction sites, etc.)

Limits of use

 See section "Technical Data".

The Leica DISTO™ is designed for use in areas permanently habitable by humans, do not use the product in explosion hazardous areas or in aggressive environments.

Areas of responsibility

Responsibilities of the manufacturer of the original equipment Leica Geosystems AG, CH-9435 Heerbrugg (for short Leica Geosystems): Leica Geosystems is responsible for supplying the product, including the User Manual and original accessories, in a completely safe condition. (additional language versions can be found at: www.disto.com.)

Responsibilities of the manufacturer of non-Leica accessories:

 The manufacturers of non-Leica accessories for the Leica DISTO™ are responsible for developing, implementing and communicating safety concepts for their products. They are also responsible for the effectiveness of these safety concepts in combination with the Leica Geosystems equipment.

Responsibilities of the person in charge of the instrument:

WARNING

The person responsible for the instrument must ensure that the equipment is used in accordance with the instructions. This person is also accountable for the deployment of personnel and for their training and for the safety of the equipment when in use.

The person in charge of the instrument has the following duties:

- To understand the safety instructions on the product and the instructions in the User Manual.
- To be familiar with local safety regulations relating to accident prevention.
- To inform Leica Geosystems immediately if the equipment becomes unsafe.

Hazards in use

CAUTION:

Watch out for erroneous distance measurements if the instrument is defective or if it has been dropped or has been misused or modified.

Precautions:

Carry out periodic test measurements. Particularly after the instrument has been subject to abnormal use, and before, during and after important measurements.

Make sure the Leica DISTO™ optics are kept clean and that there is no mechanical damage to the bumpers.

CAUTION:

In using the instrument for distance measurements or for positioning moving objects (e.g. cranes, building equipment, platforms, etc.) unforeseen events may cause erroneous measurements.

Precautions:

Only use this product as a measuring sensor, not as a control device. Your system must be configured and operated in such a way, that in case of an

erroneous measurement, malfunction of the device or power failure due to installed safety measures (e.g. safety limit switch), it is assured that no damage will occur.

 **WARNING:**

Flat batteries must not be disposed of with household waste. Care for the environment and take them to the collection points provided in accordance with national or local regulations.



The product must not be disposed of with household waste.

Dispose of the product appropriately in accordance with the national regulations in force in your country.

Always prevent access to the product by unauthorised personnel.

Product specific treatment and waste management information can be

downloaded from the Leica Geosystems home page at

<http://www.leica-geosystems.com/treatment> or received from your Leica Geosystems dealer.

Electromagnetic Compatibility (EMC)

The term "electromagnetic compatibility" is taken to mean the capability of the product to function smoothly in an environment where electromagnetic radiation and electrostatic discharges are present, and without causing electromagnetic interference to other equipment.

 **WARNING:**

The Leica DISTO™ conforms to the most stringent requirements of the relevant standards and regulations. Yet, the possibility of it causing interference in other devices cannot be totally excluded.

 **CAUTION:**

Never attempt to repair the product yourself. In case of damage, contact the local dealership.

Use of the product with BLUETOOTH®:



WARNING:

Electromagnetic radiation can cause disturbances in other equipment, in installations (e.g. medical ones such as pacemakers or hearing aids) and in aircraft. It can also affect humans and animals.

Precautions:

Although this product conforms to the most stringent standards and regulations, Leica Geosystem cannot totally exclude the possibility of harm to people and animals.

- Do not use the product near petrol stations, chemical plants, in areas with a potentially explosive atmosphere and where blasting takes place.
- Do not use the product near medical equipment.
- Do not use the product in airplanes.
- Do not use the product near your body for extended periods.



CAUTION:

Never attempt to repair the product yourself. In case of damage, contact the local dealership.

FCC statement (applic. in U.S.)

This equipment has been tested and found to comply with the limits for a Class B digital device, pursuant to part 15 of the FCC Rules. These limits are designed to provide reasonable protection against harmful interference in a residential installation.

This equipment generates, uses and can radiate radio frequency energy and, if not installed and used in accordance with the instructions, may cause harmful interference to radio communications.

However, there is no guarantee that interference will not occur in a particular installation.

If this equipment does cause harmful interference to radio or television reception, which can be determined by turning the equipment off and on, the user is encouraged to try to correct the interference by one or more of the following measures:

- Reorient or relocate the receiving antenna.
- Increase the separation between the equipment and receiver.
- Connect the equipment into an outlet on a circuit different from that to which the receiver is connected.
- Consult the dealer or an experienced radio/TV technician for help



WARNING:

Changes or modifications not expressly approved by Leica Geosystems for compliance could void the user's authority to operate the equipment.

Laser classification

Integrated distancemeter

The Leica DISTO™ produces a visible laser beam which emerges from the front of the instrument.

It is a Class 2 laser product in accordance with:

- IEC60825-1 : 2007 "Radiation safety of laser products"

Laser Class 2 products:

Do not stare into the laser beam or direct it towards other people unnecessarily. Eye protection is normally afforded by aversion responses including the blink reflex.



WARNING:

Looking directly into the beam with optical aids (e.g. binoculars, telescopes) can be hazardous.

Precautions:

Do not look directly into the beam with optical aids.



CAUTION:

Looking into the laser beam may be hazardous to the eyes.

Precautions:

Do not look into the laser beam. Make sure the laser is aimed above or below eye level. (particularly with fixed installations, in machines, etc.)

Labelling

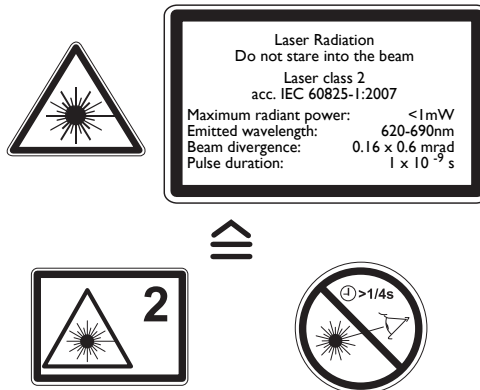

Position of the product label see last page!

Inserting/replacing batteries

See figure {A}

- 1 Remove battery compartment lid and attach handstrap.
- 2 Insert batteries, observing correct polarity.
- 3 Close the battery compartment again. Replace the batteries when the symbol  flashes permanently in the display.



Remove the batteries before any long period of non-use to avoid the danger of corrosion.



Use alkaline batteries or rechargeable batteries only.

Changing the reference point (multifunctional endpiece)

See figure {B}

The instrument can be adapted for the following measuring situations:

- For measurements from an edge, fold out the positioning bracket until it first locks in place. See figure {C}.
- For measurements from a corner, open the positioning bracket until it locks in place, then push the positioning bracket lightly to the right to fold it out fully. See figure {D}.

A built-in sensor automatically detects the orientation of the positioning bracket and adjusts the zero point of the instrument accordingly.

Keypad

See figure {E}:

- 1 **ON / DIST (On/measuring) button**
- 2 **Digital pointfinder - button**
- 3 **Timer button**
- 4 **Plus (+) button**
- 5 **Minus (-) button**
- 6 **Area / volume button**
- 7 **Indirect measurement (Pythagoras) button**
- 8 **Trapezoid button**
- 9 **Functions button**
- 10 **Reference button**
- 11 **Storage/Memory button**
- 12 **Clear/Off button**
- 13 **Menu/Equal button**
- 14 **Bluetooth button**
- 15 **Second function button**
- 16 **Indirect measurement with tilt sensor button**

Display in normal mode

See drawing {F. I}.

The graphics screen of the measurement window is split into different areas. Top left is the brightest field, which contains the currently selected measuring program. Just to the right appears the program submenu, which shows the measuring programs that can be selected by pressing the same key the required number of times.

The measurement field contains the individual measurements of the measuring program with reference to a series of separate distance measu-

rements. Three lines are provided for this. A horizontal line separates the measurement field and the result bar from one another. A red triangle indicates whether the selected measuring program has a detailed display available.

- 1 Program selection with measurement instructions
- 2 Program selection submenu
- 3 Level
- 4 Timer
- 5 Measurement field
- 6 Result bar
- 7 Detailed display
- 8 Status bar with (Laser ON, Reference plane, Display Long range mode, Offset, Plus / Minus, Battery status)



Display in "digital pointfinder" mode



Digital pointfinder (4x zoom)

The device has an integral digital pointfinder, which shows the target directly on the display. The displayed crosshairs allow precise measurements to be made even though the laser beam is not visible. See drawing {F.2}

The integral coloured digital pointfinder is a great help outdoors and can be used in every function. Longer distances and precise measurements on detailed surfaces can even be accomplished in bright sunlight without any problem.

The 4x zoom allows the image to be magnified to suit the user's requirements.

Press the  key to activate the zoom function. Press the  key again to operate in a 1x, 2x or up to 4x zoom view.

The brightness of the viewfinder can be adjusted through 5 levels using the  key or the  key.

 Parallax errors occur when the digital pointfinder is used on close targets, the laser dot may appear displaced in the crosshair. In this case you should rely on the actual laser dot for targeting the object.

See drawing {F.2}

- 1 Zoom step (1x, 2x, 4x)
- 2 Timer
- 3 Level (in °)
- 4 Crosshairs
- 5 Inclination angle
- 6 Distance tracking value
- 7 Image

Menu functions

Settings

Various device settings can be made in the menu. A vertical list shows each entry. In this menu the selection field (cursor) remains stationary and the list moves in a vertical direction. Starting from the centre of the list, the priority of list entries starts at the top and fans out clockwise. See drawing {G}.

The menu contains following items:

- 1 Units of measurement (distance)
- 2 Units of measurement (angle)
- 3 Display illumination
- 4 Long range mode
- 5 Tripod
- 6 Beep



- 7 Offset
- 8 Digital Pointfinder image in black/white
- 9 Level in status field (in °)
- 10 Reset
- 11 Calibrate tilt sensor

Navigation in the menu



The menu allows settings to be customized for a particular user or application.

General description

Press and **hold** the  key to enter the Setup menu.

By pressing the  or  keys, navigate through the main menu items in the menu.

Press the  key **briefly** to enter the submenu of the selected main menu item.

By pressing the  or  keys you can make the alterations in the submenu.

Press and **hold** the  key to accept the settings.

Pressing the  button **for longer** in the menu allows you to quit the settings function without saving.

Setting the unit for distance measurements

The following units can be set:

	Distance	Area	Volume
I.1	0.0000 m	0.000 m ²	0.000 m ³
I.2	0.000 m	0.000 m ²	0.000 m ³
I.3	0.00 m	0.000 m ²	0.000 m ³
I.4	0.00 ft	0.00 ft ²	0.00 ft ³
I.5	0'00" ¹ / ₃₂	0.00 ft ²	0.00 ft ³
I.6	0'00" ¹ / ₁₆	0.00 ft ²	0.00 ft ³
I.7	0'00" ¹ / ₈	0.00 ft ²	0.00 ft ³
I.8	0'00" ¹ / ₄	0.00 ft ²	0.00 ft ³
I.9	0.0 in	0.00 ft ²	0.00 ft ³
I.10	0 ¹ / ₃₂ in	0.00 ft ²	0.00 ft ³
I.11	0 ¹ / ₁₆ in	0.00 ft ²	0.00 ft ³
I.12	0 ¹ / ₈ in	0.00 ft ²	0.00 ft ³
I.13	0 ¹ / ₄ in	0.00 ft ²	0.00 ft ³
I.14	0.000 yd	0.000 yd ²	0.000 yd ³

Setting the unit for tilt measurements

The following units can be set for tilt measurements:

	Units for tilt
2.1	± 90.0°
2.2	± 180.0°
2.3	360.0°
2.4	0.00 %
2.5	0.0 mm/m
2.6	0.00 in/ft

Display illumination (💡)



The brightness of the display has six levels of adjustment. Step 6 is the brightest and step 1 is the darkest setting.



Long range Mode (📏)

Unfavourable conditions (strong sunlight or a very weak reflective target surface) may reduce the range of the device, in spite of this the long range mode allows you to take measurements over longer distances. The use of a tripod and measurement initiation by pressing the  key are recommended when measurements over 30m are made over longer time periods in these conditions. (For details see Technical specifications)

 The settings are reset when the device is switched off.

Measuring with the tripod (📐)

The reference point may be adjusted to the tripod mount if the user requires a measurement from the actual mounting grommit versus the front or back of the DISTO. To do this select the  symbol in this menu item. You can switch the reference on the tripod on or off. The setting can be seen on the display .





 We recommend that measurements are initiated using the  key when using the device on a tripod in order to prevent loss of sharpness.

 The settings are reset when the device is switched off.

Beep (🎵)

You can switch the beep on or off.

Offset (⬆️⬆️)

An offset adds or subtracts a specified value automatically to or from all measurements. This function allows tolerances to be taken into account (e.g. unfinished dimensions compared with finished dimensions). If you selected the Offset function in the menu, you can now adjust the value using the  or the  key. Pressing the key for longer increases the rate of change of the values. When you reach the desired offset value, confirm it with the  key. The display shows the appropriate symbol  or  for as long as the offset value is set.

Digital pointfinder image black / white (🖨️)

The display in pointfinder mode can be changed to black / white.

Level in status field (📏)

The Level (in °) in status field can be switched on or off.

Reset - returning the instrument to the factory settings (🔄)







The instrument has a Reset function. If you select the menu function Reset and confirm, the device returns to the factory settings and stack and memory are deleted.

 All customised settings and stored values are also lost.

Calibrate the tilt sensor ()

You can calibrate the tilt sensor in the device. Calibration requires two measurements on a level surface.

Select calibration mode in the menu .

- 1 Carry out a first measurement  on a level surface. The device confirms the measurement with .
- 2 Rotate the device horizontally through 180° .
- 3 Press the  key and confirm that the device was rotated through 180°.
- 4 Press the  key and take the second measurement. The device confirms the measurement with .

The tilt sensor is calibrated.

Operation

Switching on and off



Switches on the instrument and laser. The display shows the battery symbol until the next button is pressed.



Pressing this button for longer switches the instrument off.

The instrument switches off automatically after six minutes of inactivity.

CLEAR button



The last action is cancelled. While making area or volume measurements, each single measurement can be deleted and remeasured in series.

Reference setting

The default reference setting is from the rear of the instrument.



Press this button to take the next measurement from the front edge

. A special beep sounds whenever the reference setting is changed.

After a measurement the reference returns automatically to the default setting (rear reference). See figure {H}.



Press this button for **longer** the front reference is set permanently.



Press this button, the rear reference is set again.

Measuring

Single distance measurement



Press to activate the laser. Press again to trigger the distance measurement.

The result is displayed immediately.

Minimum/maximum measurement

This function allows the user to measure the minimum or maximum distance from a fixed measuring point. It can also be used to determine spacings. See figure {I}.

This function is commonly used to measure room diagonals (maximum values) or horizontal distances (minimum values).







Press and hold down this button until you hear a beep. Then slowly sweep the laser back and forth and up and down over the desired target point - (e.g. into the corner of a room).



Press to stop continuous measurement. The values for maximum and minimum distances are shown in the display as well as the last measured value in the summary line.

Laser continuous

Press and **hold down** the  key when switching on the device until the  character appears permanently in the display and a beep sounds. Every further press of the  key releases a distance measurement.























Press the  key and keep it pressed to switch the device and Laser continuous operation off.





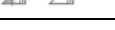















If the laser is in continuous operation mode, the device switches off automatically after 15 minutes.

Functions

Overview of the program icons

Measuring program	Icon	Measurement 1 - 2 - 3	Detail display 1 - 2 - 3
Simple distance measurement			
Area measurement			
Volume measurement			
Trapezoid measurement 1 (using three distances)			
Trapezoid measurement 2 (using two distances and one angle)			
Pythagorean calculation 1			
Pythagorean calculation 2			
Pythagorean calculation 3			

Measuring program	Icon	Measurement 1 - 2 - 3	Detail display 1 - 2 - 3
Inclination measurement			
Direct horizontal distance			
Double tilt measurement 1 (in the same quadrants)			
Double tilt measurement 2			
Triangular area measurement			
Staking out function			
Profile measurement			

Addition / subtraction

Distance measuring.

 The next measurement is added to the previous one.



 The next measurement is subtracted from the previous one.



This process can be repeated as required.



 Press this button and the result is then always shown in the summary line with the previous value in the second line.

 The last step is cancelled.



Area

 Press **once**. The  symbol appears in the display.



 Press this button to take the first length measurement  (e.g. length).



 Press it again to take the second length measurement  (e.g. width).

 Press this button and the result is shown in the summary line.



Press and **hold** the  key to display the perimeter .

(e.g. height 1).

Press the  key again and take the second length measurement  (e.g. width)



Press the  key and take the third length measurement  (e.g. height 2).



The result is shown in the summary row.



Press and **hold** the  key to display additional information about the trapezium measurement, for example inclination angle , trapezium area .

Volume





 Press this button **twice**. The  symbol appears in the display.

 Press this button to take the first length measurement  (e.g. length).

 Press this button to take the second length measurement  (e.g. width).



 Press this button to take the third length measurement  (e.g. height).



 Press this button and the volume value is shown in the summary line.



Press and **hold** the  button to display additional room information such as ceiling/floor area , surface area of the walls , circumference .

Trapezoid measurement 2



See drawing {K}.

Press the  key **twice**. This symbol  is displayed.

Press the  key and take the first length measurement .

Press the  key and take the second length measurement  and inclination angle measurement.

The result is shown in the summary row.



Press and **hold** the  key to display additional information about the trapezium measurement, for example inclination angle , trapezium area .



Triangular area

The area of a triangle can be calculated by the measurement of three sides.

See drawing {N}.



Press the  key **once** - the triangle symbol  appears in the display.



Press the  key and measure the first side of the triangle .



Press the  key and measure the second side of the triangle .

Trapezoid measurement 1



See drawing {J}

Press the  key **once**. The symbol  is displayed.

Press the  key and take the first length measurement .

Press the  key and measure the third side of the triangle .

The result  is shown in the summary row.



Press and **hold** the  key to display additional information about the measurement, such as the angle  included by the first two measurements and the perimeter  of the triangle.



Stake out function



Two different distances (a and b) can be entered into the instrument and can then be used to mark off defined measured lengths, e.g. in the construction of wooden frames.





See figure {O}.

Entering stake out distances:

 Press this button **twice** and the stake out function symbol appears in the display .



By using  and , you can adjust the values (first a and then b) to suit the desired stake out distances. Holding the buttons down increases the rate of change of the values.

Once the desired value (a)  has been reached it can be confirmed with the  button.

Value (b) can be entered using  and . The defined value (b)  is confirmed with the  button.

Pressing the  button starts the laser measurement. The display shows required stake out distance in the summary line between the stake out point (first a and then b) and the instrument (rear reference).

If the DISTO™ is then moved slowly along the stake out line the displayed distance decreases. The instrument starts to beep at a distance of 0.1m from the next stake out point.

The arrows in the display   indicate in which direction the DISTO™ needs to be moved in order to achieve the defined distance (either a or b). As soon as the staking out point is reached, the symbol  appears in the display.

The function can be stopped at any time by pressing the  button.

Indirect measurement

The instrument can calculate distances using Pythagoras' theorem.

This procedure is helpful, if the distance to measure can not be reached directly.



 Make sure you adhere to the prescribed sequence of measurement:



- All target points must be in a horizontal or vertical plane.
- The best results are achieved when the instrument is rotated about a fixed point (e.g. with the positioning bracket fully folded out and the instrument placed on a wall) or the disto is mounted on a tripod.
- The minimum/maximum function can be used - see explanation in "Measuring -> Minimum/maximum measurement". The minimum value must be used for measurements at right angles to the target; the maximum distance for all other measurements.

Indirect measurement - determining a distance using 2 auxiliary measurements



See figure {P}

e.g. for measuring building heights or widths. It is helpful to use a tripod when measuring heights that require the measurement of two or three measurements.



 Press this button **once**, the display shows . The laser is switched on.

 Aim at the upper point (1) and trigger the measurement . After

the first measurement the value is adopted. Keep the instrument as horizontal as possible.



 Press and hold down this button to trigger continuous measurement , sweep the laser back and forth and up and down over the ideal target point.

 Press to stop continuous measurement (2). The result is displayed in the summary line, the partial results in the secondary line.



Press and **hold** the  key to display additional information about the measurement of the angles of the triangle  and .

Indirect Measurement - determining a distance using 3 measurements



See figure {Q}





 Press this button **twice**; the display shows the following symbol . The laser is switched on.

 Aim at the upper point (1) and trigger the measurement. After the first measurement the value is adopted. Keep the instrument as horizontal as possible

 Press and hold down this button to trigger continuous measurement , sweep the laser up and down over the ideal target point.

 Press to stop continuous measurement (2). The value is adopted. Aim at the lower point and



 press this button to trigger the measurement (3) . The result is displayed in the summary line, the partial results in the secondary lines.

Press and **hold** the  key to display additional information about for example the partial distances ,  and the minimum distance .



Indirect measurement - determining a partial value using 3 measurements

See figure {R}



e.g. determining the height between point 1 and point 2 using three target points.

 Press this button **three times**; the display shows the following symbol . The laser is switched on.



Aim at the upper point (1).

 Press this button and trigger the measurement . After the first measurement the value is adopted.

 Triggers the measurement . After the second measurement the value is adopted.

 Press and hold down this button to trigger continuous measurement . Sweep the laser up and down over the ideal target point.

 Press this button to end continuous measurement. The result is displayed in the summary line, the partial results in the secondary lines.

Press and **hold** the  key to display additional information about the measurement of the partial lengths  and .



Indirect measurement with tilt sensor

Tilt measurement

 During tilt measurement the instrument should be held without a transverse tilt (max. 10°).

 If the device is tilted by more than $\pm 10^\circ$ laterally, the display shows infocode i 156 which means that the device has been tilted too much.



 The units of inclination are set in the menu.

 Press this button **once** to activate the tilt sensor. The  symbol





appears in the display. The tilt is continuously shown as ° or % depending on the setting.

 Press to measure the inclination and the distance. See figure {L}.

Direct horizontal distance

 Press this button **twice** and the following symbol appears in the display .



 Press this button to measure tilt and distance. The summary line displays the result as the direct horizontal distance.

Press and **hold** the  key to display additional information about the measurement, for example the inclination angle , the measured distance  and the indirect height .



See drawing {M}.



Double tilt measurement with one measured distance



This procedure is particularly helpful if one target point of those to be measured cannot be reflective. The second target point can be simply pointed at with the digital viewfinder. In this measurement it is the angle only and not the distance that is measured and therefore no special target is required for the laser. See drawing {S}.

Press the  button **three times**. The following symbol  appears in the display.

Press the  button - tilt and distance are measured. If the tilt changes, the device updates the resulting height value and displays it in the summary row.



Press the  button -  only the tilt is measured and the value of the resulting indirect height is frozen in the summary row .

Press and **hold** the  button to display additional information about the measurement, such as the horizontal distance , the distance to the



second measured point , or the height to the same point  (please note the different icons).





Double tilt measurement with two measured distances

This procedure is particularly suitable if the two measured points do not lie in the same vertical plane. The two target points are each measured using a distance and a tilt measurement. See drawing {T}.

Press the  button **four times**. The following symbol  appears in the display.

Press the button  -  tilt and distance are measured.

Press the button  -  tilt and distance are measured. The summary row shows the resulting distance between the two measured points .

Press and **hold** the  button to display additional information about the measurement, such as the horizontal distance , the height difference between the measured points , or the included angle .

 Measure to the top target point first. This point must lie behind the bottom target point. If this is not the case, an error message appears in the display.

Profile measurement



This function is used to measure profiles and terrain sections. After measuring a reference point with a known height (e.g. bench mark or floor), the height and horizontal distance to the instrument are displayed for each following point.



 We recommend using a tripod!



Press the  key **five times**.

The following symbol appears on the display: .

With  and  enter the known height of the reference point (e.g. -

4,000 m in a construction system) and confirm with . The following symbol then appears on the display: .

Now aim the instrument at the height reference point and press the  key - the gradient and distance are measured. The instrument is then ready to measure profile points .

Measure the profile points by pressing the  key. The horizontal distance from the instrument to the measured point  and the height of the point  are displayed.

Press  to exit the function.



 If the tripod and the instrument are moved, always restart the function and measure the height reference point again before continuing to measure!

Storage of constants / historical storage

Storage of a constant



You can store and recall a frequently used value e.g. height of a room. Measure the desired distance, press and hold the  button until the device beeps to confirm storage.

Recalling the constant



 Press this button **once** to recall the constant and then press the  button to enter it into your calculation.

Historical storage

 Press this button **twice** and the previous 30 results (measurements or calculated results) are shown in reverse order.

The  and  buttons can be used for navigation.

 Press this button to use a result from the summary line for further calculations.

Pressing the  and  buttons at the same time erases all the values in historical storage.

Timer (self-triggering)

 Press this button to set a 5-second time delay.

or



 Press and hold down this button until the desired time delay is reached (max. 60 seconds).

Once the key is released with the laser activated, the remaining seconds until measurement (e.g. 59, 58, 57...) are displayed in a countdown. The last 5 seconds are counted down with a beep. After the last beep the measurement is taken and the value is displayed.

 The timer can be used for all measurements.

Working with BLUETOOTH®

Switching on BLUETOOTH® / sending measurements

A quick press on the  - key starts DISTO™ BLUETOOTH®. The data connection must then be established out from Pocket PC / PC by the application software. A grey  - icon will appear in the display until this has been successfully completed. BLUETOOTH® automatically switches off if the connection to the Pocket PC / PC is not established within 240 sec from when the BLUETOOTH® was switched on.

 When the first connection between the Pocket PC/PC and the DISTO™ is being established, a query for the Pin-code of the DISTO™ may be displayed. In such a case, enter the code 0000 into your Pocket PC/PC.

Switching off BLUETOOTH®

BLUETOOTH® switches off as soon as the DISTO™ is switched off.

The direction keys

Eight direction keys (identified by a small arrow near the key) on the operator's keypad are used to manoeuvre the cursor. The direction keys become active when you switch to the second level (by pressing the  key). The distance measuring key is active in both levels. The functionality of the direction keys depends on the software used.





Transmitting the measurement

If your software supports the direction keys use them to select the appropriate position for the cursor.

Press the  button **briefly** to transfer the value from the summary row to the pocket PC / PC.

For further details please consult your manual for the software used.

Selecting particular values in the display

The display shows a number of measurements (min., max., last measurement taken). By pressing and holding the  button you can select all measurements in the display for transmitting (blue lines under the measurements). When you press the  - key or the  - key you can select one specific value. Once selected the measurement can be transmitted using the  - key. The same selection process can be used for areas, volumes, indirect measurements and room dimensions.

During data transmission

If the data is not confirmed as being successfully received by the Pocket PC/ PC then no new measurement can be processed. The Info code "240" appears in the display if no data transmission has taken place after 2 seconds. Press the  - key and repeat the measurement and then transmit it.

 The free software supplied is designed to provide the user with basic functionality. Leica Geosystems provides no warranty for this free software and offers no support for it. Leica Geosystems accepts no liability whatsoever arising from the use of the free software and is not obliged to provide corrections nor to develop updates or upgrades. You can find numerous commercial vendors of software for a wide range of applications on our homepage.

Appendix

Message codes

All message codes are displayed with either  or "Error". The following errors can be corrected:

	Cause	Remedy
156	Transverse tilt greater than 10°	Hold the instrument without any transverse tilt
162	The calibration has not been accomplished on a leveled surface and the calibration value is respectively within an ineligi-ble area.	Calibrate the device on an absolute horizontal leveled surface.
204	Calculation error	Repeat procedure
240	Data transfer error	Repeat procedure
245	2nd button pressed although no Bluetooth connection exists.	Establish Bluetooth connection
252	Temperature too high	Cool down instrument

i	Cause	Remedy
253	Temperature too low	Warm up instrument
255	Receiver signal too weak, measurement time too long, distance > 100 m	Use target plate
256	Received signal too strong	Target too reflective (use target plate)
257	Wrong measurement, background brightness too high	Darken target (measure in different lighting conditions)
260	Laser beam interrupted	Repeat measurement
Error	Cause	Remedy
Error	Hardware error	Switch on/off the device several times. If the symbol still appears, then your instrument is defective. Please call your dealer for assistance.

Technical data

Distance measurements: Measuring accuracy up to 30 m (2 σ)	typically: ± 1.0 mm* ± 0.04 in*
Power Range Technology™: Range (use target plate from about 100 m)	0.05 m to 200 m
Smallest unit displayed	0.1 mm
Distance measurement	✓
Minimum/maximum measurement, Continuous measurement	✓
Area/volume calculation of room data	✓
Addition / subtraction	✓
Indirect measurement using Pythagoras	✓
Trapezium measurement	✓

Tilt measurements: Tilt sensor: Accuracy (2 σ) - to laser beam - to the housing	- 0.1° / +0.2° ** ± 0.1 ° **
Indirect measurement using tilt sensor (direct horizontal distance)	✓
Angle measurement using tilt sensor (360°)	✓
General: Laser class	II
Laser type	635 nm, < 1 mW
Ø laser point (at distances)	6 / 30 / 60 mm (10 / 50 / 100 m)
Autom. laser switch-off	after 3 min
Autom. instrument switch-off	after 6 min
Display illumination	✓
Multifunctional endpiece	✓
Timer (self-triggering)	✓
Save constant value	✓
Historical storage	30 values
BLUETOOTH® 2.0	✓
Range of BLUETOOTH® Cl. 2	10 m
Tripod thread (Type: 1/4-20)	✓
Battery life, Type AA, 2 x 1.5V	up to 5 000 measurements
Protection against splashes and dust	IP 54, dust-proof, splash-proof
Dimensions	143.5 x 55 x 30 mm
Weight (with batteries)	195 g
Temperature range: Storage	-25°C up to +70°C (-13°F up to +158°F)
Operation	-10°C up to +50°C (14°F up to +122°F)

* maximum deviation occurs under unfavourable conditions such as bright sunlight or when measuring to poorly reflecting or very rough surfaces. Measuring accuracy may deteriorate by approx. ± 0.1 mm/m for distances above 30 m. In long range mode the maximum deviation from a distance of 30 m increases to ± 0.15 mm/m.

** applies at room temperature. For the whole operating temperature range the maximum deviation increases by $\pm 0.1^\circ$.

Measuring conditions

Measuring range

The range is limited to 200 m.

At night or dusk and if the target is in shadow the measuring range without target plate is increased. Use a target plate to increase the measurement range during daylight or if the target has poor reflection properties.

Target surfaces

Measuring errors can occur when measuring toward colourless liquids (e.g. water) or dust free glass, Styrofoam or similar semi-permeable surfaces.

Aiming at high gloss surfaces may deflect the laser beam and lead to measurement errors.

Against non-reflective and dark surfaces the measuring time may increase.

Care

Do not immerse the instrument in water. Wipe off dirt with a damp, soft cloth. Do not use aggressive cleaning agents or solutions. Handle the instrument as you would a telescope or camera.

Warranty

The Leica DISTO™ D8 comes with a three* year warranty from Leica Geosystems AG.

More detailed information can be found at: www.disto.com

All illustrations, descriptions and technical specifications may be subject to change without prior notice.

* To receive the three year warranty, the product must be registered on our website www.disto.com within eight weeks of the purchase date. If the product is not registered, a two year warranty applies.

Leica DISTO™ D8

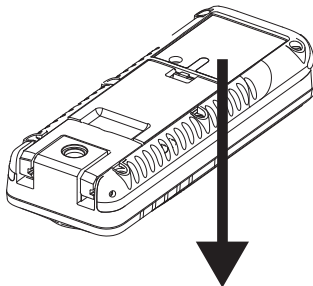

Complies with 21 CFR 1040.10 and 1040.11
except for deviations pursuant to Laser Notice
No. 50, dated June 24, 2007.



 **SWISS Technology**
by Leica Geosystems



IC: 3177A-DIST008
FCC ID: RFF-DIST008

Type: Leica DISTO™ D8

Power: 3V=0.6A

Made in Austria



www.leica-geosystems.com



Leica Geosystems AG, Heerbrugg, Switzerland has been certified as being equipped with a quality system which meets the International Standards of Quality Management and Quality Systems (ISO standard 9001) and Environmental Management Systems (ISO standard 14001).

Total Quality Management - Our commitment to total customer satisfaction.
Ask your local Leica Geosystems agent for more information about our TQM program.



**205 Westwood Ave
Long Branch, NJ 07740
1-877-742-TEST (8378)
Fax: (732) 222-7088
salesteam@Tequipment.NET**



Leica Geosystems AG
CH-9435 Heerbrugg
(Switzerland)
www.disto.com

- when it has to be **right**

