

Using Manometers to Precisely Measure
Pressure, Flow and Level

Precision Measurement Since 1911



Table of Contents

Manometer Principles.....	2
Indicating Fluids.....	5
Manometer Corrections.....	6
Digital Manometers.....	9
Applications Guide	12
Glossary of Pressure Terms.....	16
Pressure Conversions.....	Inside Back Cover

Manometer Principles

The manometer, one of the earliest pressure measuring instruments, when used properly is very accurate. NIST recognizes the U tube manometer as a primary standard due to its inherent accuracy and simplicity of operation. The manometer has no moving parts subject to wear, age, or fatigue. Manometers operate on the Hydrostatic Balance Principle: a liquid column of known height will exert a known pressure when the weight per unit volume of the liquid is known. The fundamental relationship for pressure expressed by a liquid column is

$$p = P_2 - P_1 = \rho gh$$

- p = differential pressure
- P_1 = pressure at the low pressure connection
- P_2 = pressure at the high pressure connection
- ρ = density of the liquid
- g = acceleration of gravity
- h = height of the liquid column

In all forms of manometers (U tubes, well types, and inclines) there are two liquid surfaces. Pressure determinations are made by how the fluid moves when pressures are applied to each surface. For gauge pressure, P_2 is equal to zero (atmospheric reference), simplifying the equation to

$$p = \rho gh$$

U TUBE MANOMETERS

The principles of manometry are most easily demonstrated in the U tube manometer shown in Figure 1. It is simply a glass tube bent to form the letter U and partially filled with some liquid. With both legs of the instrument open to atmosphere or subjected to the same pressure, the liquid maintains exactly the same level or a zero reference.

As illustrated in Figure 2, if a pressure is applied to the left side of the instrument, the fluid recedes in the left leg and raises in the right leg. The fluid moves until the unit weight of the fluid as indicated by H exactly balances the pressure. This is known as hydrostatic balance. The height of fluid from one surface to the other is the actual height of fluid opposing the pressure.

The pressure is always the height of fluid from one surface to the other regardless of the shape or size of the tubes, as illustrated in Figure 3. The left-hand

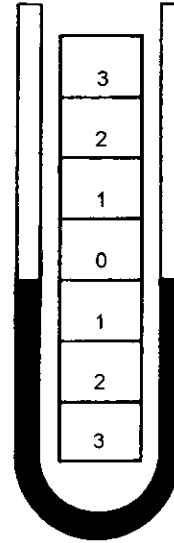

Figure 1

manometer has a uniform tube, the center one has an enlarged leg and the right-hand one has a irregular leg. Manometers in Figure 3 are open to atmosphere on both legs so the indicating fluid level in both legs is the same. Imposing an identical pressure on the left leg of each manometer, as shown in Figure 4, causes the fluid level in each manometer to change. Because of the variations in volume of the manometer legs, the distances moved by the fluid columns are different. However, the total distance between the fluid levels, H , remains identical in the three manometers.

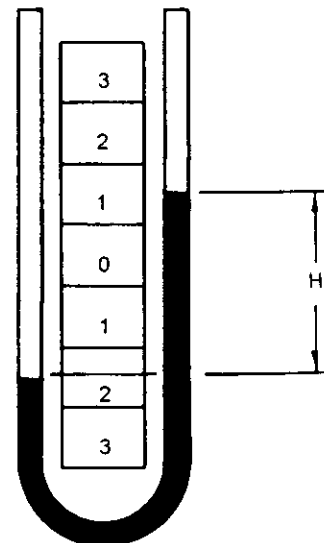

Figure 2

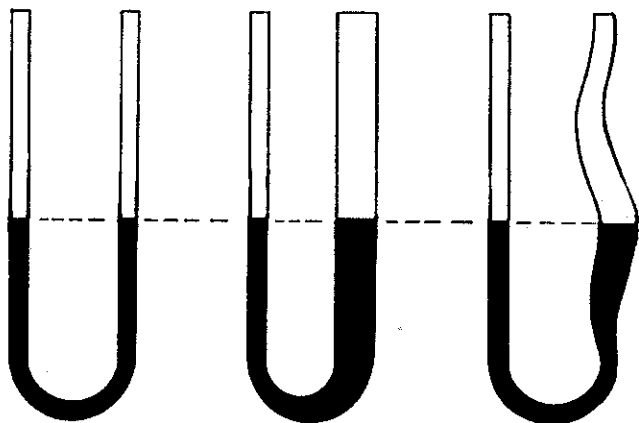

Figure 3

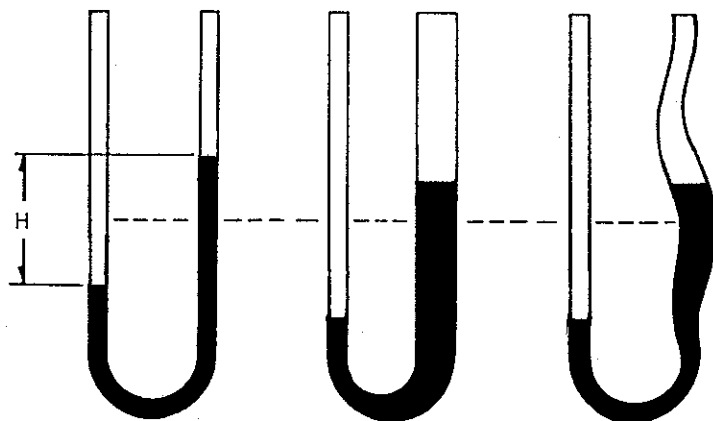

Figure 4

WELL TYPE MANOMETERS

The principles of manometry have been discussed using the U tube manometer as an example. However, the manometer has been arranged in other forms to provide greater convenience and to meet varying service requirements. The well type manometer is one of these variations. As illustrated in Figure 5, the cross-sectional area of one leg of the manometer is many times larger than the area of the other leg. The larger area leg is called the well. As pressure is applied to the larger leg, the fluid moves down a minuscule amount compared to the increase in height of the small leg. This design results in an ideal arrangement whereby you read only one convenient scale adjacent to a single indicating tube rather than the dual scale in the U tube.

The true pressure reading follows the principles previously outlined and is measured by the difference between the fluid surfaces H. As pressure is applied

at P there must be some drop in the well level D. This is readily compensated for by spacing the scale graduations in the exact amount required to correct for this well drop. To insure the accuracy of this correction, the well area and internal diameter of the indicating tube must be carefully controlled.

Thus, the well type manometer lends itself to use with direct reading scales graduated in units for the process or test variable involved. It does require certain operational restrictions not found on the U tube. A pressure higher than atmospheric is always connected to the well; a pressure lower than atmospheric is always connected to the top of the tube. For a differential pressure, the higher pressure is connected at the well. A raised well manometer, however, allows both gauge and vacuum measurements off of the well port.

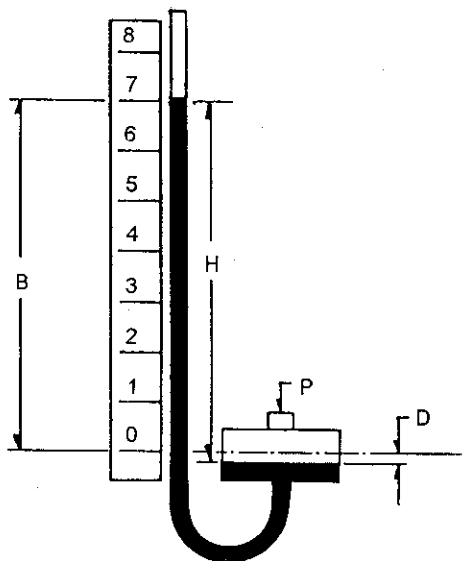

Figure 5

INCLINED MANOMETERS

Many applications require accurate measurement of low pressure such as drafts and very low differentials. To better handle these applications the manometer is arranged with the indicating tube inclined, as in Figure 6, providing for better resolution. This arrangement can allow 12" of scale length to represent 1" of vertical liquid height. With scale subdivisions, a pressure of 0.00036 psi (one hundredth of an inch of water) can be read.

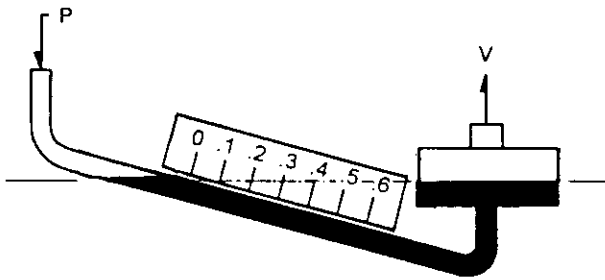

Figure 6

ABSOLUTE MANOMETERS

In an absolute pressure manometer, the pressure being measured is compared to absolute zero pressure (a perfect vacuum) in a sealed leg above a mercury column, as shown in Figure 7. The term absolute zero pressure is derived from the definition that a perfect vacuum is the complete absence of any gas. The most common form of sealed tube manometer is the conventional mercury barometer used to measure atmospheric pressure. Mercury is the only fluid used in this application. In this type of manometer there is only one connection from which both pressure above atmospheric and pressure below atmospheric can be measured. Absolute manometers are available in well type or U tube configurations.

PRESSURE REFERENCES

All types of pressure references are readily measured

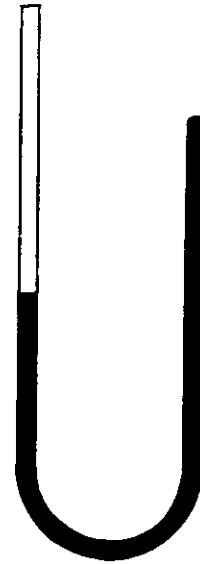

Figure 7

with the manometer. Connecting one leg of a U tube to a positive pressure source and leaving the other open to atmosphere is a gauge pressure measurement. Thus gauge pressures fluctuate with changes in atmospheric pressure. Adding the atmospheric pressure to the indicated gauge pressure converts the reading into absolute pressure units. If, however, our air supply line should be changed to a vacuum line, the only effect is reversed movement of the fluid. It would rise in the connected leg and recede in the open leg. This is a vacuum or negative pressure reading. Subtracting this indicated gauge pressure reading from atmospheric pressure converts the reading into absolute pressure units.

INDICATING FLUIDS

By selection of an indicating fluid, the sensitivity, range, and accuracy of the manometer can be altered. Indicating fluids are available with densities from 0.827 g/cm^3 Red Oil to 13.54 g/cm^3 for Mercury. For an indicating fluid three times heavier than water, the pressure range would be three times greater and the resolution, one third as great. An indicating fluid with a density less than water, decreases the range and increases the resolution (sensitivity). For a given instrument size, the pressure range can be expanded by using a fluid with higher density and reduced by using a fluid with lower density. Meriam has standard indicating fluids with properties as described in the adjacent chart of manometer indicating fluids.

INCLINED MANOMETERS

Many applications require accurate measurement of low pressure such as drafts and very low differentials. To better handle these applications the manometer is arranged with the indicating tube inclined, as in Figure 6, providing for better resolution. This arrangement can allow 12" of scale length to represent 1" of vertical liquid height. With scale subdivisions, a pressure of 0.00036 psi (one hundredth of an inch of water) can be read.

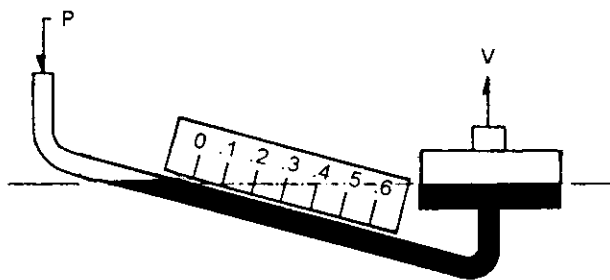

Figure 6

ABSOLUTE MANOMETERS

In an absolute pressure manometer, the pressure being measured is compared to absolute zero pressure (a perfect vacuum) in a sealed leg above a mercury column, as shown in Figure 7. The term absolute zero pressure is derived from the definition that a perfect vacuum is the complete absence of any gas. The most common form of sealed tube manometer is the conventional mercury barometer used to measure atmospheric pressure. Mercury is the only fluid used in this application. In this type of manometer there is only one connection from which both pressure above atmospheric and pressure below atmospheric can be measured. Absolute manometers are available in well type or U tube configurations.

PRESSURE REFERENCES

All types of pressure references are readily measured

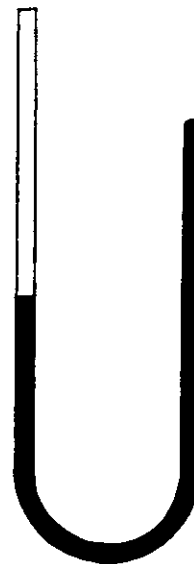

Figure 7

with the manometer. Connecting one leg of a U tube to a positive pressure source and leaving the other open to atmosphere is a gauge pressure measurement. Thus gauge pressures fluctuate with changes in atmospheric pressure. Adding the atmospheric pressure to the indicated gauge pressure converts the reading into absolute pressure units. If, however, our air supply line should be changed to a vacuum line, the only effect is reversed movement of the fluid. It would rise in the connected leg and recede in the open leg. This is a vacuum or negative pressure reading. Subtracting this indicated gauge pressure reading from atmospheric pressure converts the reading into absolute pressure units.

INDICATING FLUIDS

By selection of an indicating fluid, the sensitivity, range, and accuracy of the manometer can be altered. Indicating fluids are available with densities from 0.827 g/cm^3 Red Oil to 13.54 g/cm^3 for Mercury. For an indicating fluid three times heavier than water, the pressure range would be three times greater and the resolution, one third as great. An indicating fluid with a density less than water, decreases the range and increases the resolution (sensitivity). For a given instrument size, the pressure range can be expanded by using a fluid with higher density and reduced by using a fluid with lower density. Meriam has standard indicating fluids with properties as described in the adjacent chart of manometer indicating fluids.

Indicating Fluids

1000 GREEN CONCENTRATE A specially prepared concentrate which, when mixed with distilled water, makes an indicating fluid of low surface tension and practically zero hysteresis. This fluid keeps indicating tubes clean and is used for high precision work. Density and physical properties are identical to water. Non-corrosive to brass, glass, stainless steel, and aluminum.

Specific Gravity: 1.000 @ 55° F
Temperature Range: 40° to 120° F

Vapor Pressure: 20mm Hg @ 20° C
Flash Point: Non-flashing

827 RED OIL This fluid is non-corrosive and recommended for general use in manometers, draft gauges, air flow meters, etc., where a light fluid is desirable and where extremes in temperature are not encountered.

Specific Gravity: 0.827 @ 60° F
Temperature Range: 40° to 120° F

Vapor Pressure: 1mm Hg @ 20° C
Flash Point: 142° F

100 RED UNITY OIL A non-corrosive oil mixture. Prepared for general use where a fluid near the gravity of water is desired, but water itself is unsuitable.

Specific Gravity: 1.00 @ 73° F
Temperature Range: 30° to 100° F

Vapor Pressure: 1mm Hg @ 20° C
Flash Point: 285° F

104 HI-VAC RED FLUID (DIBUTYL PHTHALATE) A low vapor pressure liquid specially suited for high vacuum applications. Teflon gasketing is required. Non-corrosive and insoluble in water.

Specific Gravity: 1.04 @ 80° F
Temperature Range: 20° to 150° F

Vapor Pressure: 0.00001mm Hg. @ 20° C
Flash Point: 340° F

175 BLUE FLUID (X-DI BROMOETHYBENZENE) A highly stable heavy liquid for use in manometers and flow meters. Low viscosity, non-corrosive, insoluble and with a clear interface in water.

Specific Gravity: 1.75 @ 56° F
Temperature Range: -70° F to 150° F

Vapor Pressure: 0.05mm Hg @ 20° C
Flash Point: Non-flashing

200 BLUE FLUID (X-DI BROMOETHYBENZENE) Same as 175 Blue fluid. This fluid is normally used by Meriam in acrylic incline manometers.

Specific Gravity: 2.00 @ -17° F
Temperature Range: -70° F to 150° F

Vapor Pressure: 0.05mm Hg @ 20° C
Flash Point: Non-flashing

295 NO. 3 RED FLUID (ACETYLENE TETRABROMIDE) A heavy bromide. Non-toxic, but all parts in contact with fluid must be of brass, glass, or stainless steel. Corrosive to steel.

Specific Gravity: 2.95 @ 78° F
Temperature Range: 40° to 100° F

Vapor Pressure: 0.02mm Hg @ 20° C
Flash Point: Non-flashing

HI-PURITY MERCURY A specially treated mercury of the highest purity. Gives a bright, sharp meniscus. Used in all applications where the heaviest density is required for maximum range and where chemical reaction is not encountered. Cannot be used in aluminum or brass instruments.

Specific Gravity: 13.54 @ 71.6° F
Temperature Range: -30° to 200° F

Vapor Pressure: 0.001mm Hg @ 20° C
Flash Point: N/A

Manometer Corrections

As simple as manometry is, certain aspects are often overlooked. Manometry measurements are functions of both density and gravity. The values of these two are not constant. Density is a function of temperature, and gravity is a function of latitude and elevation. Because of this relationship specific ambient conditions must be selected as standard, so that a fixed definition for pressure can be maintained.

Standard conditions for mercury:

Density	13.5951 g/cm ³ at 0° C (32° F)
Gravity	980.665 cm/sec ² (32.174 ft/sec ²) at sea level and 45.544 degrees latitude

Standard conditions for water:

Density	1.000 g/cm ³ at 4° C (39.2° F)
Gravity	980.665 cm/sec ² (32.174 ft/sec ²) at sea level and 45.544 degrees latitude

The universal acceptance of a standard for water has been slow. Meriam has chosen 4° C as its standard. This temperature has been chosen due to the density being 1.000 g/cm³. Other institutions have chosen different standards, for instance in aeronautics 15° C (59° F) is used. The American Gas Association uses 15.6° C (60° F). The Instrument Society of America (ISA) has chosen 20° C (68° F) as its standard.

Recognizing that manometers may be read outside standard temperature and gravity, corrections should be applied to improve the accuracy of a manometer reading at any given condition.

FLUID DENSITY CORRECTION

Manometers indicate the correct pressure at only one temperature. This is because the indicating fluid density changes with temperature. If water is the indicating fluid, an inch scale indicates one inch of water at 4° C only. On the same scale mercury indicates one inch of mercury at 0° C only. A reading using water or mercury taken at 20° C (68° F) is not an accurate reading. The error introduced is about 0.4% of reading for mercury and about 0.2% of reading for water. Since manometers are used at temperatures above and below the standard temperature, corrections are

needed. A simple way of correcting for density changes is to ratio the densities.

$$(\text{Standard}) p_0 g h_0 = (\text{Ambient}) p_t g h_t$$

$$h_0 = \frac{p_t}{p_0} \times h_t$$

- h_0 = corrected height of the indicating fluid to standard temperature
- h_t = height of the indicating fluid at the temperature when read
- p_0 = density of the indicating fluid at standard temperature
- p_t = density of the indicating fluid at the temperature when read

This method is very accurate, when density/temperature relations are known. Data is readily available for water and mercury.

Density (g/cm³) as a function of temperature (°C) for mercury is

$$13.556786 (1 - 0.0001818(T - 15.5556))$$

Density (g/cm³) as a function of temperature (°C) for water is

$$0.9998395639 + 6.798299989 \times 10^{-5} (T) - 9.10602556 \times 10^{-6} (T^2) + 1.005272999 \times 10^{-7} (T^3) - 1.126713526 \times 10^{-9} (T^4) + 6.591795606 \times 10^{-12} (T^5)$$

For other fluids, manometer scales and fluid densities may be formulated to read inches of water or mercury at a set temperature. This temperature is usually ambient temperature. This decreases the error due to temperature change, because most manometers are used at or close to ambient temperatures. In some work direct readings close to design temperature are accurate enough. The manometer still only reads correct at one temperature, and for precise work the temperature corrections cannot be overlooked. Temperature versus density data can be supplied for all Meriam indicating fluids.

GRAVITY CORRECTION

The need for gravity correction arises because gravity at the location of the instrument governs the weight of the liquid column. Like the temperature correction, gravity correction is a ratio.

$$(\text{Standard}) p_o g_o h_o = (\text{Ambient}) p_t g_t h_t$$

$$h_o = \frac{g_t p_t}{g_o p_o} \times h_t$$

g_o = standard gravity - 980.665 cm/s² (45.54° N latitude and sea level)

g_t = gravity at the instruments location

A 10° change in latitude at sea level will introduce approximately 0.1% error in reading. At the Equator (0°) the error is approximately 0.25%. An increase in elevation of 5000 ft. will introduce an error of approximately 0.05%.

Gravity values have been determined by the U.S. Coast and Geodetic Survey at many points in the United States. Using these values, the U.S. Geodetic Survey can interpolate to determine a gravity value sufficient for most work. To obtain a gravity report, the instruments latitude, longitude, and elevation are needed. For precise work you must have the value of the gravity measured at the instrument location.

Where a high degree of accuracy is not necessary and values of local gravity have not been determined, calculations for differences from local gravity can be obtained. Gravity at a known latitude is

$$g_x = 980.616 (1 - 0.0026373 \cos 2x + 0.0000059 \cos^2 2x)$$

g_x = gravity value at latitude x, sea level (cm/sec²)

x = latitude (degrees)

Gravity at elevations above sea level is

$$g_t = g_x - 0.000094H + 0.00003408(H - H^1)(\text{cm/sec}^2)$$

H = elevation (feet) above mean sea level

H¹ = average elevation (feet) of the general terrain within a radius of 100 miles of the point.

The second term may be eliminated when H¹ is unknown, but the accuracy of the gravity determination will decrease. The degree of inaccuracy is determined by how far H¹ varies from H. In mountainous terrain this error could be large.

PRESSURE HEAD CORRECTION

Commonly a differential pressure is measured by the height of the fluid column. Actually the differential

pressure, measured by the indicating fluid height, is the difference between density of the fluid column and the density of equal height of the pressure medium. This is illustrated in Figure 8. The density

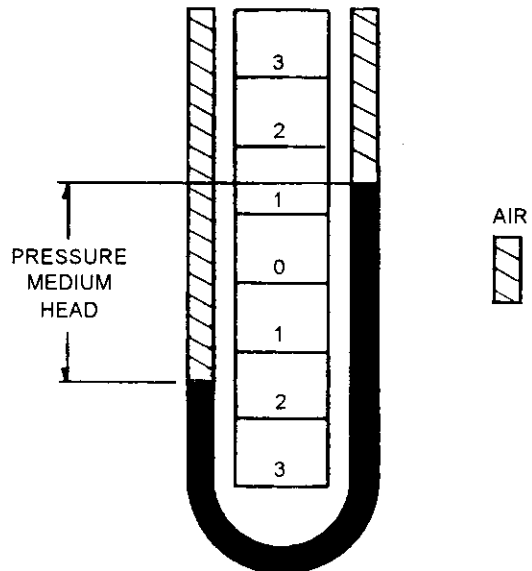

Figure 8

of the latter column is defined as the head correction. The relationship is

$$p_o g_o h_o + p_m g_t h_t = p_t g_t h_t$$

$$h_o = \frac{g_t (p_t - p_{pm})}{g_o p_o} \times h_t$$

The significance of the pressure medium correction effect on the manometer reading varies with indicating fluid and pressure medium. Whether this correction is necessary, depends upon the user's accuracy requirements. The most common pressure medium is air. Not correcting for air over water yields an error of 0.12% (using the density of air as 0.0012 g/cm³). In precise work air density can be determined exactly knowing the temperature, pressure and relative humidity of the air. The correction for air over mercury is extremely small (0.008% error) and therefore may usually be ignored.

Another combination often used in flow applications, is water over mercury. The pressure medium correction in this situation is mandatory. An error of 7.4% is introduced if the correction is not applied. In many instances manometer scales can be designed with this correction built in.

SCALE CORRECTION

As with the indicating fluids, temperature changes affect the scale. At higher temperatures the scale will expand and the graduations will be further apart. The opposite effect will occur at lower temperatures. All Meriam scales are fabricated at a 22° C (71.6° F) temperature. A ten degree C shift in temperature from that at which the scale was manufactured will induce an error in the reading of about 0.023% in an aluminum scale. All Meriam scales are made of aluminum. This correction may be ignored when working within ± 10° C of the temperature at which the scale was manufactured.

$$h_o = h_i(1 + \alpha(T - T_o))$$

- α = coefficient of expansion for the scale material
= 0.000232/°C for aluminum
T = temperature when the manometer was read
T_o = temperature when the scale was manufactured

COMPRESSIBILITY

Compressibility of indicating fluids is negligible except in a few applications. For compressibility to have an effect, the manometer must be used in measuring high differential pressures. At high differential pressures the fluid shrinkage (increase in density) may begin to be resolvable on the manometer. At 250 psi the density of water changes approximately 0.1%. Depending upon accuracy requirements compressibility may or may not be critical. The relationship between pressure and density for water is

$$\rho = 0.000003684p + 0.9999898956$$

- ρ = density of water (g.cm³) at 4° C and pressure p
p = pressure in psia

Since the need to correct is very rare, other indicating fluid's compressibilities have not been determined. Mercury's compressibility is negligible.

ABSORBED GASES

Absorbed gases are those gases found dissolved in a liquid. The pressure of dissolved gases decreases the density of the liquid. Air is a commonly dissolved gas that is absorbed by most manometer fluids. The density error of water fully saturated with air is .00004% at 20° C. The effect is variable and requires

consideration for each gas in contact with a particular fluid. Mercury is one exception in which absorbed gases are not found. This makes mercury an excellent manometer fluid in vacuum and absolute pressure applications. Along with mercury, Meriam produces 104 Hi-Vac Red Fluid (Dibutyl Phthalate - 1.04g/cm³ @ 80° F). This fluid has a very low vapor pressure (0.00001mm Hg). This makes it a good choice as an indicating fluid for vacuum applications. The low vapor pressure prevents the loss of fluid from evaporation and in some instances prevents contamination from condensation of the indicating fluid in the test set-up. It cannot be used in absolute units, because it absorbs gases easily.

CAPILLARY CONSIDERATIONS

Capillary effects occur due to the surface tension or wetting characteristics between the liquid and the glass tube. As a result of surface tension or wetting, most fluids form a convex meniscus. Mercury is the only indicating fluid which does not wet the glass and consequently, forms a concave meniscus. For consistent results, you must always observe the fluid meniscus in the same way, whether convex or concave. To help reduce the effects of surface tension, manometers should be designed with large bore tubes. This flattens the meniscus, making it easier to read. A large bore tube also helps fluid drainage. The larger the bore the smaller the time lag while drainage occurs. Another controlling factor is the accumulation of corrosion and dirt on the liquid surface. The presence of foreign material changes the shape of the meniscus. With mercury it also helps to tap or vibrate the tube to reduce error in the readings. A final note to capillary effects is the addition of a wetting agent to the manometer fluid. Adding the wetting agent helps in obtaining a symmetrical meniscus. This decreases the difficulty in making readings. A wetting agent is not needed with all fluids but is added to Meriam 1000 Green Concentrate.

ACCURACY

A typical water manometer has an accuracy of 0.1 inches of water, a manometer with a vernier has an accuracy of 0.01 inches of water, while a manometer equipped with a micrometer can provide an accuracy of 0.002 inches of water.

Digital Manometers

What is an inch of water? The correct answer to this question has taken on increased importance with the demand for better accuracy and the introduction of digital manometers. For example, let's assume that you have just received your new digital manometer and you decide to verify its accuracy. The manufacturer claims 0.1% accuracy at 100 inches of water. You set up a test using a deadweight tester and a water manometer. After placing a 100 inch of water weight on the deadweight tester, you record a reading of 99.8 inches of water on the digital manometer and 100.2 inches of water on the manometer. Which is right? The answer to this question will be evident after the following discussion of manometers and dead weight testers and their relationship to digital manometers. There will also be a discussion of digital manometer accuracy and resolution.

Manometers – The manometer is considered a primary standard since the pressure exerted by the liquid column can be accurately determined by the measurement of basic physical properties: the height of the column and the density of the liquid. For a manometer filled with water the pressure equation is

$$p = \frac{(g_i/g_o)(\rho_w - \rho_a)h}{\rho_o}$$

- g_i = gravity at instrument location
- g_o = standard gravity (980.665 cm/sec²)
- ρ_a = density of air at observed temperature
- ρ_w = density of water at observed temperature
- ρ_o = density of water at standard temperature
- h = height of water column in inches

Notice that in order to determine the pressure indicated by the height of a water column one needs to know more than the height of the column. Both the local gravity and the density of the manometer fluid and the fluid being measured, in this case water and air, need to be known. As can be seen, the pressure indicated by an inch of water varies with location and temperature. In order to make the readings comparable they must be reported at the same temperature and gravity. The three commonly used reference conditions for water columns are shown on the table below.

Standard	Temperature	Gravity
Scientific	4° C (39.2° F)	980.665
AGA	15.6° C (60° F)	980.665
Industrial	20° C (68° F)	980.665

There is only one commonly used reference condition for mercury columns: 0° C (32° F) and 980.665 cm/sec². The use of the wrong temperature reference for water columns can produce errors of 0.1% to 0.2%. The failure to correct a mercury column from an observed temperature of 68° F can produce an error of 0.36%. Figure 9 shows the errors at different latitudes caused by not correcting for gravity.



Figure 9

Consider the example presented earlier where the manometer indicated 100.2 inches of water and the digital manometer indicated 99.8 inches of water. In order to correct the manometer to reference conditions, some additional information is needed. The test was conducted in Corpus Christi, Texas at an ambient temperature of 27° C (80.6° F). The digital manometer displays water column referenced to 20° C.

The gravity correction factor is the gravity at 28° north latitude divided by the standard gravity (979.185/980.665 = 0.9985). The temperature correction factor is the specific gravity at the ambient temperature minus the specific gravity of air divided by the specific gravity at the reference temperature ((0.99654 - 0.0012)/0.9983) = 0.997. Therefore the manometer reading corrected to reference conditions is shown below.

$$(100.2)(0.9985)(0.997) = 99.85" @ 20° C$$

Notice the close agreement between this and the digital manometer reading.

The use of a water manometer is not practical for field calibrations since a manometer with a range of 100 inches of water would be over 8 feet tall. A solution to this problem is to substitute a heavy liquid, such as mercury, for the water and to adjust the scale to read in inches of water. This reduces the scale by a factor of 13.59, the ratio of the specific gravity of mercury to that of water. Although this reduces the scale length to less than 8 inches, it also reduces the scale resolution and therefore its accuracy. Typical accuracy for this type of manometer is 0.25 inches of water. This type of manometer can be read directly only at the conditions for which the scale was calculated. A typical scale would read inches of water referenced to 4° C when observed at 22° C at a gravity of 980.665 cm/sec². Corrections must be calculated if any of the conditions vary from those at which the scale was calculated. The manometer is an accurate pressure indicating device if the specific gravity of the manometer fluid is accurately known and the correction factors are properly applied.

Dead Weight Tester – Dead weight testers are the most accurate pressure sources available. Unlike manometers that measure pressure, dead weight testers generate accurate pressures. The pneumatic dead weight tester balances a known weight on a column of air from a nozzle of known area. Since the weight and the area can be accurately measured, the pressure generated can be determined by dividing the weight by the area. The dead weight tester is considered a primary standard since both weight and area are properties that can be easily and accurately measured. Dead weight testers with accuracies of 0.015% are readily available.

Dead weight testers also require correction factors to determine the actual pressure generated. In the evaluation example presented earlier, the digital manometer and the manometer are in agreement at 99.8 inches of water but the dead weight tester has a 100 inches of water weight. Dead weight testers are calibrated at a set of reference conditions. In this case the reference conditions are 20° C and 980.665 cm/sec². Because the dead weight is operating at a different gravity, the same gravity correction must be applied to the dead weight tester as to the manometer.

$$(100)(0.9985) = 99.85" @ 20^{\circ} C$$

Notice that after applying the correction factors all three of the instruments agree within their specified

accuracies. If the reference temperature were 15.6° C additional correction factors would have to be applied to the dead weight tester and the manometer. Dead weight testers can be calibrated at different temperature references and gravities. The certificate of calibration for the dead weight tester will indicate the reference conditions used for its calibration.

Since dead weight testers do not indicate the pressure output one must be sure that there are no leaks in the system. A leak will cause the pressure at the instrument under test to be lower than that indicated by the weights. A dead weight tester is a precision piece of equipment and should be carefully maintained and operated in a clean environment to insure its accuracy. Because of its high accuracy, the dead weight tester is the recommended pressure source for evaluating digital manometers.

EVALUATING DIGITAL MANOMETERS

The digital manometer is a recent addition to field calibration instrumentation. These instruments are light weight, approximately 1 pound, and are available with accuracies from 0.2% to 0.025%. Their accuracy places them between the manometer and the dead weight tester, while their size and weight make them more convenient for field calibration. Most available instruments have a 3½ or 4½ digit display with resolution down to 0.01 inches of water. Digital manometers are not primary standards and their accuracy should be verified periodically against a primary standard. When digital manometers are calibrated with properly corrected primary standards they require no further correction to indicate within their stated accuracy.

The evaluation of a digital manometer begins by comparing the manufacturer's published accuracy ratings. This is not as simple as it appears, since there is no standard format for accuracy statements. For example, one manufacturer may include the temperature coefficient of error in the accuracy rating by specifying the accuracy over a specific temperature range while another manufacturer may state the temperature coefficient separately. To compare these specifications, the temperature error would have to be calculated over the operating temperature range and added to the accuracy rating. Compare the following:

0.1% F.S. 0 - 40°C
0.1% F.S. + 0.01%/°C

Although both units are 0.1% F.S. the latter unit is within this limit only at its calibration temperature of 20° C. To equate the two we must multiply the temperature coefficient by the temperature difference between 20° C and 40° C $((0.01)(20) = 0.2\%)$. Adding this to the 0.1% accuracy at 20° C yields an accuracy of 0.3% F.S. over the temperature range of 0° C to 40° C. Therefore, the first unit is more accurate than the second unit. Always look for a statement of temperature effect. All pressure indicators are affected by temperature and manufacturers use various methods to minimize these effects. The manufacturer that does not document temperature effect is either unaware of it or unwilling to make it known to the consumer.

The accuracy rating indicates the limit that errors will not exceed when the instrument is operated under the specified conditions. An accuracy rating normally includes linearity, hysteresis and dead band. If the specifications state the accuracy components separately, then they must be combined to determine the total accuracy rating. The method recommended by the Instrument Society of America is to take the square root of the sum of the squares of the accuracy components. Since the accuracy rating is stated at specified conditions, your evaluation tests must be conducted under the same conditions. For example, if the accuracy is specified at 70° F then the evaluation tests should be conducted at that temperature; otherwise an additional error factor may be introduced by the temperature coefficient of accuracy.

Accuracy can be expressed in several different ways. Among them are

- Percent of span
- Percent of full scale
- Percent of reading

The tightest method of expressing accuracy is percent of reading while the most common is percent of full scale. An instrument with a range of 200 inches of water and an accuracy rating of 0.1% of full scale will have an error of +/-0.2 inches of water at any reading. Therefore, at 10 inches of water, the error would be 0.2 inches of water or 2% of reading. The actual error at each test point will have to be calculated before proceeding with the evaluation.

Resolution is a very important specification in digital instruments. Resolution is defined as the smallest

increment that can be distinguished or displayed. The following relationship exists between accuracy and resolution: resolution can exceed accuracy but accuracy can not exceed resolution. A 3½ digit instrument divides the input signal into 1999 parts. The smallest increment that can be displayed is 1 part in 1999 or 0.05% of full scale. This would limit the accuracy of this instrument to 0.05% of full scale. Although decreasing the resolution will decrease the accuracy of the instrument, increasing the resolution will not increase the accuracy. For example, a 0.05% of full scale instrument with a 4½ digit display has a resolution of 0.005% of full scale, since the accuracy does not change, the additional digit provided by the increased resolution is meaningless. Do not assume that all displayed digits are significant; compare the accuracy to the resolution to determine how many digits are significant.

After determining the error limits for each test point, the instrument evaluation can proceed. An instrument or pressure source with an accuracy of between 3 and 10 times that of the instrument under evaluation should be used. A dead weight tester with an accuracy of 0.015% of reading is recommended. If the evaluation is being conducted in inches of water, then the following information must be known: the reference temperature at which the dead weight tester was calibrated; and the reference temperature at which the instrument was calibrated. This is very important since the indicated error between different reference temperatures can be as much as 0.2%. In addition, all appropriate correction factors, especially gravity, must be applied to the dead weight tester and there must be no leaks in the system.

The minimum number of recommended test points is two. These should be at 50% and 100% of each range of the instrument. A more stringent test would involve four test points, at 25%, 50%, 75% and 100% of each range. A full ten point test is usually not required to evaluate an instrument, but it does provide the most detailed information about the instrument.

The digital pressure indicator is an ideal instrument for field calibration of transmitters and recorders. It is lightweight, accurate, and easy to use. The selection of an acceptable instrument can be simplified with an understanding of accuracy specifications. The evaluation of an instrument's accuracy requires a thorough knowledge of the primary standard used and the correction factors required.

Applications Guide

PRESSURE TRANSMITTER CALIBRATION

High accuracy digital manometers/calibrators are particularly useful as calibrators for pressure transmitters, pressure recorders, and other pressure measuring devices. A typical set-up for transmitter calibration is shown at the right. The digital manometer is connected through a tee to a transmitter and a pressure source (often a hand pump). The 4 - 20 ma output from the transmitter is also connected to the digital manometer. An auxiliary loop supply (if needed) provides 24v DC power to the transmitter.

After zeroing the digital manometer, and with zero pressure applied to the transmitter, the transmitter is adjusted for a 4 mA output. This output is read on the current display of the digital manometer.

Next, the pressure source is adjusted to the full scale pressure of the transmitter. A calibrator class digital manometer will indicate this pressure to an accuracy of 0.05% of reading, and a good hand pump will set this pressure to a resolution of 0.01" H₂O. The transmitter output is adjusted for a 20 mA output, which is again read on the current display of the

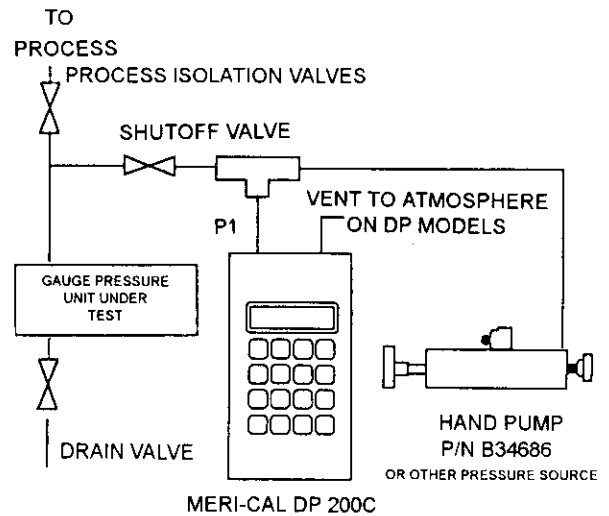

digital manometer. Compared to other calibration techniques, a digital manometer calibration is fast and simple. There are no cumbersome boxes, gas cylinders, regulators or weights to set up; and no special platforms or critical procedures for leveling.

TANK GAUGING

Many people like the advantages of using a hydrostatic measurement to determine liquid levels in tanks. These measurements are made with bubblers, or for non-pressurized tanks with a direct head technique. Manometers and mechanical gauges are used in this application because of their simplicity of installation and calibration and because of their high accuracy at a low price.

There are, however, some drawbacks. One is that many manufacturers use a single tank for different process fluids. These fluids often have different densities. Failure to correct for these changes in density can result in substantial errors in the volumetric measurement. Correcting for these changes by recalibrating the gauge or by using tables to look up the quantities in the tank is cumbersome. Another drawback to manometers and mechanical gauges is their inability to interface with PLC's and computers.

New smart pressure gauges (panel mount versions of a digital manometer) address these concerns. They can be easily programmed for changes in a fluid's

density. Once these adjustments are made the gauge gives a direct readout in volumetric units for the tank fluid. These gauges also include communication such as 4 - 20 mA outputs, RS-232C and SPDT relays.

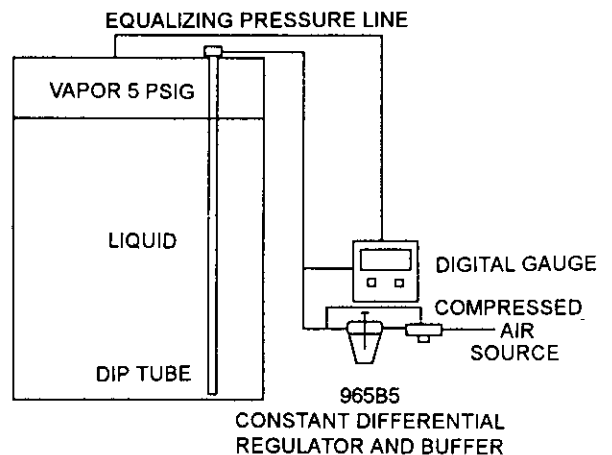

AIR FLOW

Air flow measurement is involved in a number of industrial processes such as heat treating and quenching (cooling). In these processes the product must be shielded from gases that have a debilitating effect. An example of this is oxidation. To prevent these problems, inert gases such as nitrogen or argon are flowed over the product, shielding it from harmful gases.

Generally, the gases are flowed at a low flow rate and pressure. Therefore, pressure loss and a minimal restriction to flow are important factors in determining what sort of flow measurement device will be used. In these flow ranges, the DP produced by pitot tubes, orifice plates or laminar flow elements are in the 0.5" to 8" H₂O range. This requires draft range gauges, such as incline manometers, for higher accuracies. Mechanical gauges for the DP range generally have accuracies of only 3% to 5% full scale. Neither device has an output signal for flow totalizing and data logging or for controlling the process.

Smart pressure gauges/manometers have accuracies that surpass mechanical gauges in these low DP

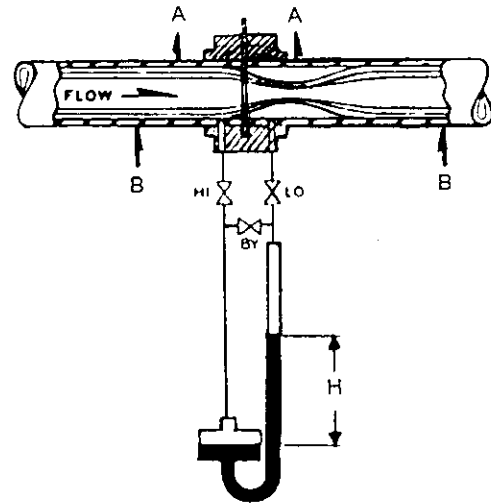

ranges. They also are programmable allowing the gauge to read out in volumetric flow rates. This, coupled with the available outputs, insures that the right amount of gas is flowing over the product at all times. It also allows efficient tracking of gas usage.

TESTING PRESSURE SWITCHES

Several new features recently incorporated into the design of smart digital manometers simplify the testing of pressure switches and other pressure relief devices such as rupture disks. One of these features is settable damping or response rate. Smart manometers have response rates as fast as 0.1 seconds and can capture rapidly changing pressure signals. A problem that arises, however, is that although the internal microprocessor of a smart manometer can keep up with fast changes in pressure, often the human eye cannot follow changes in a flickering display.

To address this problem a min/max feature is added to smart manometers. With this feature, the minimum and maximum pressures sensed by the smart manometer are captured by the microprocessor and shown on a separate line of the display. The test set-up is shown at the right.

The smart manometer is adjusted for a response time of 0.1 seconds. It is then connected thru a tee to the pressure switch and a pressure source. Last, it is put in the min/max mode to make the measurement. To run

the test, pressure is applied through the tee to the smart manometer and the pressure switch until the switch activates. The max display reading indicates the activation point (i.e. the pressure limit).

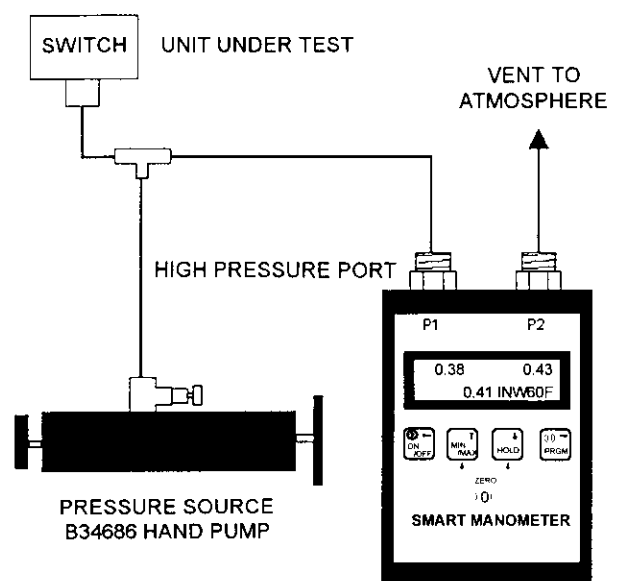

VACUUM/ABSOLUTE MEASUREMENTS.

Power Plants – In power plants mercury absolute manometers have been used to check condenser efficiency by monitoring vacuum at several points on the condenser. The requirement to eliminate mercury, coupled with the need for more interactive instrumentation, leads to the consideration of smart pressure gauges for these needs. RS-232C and 4-20 ma outputs simplify data logging, making it easier to document test results. Temperature effects are unimportant because a smart pressure gauge corrects for effects between -4° and 122° F; enabling location of the gauge anywhere in the plant.

Refrigeration and HVAC – Prior to filling an air conditioner or refrigerator with freon, a complete vacuum must be pulled on the system. Mercury absolute manometers are often used for this measurement. Besides the mercury problem, these units do not provide the outputs that are needed to automate the compressor filling process. In addition the resolution and accuracy of the manometers do not meet current customer requirements. Smart pressure gauges handles these requirements quite well. Resolution on a

2000 mm Hg absolute unit is 0.1 mm Hg. The options for SPDT Relays, RS-232C or 4-20 ma outputs meet nearly all of the requirements for controlling the evacuation and filling process. Finally, the 316SS isolated sensor makes the unit compatible with the various gases that are found in compressors.

Plastics Industry – Most plastic manufacturing processes are done with plastic resins. A vacuum blanket over the process insures that the resins stay liquefied. If a vacuum is not maintained, the plastic product will begin to solidify. Absolute manometers are used to measure the vacuum in the reactors and at the liquid ring vacuum pump. Even in plants where vacuum transmitters have been installed, absolute manometers are kept for local indication and as backup. A major drawback to using mercury manometers is the possibility that some of the liquid ring vacuum pump seal water, which can be caustic and acidic, can get into the manometer and contaminate the mercury. An absolute digital pressure gauge with 316SS sensors takes care of these problems. In addition to being a local indicator, it can be used as an alarm switch or as an alternative to transmitters.

POSITIVE DISPLACEMENT METER TESTING

Positive displacement meters are used by gas utilities to bill large volume customers such as commercial, large residential, and small industrial accounts. Rotating vanes or impellers in the meters trap a volume of gas entering the meters. The gas must be able to flow through the meters with a minimum amount of resistance. The resistance to flow is measured as a differential pressure (between 0.1" H₂O and 2.0" H₂O) from the inlet to the outlet of the meters.

Contamination of the rotating vanes, measuring chamber, gears, or bearings increases the resistance to rotation; which means gas can pass through the meter without being measured. Resistance to rotation also increases the differential pressure across the meter. This can be measured to determine if the meter needs to be repaired.

Pulsating pressure and surges in flow make this a difficult measurement. Adding to the difficulty in making a reading with U-tube manometers and mechanical DP gauges are poor resolution and parallax problems. A digital manometer eliminates problems

like these. Pulsation is dampened by averaging pressure measurements at rates that can be set from 0.1 seconds up to 25 seconds. An LCD display with resolution of 0.01" H₂O takes care of any remaining reading errors.

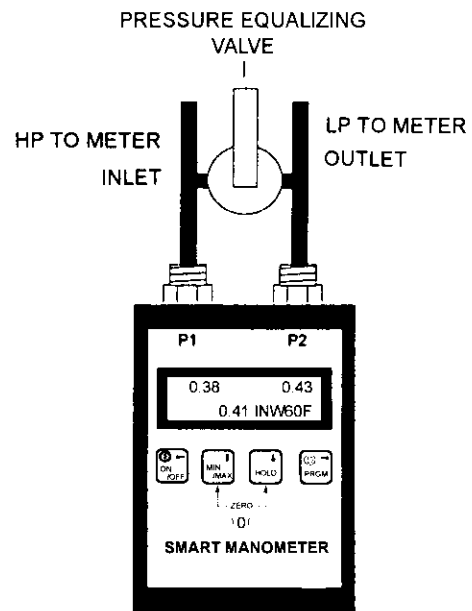

OPEN FLOW

Open flow measurement is a method used to estimate the production capabilities of a natural gas well. A section of pipe is installed off a valve at the well head; an orifice plate or hook pitot tube is placed at the end of the pipe; the gas is allowed to free flow from the well, past the pitot or orifice, and into the atmosphere. A manometer, across the pitot or orifice, measures the differential between the velocity pressure in the pipe and atmospheric pressure. Using tables published by the Appalachian Geological Society (AGS) the corresponding flow rate can be determined from the DP and the pipe size.

While this measurement can be made with a liquid manometer, sometimes there are concerns about the use of manometer fluids. In addition, there is the possibility of both reading errors on the manometer and transcription errors when using the AGS tables. An open flow version of a digital manometer simplifies this measurement. The manometer is programmed to directly calculate the flow rate using the AGS tables for orifice plates and pitot tubes. This makes the measurement fast, reduces reading errors,

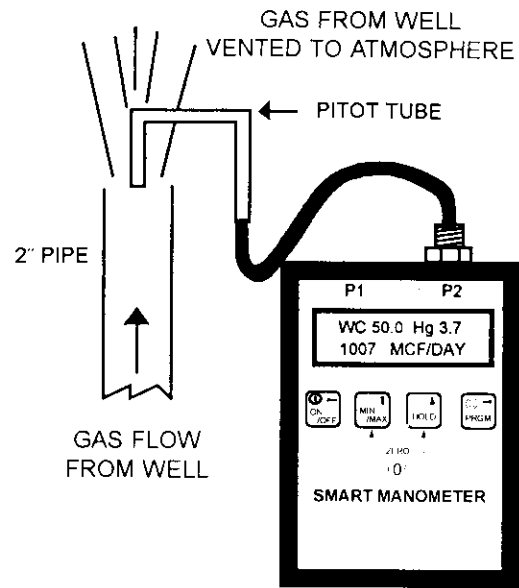

and eliminates the need to use an AGS table for conversions. The open flow manometer displays the flow rate from the well in thousands of cubic feet per day, and it also displays the differential pressure in the appropriate units.

DETECTING BLOCKAGES IN FILTERS, CONDENSERS, AND CHILLERS

These are all similar applications. For example, detecting clogged water filters in a steam power plant. River water circulates around steam condensers to cool the steam. The river water, in an open channel, passes through a series of filter screens to clean out debris and minerals. When the filters clog, water flow to the condensers decreases; reducing the efficiency of the condensers and ultimately the boiler. Measuring pressure drop across a filter as an indication of its cleanliness is a common manometer application. The open channel is a special problem.

Initially, there is a single, large channel in which water is flowing. As the filter gets clogged, separate sections or "tanks" with different water levels are created in the channel. A dual bubbler system can be used to monitor the water level upstream and downstream from the filter. With each dip tube set at the same depth, the same pressure is applied to the high and low sides of the manometer. As the filter becomes blocked, the downstream water level drops as does the corresponding hydrostatic pressure. A

digital gauge/manometer with relays can be used to monitor pressure and trigger a warning when the pressure difference indicates a clogged filter.

In HVAC ducting, condenser coils cool air flowing through an air conditioner. Over time, dirt can accumulate on the coils, which restricts air flow and reduces heat transfer. These factors in combination decrease the efficiency of the coils. As dirt accumulates, the resistance to the flow and the differential pressure across the coils also increases. A digital manometer is an excellent means of measuring the change in pressure across the coils. Its compact design allows for easy portability from job to job, the digital display is easy to read, and the accuracy meets the requirements for this type of testing.

In high rise buildings, since energy costs are high, it is important that chillers (refrigeration machines) be maintained at maximum efficiency. Cooling costs can increase 50% due to scaling in the condenser tubes. Scale build-up inhibits water flow. As the scale builds up inside the condenser, the differential between upstream and downstream pressure increases. Again, a manometer can be used to monitor the change.

Glossary of Pressure Terms

ABSOLUTE PRESSURE An absolute pressure measurement is referenced to zero pressure. It is equal to the sum of gauge pressure and atmospheric (i.e. barometric) pressure.

AMBIENT PRESSURE The pressure of the medium surrounding a device. It varies from 30 in. of mercury at sea level to a few inches at high altitudes.

ATMOSPHERIC PRESSURE Also called barometric pressure, atmospheric pressure is the weight of the atmosphere on a unit surface. The standard barometric reading at sea level and 59° F is 29.92" of mercury absolute.

DIFFERENTIAL PRESSURE Differential pressure is the pressure difference between two measurement points.

FLOW MEASUREMENT Since liquid or gas flow is accompanied by a change in pressure along the flow stream, a differential pressure device is often used with a primary element to measure the flow.

GAUGE PRESSURE A gauge pressure measurement is referenced to atmospheric pressure. It will vary with the barometric reading.

IMPACT PRESSURE In a flowing fluid, the pressure exerted parallel to the direction of flow. It is caused by the fluid velocity.

LIQUID PRESSURE The pressure below the surface of a liquid.

$$p = \rho gh$$

- ρ = density of the liquid
- g = acceleration of gravity
- h = depth below the surface

MAXIMUM WORKING PRESSURE The maximum total pressure permissible in a device under any operating conditions, at a specified temperature.

PRESSURE The force exerted per unit of area.

$$P = F/A$$

All pressure measurements are differential measurements. Pressure can be referenced to atmospheric pressure, zero pressure, or to another pressure.

PRIMARY FLOW ELEMENT The system element that quantitatively converts flow energy into a form suitable for measurement (often with a differential pressure sensing device).

RUPTURE PRESSURE The pressure at which a device will burst.

STAGNATION PRESSURE It is equal to the sum of static pressure and impact pressure. Stagnation pressure is sometimes called total or ram pressure.

STATIC PRESSURE The steady-state pressure applied to a device. In the case of a differential pressure device, the process pressure applied equally to both connections.

SURGE PRESSURE Operating pressure plus the increment above operating pressure to which a device may be subjected for a short time during pump starts, valve closings, etc.

VACUUM Any pressure below atmospheric. When this measurement is referenced to atmospheric pressure (effectively a negative gauge measurement), it is called a vacuum measurement. When this measurement, however, is referenced to zero pressure, it is an absolute pressure measurement.

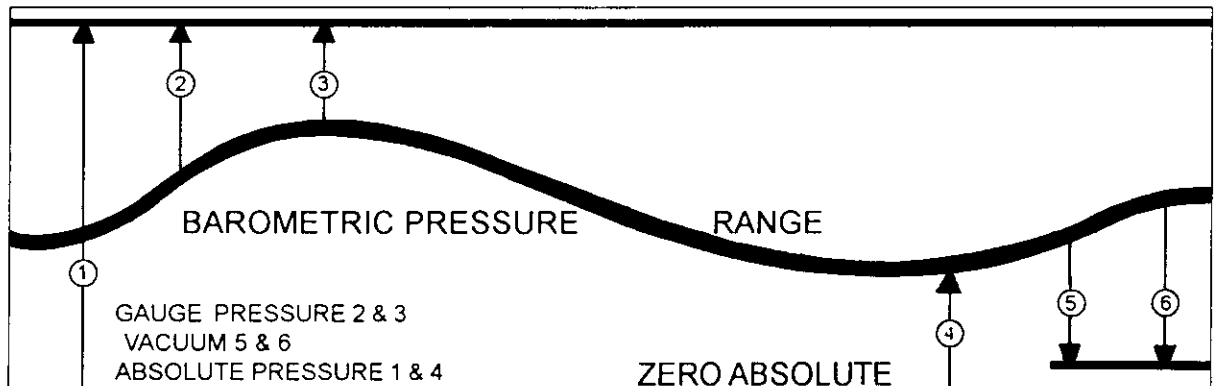

Pressure Conversions

	PSI	KPA	inches H ₂ O (20° C)	cm H ₂ O (20° C)	inches Hg (0° C)	mm Hg (0° C)	Bars	mBars	kg/cm ²
PSI	1	6.8948	27.7296	70.4332	2.0360	51.7149	.0689	68.9476	.0703
KPA	0.1450	1	4.0218	10.2155	0.2953	7.5006	.0100	10.0000	0.0102
inches H ₂ O (20° C)	0.0361	0.2486	1	2.5400	0.0734	1.8650	0.0025	2.4864	0.0025
cm H ₂ O (20° C)	0.0142	0.0979	0.3937	1	0.0289	0.7342	0.0010	0.9790	0.0001
inches Hg (0° C)	0.4912	3.3864	13.6195	34.5936	1	25.4000	0.0339	33.8639	0.0345
mm Hg (0° C)	0.0193	0.1333	0.5362	1.3620	0.0394	1	.0013	1.3332	.0014
Bars	14.5038	100.000	402.184	1021.55	29.5300	750.062	1	1000	1.0197
mBars	0.0145	.1000	0.4022	1.0216	0.0295	0.7501	.001	1	.0010
kg/cm ²	14.2233	98.0665	394.408	1001.80	28.9590	735.559	.9807	980.665	1

EXAMPLE 1mm Hg = 0.5362 inches H₂O = 1.3332 mBars

97mm Hg = 97(0.5362) = 52.0114 inches H₂O

97mm Hg = 97(1.3332) = 129.3204 mBars