

# Newline

2010 Product Catalog

## Touchboards

205 Westwood Ave, Long Branch, NJ 07740  
Phone: 866-94 BOARDS (26273) / (732)-222-1511  
Fax: (732)-222-7088 | E-mail: [sales@touchboards.com](mailto:sales@touchboards.com)





INNOVATION

*through*

# Communication

Newline has earned a reputation for providing the highest quality visual communication products including porcelain enamel markerboards, chalkboards, tackboards, bulletin boards and display cases. Our world-class production facilities are located in Asia and North America.

You can find our company listed in architectural specifications across the country and millions of square feet of our products installed throughout the United States. Materials found in our products comply with industry standards and requirements including:

- Porcelain Enamel Institute (PEI)
- American Society for Testing and Materials (ASTM)
- American National Standards Institute (ANSI)
- BUREAU VERITAS Packaging Standards

*Highest Quality*

*Innovation*

*Design*

*Value*

We keep our customers up to date with lightning fast delivery times and state of the art customer service capabilities. You can confirm and order online or call our customer service team. If you require a custom design product or a Quick Shipment item (ships in 48 hrs) Newline can accommodate you. We specialize in on-time deliveries of every order no matter how large or small. Newline supports many in house "Green" programs that include recycling and using environmentally safe materials throughout the production process. Our tested and proven delivery methods have created a high-tech process in a mature market.

We would enjoy the opportunity to discuss your company's specific needs and interests. We look forward to delivering high performance products and world-class customer service to your business every step of the way.



# Newline



## Table of Contents

Company Overview 2

### Markerboards:



Aluminum Trim, Porcelain on Steel 50-year Warranty

1/4" Thick Core Material

Streamline Series: Square Corner 4

Retroline Series: Square Corner 4

3/8" Thick Core Material

Proline Series: Radius Corner 5

Proline Composite: Radius Corner 5

Topline Series: Square Corner (With and without Map Rail) 6

1/4" Thick Core Material

Execuline Series: Aluminum and Wood Finish Trim 7

### Tackboards:

Proline Series: Radius Corners 8

Proline Composite: Radius Corner 8

Topline Series: Square Corner 9-11

Execuline Series: 12

Woodline Series Tackboard 13



### Combo Boards:

Topline Series Combo Board 9

Woodline Series Tackboard 13

Woodline Series Combo Board 13



### Presentation & Bulletin Cabinets

Presentation/Conference Cabinets 14

Bulletin Cabinets 14

### Mobile/Reversible Boards 15

### Display & Trophy Cases 16

Product Specifications 17-18

Terms & Conditions 19



Newline provides a line of high performance visual communication products to academic, civic and corporate customers. Our product offering includes porcelain enamel markerboards, chalkboards, tackboards, display cases and bulletin boards.

# Streamline Series



- Magnetic, porcelain-on-steel, projection-capable surface
- 50-year warranty on porcelain surfaces
- 1/4" thick recycled-core material for moderate use
- Lightweight for easy installation
- Designer low-profile trim
- Galvanized steel-back for strength and durability
- Magnetic marker tray 12" x 2.5"
- Mounting hardware included

## Streamline Series Markerboard

Model #	Dimensions (H x W)	Ship Wgt.	List Price	Quick Ship
P1112001	18" x 24"	6 lbs.	\$62.99	Yes
P1123001	2' x 3'	12 lbs.	\$109.99	Yes
P1134001	3' x 4'	24 lbs.	\$179.99	Yes
P1146001	4' x 6'	60 lbs.	\$289.99	Yes
P1148001	4' x 8'	80 lbs.	\$399.99	Yes

*Ships Freight Class 70*

# Retroline Series

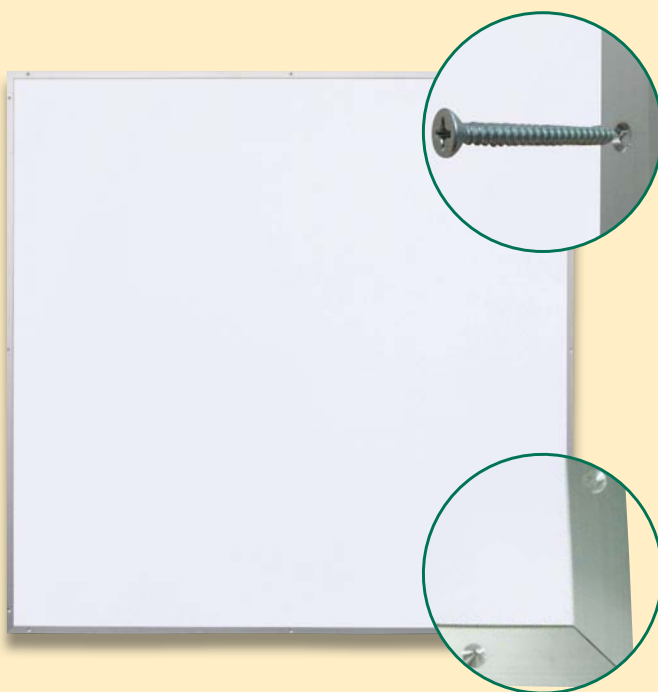

- Fits over existing chalkboards for a quick, easy upgrade
- Magnetic, porcelain-on-steel, projection-capable surface
- 50-year warranty on porcelain surfaces
- 1/4" thick recycled-core material for heavy use
- Lightweight for easy installation
- Countersink screw holes for clean low profile appearance
- Galvanized steel-back for strength and durability

## Retroline Series Markerboard

Model #	Dimensions (H x W)	Ship Wgt.	List Price
P1244001	4' x 4'	44 lbs.	\$269.00
P1246001	4' x 6'	66 lbs.	\$299.00
P1248001	4' x 8'	88 lbs.	\$429.00
P1241001	4' x 10'	110 lbs.	\$529.00
P1241201	4' x 12'	132 lbs.	\$629.00

*Ships Freight Class 70*

Proline Markerboards feature a "Concealed Corner Mounting System" that ensures a quick and easy assembly process. The unique stylish-trim comes in Light Gray and Titanium. Proline's design will enhance any environment and is ideal for heavy use applications from the office, hospital, to the classroom.

# Proline Series

- Magnetic, porcelain-on-steel, projection-capable surface
- 50-year warranty on porcelain surfaces
- MDF core material ideal in heavy use applications
- 1" radius light gray and titanium trim
- Concealed corner-mounting system
- Easy installation
- Galvanized steel-back for strength and durability
- Snap-on marker tray
- Matching tackboards page 8



**Proline Series Markerboard  
Light Gray Trim**

Model #	Dimensions (H x W)	Ship Wgt.	List Price
P1312001	18" x 24"	8 lbs.	\$96.99
P1323001	2' x 3'	18 lbs.	\$139.99
P1334001	3' x 4'	25 lbs.	\$204.99
P1344001	4' x 4'	45 lbs.	\$255.99
P1346001	4' x 6'	68 lbs.	\$359.99
P1348001	4' x 8'	90 lbs.	\$455.99

*Ships Freight Class 70*



**Proline Series Markerboard  
Titanium Trim**

Model #	Dimensions (H x W)	Ship Wgt.	List Price
P1512001	18" x 24"	8 lbs.	\$96.99
P1523001	2' x 3'	18 lbs.	\$139.99
P1534001	3' x 4'	25 lbs.	\$204.99
P1544001	4' x 4'	45 lbs.	\$255.99
P1546001	4' x 6'	68 lbs.	\$359.99
P1548001	4' x 8'	90 lbs.	\$455.99

*Ships Freight Class 70*

# Topline Series

- Magnetic, porcelain-on-steel, projection-capable surface
- MDF core material ideal in heavy use applications
- Tray channel mounting system ensures easy installation (go to [www.newline-whiteboards.com](http://www.newline-whiteboards.com) to see an installation video)
- 3/4" wide trim aluminum notch and bent mitered corners
- Available with and without map rail
- 50-year warranty on porcelain surfaces
- Galvanized steel-back for strength
- 2-1/2" deep full length marker tray
- Matching tackboards page 9



## Topline Series Markerboard - 7/16" Core

Model #	Dimensions (H x W)	Ship Wgt.	List Price	Quick Ship
P1434001	3' x 4'	24 lbs.	\$286.99	Yes
P1444001	4' x 4'	44 lbs.	\$325.99	Yes
P1446001	4' x 6'	66 lbs.	\$379.99	Yes
P1448001	4' x 8'	88 lbs.	\$459.99	Yes
P1441001	4' x 10'	110 lbs.	\$665.99	Yes
P1441201	4' x 12'	132 lbs.	\$745.99	Yes

*Ships Freight Class 70*

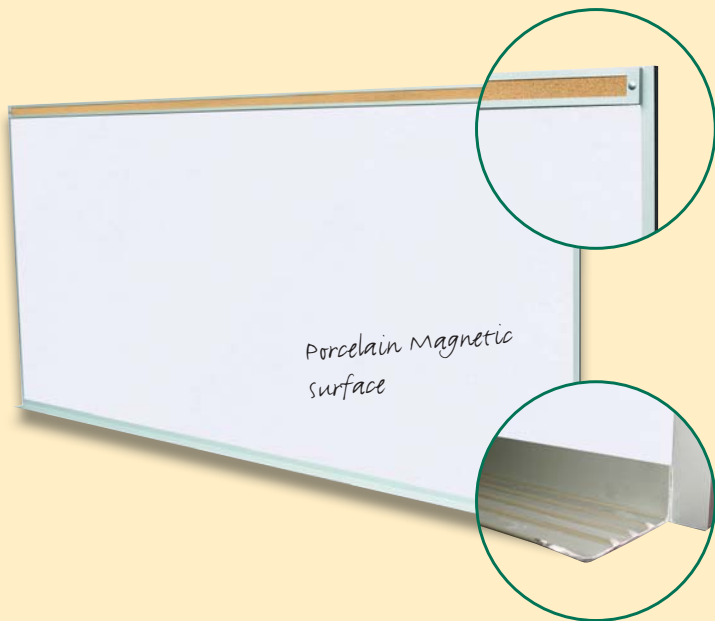

## Topline Markerboard with Map Rail - 7/16" Core

Model #	Dimensions (H x W)	Ship Wgt.	List Price	Quick Ship
P1434001MR	3' x 4'	25 lbs.	\$315.99	Yes
P1444001MR	4' x 4'	45 lbs.	\$355.99	Yes
P1446001MR	4' x 6'	68 lbs.	\$425.99	Yes
P1448001MR	4' x 8'	90 lbs.	\$505.99	Yes
P1441001MR	4' x 10'	112 lbs.	\$715.99	Yes
P1441201MR	4' x 12'	135 lbs.	\$819.99	Yes

*Ships Freight Class 70*

# Execuline Series

- Magnetic, porcelain-on-steel, projection-capable surface
- MDF core material ideal in heavy use applications
- 3 trim styles: mahogany, aluminum and graphite
- Concealed corner-mounting system (go to [www.newline-whiteboards.com](http://www.newline-whiteboards.com) to see an installation video)
- Easy installation
- 50-year warranty on porcelain surfaces
- Galvanized steel-back for strength
- Snap on marker tray
- Matching tackboards page 12



## Execuline Series Mahogany Markerboard 9mm - .354" Core

Model #	Dimensions (H x W)	Ship Wgt.	List Price
P1623001	2' x 3'	18 lbs.	\$175.99
P1634001	3' x 4'	25 lbs.	\$325.99
P1646001	4' x 6'	68 lbs.	\$599.99
P1648001	4' x 8'	90 lbs.	\$799.99

*Ships Freight Class 70*

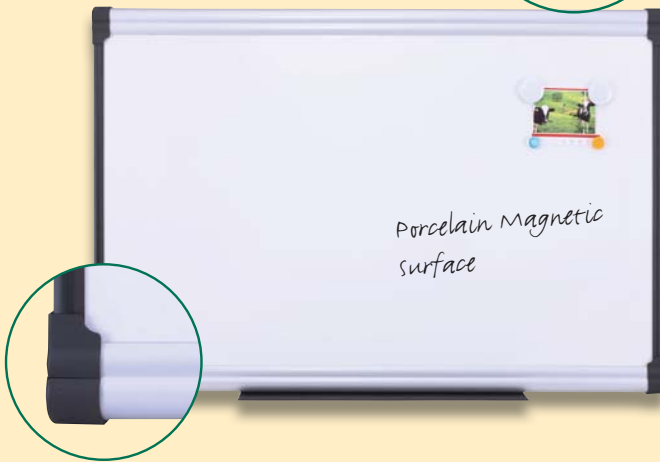

## Execuline Series Aluminum Markerboard 9mm - .354" Core

Model #	Dimensions (H x W)	Ship Wgt.	List Price
P1723001	2' x 3'	18 lbs.	\$175.99
P1734001	3' x 4'	25 lbs.	\$325.99
P1746001	4' x 6'	68 lbs.	\$599.99
P1748001	4' x 8'	90 lbs.	\$799.99

*Ships Freight Class 70*



## Execuline Series Graphite Markerboard 9mm - .354" Core

Model #	Dimensions (H x W)	Ship Wgt.	List Price
P1823001	2' x 3'	18 lbs.	\$175.99
P1834001	3' x 4'	25 lbs.	\$325.99
P1846001	4' x 6'	68 lbs.	\$599.99
P1848001	4' x 8'	90 lbs.	\$799.99

*Ships Freight Class 70*

Tackboards are available in standard Natural Cork, Forbo Cork and Vinyl Fabric or you can custom order a special style or color for your project. We can produce your tackboards to order with any custom vinyl fabric (type 1 or 2) or your own fabric. You can also select our standard colors shown on pages 10 & 11.

# Proline Series

- Self-healing natural cork with durable backer
- 10-year warranty
- 1" radius light gray and titanium trim with concealed-mounting system
- Easy installation
- Galvanized steel-back for strength
- Matching markerboards on page 5

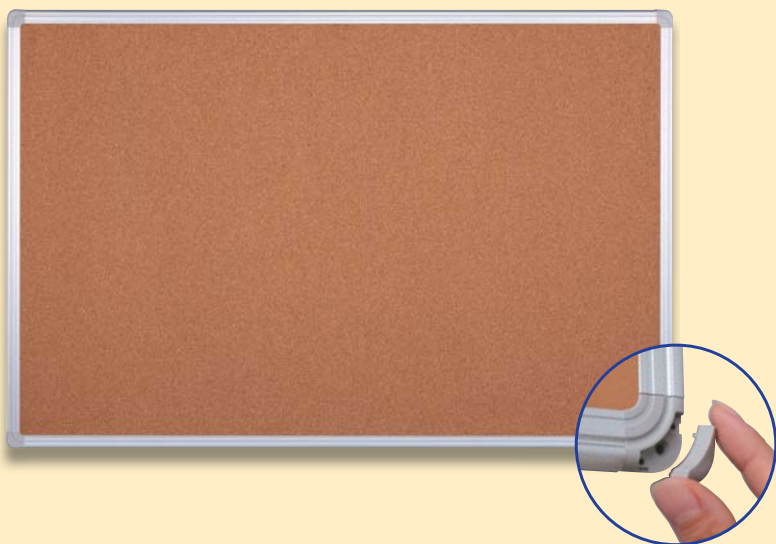

**Proline Series Natural Corkboard  
Light Gray Trim**

Model #	Dimensions (H x W)	Ship Wgt.	List Price
T1323001	2' x 3'	9 lbs.	\$79.99
T1334001	3' x 4'	14 lbs.	\$99.99
T1346001	4' x 6'	30 lbs.	\$185.99
T1348001	4' x 8'	38 lbs.	\$249.99

*Ships Freight Class 70*

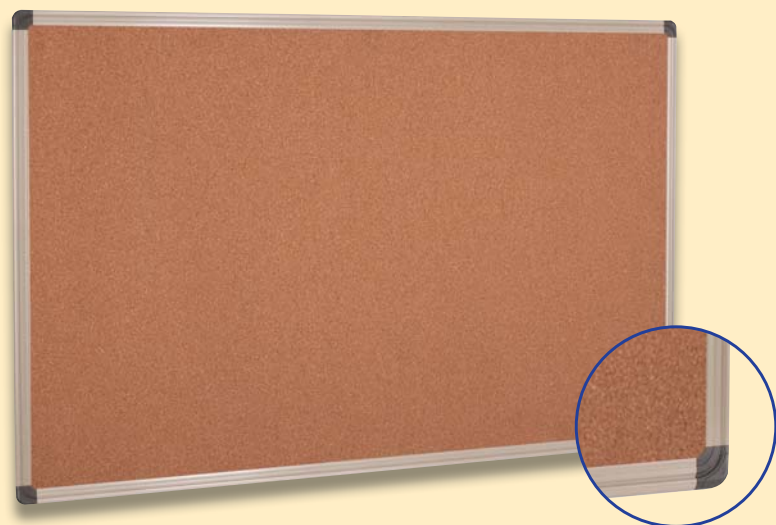

**Proline Series Natural Corkboard  
Titanium Trim**

Model #	Dimensions (H x W)	Ship Wgt.	List Price
T1523001	2' x 3'	9 lbs.	\$79.99
T1534001	3' x 4'	14 lbs.	\$99.99
T1546001	4' x 6'	30 lbs.	\$185.99
T1548001	4' x 8'	38 lbs.	\$249.99

*Ships Freight Class 70*



# Topline Series

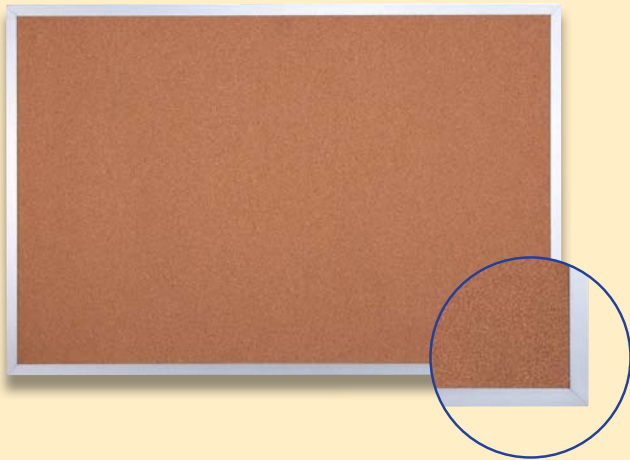

- Selfhealing natural cork
- Durable fiberboard backer
- 10-year warranty
- Easy installation
- 3/4" wide trim aluminum-mitered corners
- Galvanized steel-back for strength
- Matching markerboards page 6

## Topline Series Tackboard 3/4" Trim

Model #	Dimensions (H x W)	Ship Wgt.	List Price	Quick Ship
T1434001	3' x 4'	15 lbs.	\$75.99	Yes
T1444001	4' x 4'	20 lbs.	\$99.99	Yes
T1446001	4' x 6'	30 lbs.	\$145.99	Yes
T1448001	4' x 8'	40 lbs.	\$185.99	Yes
T1441001	4' x 10'	45 lbs.	\$235.99	Yes
T1441201	4' x 12'	55 lbs.	\$275.99	Yes

*Ships Freight Class 70*



- Selfhealing natural cork and magnetic porcelain surface
- Durable fiberboard backer
- 10-year warranty
- Easy installation
- 3/4" wide trim aluminum-mitered corners
- Galvanized steel-back for strength
- Matching markerboards page 6

## Topline Series Combo Tackboard 3/4" Trim

Model #	Dimensions (H x W)	Ship Wgt.	List Price
T1934001	3' x 4'	15 lbs.	\$179.99
T1946001	4' x 6'	30 lbs.	\$219.99
T1948001	4' x 8'	40 lbs.	\$279.99

*Ships Freight Class 70*

# Topline Series

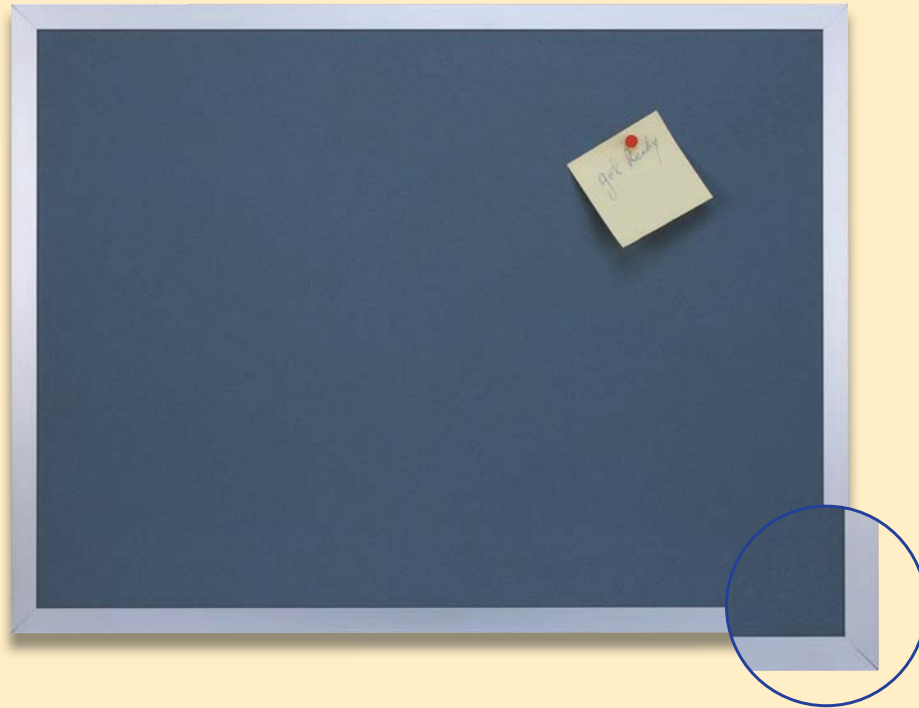

- Forbo cork made from renewable natural material
- 1/4" hardboard backer
- Durable selfhealing material
- Color-impregnated surface
- Washable and soil resistant
- 10-year warranty
- Easy installation
- 3/4" wide trim aluminum-mitered corners
- Galvanized steel-back for strength
- Matching markerboards page 6

## Topline Series Forbo Cork Tackboard 3/4" Trim

Model #	Dimensions (H x W)	Ship Wgt.	List Price
T2334001	3' x 4'	15 lbs.	\$245.99
T2346001	4' x 6'	30 lbs	\$399.99
T2348001	4' x 8'	40 lbs.	\$529.99

*Ships Freight Class 70*



Tan 2166



Stone 2182



Grey 2162



Desert Sand 2067



Green 2203



Blue 2185



**Topline Series Vinyl Fabric Tackboard**  
**3/4" Trim**

<b>Model #</b>	<b>Dimensions (H x W)</b>	<b>Ship Wgt.</b>	<b>List Price</b>
T2434001	3' x 4'	15 lbs.	\$130.99
T2446001	4' x 6'	30 lbs	\$219.99
T2448001	4' x 8'	40 lbs.	\$289.99

*Ships Freight Class 70*

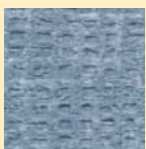

Denim OV1001



Bleached OV1002



Windrift OV1003



Taupe OV1004



Heather OV1006

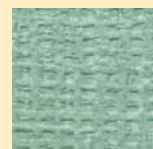

Aspen OV1005

# Execuline Series

- Concealed corner-mounting system (go to [www.newline-whiteboards.com](http://www.newline-whiteboards.com) to see an installation video)
- Self-healing natural cork
- Durable fiberboard backer
- Washable and stain resistant
- 10-year warranty
- Easy installation
- 3 trim choices
- Galvanized steel-back for strength
- Matching markerboards page 7

## Execuline Series Mahogany Tackboard

Model #	Dimensions (H x W)	Ship Wgt.	List Price
T1623001	2' x 3'	15 lbs.	\$75.99
T1634001	3' x 4'	30 lbs	\$125.99
T1646001	4' x 6'	40 lbs.	\$299.99

*Ships Freight Class 70*

## Execuline Series Aluminum Tackboard

Model #	Dimensions (H x W)	Ship Wgt.	List Price
T1723001	2' x 3'	15 lbs.	\$75.99
T1734001	3' x 4'	30 lbs	\$125.99
T1746001	4' x 6'	40 lbs.	\$299.99

*Ships Freight Class 70*

## Execuline Series Graphite Tackboard

Model #	Dimensions (H x W)	Ship Wgt.	List Price
T1823001	2' x 3'	15 lbs.	\$75.99
T1834001	3' x 4'	30 lbs	\$125.99
T1846001	4' x 6'	40 lbs.	\$299.99

*Ships Freight Class 70*

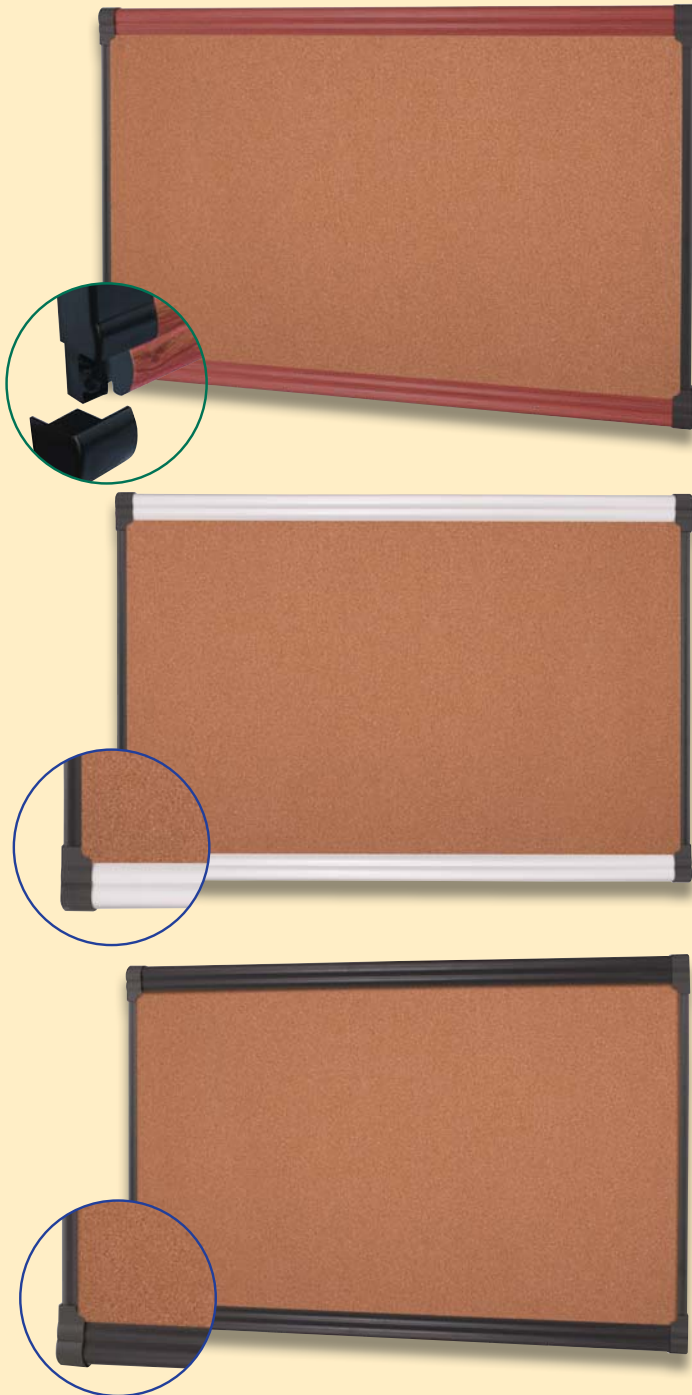



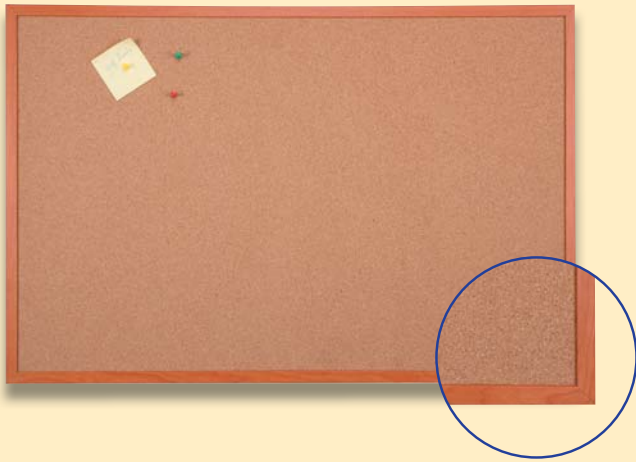

- Selfhealing natural cork
- Durable fiberboard backer
- 10-year warranty
- Easy installation
- 1 1/4" wide cherry trim
- Galvanized steel-back for strength

#### Woodline Series Tackboard

Model #	Dimensions (H x W)	Ship Wgt.	List Price
T2134001	3' x 4'	15 lbs.	\$85.99
T2146001	4' x 6'	30 lbs	\$155.99
T2148001	4' x 8'	40 lbs.	\$195.99

*Ships Freight Class 70*

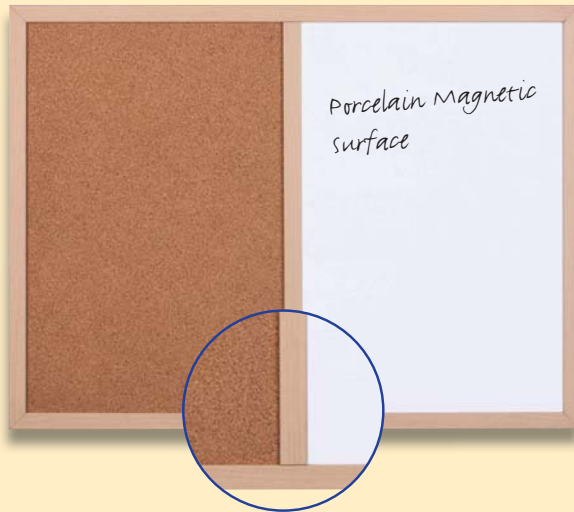

- Selfhealing natural cork and magnetic porcelain surface
- Durable fiberboard backer
- 10-year warranty
- Easy installation
- 1 1/4" wide cherry trim
- Galvanized steel-back for strength

#### Woodline Series Combo Tackboard

Model #	Dimensions (H x W)	Ship Wgt.	List Price
T2234001	3' x 4'	15 lbs.	\$149.00
T2246001	4' x 6'	30 lbs	\$179.00
T2248001	4' x 8'	40 lbs.	\$199.00

*Ships Freight Class 70*

When you need to communicate in the board room or the hallway, you can choose from a standard conference cabinet or bulletin cabinet. Or have it custom made to your exact specification.



- Cherry and mahogany veneer finish
- Fabric-covered bulletin panels on inside of doors
- Interior features a magnetic, porcelain surface with projection capabilities
- Piano hinges for strength
- Scratch and stain-resistant
- Measures 4" deep
- Markerboard doubles as a projection screen

### Conference Cabinet

Model #	Description	Dimensions (H x W x D)	Ship Wgt.	List Price
C1144001	Conference Cabinet (Cherry)	4' x 4' x 3"	115 lbs.	\$899.00
C1244001	Conference Cabinet (Mahogany)	4' x 4' x 3"	115 lbs.	\$899.00

*Ships Freight Class 100*



- Contour aluminum frame
- Tackable felt fabric
- Magnetic door closure
- Tempered glass doors
- Durable hinges
- All mounting hardware included



- Stylish aluminum frame
- Bleached vinyl fabric OV1002 over a selfhealing natural cork
- Washable tacking surface
- Locking safety glass doors
- Piano hinges for strength
- Call for other standard and custom sizes
- All mounting hardware included

### Conference Cabinet

Model #	Description	Dimensions (H x W)	Ship Wgt.	List Price
B2232001	1 Door Bulletin Board	3' x 2'	54 lbs.	\$345.99
B2234001	2 Door Bulletin Board	3' x 4'	108 lbs.	\$629.00

*Ships Freight Class 100*

Maximize the space and double the opportunity to communicate your message with reversible mobile boards.



- Ultimate versatility and mobility
- Reversible, magnetic-porcelain writing surface
- Durable, high-quality steel frame
- Easy-glide locking casters
- Full length tray

- Space saving design - ultimate versatility and mobility
- Reversible, magnetic-porcelain writing surface
- Durable, high-quality steel frame
- Easy-glide locking casters
- Full length tray

---

---

---



Recessed or free standing display cases are designed to properly showcase your awards. Standard or customized to fit the needs of the champions.



- Several trim colors available including black anodize and powder coat
- Easy installation cases come fully assembled – just install the shelves and doors
- Available with wood-veneer or vinyl-laminated side and back panels
- Interior lighting is available (voltage range from 120v-277v)
- Call for custom configurations

#### Recessed Display Case

Model #	Dimensions (H x W)	Ship Wgt.	List Price
D1146001	4' x 6'	200 lbs.	\$1,969.99
D1148001	4' x 8'	270 lbs.	\$2,599.99
D1141201	4' x 12'	405 lbs.	\$3,719.99

*Ships Freight Class 125*



- Multiple trim colors including black anodize and powder coat
- Easy installation cases come fully assembled – just install the shelves and doors
- Available with glass, wood-veneer or vinyl-laminated side panels
- Available with wood-veneer or vinyl-laminated back panels
- Available in either a 4-post base or solid-panel base
- Interior lighting is available (voltage range from 120v-277v)
- Call for custom configurations

#### Free Standing Display Case

Model #	Dimensions (H x W x D)	Ship Wgt.	List Price
D2154001	5'6" x 4' x 16"	320 lbs.	\$3,089.99
D2156001	5'6" x 6' x 16"	480 lbs.	\$3,469.99
D2158001	5'6" x 8' x 16"	640 lbs.	\$5,519.99

*Ships Freight Class 125*





## Markerboard

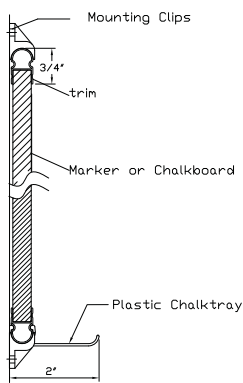
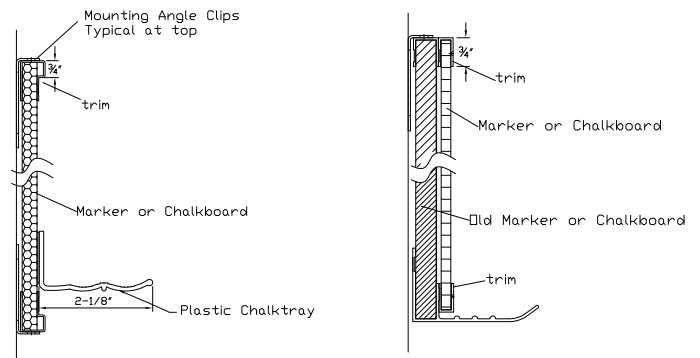

Proline

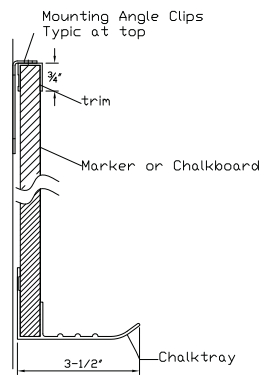
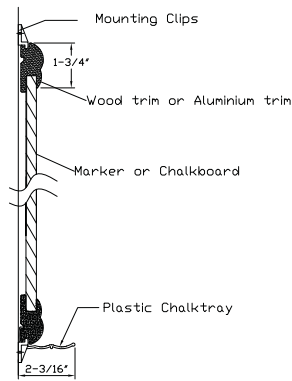

Topline

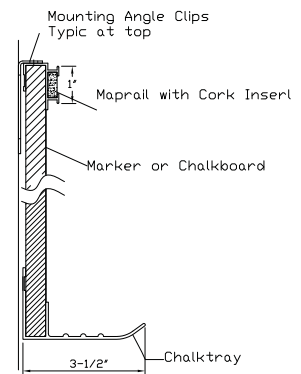

Topline with Map Rail

## Tackboard

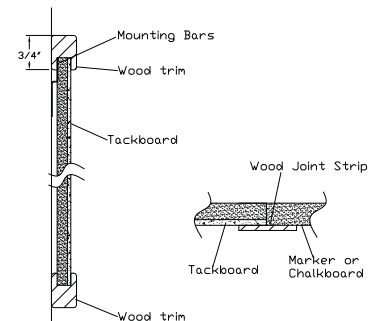
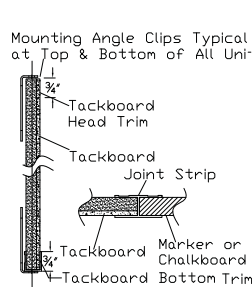
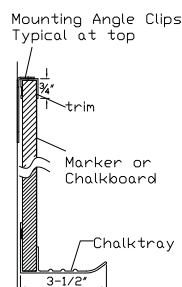
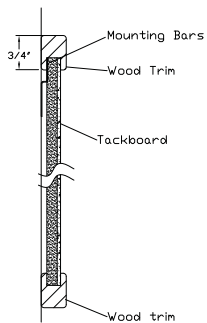
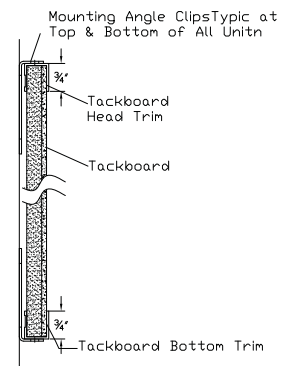
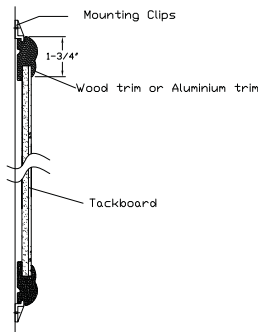
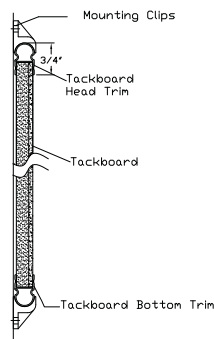

## Bulletin Board Case

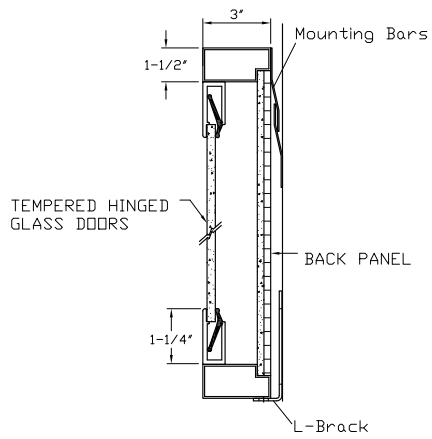

Bulletin Board Case

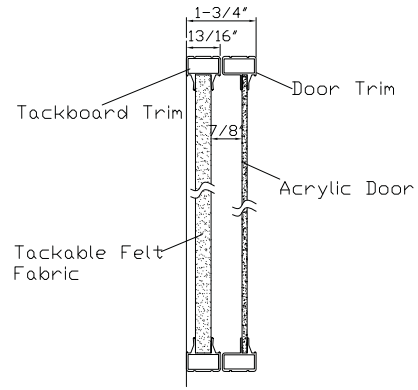

Bulletin Board Case

## Mobile Board

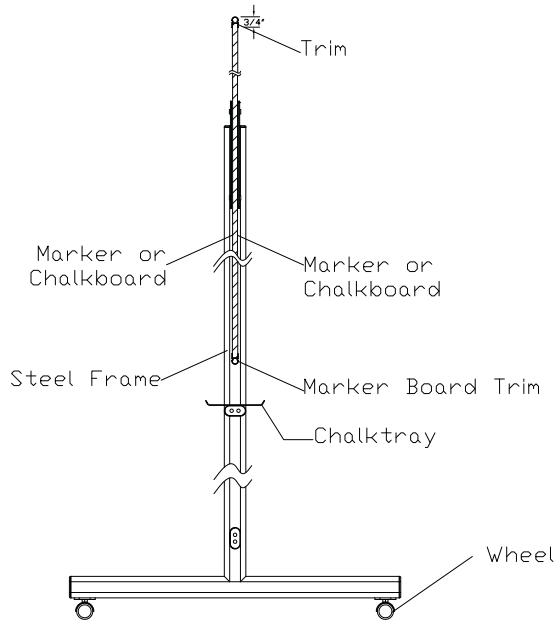

Mobile Board

## Recessed & Free Standing Display Case

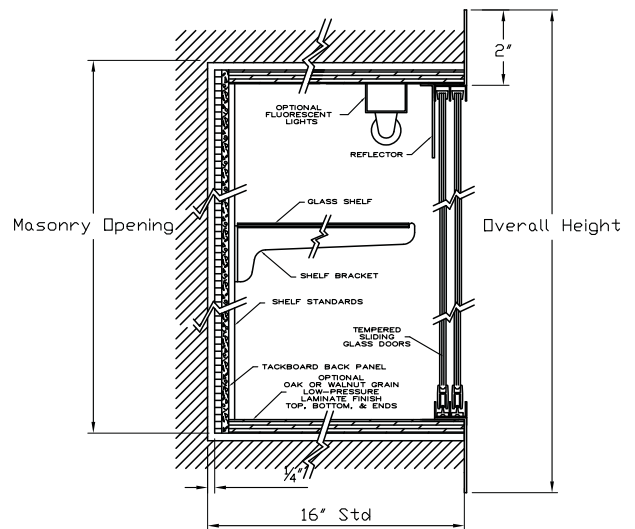

Recessed Display

## INNOVATION

*through*

# Communication

**DISCLAIMER:** The Terms & Conditions below expressly set forth Newline's position and are not intended to be a full, comprehensive and complete detail of each subject. Newline reserves the right to alter, change, modify, expand, or discontinue any of the policies set forth below. Newline further reserves the right to alter, change, modify, or discontinue its programs, policies, or relationship with any customer who violates Newline's stated Terms & Conditions.

**SPECIFICATION CHANGES:** Newline reserves the right to institute changes to material, parts, or design as well as to discontinue models, options, and/or parts without any prior notice. Prices subject to change without notice.

**ORDERS:** All orders must be submitted in writing by US mail, fax, or e-mail. It is the buyer's sole responsibility to check orders and their corresponding acknowledgments for accuracy. Minimum order of \$25.

**ACKNOWLEDGMENTS + LEAD TIMES:** Upon credit approval, orders will be manufactured and invoiced based upon the information on the acknowledgment. It is the buyer's responsibility to notify Newline of any acknowledgment discrepancies. Actual shipment dates may differ from acknowledged dates due to lack of credit approval. If an order is subject to a credit hold, it will be scheduled for shipment only after it is released from credit hold. All Commercial Division orders are acknowledged within 12 hours of receipt of order, subject to credit approval.

**CHANGE ORDERS:** Newline reserves the right to apply additional charges to the invoice for orders revised after manufacturing has begun. All changes must be in writing.

**TERMS:** For credit approved customers, all merchandise will be invoiced when shipped, with standard terms of net 30 days. The buyer agrees that Newline shall have the right to assess interest charges of 1.5% per month on invoices not paid and received by Newline within terms. The buyer further agrees that Newline has the right to change terms, suspend shipments, or refuse orders from any delinquent account.

**SECURITY:** The buyer agrees that Newline maintains a security interest in all merchandise sold by it to the buyer until all monies have been paid to Newline for said merchandise.

**CANCELLATION:** All orders are considered firm and cannot be cancelled except by consent from Newline. Newline reserves the right to assess a Cancellation Fee of no more than 25%, or as negotiated, for any order cancelled by the buyer.

**FREIGHT POLICY:** Every effort will be made to ship in accordance with customer requested freight carriers. Newline is not responsible for damage in shipment when product is shipped on a third party or collect basis. In the event of visible freight damage, note damage on the freight bill and notify the carrier at once for inspection. Note that carriers require reports of damage within 15 days. Failure to report visible damage or loss is the consignee's responsibility. Concealed damage identified after 15 days from receipt should be reported directly to Newline. Consignee is not responsible for such concealed damage.

**SHIP DATES + DELAYS:** If Newline cannot ship products as scheduled due to causes beyond their reasonable control (force majeure), the ship date will be extended to compensate for the delay as determined by Newline.

**REDELIVERY OF FREIGHT:** Two weeks' notice is required when redelivery of merchandise will be required, or the actual cost for freight, restocking and re-handling, and storage, if applicable, will be billed to the customer.

**RETURNS:** All approved returns must be prepaid by the buyer and are subject to a restocking charge of no greater than 25%. Merchandise must be returned unused and properly packaged in original shipping carton.

**WARRANTY:** Newline porcelain enamel steel markerboard and chalkboard writing surfaces are guaranteed for 50 years or the life of the building. Other product in Price Book carries a five-year guarantee against defects in materials and workmanship.

**CUSTOM PRODUCTS:** Modifications to standard products are available. Contact the factory - or the Newline location nearest you for quotations.

**MATERIAL DISCLAIMER:** Slight color variations may occur on surface materials. Newline cannot be held responsible for reasonable variances.

All inquiries and correspondence should be directed to [info@newlineproductinc.com](mailto:info@newlineproductinc.com)



**Touchboards**  
205 Westwood Ave, Long Branch, NJ 07740  
Phone: 866-94 BOARDS (26273) / (732)-222-1511  
Fax: (732)-222-7088 | E-mail: [sales@touchboards.com](mailto:sales@touchboards.com)

**Newline** 