

INSTALLATION INSTRUCTIONS

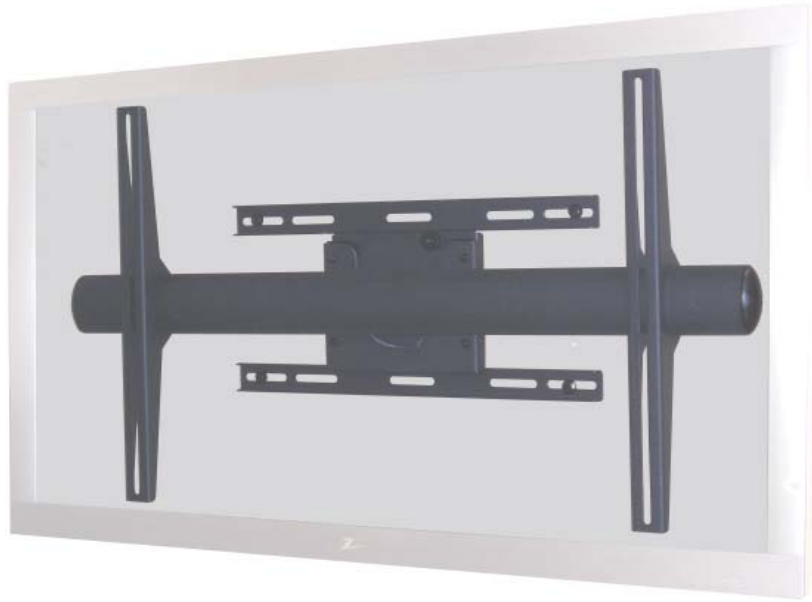

Rotary Series

Rotary Flat Mount
Model: RFM

Touchboards

205 Westwood Ave, Long Branch, NJ 07740
Phone: 866-94 BOARDS (26273) / (732)-222-1511
Fax: (732)-222-7088 | E-mail: sales@touchboards.com



Table of Contents

Contact Premier Mounts..... 2

Warning Statements..... 3

Parts List..... 4

Installation Tools..... 4

Thread Depth Indicator..... 7

Mount Installation..... 8

Concrete Mounting..... 9

Universal Mounting Bracket Installation..... 9

Display Orientation..... 11

Technical Specifications..... 11

Warranty..... 12

Warning Statements



PRIOR TO THE INSTALLATION OF THIS PRODUCT, THE INSTALLATION INSTRUCTIONS SHOULD BE READ AND COMPLETELY UNDERSTOOD. THE INSTALLATION INSTRUCTIONS MUST BE READ TO PREVENT PERSONAL INJURY AND PROPERTY DAMAGE. KEEP THESE INSTALLATION INSTRUCTIONS IN AN EASILY ACCESSIBLE LOCATION FOR FUTURE REFERENCE.



PREMIER MOUNTS DOES NOT WARRANT AGAINST DAMAGE CAUSED BY THE USE OF ANY PREMIER MOUNTS PRODUCT FOR PURPOSES OTHER THAN THOSE FOR WHICH IT WAS DESIGNED OR DAMAGE CAUSED BY UNAUTHORIZED ATTACHMENTS OR MODIFICATIONS, AND IS NOT RESPONSIBLE FOR ANY DAMAGES, CLAIMS, DEMANDS, SUITS, ACTIONS OR CAUSES OF ACTION OF WHATEVER KIND RESULTING FROM, ARISING OUT OF OR IN ANY MANNER RELATING TO ANY SUCH USE, ATTACHMENTS OR MODIFICATIONS.



THE SURFACE MUST BE CAPABLE OF SUPPORTING AT LEAST FIVE TIMES THE WEIGHT OF THE DISPLAY. IF NOT, THE SURFACE STRUCTURE MUST BE REINFORCED. THE MAXIMUM WEIGHT THAT CAN BE USED WITH THIS PRODUCT IS 160LBS. PROPER INSTALLATION PROCEDURE BY A QUALIFIED SERVICE TECHNICIAN, AS OUTLINED IN THE INSTALLATION INSTRUCTIONS, MUST BE ADHERED TO. FAILURE TO DO SO COULD RESULT IN SERIOUS PERSONAL INJURY, OR EVEN DEATH.



SAFETY MEASURES MUST BE PRACTICED AT ALL TIMES DURING THE ASSEMBLY OF THIS PRODUCT. USE PROPER SAFETY GEAR AND TOOLS FOR THE ASSEMBLY PROCEDURE TO PREVENT PERSONAL INJURY.



At least two qualified people should perform the assembly procedure. Injury and/or damage can result from dropping or mishandling the display.



If mounting to studs, make sure that the mounting screws are anchored into the center of the studs. Use of an edge-to-edge stud finder is recommended.



Be aware of the mounting environment. If drilling and/or cutting into the mounting surface, always make sure that there are no electrical wires in wall. Cutting/drilling into an electrical line may cause serious injury.



Make sure there are no water lines inside the wall where the mount is to be located. Cutting/drilling into a water line may cause severe water damage to the mounting surface.



This product is intended for indoor use only. Use of this product outdoors could lead to product failure and personal injury.



Do not install near sources of high heat. Do not install on a structure that is prone to vibration, movement or chance of impact



Contact Premier Mounts with any questions
(800) 368-9700
techsupport@mounts.com





Parts List



Note

This mount is shipped with all installation hardware and components. Make sure that none of these parts are missing and/or damaged before beginning installation. If there are parts missing and/or damaged, please stop and contact Premier Mounts (800) 368-9700.

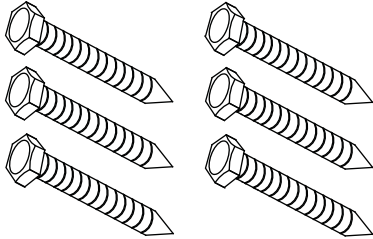
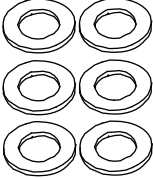
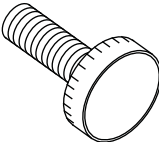
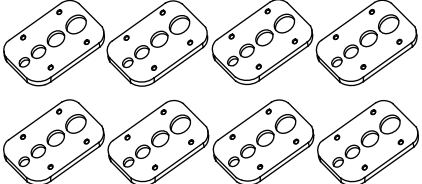
 <p>Universal Mounting Brackets (Qty 2)</p>			 <p>Rotating Universal Bracket Bar (Qty 1)</p>
 <p>5/16" x 3" Lag Bolts - wooden studs only (Qty 6)</p>	 <p>5/16" Flat Washers (Qty 6)</p>	 <p>M6 Knurl Knob (Qty 1)</p>	 <p>Griplate™ (Qty 8)</p>

Installation Tools

Phillips Head Screw Driver
 Pencil
 Level (Supplied)
 1/4" Drill Bit (Pilot Holes)
 Masonry Drill Bit (Concrete Applications - Commercially Available)

Soft Material/Blanket
 Tape Measure
 M5 Allen Wrench (Supplied)
 Thread Depth Indicator (Supplied)

1/2" Socket and Wrench
 Drill Gun
 5/32" Allen Wrench (Supplied)

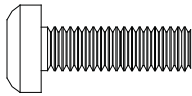

M4 x 16  (Qty 8)

M6 x 20  (Qty 8)

M4 x 25  (Qty 8)

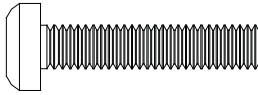
M6 x 30  (Qty 8)

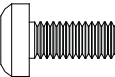
M5 x 12  (Qty 8)

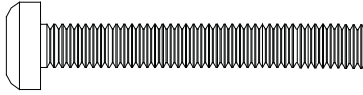
M6 x 45  (Qty 8)

M5 x 16  (Qty 8)

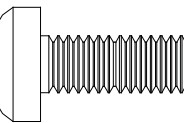
M8 x 20  (Qty 8)

M5 x 20  (Qty 8)

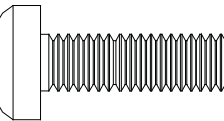
M8 x 25  (Qty 8)

M5 x 25  (Qty 8)

M5 x 50  (Qty 8)

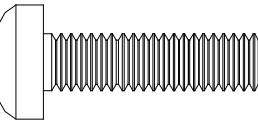
M8 x 30  (Qty 8)

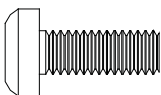
M6 x 16  (Qty 8)

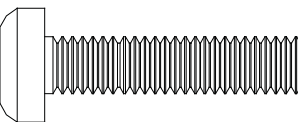
M8 x 35  (Qty 8)

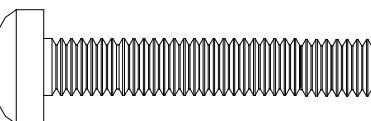
M8 x 45  (Qty 8)

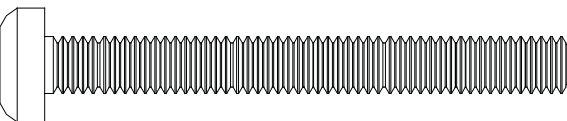
M8 x 70  (Qty 4)



Note

The nylon spacers may be stacked to achieve proper spacing.

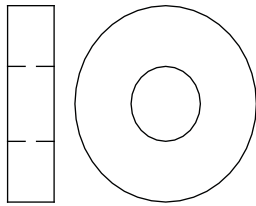

**1/4" Nylon spacers
(large)
(Qty 8)**

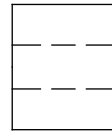

**9/16" Nylon spacers
(Qty 8)**

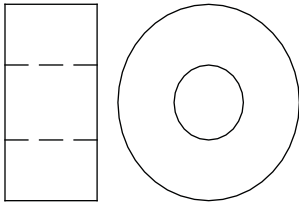

**1/2" Nylon spacers
(large)
(Qty 12)**

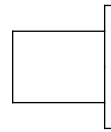

**Nylon sleeves
(Qty 8)**

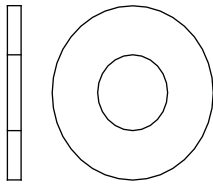

**5/16" Flat washers
(metal)
(Qty 8)**

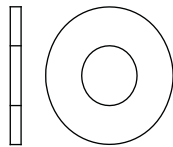

**1" Nylon Spacers
(Qty 8)**

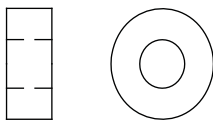

**1/4" Nylon spacers
(small)
(Qty 8)**



Thread Depth Indicator

1. Insert the thread depth indicator (supplied) through the thread inserts found on the back of the flat panel to make sure the inserts measure the same full depth and mark it (Figure 1).
2. Locate the correct diameter screw for the thread insert. Compare your marking to the screws (supplied).
3. If your selected screw is longer than the marking on the thread depth indicator, **DO NOT USE** this screw.
4. The screw length must not bypass the marking. Select another screw size (Figure 2 and 3), until you find one that comes closest to your mark without going past.

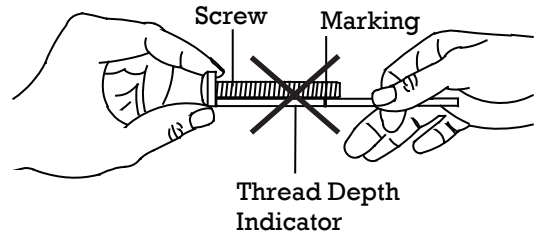
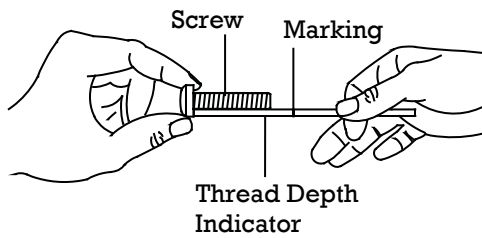
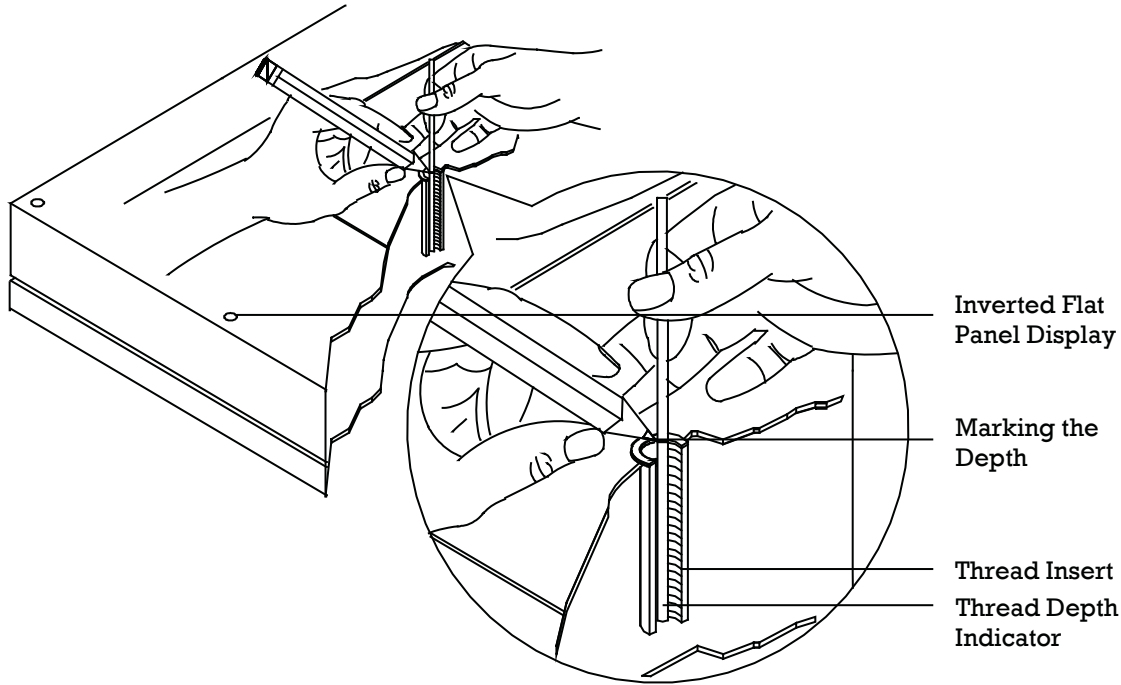



Mount Installation



Step 1

Determine where the mount location will be. Use a stud finder to locate the nearest wall stud.



Step 2

Once the stud has been located, use a pencil to mark the spot.



Step 3

Using a 1/4" drill bit, drill the upper mounting hole where the mark was made.



Note

For ease of installation, it is recommended that two people perform the installation. One person should hold the mount while the other person installs the lag bolt and washer. Making sure that the mount is level, the person not holding the mount must mark and drill the second mounting hole and secure the second lag bolt and washer.



Step 4

After the holes have been pre-drilled, line up the mounting slot openings with the pre-drilled holes.



Step 5

Insert two (2) 5/16" x 3" lag bolts and washers into the mounting holes and tighten (see WARNING: below



Step 6

Place a level (supplied) on the top rail and make sure that the mount is level. Once the mount is level, Drill pilot holes in the lower mounting slots and install two (2) 5/16" x 3" lag bolts and washers into the mounting holes and tighten.



WARNING

Do NOT over-tighten lag bolts when attaching the mount to the wall. Improper installation may result in personal injury or damage to property.



Note

If the studs are 12" (304.8mm) apart, use three (3) 3" (76.2mm) lag bolts for the top rail and three (3) 3" (76.2mm) lag bolts for the lower rail. If the studs are 16" (406.4mm), 18" (457.2mm) or 24" (609.6mm) apart, use two (2) 3" lag bolts for the top rail and two (2) 3" lag bolts for the lower rail.



Concrete Mounting



Note Concrete anchors must be used for concrete installation. They can be purchased at your local hardware store. The mounting surface must be a minimum 6" thick.

1. Begin by placing the mount into position against the wall, keeping it level.
2. Mark off four holes to be used for securing the mount.
3. Next, drill holes using a masonry bit for your anchors (recommended masonry bit).
4. Insert a commercially available concrete anchor into each hole (recommended 3/8" wedge anchors).
5. If necessary, a hammer can be used to lightly tap each anchor into place so that they are flush with the wall.
6. Once all of the anchors are in place, move the wall bracket into position.
7. Attach the nut onto the threaded shaft that is protruding from the wall.
8. Do not tighten until all nuts are in place.

Universal Mounting Bracket Assembly

1. Place the universal bracket bar and the universal brackets on a flat surface.
2. Slide the universal brackets onto the universal bracket bar (as shown below) with the set screws facing up. At this time, do not tighten the set screws that are located on the universal bracket.
3. Place the display on a soft, flat surface, face-down. Next, place the universal bracket assembly on the back of the display, with the universal brackets resting directly over the display mounting points.
4. Once the desired position has been determined, place the Griplate™ washers over each mounting point and secure them using the appropriate hardware (see Page 5).



Note For the two upper mounting points, the Griplate™ flat side must be facing up. For the two lower mounting points, the Griplate™ flat side must be facing down.

5. At this time, center the universal bracket bar and tighten the set screws that are located on the universal brackets.

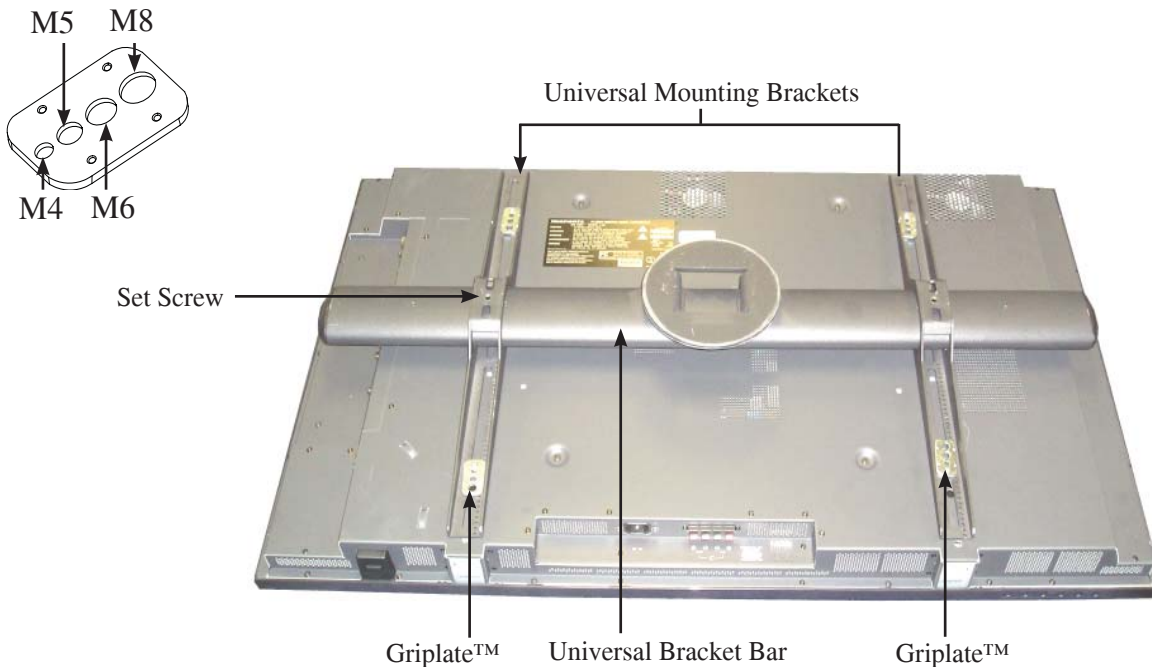

WARNING IT WILL TAKE TWO PEOPLE TO COMPLETE THE NEXT INSTALLATION STEP.



6. Lower the universal bracket bar with attached display into the cradle (as shown to the left).



Nylon Sleeve



Note

After loosening the tension bolts, be sure that the nose piece is held together tightly before rotating.

- Knurl Knob Mounting Point/M6 x 12mm Security Head and M6 Lock Washer Mounting Point.

7. Insert an M6 Knurl Knob/M6 x 12mm Security Head and M6 Lock Washer into the knurl knob/security screw mounting point and tighten.



Note

To access the knurl knob/security screw location while the display is attached, the RFM must be rotated to the "portrait" position (vertical position)

8. Tighten the two (2) Phillips head screws (located on the side of the mounting block) once the final position is attained.

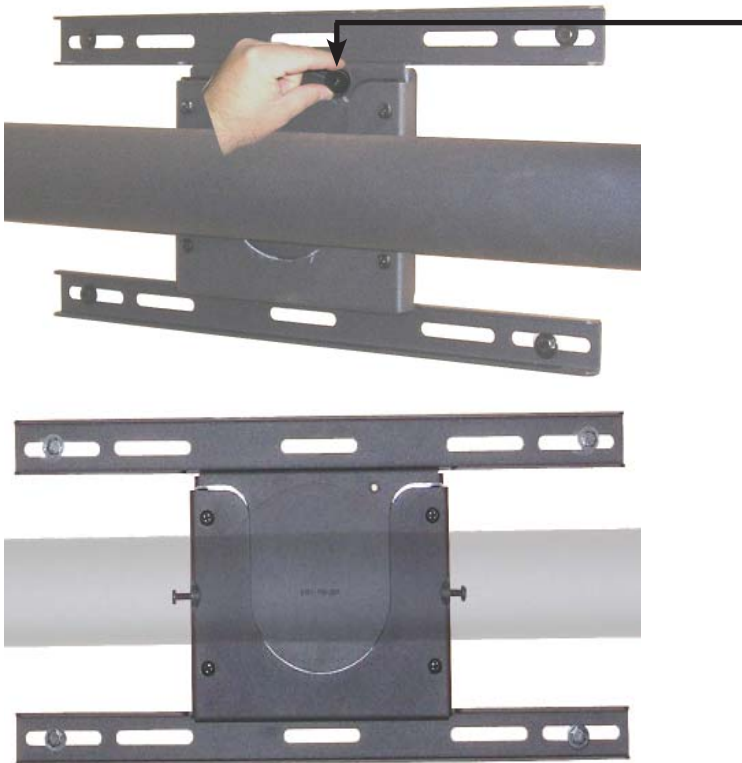



Display Orientation

The RFM will allow the user to adjust the display a full 360°.



WARNING

BEFORE ROTATING THE RFM, MAKE SURE THAT THE M6 KNURL KNOB IS SECURELY FASTENED TO THE RFM. ALSO, PLEASE MAKE SURE YOU ALLOW ENOUGH CABLE AND WIRE CLEARANCE FOR FULL ROTATION.

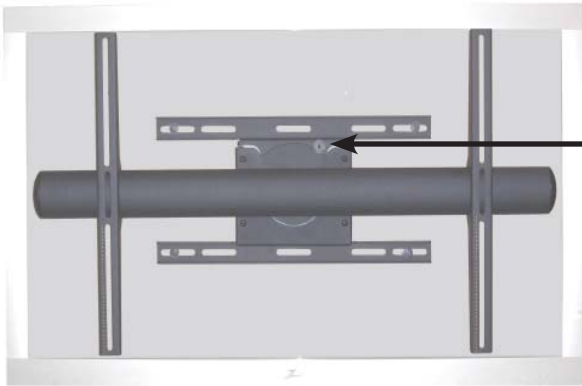

M6 Knurl Knob

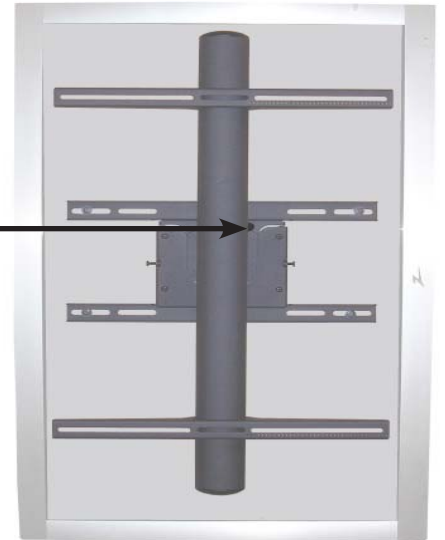

1. To adjust the RFM, rotate the display either clockwise or counter-clockwise.

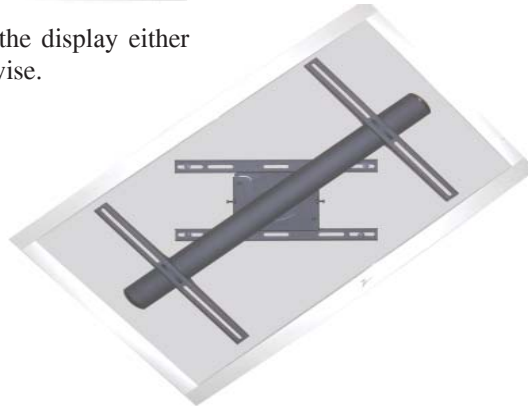

2. Tighten the two Phillips head locking screws (see Step 8, Page 10).

Technical Specifications

All measurements are in inches (mm).

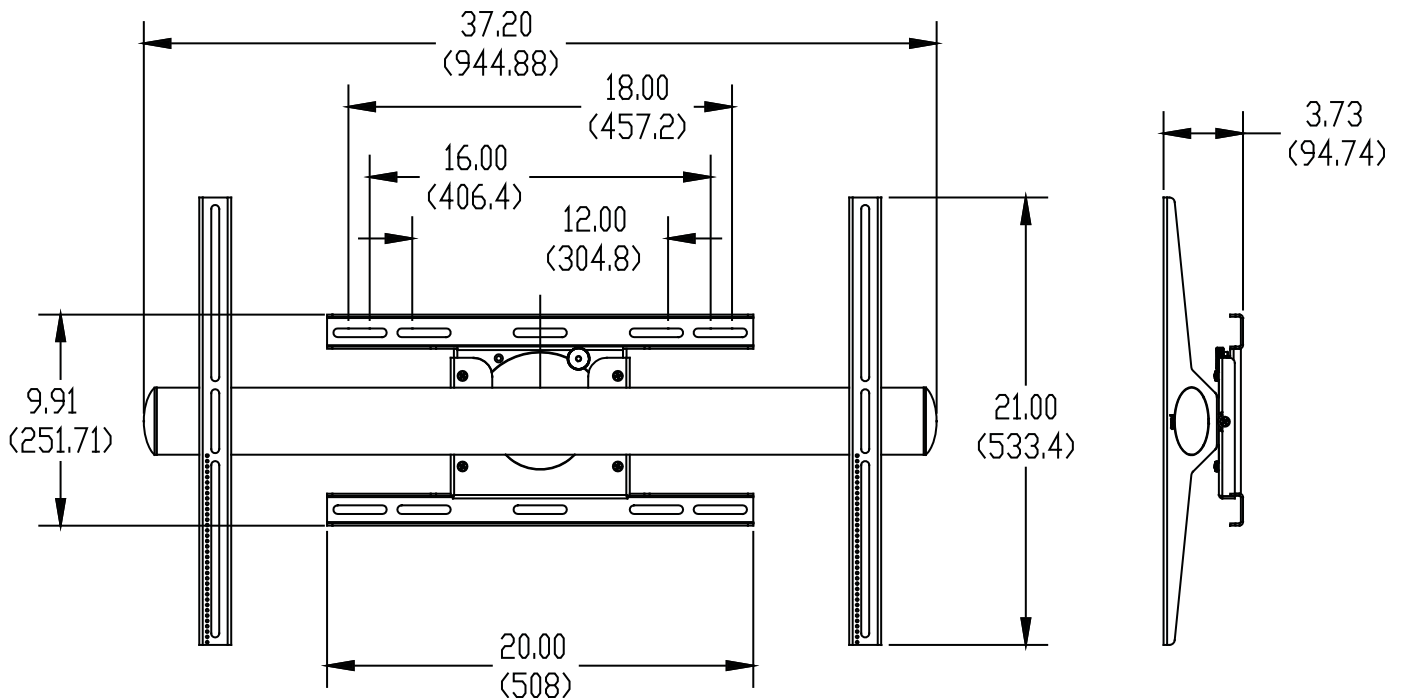



Warranty

PREMIER MOUNTS LIMITED LIFETIME WARRANTY

What and Who is Covered by this Limited Warranty and for How Long

Premier Mounts warrants this product to be free from defects in material and workmanship for the lifetime of the original owner of this product. The limited warranty is valid only for the original purchaser of the product.

What Premier Mounts Will Do

At the sole option of Premier Mounts, Premier Mounts will repair or replace any product or product part that is defective. If Premier Mounts chooses to replace a defective product or part, a replacement product or part will be shipped to you at no charge, but you must pay any labor costs.

What is Not Covered; Limitations

PREMIER MOUNTS DISCLAIMS ANY LIABILITY FOR DAMAGE TO MOUNTS, ADAPTERS, DISPLAYS, PROJECTORS, OTHER PROPERTY, OR PERSONAL INJURY RESULTING, IN WHOLE OR IN PART, FROM IMPROPER INSTALLATION, MODIFICATION, USE OR MISUSE OF ITS PRODUCTS.

PREMIER MOUNTS DISCLAIMS ALL OTHER WARRANTIES, EXPRESS OR IMPLIED, INCLUDING WARRANTIES OF MERCHANTABILITY AND FITNESS FOR A PARTICULAR PURPOSE. PREMIER MOUNTS IS NOT RESPONSIBLE FOR INCIDENTAL OR CONSEQUENTIAL DAMAGES, INCLUDING BUT NOT LIMITED TO, INABILITY TO USE ITS PRODUCTS OR LABOR COSTS FOR REMOVING AND REPLACING DEFECTIVE PRODUCTS OR PARTS. SOME STATES DO NOT ALLOW THE EXCLUSION OR LIMITATION OF INCIDENTAL OR CONSEQUENTIAL DAMAGES, SO THE ABOVE LIMITATION OR EXCLUSION MAY NOT APPLY TO YOU.

What Customers Must Do for Limited Warranty Service

If you discover a problem that you think may be covered by the warranty you **MUST REPORT** it in writing to the address below within thirty (30) days. Proof of purchase (an original sales receipt) from the original consumer purchaser must accompany all warranty claims. Warranty claims must also include a description of the problem, the purchaser's name, address, and telephone number. General inquiries can be addressed to Premier Mounts Customer Service at 1-800-368-9700. Warranty claims will not be accepted over the phone or by fax.

Premier Mounts
Attn: Warranty Claim
3130 E. Miraloma Avenue
Anaheim, CA 92806

How State Law Applies

THIS WARRANTY GIVES YOU SPECIFIC LEGAL RIGHTS, AND YOU MAY ALSO HAVE OTHER RIGHTS WHICH VARY FROM STATE TO STATE.



205 Westwood Ave, Long Branch, NJ 07740
Phone: 866-94 BOARDS (26273) / (732)-222-1511
Fax: (732)-222-7088 | E-mail: sales@touchboards.com