

English

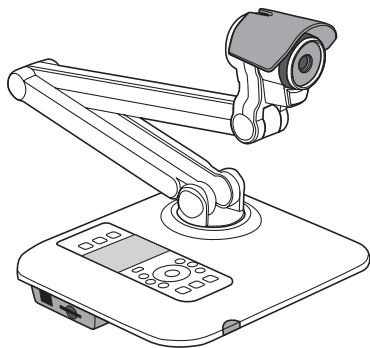

QOMO Portable Document Camera
QPC60

- **Welcome:**

Thanks for purchasing this product. Please read the instructions carefully before using this product.

- **FCC Compliance Statement (Class A):**

This device complies with Part 15 of the FCC Rules. Operation is subject to the following two conditions: (1) this device may not cause harmful interference, and (2) this device must accept any interference received; including interference that may cause undesired operation.



- **Federal Communications Commission (FCC) Statement :**

This Equipment has been tested and found to comply with the limits for a Class A digital device, pursuant to Part 15 of the FCC rules. These limits are designed to provide reasonable protection against harmful interference when the equipment is operated in a commercial environment. This equipment generates, uses and can radiate radio frequency energy and, if not installed and used in accordance with the instructions, may cause harmful interference to radio communications. Operation of this equipment in a residential area is likely to cause harmful interference in which case the user will be required to correct the interference at his own expense.

- **European Community Compliance Statement (Class A):**

This is a class A product. In a domestic environment this product may cause radio interference in which case the user may be required to take adequate measures.



- **VCCI-A**

This is a Class A product.

In a domestic environment this product may cause radio interference, in which case the user may be required to take corrective actions.

The symbol of the crossed out wheeled bin indicates this product should not be placed in municipal waste. Instead, you need to dispose of the waste equipment by handing it over to a designated collection point for the recycling of waste electrical and electronic equipment.



Warning

1. Do not allow children to operate the folding arm without supervision.

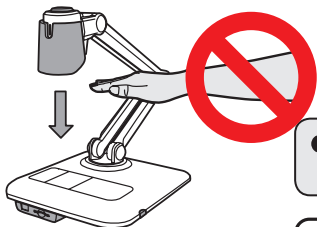

❗ Do not put your hands here to avoid injury.

2. Do not look directly at the LED light source, which may cause retinal damage.

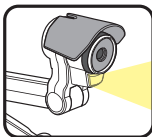

3. Carry the product by holding the lower part of the main unit in both hands. Never hold the product by the arm or the camera head only.

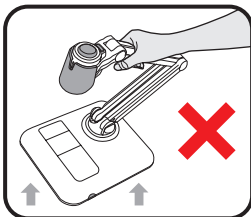
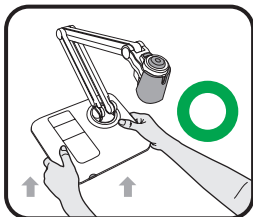

4. The camera can be damaged if it hits a desk surface or any hard object.

5. Never turn the arm in the opposite direction.

6. Be sure to hold the arm when turning it.

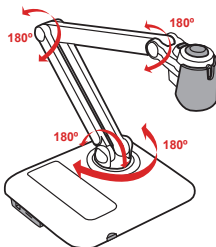







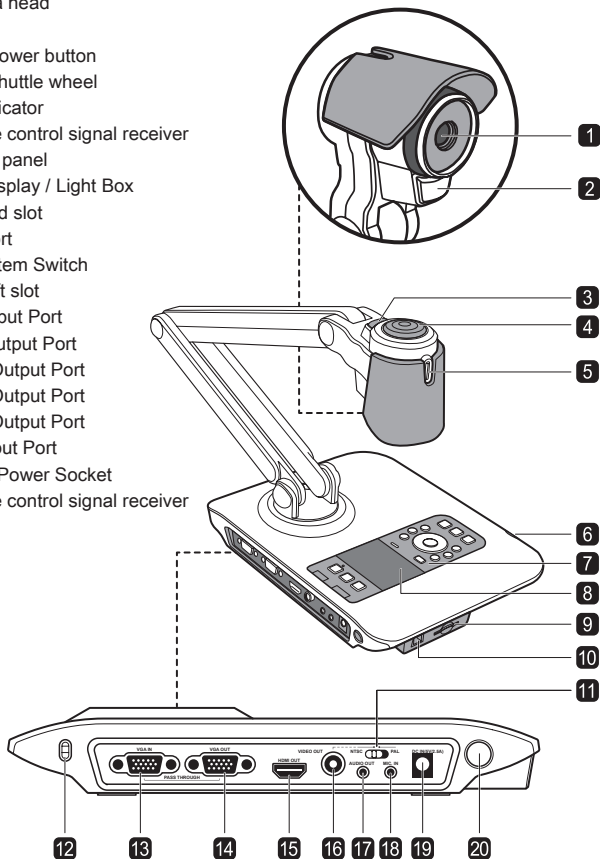







Preparing the document camera

● Knowing the document camera parts

- 1 Camera head
- 2 Lamp
- 3 Lamp power button
- 4 Lamp shuttle wheel
- 5 Led indicator
- 6 Remote control signal receiver
- 7 Control panel
- 8 LCD Display / Light Box
- 9 SD Card slot
- 10 USB port
- 11 TV System Switch
- 12 Antitheft slot
- 13 VGA Input Port
- 14 VGA Output Port
- 15 HDMI Output Port
- 16 Video Output Port
- 17 Audio Output Port
- 18 MIC Input Port
- 19 DC 5V Power Socket
- 20 Remote control signal receiver























Control Panel

Button	Function
	Select output port.
	Select Aspect Ratio. 16:9 for 1280x720 / 4:3 for 1024x768
	3" screen backlight on / off.
	Power on / off.
PC	Pass the signal from PC via RGB input port to RGB output port.
	Display toggle. Toggle between the 3" LCD display and external display device.
	Freeze the current image. *Pause the clip while playing videos.
	Show or hide OSD menu.
	Record a video clip.
	Capture a still image.
	Playback mode to display recorded pictures and video clips.
	Invert image 180°.
	Select and adjust.
	Zoom out / Zoom in.
	One-shot auto focus.



Remote Control

Button	Function
	Laser pointer / Brightness hotkey * The function varies with model.
	Power on / off
	Freeze current image. * Pause the clip while playing videos
ICON	Show or hide on-screen icons
	To show or hide OSD menu
	Playback mode to display recorded pictures and video clips
	Invert image 180°
	Select and adjust
	Record a video clip
	Capture a still image
	Zoom out / Zoom in
	One-shot auto focus
	Use the level bar to adjust the focus manually
	2X or 4X digital zoom
	Highlight function on / off
	Mask function on / off
	Marco / Normal switch
	Adjust highlighted / masked area size
	Set color for highlighted / masked area

Button	Function
	Increase / decrease the sound volume.
	Picture in Picture function on / off *For displaying a still image as an insert while displaying another image.

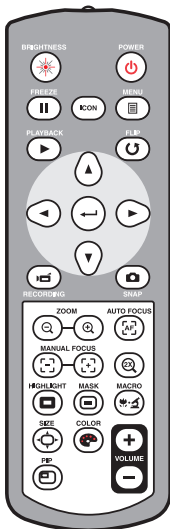

- ❗ Infrared remote control can only be used in proximity to the unit.
- ❗ Remove the battery cover and load the batteries into the battery compartment correctly according to the "+" and "-" symbols.
- ❗ Be sure to use two AAA batteries. Do not use new and old batteries or different battery types together.

Setting up

This section provides useful tips on how to adjust the document camera smoothly for your needs.

● Camera head

The camera head can turn freely at 180° up and down.

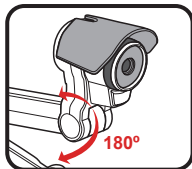

● Illumination lamp

If the light is too dark, please turn on the lamp on camera head to make best exposure.

1. Press the lamp button to turn on / off the illumination lamp.
2. Adjust the brightness by rotating the shuttle wheel on top of the camera head.

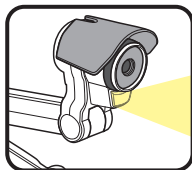
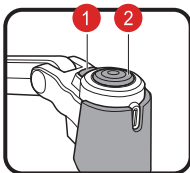

● Mechanical folding arm

The folding arm can turn freely 180° up and down and the lower arm can rotate 180° for a different working area.

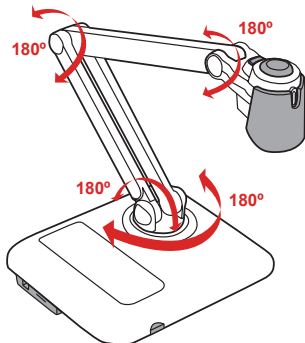

● Recommended working area

► Main working area

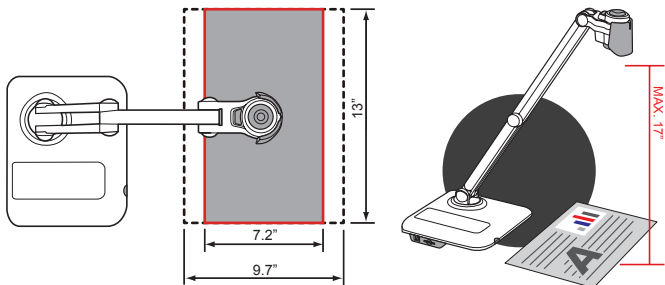

► Secondary working area

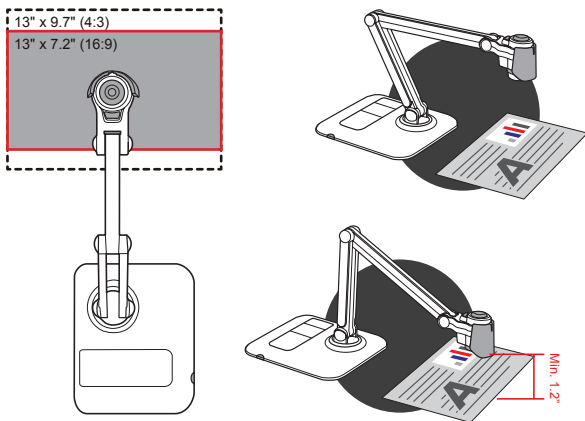



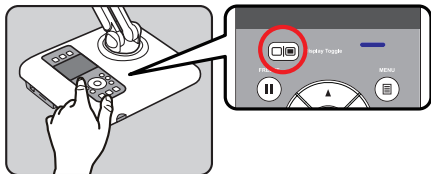

- ❗ If the document is not put in the recommend working area, the image should be rotated by FLIP button (☺) on control panel or remote control.

● Recommended panel switch function

Press Display toggle () to preview images and videos in the external display device.



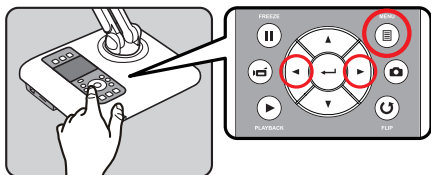

● Adjusting the brightness

1. Press MENU button (), and select the brightness mode ().
2. Use ( or ) buttons to increase or decrease the brightness level.



● Adjusting the size

Use the Zoom button ( / ) to zoom in or zoom out the screen.

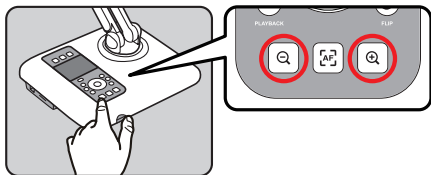

● Adjusting the focus

► Automatic focus

Press AF button ([AF]) to automatically focus. This function provides a one-shot auto-focus.

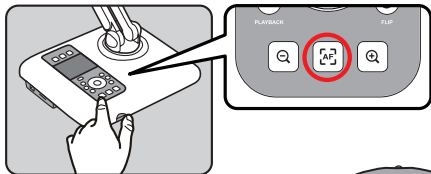

► Manual focus

Use the manual focus button ([] / []) (★) on remote control to finetune the focus.

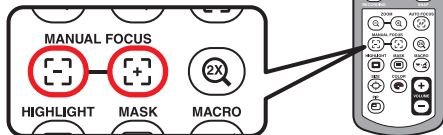

● Anti-glare

Anti-glare sheet is a transparent plastic that is overlaid on top of shiny object or glossy surface to reduce the glare.

To use, simply place the anti-glare sheet on top of shiny object to glossy surface such as magazine to reduce light reflection.

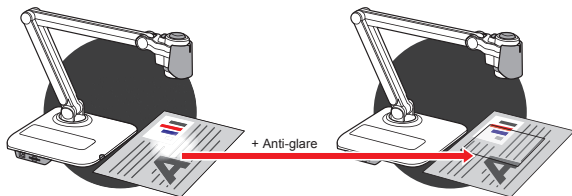

● Inserting and Ejecting an SD / SDHC card (Not supplied)

1. Insert a memory card (SD/SDHC/MMC/MMC 2.0) with the label facing up until it reaches the end of the slot.
2. When the card is inserted successfully, the icon () will appear on screen and the internal memory will become inaccessible.
3. To remove the card, push the card to release it and then pull it out gently.

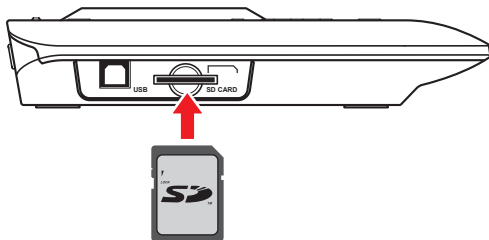

- ❗ When using a brand new memory card, you are recommended to format the card with the product. Do not turn off the power while formatting the SD card.
- ❗ Even If your card has already been formatted on other devices, you may have to reformat the card using the product.
- ❗ If no external storage devices are connected, all files will be saved in the built-in memory.

Making the Connections

● System diagram

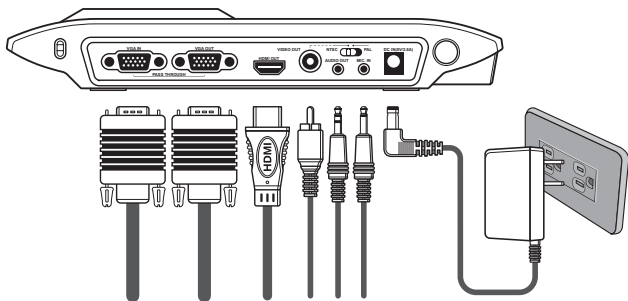

Step 1 / Plugging in the Power Outlet

Use power adapter to connect DC IN connector on the product to a standard 100V~240V AC power outlet.















ⓘ The type of power adapter is depending on your countries / regions.

Step 2 / Output resolution and aspect ratio

Various output resolutions are available depending on the output and aspect ratio setting. Please refer to the table listed below.

Output	ASPECT RATIO	TV system	Resolution	Vertical Frequency
HDMI	16:9	-	1280x720	50Hz/ 60Hz
	4:3	-	1024x768	50Hz/ 60Hz
VIDEO	-	NTSC	720x480	60Hz
	-	PAL	720x576	50Hz
VGA	16:9	-	1280x720	50Hz/ 60Hz
	4:3	-	1024x768	50Hz/ 60Hz

Step 3 / Connecting with Components

	Product Port	Cable	Display Device Port
HDMI	 HDMI OUT		 HDMI
VGA	 RGB OUTPUT		 RGB INPUT
	 AUDIO OUTPUT		 AUDIO IN
VIDEO	 VIDEO OUTPUT		 VIDEO IN
	 AUDIO OUTPUT		 AUDIO IN

► HD TV

• Connect via HDMI OUTPUT

1. Use HDMI cable to connect to your HDTV via the HDMI OUT connector.
2. Make sure the output switch is set for HDMI mode and select an appropriate Aspect Ratio.

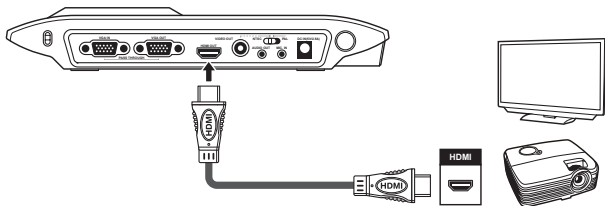

ⓘ When connecting HDMI OUT, it can play audio and video synchronization.

► Standard TV

• Connect via VGA OUTPUT

1. To display images, you can use VGA cable to connect to your television's RGB port via the VGA OUT connector.
2. Make sure the output switch is set for VGA mode and select an appropriate Aspect Ratio.
3. To output sound, you can simply use internal speaker, or connect a speaker to the AUDIO OUT port.

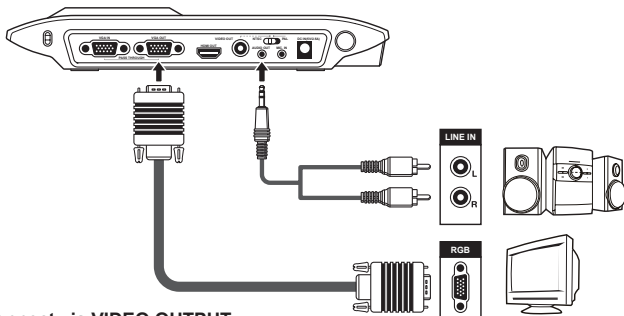

• Connect via VIDEO OUTPUT

1. To display images, you can use VIDEO cable(yellow) to connect to the C-video in on your television via the VIDEO OUT connector.
2. Make sure the output switch is set for VIDEO mode.
3. To output sound, use the AUDIO cable to connect to your television via the AUDIO OUT connector a TV.

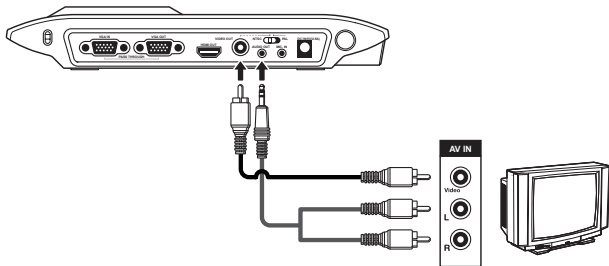

- ⓘ Please make sure to adjust TV SYSTEM(NTSC / PAL) switch setting.
NTSC:America, Taiwan, Panama, Canada, Chile, Japan, Korea and Mexico.
PAL:Europe, China and Hong Kong.

● Connect to a speaker system

Plug a 3.5mm plug speaker to AUDIO OUT connector on the product. Only the audio from the video playback is supported.

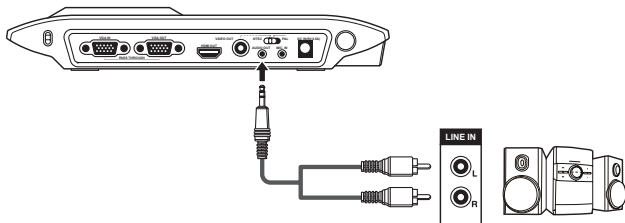

- ❗ If HDMI OUT and AUDIO OUT are connected simultaneously, the audio from HDMI OUT device will be disabled but output from AUDIO OUT device.
- ❗ Take caution when using earphones. Adjust the volume down to prevent hearing damage due to loudness.

● Connect to an external microphone

Plug a 3.5mm mono microphone to MIC. IN connector on the product. The built-in microphone will be disabled when an external microphone is connected.

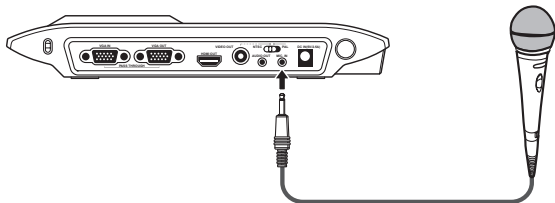

● Connect to a computer

► Connect via VGA cable

Use VGA cable to connect VGA IN connector on the product to the VGA OUT connector on the computer.

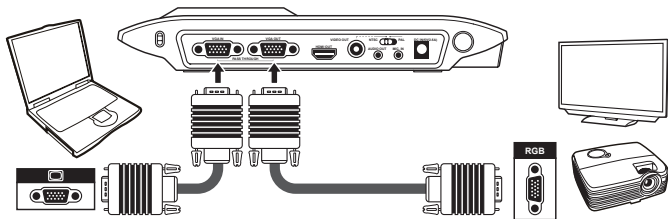



- ❗ To display computer image, press PC button (**PC**) on the control panel.
- ❗ For laptop to output display mode, use the keyboard command (Fn + ) to switch between the display modes. For different command, please refer to your laptop manual.
- ❗ The signal is only pass through from VAG IN port to VGA OUT port on document camera. It cannot display computer image on 3" LCD panel. Please connect an output device to display the image on computer.

► Connect via USB

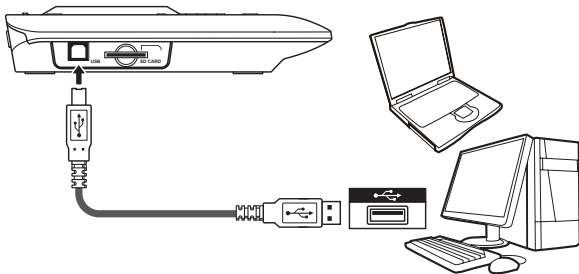









Press MENU () button → select "USB Connect". Choose "Disk" to connect mass storage. Choose "PC Cam" to be as a PC-Cam.













Basic operation





1. Press MENU () button on the remote control or control panel.
2. Press (◀ or ▶) button to toggle between tabs.
3. Press (←) to make a selection and display the setting selections.
4. Use (◀ or ▶) to adjust the setting.
5. Press (←) to make the new setting activate.
6. Press MENU () button again to hide the OSD menu.

● Menu options in Preview Mode

Name	icon	Option	Description
Brightness		-	Use the Right / Left buttons to make the image brighter / darker
Still Resolution		2M / 5M / 12M	Select the desired still image resolution.
Effect		Graphic 1	To improve the tint of color-based subjects such as pictures or figures, select Graphic 1 or Graphic 2, which represent different level of tint, to satisfy your presentation.
		Graphic 2	
		Text 1	The function is designed especially for text-based documents to which can be enhanced white and black subjects such as characters and lines. The effect goes stronger as the number increase.
		Text 2	
		B&W	To output a black & white camera image. To make the image easier to view, select this when shooting black & white documents etc.
		Negative	To output a negative camera image.
Quick Zoom		2X / 4X	Set the quick zoom to 2X or 4X.
Focus		Normal	Select standard mode for 20cm ~ 00.
		Macro / Microscope	Select Macro/Microscope mode to take close-ups or while connecting to a microscope.

Name	icon	Option	Description	
HD Rec. Mode		On / Off	Enable HD Rec. mode on / off *When enter the HD Rec. mode, the output signal will be terminated and then press "Recording" button to record videos in High Definition (1280x720) resolution.	
SETTING	Beep		On / Off	Enable beep sound on / off
	Flicker		50Hz / 60Hz	Set flicker frequency to 50Hz or 60Hz The flicker setting is based on the frequency standard of your local power supply.
	USB Connect		Disk	Select "Disk" to enter Mass storage Mode
			PC cam	Select "PC Cam" to enter PC Cam Mode
			Off	Disable USB function
	Language		-	Allows you select the language used for OSD
	Volume		-	Use the Right / Left buttons to adjust volume
	Clock		-	Set date and time
	Format		No / Yes	Format the storage medium. Note that all files stored in the medium will be gone.
	Reset default		No / Yes	Restore factory defaults. Note that your current settings will be overwritten.

● Menu options in Playback Mode

Name	icon	Option	Description
File Info		-	View the file's title , saved date and time , size and the length of recording.
Slide show		Off / 5s / 10s / 30s	Start a slide show with selected interval time.
Delete one		Yes / No	Delete current file.
Delete all		Yes / No	Delete all images of the same type stored in the memory.







● Recording a video clip / Taking a still picture

1. Choose the focus mode according to distance to object:

Normal mode for 20cm to ∞.

Macro mode () or () (★) for 5cm ~ 20cm.



2. Use the Zoom button ( / ) to zoom in or zoom from the screen.
3. Automatic focus/Manual focus
Press AF button () to focus automatically. This function provides a one-shot auto-focus.
Use manual focus button ( / ) (★) on the remote control to fine-tune focus.
4. Press the Record button () to start recording and press it again to stop recording.
Press the Shutter button () to take a still picture.

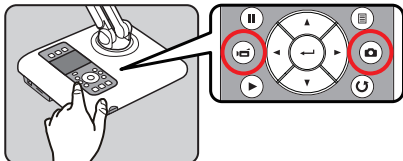



- ! The default resolution of video clip is SVGA.

Use "REC HD" mode to record high resolution video in HD720p. "REC HD" only supports the built-in 3" LCD display.

● Playing-back

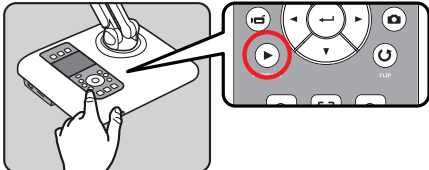
1. Press PLAYBACK button ().



2. The last recorded picture or video clip will play.
3. Use Up / Down button to choose files.
4. Press the zoom out button (). The 9-image display will appear.

● Copying files to your computer

Please notice that the video clips are recorded in MP4 format and are compiled as CLIPxxxx.mp4 (xxxx are four serial numbers).

Before viewing these videos on your PC, you may need to install some media programs.

1. Power on the product.
2. Connect the product to your computer with USB cable.
3. Press MENU () → select "USB Connect" → choose "Disk". The built-in memory or external memory will be detected.

Then, You can view the image data on a SD card on the PC's viewer software or simply cut and paste the file to your PC.



- ❗ When the operating panel or the remote control is in operation, do not connect or disconnect the USB cable, as this could cause the product to malfunction. This may cause malfunctions to occur.
- ❗ If you would like to change the setting, please refer to the "Advanced settings" section for more information.

● Using product as a PC cam

Installing the software

The PC Camera driver is included in the accessory CD, and therefore you should install the driver before using PC Camera.

Starting the application

1. Connect the product to your computer.
Turn on your computer, then connect the accessory USB cable to the USB port of your computer.
Make sure the connector and the port are correctly aligned.
2. Switch to PC Cam mode.
Connect the other end of the USB cable to the main unit.
Power on press MENU () → select USB Connect → select PC Cam () and press OK button to confirm.
3. Launch PC Camera
After the product is correctly connected to and detected by your PC, you are ready to launch your favorite software (such as MSN Messenger or Yahoo Messenger) to use PC Camera function.

Advance operation

● Highlight function / Mask function(★)

Highlight function



1. Use the Highlight display to draw attention to a particular section of the output image.
2. Press the Highlight button () on the remote control, and use the direction buttons to move the highlighted area.



Mask function

1. You can mask a section of the output image.
2. Press the Mask button () on the remote control, and use the direction buttons to move the masked area.

4 + 3 = 

- ❗ Press the Size button () on the remote control, and use the direction buttons to adjust the highlighted / masked size.
- ❗ Press the Color button () on the remote control, and use the direction buttons to adjust the color of highlighted / masked area.

● PIP (Picture in Picture) function(★)

1. Press the PIP button () to display an around quarter-size still image on a live camera display.
2. Use the up / down button to move the still image to the top left and bottom left.
3. Use the left or right button to change the shift between still images.

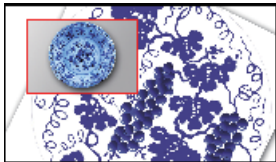

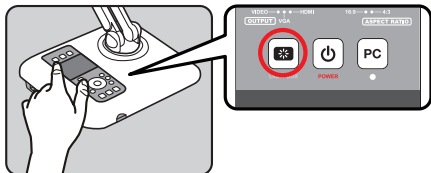

● Project slides

1. Place the anti-glare sheet on top of the built-in panel first and then place the slide on top of the anti-glare sheet.
2. Press LightBox button () to turn on the panel's backlight as a lightbox.

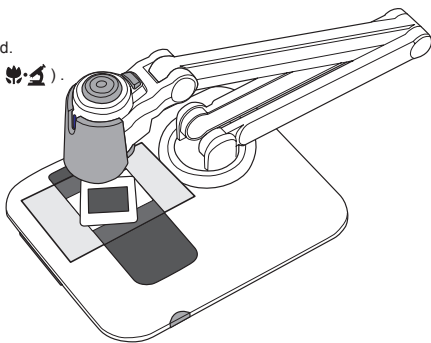

3. Adjust the position of camera head.
4. Switch the focus mode to Macro ().



5. Press the AF button () to get clear image.

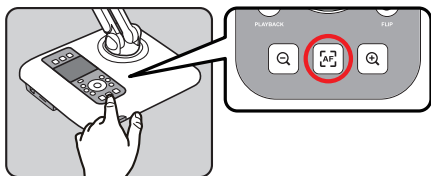

● Connect to a microscope

Connect to a microscope enables you to examine microscopic objects on a big screen.

1. Adjust the microscope and focus objects.
2. Choose an appropriate microscope adapter.
3. Microscope adapter accessories are applicable to $\varnothing 28\text{mm}$, $\varnothing 31\text{mm}$, $\varnothing 33\text{mm}$, and $\varnothing 34\text{mm}$ eyepieces.

❗ For eyepieces of about $\varnothing 33\text{mm}$, $\varnothing 34\text{mm}$, only a microscope adaptor with $\varnothing 33$ or $\varnothing 34\text{mm}$ label should be installed.

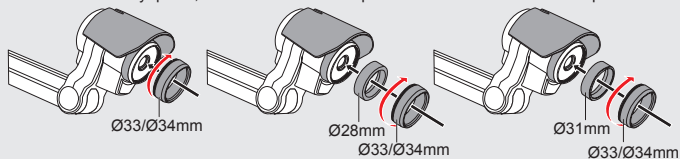

❗ For a $\varnothing 28\text{mm}$ eyepiece, insert the $\varnothing 28\text{mm}$ adapter into the $\varnothing 33$ or $\varnothing 34\text{mm}$ adapter.

❗ For a $\varnothing 31\text{mm}$ eyepiece, insert the $\varnothing 31\text{mm}$ adapter into the $\varnothing 33$ or $\varnothing 34\text{mm}$ adapter.



4. Mount the microscope adapter onto the Lens.

5. Switch the focus mode to Macro.

Press MENU () --> select Focus () -->

select Macro



or press Macro button () (★) on remote controller.

6. Connect the lens with microscope adapter to the microscope.

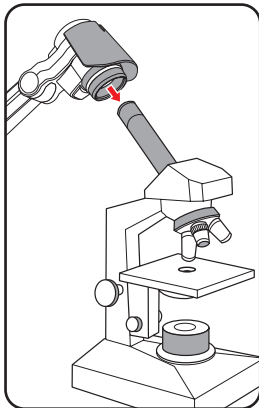

❗ If the image is not clear. Please adjust the focus of microscope.

❗ Press the AF button () or use the manual focus button on remote control to fine-tune the focus.

Storing

1. Power off the product.

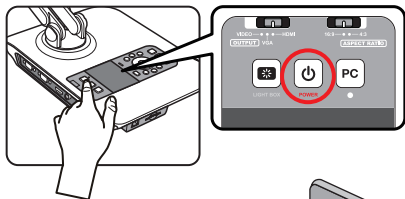

2. Unplug the AC adapter from the wall outlet. Then, disconnected the AC Adapter and all cables.

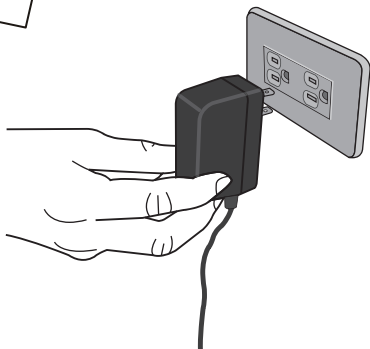



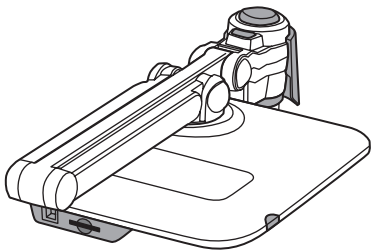

3. Fold the camera head and arms in the direction shown in the figure.



Troubleshooting

When using the document camera :		
Problem	Cause	Solution
Cannot be powered on normally.	The AC adapter is not correctly connected to the wall outlet or the document camera.	Re-connect one end of the AC adapter to the document camera and the other end to a wall outlet.
Cannot take pictures and video clips.	Out of memory.	Free some space from the SD / MMC card or the internal memory.
	Using a "protected" SD card.	Set the SD card to be written in.
No image output after connecting.	The document camera is not correctly connected to the external device.	Re-connect all related cables with the external device correctly.
	Incorrect input type of display output device.	Set up correct input type of display output device.
	Incorrect supported resolution of display output device.	Set up correct supported resolution of display output device.
	Incorrect output port selected by output switch on document camera.	Set up correct output port by output switch.
	Built-in 3" LCD display is on.	Press Display Toggle [] to switch display output between the 3" LCD display and external display device.
	PC pass through button indicator is on.	Press [PC] pass through button to turn off the function.
	Rec HD has no image output.	Rec HD displays only on the 3" LCD panel.

When using the document camera :		
Problem	Cause	Solution
The image is fuzzy.	Probably the distance of object is too close to the lens.	Press AF button to auto focus or adjust by pressing Manual Focus.
		Select Macro mode if the distance is less 20cm.
The image is reverse.	The document is not put in the recommend working area.	Press [] button to adjust the direction.
The image dose not move.	Camera image is set to Freeze [].	Press the [] button on the control panel again to unpaue.
The button of LightBox is no function.	The 3" LCD display is already on.	Press Display Toggle [] to switch display output, then press LightBox to turn on the 3" LCD backlight.
Remote control can not work.	No power.	Replace the AAA batteries in the remote control.
	Object is blocking the remote control signal receiver of the product.	Remove obstruction in front of the product.
	The distance of usage is too far.	Stand closer to the product to use the remote control.
The LCD screen displays "MEMORY ERROR" or "CARD ERROR" message. Or memory card cannot be read.	The format of the memory card is not compatible with the product.	Use the product "Format" function to format the card.
	The memory card is corrupted.	Replace the memory card with a new one.

When using the document camera :

Problem	Cause	Solution
Cannot delete the pictures and video clips, and also cannot find them in the memory card.	The lost recordings are saved in the internal memory.	It happens when you insert a memory card after taking a few pictures or video clips. You can access those files after removing the memory card.
Cannot view the video clips on my computer.	Software is not installed on the computer.	Install Direct X 9.0c or above and Windows Media 9.0 Co-decs to solve this problem. Go to the website " http://www.microsoft.com " to download the required files. Please refer to "Copying files to your computer".
TV screen does not display after connecting the product to TV.	The product is not correctly connected to the TV.	Reconnect the product to TV correctly.
Noises occur when viewing images on the LCD screen or on the computer.	The flicker setting does not match the standard of the country you are staying.	Adjust the flicker setting .For more information, please refer to the "Flicker Settings" table.

ⓘ The contents in this manual are subject to change without prior notification.

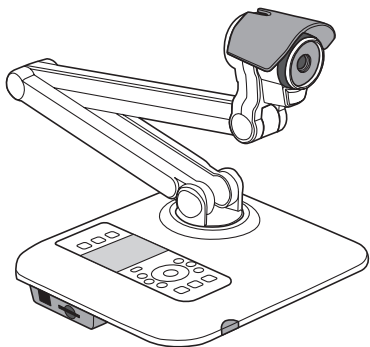

Touchboards 1-866-942-6273

205 Westwood Ave, Long Branch, NJ 07740