

RIGOL

User's Guide

**DSA800 Series
Spectrum Analyzer**

Dec. 2011

RIGOL Technologies, Inc.

Guaranty and Declaration

Copyright

© 2011 RIGOL Technologies, Inc. All Rights Reserved.

Trademark Information

RIGOL is a registered trademark of **RIGOL** Technologies, Inc.

Publication Number

UGD03103-1110

Notices

- **RIGOL** products are protected by patent law in and outside of P.R.C.
- **RIGOL** Technologies, Inc. reserves the right to modify or change parts of or all the specifications and pricing policies at company's sole decision.
- Information in this publication replaces all previously corresponding material.
- **RIGOL** shall not be liable for losses caused by either incidental or consequential in connection with the furnishing, use or performance of this manual as well as any information contained.
- Any part of this document is forbidden to be copied or photocopied or rearranged without prior written approval of **RIGOL**.

Product Certification

RIGOL guarantees this product conforms to the national and industrial standards in China. International standard conformance certification is in progress, e.g. ISO. At present the analyzer has passed CE, PictBridge, LXI and cTUVus certification.

Contact Us

If you have any problem or requirement when using our products, please contact RIGOL Technologies, Inc. or your local distributors, or visit: www.rigol.com

Safety Requirement

General Safety Summary

Please review the following safety precautions carefully before putting the instrument into operation so as to avoid any personal injuries or damages to the instrument and any product connected to it. To prevent potential hazards, please use the instrument only specified by this manual.

Use Proper Power Cord

Only the power cord designed for the instrument and authorized by local country could be used.

Ground the Instrument

The instrument is grounded through the Protective Earth lead of the power cord. To avoid electric shock, it is essential to connect the earth terminal of power cord to the Protective Earth terminal before any inputs or outputs.

Observe all Terminal Ratings

To avoid fire or shock hazard, observe all ratings and markers on the instrument and check your manual for more information about ratings before connecting.

Use Proper Overvoltage Protection

Make sure that no overvoltage (such as that caused by a thunderstorm) can reach the product, or else the operator might expose to danger of electrical shock.

Do Not Operate Without Covers

Do not operate the instrument with covers or panels removed.

Use Proper Fuse

Please use the specified fuses.

Avoid Circuit or Wire Exposure

Do not touch exposed junctions and components when the unit is powered.

Do Not Operate With Suspected Failures

If you suspect damage occurs to the instrument, have it inspected by qualified service personnel before further operations. Any maintenance, adjustment or replacement especially to circuits or accessories must be performed by **RIGOL** authorized personnel.

Keep Well Ventilated

Inadequate ventilation may cause an increase of temperature or damage to the device. So please keep well ventilated and inspect the intake and fan regularly.

Do Not Operate in Wet Conditions

In order to avoid short circuiting to the interior of the device or electric shock, please do not operate in a humid environment.

Do Not Operate in an Explosive Atmosphere

In order to avoid damages to the device or personal injuries, it is important to operate the device away from an explosive atmosphere.

Keep Product Surfaces Clean and Dry

To avoid the influence of dust and/or moisture in air, please keep the surface of device clean and dry.

Electrostatic Prevention

Operate in an electrostatic discharge protective area environment to avoid damages induced by static discharges. Always ground both the internal and external conductors of the cable to release static before connecting.

Handling Safety

Please handle with care during transportation to avoid damages to buttons, knob, interfaces and other parts on the panels.

Safety Terms and Symbols

Terms in this Manual. These terms may appear in this manual:



WARNING

Warning statements indicate the conditions or practices that could result in injury or loss of life.



CAUTION

Caution statements indicate the conditions or practices that could result in damage to this product or other property.

Terms on the Product. These terms may appear on the product:

DANGER indicates an injury or hazard may immediately happen.

WARNING indicates an injury or hazard may be accessible potentially.

CAUTION indicates a potential damage to the instrument or other property might occur.

Symbols on the Product. These symbols may appear on the product:



Hazardous Voltage



Refer to Instructions



Protective Earth Terminal



Chassis Ground



Test Ground

General Care and Cleaning

General Care:

Do not store or leave the instrument in where the instrument will be exposed to direct sunlight for long periods of time.

Cleaning:

Clean the instrument regularly according to its operating conditions. To clean the exterior surface, perform the following steps:

1. Disconnect the instrument from all power sources.
2. Clean the loose dust on the outside of the instrument with a lint- free cloth (with mild detergent or water). When cleaning the LCD, take care to avoid scarifying it.



CAUTION

To avoid damages to the instrument, do not expose them to liquids which have causticity.



WARNING

To avoid injury resulting from short circuit, make sure the instrument is completely dry before reconnecting into a power source.

Environmental Considerations

The following symbol indicates that this product complies with the applicable European Union requirements according to Directives 2002/96/EC on waste electrical and electronic equipment (WEEE) and batteries.



Product End-of-Life Handling

The equipment may contain substances that could be harmful to the environment or human health. In order to avoid release of such substances into the environment and harmful to human health, we encourage you to recycle this product in an appropriate system that will ensure that most of the materials are reused or recycled appropriately. Please contact your local authorities for disposal or recycling information.

DSA800 Series Overview

DSA800 series spectrum analyzers which are small, light and cost-effective, are portable spectrum analyzers designed for starters. Configured with easy-to-operate numeric keyboard, high-resolution color LCD display and various remote communication interfaces, they can be widely used in various fields, such as education, company research and development as well as industrial manufacture.

Main features:

- Frequency Range: 9 kHz to 1.5 GHz
- Displayed Average Noise Level (DANL): -135 dBm (Typical)
- Phase Noise: -80 dBc/Hz @ 10 kHz offset
- Total Amplitude Accuracy: <1.5 dB
- Minimum Resolution Bandwidth (RBW): 100 Hz
- EMI Filter and Quasi-Peak Detector Kit (Option)
- VSWR Measurement Kit(Option)
- Standard with Preamplifier and AM/FM Demodulation Function
- Various measurement functions (option)
- 1.5 GHz Tracking Generator (option)
- 8 inch (800×480 pixels) high-definition display with clear, vivid, and easy-to-use graphical interface
- Various interfaces such as LAN, USB Host, USB Device and GPIB (option)
- Compact design with only 9.4 lbs

Document Overview

Topics in this manual:

Chapter 1 Quick Start

This chapter introduces the front/rear panel and user interface as well as announcements during first use of the analyzer.

Chapter 2 Front Panel Operation

This chapter gives detailed function descriptions of the front panel keys with their associated menu keys.

Chapter 3 Remote Control

This chapter shows how to control the analyzer in remote mode.

Chapter 4 Troubleshooting&Message

This chapter lists the troubleshooting information and messages that may appear during the use of the analyzer.

Chapter 5 Specifications

This chapter lists the specifications and general specifications of the analyzer.

Chapter 6 Appendix

This chapter lists the options and accessories that can be ordered along with your analyzer as well as the service and support information.

Format Conventions in this manual:**1. Buttons:**

The keys at the front panel are usually denoted by the format of "Button name (Bold) +textbox", such as **FREQ**.

2. Menu keys:

The menu softkeys are usually denoted by the format of "Menu word (Bold) +character shading", such as **Center Freq**.

3. Connectors:

The connectors at the front or rear panel are usually denoted by the format of "Connector name (Bold) +square brackets (Bold)", such as **[GEN OUTPUT 50Ω]**.

4. Operation steps:

"→" represents the next step of operation, such as **FREQ** → **Center Freq** indicates pressing **FREQ** at the front panel and then pressing the menu softkey **Center Freq**.

User manuals provided with this product:

User's Guide, Quick Guide, Programming Guide, Data sheet etc. For the desired manual, please download it from www.rigol.com.

Contents

Guaranty and Declaration	I
Safety Requirement	II
General Safety Summary.....	II
Safety Terms and Symbols	IV
General Care and Cleaning	V
Environmental Considerations.....	VI
DSA800 Series Overview	VII
Document Overview	VIII
Chapter 1 Quick Start	1-1
General Inspection	1-2
Appearance and Dimensions	1-3
To Prepare for Use	1-4
To Adjust the Supporting Legs	1-4
To Connect to Power	1-5
Power-on Inspection	1-6
Self-calibration	1-6
Front Panel.....	1-7
Front Panel Function Keys	1-8
Front Panel Key Backlight	1-10
Front Panel Connectors	1-11
To Use the Numeric Keyboard	1-13
Rear Panel.....	1-15
User Interface.....	1-17
Menu Operation	1-20
Parameter Setting	1-22
To Input Filename	1-24
To Use the Built-in Help	1-27
To Use the Security Lock.....	1-29
To Replace the Fuse	1-30
Chapter 2 Front Panel Operation	2-1
Basic Settings	2-2

FREQ.....	2-2
SPAN	2-9
AMPT.....	2-12
Sweep and Function Settings.....	2-23
BW/Det.....	2-23
Sweep/Trig.....	2-28
Trace/P/F	2-34
TG.....	2-40
Measurement Settings	2-45
Meas	2-45
Meas Setup	2-49
Demod	2-75
Marker Measurements.....	2-77
Marker	2-77
Marker->	2-84
Marker Fctn.....	2-86
Peak.....	2-90
Shortcut Key	2-94
Auto	2-94
UserKey	2-96
Preset.....	2-97
Print.....	2-103
System Settings	2-104
System	2-104
Print Setup.....	2-115
Storage.....	2-118
Chapter 3 Remote Control	3-1
Remote Control Overview.....	3-2
Remote Control Method	3-3
User-defined Programming	3-3
To Use PC software	3-6
Chapter 4 Troubleshooting&Message	4-1
Troubleshooting	4-2
Messages	4-4
Information Message.....	4-6
Error Message	4-8

Status Message 4-21

Chapter 5 Specifications 5-1

 Technical Specifications 5-2

 Frequency..... 5-2

 Amplitude 5-3

 Sweep 5-6

 Trigger 5-7

 Tracking Generator (DSA815 Option) 5-7

 Input/Output..... 5-7

 General Specifications 5-9

Chapter 6 Appendix 6-1

 Appendix A: Ordering Information..... 6-1

 Appendix B: Warranty..... 6-2

 Appendix C: Any Comment or Question? 6-3

Index..... 1

Chapter 1 Quick Start

This chapter introduces the front/rear panel and the user interface, as well as announcements during first use of the analyzer.

Subjects in this chapter:

- General Inspection
- Appearance and Dimensions
- To Prepare for Use
- Front Panel
- Rear Panel
- User Interface
- Menu Operation
- Parameter Setting
- To Input Filename
- To Use the Built-in Help
- To Use the Security Lock
- To Replace the Fuse

General Inspection

1. **Inspect the shipping container for damage**

Keep the damaged shipping container or cushioning material until the contents of the shipment have been checked for completeness and the instrument has passed both electrical and mechanical tests.

The consigner or carrier shall be liable for the damage to instrument resulting from shipment. **RIGOL** would not be responsible for free maintenance/rework or replacement of the unit.

2. **Inspect the instrument**

In case of any damage, or defect, or failure, notify your **RIGOL** sales representative.

3. **Check the accessories**

Please check the accessories according to the packing lists. If the accessories are incomplete or damaged, please contact your **RIGOL** sales representative.

Appearance and Dimensions

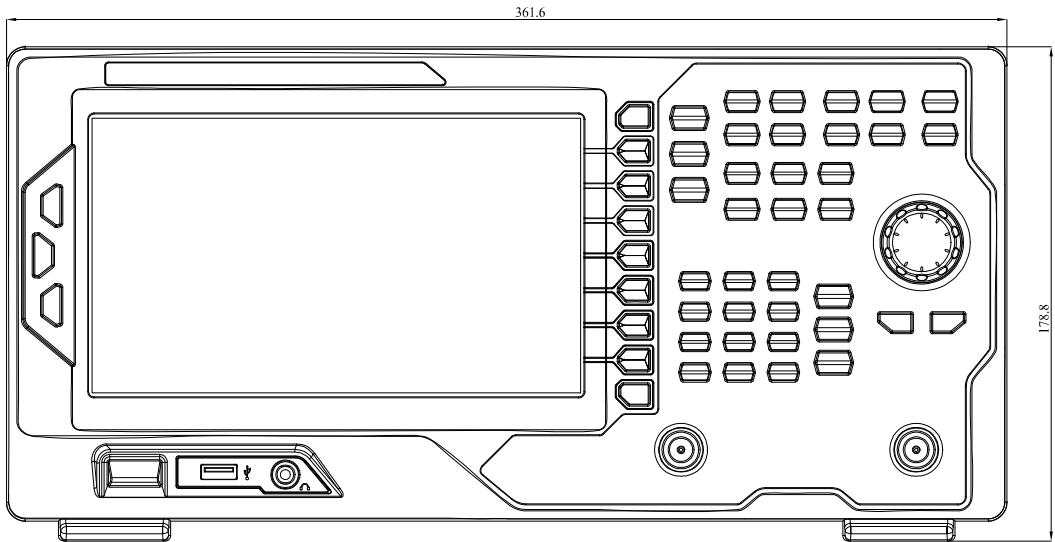

Figure 1-1 Front View

Unit: mm

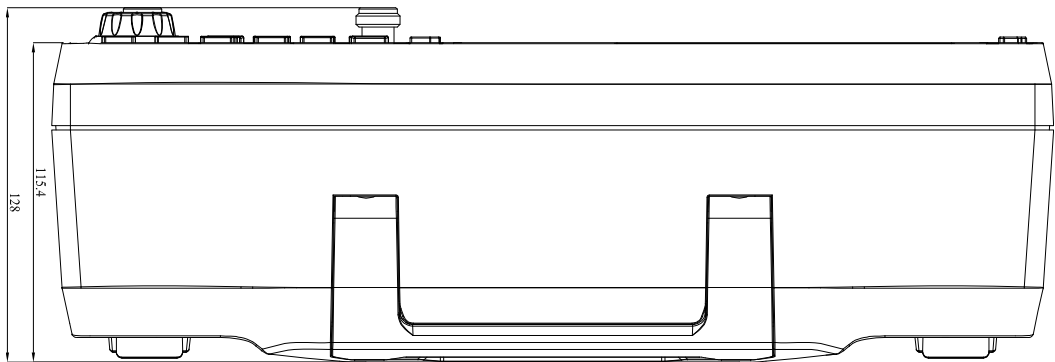

Figure 1-2 Side View

Unit: mm

To Prepare for Use

To Adjust the Supporting Legs

Users can unfold the supporting legs to use them as stands to tilt the instrument upwards for easier operation and observation. Users can also fold the supporting legs when the instrument is not in use for easier storage or shipment.

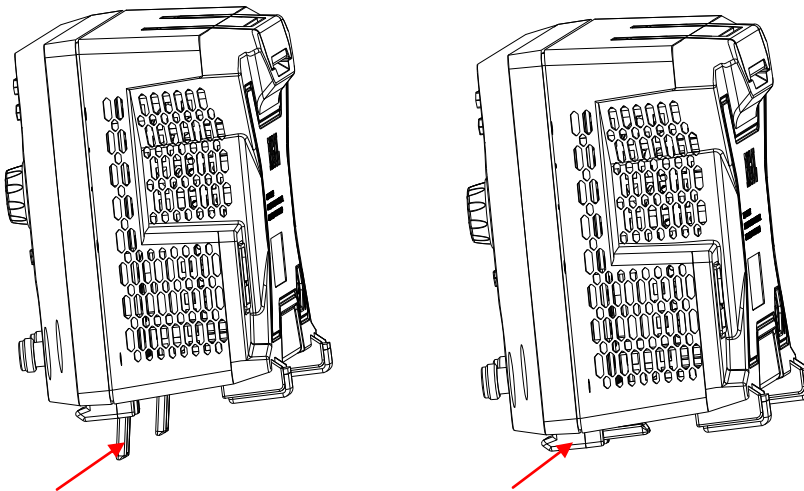

To unfold the supporting legs

To fold the supporting legs

Figure 1-3 To Adjust the Supporting Legs

To Connect to Power

Please use the power cord provided with the accessories to connect the spectrum analyzer to AC power source as shown in the figure below. For the AC voltage and frequency requirements, refer to "**Rear Panel**".

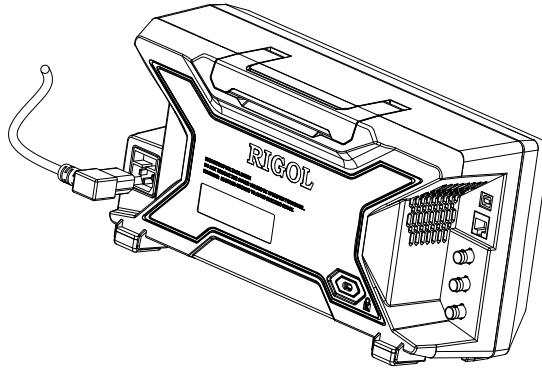



Figure 1-4 Power Cord Connection



CAUTION

Make sure that the instrument is properly grounded to avoid electric shock.

Power-on Inspection

After connecting the instrument to power source correctly, press  at the front panel to start the spectrum analyzer. Following the start-up screen which shows the start-up initialization process information, the sweep curve is displayed.

Self-calibration

After the instrument starts, execute self-calibration.

Press **System** → **Calibrate** → **Cal Now** and the instrument will perform self-calibration using the internal calibration source.

Front Panel

The front panel of DSA800 is as shown in the figure below.

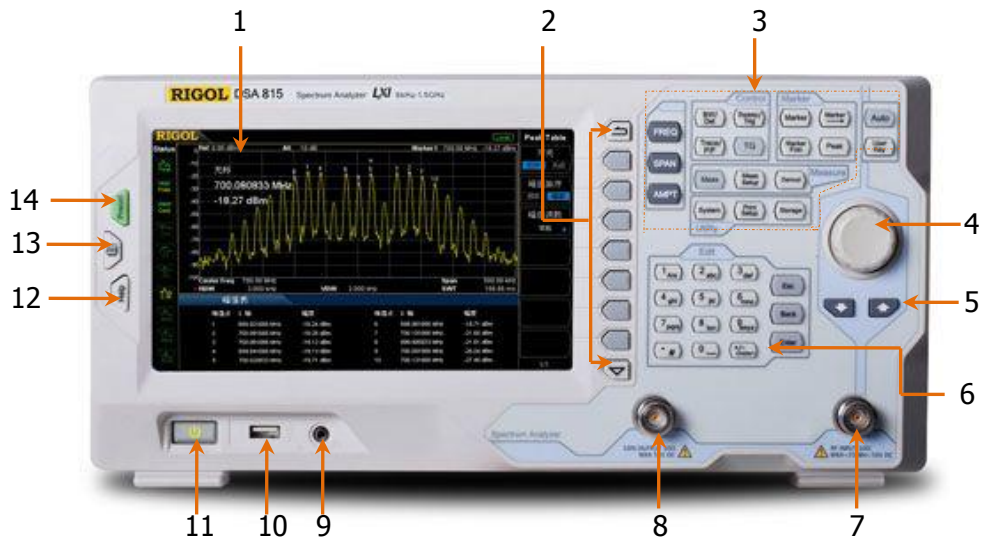

Figure 1-5 Front Panel

Table 1-1 Front Panel Description

NO.	Description	NO.	Description
1	LCD	8	Tracking generator output*
2	Menu softkeys/menu control keys	9	Earphone jack
3	Function key area	10	USB Host
4	Knob	11	Power switch
5	Direction keys	12	Help
6	Numeric Keyboard	13	Print
7	RF input	14	Preset

*Note: This function is an option for DSA815.

Front Panel Function Keys

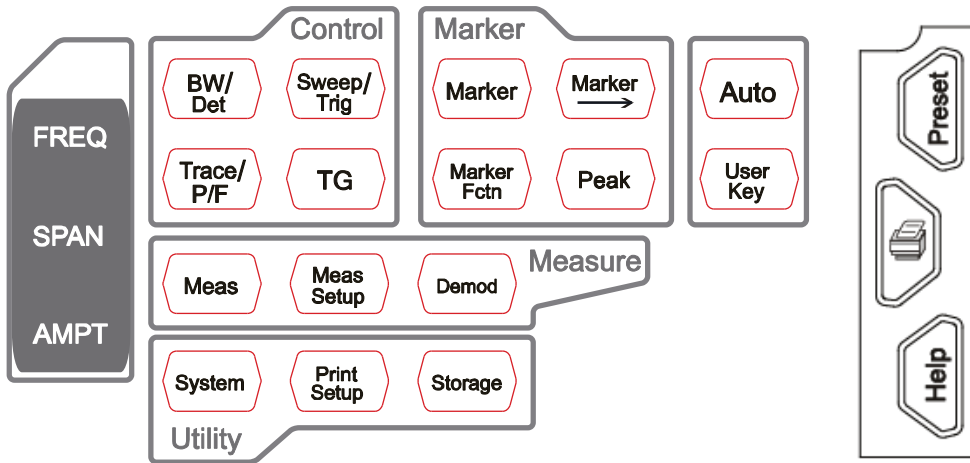



Figure 1-6 Function Key Area

Table 1-2 Function keys description

Key	Description
FREQ	Set the center, start and stop frequency; enable the signal tracking function.
SPAN	Set the frequency span of the sweep.
AMPT	Set the reference level, RF attenuator, scale and the unit of Y-axis, etc. Set the reference level offset, maximum mixing level and input impedance. Execute auto scale and auto range as well as turn on the RF preamplifier.
BW/Det	Set the resolution bandwidth (RBW) and video bandwidth (VBW). Set the detector and filter types.
Sweep/Trig	Set the sweep and trigger parameters.
Trace/P/F	Set the parameters related to trace. Configure the Pass/Fail test.
TG	Set the tracking generator*.
Meas	Select and control the measurement function*.
Meas Setup	Set the parameters for the selected measurement function*.

Demod	Set the demodulation function.
Marker	Read the amplitude, frequency and sweep time of a certain point on the trace.
Marker—>	Set other system parameters on the basis of the current marker value.
Marker Fctn	Special functions of the marker such as noise marker, N dB bandwidth measurement and frequency counter.
Peak	Open the peak search menu and search for peaks immediately.
System	Set the system parameters.
Print Setup	Set the print parameters.
Storage	Provide file storage and recall functions.
Auto	Search for signals automatically within full frequency range.
User Key	User-defined shortcut key.
Preset	Restore the system to factory settings or user-defined state.
	Print or save the current screen.
Help	Turn on the built-in help.

*Note: This function is an option for DSA815.

Front Panel Key Backlight

The on/off state and the color of the backlights of some keys at the front panel indicate the working state of the spectrum analyzer. The states are as listed below.

- 1. Power Switch** 
 - Flash on and off alternatively, in breathing state: indicate the unit is in stand-by state.
 - Constant on: indicate the instrument is in normal operating state.
- 2. TG***

When the **TG** function is enabled, the backlight of **TG** turns on and turns off when the function is disabled.
- 3. Auto**

When **Auto** is pressed, the backlight turns on. The instrument starts sweeping within the full frequency range, searches for the signal with the maximum amplitude and moves it to the center of the screen. Then the backlight turns off.
- 4. Meas***

The backlight of **Meas** turns on when VSWR or any of the advanced measurements is enabled and stays on until all measurement functions are disabled.

*Note: This function is only applicable to DSA815 installed with the corresponding option.

Front Panel Connectors

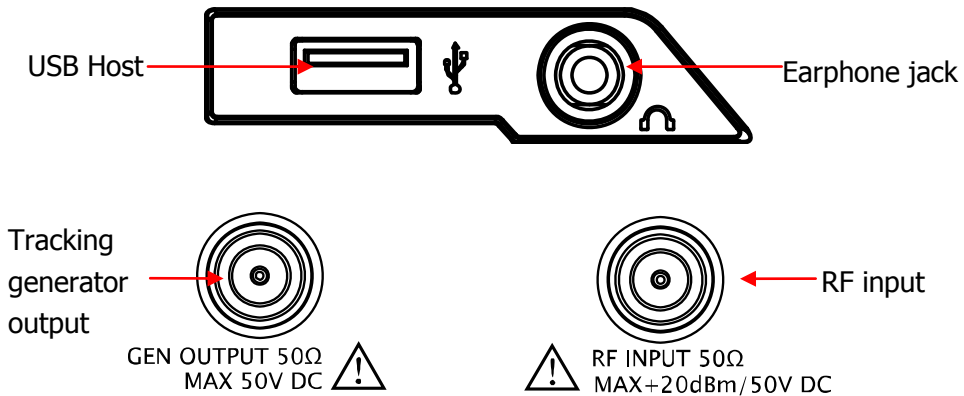

Figure 1-7 Front Panel Connectors

1. USB Host

The analyzer can serve as a “host” device to connect external USB devices. This interface is available for USB storage devices and the USB-GPIB interface converter.

- **USB Storage Device**

Read the trace or state file stored in the USB storage device, store the current instrument state or trace in the USB storage device or store the contents currently displayed on the screen in the USB storage device in “.bmp” format.

- **USB-GPIB Interface Converter**

Extend a GPIB interface for the analyzer.

2. Earphone Jack

The analyzer provides AM and FM demodulations. Insert the earphone to the jack to acquire the audio output of the demodulated signal. You can turn on or off the earphone output and adjust the volume via **Demod** → **Demod Setup**.



CAUTION

For fear of damaging your hearing, please turn the volume down to zero and gradually turn the volume up after putting on the earphone.

3. GEN OUTPUT 50 Ω

The output of the tracking generator can be connected to a receiver through a cable with an N male connector. The tracking generator is an option and you can order it when required.



CAUTION

To avoid damage to the tracking generator, the reverse power or voltage can not exceed 1 W or 50 V DC.

4. RF INPUT 50 Ω

The input terminal of the signal under measurement. **[RF INPUT 50 Ω]** can be connected to the device under measurement via a cable with an N male connector.



CAUTION

To avoid damage to the instrument, for the signal input from the RF input terminal, the DC voltage component and the maximum continuous power of the AC (RF) signal component can not exceed 50 V and 20 dBm respectively.

To Use the Numeric Keyboard

DSA800 provides a numeric keyboard at the front panel (as shown in the figure below). The numeric keyboard which supports the Chinese characters, English uppercase/lowercase characters, numbers and common symbols (including decimal point, #, space and +/-) are mainly used to edit file or folder name (refer to "To Input Filename") and set parameters (refer to "Parameter Setting").

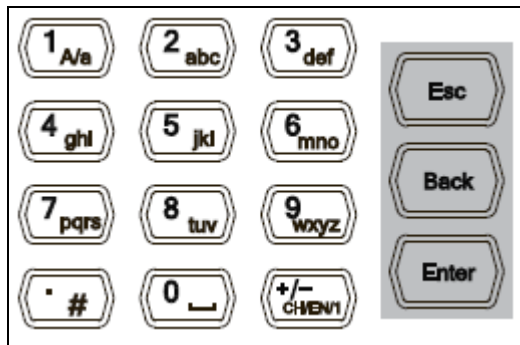





Figure 1-8 Numeric Keyboard

The numeric keyboard consists of the following parts:

1. 
 - The input mode is fixed at number input during parameter setting. During parameter setting, press this key to input the symbol ("+" or "-") of the figure. When the key is pressed for the first time, the parameter symbol is "-" and "+" when the key is pressed again.
 - Press  to switch among Chinese, English and number input during file or folder name editing.
2. **Number/Letter**
 - Multiplexing keys for numbers and letters. They are used to directly input the desired number or letter.
 -  is used to switch between upper and lower cases in English input.
 -  is the multiplexing key for 0 and space. Press this key to input 0 in

number input and space in Chinese or English input.

3. 

- Press this key to input a decimal point at the current cursor position in number input.
- Press this key to input “#” in English input.
- This key is invalid in Chinese input.

4. **Enter**

- When pressed during parameter editing process, the system will complete the input and insert a default unit for the parameter automatically.
- While in the process of file name editing, this key is used to input the character currently selected by the cursor.

5. **Esc**

- During parameter editing process, press this key to clear the inputs in the active function area and exit parameter input.
- While in the process of file name editing, press this key to delete characters that have been entered.
- Press this key to turn off the display of the active function area when the main measurement screen is displayed.
- Press this key to exit the current test mode in keyboard test.
- Press this key to unlock the screen when it is locked.

6. **Back**

- During the process of parameter editing, press this key to delete the character on the left of the cursor.
- While in the process of file name editing, press this key to delete the character on the left of the cursor.

Rear Panel

The rear panel of DSA800 is as shown in the figure below.



Figure 1-9 Rear Panel

1. AC Power Connector

Available AC power supply types: 100 V - 240 V, 45 Hz - 440 Hz.

2. Fuse Seat Lid

Open the fuse lid and replace the fuse. DSA800 supports 250V AC, T2A fuse.

3. Security Lock Hole

If needed, you can use a security lock (buy it yourself) to lock the analyzer to a desired location.

4. USB Device Interface

The analyzer can serve as a “slave” device to connect external USB devices. Through this interface, PictBridge printer can be connected to print screen image or PC can be connected to control DSA800 remotely through programming or PC software.

5. LAN Interface

Through this interface, the analyzer can be connected to your local network

for remote control. An integrated testing system can be built quickly, as the analyzer conforms to LXI-C class instrument standards.

6. TRIGGER IN

In external trigger mode, the connector receives an external trigger signal through BNC cable.

7. 10MHz OUT

DSA800 can use internal or external reference source.

- When internal reference source is used, the **[10MHz OUT]** connector can output a 10 MHz clock signal generated by the analyzer. This signal can be used to synchronize other instruments.
- **[10MHz OUT]** and **[10MHz IN]** connectors are usually used to build synchronization among multiple instruments.

8. 10MHz IN

DSA800 can use internal or external reference source.

- When a 10 MHz external clock signal is received through the **[10MHz IN]** connector, this signal is used as the external reference source and "Ext Ref" is displayed in the status bar of the user interface. When the external reference is lost, transfinite or not connected, the instrument switches to its internal reference source automatically and "Ext Ref" on the screen disappears.
- **[10MHz IN]** and **[10MHz OUT]** connectors are usually used to build synchronization among multiple instruments.

9. Handle

Users can adjust the handle to the vertical position for easier carrying of the analyzer.

User Interface

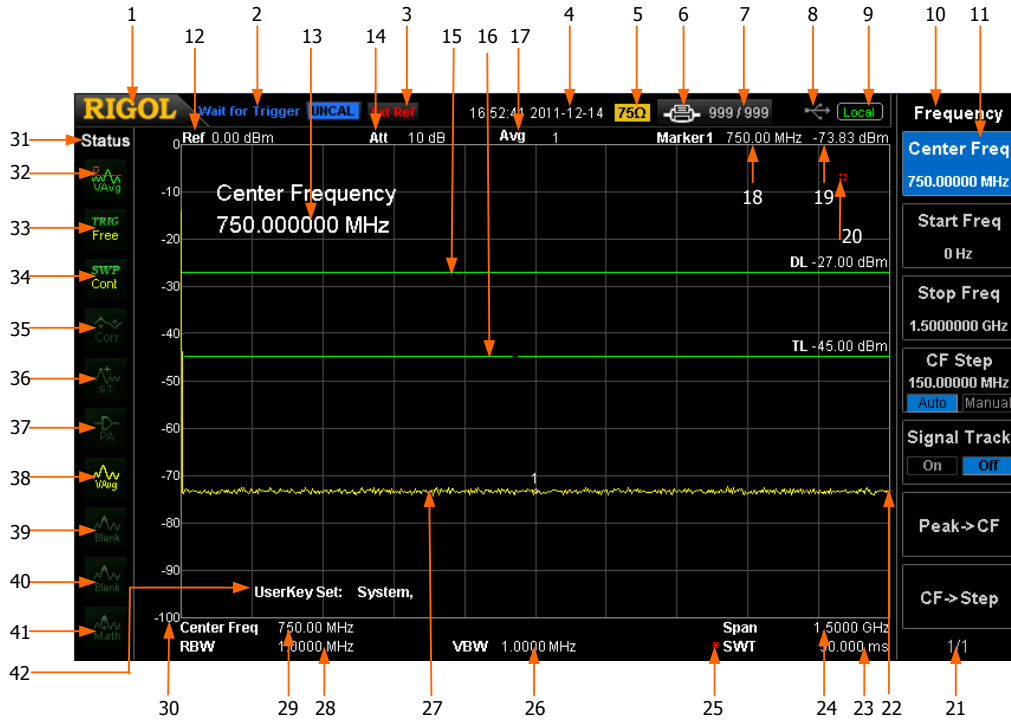







Figure 1-10 User Interface

Table 1-3 User interface labels

NO.	Name	Description
1	RIGOL	Logo of RIGOL
2	System status ("UNCAL" and "Identification..." are displayed in different place as others; refer to the figure above)	Auto Tune Auto Range Wait for Trigger Calibrating UNCAL (Measurement Uncalibrated) Identification... (LXI Identification)
3	External reference	Ext Ref
4	Time	System time
5	Input impedance	Show "75Ω" if the current input impedance is 75Ω.
6	Printer status	: displayed alternatively, denote the printer

		<p>connection is in process.</p> <p>: denote the connection succeeds, the print finishes or the printer is idle.</p> <p> : displayed alternatively, denote the print is in process.</p> <p>: denote the print has been paused.</p>
7	Print process	Show the current print copy and total print copies.
8	USB storage device status	 is displayed when USB storage device is installed.
9	Operation status	Display "Local" (in local mode) or "Rmt" (in remote mode).
10	Menu title	Function of the current menu.
11	Menu items	Menu items of the current function.
12	Reference level	Reference level.
13	Active function area	Current parameter and its value.
14	Attenuator settings	Attenuator settings.
15	Display line	Reading the reference and the threshold condition for peak value display.
16	Trigger level	Set the trigger level in video trigger.
17	Average times	Average times of trace.
18	Cursor X	Current X value of the cursor. Note that X indicates different physical quantities in different functions.
19	Cursor Y	Current Y value of the cursor. Note that Y indicates different physical quantities in different functions.
20	Invalid data	Current measured data is invalid as a full sweep doesn't complete after the system parameters have been modified.
21	Menu page number	Show the total number of pages and current page number.
22	Sweep position	Current sweep position.
23	Sweep time	Sweep time.
24	Span or stop frequency	The frequency range of the current sweep channel can be expressed by a combination of center frequency and span or a combination of start frequency and stop frequency.
25	Manual setting	The corresponding parameter is in manual setting

	symbol	mode.
26	VBW	Video bandwidth.
27	Spectrum line display area	Display the spectrum line.
28	RBW	Resolution bandwidth.
29	Center or start frequency	The frequency range of the current sweep channel can be expressed by a combination of center frequency and span or a combination of start frequency and stop frequency.
30	Y scale	Label of Y scale.
31	Parameter status	Icons on the left side of the screen indicate the status of system parameters.
32	Detector type	Pos peak, Neg peak, Sample, Normal, RMS Avg, Voltage Avg and Quasi-Peak.
33	Trigger type	Free, video and external.
34	Sweep mode	Continuous or Single sweep (with current number of sweeps)
35	Correction switch	Turn amplitude correction on or off.
36	Signal tracking	Enable or disable the signal tracking function.
37	Preamplifier status*	Enable or disable the preamplifier.
38	Trace 1 type and status	Trace types: Clear Write, Freeze, Max Hold, Min Hold, Video Avg and Power Avg. Trace status: yellow denotes On and gray denotes Off.
39	Trace 2 type and status	Trace types: Clear Write, Freeze, Max Hold, Min Hold, Video Avg and Power Avg. Trace status: purple denotes On and gray denotes Off.
40	Trace 3 type and status	Trace types: Clear Write, Freeze, Max Hold, Min Hold, Video Avg and Power Avg. Trace status: light blue denotes On and gray denotes Off.
41	MATH trace type and status	Trace types: A-B, A+C, A-C. Trace status: green denotes On and gray denotes Off.
42	UserKey definition	Display the definition of UserKey .

Menu Operation

There are 7 types of menus according to their operation modes. Each type of menu and its operation method are introduced below.

1. Parameter Input

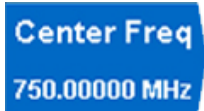

When selected, use the numeric keys to modify the parameters directly.

For example, select **Center Freq**, input the desired figure and press **Enter** to change the center frequency.

2. State Switching

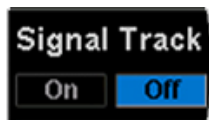

Press the corresponding menu key to switch between the sub-options.

For example, press **Signal Track** to enable or disable the signal tracking function.

3. Enter Lower Menu (with parameter)



Press the corresponding menu key to enter the lower menu and change the option currently selected.

For example, press **Units** to enter the lower menu. Select **dBm** and return to the previous menu. The unit of Y-axis changes to dBm.

4. Enter Lower Menu (without parameter)



Press the corresponding menu key to enter the lower menu.

For example, press **Corrections** to enter directly.

5. Direct Execution



Press the key to execute the corresponding function. For example, press **Peak->CF** to execute a peak search and set the center frequency of the analyzer to the frequency of the current peak signal.

6. Function Switch + Parameter Input



Press the corresponding menu key to switch between functions; change the parameter directly using the numeric keys.

For example, press **CF Step** to switch between **Auto** and **Manual**; if **Manual** is selected, you can directly input the desired number to change the CF Step.

7. State Selection



Press the corresponding menu key to modify the parameter and return to the menu one level up. For example, press **Trig Type → Free Run** to select free trigger and the analyzer is in Free Run state at present.

Parameter Setting

Users can enter the desired parameter values using the numeric keys, knob, or direction keys. This section describes the three methods of parameter setting through an example (to set the center frequency to 800 MHz).

1. Use the numeric keyboard

- 1) Press **FREQ** → **Center Freq**;
- 2) Input **800** using the numeric keys;
- 3) Select **MHz** by pressing **Enter** or select the desired unit from the popup menu.

2. Use the knob

When the parameter is editable (namely when the parameter is selected), turn the knob clockwise to increase or counterclockwise to decrease the parameter value at specified step.

- 1) Press **FREQ** → **Center Freq**;
- 2) Rotate the knob until the parameter is set to a certain value (800 MHz).

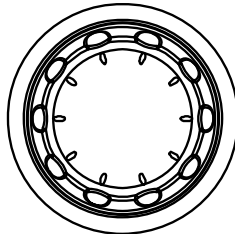

Figure 1-11 The Knob

Note: in the storage function, the knob can also be used to select the current path or file.

3. Use the direction keys

When the parameter is editable (namely when the parameter is selected), you can increase or decrease the parameter value at specific step using the direction keys.

- 1) Press **FREQ** → **Center Freq**;
- 2) Press up/down direction key until the parameter is set to a certain value (800 MHz).

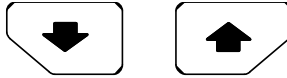

Figure 1-12 Direction Keys

Note: in the storage function, the direction keys can also be used to select the current path or file.

To Input Filename

DSA800 supports filenames consisting of Chinese characters, English letters, number and #.

1. Enter the filename input interface

Press **Storage** and select the desired file type and storage location. Then press **Save** to enter the filename input interface. You can press **+/-** **CH/EN/1** to switch among English, Chinese and number input modes.

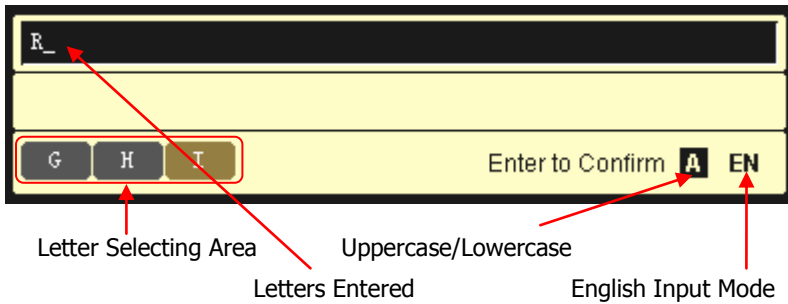

(a) English Input Mode

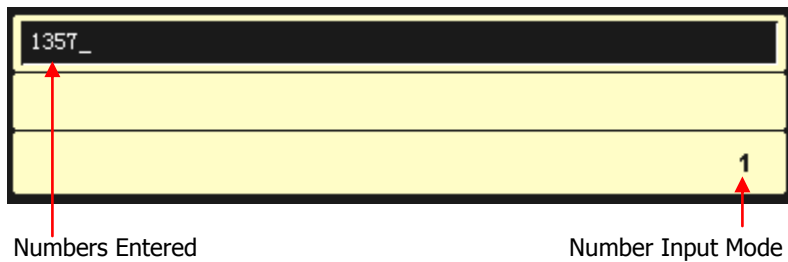

(b) Number Input Mode

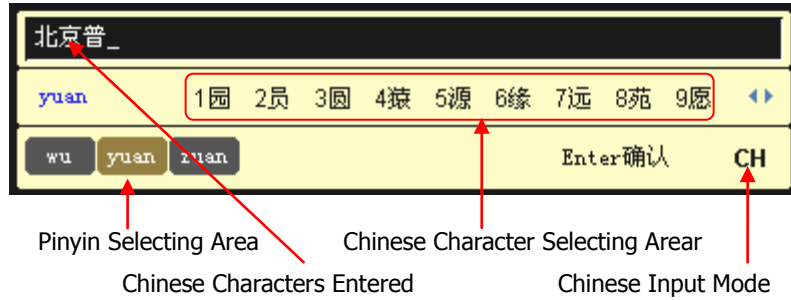



(c) Chinese Input Mode

Figure 1-13 Filename Input Interface

Tip

If USB storage device is currently connected, the instrument will also enter the filename input interface when  is pressed.

2. Input English Filename

- 1) Press  to switch to English input mode. You can also press  to switch between upper and lower cases. At this point, the corresponding label is displayed at the lower right corner of the filename input interface.
- 2) Press the key of the desired letter. At this point, the letters available are displayed in the **letter selecting area**. Press this key repeatedly until the desired letter is selected (the background color of the letter becomes brown). Then press  to input the desired letter.
- 3) Use the above method to input the other letters.

3. Input Chinese Filename

- 1) Press  to switch to Chinese input mode (T9 input method). At this point, the corresponding label is displayed at the lower right corner of the filename input interface.
- 2) Press the key of the first letter of the pinyin of the Chinese character. At this point, the pinyins available are displayed in the **pinyin selecting area** and the corresponding Chinese characters of the pinyin currently selected are displayed in the **Chinese character selecting area**. If the desired pinyin is displayed, refer to 3). Otherwise, please continue to

- input the other letters in the pinyin and then refer to 3).
- 3) Rotate the knob until the background color of the desired pinyin becomes brown. Then, press **Enter** to select the pinyin. At this point, the corresponding Chinese characters with numbers are displayed in the **Chinese character selecting area**. Use the numeric keys to select the desired Chinese character. You can also use the the direction keys to open the previous or next page in the **Chinese character selecting area**.
 - 4) Use the same method to input the other Chinese characters.

Tip

If you need to use numbers as the filename (or part of the filename), press  to switch to number input mode and use the numeric keys to input the desired number.

To Use the Built-in Help

The built-in help system provides information about every function key at the front panel and every menu softkey.

1. How to acquire built-in help

Press **Help** and a prompt about how to obtain help information will be shown at the center of the screen. Then, press the key that you want to get help of and the relevant help information will be shown at the center of the screen.

2. Page up and down

If there is more than one page of information, you can read the help information on the previous or next page using the direction keys or the knob.

3. Close the current help information

Press any key at the front panel (except the direction keys and the knob) to close the help information currently displayed at the center of the screen.

4. Acquire the menu help

Press **Help** and the help information display window is displayed at the center of the screen. Then, press the menu key and the help information of the corresponding menu item is displayed.

5. Acquire the help information of any function key

Press **Help** and the help information display window is displayed at the center of the screen. Then, press any function key and the corresponding function help information is displayed.

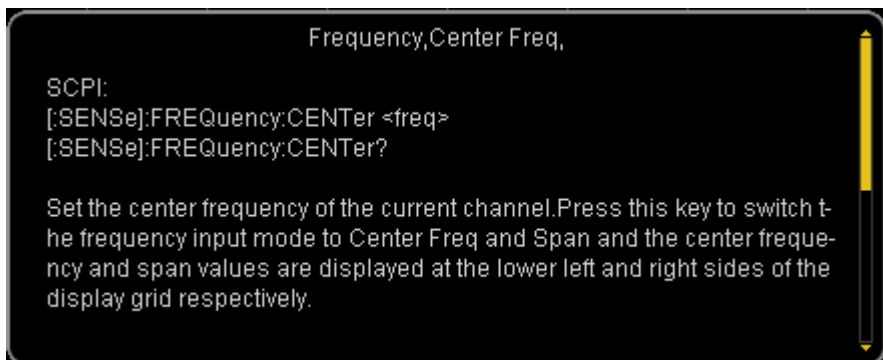

Figure 1-14 The Built-in Help Interface

To Use the Security Lock

If necessary, use a security lock to lock the analyzer in a desired location. As shown in the figure below, align the lock with the lock hole and plug it into the lock hole vertically, turn the key clockwise to lock the instrument and then pull the key out.

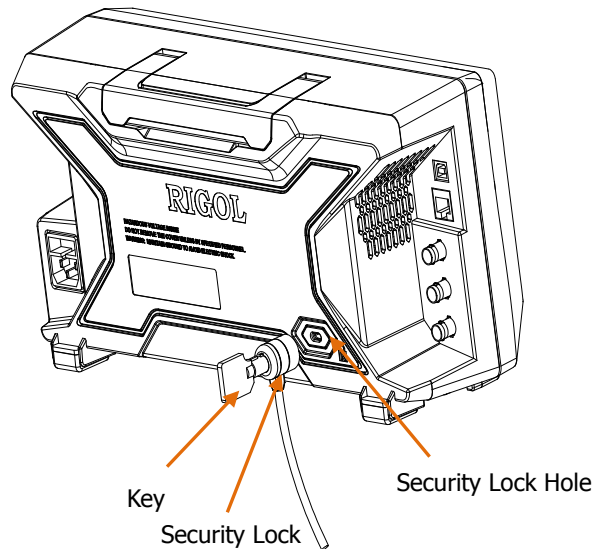

Figure 1-15 To Use the Security Lock

Note: Please do not insert other articles into the security lock hole to avoid damaging the instrument.

To Replace the Fuse

Please replace the burned fuse with specified fuse according to the following steps when needed:

1. Open the fuse lid above the power connector.
2. Dismount the fuse holder.
3. Replace with a new fuse.
4. Remount the fuse holder and close the lid.

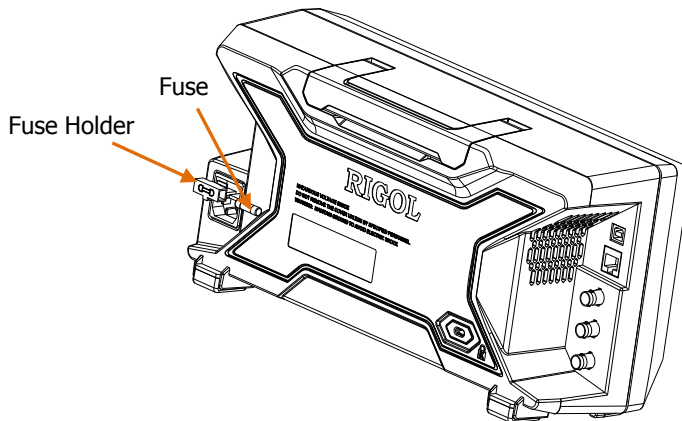

Figure 1-16 To Change the Fuse



WARNING

Please ensure that the instrument has been turned off and the power source has been cut off before replacing the fuse in order to avoid electric shock.

Chapter 2 Front Panel Operation

This chapter describes in detail the function keys at the front panel and the associated functions.

Subjects in this chapter:

- Basic Settings
- Sweep and Function Settings
- Measurement Settings
- Marker Measurements
- Shortcut Key
- System Settings

Basic Settings

FREQ

Set the frequency parameters of the analyzer. The analyzer sweeps within a specified frequency range, and the sweep is restarted every time you change the frequency parameters.

The frequency range of a channel can be expressed by either of two groups of parameters: Start Frequency and Stop Frequency (f_{start}/f_{stop}) ; or Center Frequency and Span (f_{center}/f_{span}) . If any of the parameters is changed, the others would be adjusted automatically in order to ensure the coupling relationship among them:

$$f_{center} = (f_{stop} + f_{start})/2 \quad (2-1)$$

$$f_{span} = f_{stop} - f_{start} \quad (2-2)$$

Center Freq

Set the center frequency of the current channel. Press this key to switch to center frequency/span input mode and the center frequency and span values are displayed at the lower left and right sides of the grid respectively.

Key Points:

- The start and stop frequencies vary with the center frequency when the span is constant.
- Changing the center frequency horizontally shifts the current channel and the adjustment is limited by the specified frequency range.
- In Zero Span mode, the start frequency, stop frequency and center frequency are always the same.
- You can modify this parameter using the numeric keys, knob or direction keys. Refer to "**Parameter Setting**" for more details.

Table 2-1 Center Frequency

Parameter	Explanation
Default	750 MHz
Range*	0 Hz to 1.5 GHz
Unit	GHz, MHz, kHz, Hz
Knob Step	Span > 0, step = Span/200 Span = 0, step = RBW/100 Min = 1 Hz
Direction Key Step	CF step

*Note: The range is from 50 Hz to (1.5 GHz-50 Hz) in non-zero span.

Start Freq

Set the start frequency of the current channel. Press this key to switch to start/stop frequency input mode and the start and stop frequencies are displayed at the lower left and right sides of the grid respectively.

Key Points:

- The span and center frequency vary with the start frequency. The change of

span would affect other system parameters. For more details, please refer to **"Span"**.

- In Zero Span mode, the start frequency, stop frequency and center frequency are always the same. If one is changed, the others are updated to match.
- You can modify this parameter using the numeric keys, knob or direction keys. Refer to **"Parameter Setting"** for more details.

Table 2-2 Start Frequency

Parameter	Explanation
Default	0 GHz
Range*	0 Hz to 1.5 GHz
Unit	GHz, MHz, kHz, Hz
Knob Step	Span > 0, step = Span/200 Span = 0, step = RBW/100 Min = 1 Hz
Direction Key Step	CF step

*Note: The range is from 0 Hz to (1.5 GHz-100 Hz) in non-zero span.

Stop Freq

Set the stop frequency of the current channel. Press this key to switch to start/stop frequency input mode and the start and stop frequencies are displayed at the lower left and right sides of the grid respectively.

Key Points:

- The span and center frequency vary with the stop frequency. The change of span would affect other system parameters. For more details, please refer to **"Span"**.
- You can modify this parameter using the numeric keys, knob or direction keys. For more details, please refer to **"Parameter Setting"**.

Table 2-3 Stop frequency

Parameter	Explanation
Default	1.5 GHz
Range*	0 Hz to 1.5 GHz
Unit	GHz, MHz, kHz, Hz
Knob Step	Span > 0, step = Span/200 Span = 0, step = VBW/100 Min = 1 Hz
Direction Key Step	CF step

*Note: The range is from 100 Hz to 1.5 GHz in non-zero span.

CF Step

Set the step of center frequency. Changing the center frequency in a fixed step continuously switches the channel to be measured.

Key Points:

- The CF step can be set in "Manual" or "Auto" mode. In Auto mode, the CF step is 1/10 of the span in Non-zero span mode or equals the RBW while in Zero span mode; in Manual mode, you can set the step using the numeric keys.
- After you set an appropriate CF step and select **Center Freq**, use up and down direction keys to switch between measurement channels in a specified step in order to sweep the adjacent channel manually.
- You can modify this parameter using the numeric keys, knob or direction keys. For more details, please refer to "**Parameter Setting**".

Table 2-4 CF step

Parameter	Explanation
Default	150 MHz
Range	1 Hz to 1.5 GHz
Unit	GHz, MHz, kHz, Hz
Knob Step	Span > 0, step = Span/200 Span = 0, step = 100 Hz Min = 1 Hz
Direction Key Step	in 1, 2, 5 sequence

Signal Track

Turn on or off signal track. This function is used to track and measure signal with unstable frequency and less than 3 dB transient variation in amplitude by placing Marker1 (see "**Marker Measurements**") onto the signal under measurement to track and measure the variation of the signal continuously.

The signal track process is as shown in the figure below:

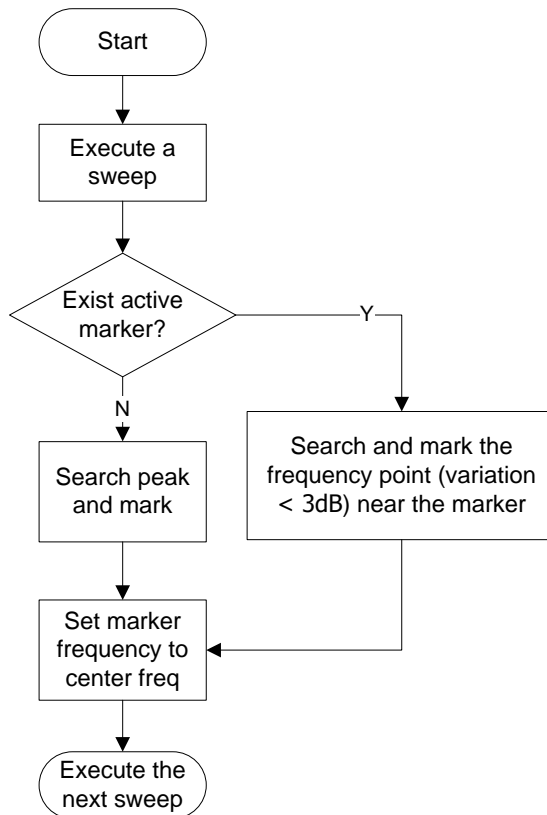



Figure 2-1 Process of Signal Track

Key Points:

- When Signal Track is On, the ST (Signal Track) icon  is shown in the status bar at the left of the screen.
- If an active marker currently exists, when Signal Track is enabled, the instrument will search and mark the point (with no more than 3 dB variation in amplitude) near the marker as well as set the frequency of this point as the

- center frequency to hold the signal at the center of the screen.
- If no marker is currently active, when Signal Track is enabled, the instrument will activate Marker 1, execute a peak search automatically and set the frequency of the current peak as the center frequency to hold the signal at the center of the screen.
- In continuous sweep, the system tracks the signal continuously; in single sweep, only one track is done; in Zero Span, Signal Track is invalid.

Peak -> CF

Execute a peak search and use the frequency of current peak as the center frequency (CF) of the analyzer. The function is invalid in Zero Span mode.

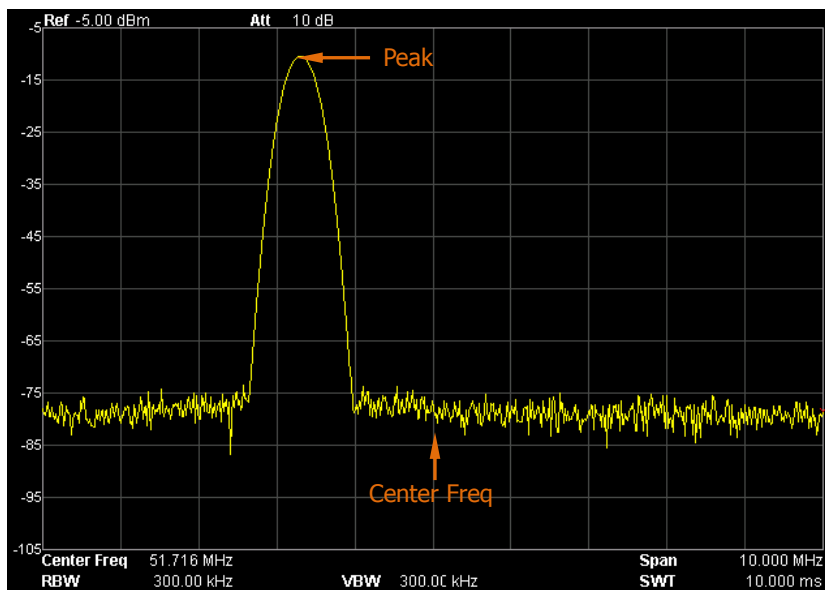

Figure 2-2 Before Peak->CF

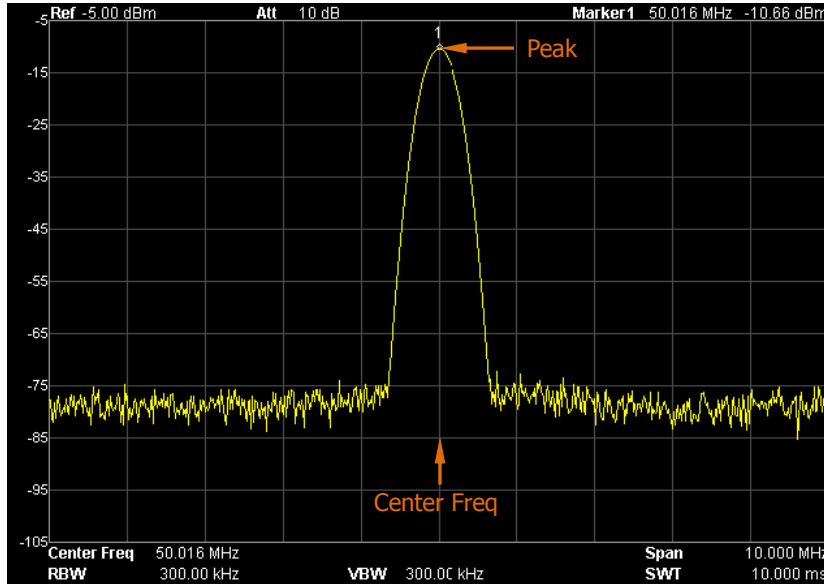

Figure 2-3 After Peak->CF

CF -> Step

Set the current center frequency as the CF step. At this point, the CF step will switch to "Manual" mode automatically. This function is usually used with channel switching. Take harmonic waveform measurement for example: locate a signal at the center frequency of a channel, execute **CF-> Step** and then continuously press the down direction key to measure each order of harmonic in sequence.

SPAN

Set the span of the analyzer. The change of this parameter will affect the frequency parameters and restart the sweep.

Span

Set the frequency range of the current channel. Press this key to switch to center frequency/span input mode and the center frequency and span are displayed at the lower left and right sides of the grid respectively.

Key Points:

- The start and stop frequencies vary with the span automatically.
- In manual span mode, the span can be set down to 100 Hz (the only way into the zero-span mode is pressing the **Zero Span** menu option) and up to the full span described in "**Specifications**". When the span is set to the maximum, the analyzer enters full span mode.
- Modifying the span in non-zero span mode may cause an automatic change in both CF step and RBW if they are in Auto mode, and the change of RBW may influence VBW (in Auto VBW mode).
- Variation in the span, RBW or VBW would cause a change in the sweep time.
- In non-zero span mode, neither "Video" trigger nor "1/ Δ time" readout function is valid.
- You can modify this parameter using the numeric keys, knob, or direction keys. For more details, please refer to "**Parameter Setting**".

Table 2-5 Span

Parameter	Explanation
Default	1.5 GHz
Range*	0 Hz to 1.5 GHz
Unit	GHz, MHz, kHz, Hz
Knob Step	Span/200, Min = 1 Hz
Direction Key Step	in 1, 2, 5 sequence

*Note: 0 Hz is available only in zero span.

Full Span

Set the span of the analyzer to the maximum.

Zero Span

Set the span of the analyzer to 0 Hz. Both the start and stop frequencies will equal the center frequency and the horizontal axis will denote time. The analyzer measures the time domain characteristics of the amplitude of the corresponding frequency point on the input signal.

Key Points:

As opposed to the Non-zero span, the screen shows the time domain characteristics of the fixed frequency component in zero span mode. The following functions are invalid in Zero span mode:

- **FREQ**: Peak->CF and Signal Track;
- **SPAN**: Zoom In and Zoom Out;
- **Marker->**: Mkr->CF, Mkr->Step, Mkr->Start, Mkr->Stop, Mkr Δ ->CF and Mkr Δ ->Span;
- **Marker** \rightarrow **Readout**: Frequency, Period and $1/\Delta$ Time (valid in Delta marker type);
- **TG**: Power Sweep.

Zoom In

Set the span to half of its current value. At this point, the signal on the screen is zoomed in on to observe signal details.

Zoom Out

Set the span to twice the current value. At this point, the signal on the screen is zoomed out on to gain more information about the signal.

Last Span

Set the span to the previous span setting.

AMPT

Set the amplitude parameters of the analyzer. Through modifying these parameters, signals under measurement can be displayed in a proper mode for easier observation and minimum error.

Auto Scale

This function enables the readout resolution of the Y-axis to be the maximum possible while at the same time ensures the completeness of the signal. When enabled, the system sets the reference level automatically in order to place the peak of the signal within the topmost grip for easier observation of the trace.

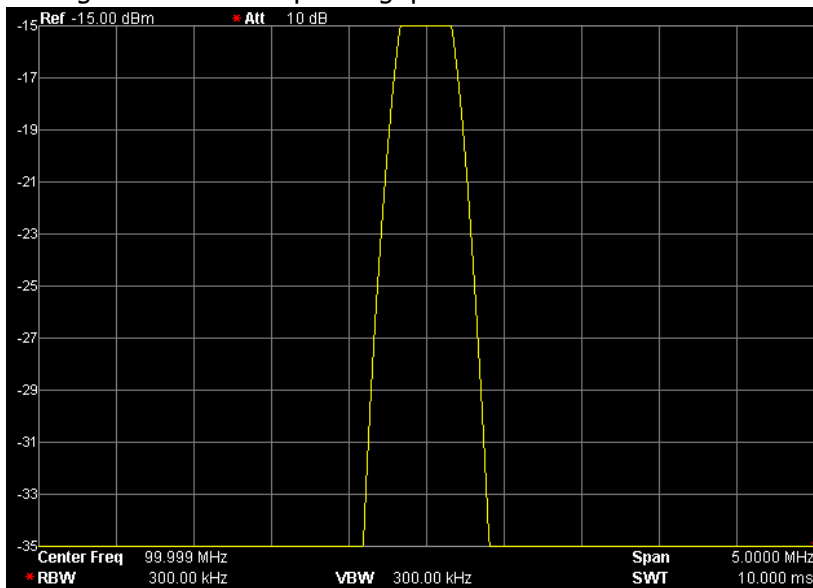

Figure 2-4 Before Auto Scale

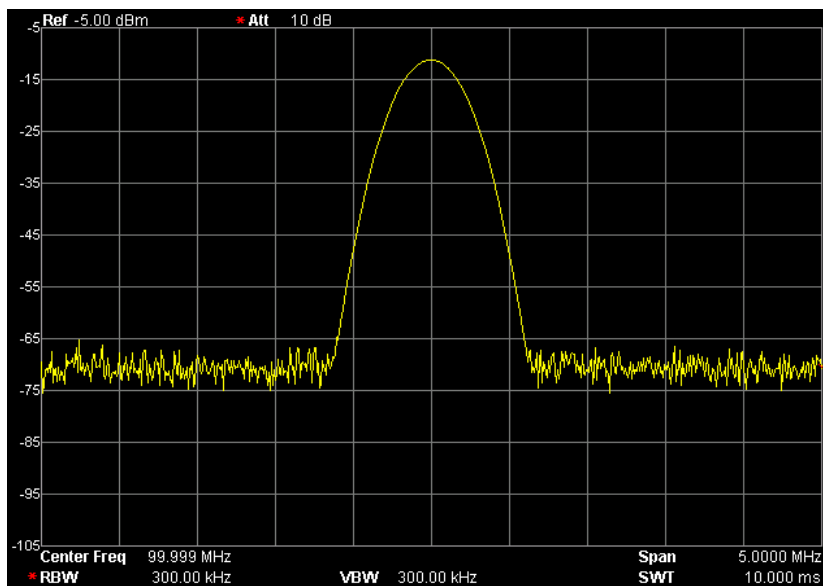

Figure 2-5 After Auto Scale

Ref Level

Set the maximum power or voltage can be currently displayed in the window and the value is displayed at the upper left corner of the screen grid.

Key Points:

- The maximum reference level available is affected by the maximum mixing level, input attenuation and preamplifier. When you adjust it, the input attenuation is adjusted under a constant maximum mixing level in order to fulfill the following inequality:

$$L_{Ref} - a_{RF} + a_{PA} \leq L_{mix} \quad (2-3)$$

L_{Ref} , a_{RF} , a_{PA} and L_{mix} denote the reference level, the input attenuation, the preamplifier and the maximum mixing level respectively.

- You can modify this parameter using the numeric keys, knob or direction keys. For more details, please refer to "**Parameter Setting**".

Table 2-6 Reference level

Parameter	Explanation
Default	0 dBm
Range	-100 dBm to 20 dBm
Unit	dBm, -dBm, mV, uV
Knob Step	in Log scale mode, step = Scale/10 in Lin scale mode, step = 0.1 dBm
Direction Key Step	in Log scale mode, step = Scale in Lin scale mode, step = 1 dBm

Input Atten

Set the front attenuator of the RF input in order to ensure big signals (or small signals) to pass from the mixer with low distortion (or low noise).

Key Points:

- When the preamplifier is On, the input attenuation could be set up to 30 dB. You can adjust the reference level to ensure that the specified parameter meets the inequality (2-3).
- You can modify this parameter using the numeric keys, knob or direction keys. For more details, please refer to "**Parameter Setting**".

Table 2-7 Input attenuation

Parameter	Explanation
Default	10 dB
Range	0 dB to 30 dB
Unit	dB
Knob Step	1 dB
Direction Key Step	5 dB

Scale/Div

Set the logarithmic units per vertical grid division on the display. This function is only available when the scale type is set to "Log".

Key Points:

- By changing the scale, the amplitude range available is adjusted.
- The range of the amplitude that can be displayed:
Minimum: reference level – 10 × the current scale value
Maximum: the reference level.
- You can modify this parameter using the numeric keys, knob or direction keys.
For more details, please refer to "**Parameter Setting**".

Table 2-8 Scale

Parameter	Explanation
Default	10 dB
Range	0.1 dB to 20 dB
Unit	dB
Knob Step	Scale \geq 1, step = 1 dB Scale < 1, step = 0.1 dB
Direction Key Step	in 1, 2, 5 sequence

Scale Type

Set the scale type of Y-axis to Lin or Log, the default is Log.

Key Points:

- In Log scale type: the Y-axis denotes the logarithmic coordinate, the value shown at the top of the grid is the reference level and each grid represents the scale value. The unit of Y-axis will automatically switch to the default "dBm" in Log scale type when the scale type is changed from Lin to Log.
- In Lin scale type: the Y-axis denotes the linear coordinate, the values shown at the top of the grid and the bottom of the grid are the reference level and 0 V respectively. Each grid represents 10% of the reference level and the Scale/Div is invalid. The unit of Y-axis will automatically switch to the default

“Volts” in Lin scale type when the scale type is changed from Log to Lin.

- The scale type does not affect the unit of Y-axis.

Units

Set the unit of the Y-axis to dBm, dBmV, dBuV, Volts or Watts. Wherein, dBm, dBmV, and dBuV are for Log scale; Volts and Watts are for Linear scale. The default is dBm.

Key Points:

The conversion relationships between units:

$$dBm = 10\log\left(\frac{Volts^2}{R} \times \frac{1}{0.001W}\right) \quad (2-4)$$

$$dB\mu V = 20\log\left(\frac{Volts \times 10^6}{1\mu V}\right) \quad (2-5)$$

$$dBmV = 20\log\left(\frac{Volts \times 10^3}{1mV}\right) \quad (2-6)$$

$$Watts = \frac{Volts^2}{R} \quad (2-7)$$

Wherein, R denotes the reference resistance.

Ref Offset

Assign an offset to the reference level to compensate for gains or losses generated between the device under measurement and the analyzer.

Key Points:

- The change of this value changes both the reference level readout and the amplitude readout of the marker, but does not impact the position of the curve

on the screen.

- You can modify this parameter using the numeric keys. For more details, please refer to “**Parameter Setting**”.

Table 2-9 Reference level offset

Parameter	Explanation
Default	0 dB
Range	-300 dB to 300 dB
Unit	dB
Knob Step	N/A
Direction Key Step	N/A

Auto Range

Adjust the amplitude parameters within the current span range automatically in order to display the whole signal optimally on the screen.

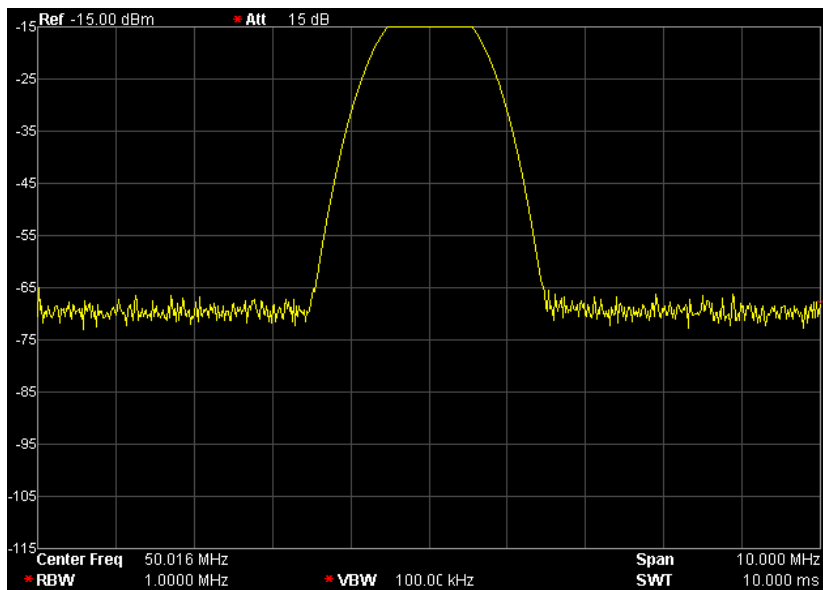

Figure 2-6 Before Auto Range

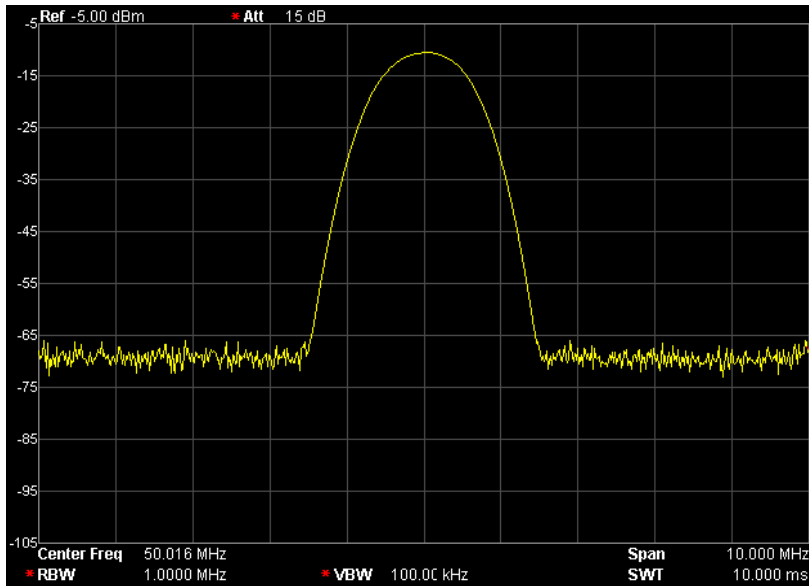

Figure 2-7 After Auto Range

Key Points:

- Unlike Auto Scale, this function can solve the problem of signal overrange due to parameter settings and adjust the maximum mixing level according to the signal under measurement.
- Unlike Auto, this function adjusts the signal within the current channel and does not modify the channel frequency setting. While, Auto will search for signal within the full frequency range and locate the signal at the center frequency.

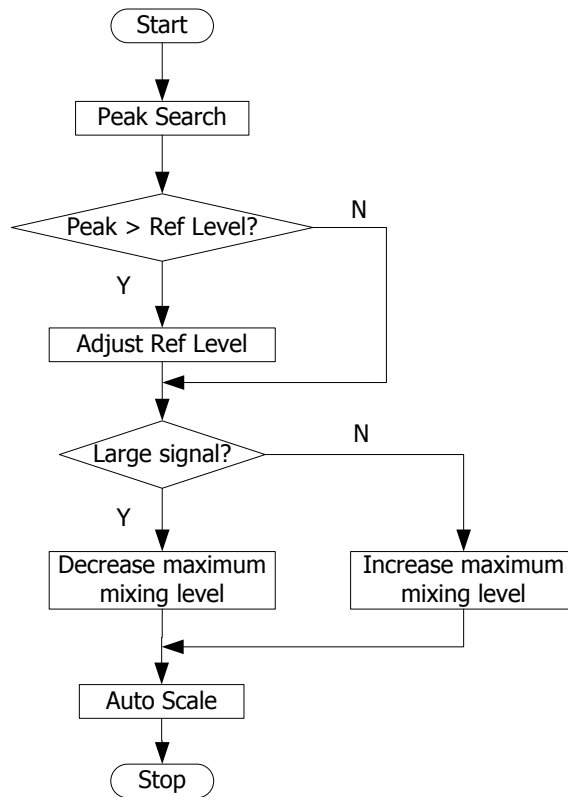



Figure 2-8 Process of Auto Range

RF Preamp

Set the status of the preamplifier located at the front of the RF signal path. Turning on the preamplifier reduces the displayed average noise level in order to distinguish small signals from the noise when the signal under measurement is small.

Key Points:

The corresponding icon  will be displayed in the status bar at the left side of the screen when the preamplifier is On.

Correction

Correct the amplitude in order to compensate for the gain or loss from external devices such as Antenna and Cable. When using this function, you can view the correction data table and save or load the current correction data. When Correction is On, both the trace and related measurement results will be corrected, and the corresponding icon  is shown in the status bar at the left of the screen.

1. Select

Select a correction factor from Antenna, Cable, Other and User for the current correction and the default is Off. After choosing correction factors, press **Correction** to enable the chosen correction factors. Multiple correction factors can be enabled at the same time.

2. Correction

Enable or disable amplitude correction and the default is Off.

When Correction is enabled, the data of the correction factor currently selected is used for amplitude correction. If multiple factors are enabled, all related data will be used for amplitude correction.

3. Edit

Edit the frequency of the correction factor and the correction data of the corresponding amplitude. You can modify this parameter using the numeric keys, knob or direction keys. For details, refer to the table on the next page.

Note: the edited correction data can be stored in internal or external memory and can be recalled when needed. When correction data editing is finished, press **Storage** to save the correction data using the method introduced in "Storage". The edit point can only increase continuously, namely the point can only increase to 2 after "point 1" is edited.

Table 2-10 Edit menus of Amplitude correction

Menu	Explanation
Point	Create or edit the data point of a correction factor. Range: 1 to 200
Frequency	Set the frequency of the specified point in the correction factor.
Amplitude	Set the amplitude correction of the specified point in the correction factor. Range: -120 dB to 100 dB
Del Point	Delete the specified point data in the correction factor: frequency and amplitude correction.

4. Freq Interp

Set the interpolation type of the points between two points in the correction table during amplitude correction.

- In Lin mode, the frequency and amplitude separately use a Lin and Log unit to perform interpolation.
- In Log mode, both of the parameters use a Log unit.

5. Delete

Clear the frequency and amplitude correction data of the selected correction factor.

6. Corr Table

Turn on the correction table to view the correction data edited. At this moment, the screen is divided into two parts with the upper showing the measurement curve and the lower showing the points edited, frequency, and amplitude.

7. Corr View

- All: view the data of all the correction factors.
- Sel: view the data of the selected correction factor.

MaxMixL

Set the max input level of the mixer according to the magnitude of the signal.

Key Points:

- For a larger input signal, select a smaller maximum mixing level to increase the input attenuation and reduce the distortion of the signal; for a smaller input signal, select a larger maximum mixing level to reduce the input attenuation and noise.
- Parameters in inequality (2-3) are always modified on the basis of the maximum mixing level.
- You can modify this parameter using the numeric keys, knob or direction keys. For more details, please refer to "**Parameter Setting**".

Table 2-11 Maximum mixing level

Parameter	Explanation
Default	-10 dBm
Range	-30 dBm to 0 dBm
Unit	dBm, -dBm, mV, uV
Knob Step	1 dBm
Direction Key Step	10 dBm

Input Impedance

Set the input impedance for voltage-to-power conversions (refer to equation (2-4)). The default is 50 Ω . To measure a 75 Ω device, you should use a 75 Ω to 50 Ω adapter supplied by **RIGOL** to connect the analyzer with the system under test and then set the input impedance to 75 Ω .

Note: "75 Ω " will be shown in the status bar on the screen in this situation.

Sweep and Function Settings

BW/Det

Set the RBW (Resolution Bandwidth), VBW (Video Bandwidth) and detector type parameters of the analyzer.

RBW

Set the desired resolution bandwidth in order to distinguish between signals which are close in frequency.

Key Points:

- Reducing RBW will increase the frequency resolution, but will increase the sweep time (Sweep Time is affected by a combination of RBW and VBW when it is in Auto mode).
- RBW decreases with the span (non-zero span) in Auto RBW mode.
- You can modify this parameter using the numeric keys, knob or direction keys. For more details, please refer to "**Parameter Setting**".

Note: if detector type is "Quasi-Peak" or filter type is "EMI", RBW can be 200 Hz, 9 kHz or 120 kHz only.

Table 2-12 RBW (Filter Type is Gauss)

Parameter	Explanation
Default	1 MHz
Range	100 Hz to 1 MHz
Unit	GHz, MHz, kHz, Hz
Knob Step	in 1, 3, 10 sequence
Direction Key Step	in 1, 3, 10 sequence

VBW

Set the desired video bandwidth in order to filter out the noise outside the video band.

Key Points:

- Reducing the VBW will smooth the spectrum line to differentiate small signals from noise, but will increase the sweep time (Sweep Time is affected by a combination of RBW and VBW when it is in Auto mode).
- VBW varies with RBW when it is set to Auto. While in Manual mode, VBW is not affected by RBW.
- You can modify this parameter using the numeric keys, knob or direction keys. For more details, please refer to "**Parameter Setting**".

Table 2-13 VBW

Parameter	Explanation
Default	1 MHz
Range	1 Hz to 3 MHz
Unit	GHz, MHz, kHz, Hz
Knob Step	in 1, 3, 10 sequence
Direction Key Step	in 1, 3, 10 sequence

V/R Ratio

Set the ratio of VBW to RBW.

Key Points:

- This value is different while measuring different kinds of signals:
Sine signal: use 1 to 3 (for faster sweeps)
Pulse signal: use 10 (to reduce the influence on the amplitude of transient signals)
Noise signal: generally use 0.1 (to obtain the average of noises)
- You can modify this parameter using the numeric keys, knob or direction keys. For more details, please refer to "**Parameter Setting**".

Table 2-14 V/R Ratio

Parameter	Explanation
Default	1
Range	0.0000010 to 30000
Unit	N/A
Knob Step	in 1, 3, 10 sequence
Direction Key Step	in 1, 3, 10 sequence

Detector Type

The analyzer displays the swept signal on the screen in the form of trace. For each trace point, the analyzer always captures all the data within a specific time interval and processes (Peak, Average, etc.) the captured data using the detector selected currently, then display the processed data (one point) on the screen .

Key Points:

- Select an appropriate detector type according to the actual application in order to ensure the accuracy of the measurement.
- The available types are Pos Peak, Neg Peak, Sample, Normal, RMS Avg, Voltage Avg and Quasi-Peak. The default is Pos peak.
- The corresponding icon (as shown in the figure below) of the detector type selected is displayed in the status bar at the left side of the screen.



1. Pos Peak

For each trace point, Positive Peak detector displays the maximum value of data sampled within the corresponding time interval.

2. Neg Peak

For each trace point, Negative Peak detector displays the minimum value of data sampled within the corresponding time interval.

3. Sample

For each trace point, Sample detector displays the transient level corresponding to the central time point of the corresponding time interval. This detector type is applicable to noise or noise-like signal.

4. Normal

Normal detector (also called rosenfell detector) displays the maximum value and the minimum value of the sample data segment in turn, namely for an odd-numbered data point, the maximum value is displayed; and for an even-numbered data point, the minimum value is displayed. In this way, the amplitude variation range of the signal is clearly shown.

5. RMS Avg

For each data point, perform mean square root operation (see the equation below) of the sample data within the corresponding time interval and display the result. In this type, noise can be rejected and weak signals can be clearly observed.

$$V_{RMS} = \sqrt{\frac{1}{N} \times \sum_{i=1}^N v_i^2} \quad (2-8)$$

Wherein, V_{RMS} is the mean square root of voltage in V; N is the number of sample values for each point displayed; v_i is the envelop of the sample value in V. The reference resistance R (the reference impedance) can be used for power calculation: $P = \frac{v_{RMS}^2}{R}$.

6. Voltage Avg

For each data point, average (see the equation below) all the sample data within the corresponding time interval and display the result.

$$V_{AV} = \frac{1}{N} \times \sum_{i=1}^N v_i \quad (2-9)$$

Wherein, V_{AV} is the average of voltage in V; N is the number of sample

values for each point displayed; v_i is the envelop of the sample value in V.

7. Quasi-Peak (an option for DSA815)

It is a weighted form of peak detector. For each data point, the detector detects the peaks within the corresponding time interval. The peaks detected are weighted using circuit with specified charge and discharge structures as well as the display time constant specified in the CISPR Publication 16 standards and the result is displayed. Quasi-Peak detector is applicable to EMI testing.

Note: compared to the discharge time, the charge time of Quasi-Peak detector is much shorter and can reflect the amplitude as well as time distribution of the signal.

Filter Type

Set RBW filter type.

Key Points:

- DSA800 supports two kinds of RBW filters: "Gause" (-3 dB bandwidth) and "EMI" (-6 dB bandwidth).
- When "EMI" is selected, resolution bandwidth can be 200 Hz, 9 kHz or 120 kHz only.
- The default is "Gause"; the instrument will switch to "EMI" filter automatically when "Quasi-Peak" detector is selected.

Sweep/Trig

Set parameters about the Sweep and Trigger functions, including Time, Auto SWT, Mode, Numbers, Trigger type, etc.

Sweep Time

Set the time needed for the spectrum analyzer to finish a sweep within the span range. The sweep time can be set in "Auto" or "Manual" mode and the default is "Auto".

Key Points:

- In non-zero span, the analyzer selects the shortest sweep time on the basis of the current RBW and VBW settings if Auto is selected.
- Decreasing the sweep time would speed the measurement. However, an error may be caused if the specified sweep time is less than the minimum sweep time in Auto coupling, and "UNCAL" is shown in the status bar on the screen.
- You can modify this parameter using the numeric keys, knob or direction keys. For more details, please refer to "**Parameter Setting**".

Table 2-15 Sweep time

Parameter	Explanation
Default	50 ms
Range*	20 us to 1500 s
Unit	ks, s, ms, us, ns, ps
Knob Step	Sweep time/100, Min = 1 ms
Direction Key Step	in 1, 1.5, 2, 3, 5, 7.5 sequence

*Note: The minimum in non-zero span mode is 10 ms.

Auto SWT

Set the auto setting method of the sweep time to "Normal" or "Accy". The sweep will be faster if "Normal" is selected; while in "Accy" type, higher measurement precision can be obtained.

Mode

Set the sweep mode to "Single" or "Cont", the default is "Cont". The corresponding icon of the sweep mode will be displayed in the status bar at the left side of the screen.



Single



Continuous

1. Single

Set the sweep mode to "Single". The number **10** on the parameter icon denotes the current sweep number.

2. Cont

Set the sweep mode to "Cont". The character **Cont** on the parameter icon denotes the analyzer is sweeping continuously.

Key Points:

- If the instrument is in single sweep mode and no measurement function is enabled, press this key and the system will enter the continuous mode and sweep continuously if all the trigger conditions are satisfied.
- If the instrument is in single sweep mode and a measurement function is on, press this key and the system will enter the continuous sweep mode and measure continuously if all the trigger conditions are satisfied.
- In continuous mode, the system will send a trigger initialization signal automatically and enter the trigger condition judgment directly after each sweep.

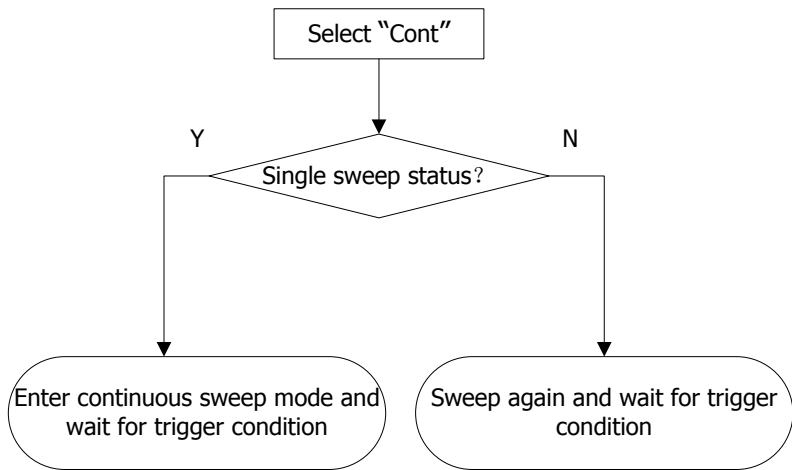

Figure 2-9 Process of Continuous Sweep

Single

In single sweep mode, this menu is used to execute trigger initialization. After that, the analyzer will execute specified number of sweeps (or measurements) if all the trigger conditions are satisfied.

Key Points:

- If the instrument is in continuous sweep mode and no measurement function is enabled, press this key and the system will enter the single sweep mode and execute specified number of sweeps if all the trigger conditions are satisfied.
- If the instrument is in continuous sweep mode and a measurement function is on, press this key and the system will enter the single measure mode and execute specified number of measurements if all the trigger conditions are satisfied.
- If the system is already in single sweep mode, press this key and the system will execute specified number of sweeps (or measurements) if all the trigger conditions are satisfied.
- In single sweep mode, trigger initialization (press **Sweep/Trig** → **Single** or send the ":INIT" command through the remote interface) should be executed before trigger condition judgment.

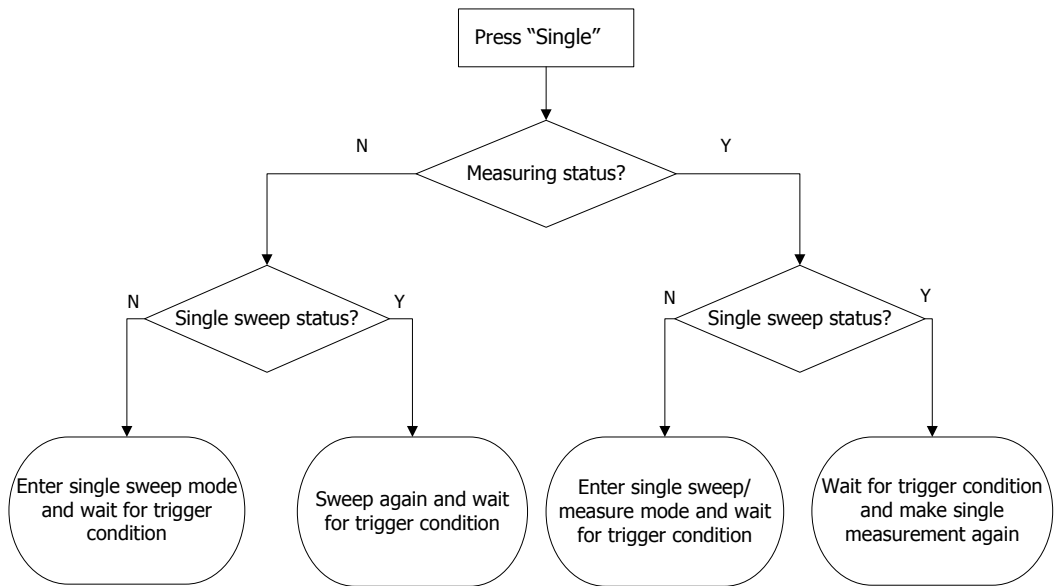

Figure 2-10 Process of Single Sweep

Numbers

Set the number of sweeps for a single sweep. In single mode, the system executes specified number of sweeps and the number shown on the icon in the status bar at the left of the screen varies with the process of the sweep.

Table 2-16 Numbers

Parameter	Explanation
Default	1
Range	1 to 9999
Unit	N/A
Knob Step	1
Direction Key Step	1

Trig Type

The trigger type can be Free Run, Video or External. The corresponding icon of the trigger type will be displayed in the status bar at the left of the screen.



1. Free Run

All trigger conditions can be satisfied at any time and the analyzer generates trigger signals continuously.

2. Video

A trigger signal will be generated when the system detects a video signal of which the voltage exceeds the specified video trigger level. This function is invalid in non-zero span mode, RMS Avg detection or Voltage Avg detection in zero span mode.

3. External

In this mode, an external signal (TTL signal) is input from the **[TRIGGER IN]** connector at the rear panel and trigger signals are generated when this signal fulfills the specified trigger edge condition.

Trig Setup

1. Trigger Level

Set the trigger level in video trigger. At this point, the trigger level line (TL) and value are displayed on the screen. You can use the numeric keys, knob or direction keys to modify this parameter. Please refer to "**Parameter Setting**" for more details.

Table 2-17 Trigger level

Parameter	Explanation
Default	0 dBm
Range	-300 dBm to 50 dBm
Unit*	dBm
Knob Step	1 dBm
Direction Key Step	10 dBm

*Note: it is related to the specified unit of Y-axis.

2. Edge

Set the trigger edge in external trigger to the rising (Pos) or falling (Neg) edge of the pulse.

Trace/P/F

The sweep signal is displayed as a trace on the screen. In addition, DSA800 provides the Pass/Fail (P/F) test function. **Trace/P/F** is used to set parameters related to the trace and P/F test.

Select Trace

DSA800 allows for up to four traces to be displayed at the same time, and each trace has its own color (Trace 1 - Yellow, Trace 2 - purple, Trace 3 - light blue and Trace 4 - green). All traces can be set freely except Trace 4 (a math operation trace that can only be obtained using the other three traces).

Select Trace 1, Trace 2 or Trace 3 to set the corresponding parameters. The default trace and type is Trace 1 and Clear Write.

Note: the trace currently displayed on the screen can be stored in internal or external memory and can be recalled when needed. Press **Storage** to save the trace according to the method introduced in "Storage".

Trace Type

Set the type of the current trace or disable it. The system calculates the sample data using a specific operation method according to the trace type selected and displays the result. Trace types contain Clear Write, Max Hold, Min Hold, Video Avg, Power Avg and Freeze. The corresponding icon of the trace type will be displayed in the status bar at the left of the screen. Take Trace 1 (yellow) as an example and the icons are as shown in the figure below.



1. Clear Write

The trace continuously displays the points during the sweep of the analyzer.

2. Max Hold

Maintain the maximum for each point of the trace, and update the trace point if a new maximum is generated in successive sweeps.

3. Min Hold

Maintain the minimum for each point of the trace, and update the trace point if a new minimum is generated in successive sweeps.

4. Video Avg

Display the logarithmic average for each point of the trace. Traces in this type are smoother.

5. Power Avg

Display the average of each point of the trace. Traces in this type are smoother.

6. Freeze

Stop updating the trace data to observe the trace and read the measurement data. This type is generally used by traces loaded from storage devices or remote interface as default.

7. Blank

Disable the trace display and all measurements of this trace.

Average Times

Set the number of averages of the selected trace.

Key Points:

- More averages can reduce the noise and the influence of other random signals, thus highlighting the stable signal characteristics. The larger the number of averages is, the smoother the trace will be.
- You can use the numeric keys to modify this parameter, please refer to "**Parameter Setting**" for more details.

Table 2-18 Average times

Parameter	Explanation
Default	100
Range	1 to 1000
Unit	N/A
Knob Step	N/A
Direction Key Step	N/A

Trace Math

1. Function

Set the computational method of the math trace.

- A-B: subtract Trace B from A
- A+Constant: add a constant to Trace A
- A-Constant: subtract a constant from Trace A

2. A

Select "T1", "T2" or "T3". Assign a value to A from Trace1, Trace 2 or Trace 3, the default is Trace 1 (T1).

3. B

Select "T1", "T2" or "T3". Assign a value to B from Trace1, Trace 2 or Trace 3, the default is Trace 2 (T2).

4. Constant

Set the value of the constant.

You can use the numeric keys to modify this parameter, please refer to "**Parameter Setting**" for more details.

Table 2-19 Constant in the math operation

Parameter	Explanation
Default	0 dB
Range	-300 dB to 300 dB
Unit	dB

5. Operate

Enable or disable the display of the math trace and the default is Off.

Clear All

Clear all the traces displayed on the screen. This operation will stop the current advanced measurement as there is not valid data source.

Pass/Fail

DSA800 supports the Pass/Fail test function. In this function, the measured curve is compared with the pre-edited curve. If the related rules are met, the result is "Pass", or else is "Fail". The measurement interface is as shown in the figure below.

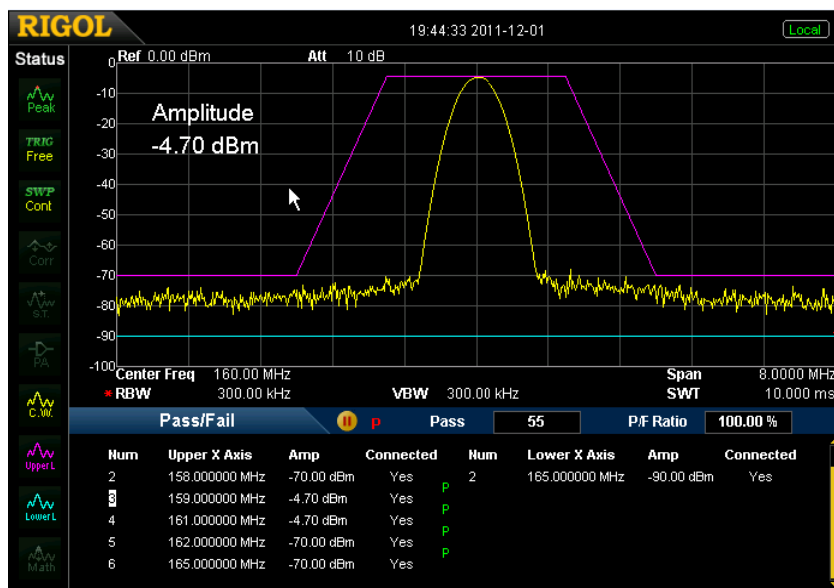

Figure 2-11 Interface of Pass/Fail Measurement

Result:

The results of Pass/Fail test contain the pass number and the pass ratio.

1. Switch

Turn on or off the Pass/Fail test function and the default is "Off". When the function is enabled, the system changes to split-screen display. At this point, T2 and T3 are used for marking the Upper and Lower limits separately.

2. Settings

- **Limit:** select the desired limit line (upper or lower) for editing, and then press **Edit** to set the limit conditions.
- **Test:** enable or disable the test function. Each limit line has its own switch, you can test both together, either one or neither.
Note: **Trace/P/F** → **Pass/Fail** → **Switch** is only used to enable or disable the setting menu of Pass/Fail test, not the test itself.
- **Edit:** Edit the properties of the limit lines.
Note: the edited limit line data can be stored in internal or external memory and can be recalled when needed. After the editing is finished, press **Storage** to store the data according to the method introduced in "Storage".

Table 2-20 Pass/Fail menu

Function	Explanation
Limit	Quickly select the limit line to be edited.
Point	Set the number of the point to be edited. The range is from 1 to 200.
X-axis	Edit the properties of the limit lines.
Amplitude	Enter the amplitude of the point you are editing. The range is from -400 dBm to 320 dBm.
Connected	Connect this point with the previous one or not.
Del Point	Delete the point you are editing.

- **X Axis:** set the X-axis unit to frequency or time unit. Note that all the points of the current limit line will be deleted when the X-axis unit changes.
- **Freq Interp:** set the Freq Interp to Log or Lin. In Log mode, both the frequency and amplitude use Log unit to do interpolation operation; in Lin mode, the frequency uses a Lin unit and the amplitude uses a Log unit for interpolation operation.
- **Del Limit:** delete the limit line you are editing.

- **Fail Stop:** select whether to perform the next sweep if the test fails.
- **Beeper:** turn on or off the beeper. When the beeper is on, it beeps when the test fails.

3. Restart

Re-execute the active or suspended test.

4. Pause

Suspend the test after the current test is finished. At this point, the measurement data stops updating, but the sweep continues.  is displayed in the test result display window.

5. Resume

Resume the suspended test and the test data begins updating again.  is displayed in the test result display window.

6. Meas Mode

Set the measurement mode to single or continuous. In single mode, the analyzer stops after a specified number of tests. After this, every time when **Single** is pressed, the system executes specified number of tests and updates the test data. In continuous mode, the analyzer tests continuously.

7. Single

In single mode, the analyzer stops after a specified number of tests. After this, every time when **Single** is pressed, the system executes specified number of tests and updates the test data.

TG

Set the parameter related to the tracking generator (TG). The tracking generator provides two working modes: Power Sweep output (when Power Sweep is On) and Fixed Power output (when Power Sweep is Off). The TG function is an option for DSA815 and can only be used when installed. To purchase, please contact **RIGOL** or your local distributor.

TG

TG is used to enable or disable the TG.

When the TG is enabled, a signal with the same frequency of the current sweep signal will be output from the **[GEN OUTPUT 50Ω]** connector at the front panel. The Power of the signal could be set through the menu. The tracking generator provides two working modes: Power Sweep output (when Power Sweep is On) and Fixed Power output (when Power Sweep is Off).

The TG function is an option for DSA815. To purchase, please contact **RIGOL** salesman or your local distributor.

TG Level

Set the output power of the signal from the tracking generator. In Power Sweep mode, this parameter indicates the start power of the sweep. You can use the numeric keys, knob or direction keys to modify this parameter. For more details, please refer to "**Parameter Setting**".

Table 2-21 TG level

Parameter	Explanation
Default	-20 dBm
Range	-20 dBm to 0 dBm
Unit	dBm, -dBm, mV, uV
Knob Step	1 dBm
Direction Key Step	10 dBm

TG Lvl Offset

Assign a certain offset to the output power of the TG when gains or losses occur between the TG output and external device in order to display the actual power value.

Key Points:

- This parameter only changes the readout of the TG output power, rather than the actual value of it.
- The offset could be either a positive (gain in the external output) or a negative (loss in the external output).
- You can use the numeric keys, knob or direction keys to modify this parameter. For more details, please refer to "**Parameter Setting**".

Table 2-22 TG Level Offset

Parameter	Explanation
Default	0 dB
Range	-200 dB to 200 dB
Unit	dB
Knob Step	1 dB
Direction Key Step	10 dB

Power Sweep

Enable or disable the power sweep function.

When enabled, the output power of the TG varies with the sweep rate of the analyzer within the specified sweep frequency range (from start to stop frequency) and increases gradually from the specified TG power (see "TG ") within the specified power range (see "**Power Range**"). When disabled, the TG output is fixed at the specified power (see "TG ").

Note: this function is not available in zero span mode.

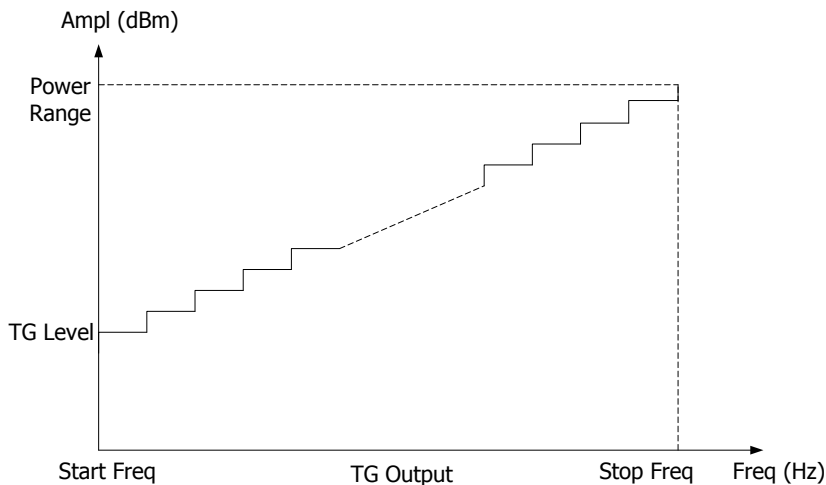

Figure 2-12 Power Sweep

Power Range

Set the output power range of the TG in power sweep mode. This parameter together with the TG level forms the boundary parameters in power sweep mode. You can use the numeric keys, knob or direction keys to modify this parameter. For more details, please refer to "**Parameter Setting**".

Table 2-23 Power Range of TG

Parameter	Explanation
Default	0 dB
Range	0 dB to 20 dB
Unit	dB
Knob Step	1 dB
Direction Key Step	10 dB

Normalize

Eliminate the error of TG Level. Before using this function, connect the **[GEN OUTPUT 50 Ω]** output terminal of the TG with the **[RF INPUT 50 Ω]** input terminal of the analyzer.

1. Stor Ref

Save the data of Trace 1 to Trace 3 as the reference value for normalization. This operation should be done before you enable the normalization.

2. Normalize

Enable or disable the normalization. When enabled, the reference trace will be stored automatically after the current sweep finishes if no reference trace is stored before. During storing the reference trace, the corresponding prompt message is displayed. When normalization is enabled, the corresponding value of the reference trace will be subtracted from the trace data after every sweep.

3. Norm Ref Lvl

Adjust the vertical position of the trace on the screen when normalization is enabled.

- Being different from the **Ref Level** function in the **AMPT** menu, this parameter has no influence on the reference level of the analyzer.
- You can use the numeric keys, knob or direction keys to modify this parameter. For more details, please refer to "**Parameter Setting**".

Table 2-24 Reference level under normalization

Parameter	Explanation
Default	0 dB
Range	-200 dB to 200 dB
Unit	dB
Knob Step	1 dB
Direction Key Step	10 dB

4. Norm Ref Pos

Adjust the vertical position of the normalization reference level on the screen when normalization is enabled.

- The function of this menu is similar to that of **Norm Ref Lvl**. When it is set to 0%, the normalization reference level is displayed at the bottom of the screen grid and at the top when it is set to 100%.
- You can use the numeric keys, knob or direction keys to modify this parameter. For more details, please refer to "**Parameter Setting**".

Table 2-25 TG reference position

Parameter	Explanation
Default	100%
Range	0 to 100%
Unit	%
Knob Step	1%
Direction Key Step	10%

5. Ref Trace

Set whether to display the reference trace or not. If "View" is selected, the reference trace saved (Trace 3) will be shown in "Freeze" type.

Note: When normalization is enabled, the unit of Y-axis is "dB" and will not be influenced by the definition in **AMPT** → **Units**, and "(dB)" is displayed under the Y-axis scale in the user interface.

Measurement Settings

Meas

Provide VSWR and various advanced measurement functions, including T-Power, ACP (Adjacent Channel Power), Chan Pwr (Channel Power), OBW (Occupied Bandwidth), EBW (Emission Bandwidth), C/N Ratio, Harmo Dist (Harmonic Distortion) and TOI (Third Order Intermodulation). For advanced measurement functions, the measurement mode can be single or continuous and you can control the measurement including Restart, Pause and Resume.

VSWR

Turn on or off the VSWR measurement function. This function is an option for DSA815. Turn on the VSWR measurement function, the screen is divided into two windows automatically (the lower window provides the measurement wizard). At this point, you can perform the VSWR measurement according to the wizard. Press **Meas Setup** to set the corresponding parameters.

Tip

VSWR bridge and TG are required in VSWR measurement. Therefore, this function is only available when the VSWR measurement kit, VSWR bridge and 1.5 GHz TG are installed. Enable the VSWR measurement and the TG and the backlights of **Meas** and **TG** at the front panel turns on.

Measurement Function

This function is an option for DSA815 and is only available when the advanced measurement kit is installed. When a measurement function is selected, the screen is divided into two windows with the upper window (the basic measurement window) displaying the sweep trace and the lower window displaying the measurement results.

1. T-Power

This system enters zero span mode and calculates the power within the time domain. The types of powers available include Peak, Average and RMS.

Select **T-Power** and press **Meas Setup** to set the corresponding parameters.

2. ACP

Measure the powers of the main channel and adjacent channels as well as the power difference between the main channel and each of the adjacent channels. When this function is enabled, the span and resolution bandwidth of the analyzer are adjusted to smaller values automatically.

Select **ACP** and press **Meas Setup** to set the corresponding parameters.

3. Chan Pwr

Measure the power and power density within the specified channel bandwidth. When this function is enabled, the span and resolution bandwidth are automatically adjusted to smaller values.

Select **Chan Pwr** and press **Meas Setup** to set the corresponding parameters.

4. OBW

Integrate the power within the whole span and calculate the bandwidth occupied by this power according to the specified power ratio. The OBW function also indicates the difference between the center frequency of the channel under measurement and the center frequency of the analyzer.

Select **OBW** and press **Meas Setup** to set the corresponding parameters.

5. EBW

Measure the bandwidth between two points on the signal which are X dB below the highest point within the span.

Select **EBW** and press **Meas Setup** to set the corresponding parameters.

6. C/N Ratio

Measure the powers of the carrier and noise with the specified bandwidth as well as their power ratio.

Select **C/N Ratio** and press **Meas Setup** to set the corresponding parameters.

7. Harmo Dist

Measure the power of each order of harmonic and THD (total harmonic distortion) of the carrier. The highest order of harmonic available is 10 and the fundamental wave amplitude must be greater than -50 dBm, or else the measurement will be invalid.

Select **Harmo Dist** and press **Meas Setup** to set the corresponding parameters.

8. TOI

Measure the parameters of the TOI production of two signals with the same amplitude and similar frequency. Those parameters include the frequencies and amplitudes of the Base Lower, Base Upper, 3rd Order Lower and 3rd Order Upper signal, as well as the Intercepts of both the Base Lower and Base Upper.

Select **TOI** and press **Meas Setup** to set the corresponding parameters.

Restart

Re-execute the active or suspended measurement. This setting is only available for advanced measurement functions.

Pause

Suspend the measurement after the current measurement is finished. The measurement data stops updating, but the sweep continues.  is displayed in the measurement result display window. This setting is only available for advanced measurement functions.

Resume

Resume the suspended measurement and the measurement data begins updating again.  is displayed in the measurement result display window. This setting is only available for advanced measurement functions.

Meas Mode

Set the measurement mode to single or continuous. In single mode, the analyzer stops after a specified number of measurements. After this, every time when **Single** is pressed, the system executes specified number of measurements and updates the measurement data. In continuous mode, the analyzer measures continuously. This setting is only available for advanced measurement functions.

Single

In single mode, the analyzer stops after a specified number of measurements. After this, every time when **Single** is pressed, the system executes specified number of measurements and updates the measurement data. This setting is only available for advanced measurement functions.

Meas Setup

Open the parameter setting menu of the function selected in the **Meas** menu. This key is only available when the function is enabled.

VSWR

Measurement Interface:

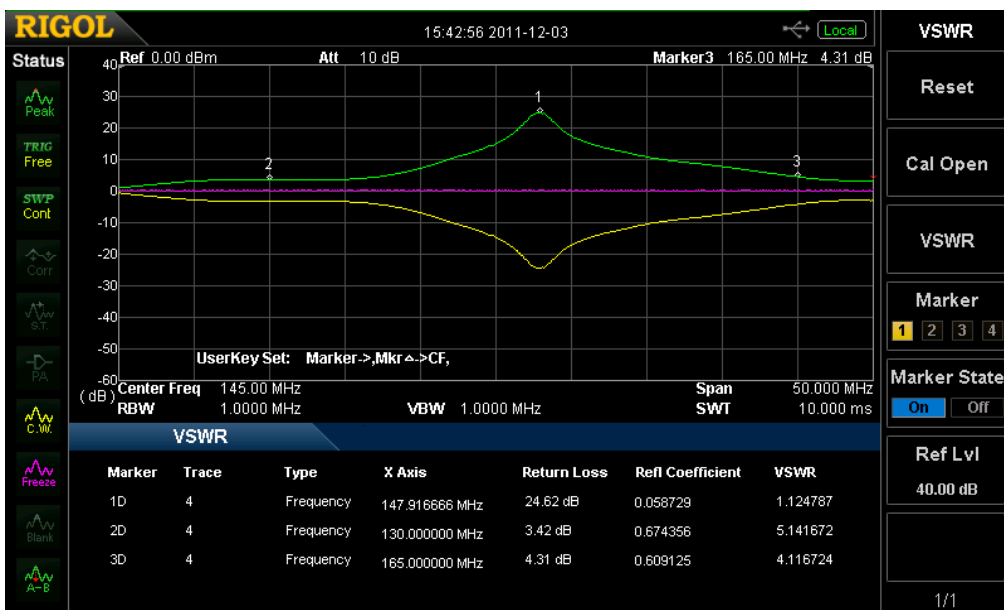

Figure 2-13 VSWR Measurement Interface

Measurement Results: return loss, reflection coefficient and VSWR.

This measurement requires the VSWR, VSWR bridge and TG options. Two measurements have to be performed according to the measurement wizard at the lower side of the interface: measurement with the device under test disconnected (represented by trace 2) and measurement with the device under test connected (represented by trace 1). The return loss (represented by the math trace) is determined by the difference of the results of the two measurements and the reflection coefficient and VSWR are determined by the return loss.

1. Reset

Reset VSWR measurement parameters.

2. Cal Open

Disconnect the device under test and then press this softkey. The instrument executes the first measurement and the measurement result is represented by trace 2.

3. VSWR

Connect the device under test and then press this softkey. The instrument executes the second measurement and the measurement result is represented by trace 1. At the same time, the analyzer calculates the difference between the two measurement results (represented by the math trace) and calculates the return loss, reflection coefficient and VSWR on the basis of the difference.

4. Marker

Select one marker from the four and the default is marker 1. When a marker is selected, you can set its state. The marker selected is marked onto the math trace and the measurement result at the current marker is displayed in the measurement wizard. You can use the knob to move the marker to view the measurement results of different positions.

5. Marker State

Set the state of the current marker.

6. Ref Level

Adjust the vertical position of the trace on the screen.

- Being different from the **Ref Level** in the **AMPT** menu, this parameter has no influence on the reference level of the analyzer.
- You can use the numeric keys, knob or direction keys to modify this parameter.

Table 2-26 VSWR Ref Level

Parameter	Explanation
Default	0 dB
Range	-200 dB to 200 dB
Unit	dB
Knob Step	1 dB
Direction Key Step	10 dB

T-Power

Measurement Interface:

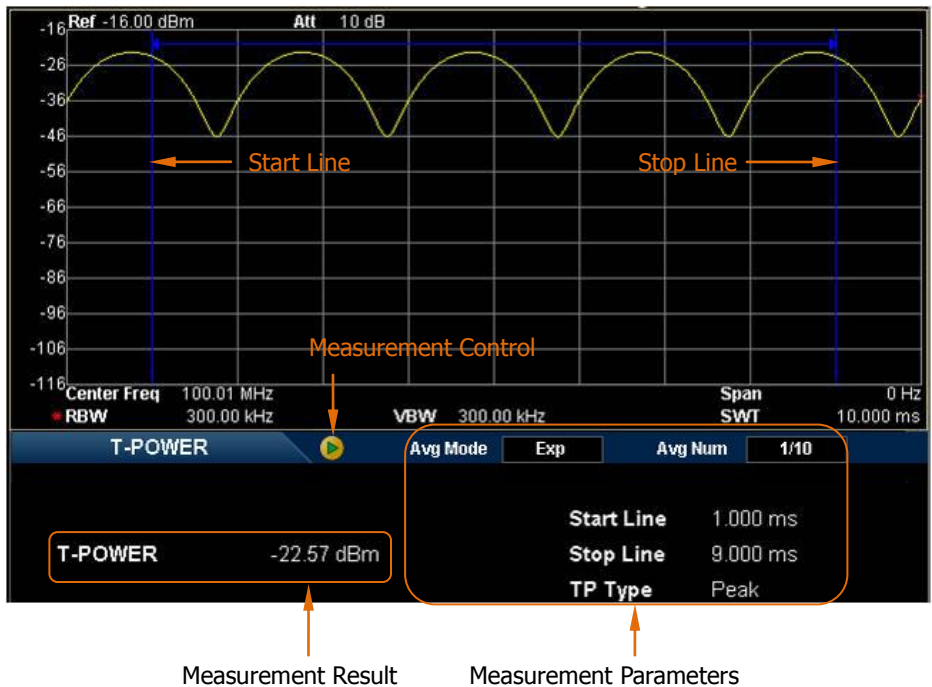

Figure 2-14 T-Power Measurement Interface

Measurement Result: T-power, namely the power of the signal from the start line to the stop line.

Measurement Parameters: average number, average mode, TP type, start line and stop line.

1. Avg Num

Specify the number of measurement averages used when calculating the measurement result. The default is "Off". You can use the numeric keys, knob or direction keys to modify this parameter.

Table 2-27 Average Number of T-Power Measurement

Parameter	Description
Default	10
Range	1 to 1000

Unit	N/A
Knob Step	1
Direction Key Step	1

2. Avg Mode

Set the average operation mode to "Exp" or "Repeat" and the default is "Exp".

- When "Exp" is selected, the result is the exponential average of the current **N** (**N** is specified in "**Avg Num**") measurement results.
- When "Repeat" is selected, the result is the arithmetic average of the current **N** (**N** is specified in "**Avg Num**") measurement results.

3. TP Type

- **Peak**

Display the power of the signal with the maximum amplitude between the start line and stop line. The detector type is set to "Pos Peak" automatically.

- **Average**

Display the average power of signals between the start line and stop line. The detector type is set to "Voltage Avg" automatically.

- **RMS**

Display the mean square root (in power unit) of the voltages of signals between the start line and stop line. The detector type is set to "RMS Avg" automatically.

4. Start Line

Set the left margin (in time unit) of T-Power measurement. The data calculated under this measurement is between the start line and stop line.

You can use the numeric keys, knob or direction keys to modify this parameter.

Table 2-28 Start Line for T-Power Measurement

Parameter	Description
Default	0 us
Range	0 us to Stop Line
Unit	Ks, s, ms, us, ns, ps
Knob Step	Sweep Time/600
Direction Key Step	in 1-1.5-2-3-5-7.5 sequence

5. Stop Line

Set the right margin (in time unit) of T-Power measurement. The data calculated under this measurement is between the start line and stop line.

You can use the numeric keys, knob or direction keys to modify this parameter.

Table 2-29 Stop Line for T-Power Measurement

Parameter	Description
Default	50 ms
Range	Start Line to Sweep Time
Unit	Ks, s, ms, us, ns, ps
Knob Step	Sweep Time/600
Direction Key Step	in 1-1.5-2-3-5-7.5 sequence

ACP

Measurement Interface:

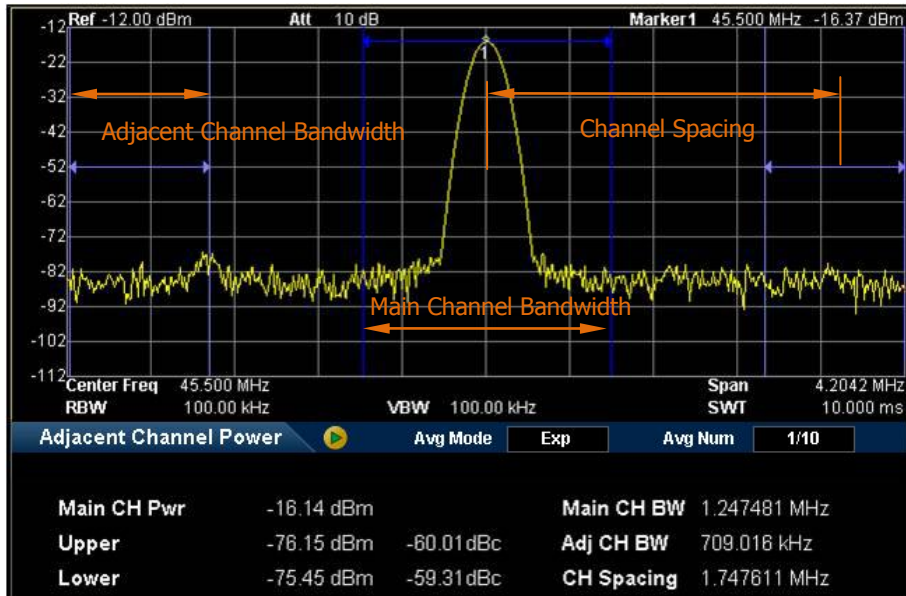

Figure 2-15 Adjacent Channel Power Measurement Interface

Measurement Results: Main CH Pwr, Upper and Lower.

- CH Pwr: display the power within the bandwidth of the main channel.
- Upper: display the power of the upper channel and the power difference between the upper channel and the main channel (in dBc).
- Lower: display the power of the lower channel and the power difference between the lower channel and the main channel (in dBc).

Measurement Parameters: average number, average mode, main channel bandwidth, adjacent channel bandwidth and channel spacing.

1. Avg Num

Specify the number of measurement averages used when calculating the measurement result and the default is "Off". You can use the numeric keys, knob or direction keys to modify this parameter.

Table 2-30 Average Number for ACP Measurement

Parameter	Description
Default	10
Range	1 to 1000
Unit	N/A
Knob Step	1
Direction Key Step	1

2. Avg Mode

Set the average operation mode to "Exp" or "Repeat" and the default is "Exp".

- When "Exp" is selected, the result is the exponential average of the current **N** (**N** is specified in "**Avg Num**") measurement results.
- When "Repeat" is selected, the result is the arithmetic average of the current **N** (**N** is specified in "**Avg Num**") measurement results.

3. Main CH BW

Set the bandwidth of the main channel and the power of the main channel is the power integral within this bandwidth. You can use the numeric keys, knob and direction keys to modify this parameter.

Table 2-31 Main Channel Bandwidth for ACP Measurement

Parameter	Description
Default	2 MHz
Range	33 Hz to 500 MHz
Unit	GHz, MHz, kHz, Hz
Knob Step	Main Channel BW/100, the minimum is 1Hz
Direction Key Step	in 1-1.5-2-3-5-7.5 sequence

4. Adj CH BW

Set the frequency width of the adjacent channels.

- The adjacent channel bandwidth is related to the main channel bandwidth and the range available is from main channel bandwidth/20 to main channel bandwidth×20.
- You can use the numeric keys, knob or direction keys to modify this parameter.

Table 2-32 Adjacent Channel Bandwidth for ACP Measurement

Parameter	Description
Default	2 MHz
Range	33 Hz to 500 MHz
Unit	GHz, MHz, kHz, Hz
Knob Step	Adjacent Channel BW/100, the minimum is 1 Hz
Direction Key Step	in 1-1.5-2-3-5-7.5 sequence

5. CH Spacing

Set the difference between the center frequency of the main channel and the center frequency of the adjacent channels.

- Adjusting this parameter will also adjust the distance between the upper/lower channel and the main channel.
- You can use the numeric keys, knob or direction keys to modify this parameter.

Table 2-33 Channel Spacing for ACP Measurement

Parameter	Description
Default	2 MHz
Range	33 Hz to 500 MHz
Unit	GHz, MHz, kHz, Hz
Knob Step	Channel Spacing/100, the minimum is 1 Hz
Direction Key Step	in 1-1.5-2-3-5-7.5 sequence

Chan Pwr

Measurement Interface:

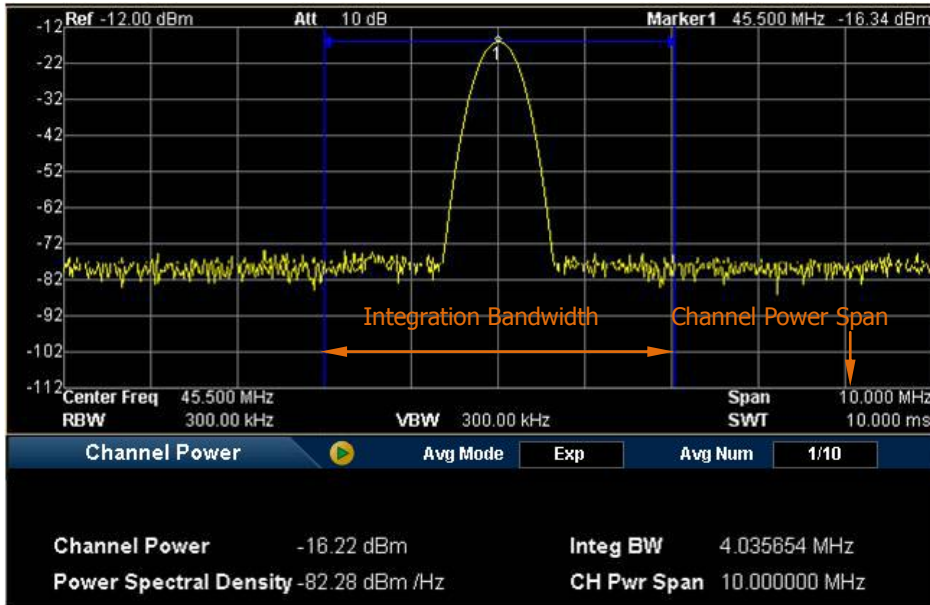

Figure 2-16 Channel Power Measurement Interface

Measurement Results: channel power and power spectral density.

- Channel Power: power within the integration bandwidth.
- Power Spectral Density: power (in dBm/Hz) normalized to 1 Hz within the integration bandwidth.

Measurement Parameters: average number, average mode, integration bandwidth and channel power span.

1. Avg Num

Specify the number of measurement averages used when calculating the measurement result and the default is "Off". You can use the numeric keys, knob or direction keys to modify this parameter.

Table 2-34 Average Number for Chan Power Measurement

Parameter	Description
Default	10
Range	1 to 1000
Unit	N/A
Knob Step	1
Direction Key Step	1

2. Avg Mode

Set the average operation mode to "Exp" or "Repeat" and the default is "Exp".

- When "Exp" is selected, the result is the exponential average of the current **N** (**N** is specified in "**Avg Num**") measurement results.
- When "Repeat" is selected, the result is the arithmetic average of the current **N** (**N** is specified in "**Avg Num**") measurement results.

3. Integ BW

Set the frequency width of the channel to be tested and the power of the channel is the power integral within this bandwidth. You can use the numeric keys, knob or direction keys to modify this parameter.

Table 2-35 Integration Bandwidth for Chan Power Measurement

Parameter	Description
Default	2 MHz
Range	100 Hz to 1.5 GHz
Unit	GHz, MHz, kHz, Hz
Knob Step	Integration BW/100, the minimum is 1 Hz
Direction Key Step	in 1-1.5-2-3-5-7.5 sequence

4. CH Pwr Span

Set the frequency range of the channel. This span which is the same with the span of the analyzer is the frequency range of the sweep. Modifying this parameter will change the span of the analyzer.

- The channel power span is related to the integration bandwidth and the range available is from integration bandwidth to integration bandwidth×20.
- You can use the numeric keys, knob or direction keys to modify this parameter.

Table 2-36 Channel Power Span for Chan Power Measurement

Parameter	Description
Default	3 MHz
Range	100 Hz to 1.5 GHz
Unit	GHz, MHz, kHz, Hz
Knob Step	Channel Power Span/100, the minimum is 1 Hz
Direction Key Step	in 1-1.5-2-3-5-7.5 sequence

OBW

Measurement Interface:

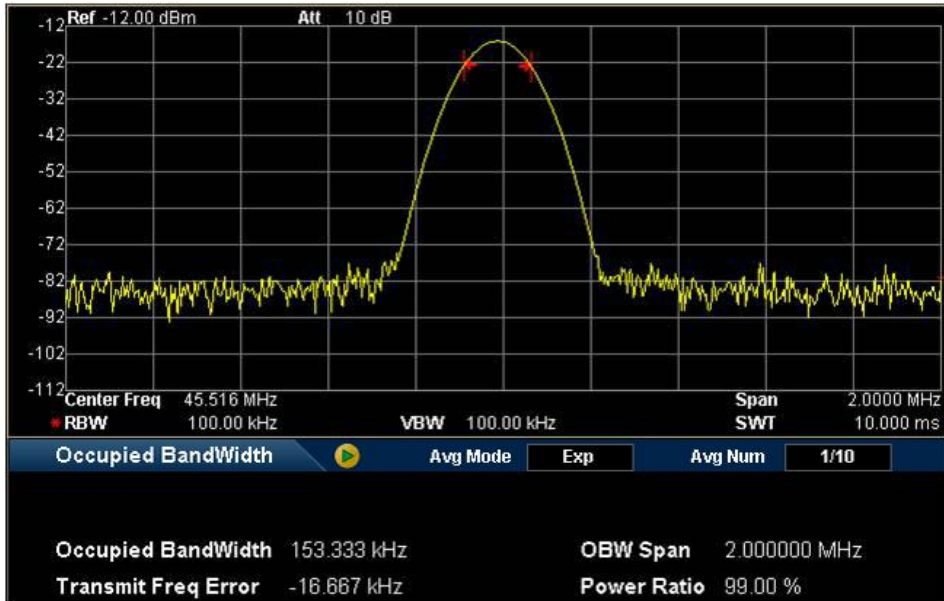

Figure 2-17 OBW Measurement Interface

Measurement Results: occupied bandwidth and transmit frequency error.

- Occupied Bandwidth: integrate the power within the whole span and then calculate the bandwidth occupied by the power according to the specified power ratio.
- Transmit Frequency Error: difference between the center frequency of the channel and the center frequency of the analyzer.

Measurement Parameters: average number, average mode, max hold, span and power ratio.

1. Avg Num

Specify the number of measurement averages used when calculating the measurement result and the default is "Off". You can use the numeric keys, knob or direction keys to modify this parameter.

Table 2-37 Average Number for OBW Measurement

Parameter	Description
Default	10
Range	1 to 1000
Unit	N/A
Knob Step	1
Direction Key Step	1

2. Avg Mode

Set the average operation mode to "Exp" or "Repeat" and the default is "Exp".

- When "Exp" is selected, the result is the exponential average of the current **N** (**N** is specified in "**Avg Num**") measurement results.
- When "Repeat" is selected, the result is the arithmetic average of the current **N** (**N** is specified in "**Avg Num**") measurement results.

3. Max Hold

Enable or disable max hold and the default is "Off".

- When Max Hold is enabled, each measurement result is compared with the previous result and the maximum is displayed.
- When Max Hold is disabled, the current measurement result is displayed.
- Max Hold and average measurement mode are mutually exclusive and average measurement mode will be automatically disabled when Max Hold is enabled.

4. OBW Span

Set the frequency range of integration. This span which is the same with the span of the analyzer is the frequency range for the sweep. Modifying this parameter will also change the span of the analyzer. You can use the numeric keys, knob or direction keys to modify this parameter.

Table 2-38 Span for OBW Measurement

Parameter	Description
Default	2 MHz
Range	100 Hz to 1.5 GHz
Unit	GHz, MHz, kHz, Hz
Knob Step	OBW Span/100, the minimum is 1 Hz
Direction Key Step	in 1-1.5-2-3-5-7.5 sequence

5. Power Ratio

Set the percentage the signal power takes up in the whole span power. You can use the numeric keys, knob or direction keys to modify this parameter.

Table 2-39 Power Ratio for OBW Measurement

Parameter	Description
Default	99%
Range	1% to 99.99%
Unit	%
Knob Step	0.01%
Direction Key Step	1%

EBW

Measurement Interface:

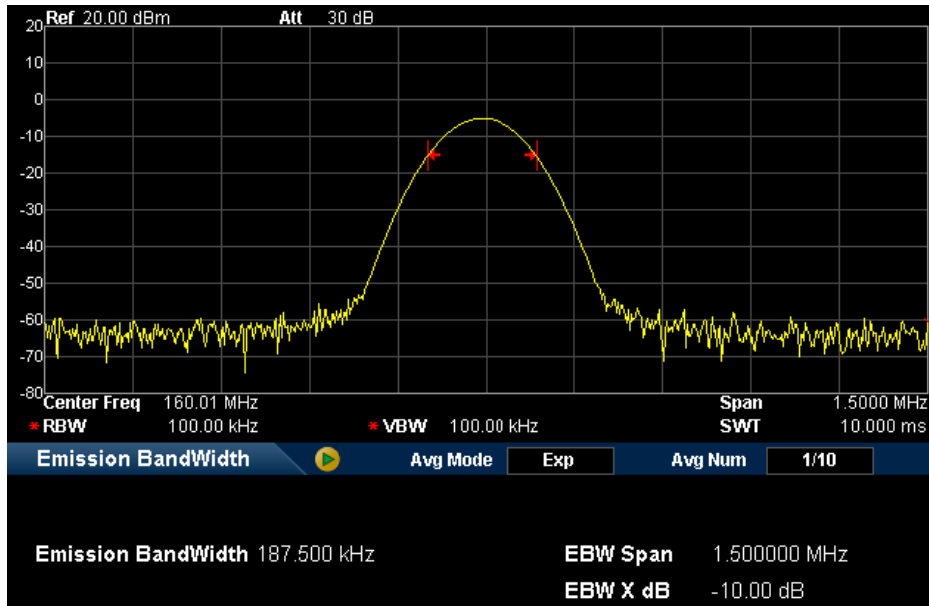

Figure 2-18 EBW Measurement Interface

Measurement Results: emission bandwidth, namely the bandwidth between two points on a signal which are X dB below the highest point within the span. During the measurement, the analyzer first determines the frequency (f_0) of the maximum amplitude point and then finds the two frequencies furthest below and furthest above f_0 at which the signal amplitude is X dB below the maximum amplitude. These frequencies are designated as f_1 and f_2 and the emission bandwidth is f_2-f_1 .

Measurement Parameters: average number, average mode, max hold, span and X dB.

1. Avg Num

Specify the number of measurement averages used when calculating the measurement result and the default is "Off". You can use the numeric keys, knob or direction keys to modify this parameter.

Table 2-40 Average Number for EBW Measurement

Parameter	Description
Default	10
Range	1 to 1000
Unit	N/A
Knob Step	1
Direction Key Step	1

2. Avg Mode

Set the average operation mode to "Exp" or "Repeat" and the default is "Exp".

- When "Exp" is selected, the result is the exponential average of the current **N** (**N** is specified in "**Avg Num**") measurement results.
- When "Repeat" is selected, the result is the arithmetic average of the current **N** (**N** is specified in "**Avg Num**") measurement results.

3. Max Hold

Enable or disable max hold and the default is "Off".

- When Max Hold is enabled, each measurement result is compared with the previous result and the maximum is displayed.
- When Max Hold is disabled, the current measurement result is displayed.
- Max Hold and average measurement mode are mutually exclusive and average measurement mode will be automatically disabled when Max Hold is enabled.

4. EBW Span

This span which is the same with the span of the analyzer is the frequency range for the sweep. Modifying this parameter will also change the span of the analyzer. You can use the numeric keys, knob or direction keys to modify this parameter.

Table 2-41 Span for EBW Measurement

Parameter	Description
Default	2 MHz
Range	100 Hz to 1.5 GHz
Unit	GHz, MHz, kHz, Hz
Knob Step	EBW Span/100, the minimum is 1 Hz
Direction Key Step	in 1-1.5-2-3-5-7.5 sequence

5. EBW X dB

Set the value of X dB used for EBW calculation. You can use the numeric keys, knob or direction keys to modify this parameter.

Table 2-42 X dB for EBW Measurement

Parameter	Description
Default	-10 dB
Range	-100 dB to -0.1 dB
Unit	dB
Knob Step	0.1 dB
Direction Key Step	1 dB



C/N Ratio

Measurement Interface:

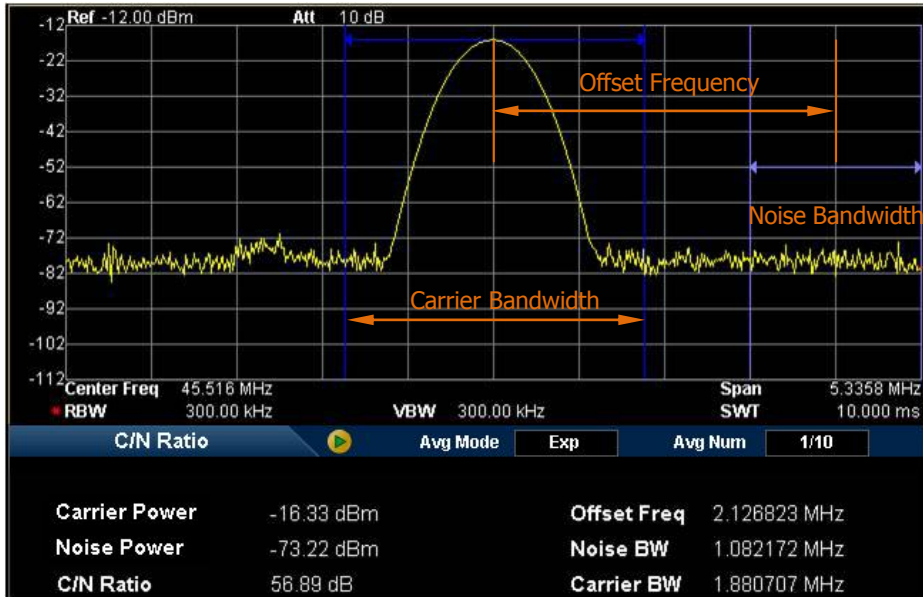

Figure 2-19 C/N Ratio Measurement Interface

Measurement Results: carrier power, noise power and C/N ratio.

- Carrier Power: power within the carrier bandwidth.
- Noise Power: power within the noise bandwidth.
- C/N Ratio: the ratio of the carrier power to the noise power.

Measurement Parameters: average number, average mode, offset frequency, noise bandwidth and carrier bandwidth.

1. Avg Num

Specify the number of measurement averages used when calculating the measurement result and the default is "Off". You can use the numeric keys, knob or direction keys to modify this parameter.

Table 2-43 Average Number for C/N Ratio Measurement

Parameter	Description
Default	10
Range	1 to 1000
Unit	N/A
Knob Step	1
Direction Key Step	1

2. Avg Mode

Set the average operation mode to "Exp" or "Repeat" and the default is "Exp".

- When "Exp" is selected, the result is the exponential average of the current **N** (**N** is specified in "**Avg Num**") measurement results.
- When "Repeat" is selected, the result is the arithmetic average of the current **N** (**N** is specified in "**Avg Num**") measurement results.

3. Offset Freq

Set the difference between the carrier center frequency and the noise center frequency. You can use the numeric keys, knob and direction keys to modify this parameter.

Table 2-44 Frequency Offset for C/N Ratio Measurement

Parameter	Description
Default	2 MHz
Range	33 Hz to 500 MHz
Unit	GHz, MHz, kHz, Hz
Knob Step	Offset Frequency/100, the minimum is 1Hz
Direction Key Step	in 1-1.5-2-3-5-7.5 sequence

4. Noise BW

Set the bandwidth of the noise to be measured. You can use the numeric keys, knob or direction keys to modify this parameter.

Table 2-45 Noise Bandwidth for C/N Ratio Measurement

Parameter	Description
Default	2 MHz
Range	33 Hz to 500 MHz
Unit	GHz, MHz, kHz, Hz
Knob Step	Noise BW/100, the minimum is 1 Hz
Direction Key Step	in 1-1.5-2-3-5-7.5 sequence

5. Carrier BW

Set the bandwidth of the carrier to be measured.

- The carrier bandwidth is related to the noise bandwidth and the range available is from noise bandwidth/20 to noise bandwidth×20.
- You can use the numeric keys, knob and direction keys to modify this parameter.

Table 2-46 Carrier Bandwidth for C/N Ratio Measurement

Parameter	Description
Default	2 MHz
Range	33 Hz to 500 MHz
Unit	GHz, MHz, kHz, Hz
Knob Step	Carrier Noise/100, the minimum is 1 Hz
Direction Key Step	in 1-1.5-2-3-5-7.5 sequence

Harmo Dist

Measurement Interface:

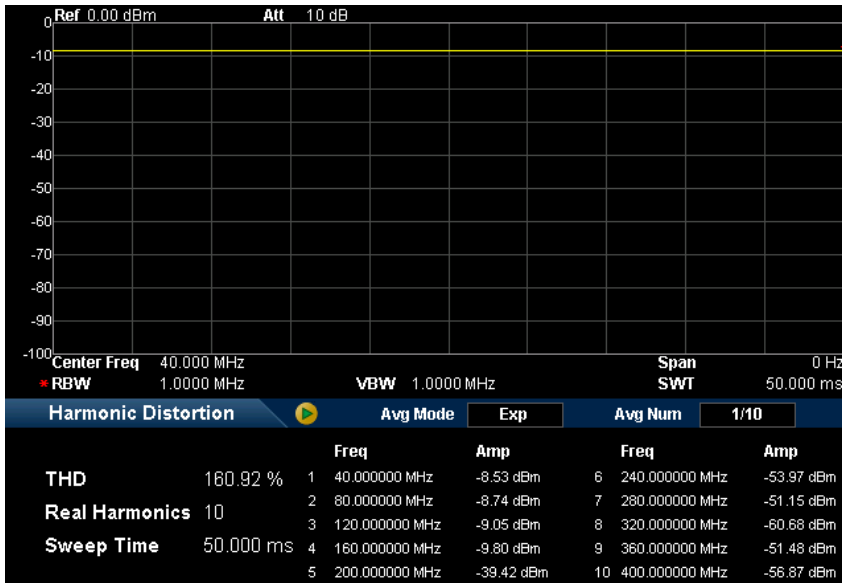

Figure 2-20 Harmonic Distortion Measurement Interface

Measurement Results: amplitude of each order of harmonic and total harmonic distortion. Up to 10th order of harmonic can be measured.

Measurement Parameters: average number, average mode, number of harmonics and sweep time.

1. Avg Num

Specify the number of measurement averages used when calculating the measurement result and the default is "Off". You can use the numeric keys, knob or direction keys to modify this parameter.

Table 2-47 Average Number for Harmo Dist Measurement

Parameter	Description
Default	10
Range	1 to 1000
Unit	N/A
Knob Step	1
Direction Key Step	1

2. Avg Mode

Set the average operation mode to "Exp" or "Repeat" and the default is "Exp".

- When "Exp" is selected, the result is the exponential average of the current **N** (**N** is specified in "**Avg Num**") measurement results.
- When "Repeat" is selected, the result is the arithmetic average of the current **N** (**N** is specified in "**Avg Num**") measurement results.

3. NO.of Harmo

Set the number of the harmonics to measure before calculating the total harmonic distortion. You can use the numeric keys, knob and direction keys to modify this parameter.

Table 2-48 Number of Harmonics for Harmo Dist Measurement

Parameter	Description
Default	10
Range	2 to 10
Unit	N/A
Knob Step	1
Direction Key Step	1

4. Harmonic ST

Set the sweep time of the harmonic measurement, namely the sweep time of the analyzer. You can use the numeric keys, knob and direction keys to modify this parameter.

Table 2-49 Sweep Time for Harmonic Measurement

Parameter	Description
Default	50 ms
Range	20 us to 1.5 ks
Unit	Ks, s, ms, us, ns, ps
Knob Step	1 us
Direction Key Step	1 us

TOI

Measurement Interface:

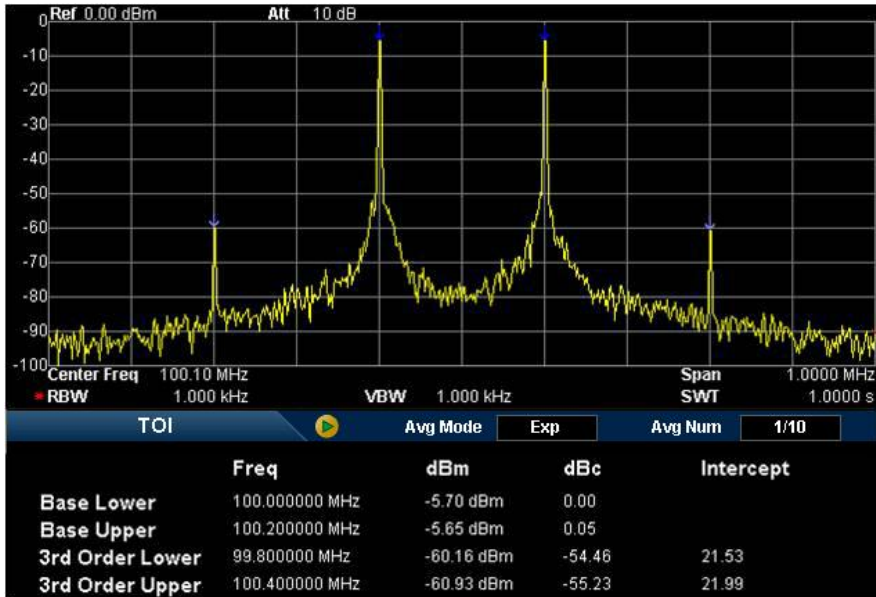

Figure 2-21 TOI Measurement Interface

Measurement Results: Base Lower, Base Upper, TOI (3rd Order Lower), TOI (3rd Order Upper), the frequency and amplitude of each kind of signal, the amplitude difference between each kind of signal and the base lower as well as the intercepts of the base lower and base upper.

Measurement Parameters: average number, average mode and span.

1. Avg Num

Specify the number of measurement averages used when calculating the measurement result and the default is "Off". You can use the numeric keys, knob or direction keys to modify this parameter.

Table 2-50 Average Number for TOI Measurement

Parameter	Description
Default	10
Range	1 to 1000
Unit	N/A
Knob Step	1
Direction Key Step	1

2. Avg Mode

Set the average operation mode to "Exp" or "Repeat" and the default is "Exp".

- When "Exp" is selected, the result is the exponential average of the current **N** (**N** is specified in "**Avg Num**") measurement results.
- When "Repeat" is selected, the result is the arithmetic average of the current **N** (**N** is specified in "**Avg Num**") measurement results.

3. Span

This span which is the same with the span of the analyzer is the frequency range for sweep. Modifying this parameter will also change the span of the analyzer. You can use the numeric keys, knob or direction keys to modify this parameter.

Table 2-51 Span for TOI Measurement

Parameter	Description
Default	2 MHz
Range	100 Hz to 1.5 GHz
Unit	GHz, MHz, kHz, Hz
Knob Step	TOI Distortion Span/100, the minimum is 1 Hz
Direction Key Step	in 1-1.5-2-3-5-7.5 sequence

Demod

Press **Demod** at the front panel to enter the demodulation setting menu. Both AM and FM demodulations are available in this device.

Demod

Set the demodulation type to AM or FM, or disable the demodulation function. The default is Off.

Key Points:

- The system will enable a marker automatically and place it at the center frequency for AM (or FM) demodulation after you enable AM (or FM) demodulation.
- DSA800 provides earphone jack and the demodulated signal can be output in audio frequency (AF) mode through the earphone. The frequency and intensity of AF separately denotes the frequency and amplitude of the signal.

Demod Setup

1. Earphone

Set the status of the earphone. When it is on, the demodulated signal can be heard through the earphone during the demodulation. By default, it is Off.

2. Volume

Set the volume of the earphone.

Table 2-52 Volume

Parameter	Explanation
Default	100
Range	0 to 255
Unit	N/A
Knob Step	10
Direction Key Step	20

3. Demod Time

Set the time interval for the analyzer to complete a signal demodulation after each sweep. If **Earphone** is set to "On", you will hear the demodulated signal through the earphone during the demodulation. You can use the numeric keys, knob or direction keys to modify this parameter. For more details, please refer to "**Parameter Setting**".

Table 2-53 Demod Time

Parameter	Explanation
Default	100 ms
Range	5 ms to 1000 s
Unit	ks, s, ms, us, ns, ps
Knob Step	0 to 10 ms, step=0.1ms 10 ms to 100 ms, step = 1 ms 100 ms to 1 s, step = 10 ms 1 s to 10 s, step = 100 ms 10 s to 100 s, step = 1 s 100 s to 1000 s, step = 10 s
Direction Key Step	in 1, 2, 5 sequence

Marker Measurements

Marker

The marker appears as a rhombic sign (as shown below) for identifying the point on the trace. You can easily read the the amplitude, frequency and sweep time of the marked point on the trace.

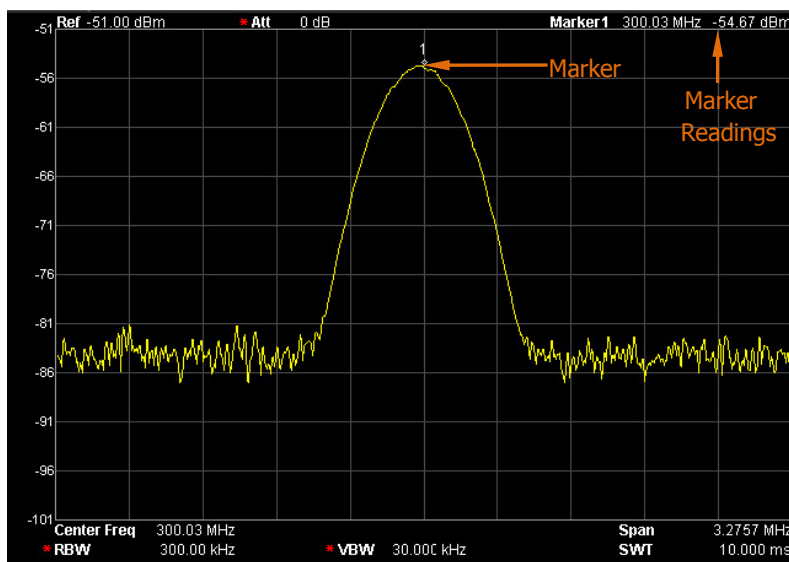

Figure 2-22 Schematic of the marker

Key Points:

- The analyzer allows for up to four pairs of markers to be displayed at one time, but only one pair or one single marker is active every time.
- You can use the numeric keys, knob or direction keys to enter the desired frequency or time as well as view the readouts of different points on the trace.

Select Mkr

Select one marker from the four and the default is Marker1. When a marker is selected, you can set its type, trace to be marked, readout type and other related parameters. The enabled marker will appear on the trace selected through the **Mkr Trace** option, and the readouts of this marker are also displayed in the active function area and at the upper right corner of the screen.

Table 2-54 Marker parameters

Parameter	Explanation
Default	Center Frequency
Range	0 to 1.5 GHz
Unit	Readout = Frequency (or Period), units available are GHz, MHz, kHz, Hz (or ks, s, ms, us, ns, ps); Readout = Time (or 1/ Δ time), units available are ks, s, ms, us, ns, ps (or GHz, MHz, kHz, Hz)
Knob Step	Readout = Frequency (or Period), step = Span/(Sweep Points -1); Readout = Time (or 1/ Δ time), step = Sweep Time/(Sweep Points -1)
Direction Key Step	Readout = Frequency (or Period), step = Span/10; Readout = Time (or 1/ Δ time), step = Sweep Time/10

Normal

One of the marker types. It is used to measure the X (Frequency or Time) and Y (Amplitude) values of a certain point on the trace. When selected, a marker with the number of the current marker (such as "1") appears on the trace.

Key Points:

- If no active marker exists currently, a marker will be enabled automatically at the center frequency of the current trace.
- You can use the numeric keys, knob or direction keys to move the marker. The readouts of the marker will be displayed at the upper right corner of the screen.

- The readout resolution of the X-axis (frequency or time) is related to the span. For higher readout resolution, reduce the span.

Delta

One of the marker types. It is used to measure the delta values of X (Frequency or Time) and Y (Amplitude) between the reference point and a certain point on the trace. When selected, a pair of markers appears on the trace: Reference Marker (marked by a combination of the marker number and letter "R", such as "1R") and the Delta Marker (marked by the marker number, such as "1").

Key Points:

- The reference marker will be activated at the position of the current marker if an active marker currently exists, or else both the reference marker and delta marker will be simultaneously activated at the center frequency.
- The location of the reference marker is always fixed (both on the X-axis and the Y-axis), while the Delta Marker is active. You can use the numeric keys, knob or direction keys to change the location of the Delta Marker.
- The delta of both the frequency (or time) and amplitude between the two markers are displayed at the upper right corner of the screen.
- There are two methods for defining a point as the reference point:
 - a) Open a "Normal" marker and locate it onto a point and then switch the marker type to "Delta". Then, you can modify the location of the delta point to achieve delta measurement.
 - b) Open a "Delta" marker and locate it onto a point, then reselect the **Delta** menu to locate the reference marker onto this point. Then, you can modify the location of the delta point to achieve delta measurement.
- When the **Noise Mkr** function under the **Marker Fctn** menu is activated, the result of the noise measurement will be corrected automatically and be normalized to 1 Hz.

The application of "Delta" marker

Measure the signal-noise ratio of single spectrum signal:

separately place the reference and delta Markers onto the signal and noise, the amplitude in the measurement result is the signal-noise ratio.

Delta Pair

One of the marker types. When selected, a pair of markers will appear on the trace: Reference Marker (marked by a combination of the marker number and letter "R", such as "1R") and the Delta Marker (marked by the marker number, such as "1").

Key Points:

- You can use the numeric keys, knob or direction keys to set the locations of the reference marker (selecting "Ref") and the delta marker (selecting "Delta") respectively.
- This is different from the **Delta** type marker in that you can modify both the reference and delta points. Additionally, both the X and Y values of the reference marker are stable for "Delta" marker during the sweep, but the Y value of the reference marker updates along with the sweep for "Delta Pair" marker.

Span Pair

One of the marker types. When selected, a pair of markers will appear on the trace: Reference Marker (marked by a combination of the marker number and letter "R", such as "1R") and the Delta Marker (marked by the marker number, such as "1").

Key Points:

- You can use the numeric keys, knob or direction keys to set the locations of both the reference marker and delta marker at the same time.
- If "Span" is selected, setting the "Span Pair" will keep the center position of the two markers and move them towards the two sides (value increases) or the middle (value decreases).
- If "Center" is selected, setting the "Span Pair" will keep the relative distance between the two markers and move their center position left (value decreases) or right (value increases).
- This is different from the "Delta" type marker in that you can modify both the reference marker and delta marker at the same time.

Off

Turn off the marker currently selected. The marker information displayed on the screen and functions based on the marker will also be turned off.

Mkr Trace

Select the trace to be marked by the current marker from 1, 2, 3, Math or Auto (default). When Auto is selected, the system searches the desired trace in the order of Clear Write, Max Hold, Min Hold, Video Avg, Power Avg, Freeze, and then selects one from them in the sequence of the trace number 1, 2 and 3 if more than two traces are found.

Readout

Select a desired readout type of the X-axis for the marker and different markers can use different readout types. This setting will change the readout type and affect the marker readings in the active function area and at the upper right corner of the screen, but will not change the actual value.

1. Frequency

In this type, **Normal** marker shows the absolute frequency, while **Delta** marker, **Delta Pair** marker and **Span Pair** marker show the frequency difference between the delta marker and reference marker.

The default readout mode in non-zero span mode is "Frequency".

2. Period

In this type, **Normal** marker shows the reciprocal of frequency, while **Delta** marker, **Delta Pair** marker and **Span Pair** marker show the reciprocal of frequency difference. When the frequency difference is zero, the reciprocal is infinite and 10 Ts is displayed.

This type is invalid in Zero span mode.

3. ΔTime

In this type, **Normal** marker shows the time difference between the marker

and the start of the sweep, while **Delta** marker, **Delta Pair** marker and **Span Pair** marker show the sweep time difference between the delta marker and reference marker.

The default readout mode in Zero span mode is Δ Time.

4. $1/\Delta$ Time

In this type, the reciprocal of sweep time difference between the delta marker and reference marker will be shown. When the time difference is zero, the reciprocal is infinite and 100 THz is displayed.

This type is available only in Zero span mode when a **Delta** type marker is selected and is suitable for the frequency measurement of a video signal.

Mkr Table

Enable or disable the Marker Table.

Display all the opened markers on the lower portion of the screen, including marker number, trace number, marker readout type, X-axis readout and amplitude. Through this table you can view the measurement values of multiple points. The table allows for up to eight markers to be displayed at one time.

Note: the marker table currently opened can be stored in internal or external memory and be recalled when needed. Press **Storage** to save the marker table according to the method introduced in "**Storage**".

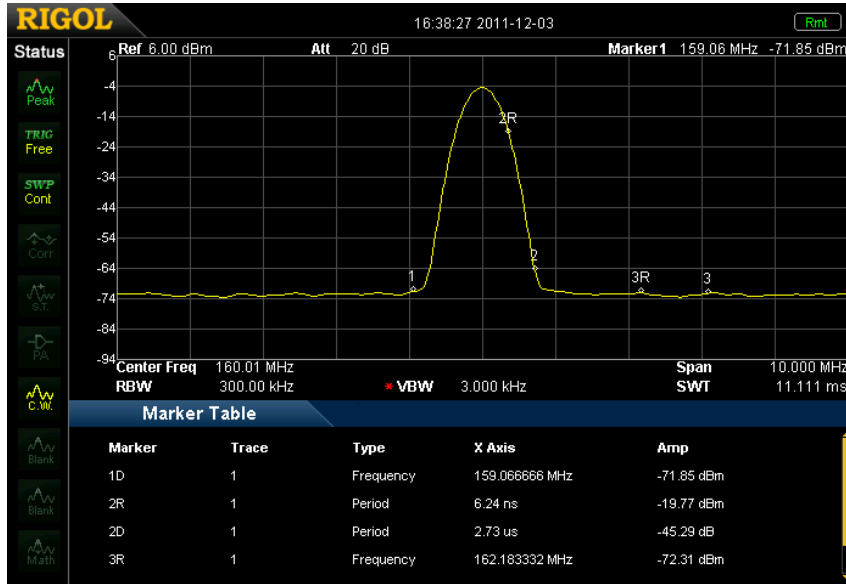

Figure 2-23 Marker Table

All Off

Turn off all the opened markers and the related functions.

Marker->

Set the other system parameters (such as center frequency and reference level) using the current marker readings. Press **Marker->** to enable a marker automatically if no marker is currently enabled.

Mkr->CF

Set the center frequency of the analyzer to the frequency of the current marker.

- If **Normal** marker is selected, the center frequency will be set to the frequency of the current marker.
- If **Delta, Delta Pair, or Span Pair** marker is selected, the center frequency will be set to the frequency of the Delta Marker.
- The function is invalid in Zero span mode.

Mkr->Step

Set the center frequency step of the analyzer to the frequency of the current marker.

- If **Normal** marker is selected, the center frequency step will be set to the frequency of current marker.
- If **Delta, Delta Pair or Span Pair** marker is selected, the center frequency step will be set to the frequency of the Delta Marker.
- The function is invalid in Zero span mode.

Mkr->Start

Set the start frequency of the analyzer to the frequency of the current marker.

- If **Normal** marker is selected, the start frequency will be set to the frequency of the current marker.
- If **Delta, Delta Pair or Span Pair** marker is selected, the start frequency will be set to the frequency of the Delta Marker.

- The function is invalid in Zero span mode.

Mkr->Stop

Set the stop frequency of the analyzer to the frequency of the current marker.

- If **Normal** marker is selected, the stop frequency will be set to the frequency of the current marker.
- If **Delta**, **Delta Pair** or **Span Pair** marker is selected, the stop frequency will be set to the frequency of the Delta Marker.
- The function is invalid in Zero span mode.

Mkr->Ref

Set the reference level of the analyzer to the amplitude of the current marker.

- If **Normal** marker is selected, the reference level will be set to the amplitude of the current marker.
- If **Delta**, **Delta Pair**, or **Span Pair** marker is selected, the reference level will be set to the amplitude of the Delta Marker.

Mkr Δ ->CF

Set the center frequency of the analyzer to the frequency difference between the two markers in **Delta**, **Delta Pair**, or **Span Pair** marker type.

The function is invalid in Zero span mode.

Mkr Δ ->Span

Set the span of the analyzer to the frequency difference between the two markers in **Delta**, **Delta Pair** or **Span Pair** marker type.

The function is invalid in Zero span mode.

Marker Fctn

Special marker functions including Noise Mkr, N dB BW and Freq Count.

Select Mkr

Select the marker to be used for the specified measurement function and the default is marker 1.

Noise Mkr

Execute the Noise marker function for the selected marker and read the noise power spectral density.

Key Points:

- If the current marker is Off in the **Marker** menu, pressing **Noise Mkr** will first set it to Normal type automatically, then measure the average noise level at the marked point and normalize this value to 1 Hz bandwidth. During this process, certain compensation is always made on the basis of detection and trace types. The measurement will be more precise if RMS Avg or Sample detection type is used.
- This function can be used for measuring the C/N ratio.

N dB BW

Enable the N dB BW measurement or set the value of N. The N dB BW denotes the frequency difference between points that are located on both sides of the current marker and with N dB fall ($N < 0$) or rise ($N > 0$) in amplitude as shown in the figure below.

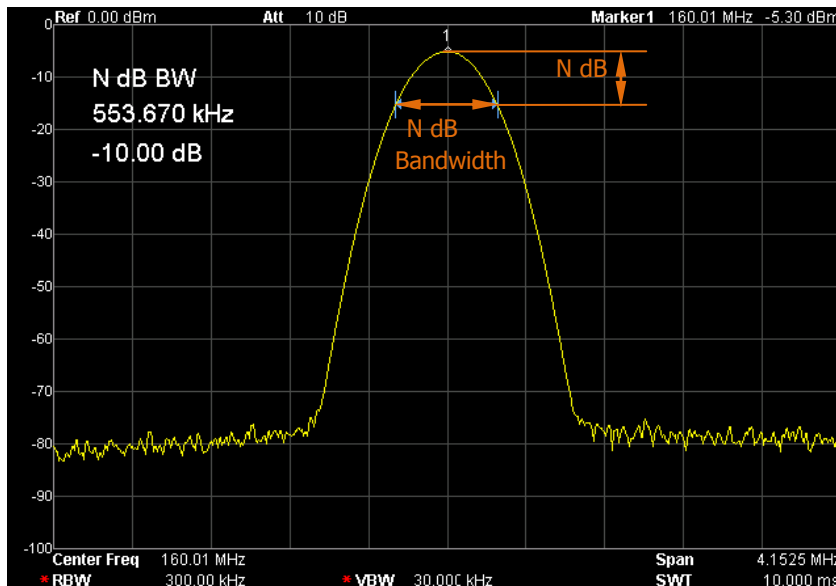

Figure 2-24 N dB BW measurement

Key Points:

- When the measurement starts, the analyzer will search for the two points which are located at both sides of the current point with N dB fall or rise in amplitude and display the frequency difference between the two points. "---" would be displayed if the search fails.
- You can use the numeric keys, knob or direction keys to modify the value of N, for more details please refer to "**Parameter Setting**".

Table 2-55 N dB BW parameter settings

Parameter	Explanation
Default	-3 dB
Range	-100 dB to 100 dB
Unit	dB
Knob Step	0.1 dB
Direction Key Step	1 dB

Function Off

Turn off the opened noise marker or N dB BW measurement, but not the marker itself.

Freq Count

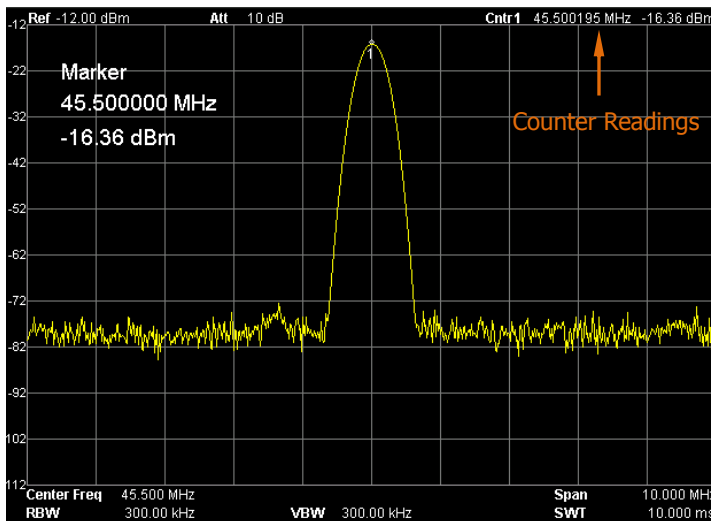

Figure 2-25 Frequency Counter Measurement

1. State

Turn on or off the frequency counter.

Key Points:

- If no active marker currently exists, turning on the frequency counter will open a **Normal** marker automatically.
- The frequency readout is more accurate when the frequency counter is enabled.
- The frequency counter measures the frequency near the center frequency in Zero span mode.

2. Resolution

Set the resolution of the frequency counter manually or automatically. The available resolutions are 1 Hz, 10 Hz, 100 Hz, 1 kHz, 10 kHz and 100 kHz.

Table 2-56 Resolution of frequency counter

Parameter	Explanation
Default	1 kHz
Range	1 Hz to 100 kHz
Unit	GHz, MHz, kHz, Hz
Knob Step	10 times
Direction Key Step	10 times

Peak

Open the peak search setting menu and execute peak search.

Key Points:

- If **Max** is selected in **Search Para** → **Peak Search**, the system will search and mark the maximum on the trace.
- If **Param** is selected in **Search Para** → **Peak Search**, the system will search and mark the peak that meets the peak search condition.
- The search of Next Peak, Peak Right, Peak Left or peaks in the peak table must meet the specified peak search condition.
- The spurious signal caused by LO feed through at zero frequency is ignored.
- When no peak that meets the specified peak search condition is found, "**No peak found**" is displayed.

Next Peak

Search and mark the peak whose amplitude is closest to that of the current peak and which meets the peak search condition.

Peak Right

Search and mark the nearest peak which is located at the right side of the current peak and meets the peak search condition.

Peak Left

Search and mark the nearest peak which is located at the left side of the current peak and meets the peak search condition.

Min Search

Search and mark the peak with the minimum amplitude on the trace.

Peak Peak

Execute peak search and minimum search at the same time and mark the results with a pair of markers. Wherein, the result of peak search is marked with the delta marker and the result of minimum search is marked with the reference marker.

Cont Peak

Enable or disable continuous peak search and the default is Off. When enabled, the system will always execute a peak search automatically after each sweep in order to track the signal under measurement.

The difference between Cont Peak and Signal Track

In Cont peak, the system always searches for the maximum in the current channel, while in Signal Track, the system always tracks the signal with the same amplitude as the marker before Signal Track was enabled and uses the frequency of this signal as the center frequency.

Search Para

Define the conditions of peak search for various peak searches. A real peak should meet the requirements of both the "PK Excursn" and "PK Thresh".

1. PK Excursn

Set the excursion between the peak and the minimum amplitude on both sides of it. Peaks whose excursions are beyond the specified excursion are treated as real peaks.

Table 2-57 PK Excursn

Parameter	Explanation
Default	10 dB
Range	0 dB to 200 dB
Unit	dB
Knob Step	1 dB
Direction Key Step	1 dB

2. PK Thresh

Assign a minimum for the peak amplitude. Peaks whose amplitudes are greater than the specified peak threshold are treated as real peaks.

Table 2-58 PK Thresh

Parameter	Explanation
Default	-90 dBm
Range	-200 dBm to 0 dBm
Unit	dBm, -dBm, mV, uV
Knob Step	1 dBm
Direction Key Step	1 dBm

3. Peak Search

Set the peak search condition. The available options are Maximum and Para.

- If **Max** is selected, the system searches for the maximum on the trace.
- If **Para** is selected, the system searches for the peak that meets the parameter condition on the trace.
- This setting applies only to the peak search executed by pressing **Peak** at the front panel, while other searches such as Next Peak, Peak Right, Peak Left and Min Search are all based on the **Para**.

Peak Table

Open the peak table (in the lower window) which lists peaks (with frequency and amplitude) that meet the peak search condition. Up to 10 peaks can be displayed in the table.

The peak table currently opened can be stored in internal or external memory and be recalled when needed. Press **Storage** to save the peak table according to the method introduced in “**Storage**”.

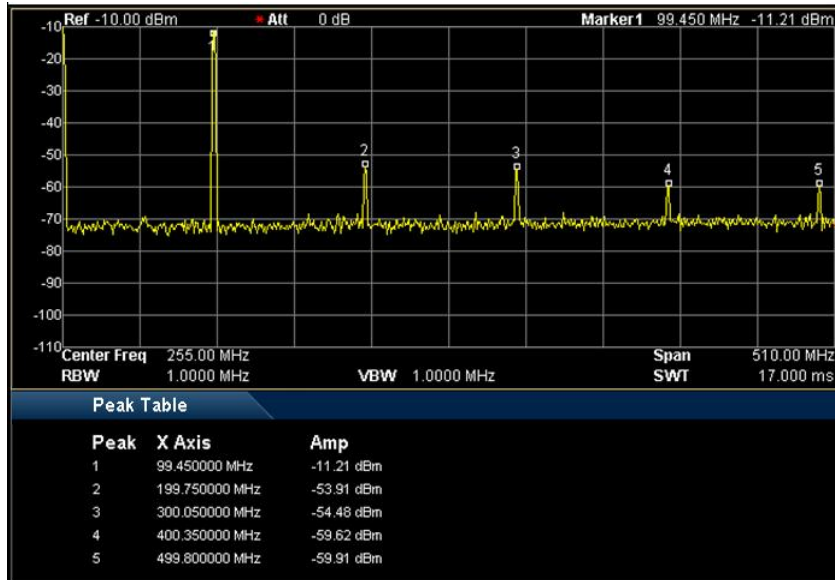

Figure 2-26 Peak Table

1. State

Turn on or off the peak table and the default is Off.

2. Peak Sort

Select a rule for peak sorting and the default is frequency ascending.

3. Pk Readout

Set the peak display condition to Normal, >DL or <DL.

- Normal
Display the first ten qualified peaks in the table.
- >DL
Display the first ten peaks that not only meet the peak search conditions but also have amplitudes greater than the specified display line (set in **System** → **Display**) in the table.
- <DL
Display the first ten peaks that not only meet the peak search conditions but also have amplitudes lower than the specified display line (set in **System** → **Display**) in the table.

Shortcut Key

Auto

Search for signals automatically throughout the full frequency range and adjust the frequency and amplitude for optimum display effect of the signal, thus realizing one-key signal search and auto setting of parameters.

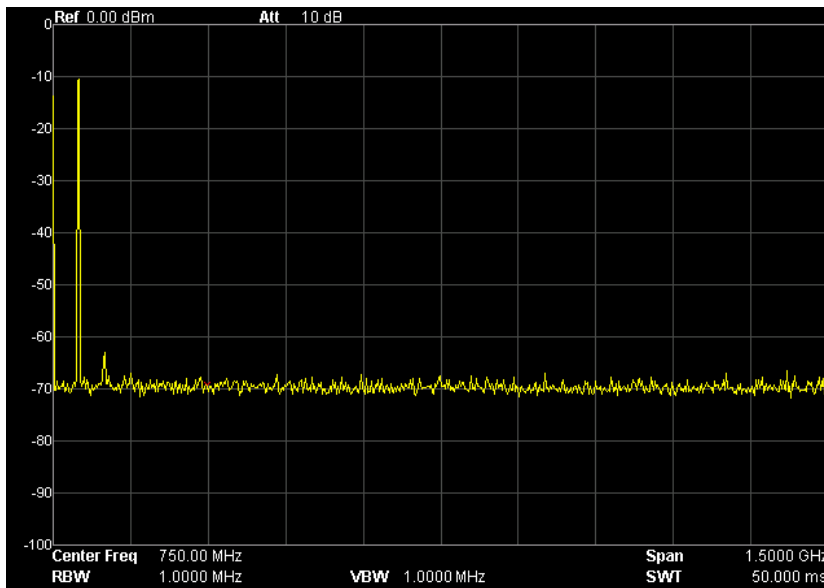

Figure 2-27 Before Auto Search

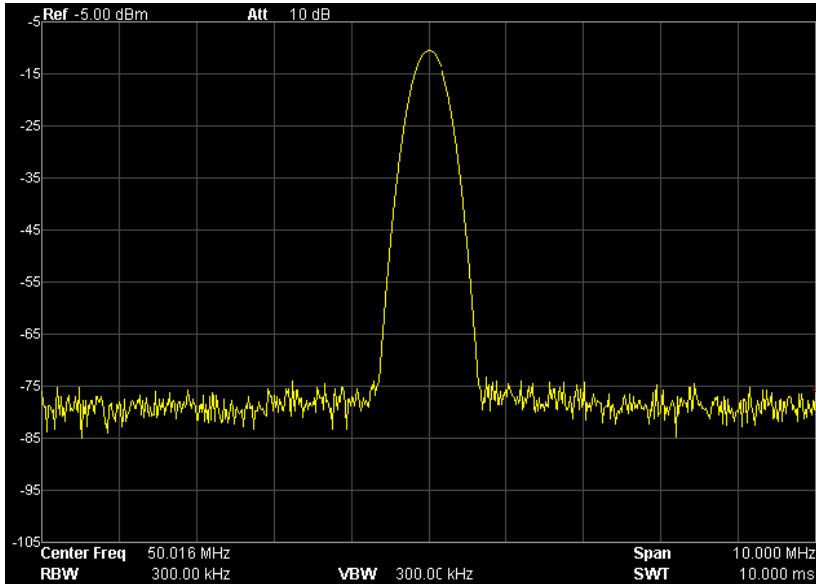

Figure 2-28 After Auto Search

Key Points:

- In the process of auto search, the backlight of **Auto** turns on and “Auto Tune” is shown in the status bar on the screen until the search is finished.
- During the auto search, press **Auto** to stop the search.
- Some parameters such as the reference level, scale, input attenuation and maximum mixing level may be changed during the auto search.

UserKey

User-defined shortcut key. For some hard-to-find but commonly used function menu, user can define it as shortcut key (for the defining method, refer to the introduction in "**UserKey Setting**"). After that, press the shortcut key under any operation interface to quickly open and set the desired menu or function.

Note: you can use **UserKey** to define all the keys at the front panel as well as the sub-menus of these keys (except **Storage**).

Preset

Recall the preset setting and restore the analyzer to a specified status.

Key Points:

- Press **System** → **Reset** → **Preset Type** to select "Factory" or one of "User1" to "User6".
- Press **Preset** to load the factory settings listed in the following table (except items marked with "**") or User-defined settings.

Table 2-59 Factory Settings

Parameter	Default
Frequency	
Center Freq	750 MHz
Start Freq	0 Hz
Stop Freq	1.5 GHz
CF Step	Auto, 150 MHz
Signal Track	Off
Span	
Span	1.5 GHz
Amplitude	
Ref Level	0 dBm
Ref Offset	0 dB
Scale/Div	10 dB
Input Atten	Auto, 10 dB
Scale Type	Log
Units	dBm
RF Preamp	Off
Input	50 Ω
MaxMixL	-10 dBm
BW/Det	
BW	
RBW	Auto, 1 MHz
VBW	Auto, 1 MHz
V/R Ratio	1

Detector	
Det Type	Pos Peak
Filter Type	Gauss
Sweep/Trig	
Sweep	
Time	Auto, 50 ms
Auto SWT	Normal
Mode	Cont
Numbers	1
Trig	
Trig Type	Free Run
Trig Level	0 dBm
Edge	Positive
Trace/P/F	
Trace	
Select Trace	1
Trace Type of Trace 1	Clear Write
Avg Times	100
Function	A-B
A	T1
B	T2
Const	0
Operate	Off
P/F	
Limit	Upper
Test	Off
X-axis	Freq
Freq Interp	Lin
Fail Stop	On
Beeper	Off
TG*	
TG	Off
Power Sweep	Off
Power Range	0 dB
Ref Trace	Off
TG Level	-20 dBm

TG Lvl Offset	0 dB
Normalize	Off
Norm Ref Lvl	0 dB
Norm Ref Pos	100%
Measure*	
VSWR	Off
Meas Mode	Cont
Meas Fctn	Off
Measure Setup*	
VSWR	
Marker	1
Marker State	On
Ref Lv	0.00 dB
T-Power	
Avg Num	Off, 10
Avg Mode	Exp
TP Type	Peak
Start Line	0 us
Stop Line	50 ms
ACP	
Avg Num	Off, 10
Avg Mode	Exp
Main CH BW	2 MHz
Adj CH BW	2 MHz
CH Spacing	2 MHz
Chan Pwr	
Avg Num	Off, 10
Avg Mode	Exp
Integ BW	2 MHz
CH Pwr Span	3 MHz
OBW	
Avg Num	Off, 10
Avg Mode	Exp
Max Hold	Off
OBW Span	2 MHz
Power Ratio	99%

EBW	
Avg Num	Off, 10
Avg Mode	Exp
Max Hold	Off
EBW Span	2 MHz
EBW X dB	-10 dB
C/N Ratio	
Avg Num	Off, 10
Avg Mode	Exp
Offset Freq	2 MHz
Noise BW	2 MHz
Carrier BW	2 MHz
Harmo Dist	
Avg Num	Off, 10
Avg Mode	Exp
NO.of Harmo	10
Harmonic ST	Auto, 50 ms
TOI	
Avg Num	Off, 10
Avg Mode	Exp
TOI Span	2 MHz
Demod	
Demod	Off
Earphone	Off
Volume	100
Demod Time	100 ms
Marker	
Select Mkr	1
Mkr Type	Normal
Delta Pair	Delta
Span Pair	Center
Mkr Trace	Auto
Readout	Frequency
Mkr Table	Off
Peak	
Cont Peak	Off

Peak Search	Max
Pk Excursn	10 dB
Pk Thresh	-90 dBm
Peak Table	Off
Peak Sort	Freq
Pk Readout	Normal
Mkr Fctn	
Mkr Fctn	Off
N dB BW	-3 dB
Freq Count State	Off
Resolution	Auto, 1 kHz
System**	
Preset Type	Factory
Power On	Preset
Language	English
Remote I/O	Off
DHCP	On
Auto-IP	On
Manual-IP	Off
USB Dev Class	TMC
Dev Addr	1
GPIO Address	18
Front Switch	On
Time/Date	On
Self-Cal	On
Display Line	Off, 0 dBm
Active Fctn	Top
Graticule	3
Scr State	On
Brightness	2
UserKey	On
Msg Switch	On
Storage**	
File Type	All
Format	BIN
File Source	T1

Browser	File
Input Style	English
Prefix Switch	Off
Print**	
Orientation	Landsc
Page Size	Default
Inverted	Off
Palette	Gray
Copies	1
Date Prints	Off
Qualities	Default
File Type	Default

*Note: the function is only applicable to DSA815 installed with the corresponding option.

Print

Press  to save or print the current screen.

Key Points:

- When a printer is currently connected, press this key and the analyzer prints the current screen image according to the print settings (please refer to the introduction in "**Print Setup**").
- If an USB storage device rather than printer is currently connected, press this key and the analyzer switches to the storage and recall interface. You can save the current screen data (with the specified filename) in ".bmp" format under the specified directory in the USB storage device.
- If the key is pressed when neither a printer nor a USB storage device is successfully connected, "Missing media" is displayed and the operation is ignored.

System Settings

System

Set the system parameters.

Language

DSA800 supports multi-language menu, Chinese and English bulid-in help and popup messages.

Press this key to select the desired display language.

Reset

Functions include: select the instrument settings to be recalled after the analyzer is powered on ("Last" or "Preset"); set the preset type ("Factory" or one of "User1" to "User6") and save system configuration.

1. Power On

Set the power on setting to "Last" or "Preset".

- When "Last" is selected, settings before the last power-off would be recalled automatically at power on.
- When "Preset" is selected, settings defined in **Preset Type** would be recalled automatically at power on.

2. Preset Type

Set the preset type to factory (default) or one of User1 to User6.

- When **Power On** is set to "Preset", the specified preset type will be recalled at power on.
- After the instrument starts, press **Preset** at the front panel under any operation interface will recall the specified preset type.

3. Save Preset

Save the current instrument setting as user-defined setting into the internal non-volatile memory. You can store and name up to 6 system states (correspond to "User1" to "User6" in the preset type).

When one of "User1" to "User6" is selected in **Preset Type**, press **Save Preset** and the instrument automatically opens the filename input interface (refer to "**To Input Filename**" to store the setting).

Note: this menu is grayed out and disabled when "Factory" is selected in **Preset Type**.

Calibrate

1. Cal Now

Press this key and the analyzer will use the internal calibration source to perform a self-calibration immediately. Self-calibration would last about 5 s and "Calibrating" is displayed in the user interface status bar during the calibration.

2. Self-Cal

When auto calibration is enabled, the analyzer executes self-calibration regularly. Within half an hour after power-on, the analyzer executes a self-calibration every 10 minutes and per hour after being powered on for more than half an hour.

I/O Settings

This analyzer supports communications through LAN, USB and GPIB interfaces. Both LAN and USB are standard interfaces, and GPIB should be configured by using a USB-GPIB interface converter (option) provided by **RIGOL**.

1. Remote I/O

Select LAN, USB or GPIB, or disable all the three interfaces.

2. LAN

Set or reset the LAN parameters.

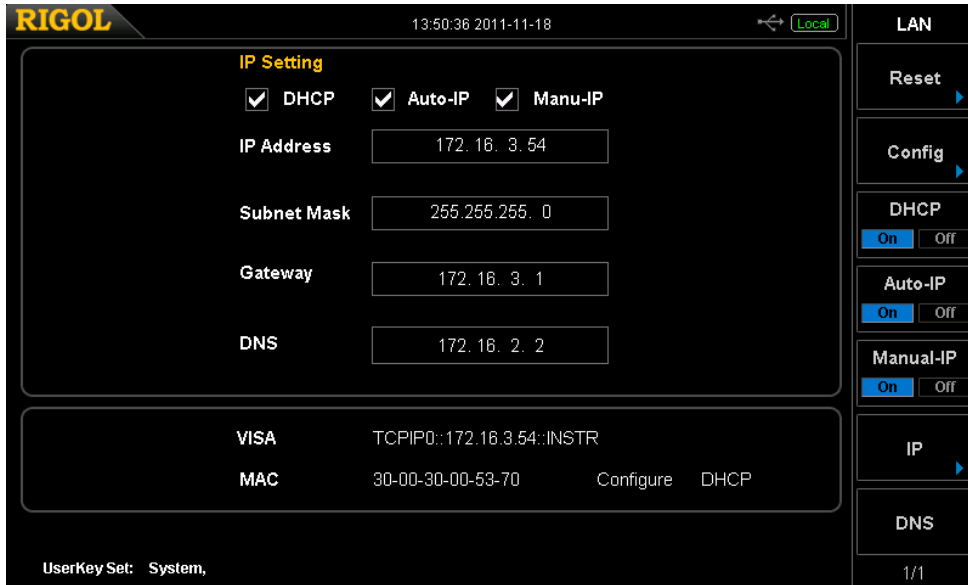

Figure 2-29 LAN parameter setting

The following items can be set through the front panel or remote interface.

- **Reset:**
Turn on DHCP and Auto-IP, turn Manual-IP off, and then clear the network password set.
- **Config:**
After the LAN interface configuration is finished, press **Config** → **OK** to apply the configuration.
- **DHCP:**
One of the setting methods of IP address. When DHCP is enabled, the DHCP server assigns network parameters (such as the IP address, subnet mask and gateway) to the analyzer on the basis of the current network configuration.
- **Auto-IP:**
One of the setting methods of IP address. When auto IP is enabled, the

analyzer obtains an IP address (from 169.254.0.1 to 169.254.255.254) and the subnet mask 255.255.0.0 automatically.

- **Manual-IP:**
One of the setting methods of IP address. When manual IP is enabled, users can define a desired IP address for the analyzer.

- **IP:**
Set the IP address, subnet mask and gateway manually.
 - a) The format of IP address is nnn.nnn.nnn.nnn. Wherein, the range of the first nnn is from 0 to 223 (except 127) and the ranges of the other three nnn are from 0 to 255. It is recommended that you ask your network administrator for an available IP address. Press **IP Address** and use the numeric keys to input the desired IP address.
 - b) The format of subnet mask is nnn.nnn.nnn.nnn, wherein, the range of nnn is from 0 to 255. It is recommended that you ask your network administrator for an available subnet mask. Press **Mask** and use the numeric keys to input the desired subnet mask.
 - c) The format of gateway is nnn.nnn.nnn.nnn. Wherein, the range of the first nnn is from 0 to 223 (except 127) and the ranges of the other three nnn are from 0 to 255. It is recommended that you ask your network administrator for an available gateway. Press **Gate** and use the numeric keys to input the desired gateway.

Note: the analyzer always tries to get an IP address in the order of DHCP, Auto-IP and Manual-IP. These three methods cannot be disabled at the same time.

- **Domain Server (DNS):**
Set the IP address of the DNS server. The format of domain server address is nnn.nnn.nnn.nnn. Wherein, the range of the first nnn is from 0 to 223 (except 127) and the ranges of the other three nnn are from 0 to 255. It is recommended that you ask your network administrator for an available address. Press **DNS** and use the numeric keys to input the desired address.

3. USB

DSA800 provides a USB Device interface at the rear panel.

Dev Class:

The analyzer may serve as a “slave” device to connect computer or PictBridge printing device through this interface. You can set the class and address of the USB slave device. The device classes include Auto Configure (default), TMC and Printer.

- Auto Configure: the device class depends on the USB host device.
- TMC: use the analyzer as a Test & Measurement Class device.
- Printer: use the analyzer as a Printer Class device.

Dev Addr:

View the device address. The device address shows the current USB address and can't be edited by users.

4. GPIB

Set the GPIB address.

You can modify this parameter using the numeric keys, knob or direction keys. For more details, please refer to “**Parameter Setting**”.

Table 2-60 GPIB address

Parameter	Explanation
Default	18
Range	0 to 30
Unit	N/A
Knob Step	1
Direction Key Step	1

Display

Control the screen display of the analyzer, such as setting the display line, active function area, graticule brightness, screen state, brightness, UserKey status and message switch.

1. Display Line

Turn on or off the display line or change its position. This line can be used as either the reference for you to read the measurement result or the threshold

condition for the peaks displayed in the peak table.

Key Points:

- This line is a horizontal reference of which the amplitude is equal to the set value and the corresponding amplitude unit is the same as the Y-axis unit.
- You can modify this parameter using the numeric keys, knob or direction keys. For more details, please refer to "**Parameter Setting**".

Table 2-61 Display line

Parameter	Explanation
Default	0 dBm
Range	Current amplitude range
Unit	dBm, -dBm, mV, uV
Knob Step	Step = Scale/10 (Log scale type) Step = 0.1 dB (Lin scale type)
Direction Key Step	Step = Scale (Log scale type) Step = 1 dB (Lin scale type)

2. Active Fctn

Set the position of the active function area for convenient observation of the trace. Selectable positions are Top (default), Center and Bottom. Pressing **Esc** key closes the display of the active function area.

3. Graticule

Set the brightness of the grid to highlight the display of the trace. You can modify this parameter using the numeric keys, knob or direction keys. For more details, please refer to "**Parameter Setting**".

Table 2-62 Graticule

Parameter	Explanation
Default	3
Range	0 to 10
Unit	N/A
Knob Step	1
Direction Key Step	1

4. Scr State

Turn on or off the screen and the default is "On". If you select "Off", "The display was locked, please press Esc to unlock." will be displayed. At this point, the screen stops updating and the measurement speed improves. In remote mode, the screen is always locked.

5. Brightness

Set the LCD brightness of the analyzer.

You can modify this parameter using the numeric keys, knob or direction keys.

For more details, please refer to "**Parameter Setting**".

Table 2-63 Brightness setting

Parameter	Explanation
Default	2
Range	0 to 7
Unit	N/A
Knob Step	1
Direction Key Step	1

6. Userkey

Turn on or off the display of the definition of **UserKey** in the main interface.

7. Msg Switch

Enable or disable the display of messages. The types of messages in this analyzer include Information Message, Error Message and Status Message. Only Information Messages will be displayed if the message display is turned off. For more details about messages, refer to "**Messages**".

Work Setting

1. Front Switch

Set the status of the front switch and the default is "On".

- On: when the analyzer is powered on, press the power switch at the front panel to start up the analyzer.
- Off: when the analyzer is powered on, it starts automatically.

2. Line Mode

Enter line mode. In line mode, in order to avoid fault operation, all the keys except the following are disabled.

- **Menu softkeys:** select the desired preset type.
- **Esc:** exit line mode.

3. UserKey Setting

Define a relative function for **UserKey** at the front panel (the defining method is as described below). After that, pressing **UserKey** under any operation interface can quickly enable the pre-defined function.

- Press **UserKey Set** and select "On";
- Open the desired function menu, such as: **System** → **Self Test** → **Key Test**;
- Press **UserKey** and the definition is finished, then **UserKey Set** turns off automatically.

Coupl Param

Set all the related parameters automatically according to the coupling relationship.

Definitions of the auto coupling parameters:

1. CF Step

This parameter maintains a coupling relationship with the RBW (or span) in zero span (or non-zero span) mode. Refer to "**CF Step**" for more details.

2. Reference level

The reference level, input attenuation, preamplifier and maximum mixing level maintain coupling relationships. Refer to the introduction of equation (2-3) in "**Ref Level**" for more details.

3. Input Attenuation

The input attenuation, reference level, preamplifier and maximum mixing level maintain coupling relationships. Refer to the introduction of equation (2-3) in "**Ref Level**" for more details.

4. **RBW**

This parameter maintains a coupling relationship with the span. Refer to "**RBW**" for more details.

5. **VBW**

This parameter maintains a coupling relationship with RBW. Refer to "**VBW**" for more details.

6. **Sweep Time**

The sweep time, RBW, VBW and span maintain coupling relationships. Refer to "**BW/Det**" for more details.

Information

View the system information or messages recently shown on the screen.

1. **System Information**

- Model
- Serial Number
- Version of Main Board
- Version of Radio Frequency Board FPGA
- Version of Digital Board FPGA
- Version of Firmware
- Version of Boot

2. **System Message**

View the system messages recently displayed (up to 71 items). For more information about system messages, refer to "**Messages**".

Self-Test

1. **Screen Test**

Test whether the screen has a dot defect using five colors: White, Red, Green, Blue and Black.

2. Key Test

Enter the keyboard test interface. Press the function keys at the front panel one by one and observe whether the corresponding key lights. If not, an error may have occurred in that key. Note if the key at the front panel is transparent, its backlight will also light when you press it. To exit the test, press **Esc** three times.

Time/Date

The system time is displayed in “hh:mm:ss YYYY-MM-DD” format in the DSA800 user interface. The output file can include the time information when printing or storing interface image according to your setting.

1. Time/Date

Enable or disable the Time/Date display.

2. Set Time

Set the display time of the analyzer. The time format should be hhmmss, for example, 231211 (denotes 23:12:11).

3. Set Date

Set the display date of the analyzer. The date format should be YYYYMMDD, for example, 20111001 (denotes October 1st, 2011).

License

DSA800 provides many kinds of options to fulfill various measurement requirements. To order the corresponding option, please contact **RIGOL**.

Press **License** to enter the option management interface to view the option status and the license key of the installed option as well as to install option.

1. Option Info

Display the status of options.

2. License Info

Show the license key installed.

3. Install

Input the license key of the option.

TX1000

DSA800 supports **RIGOL** TX1000* series spectrum analyzer RF Demo Kit. Press this key to open the TX1000 control panel. This function is available only when the analyzer is connected with the TX1000 option.

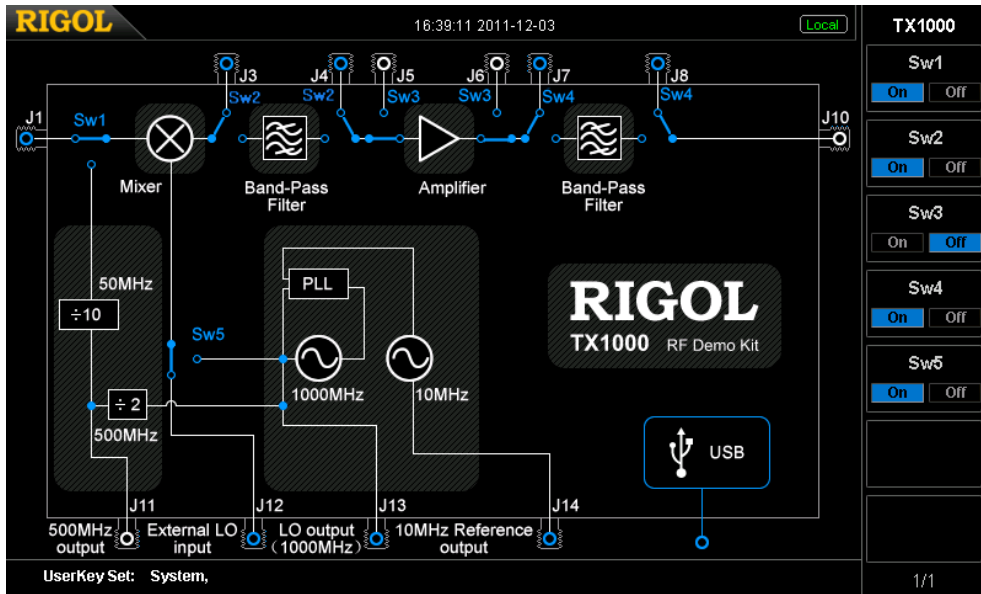



Figure 2-30 TX1000 control panel

*Note: this function is an option for DSA815.







Print Setup

Set the print parameters. The analyzer supports PictBridge printer. Connect the analyzer (USB Device interface) with the PictBridge printer using USB cable; press **System** → **I/O Setting** → **USB** → **Dev Class** → "Printer" and set the desired print parameters; then press  to print the current measurement results.

Printer Connection and Printing Procedures:

- (1) Turn on the PictBridge printer and wait until the power-on initialization is finished.
- (2) Use the USB cable provided in the accessories to connect the analyzer with the PictBridge printer.
- (3) "PictBridge printer connected." is shown on the analyzer screen to prompt you that the instrument now is initializing the driver and the print module.
- (4) If the printer is successfully installed, "PictBridge printer installed successfully." will be displayed on the analyzer screen. At this point, you can set the print parameters and start to print.
- (5) After the corresponding measurement is done, set the sweep mode to "Single" to stop the sweep and save the frozen measurement result, then execute the print operation.
- (6) The printer symbol, print state and process are shown in the status bar on the analyzer screen during the printing.
- (7) You can pause and resume the printing if necessary.
- (8) The printer enters idle state and waits for the next task after the printing is finished.

Table 2-64 Printing state icons

Icon	Explanation
 	The two icons are displayed alternately, indicating that the printer now is connecting.
	The printer is successfully connected, the printing is finished or the printer is idle.
 	The two icons are displayed alternately, indicating that the printing job is in progress.
	The printing has been paused.

1. print

Print the current screen according to print parameter settings when the printer has been successfully installed and is in idle state.

2. Resume

Resume the print job that has been paused.

3. Cancel

Stop the current print job.

4. Orientation

Set the print orientation to "Landscape" or "Portrait" and the default is "Landscape".

5. Page Size

Set the page size to "Default", "A4", "A5", "A6" or "B5". When "Default" is selected, the page size depends on the printer currently connected.

6. Inverted

Turn on or off the inverted print and the default is "Off".

7. Palette

Set the print color to "Gray" or "Color" and the default is "Gray".

8. Copies

Set the print copies and the default is 1. The range available is from 1 to 999.

9. Date Prints

Turn on or off the date print and the default is "Off". When it is turned on, the system date will be printed.

10. Qualities

Set the print quality to "Normal", "Draft", "Fine" or "Default". When "Default" is selected, the quality depends on the printer connected.

Hint

"Fine" printing may consume more ink than others.

11. File Type

Set the printing file type to "Default" or "Exif/JPEG". When "Default" is selected, the type depends on the printer currently connected.

Hint

The analyzer can automatically identify the characteristics of the printer, such as the page size, during the printer installation. If some configuration is not supported by the current printer, the corresponding menu in the analyzer is invalid. For example, if the current printer does not support color printing, the "Color" option in the **Palette** menu is invalid.

Storage

DSA800 allows users to store and recall various kinds of files in internal or external memory.

DSA800 provides a storage space (User Preset (C:)) for user-defined instrument states, a local memory (Local (D:)) and an external memory (Mobile Disk (E:)).

- **C disk:** provide 6 state file storage locations. Users can store 6 state files through **System** → **Reset** → **Save Preset**.
- **D disk:** provide storage locations for various kinds of files, such as setup, state and trace.
- **E disk:** available when USB storage device connected to the USB Host interface at the front panel is detected.

Press **Storage** at the front panel to enter the storage and recall interface.



Figure 2-31 File Manager

Note: DSA800 can only recognize files with filenames consisting of Chinese characters, English characters, numbers and underscore. If the filename or folder name contains other characters, the file or folder might not be displayed normally in the storage and recall interface.

File Type

Press **Storage** → **File Type** to select the desired file type. File types available include All, Setup, State, Trace, Corrections, Measure, Marker Table, Peak Table and Limit. The default is All. For the details about each type of file, see the table below.

Note: Measure, Marker Table and Peak Table in **File Type** are only available when the corresponding functions are enabled.

Table 2-65 File type*

File Type	Format	Extension
Setup	BIN	.set
State	BIN	.sta
Trace	BIN	.trc
	CSV	.csv
Amplitude correction	BIN	.cbl
	CSV	.csv
Measurement data	CSV	.csv
Marker table	BIN	.mkr
	CSV	.csv
Peak table	CSV	.csv
Limit	BIN	.lim

*Note: Mobile Disk (E:) supports all types of files; User Preset (C:) only supports the "State" files and Local (D:) supports all types of files except "Measure", "Marker Table" and "Peak Table".

Format

Press **Storage** → **Format** to set the storage format of the file to BIN (default) or CSV.

- BIN: binary file format.
- CSV: character file that can be read by editors such as Excel and supports all data processings under Excel such as drawing histogram.

Note: this menu is available only when external memory is connected.

File Source

Press **Storage** → **File Source** to set the file source of the storage to T1, T2, T3, Math Trace or All. Note that this menu is available only when the **File Type** is set to "Trace", the **Format** is set to "CSV" and external memory is connected.

- T1: only store the data of Trace 1.
- T2: only store the data of Trace 2.
- T3: only store the data of Trace 3.
- Trace Math: only store the data of the math operation trace.
- Trace All: store the data of all the traces currently displayed on the screen.

Browser

Press **Storage** → **Browser** to set browser type to "Dir" (directory) or "File". You can use the direction keys or the knob to select the desired disk, file or folder.

- Dir: when selected, use the knob or direction keys to switch among C, D and E (when USB storage device is connected) disks.
- File: when selected, use the knob or direction keys to switch among files or folders under the current directory.

Save

Save the file using the specified file type, file format and file source. Press this key to enter the filename editing interface and refer to "**To Input Filename**" to edit the new filename. Note that the length of a filename is limited to 48 characters. After finishing the filename editing, press **Save** to save the file. When storing a file in USB storage device, if the filename is already in use, select **Cover File** or **Reenter**.

Expand Dir

Expand E disk or the folder currently selected in E disk when USB storage device is installed.

Collapse Dir

Collapse E disk or the folder currently selected in E disk when USB storage device is installed.

Recall

Read the selected file and load it into the system.

Rename

Rename a stored file. Press this key to enter the filename editing interface and refer to the "**To Input Filename**" to edit the new filename. Then, press **Save** to save the file with the new filename.

Delete

Delete the selected file.

Copy

1. Copy From

Copy files or folders.

- When "Dir" is selected in **Browser**, pressing this key will copy all the files

or folders under the current path.

- When "File" is selected in **Browser**, pressing this key will copy the selected file or folder.

2. Copy To

Paste the directory or file.

- Replace file: press this key to replace the directory or file with the same name under the current path.
- Cancel: press this key to cancel the paste operation.

3. Apply To

Apply the state file selected in the external memory to the specified user-defined configuration (User1 to User6).

4. Browser

A shortcut key. Refer to "**Browser**".

5. Expand Dir

A shortcut key. Refer to "**Expand Dir**".

6. Collapse Dir

A shortcut key. Refer to "**Collapse Dir**".

Create Dir

Create a folder. Note that the length of the folder name is limited to 48 characters. Press this key to enter the filename editing interface and refer to "**To Input Filename**" to edit the folder name. Then, press **Save** to save the folder. This operation is only available when the USB storage device connected is recognized by the analyzer.

Disk Info

View the disk information, including disk name, type, file system, the used space

and the total space. This menu is available only when external storage device is selected.

Name Prefix

1. Prefix Switch

Enable or disable the edited prefix name. The input box will automatically load the prefix name after you press **Save** when **Prefix Switch** is set to "On".

2. Edit Prefix

Edit the desired prefix name using the numeric keyboard. Up to 15 characters can be entered.

System Update

Press this key to update the analyzer software after selecting the update file in the USB storage device.

Chapter 3 Remote Control



Users can control DSA800 series spectrum analyzer through USB, LAN or GPIB (option) remote interface. This chapter introduces remote control as well as the control method.

Subjects in this chapter:

- Remote Control Overview
- Remote Control Method

Remote Control Overview

DSA800 supports communication with PC via USB, LAN or GPIB (option) interface for remote control. The remote control is realized on the basis of SCPI (Standard Commands for Programmable Instruments) command set. DSA800 supports SCPI 1999.1 version.

When the instrument is in remote mode, the  icon is displayed in the user interface and the front panel keys (except ) are locked. At this point, you can press  to exist the remote mode.

Remote Control Method

The remote control of the analyzer on the basis of SCPI commands can be realized through two ways:

1. User-defined programming.
2. PC software.

User-defined Programming

Users can program and control DSA800 by using the SCPI commands on the basis of NI-VISA (National Instrument – Virtual Instrument Software Architecture) library.

1. Install NI-VISA Library

You need to install the VISA library of NI (download from <http://www.ni.com/visa/>) on your PC. NI-VISA is an application program interface developed by NI according to the VISA standards. You can use NI-VISA to realize the communication between the analyzer and PC through instrument buses (such as USB). VISA defines a set of software commands with which users can control the instrument without the need to understand how the interface bus works. For details, please refer to the NI-VISA Help.

2. Build Communication between Instrument and PC

You need to build the communication between the analyzer and PC.

- USB interface:
Use USB cable to connect the analyzer and PC. At this point, the hardware update wizard dialog box is displayed. Then, follow the instructions to install the "USB Test and Measurement Device".

The procedures are as follows:

- 1) Select "Install from a list or specific location (Advanced) and press "Next";
- 2) Select "Don't search. I will choose the driver to install." and press

- “Next”;
- 3) Select “USB Test and Measurement Device” and press “Next”;
- 4) Press “Finish” after the installation finishes.

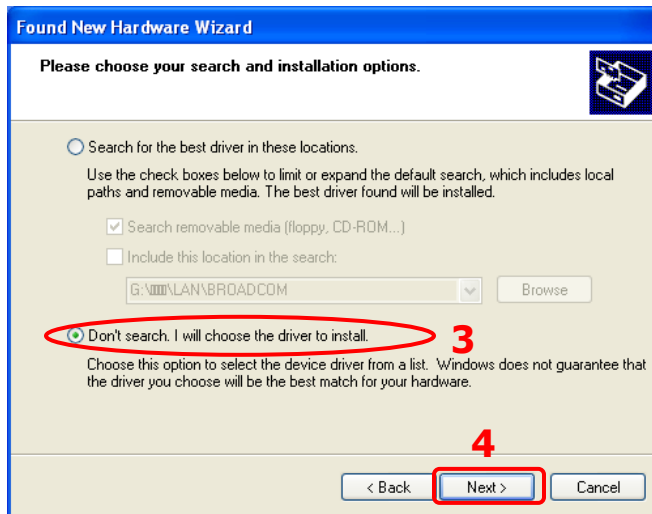
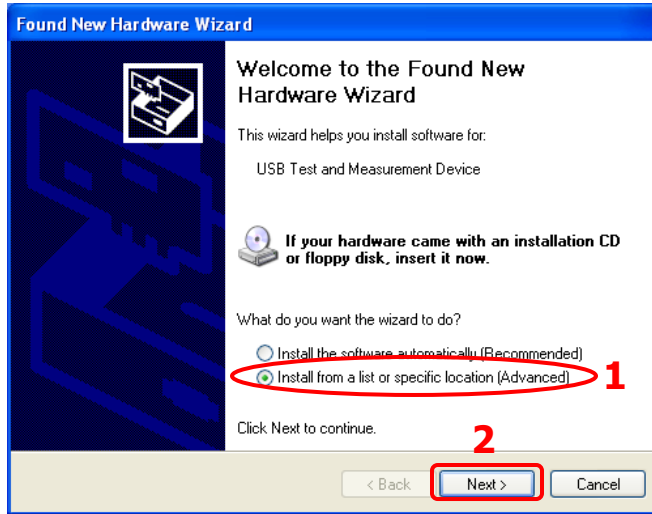

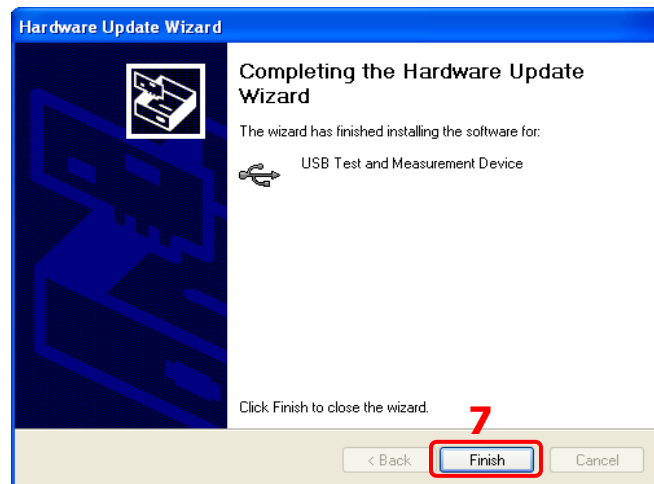
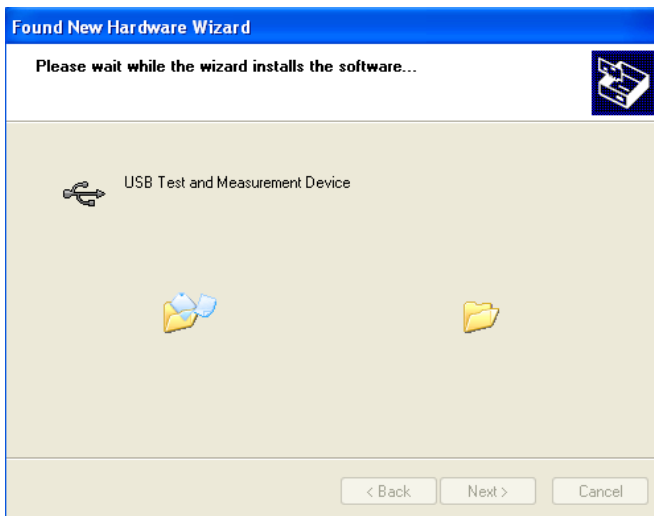
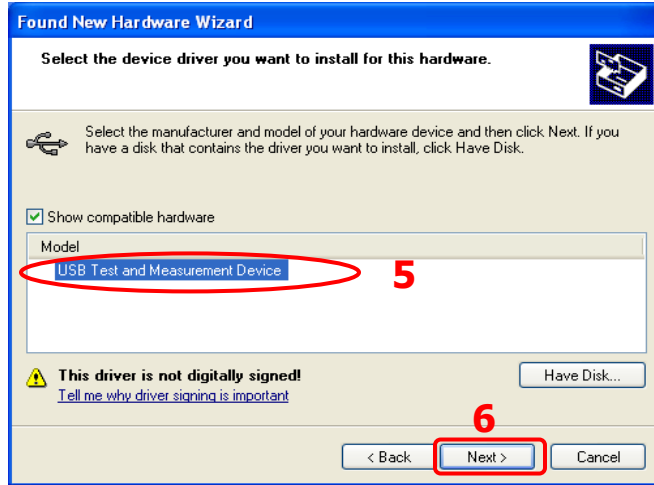

- LAN interface:
Connect your analyzer to the local area network of the PC and set the network parameters correctly following the instructions in “**I/O Settings**”.
- GPIB interface:
Use the USB-GPIB interface converter (option) to connect the analyzer to PC with GPIB card through the USB Host interface and set the GPIB address correctly following the instructions in “**I/O Settings**”.

3. Programming

Then, you can select a familiar software developing tool for programming. The developing tools available include Visual C++ 6.0, Visual Basic 6.0, LabVIEW 8.6 and etc. For detailed information about SCPI commands and programming method, refer to DSA800 Programming Guide.

To Use PC software

Users can also use the PC software to send commands and control the analyzer remotely. The PC softwares supported by DSA800 include:

1. General PC software **Ultra Sigma** of **RIGOL**
2. Measurement & Automation Explore of NI (National Instrument Corporation)
3. Agilent IO Libraries Suite of Agilent (Agilent Technologies, Inc.)

This section introduces in details how to use **Ultra Sigma** to send commands through each kind of interface to control the analyzer. Please refer to Ultra Sigma Help to install the software and the components required correctly. For the Ultra Sigma software, please contact **RIGOL**.

1. Remote Control via USB

1) Connect the devices

Connect the analyzer (USB Device) with PC (USB Host) using USB cable.

2) Install the USB drive

As the analyzer is a USBTMC device, after you connect the analyzer to the

PC and turn both on (the analyzer will be configured as USB interface automatically), the PC will display the hardware update wizard dialog box. Please install the “USB Test and Measurement Device” driver following the directions of the wizard. For the procedures, refer to “**User-defined Programming**”.

3) Search device resource

Start-up **Ultra Sigma**, and the software starts searching the analyzer resources currently connected to the PC, or click **USB-TMC** to search manually. The status bar of Ultra Sigma at present is as shown in the figure below.



Figure 3-1 Search USB Resources

4) View the resource

The resources that have been found successfully are shown under the “RIGOL Online Resource” catalog and the instrument model and USB interface information are also displayed as shown in the figure below.

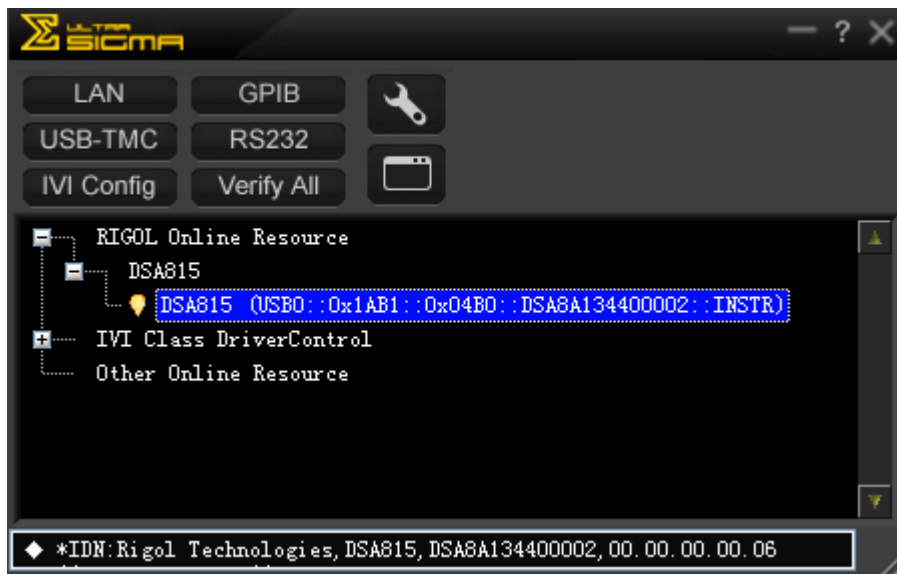

Figure 3-2 View the Resource

5) Communication test

Right click the resource name such as

DSA815 (USB0::0x1AB1::0x04B0::DSA8A134400002::INSTR)

and select **SCPI Panel Control** to open the remote control panel (as shown in the figure below) from which you can write commands and read data.



Figure 3-3 Write and Read Commands via USB

2. Remote Control via LAN

1) Connect the devices

Connect the analyzer to your LAN.

2) Configure LAN parameters

Select LAN interface according to the description in "LAN" of "I/O Settings".

3) Search device resource

Start-up **Ultra Sigma** and click **LAN**. Then, click **Search**

in the pop-up window and the software starts searching the analyzer resources connected to LAN. When a LAN resource is found, the name of it will be displayed in the resource box on the right side of the panel.

Select the desired resource and click **OK** to add the resource.

As shown in the figures below.

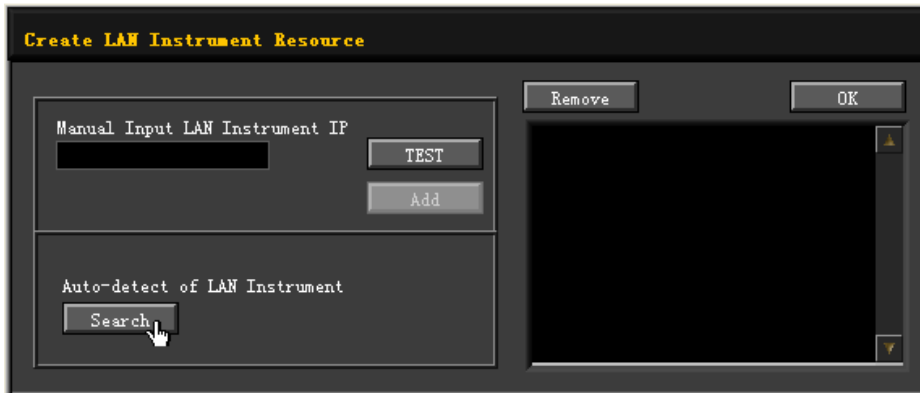

(a)



(b)

Figure 3-4 Search LAN Resources

4) View the resource

The resources that have been found successfully are shown under the “RIGOL Online Resource” catalog as shown in the figure on the next page.

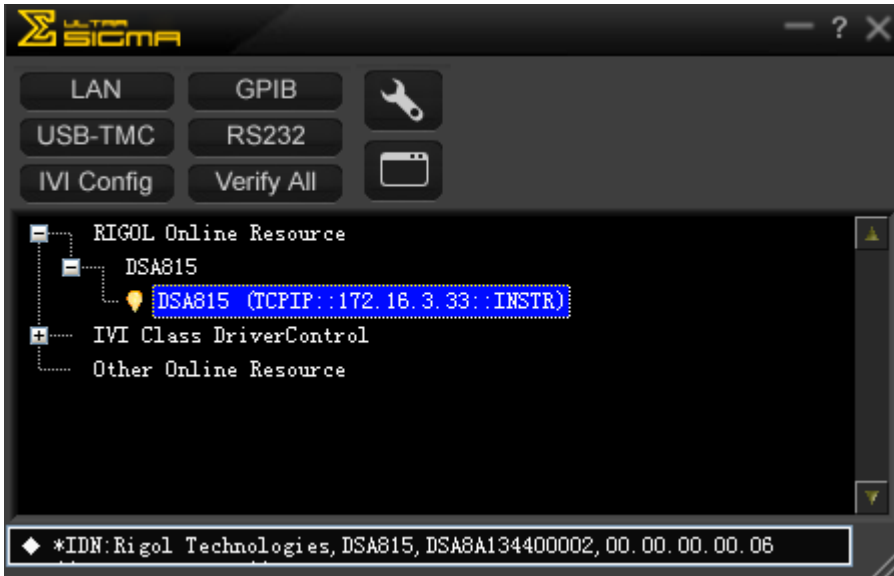

Figure 3-5 View the Resource

5) Communication test

Right click the resource name such as

DSA815(TCPIP::172.16.3.33::INSTR) and select **SCPI Panel Control** to open the remote control panel (as shown in the figure below) from which you can write commands and read data.

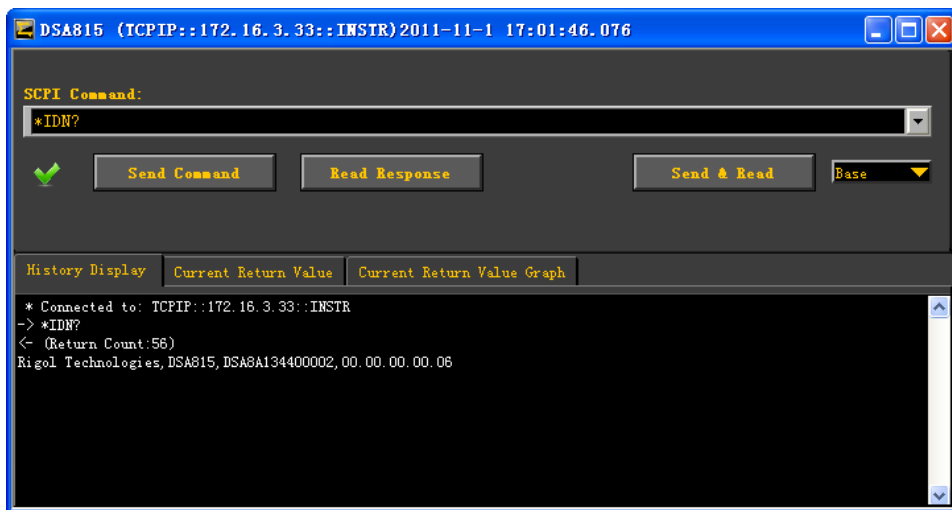

Figure 3-6 Write and Read Commands via LAN

6) Load LXI webpage

The analyzer conforms to LXI-C standards. You can load LXI webpage conveniently through **Ultra Sigma** (right-click the resource name and select "LXI-Web"). On the webpage, some important information about the analyzer such as the model, manufacturer, serial number, description, MAC address and IP address is shown as shown in the figure below.

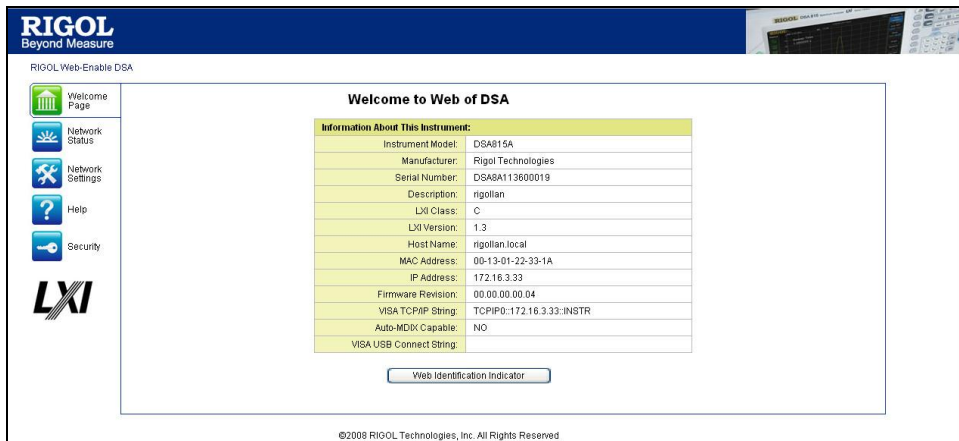

Figure 3-7 LXI Webpage

3. Remote Control via GPIB

1) Connect the devices

Connect the analyzer to the PC (configured with GPIB card) using **RIGOL** USB-GPIB interface converter (option).

2) Install the device driver of the GPIB card

Install the driver of the GPIB card connected to the PC.

3) Set the GPIB address

Set the GPIB address of the analyzer according to the description in "GPIB" of "**I/O Settings**".

4) Search device resource

Start-up **Ultra Sigma** and click **GPIB** to open the panel as shown in the figure below. Then, click "Search" and the software starts searching the GPIB device resources connected to PC automatically. When a GPIB resource is found, the device source descriptor of it will be

displayed on the right side of the panel.



Figure 3-8 GPIB Setting

If resources cannot be found automatically:

- Select the GPIB card address of the PC and the GPIB address of the analyzer from the "GPIB::" and "INSTR::" dropdown boxes separately.
- Click "Test" to see if the GPIB communication works normally; if not, please follow the prompt messages step by step.

5) View the resource

Click  and return back to the main interface of **Ultra Sigma**.

The resources that have been found successfully at present are shown under the "RIGOL Online Resource" catalog.



Figure 3-9 View the GPIB Resource

6) Communication test

Right-click the resource name such as **DSA815(GPIB1::18::INSTR)** and select **SCPI Panel Control** to open the remote control panel (as shown in the figure below) from which you can write commands and read data.

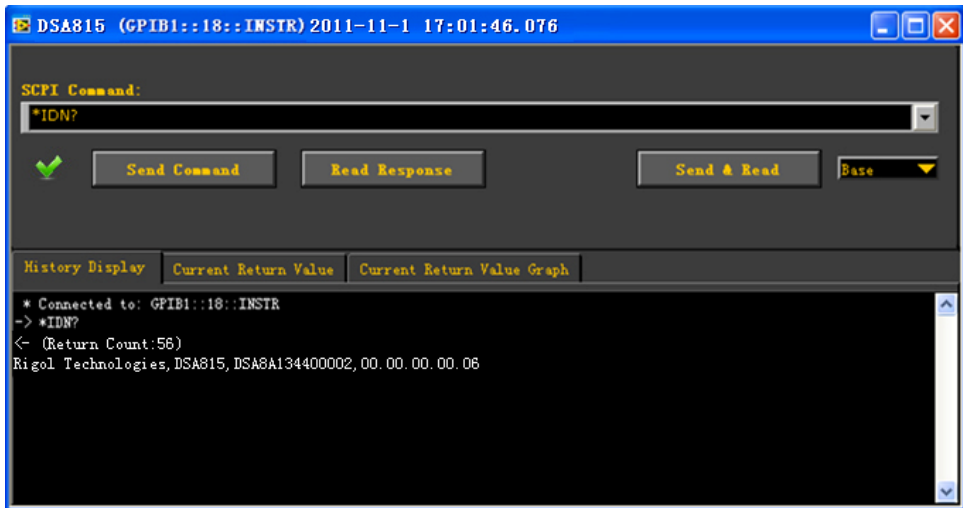

Figure 3-10 Write and Read Commands via GPIB

Chapter 4 Troubleshooting&Message

This chapter lists the commonly encountered failures of the analyzer and their solutions. In addition, the meaning of each message in the message list is also introduced.

Subjects in this chapter:

- Troubleshooting
- Messages

Troubleshooting

The commonly encountered failures and their solutions are listed below. When you encounter those problems, please solve them following the corresponding steps. If the problem remains still, please contact **RIGOL** and provide your device information (**System** → **Information** → **System Info**).

1. The screen is still dark (no display) after power on:

- (1) Check whether the fan is running:
 - If yes, the connection of the internal screen cable may be loose.
 - If not, the instrument has failed to start up and please refer to step (2).
- (2) Check the power:
 - Check whether the power supply has been connected correctly and the power switch has been turned on.
 - Check whether the power fuse is burned. If a new fuse needs to be installed, please select one with these specifications: 250V AC, T2A; 5 mm×20 mm.

2. The key is unresponsive or gives a wrong response

- (1) Press all the keys at the front panel to check if all of them are normal after power on.
- (2) Press **System** → **Self-Test** → **Key Test** to check if all the keys are working properly.
- (3) If a key is not working, the numeric keyboard connection might be loose or the numeric keyboard is broken. Do not disassemble the instrument by yourself and contact **RIGOL**.

3. The spectrum lines on the screen do not update for a long period of time:

- (1) Check whether the screen is locked; if so, press **Esc** to unlock.
- (2) Verify whether all the trigger conditions have been met and whether there is a valid trigger signal.
- (3) Check whether the analyzer is in single sweep.
- (4) Check whether the current sweep time is too long.

4. Wrong measurement results or poor precision:

To calculate the system errors and check the measurement results and precision, refer to the introductions in "**Specifications**". To reach these specifications, please:

- (1) Check whether all the external devices are successfully connected and are working normally.
- (2) Have some knowledge of the signal under measurement and set appropriate instrument parameters.
- (3) Make measurements under proper conditions, for example, warm-up the instrument appropriately and operate under the specified environment temperature.
- (4) Calibrate the instrument regularly to reduce or avoid errors that might occur over time.
 - If you need a specific calibration after the stated calibration period, contact **RIGOL** or get paid service from authorized measurement agencies.
 - The analyzer provides self-calibration function. If required, press **System** → **Calibrate** → **Self-Cal**, and the instrument will perform self-calibration automatically once the operating temperature changes.
 - Press **System** → **Calibrate** → **Cal Now** to make a self-calibration immediately.

5. Pop-up Message:

The instrument may display prompt messages, error messages or state messages according to the current working status. These messages are displayed to help you to use the instrument correctly and are not instrument failures. For information of the pop-up messages, please refer to "**Messages**".

Messages

Messages fall into three types on the basis of the purpose and severity: Information Message, Error Message and Status Message. To get accurate measurements and specific working status of the analyzer, you should be familiar with these messages.

1. Information Message

Give a clue that the current task has been finished or the analyzer has entered a specified state. The message is always marked with an  icon and displayed on the screen in message box for several seconds and then disappears automatically. You can also press any key to clear the message. Message number: 1 - 199.

2. Error Message

Warn you that the current operation cannot be executed and has been ignored or paused for some reason. The message is always marked with an  icon and displayed on the screen in message box for several seconds and then disappears automatically. You can also press any key to clear the error message.

On the basis of the cause of the error, Error Messages are divided into Command Error, Execution Error, Device Specific Error and Query Error. Each kind of error corresponds to a specific bit in the Standard Event Status Register (see IEEE 488.2,11.5.1). In remote mode, if you observe an error in the standard event status register, send the **:SYSTEM:ERROR?** command to get the specific error message and locate the cause of the error.

(1) Command Error:

Indicate a command error is detected by the parser while in remote control (see IEEE488.2,6.1.6). Possible reasons are:

- The parser detects a syntax error (see IEEE488.2,7.1.2.2) ;
- An unrecognized header causes semantic error (see IEEE488.2,10) .

Message number: -199 to -100.

(2) Execution Error:

Indicate an execution error is detected by the Execution Control Block.

Possible reasons are:

- A parameter following a header is evaluated by the device as outside of its legal input range.
- The command could not be properly responded to due to the current device condition.

Message number: -299 to -200.

(3) Device Specific Error:

The command cannot be correctly executed due to the current settings of the hardware and software of the device.

Message number: -399 to -300 (defined in SCPI standard) and 300 to 1000.

(4) Query Error:

Indicate a query error is generated when the output queue controller detects a Message Exchange Protocol error (see IEEE488.2,6.1.10).

Possible reasons are (see IEEE488.2,6.5.7) :

- When trying to read the output queue, the queue has no data or is being suspended.
- Data in the output queue has been lost.

Message number: -499 to -400.

3. Status Message:

Warn you that the analyzer is now in a certain or abnormal condition and should be paid attention to. The message is always marked with an  icon and displayed on the screen until the instrument exits the condition, the **Esc** key is pressed or the ***CLS** command is sent. The status message is stored in the corresponding status register, and can be queried by sending **:Status** or **:SYSTEM:ERROR[:NEXT]?**.

Message number: 200 to 299.

Information Message

Number	Error Description
1	PictBridge printer connected. PictBridge printer has already been connected successfully and is waiting for initialization.
2	PictBridge printer installed successfully. PictBridge printer has already been installed successfully and is ready for printing.
3	PictBridge printer disconnected.
4	Printing task finished.
5	Printing task paused. Printing task has been paused due to an error, please solve the problem and select RESUME . For the cause of the error please refer to the message list.
6	Printing task stopped. An irretrievable error occurred during printing, please select "Cancel" to stop the printing.
7	Printing task canceled.
8	Printing task resumed.
10	U Disk connected. USB storage device has already been connected and is waiting for initialization.
11	U Disk installed successfully.
12	U Disk removed.
13	Start updating firmware. The firmware is updating, please wait and keep the USB storage device connected. For any problem, please contact RIGOL technical support.
14	Updating firmware completed. Firmware update is finished and the new firmware program will be executed automatically when you restart the device.
15	Saving file completed.
16	To Recover file existed.
17	Load data with old revision. Load data from the old edition to the current system. The data

might not be correctly recognized and the instrument might not work normally.

- 18 The last spell char is allowed to input.**
- 19 Please select the valid file type.**
- 20 U Disk is not connected.**
- 30 LAN connected.**
- 31 LAN disconnected.**
- 32 Network settings will be reset, press yes to continue?**
- 41 Welcome to User Mode.**
- 50 Please Confirm, and press twice.**
- 51 The display was locked, please press Esc to unlock.**
- 52 Display unlocked.**
- 54 Please select the valid file.**
- 55 It is not allowed to delete folder.**
- 56 Fail to load file.**
- 57 Local Disk is being Formatted, please wait for a moment.**
- 58 Formatting is finished.**
- 60 Software version is not matched, file loading is failed.**
- 61 Invalid source.**
- 62 Select where to load, antenna, cable, user or others.**
- 63 Option is activated.**
- 64 Option is deleted.**
- 65 The edit frequency has been existed.**
- 80 Limit lines are cleaned because of change of X Axis type.**
- 81 Copy complete.**
- 82 Do you want to replace the exist file?**
- 83 Please select the copy.**
- 84 Fail to copy, as the destination is the same as the source.**
- 85 Updating the reference trace...**
- 86 Enter production line mode.**
- 87 Exit production line mode.**
- 88 Please press key ESC to exit remote control mode.**

Error Message

Command Error

Number	Error Description
-100	Command error. A generic syntax error indicates that the device cannot detect more specific errors. This code indicates that only Command Error defined in IEEE 488.2,11.5.1.1.4 has been found.
-101	Invalid character. The syntactic element contains an invalid character; for example, a header containing an ampersand (SETUP&). This error might be used in place of errors -114, -121, -141, and perhaps some others.
-102	Syntax error. An unrecognizable command or data type was encountered; for example, a string not supported by the device was received.
-103	Invalid separator. The parser was expecting a separator but recieved an illegal character; for example, the semicolon following a program message was omitted: *EMC 1:CH1:VOLTS 5.
-104	Data type error. The parser recognized a data element other than the one allowed; for example, numeric or string data was expected but block data was encountered.
-105	GET not allowed. A Group Execute Trigger was contained in a program message (see IEEE 488.2, 7.7).
-108	Parameter not allowed. More parameters were received than expected for the header; for example, the *EMC common command only accepts one parameter, so *EMC 0, 1 is not allowed.
-109	Missing parameter. Fewer parameters were contained than required in the header; for example, the *EMC common command requires one parameter, so *EMC is not allowed.
-110	Command header error.

An error was detected in the header. This error message is always used when the device cannot detect the more specific errors described in errors -111 to -119.

- 111 Header separator error.**
An illegal header separator was encountered while parsing the header; for example, no space is allowed following the header, thus *GMC"MACRO" is wrong.
- 112 Program mnemonic too long.**
The header contains more than twelve characters (see IEEE 488.2, 7.6.1.4.1).
- 113 Undefined header.**
The header is syntactically correct, but it is not defined by the device; for example, *XYZ is not defined by any device.
- 114 Header suffix out of range.**
A numeric suffix value was attached to a program mnemonic, making the header invalid.
- 115 Unexpected number of parameters.**
The number of parameters received does not correspond to the number of parameters expected. This is typically due to an inconsistency with the number of the instrument in the selected group (see INSTRUMENT:DEFine:GROup).
- 120 Numeric data error.**
This error, as well as errors -121 to -129, is generated when parsing a numeric data element and non-decimal number is contained in the numeric representation area. This error message is always used when the device cannot detect a more specific error.
- 121 Invalid character in number.**
An invalid character for the data type being parsed was encountered; for example, an alpha in a decimal numeric or "9" in octal data.
- 123 Exponent too large.**
The exponent was larger than 32000 (see IEEE 488.2,7.7.2.4.1).
- 124 Too many digits.**
The mantissa of a decimal numeric data element contained more than 255 digits excluding leading zeros (see IEEE 488.2, 7.7.2.4.1).
- 128 Numeric data not allowed.**
A legal numeric data element was received, but the device does not support one in this position for the header.

- 130 Suffix error.**
This error, as well as errors -131 to -139, is generated when parsing a suffix. This error message is always used when the device cannot detect a more specific error.
- 131 Invalid suffix.**
The suffix does not follow the syntax described in IEEE 488.2, 7.7.3.2, or the suffix is inappropriate for this device.
- 134 Suffix too long.**
The suffix contained more than 12 characters (see IEEE 488.2, 7.7.3.4).
- 138 Suffix not allowed.**
A suffix was encountered after a numeric element which does not allow suffixes.
- 140 Character data error.**
This error, as well as errors -141 to -149, is generated when parsing a character data element. This particular error message should be used if the device cannot detect a more specific error.
- 141 Invalid character data.**
The header is invalid when the character data element contains an invalid character or a particular character.
- 144 Character data too long.**
The character data element contains more than twelve characters (see IEEE 488.2, 7.7.1.4).
- 148 Character data not allowed.**
A legal character data element was used in a position prohibited by the device.
- 150 String data error.**
This error, as well as errors -151 to -159, is generated when parsing a string data element. This error message is always used when the device cannot detect a more specific error.
- 151 Invalid string data.**
A string data element was expected, but was invalid for some reason (see IEEE 488.2, 7.7.5.2); for example, an END message was received before the terminal quote character.
- 158 String data not allowed.**
A legal string data element was encountered but was not allowed by the device at this point in parsing.

- 160 Block data error.**
This error, as well as errors -161 to -169, is generated when parsing a block data element. This error message is always used when the device cannot detect a more specific error.
- 161 Invalid block data.**
A block data element was expected, but was invalid for some reason (see IEEE 488.2, 7.7.6.2); for example, an END message was received before the length was satisfied.
- 168 Block data not allowed.**
A legal block data element was encountered but was not allowed by the device at this point in parsing.
- 170 Expression error.**
This error, as well as errors -171 to -179, is generated when parsing an expression data element. This error message is always used when the device cannot detect a more specific error.
- 171 Invalid expression.**
The expression data element was invalid (see IEEE 488.2, 7.7.7.2); for example, unmatched parentheses or an illegal character.
- 178 Expression data not allowed.**
A legal expression data was encountered but was not allowed by the device at this point in parsing.
- 180 Macro error.**
This error, as well as errors -181 to -189, is generated when defining a macro or executing a macro. This error message is always used when the device cannot detect a more specific error.
- 181 Invalid outside macro definition.**
Indicate that a macro parameter placeholder ($\$<number>$) was encountered outside of a macro definition.
- 183 Invalid inside macro definition.**
Indicate that the program message unit sequence, sent with a *DDT or *DMC command, is syntactically invalid (see IEEE 488.2, 10.7.6.3).
- 184 Macro parameter error.**
Indicate that the command parameter type or value inside the macro definition is wrong.

Execution Error

Number	Error Description
-200	Execution error. A generic syntax error indicates that the device cannot detect more specific errors. This code indicates that only an Execution Error defined in IEEE 488.2, 11.5.1.1.5 has occurred.
-201	Invalid while in local. Indicate that a command is not executable while the device is in local mode (see IEEE 488.2, 5.6.1.5); select a proper communication interface to switch to remote mode.
-203	Command protected. Indicate that a legal password-protected program command or query could not be executed because the command was disabled.
-220	Parameter error. Indicate that a program data element related error occurred. This error message is always used when the device cannot detect the more specific errors described in errors -221 to -229.
-221	Settings conflict. Indicate that a legal program data element was parsed but could not be executed due to the current device state (see IEEE 488.2, 6.4.5.3 and 11.5.1.1.5.)
-222	Data out of range. Indicate that a legal program data element was parsed but could not be executed because the interpreted value was outside the legal range defined by the device (see IEEE 488.2, 11.5.1.1.5.)
-223	Too much data. Indicate that a legal program data element of block, expression or string type was received but could not be executed because it contained more data than the device could handle due to memory or related device requirements.
-224	Illegal parameter value. Used where the specified value in the parameter list was expected.
-225	Out of memory. The device has insufficient memory to perform the requested operation.
-233	Invalid version. Indicate that a legal program data element was parsed but could not be

executed because the version of the data is incorrect for the device. This particular error message is always used when file or block data formats can be recognized by the instrument but cannot be executed due to version incompatibility. For example, an unsupported file version, an unsupported instrument version.

-240 Hardware error.

Indicate that a legal program data or query could not be executed because of a hardware problem in the device. This error message is always used when the device cannot detect the more specific error described in error -241.

-241 Hardware missing.

Indicate that a legal program data or query could not be executed because the option was not installed.

-250 Mass storage error.

Indicate that a mass storage error occurred. This error message is always used when the device cannot detect the more specific errors described in errors - 251 to -258.

-251 Missing mass storage.

Indicate that a legal program command or query could not be executed because the mass storage was not installed.

-252 Missing media.

Indicate that a legal program command or query could not be executed because no disk can be found.

-253 Corrupt media.

Indicate that a legal program command or query could not be executed because of a bad disk or wrong disk formatting.

-254 Media full.

Indicate that a legal program command or query could not be executed because there is not enough space on the disk.

-256 File name not found.

Indicate that a legal program command or query could not be executed because the file to be read or copied does not exist.

-257 File name error.

Indicate that a legal program command or query could not be executed because the name of the file to be copied is already in use.

-258 Media protected.

Indicate that a legal program command or query could not be executed because the disk was in write-protect mode.

Device Specific Error

Number	Error Description
--------	-------------------

-300	Device-specific error.
-------------	-------------------------------

A generic device-dependent error indicates that the device cannot detect more specific errors. This code indicates that only a Device-Dependent Error defined in IEEE 488.2, 11.5.1.1.6 has occurred. Please report the error to your **RIGOL** sales or technical support team.

-310	System error.
-------------	----------------------

Indicate that some error, termed "system error" by the device, has occurred. Please report the error to your **RIGOL** sales or technical support team.

-311	Memory error.
-------------	----------------------

Indicate that local C disc is not formatted or an error occurred during self-test. If restarting the device is still of no effect, please report the error to your **RIGOL** sales or technical support team.

-313	Calibration memory lost.
-------------	---------------------------------

Indicate that the data before delivery or last valid calibration data has been lost. Please report the error to your **RIGOL** sales or technical support team.

-314	Save/recall memory lost.
-------------	---------------------------------

Indicate that the nonvolatile data saved by the *SAV? command has been lost.

-315	Configuration memory lost.
-------------	-----------------------------------

Indicate that nonvolatile configuration data saved by the device has been lost.

-321	Out of memory.
-------------	-----------------------

An internal operation needed more memory than that was available. Please report the error to your **RIGOL** sales or technical support team.

-330	Self-test failed.
-------------	--------------------------

The self-test failed. For more information, please refer to the result of the Self-test.

-340	Calibration failed.
-------------	----------------------------

The calibration failed. Please report the error to your **RIGOL** sales or technical support team.

- 350 Queue overflow.**
Error occurs when the code enters into the queue. This message indicates that there is no room in the queue and an error occurred but was not recorded.
- 360 Communication error.**
- 365 Time out error.**
Communicating with USB-GPIB interface converter times out. Please restart the converter.
- 300 Print paper error.**
Fail to print. Please check whether the print paper is available and in the correct position.
- 301 Print ink error.**
Fail to print. Please check the quantity of ink or confirm whether the ink box is installed correctly.
- 302 Print hardware error.**
Fail to print. Indicate that a printer hardware error has occurred. Please check it.
- 303 Print file type error.**
Fail to print owing to wrong print file type.
- 304 Unknown print error.**
- 310 Updating error with wrong image file.**
An error occurred when updating firmware because the format of the image file is incorrect or the file has already been damaged.
- 311 Updating error with wrong revision.**
An error occurred when updating firmware because of a revision incompatibility.
- 312 Updating error with failing to write flash.**
An error occurred when updating firmware owing to a failure to write to the flash.
- 320 Invalid file path.**
The file path received may not exist or an illegal path format was used.
- 321 Invalid input string.**
An illegal string has been received.
- 322 File name too long.**
The file name is too long. The length should not exceed 48 characters.

- 323 U-Disk failed to install.**
The USB storage device can not be correctly installed and please examine it for possible damage. For any question, please contact your distributor or **RIGOL** technical support.
- 324 File name existed.**
The file name received already exists and please re-input.
- 325 Input empty.**
The input is empty and please input a legal string before saving.
- 326 Fail to save file.**
- 327 Other language except English not supported.**
Any other languages are disabled except English.
- 328 File operation failed.**
- 329 No space to save file.**
The document or file can not be created or saved owing to limited space.
- 331 Invalid option serial number.**
The length of option serial number must be less than 20 characters.
- 332 Invalid File Type to load.**
- 333 Invalid installation, please insert U disk again.**
- 340 DHCP renew failed.**
Fail to configure IP address with DHCP server. Please try manual IP.
- 341 IP conflict.**
The IP address received is already in use. Please try another IP address.
- 342 Invalid IP.**
The IP address received is invalid.
- 350 Can't auto-couple sweep time in zero span.**
Sweep time can not be coupled automatically in zero span. Please set it manually.
- 351 Zero span unavailable at power measurement mode.**
- 354 Pre-amplifier disable.**
Please adjust the settings of reference level, attenuator as well as maximum mixing level.
- 355 Scale/div invalid in linear scale mode.**
- 356 Invalid function in zero span.**
In zero span, the following operations cannot be executed: Signal Track On, Span Zoom In, Span Zoom Out, Peak->CF, Mkr->CF, Mkr->Step, Mkr->Start, Mkr->Stop, Mkr Delta->CF, Mkr Delta->Span, setting the Mark readout as FREQ or PERIOD, TG power sweep.

- 357 Invalid function in non-zero span.**
Neither Video trigger nor the $1/\Delta$ Time in marker readout is effective in non-zero span.
- 358 Invalid mark readout.**
When the marker is in Delta Pair mode, the $1/\Delta$ Time in marker readout is of no effect; and when the marker is in normal mode, Mkr Δ ->CF and Mkr Δ ->Span are of no effect.
- 359 Invalid function when trace is not enabled.**
A marker could not be assigned to a trace when the correct trace function is not enabled.
- 360 User preset failed.**
The user preset has failed because the edition of the saved status data is incorrect or the status data has been damaged. In this situation, the system will execute Factory settings by default.
- 400 Input signal power out of range.**
Indicate that the input signal power is out of range. If this state continues for a long time, some damage may occur to the device. Please reduce the input power.
- 401 1st LO unlock.**
The first LO is unlocked. Please report the error to your **RIGOL** sales or technical support.
- 402 2nd LO unlock.**
The second LO is unlocked. Please report the error to your **RIGOL** sales or technical support.
- 403 Track LO unlock.**
Track LO is unlocked. Please report the error to your **RIGOL** sales or technical support.
- 412 Overrange occurs in DA by a volume adjustment in FM.**
- 413 Intermediate frequency signal out of range.**
- 420 Option not installed.**
The desired operation cannot be performed because the option required is not installed. For example, press TG when no tracking generator is installed.
- 460 No peak found.**
No signal peak that meets the criteria was found under Peak Search.
- 461 No fundamental wave found.**
Indicate that no fundamental wave greater than 50dBm is found.

- 462** **No two-tune signal found.**
- 463** **Invalid function as cursor is not enabled.**
The cursor can not be set to the reference level unless it is enabled.
- 464** **Invalid set userkey as menu under storage.**
- 465** **Invalid function.**

Query Error

Number	Error Description
---------------	--------------------------

-400	Query error.
-------------	---------------------

A generic query error indicates that the device cannot detect more specific errors. This code indicates that only a Query Error defined in IEEE 488.2, 11.5.1.1.7 and 6.3 has occurred.

-410	Query INTERRUPTED.
-------------	---------------------------

Indicate that an INTERRUPTED Query error occurred due to some reason (see IEEE 488.2, 6.3.2.3); for example, a query was added to DAB or GET before a response was completely sent.

-420	Query UNTERMINATED.
-------------	----------------------------

Indicate that an UNTERMINATED Query error occurred due to some reason (see IEEE 488.2, 6.3.2.2); for example, the device was addressed to communicate but an incomplete program message was received.

-430	Query DEADLOCKED.
-------------	--------------------------

Indicate that a DEADLOCKED Query error occurred due to some reason (see IEEE 488.2, 6.3.1.7); for example, both input buffer and output buffer are full and the device cannot continue.

-440	Query UNTERMINATED after indefinite response.
-------------	--

Indicate that a query was received before the error response generated from the previous query was solved (see IEEE 488.2, 6.5.7.5).

Status Message

Number	Error Description
---------------	--------------------------

202	Auto range...
------------	----------------------

203	Auto tune...
------------	---------------------

204	Calibrating...
------------	-----------------------

205	Waiting for triggered...
------------	---------------------------------

The system is not in freerun mode currently and will keep waiting until it receives the trigger signal.

252	Auto range finished.
------------	-----------------------------

253	Auto tune finished.
------------	----------------------------

254	Self-calibration finished.
------------	-----------------------------------

255	Triggered.
------------	-------------------

Chapter 5 Specifications

This chapter lists the specifications and general specifications of the analyzer. All the specifications apply to the following conditions unless otherwise noted.

- The instrument has been warmed-up for 30 minutes.
- The instrument is within the calibration period and a self-calibration has been performed.

Typical value and nominal value are defined as follows.

- Typical value: defined as the specifications of the product under specified conditions.
- Nominal value: defined as the approximate quantity in the application of the product.

Technical Specifications

Frequency

Frequency		
Frequency Range	DSA815	9 kHz to 1.5 GHz
Frequency Resolution		1 Hz

Internal Frequency Reference		
Reference Frequency		10 MHz
Aging Rate		<2 ppm/year
Temperature Drift	20 °C to 30 °C	<2 ppm

Frequency Readout Accuracy		
Marker Resolution		span / (sweep points-1)
Marker Uncertainty		\pm (frequency indication \times frequency reference uncertainty +1% \times span + 10% \times resolution bandwidth + marker resolution)

Marker Frequency Counter		
Resolution		1 Hz, 10 Hz, 100 Hz, 1 kHz, 10 kHz, 100 kHz
Uncertainty		\pm (frequency indication \times frequency reference uncertainty + counter resolution)

Note: Frequency Reference Uncertainty= (aging rate \times period since the last calibration + temperature drift).

Frequency Span		
Range	DSA815	0 Hz, 100 Hz to 1.5 GHz
Uncertainty		\pm span / (sweep points-1)

SSB Phase Noise		
Carrier Offset	10 kHz	<-80 dBc/Hz

Bandwidth		
Resolution Bandwidth (-3 dB)		100 Hz to 1 MHz, in 1-3-10 sequence
Resolution Bandwidth (-6dB)	Option	200 Hz, 9 kHz, 120 kHz
RBW Uncertainty		< 5%, nominal
Resolution Filter Shape Factor (60 dB: 3 dB)		<5, nominal
Video Bandwidth (-3 dB)		1 Hz to 3 MHz, in 1-3-10 sequence

Amplitude

Measurement Range		
Range		DANL to +20 dBm

Maximum rated input level		
DC Voltage		50 V
CW RF Power	RF attenuation =30 dB	+20 dBm (100 mW)
Max. Damage Level		+30 dBm (1W)

Note: When input level >+25 dBm (preamplifier off) or +5 dBm (preamplifier on), the protection switch will be on.

Displayed Average Noise Level (DANL)		
0 dB RF Attenuation, RBW=VBW=100 Hz, Sample Detector, Trace Average \geq 50		
DANL (Preamp Off)	100 kHz to 1 MHz	<-90 dBm, typical -110 dBm
	1 MHz to 1.5 GHz	<-110 dBm+6 x (f/1GHz) dB, typical -115 dBm

DANL (Preamplifier On)	100 kHz to 1 MHz	<- 110 dBm, typical -130 dBm
	1 MHz to 1.5 GHz	<-130 dBm+6 x (f/1 MHz) dB, typical -135 dBm

Level Display Range		
Log Scale		1 dB to 200 dB
Linear Scale		0 to Reference Level
Number of Points		601
Number of Traces		3+ Math Trace
Trace Detector		Normal, Positive-peak, Negative-peak, Sample, RMS, Voltage Average, Quasi-Peak
Trace Function		Clear Write, Max Hold, Min Hold, Average, Freeze, Blank
Scale Unit		dBm, dBmV, dB μ V, nV, μ V, mV, V, nW, μ W, mW, W

Frequency Response		
10 dB RF Attenuation, Relative to 50 MHz, 20 °C to 30 °C		
Frequency Response (Preamplifier Off)	100 kHz to 1.5 GHz	<0.7 dB
Frequency Response (Preamplifier On)	1 MHz to 1.5 GHz	<1.0 dB

Input Attenuation Switching Uncertainty		
Setting Range		0 to 30 dB, in 1 dB step
Switching Uncertainty	fc=50 MHz, relative to 10 dB, 20 °C to 30 °C	< 0.5 dB

Absolute Amplitude Uncertainty		
Uncertainty	fc=50 MHz, peak detector, preamplifier off, 10 dB RF attenuation, input	\pm 0.4 dB

	signal=-10 dBm, 20 °C to 30 °C	
--	--------------------------------	--

RBW Switching Uncertainty

Uncertainty	100 Hz to 1 MHz, relative to 1 kHz RBW	<0.1 dB
-------------	--	---------

Reference Level

Range		-100 dBm to +20 dBm , in 1 dB step
Resolution	Log Scale	0.01 dB
	Linear Scale	4 digits

Full Amplitude Measurement Uncertainty

Full Amplitude Measurement Uncertainty	95% confidence level, S/N>20 dB, RBW=VBW=1 kHz, preamplifier off, 10 dB RF attenuation, -50 dBm<Reference level<0, 10 MHz<fc<1.5 GHz, 20 °C to 30 °C	<1.5 dB, nominal
--	--	------------------

RF Input VSWR

10 dB RF Attenuation		
VSWR	1 MHz to 1.5 GHz	<1.5

Intermodulation

Second Harmonic Intercept (SHI)		+40 dBm
Third-order Intercept (TOI)	fc >30 MHz	+10 dBm

1dB Gain Compression		
Total Input Power of Mixer	$f_c \geq 50$ MHz, preamplifier off	>0 dBm

Note: Mixer power level (dBm) = input power (dBm) – input attenuation (dB).

Spurious Responses		
Image Frequency		<-60 dBc
Intermediate Frequency		<-60 dBc
Spurious Response, Inherent		<-88 dBm, typical
Spurious Response, Others	Referenced to local oscillators, referenced to A/D conversion, referenced to subharmonic of first LO, referenced to harmonic of first LO	<-60 dBc
Input Related Spurious	Mixer level: -30 dBm	<-60 dBc, typical

Sweep

Sweep		
Sweep Time Range	100 Hz ≤Span≤ 1.5 GHz	10 ms to 1500 s
	Zero Span	20 μs to 1500 s
Sweep Time Uncertainty	100 Hz ≤Span≤ 1.5 GHz	5%, nominal
	Zero Span	0.5%, nominal
Sweep Mode		Continuous, Single

Trigger

Trigger		
Trigger Source		Free run, Video, External
External Trigger Level		5 V TTL level

Tracking Generator (DSA815 Option)

TG Output		
Frequency Range		9 kHz to 1.5 GHz
Output Level		-20 dBm to 0 dBm, in 1 dB step
Output Flatness	1 MHz to 1.5 GHz, referenced to 50 MHz	± 3 dB

Input/Output

RF Input		
Impedance		50 Ω
Connector		N-type, female

TG Out		
Impedance		50 Ω
Connector		N-type, female

10 MHz REF In/10 MHz REF Out/External Trigger In		
Connector		BNC female
10 MHz REF In Amplitude		0 dBm to +10 dBm
10 MHz REF Out Amplitude		+3 dBm to +10 dBm
Trigger Voltage		5 V TTL level

USB		
	USB Host	
Connector		B plug
Protocol		Version 2.0
	USB Device	
Connector		A plug
Protocol		Version 2.0

General Specifications

Display		
Type		TFT LCD
Resolution		800 x 480
Size		8"
Color		64 k

Printer Supported		
Protocol		PictBridge

Remote Control		
USB		USB TMC
LAN		10/100 Base-T, RJ-45, LXI-C Class
IEC/IEEE BUS (GPIB)	with USB-GPIB interface converter option	IEEE 488.2

Mass Memory		
Mass Memory		Internal Memory USB Storage Device (not supplied)

Power Supply		
Input Voltage Range, AC		100 V to 240 V, nominal
AC Supply Frequency		45 Hz to 440 Hz
Power Consumption		Typical 35 W, Max 50 W with all options.

Temperature		
Operating Temperature Range		5 °C to 40 °C
Storage Temperature Range		-20 °C to 70 °C

Dimensions		
	(W x H x D)	361.6 mm x 178.8 mm x 128mm(14.2 inches x 7.0 inches x 5.0 inches)

Weight		
	With Tracking Generator	4.25 kg (9.4 lbs)

Chapter 6 Appendix

Appendix A: Ordering Information

	Description	Order No.
Model	Spectrum Analyzer, 9 kHz to 1.5 GHz (with preamplifier)	DSA815
Standard Accessories	Quick Guide (Hard Copy)	QGD03X00
	CDROM (User's Guide, Programming Guide)	-
	Power Cord	-
Options	EMI Filter & Quasi-Peak Detector Kit (for DSA815 only)	DSA800-EMI
	VSWR Measurement Kit (for DSA815 only)	DSA800-VSWR
	VSWR Bridge	VB1020
	Advanced Measurement Kit (for DSA815 only)	DSA800-AMK
	1.5 GHz Tracking Generator (for DSA815 only)	DSA800-TG
	RF Demo Kit (Transmitter)	TX1000
	USB to GPIB Interface Converter	USB-GPIB
	Rack Mount Kit	DSA800-RMSA
Optional Accessories	DSA Accessories Package includes: N-SMA Cable, BNC-BNC Cable, N-BNC Adapter, N-SMA Adapter, 75 Ω -50 Ω Adapter, 2 Antennas (900 MHz/1.8 GHz), 2 Antennas (2.4 GHz)	DSA Utility Kit
Optional Manual (Hard Copy)	Quick Guide, Chinese&English	QGD03X00
	User's Guide, Chinese	UGD03000
	User's Guide, English	UGD03100
	Programming Guide, Chinese	PGD03000
	Programming Guide, English	PGD03100

Note: for more option and accessory information, please contact RIGOL salesman or local distributor.

Appendix B: Warranty

RIGOL warrants that its products mainframe and accessories will be free from defects in materials and workmanship within the warranty period.

If a product is proven to be defective within the respective period, **RIGOL** guarantees the free replacement or repair of products which are approved defective. To get repair service, please contact with your nearest **RIGOL** sales and service office.

RIGOL does not provide any other warranty items except the one being provided by this summary and the warranty statement. The warranty items include but not being subjected to the hint guarantee items related to tradable characteristic and any particular purpose. **RIGOL** will not take any responsibility in cases regarding to indirect, particular and ensuing damage.

Appendix C: Any Comment or Question?

If you have any question or comment on our document, please mail to:
service@rigol.com



Index

1/ΔTime.....	2-82	Demod Time.....	2-76
3rd Order Lower	2-73	Display Line	2-108
3rd Order Upper	2-73	Earphone.....	2-75
ACP.....	2-46	EBW	2-46
Active Fctn	2-109	EBW X dB.....	2-66
Adj CH BW	2-56	Edit Prefix	2-123
attenuator.....	1-8	EMI filter	2-27
Average	2-53	External Trigger.....	2-32
Average Times	2-35	Factory Settings	2-97
Avg Mode.....	2-53	File Source.....	2-120
Avg Num.....	2-52	Free Run Trigger	2-32
Base Lower	2-73	Freeze.....	2-35
Base Upper	2-73	Freq Interp	2-21
Brightness.....	2-110	Frequency Range	VII
C/N Ratio	2-46	Front Switch	2-110
Cal Now.....	2-105	Function.....	2-36
Cal Open.....	2-50	GPIOB	2-108
Carrier BW	2-69	Graticule.....	2-109
Carrier Power	2-67	Harmonic ST.....	2-71
CH Pwr	2-55	Install	2-114
CH Pwr Span.....	2-59	Integ BW.....	2-59
CH Spacing	2-57	intercepts	2-73
Chan Pwr	2-46	Key Test	2-113
Channel Power	2-58	LAN	2-106
Cleaning	V	License Info.....	2-114
Clear Write.....	2-34	Line Mode.....	2-111
Collapse Dir.....	2-122	Main CH BW	2-56
Constant.....	2-36	Marker	2-50
Continuous sweep.....	2-29	Marker State	2-50
Corr Table	2-21	Max	2-90
Corr View.....	2-21	Max Hold.....	2-35, 2-62, 2-65
Correction.....	2-20	Min Hold.....	2-35
DANL.....	VII	Msg Switch	2-110
Delta Marker	2-79	Neg Peak.....	2-25

NO.of Harmo.....	2-71	Reference Marker.....	2-79
Noise BW.....	2-68	Reset.....	2-50
Noise Power.....	2-67	RMS.....	2-53
Norm Ref Pos.....	2-44	RMS Avg.....	2-26
Normal.....	2-26	Sample.....	2-26
Normalize.....	2-43	Save Preset.....	2-105
OBW.....	2-46	Scr State.....	2-110
OBW Span.....	2-62	Screen Test.....	2-112
Offset Freq.....	2-68	Self-Cal.....	2-105
Option Info.....	2-113	Single Sweep.....	2-29
Param.....	2-90	Span.....	2-74
Peak.....	2-53	span.....	1-8
Peak Search.....	2-92	Start Line.....	2-53
peak search.....	2-90	Stop Line.....	2-54
Peak Sort.....	2-93	Stor Ref.....	2-43
Phase Noise.....	VII	System Information.....	2-112
PK Excursn.....	2-91	System Message.....	2-112
Pk Readout.....	2-93	Time/Date.....	2-113
PK Thresh.....	2-92	TOI.....	2-47
Pos Peak.....	2-25	TP Type.....	2-53
Power Avg.....	2-35	T-Power.....	2-46
Power On.....	2-104	Tracking Generator.....	VII
Power Ratio.....	2-63	Trigger Edge.....	2-33
Power Spectral Density.....	2-58	Trigger Level.....	2-32
Prefix Switch.....	2-123	USB.....	2-107
Preset Type.....	2-104	UserKey Setting.....	2-111
Printing state icons.....	2-115	Video Avg.....	2-35
Quasi-Peak.....	2-27	Video Trigger.....	2-32
RBW.....	1-8	Voltage Avg.....	2-26
Ref Trace.....	2-44	Volume.....	2-75
reference level.....	1-8	VSWR.....	2-50
Reference level under normalization.....	2-44	VSWR Ref Level.....	2-51